



TEST REPORT

FCC Part 27

Report Reference No. : **CTL1702156501-WF05**

Compiled by: (position+printed name+signature)	Allen Wang (File administrators)	<u>Allen Wang</u>
Tested by: (position+printed name+signature)	Nice Nong (Test Engineer)	<u>Nice Nong</u>
Approved by: (position+printed name+signature)	Ivan Xie (Manager)	<u>Ivan Xie</u>

Product Name : 8 inch 4G Tablet

Model/Type reference : TT800Q

List Model(s)..... : N/A

Trade Mark..... : N/A

FCC ID..... : 2AGCDJACS800Q

Applicant's name : **JACS SOLUTIONS LLC**

Address of applicant..... : 8808 Centre Park Drive Suite 305 Columbia, MD 21045, USA

Test Firm..... : **Shenzhen CTL Testing Technology Co., Ltd.**

Address of Test Firm : Floor 1-A, Baisha Technology Park, No.3011, Shahexi Road, Nanshan District, Shenzhen, China 518055

Test specification :

Standard : **FCC CFR Title 47 Part 2, Part 27**
EIA/TIA 603-D: 2010
KDB 971168 D01

TRF Originator : Shenzhen CTL Testing Technology Co., Ltd.

Master TRF : Dated 2011-01

Date of Receipt..... : Jun. 15, 2017

Date of Test Date..... : Jun. 16, 2017–Jul. 11, 2017

Data of Issue..... : Jul. 12, 2017

Result..... : Pass

Shenzhen CTL Testing Technology Co., Ltd. All rights reserved.

This publication may be reproduced in whole or in part for non-commercial purposes as long as the Shenzhen CTL Testing Technology Co., Ltd. is acknowledged as copyright owner and source of the material. Shenzhen CTL Testing Technology Co., Ltd. takes no responsibility for and will not assume liability for damages resulting from the reader's interpretation of the reproduced material due to its placement and context.

TEST REPORT

Test Report No. :	CTL1702156501-WF05	Jul. 12, 2017
		Date of issue

Equipment under Test : 8 inch 4G Tablet

Model /Type : TT800Q

Listed Models : N/A

Applicant : **JACS SOLUTIONS LLC**

Address : 8808 Centre Park Drive Suite 305 Columbia, MD
21045, USA

Manufacturer : **SHENZHEN JIZHAO INFORMATION
TECHNOLOGY CO., LTD.**

Address : BUILDING NO.1 ZHONGKENUO INDUSTRIAL
PARK HEZHOU ROAD XIXIANG STREET BAOAN
DISTRICT SHENZHEN ,CHINA

Test result	Pass *
--------------------	---------------

*In the configuration tested, the EUT complied with the standards specified page 5.

The test report merely corresponds to the test sample.

It is not permitted to copy extracts of these test result without the written permission of the test laboratory.

Table of Contents

Page

1. SUMMARY.....	5
1.1. TEST STANDARDS	5
1.2. TEST DESCRIPTION.....	5
1.3. TEST FACILITY	6
1.4. STATEMENT OF THE MEASUREMENT UNCERTAINTY.....	6
2. GENERAL INFORMATION	7
2.1. ENVIRONMENTAL CONDITIONS	7
2.2. GENERAL DESCRIPTION OF EUT	7
2.3. DESCRIPTION OF TEST MODES	7
2.4. EQUIPMENTS USED DURING THE TEST	7
2.5. RELATED SUBMITTAL(S) / GRANT (S)	8
2.6. MODIFICATIONS.....	8
3. TEST CONDITIONS AND RESULTS	9
3.1. OUTPUT POWER	9
3.2. PEAK-TO-AVERAGE RATIO (PAR).....	14
3.3. OCCUPIED BANDWIDTH AND EMISSION BANDWIDTH.....	19
3.4. BAND EDGE COMPLIANCE	24
3.5. SPURIOUS EMISSION	29
3.6. FREQUENCY STABILITY UNDER TEMPERATURE & VOLTAGE VARIATIONS	46
4. TEST SETUP PHOTOS OF THE EUT	48
5. PHOTOS OF THE EUT	49

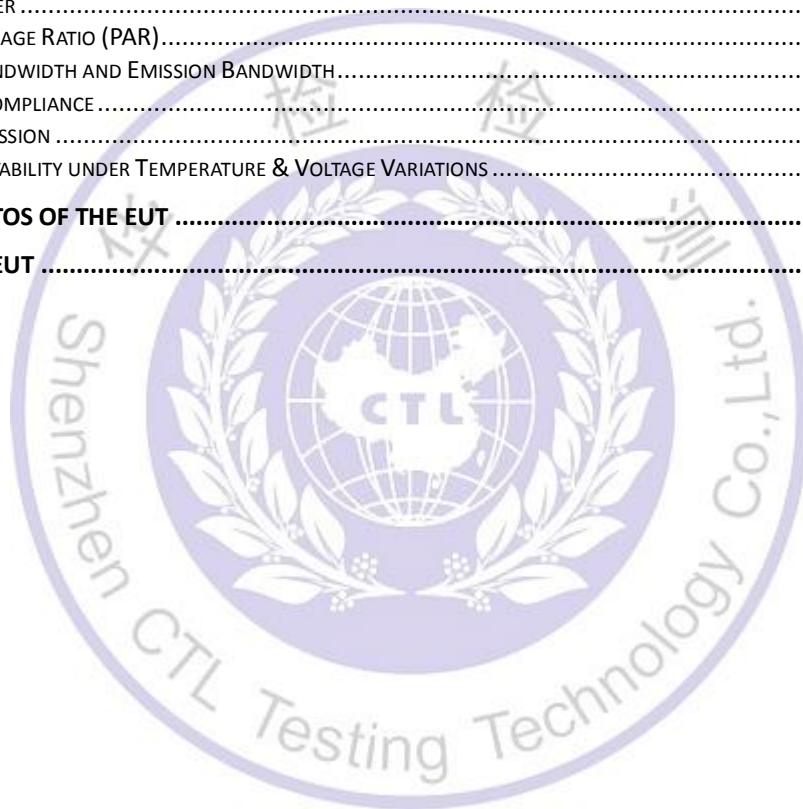

1. SUMMARY

1.1. TEST STANDARDS

The tests were performed according to following standards:

[FCC Part 27](#) : MISCELLANEOUS WIRELESS COMMUNICATIONS SERVICES

[TIA/EIA 603 D June 2010](#):Land Mobile FM or PM Communications Equipment Measurement and Performance Standards.

[FCC Part 2](#): FREQUENCY ALLOCA-TIONS AND RADIO TREATY MAT-TERS; GENERAL RULES AND REG-ULATIONS

[KDB971168 D01: v02r02](#) MEASUREMENT GUIDANCE FOR CERTIFICATION OF LICENSED DIGITAL TRANSMITTERS

[ANSI C63.10: 2013](#): American National Standard for Testing Unlicensed Wireless Devices

[ANSI C63.4: 2014](#): –American National Standard for Methods of Measurement of Radio-Noise Emissions from Low-Voltage Electrical and Electronic Equipment in the Range of 9 kHz to 40GHz
Range of 9 kHz to 40GHz

1.2. Test Description

Test Item	Section in CFR 47	Result
RF Output Power	Part 2.1046 Part 27.50(d)(4)	Pass
Peak-to-Average Ratio	Part 27.50(d)(4)	Pass
99% & -26 dB Occupied Bandwidth	Part 2.1049 Part 27.53(h)	Pass
Spurious Emissions at Antenna Terminal	Part 2.1051 Part 27.53(h)	Pass
Field Strength of Spurious Radiation	Part 2.1053 Part 27.53(h)	Pass
Out of band emission, Band Edge	Part 2.1051 Part 27.53(h)	Pass
Frequency stability	Part 2.1055 Part 27.54	Pass

1.3. Test Facility

1.3.1 Address of the test laboratory

Shenzhen CTL Testing Technology Co., Ltd.

Floor 1-A, Baisha Technology Park, No. 3011, Shahexi Road, Nanshan, Shenzhen 518055 China

There is one 3m semi-anechoic chamber and two line conducted labs for final test. The Test Sites meet the requirements in documents ANSI C63.4 and CISPR 32/EN 55032 requirements.

1.3.2 Laboratory accreditation

The test facility is recognized, certified, or accredited by the following organizations:

IC Registration No.: 9618B

The 3m alternate test site of Shenzhen CTL Testing Technology Co., Ltd. EMC Laboratory has been registered by Certification and Engineer Bureau of Industry Canada for the performance of with Registration No.: 9618B on November 13, 2013.

FCC-Registration No.: 970318

Shenzhen CTL Testing Technology Co., Ltd. EMC Laboratory has been registered and fully described in a report filed with the (FCC) Federal Communications Commission. The acceptance letter from the FCC is maintained in our files. Registration 970318, December 19, 2013.

1.4. Statement of the measurement uncertainty

The data and results referenced in this document are true and accurate. The reader is cautioned that there may be errors within the calibration limits of the equipment and facilities. The measurement uncertainty was calculated for all measurements listed in this test report acc. to CISPR 16 - 4 "Specification for radio disturbance and immunity measuring apparatus and methods – Part 4: Uncertainty in EMC Measurements" and is documented in the Shenzhen CTL Testing Technology Co., Ltd. quality system acc. to DIN EN ISO/IEC 17025. Furthermore, component and process variability of devices similar to that tested may result in additional deviation. The manufacturer has the sole responsibility of continued compliance of the device.

Hereafter the best measurement capability for CTL laboratory is reported:

Test	Range	Measurement Uncertainty	Notes
Radiated Emission	30~1000MHz	4.10dB	(1)
Radiated Emission	Above 1GHz	4.32dB	(1)
Conducted Disturbance	0.15~30MHz	3.20dB	(1)

- (1) This uncertainty represents an expanded uncertainty expressed at approximately the 95% confidence level using a coverage factor of k=2.

2. GENERAL INFORMATION

2.1. Environmental conditions

During the measurement the environmental conditions were within the listed ranges:

Normal Temperature:	25°C
Relative Humidity:	55 %
Air Pressure:	101 kPa

2.2. General Description of EUT

Product Name:	8 inch 4G Tablet
Model/Type reference:	TT800Q
Power supply:	DC 3.7V from battery
LTE	
Operation Band:	FDD-LTE: Band 2/4/5/12
Modulation Type:	QPSK, 16QAM
Release Version:	Release 9
Category:	Cat 4
Antenna Type:	PIFA antenna

Note: For more details, please refer to the user's manual of the EUT.

2.3. Description of Test Modes

The EUT has been tested under typical operating condition. The CMW500 used to control the EUT staying in continuous transmitting and receiving mode for testing. Regards to the frequency band operation: the lowest, middle and highest frequency of channel were selected to perform the test, then shown on this report.

2.4. Equipments Used during the Test

Test Equipment	Manufacturer	Model No.	Serial No.	Calibration Date	Calibration Due Date
Bilog Antenna	Sunol Sciences Corp.	JB1	A061713	2017/06/02	2018/06/01
Bilog Antenna	Sunol Sciences Corp.	JB1	A061714	2017/06/02	2018/06/01
EMI Test Receiver	R&S	ESCI	103710	2017/06/02	2018/06/01
Spectrum Analyzer	Agilent	E4407B	MY41440676	2017/05/21	2018/05/20
Spectrum Analyzer	Agilent	N9020	US46220290	2017/01/16	2018/01/17
Controller	EM Electronics	Controller EM 1000	N/A	2017/05/21	2018/05/20
Horn Antenna	Sunol Sciences Corp.	DRH-118	A062013	2017/05/19	2018/05/18
Horn Antenna	Sunol Sciences Corp.	DRH-118	A062014	2017/05/19	2018/05/18
Active Loop Antenna	SCHWARZBEC K	FMZB1519	1519-037	2017/05/19	2018/05/18
Amplifier	Agilent	8349B	3008A02306	2017/05/19	2018/05/18

Amplifier	Agilent	8447D	2944A10176	2017/05/19	2018/05/18
Temperature/Humidity Meter	Gangxing	CTH-608	02	2017/05/20	2018/05/19
Wideband Radio Communication Tester	R&S	CMW500	101814	2016/11/21	2017/11/20
High-Pass Filter	K&L	9SH10-2700/X1 2750-O/O	N/A	2017/05/20	2018/05/19
High-Pass Filter	K&L	41H10-1375/U1 2750-O/O	N/A	2017/05/20	2018/05/19
RF Cable	HUBER+SUHNER	RG214	N/A	2017/06/02	2018/06/01
Climate Chamber	ESPEC	EL-10KA	A20120523	2017/05/19	2018/05/18
SIGNAL GENERATOR	Agilent	E4421B	US40051744	2017/05/19	2018/05/18
Directional Coupler	Agilent	87300B	3116A03638	2017/05/19	2018/05/18

The calibration interval was one year

2.5. Related Submittal(s) / Grant (s)

This submittal(s) (test report) is intended to comply with of the Part 27 Rules.

2.6. Modifications

No modifications were implemented to meet testing criteria.

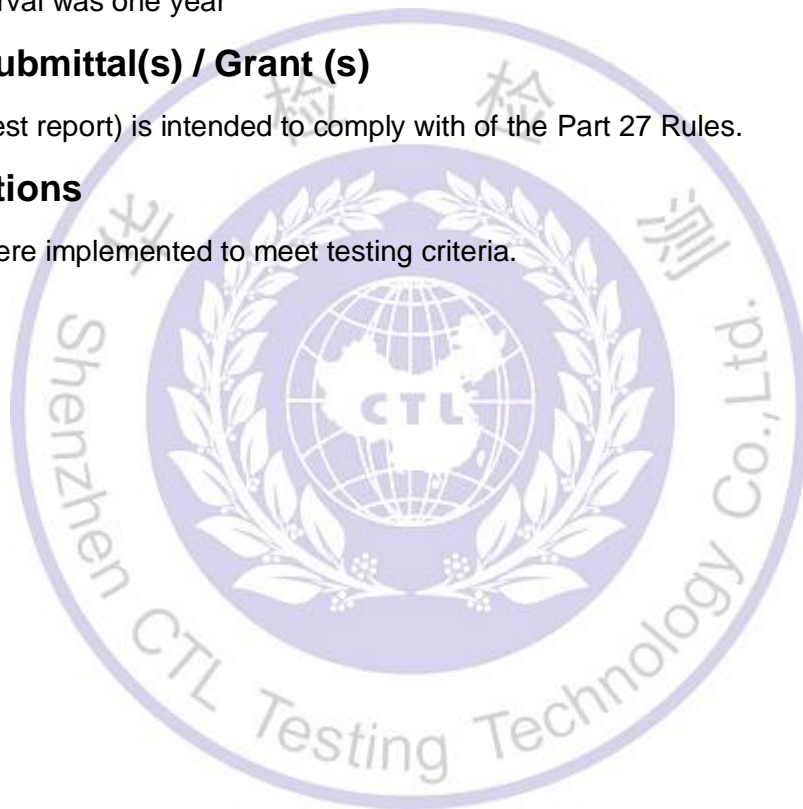

3. TEST CONDITIONS AND RESULTS

3.1. Output Power

LIMIT

According to § 27.50 C(10): Portable stations (hand-held devices) in the 600 MHz uplink band and the 698-746 MHz band, and fixed and mobile stations in the 600 MHz uplink band are limited to 3 watts ERP.”

TEST CONFIGURATION

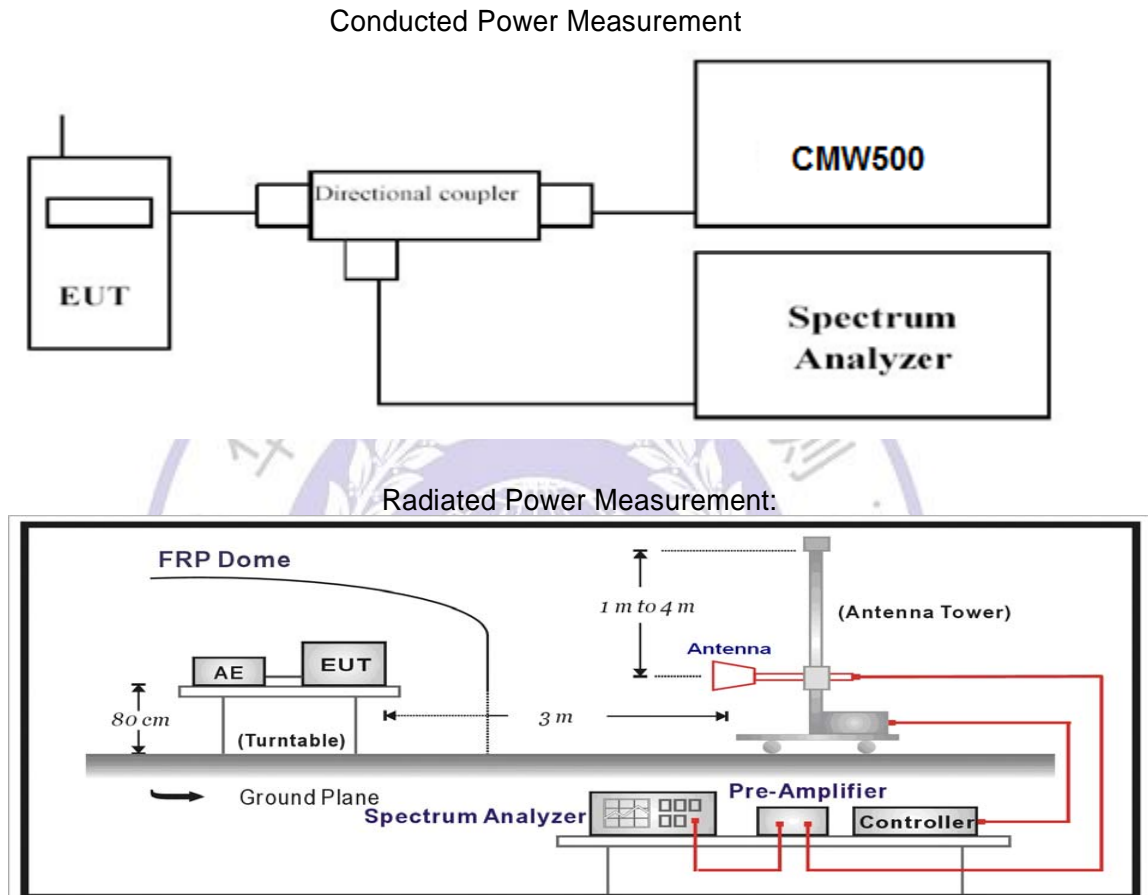

TEST PROCEDURE

The EUT was setup according to EIA/TIA 603D

Conducted Power Measurement:

- a) Place the EUT on a bench and set it in transmitting mode.
- b) Connect a low loss RF cable from the antenna port to a spectrum analyzer and CMW500 by a Directional Couple.
- c) EUT Communicate with CMW500 then selects a channel for testing.
- d) Add a correction factor to the display of spectrum, and then test.

Radiated Power Measurement:

- a) The EUT shall be placed at the specified height on a support, and in the position closest to normal use as declared by provider.
- b) The test antenna shall be oriented initially for vertical polarization and shall be chosen to correspond to the frequency of the transmitter

- c) The output of the test antenna shall be connected to the measuring receiver.
- d) The transmitter shall be switched on and the measuring receiver shall be tuned to the frequency of the transmitter under test.
- e) The test antenna shall be raised and lowered through the specified range of height until a maximum signal level is detected by the measuring receiver.
- f) The transmitter shall then be rotated through 360° in the horizontal plane, until the maximum signal level is detected by the measuring receiver.
- g) The test antenna shall be raised and lowered again through the specified range of height until a maximum signal level is detected by the measuring receiver.
- h) The maximum signal level detected by the measuring receiver shall be noted.
- i) The transmitter shall be replaced by a substitution antenna.
- j) The substitution antenna shall be orientated for vertical polarization and the length of the substitution antenna shall be adjusted to correspond to the frequency of the transmitter.
- k) The substitution antenna shall be connected to a calibrated signal generator.
- l) If necessary, the input attenuator setting of the measuring receiver shall be adjusted in order to increase the sensitivity of the measuring receiver.
- m) The test antenna shall be raised and lowered through the specified range of height to ensure that the maximum signal is received.
- n) The input signal to the substitution antenna shall be adjusted to the level that produces a level detected by the measuring receiver, that is equal to the level noted while the transmitter radiated power was measured, corrected for the change of input attenuator setting of the measuring receiver.
- o) The measurement shall be repeated with the test antenna and the substitution antenna orientated for horizontal polarization.
- p) The measure of the effective radiated power is the larger of the two levels recorded at the input to the substitution antenna, corrected for gain of the substitution antenna if necessary.
- q) Test site anechoic chamber refer to ANSI C63.4.

TEST RESULTS**Conducted Measurement:**

LTE FDD Band 12				
TX Channel Bandwidth	RB Size/Offset	Frequency (MHz)	Average Power [dBm]	
			QPSK	16QAM
1.4 MHz	1 RB low	699.7	22.60	22.44
		707.5	22.50	22.38
		715.3	22.63	22.47
	1 RB high	699.7	22.41	22.05
		707.5	22.02	21.38
		715.3	21.66	20.93
	50% RB mid	699.7	22.36	21.66
		707.5	22.31	21.82
		715.3	22.80	22.70
	100% RB	699.7	22.19	21.40
		707.5	22.25	21.76
		715.3	22.79	22.69
3 MHz	1 RB low	700.5	21.62	20.80
		707.5	22.49	21.70
		714.5	22.22	21.82
	1 RB high	700.5	21.55	21.19
		707.5	22.64	22.33
		714.5	22.78	22.35
	50% RB mid	700.5	22.83	22.61
		707.5	22.81	22.07
		714.5	22.84	22.40
	100% RB	700.5	22.29	21.90
		707.5	22.38	21.66
		714.5	22.81	22.66
5 MHz	1 RB low	701.5	22.73	22.24
		707.5	22.53	22.13
		713.5	22.41	21.81
	1 RB high	701.5	22.02	21.44
		707.5	22.14	21.59
		713.5	21.72	21.16
	50% RB mid	701.5	21.91	21.21
		707.5	22.26	21.77
		713.5	22.42	21.93
	100% RB	701.5	21.85	21.13
		707.5	22.58	22.09
		713.5	23.08	22.40
10 MHz	1 RB low	704.0	22.42	21.98
		707.5	22.19	21.09
		711.0	22.61	20.88
	1 RB high	704.0	22.03	21.97
		707.5	22.76	22.22
		711.0	22.10	22.41
	50% RB mid	704.0	21.74	21.34
		707.5	23.05	22.07
		711.0	23.00	21.31
	100% RB	704.0	21.64	22.71
		707.5	23.08	21.73
		711.0	23.18	22.81

Radiated Measurement:

Remark:

1. We were tested all RB Configuration refer 3GPP TS136 521 for each Channel Bandwidth of LTE FDD Band 12; recorded worst case for each Channel Bandwidth of LTE FDD Band 12.
2. $EIRP = P_{Mea}(dBm) - P_{cl}(dB) + P_{Ag}(dB) + G_a(dBi)$

LTE FDD Band 12_Channel Bandwidth 1.4MHz_QPSK

Frequency (MHz)	P _{Mea} (dBm)	P _{cl} (dB)	G _a Antenna Gain(dB)	Correction (dB)	P _{Ag} (dB)	ERP (dBm)	Limit (dBm)	Margin (dB)	Polarization
699.7	-18.28	2.38	8.23	2.15	36.70	22.12	34.77	12.65	V
707.5	-17.42	2.40	8.29	2.15	36.70	23.02	34.77	11.75	V
715.3	-17.86	2.43	8.28	2.15	36.70	22.54	34.77	12.23	V

LTE FDD Band 12_Channel Bandwidth 3MHz_QPSK

Frequency (MHz)	P _{Mea} (dBm)	P _{cl} (dB)	G _a Antenna Gain(dB)	Correction (dB)	P _{Ag} (dB)	ERP (dBm)	Limit (dBm)	Margin (dB)	Polarization
700.5	-18.35	2.38	8.23	2.15	36.70	22.05	34.77	12.72	V
707.5	-17.79	2.40	8.29	2.15	36.70	22.65	34.77	12.12	V
714.5	-18.25	2.43	8.28	2.15	36.70	22.15	34.77	12.62	V

LTE FDD Band 12_Channel Bandwidth 5MHz_QPSK

Frequency (MHz)	P _{Mea} (dBm)	P _{cl} (dB)	G _a Antenna Gain(dB)	Correction (dB)	P _{Ag} (dB)	ERP (dBm)	Limit (dBm)	Margin (dB)	Polarization
701.5	-17.55	2.38	8.23	2.15	36.70	22.85	34.77	11.92	V
707.5	-17.48	2.40	8.29	2.15	36.70	22.96	34.77	11.81	V
713.5	-18.28	2.43	8.28	2.15	36.70	22.12	34.77	12.65	V

LTE FDD Band 12_Channel Bandwidth 10MHz_QPSK

Frequency (MHz)	P _{Mea} (dBm)	P _{cl} (dB)	G _a Antenna Gain(dB)	Correction (dB)	P _{Ag} (dB)	ERP (dBm)	Limit (dBm)	Margin (dB)	Polarization
704.0	-17.38	2.38	8.23	2.15	36.70	23.02	34.77	11.75	V
707.5	-17.32	2.40	8.29	2.15	36.70	23.12	34.77	11.65	V
711.0	-17.41	2.43	8.28	2.15	36.70	22.99	34.77	11.78	V

LTE FDD Band 12_Channel Bandwidth 1.4MHz_16QAM

Frequency (MHz)	P _{Mea} (dBm)	P _{cl} (dB)	G _a Antenna Gain(dB)	Correction (dB)	P _{Ag} (dB)	ERP (dBm)	Limit (dBm)	Margin (dB)	Polarization
699.7	-18.42	2.38	8.23	2.15	36.70	21.98	34.77	12.79	V
707.5	-18.99	2.40	8.29	2.15	36.70	21.45	34.77	13.32	V
715.3	-19.88	2.43	8.28	2.15	36.70	20.52	34.77	14.25	V

LTE FDD Band 12_Channel Bandwidth 3MHz_16QAM

Frequency (MHz)	P _{Mea} (dBm)	P _{cl} (dB)	G _a Antenna Gain(dB)	Correction (dB)	P _{Ag} (dB)	ERP (dBm)	Limit (dBm)	Margin (dB)	Polarization
700.5	-19.15	2.38	8.23	2.15	36.70	21.25	34.77	13.52	V
707.5	-18.38	2.40	8.29	2.15	36.70	22.06	34.77	12.71	V
714.5	-18.86	2.43	8.28	2.15	36.70	21.54	34.77	13.23	V

LTE FDD Band 12_Channel Bandwidth 5MHz_16QAM

Frequency (MHz)	P _{Mea} (dBm)	P _{cl} (dB)	G _a Antenna Gain(dB)	Correction (dB)	P _{Ag} (dB)	ERP (dBm)	Limit (dBm)	Margin (dB)	Polarization
701.5	-19.04	2.38	8.23	2.15	36.70	21.36	34.77	13.41	V
707.5	-18.59	2.40	8.29	2.15	36.70	21.85	34.77	12.92	V
713.5	-18.71	2.43	8.28	2.15	36.70	21.69	34.77	13.08	V

LTE FDD Band 12_Channel Bandwidth 10MHz_16QAM

Frequency (MHz)	P _{Mea} (dBm)	P _{cl} (dB)	G _a Antenna Gain(dB)	Correction (dB)	P _{Ag} (dB)	ERP (dBm)	Limit (dBm)	Margin (dB)	Polarization
704.0	-18.74	2.38	8.23	2.15	36.70	21.66	34.77	13.11	V
707.5	-18.70	2.40	8.29	2.15	36.70	21.74	34.77	13.03	V
711.0	-19.72	2.43	8.28	2.15	36.70	20.68	34.77	14.09	V



3.2. Peak-to-Average Ratio (PAR)

LIMIT

The Peak-to-Average Ratio (PAR) of the transmission may not exceed 13 dB.

TEST CONFIGURATION

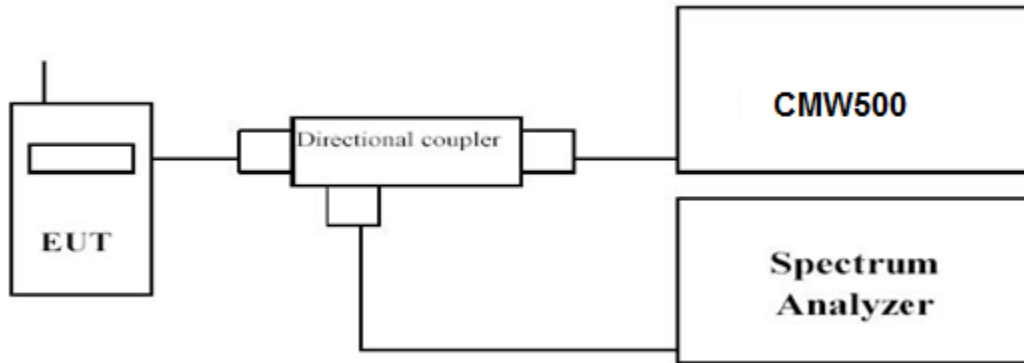

TEST PROCEDURE

1. Refer to instrument's analyzer instruction manual for details on how to use the power statistics/CCDF function;
2. Set resolution/measurement bandwidth \geq signal's occupied bandwidth;
3. Set the number of counts to a value that stabilizes the measured CCDF curve;
4. Set the measurement interval as follows:
 - 1). for continuous transmissions, set to 1 ms,
 - 2). for burst transmissions, employ an external trigger that is synchronized with the EUT burst timing sequence, or use the internal burst trigger with a trigger level that allows the burst to stabilize and set the measurement interval to a time that is less than or equal to the burst duration.
5. Record the maximum PAPR level associated with a probability of 0.1%.

TEST RESULTS

Remark:

1. We were tested all RB Configuration refer 3GPP TS136 521 for each Channel Bandwidth of LTE FDD Band 12; recorded worst case for each Channel Bandwidth of LTE FDD Band 12.

LTE FDD Band 12				
TX Channel Bandwidth	Frequency (MHz)	RB Size/Offset	PAPR (dB)	
			QPSK	16QAM
1.4 MHz	699.7	1RB#0	4.75	5.42
	707.5		4.31	5.09
	715.3		3.19	3.95
3 MHz	700.5	1RB#0	4.67	5.40
	707.5		4.25	4.65
	714.5		3.13	3.83
5 MHz	701.5	1RB#0	4.54	5.38
	707.5		4.02	4.81
	713.5		3.82	4.61
10 MHz	704.0	1RB#0	4.61	5.37
	707.5		3.76	4.23
	711.0		4.17	4.96

LTE FDD Band 12-1.4MHz Channel Bandwidth PAPR

QPSK

16QAM

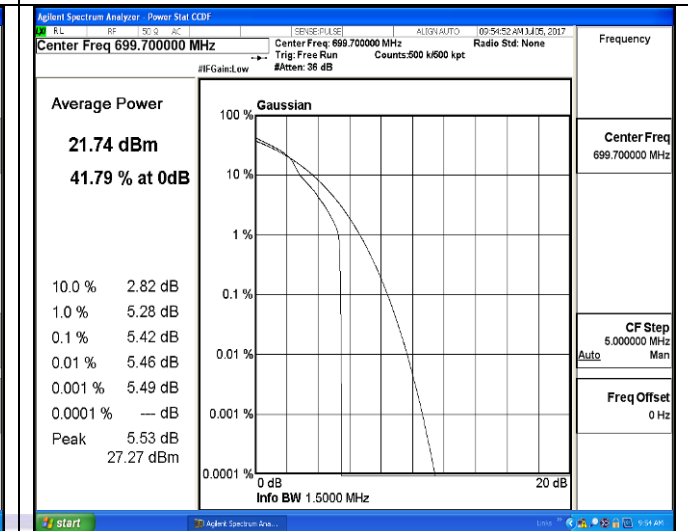
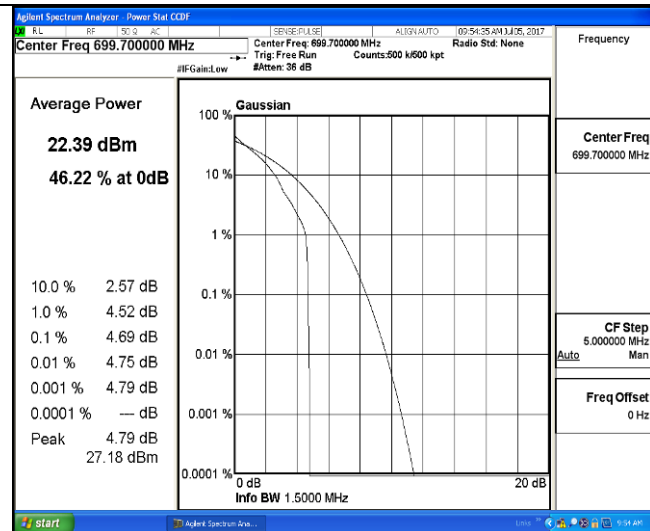

1RB#0

1RB#0

Low Channel

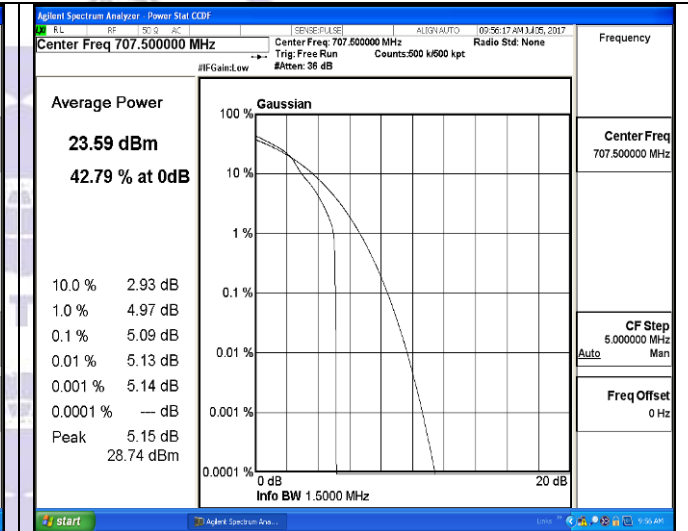
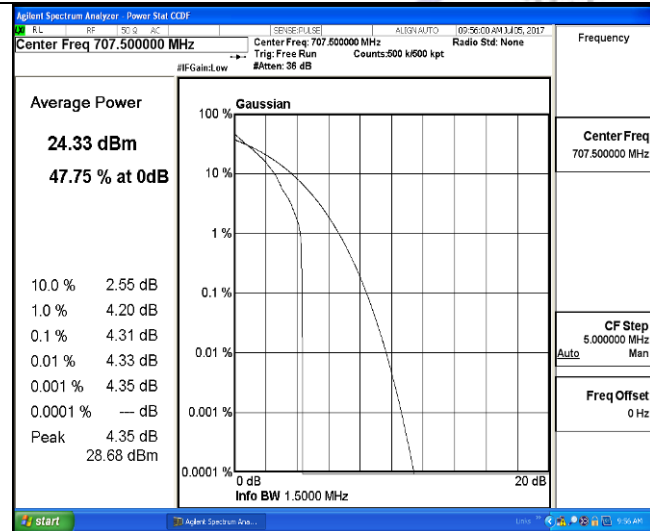

1RB#0

1RB#0

Middle Channel

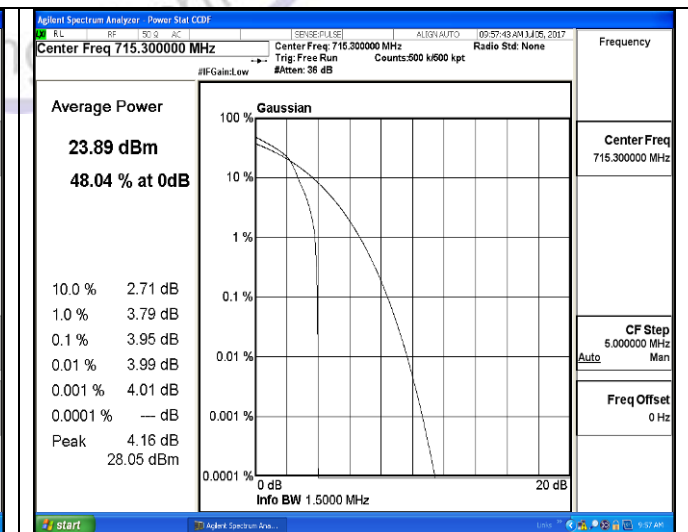
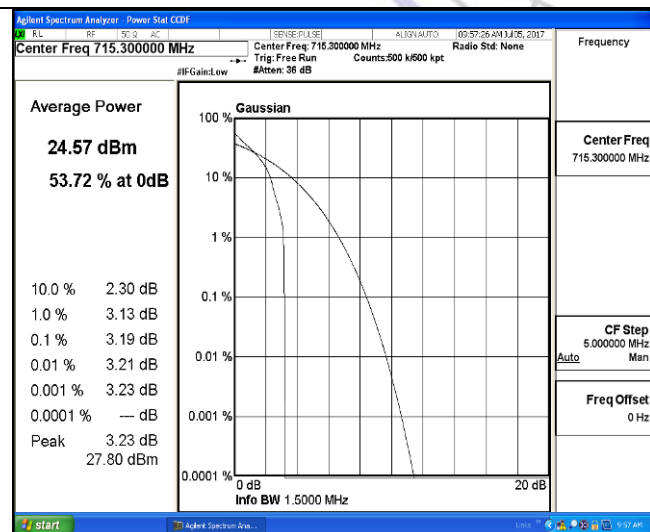

1RB#0

1RB#0

High Channel

LTE FDD Band 12-3MHz Channel Bandwidth PAPR

QPSK

16QAM

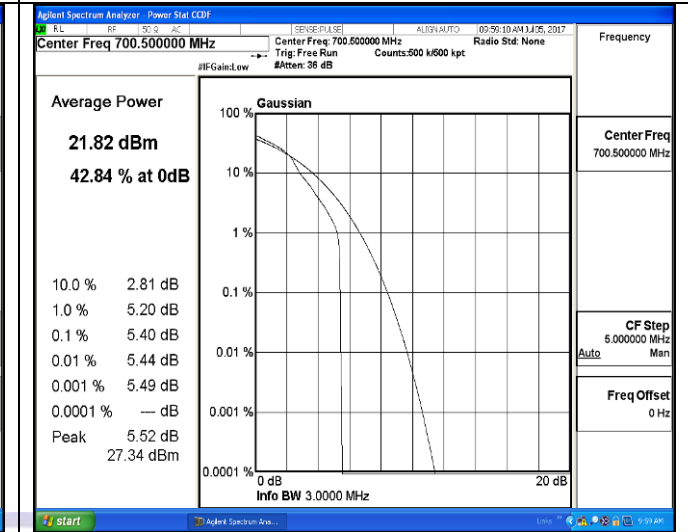
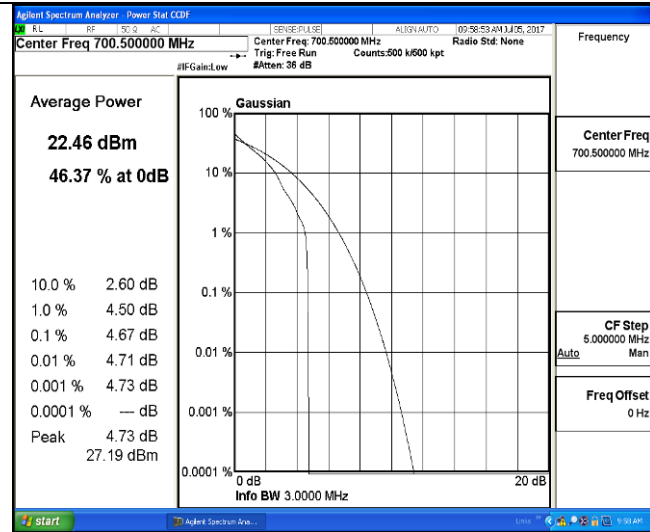

1RB#0

1RB#0

Low Channel

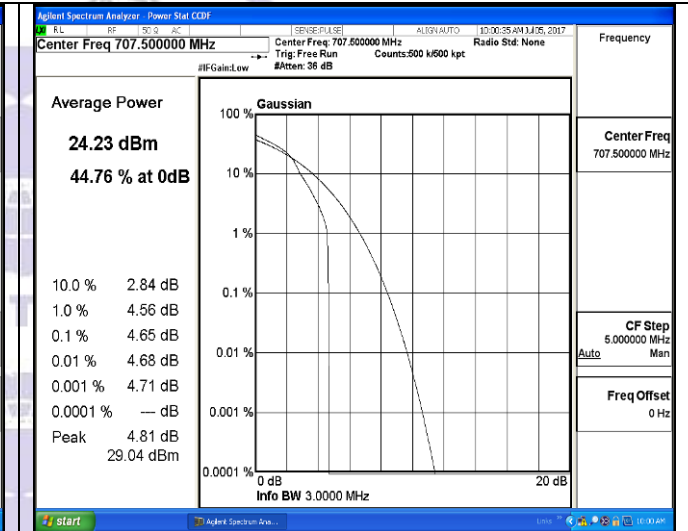
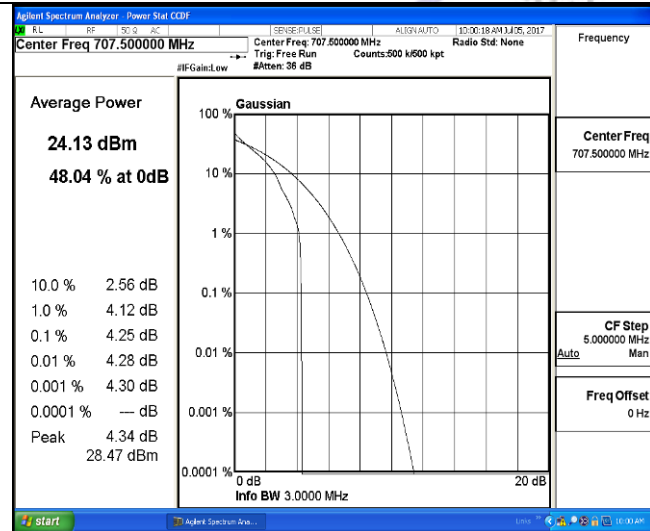

1RB#0

1RB#0

Middle Channel

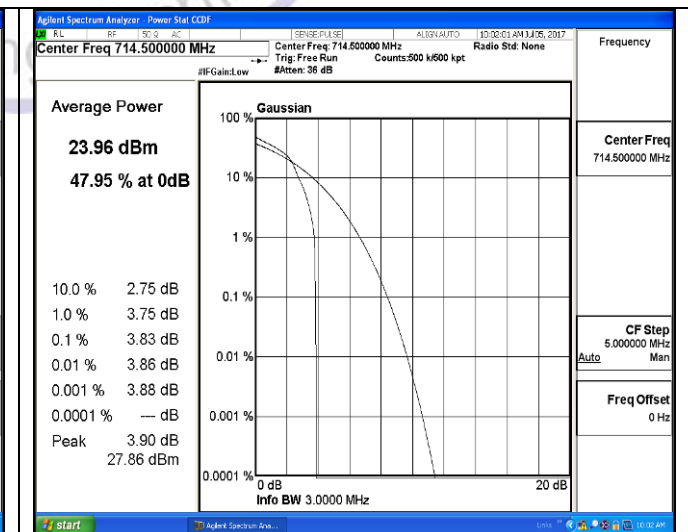
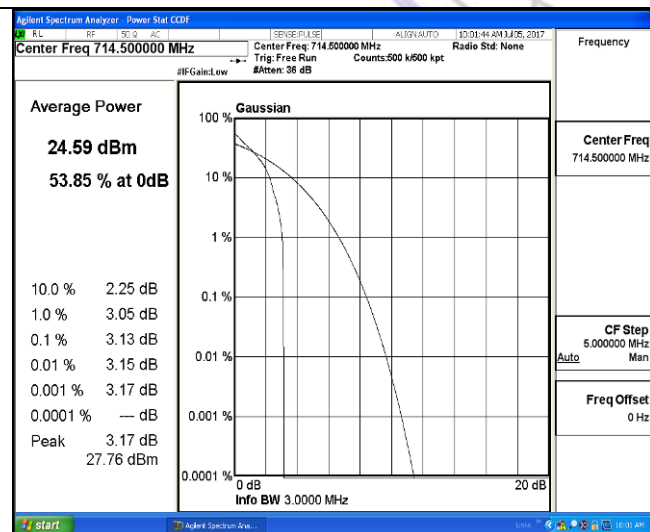

1RB#0

1RB#0

High Channel

LTE FDD Band 12-5MHz Channel Bandwidth PAPR

QPSK

16QAM

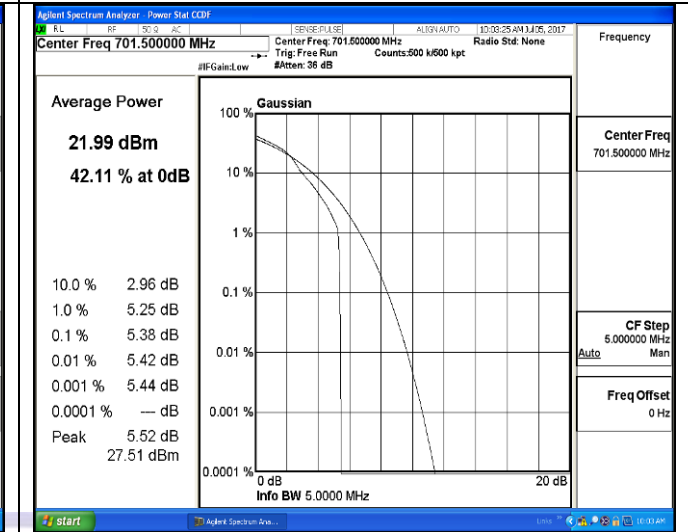
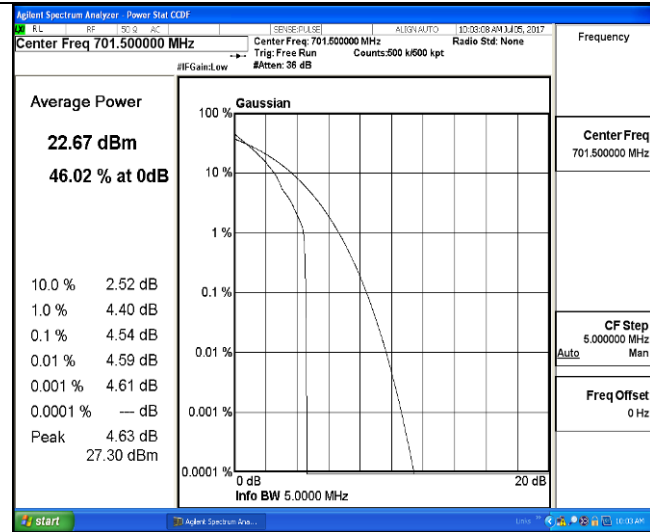

1RB#0

1RB#0

Low Channel

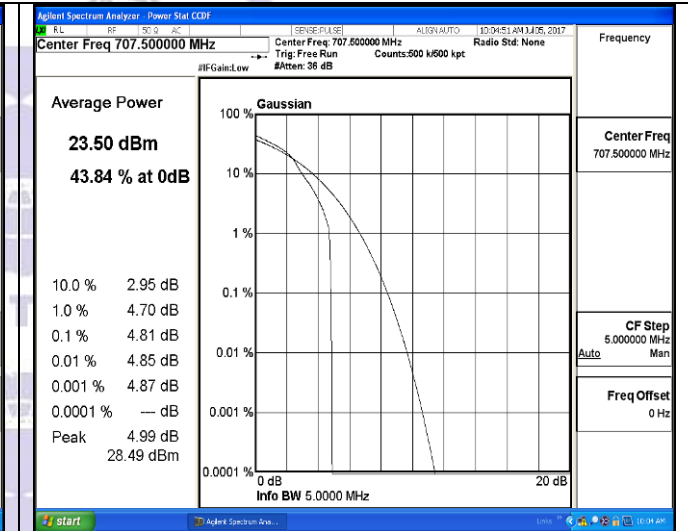
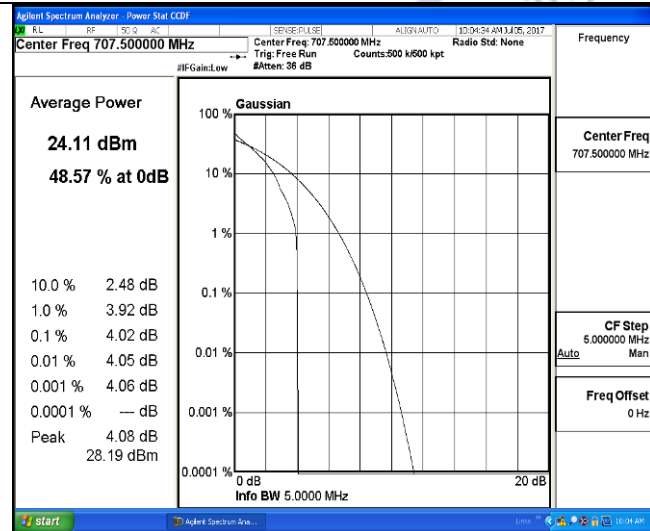

1RB#0

1RB#0

Middle Channel

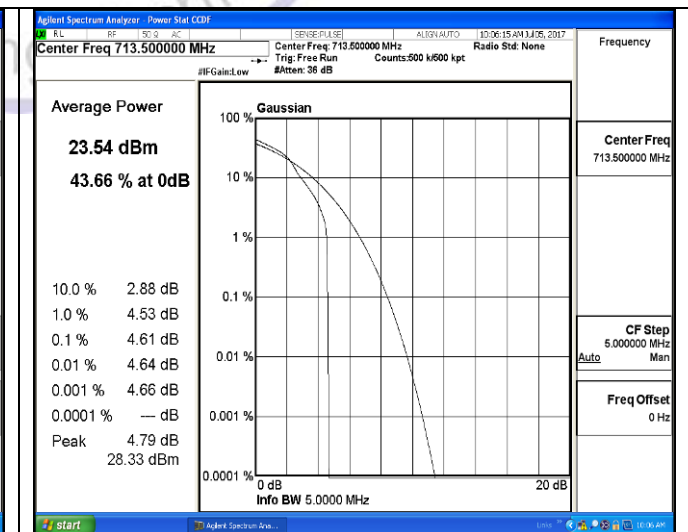
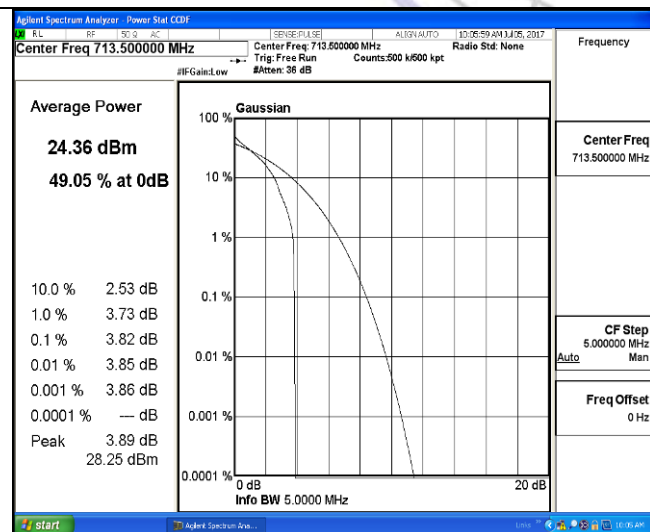

1RB#0

1RB#0

High Channel

LTE FDD Band 12-10MHz Channel Bandwidth PAPR

QPSK

16QAM

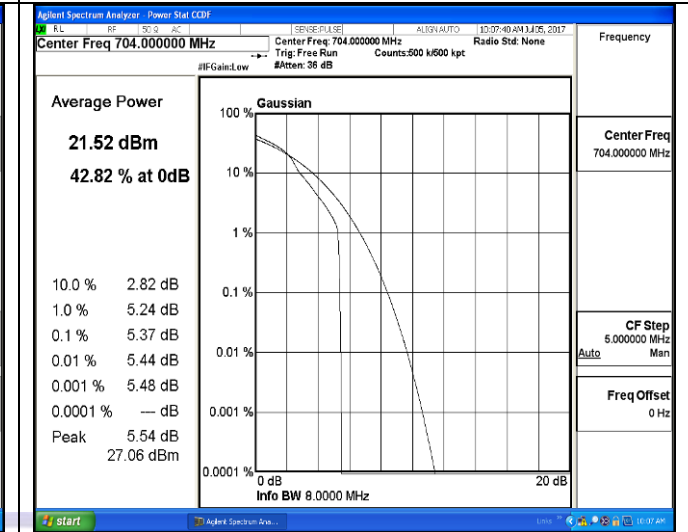
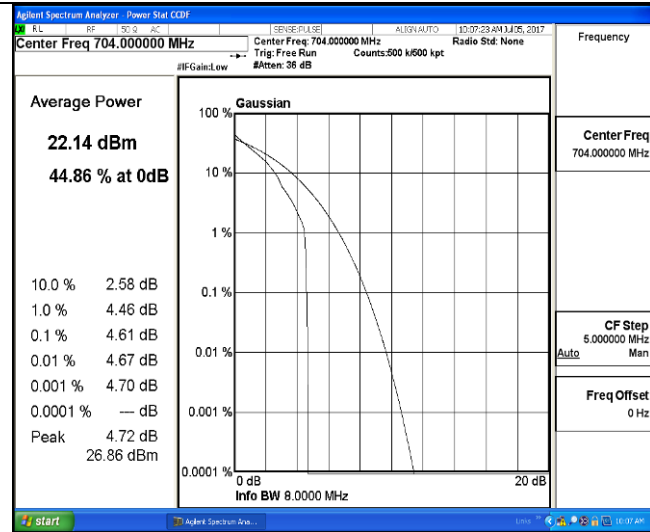

1RB#0

1RB#0

Low Channel

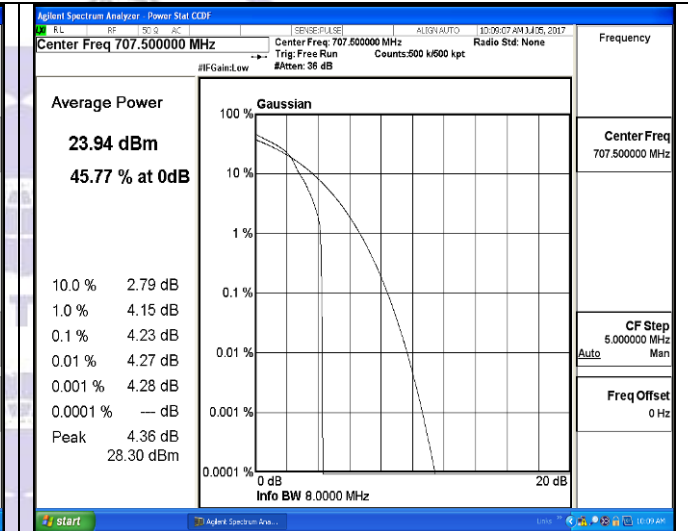
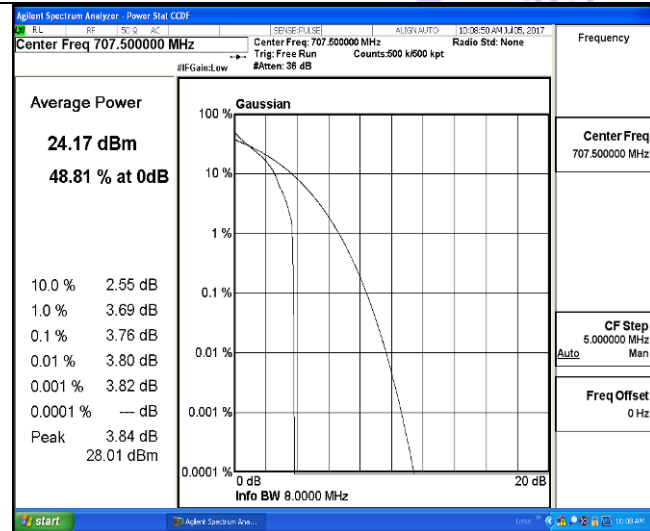

1RB#0

1RB#0

Middle Channel

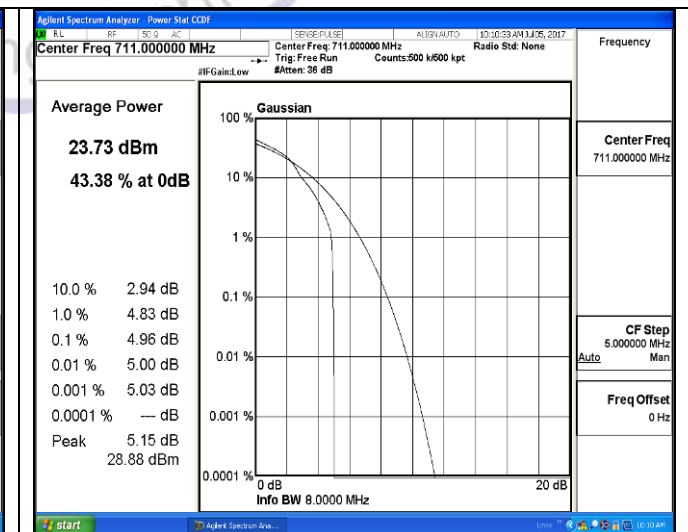
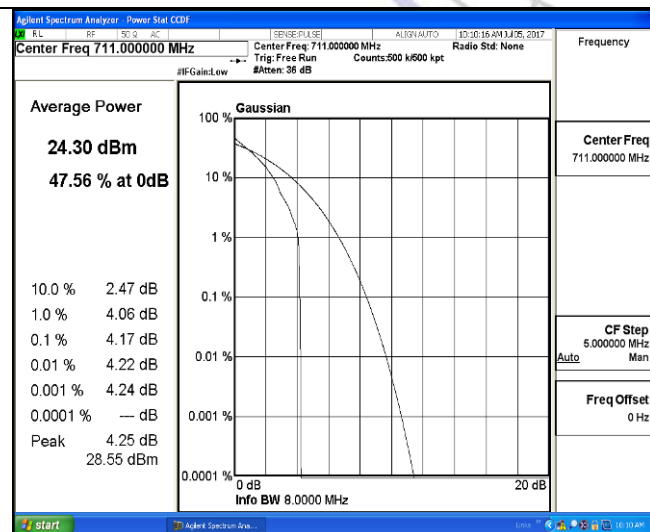

1RB#0

1RB#0

High Channel

3.3. Occupied Bandwidth and Emission Bandwidth

LIMIT

N/A

TEST CONFIGURATION

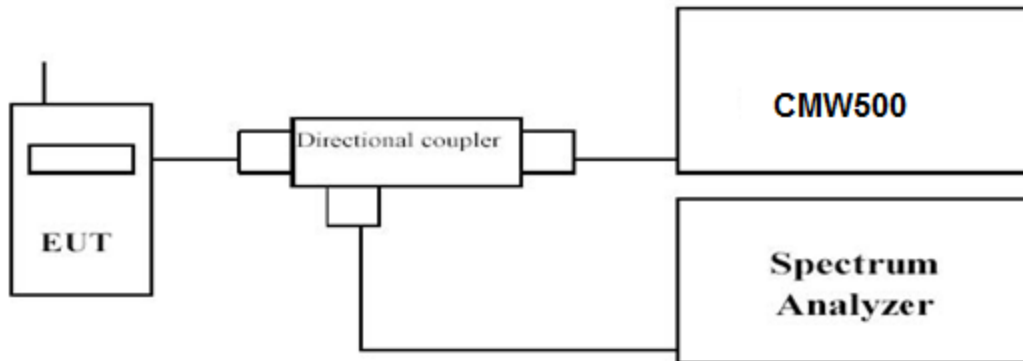

TEST PROCEDURE

The transmitter output was connected to a calibrated coaxial cable and coupler, the other end of which was connected to a spectrum analyzer. The occupied bandwidth was measured with the spectrum analyzer at low, middle and high channel in each band. The -26dBc Emission bandwidth was also measured and recorded.

Set RBW was set to about 1% of emission BW, VBW \geq 3 times RBW.

-26dBc display line was placed on the screen (or 99% bandwidth), the occupied bandwidth is the delta frequency between the two points where the display line intersects the signal trace.

TEST RESULTS

Remark:

1. We were tested all RB Configuration refer 3GPP TS136 521 for each Channel Bandwidth of LTE FDD Band 12; recorded worst case for each Channel Bandwidth of LTE FDD Band 12.

LTE FDD Band 12						
TX Channel Bandwidth	RB Size/Offset	Frequency (MHz)	-26dBc Emission bandwidth (MHz)		99% Occupied bandwidth (MHz)	
			QPSK	16QAM	QPSK	16QAM
1.4 MHz	6RB#0	699.7	1.216	1.241	1.0781	1.0813
		707.5	1.228	1.236	1.0755	1.0795
		715.3	1.246	1.231	1.0789	1.0792
3 MHz	15RB#0	700.5	2.896	2.908	2.6873	2.6865
		707.5	2.886	2.905	2.6857	2.6856
		714.5	2.950	2.938	2.6898	2.6868
5 MHz	25RB#0	701.5	4.791	4.819	4.4810	4.4786
		707.5	4.799	4.795	4.1843	4.4812
		713.5	4.831	4.830	4.4711	4.4771
10 MHz	50RB#0	704.0	9.392	9.344	8.8878	8.8891
		707.5	9.436	9.447	8.9441	8.9378
		711.0	9.473	9.467	8.9489	8.9653

LTE FDD Band 12-1.4MHz Channel Bandwidth

QPSK

16QAM

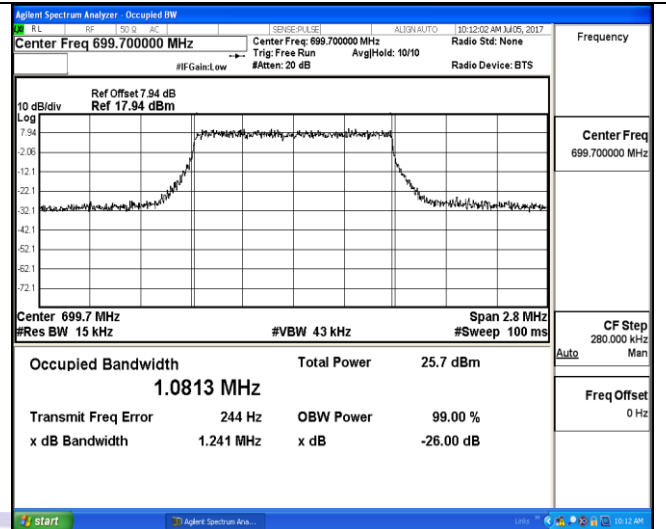
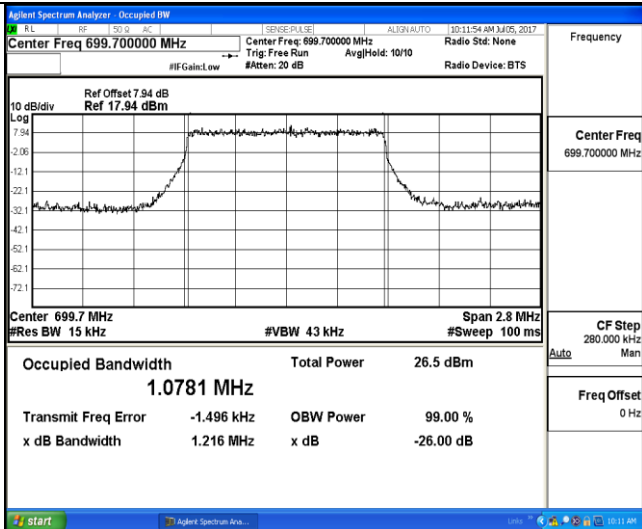

6RB#0

6RB#0

Low Channel

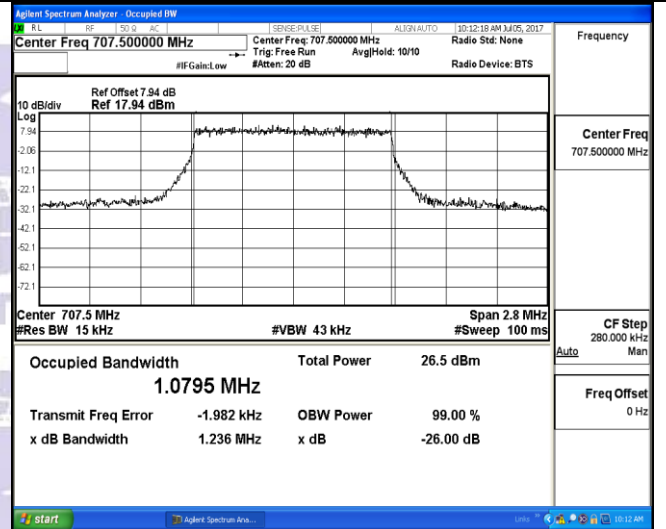
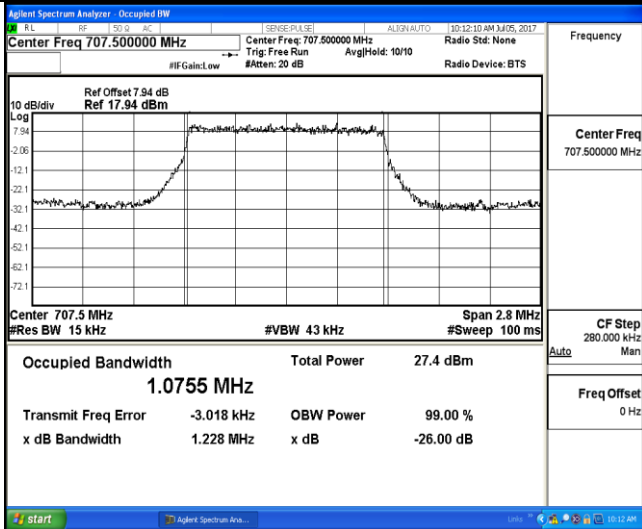

6RB#0

6RB#0

Middle Channel

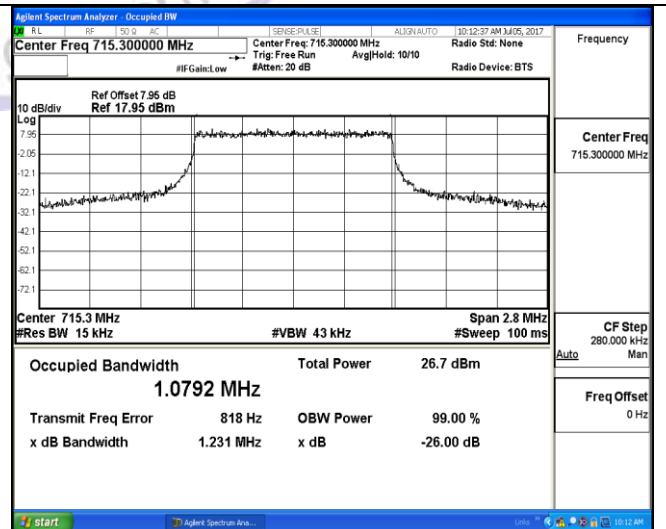
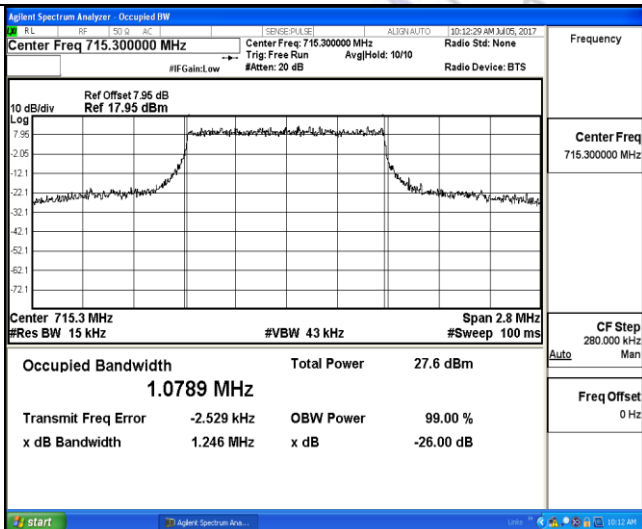

6RB#0

6RB#0

High Channel

LTE FDD Band 12-3MHz Channel Bandwidth

QPSK

16QAM

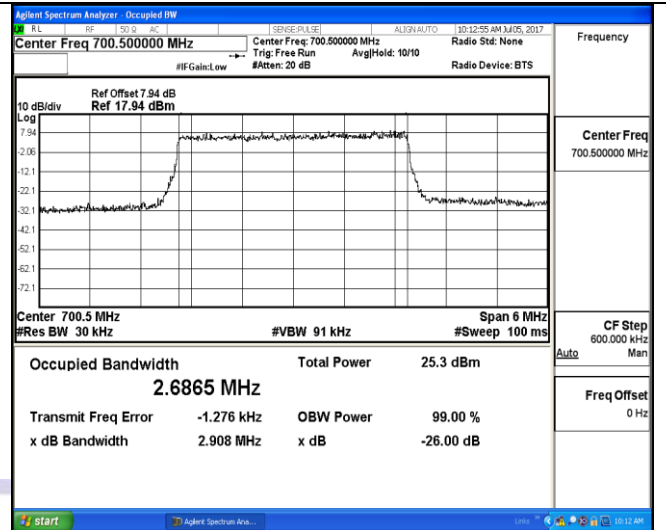
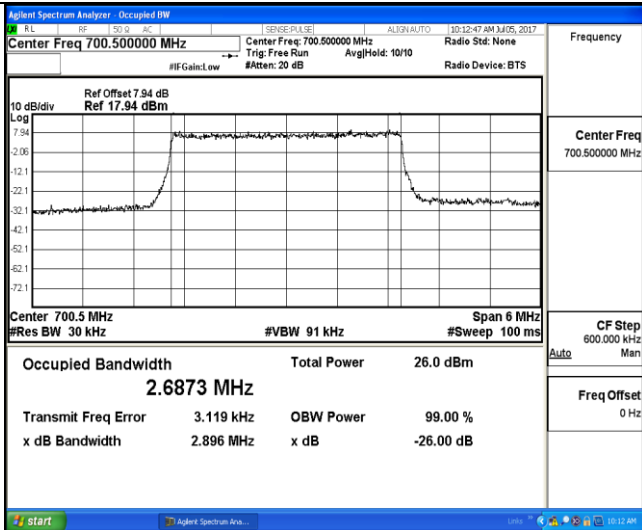

15RB#0

15RB#0

Low Channel

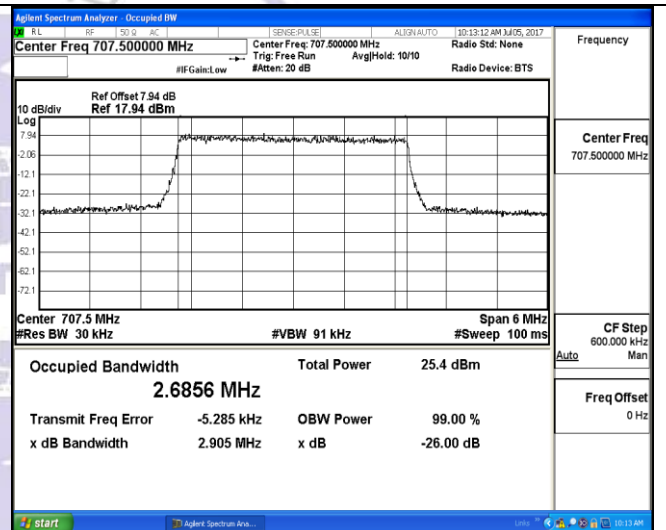
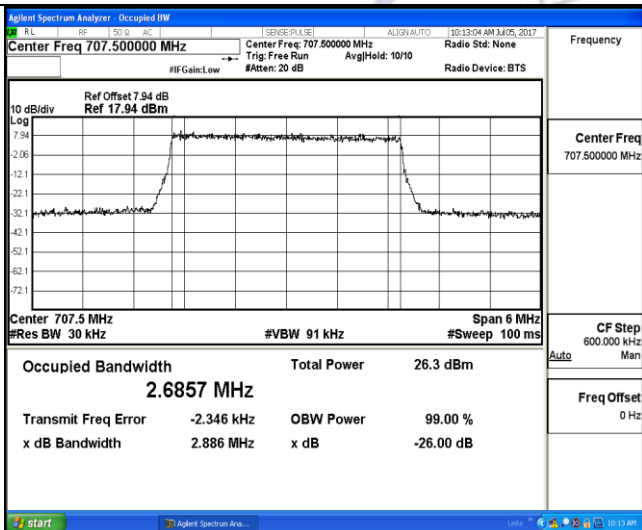

15RB#0

15RB#0

Middle Channel

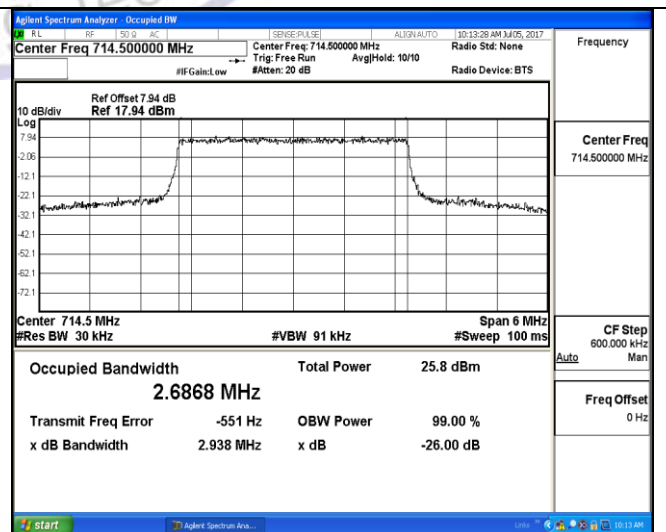
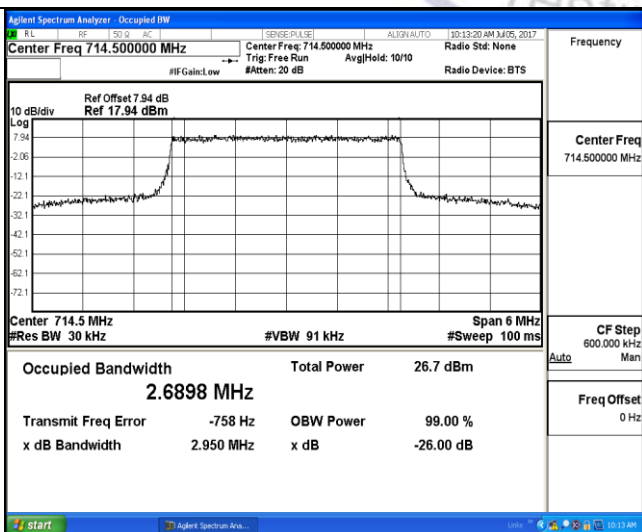

15RB#0

15RB#0

High Channel

LTE FDD Band 12-5MHz Channel Bandwidth

QPSK

16QAM

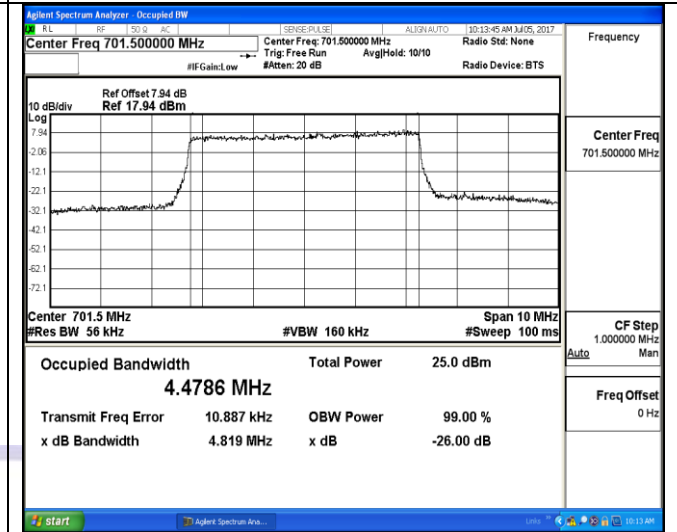
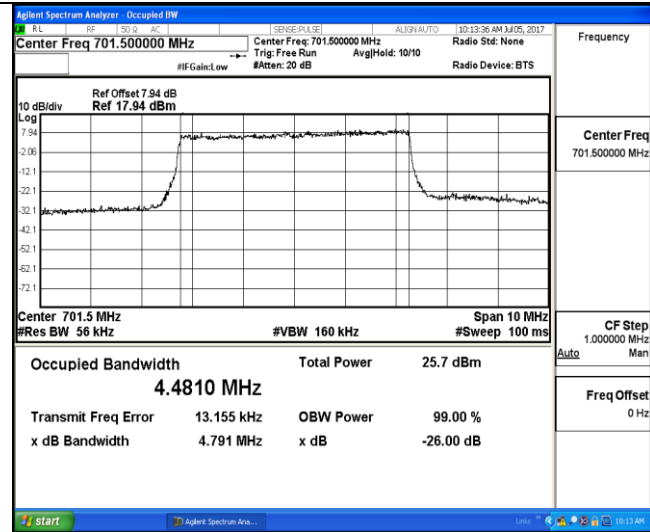

25RB#0

25RB#0

Low Channel

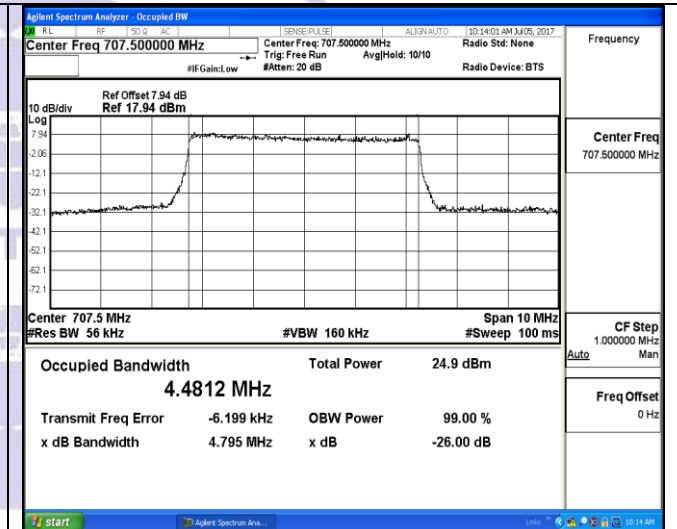
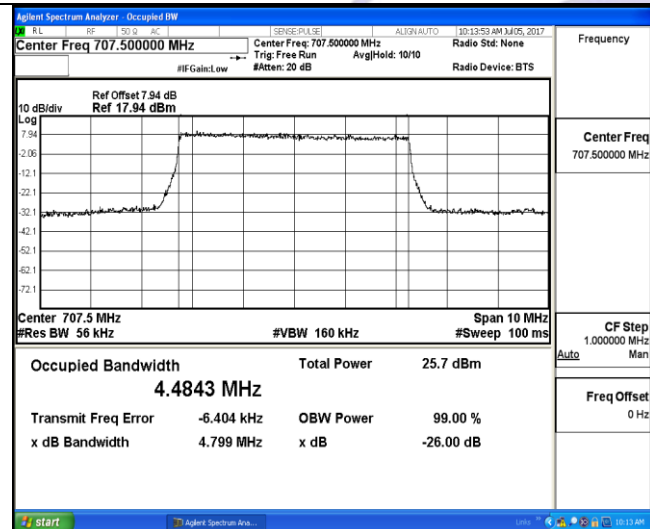

25RB#0

25RB#0

Middle Channel

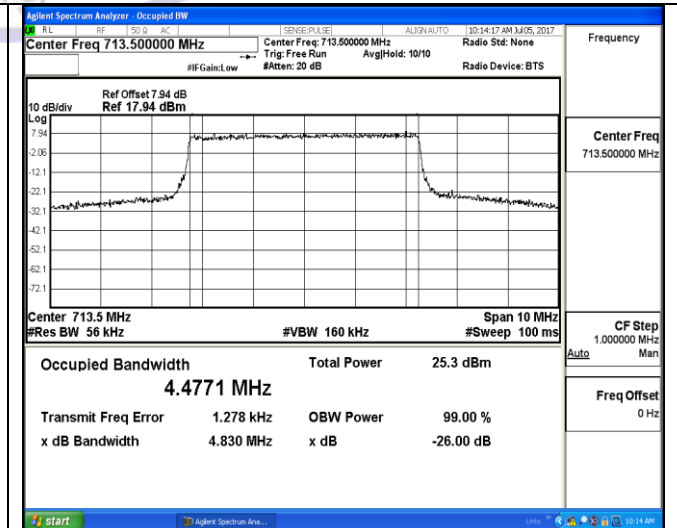
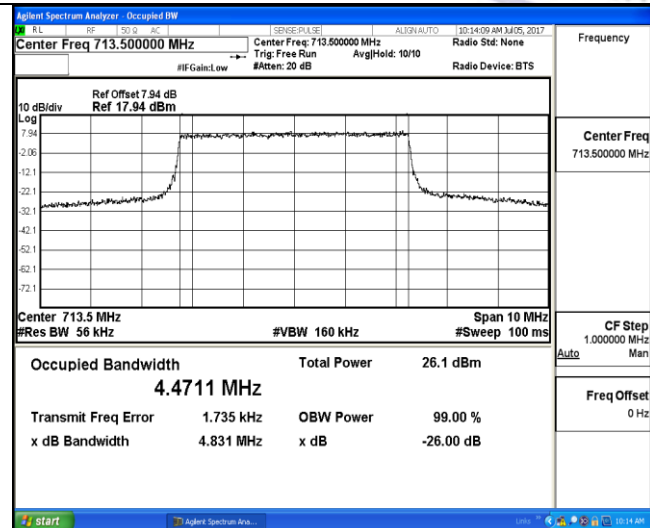

25RB#0

25RB#0

High Channel

LTE FDD Band 12-10MHz Channel Bandwidth

QPSK

16QAM

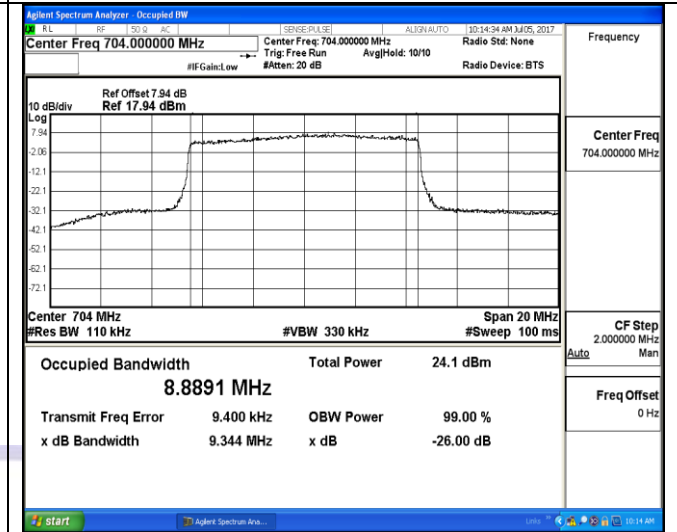
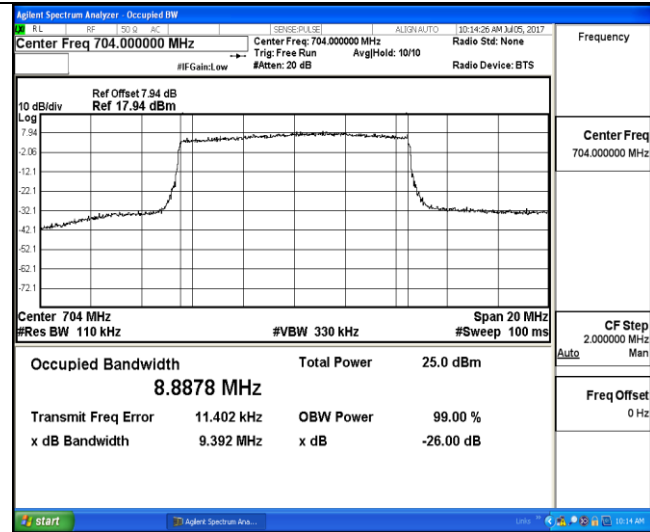

50RB#0

50RB#0

Low Channel

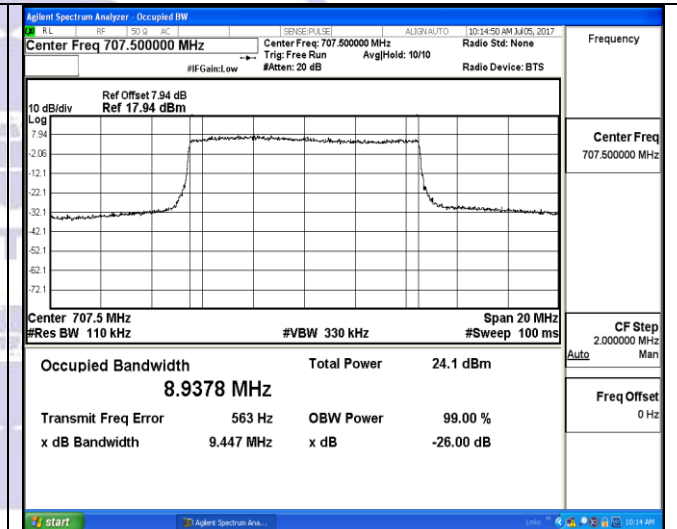
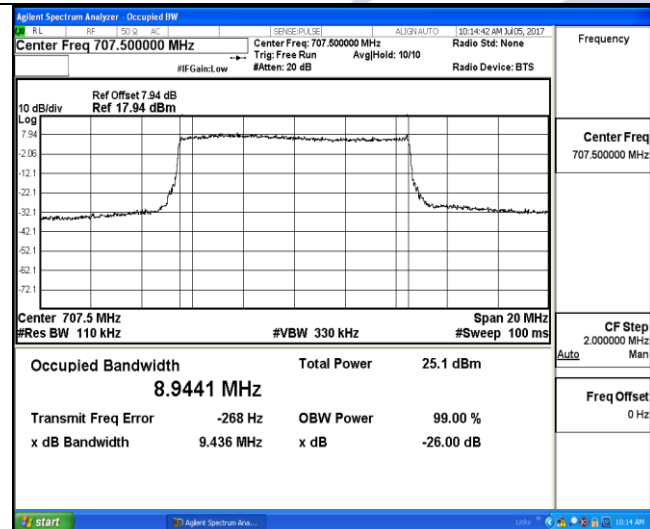

50RB#0

50RB#0

Middle Channel

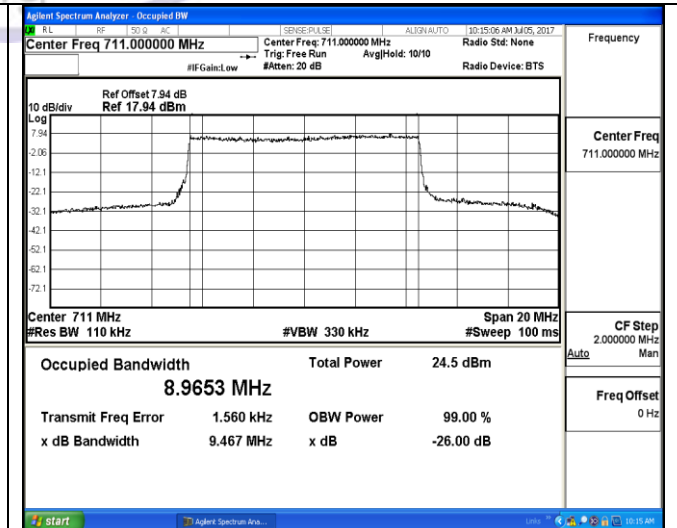
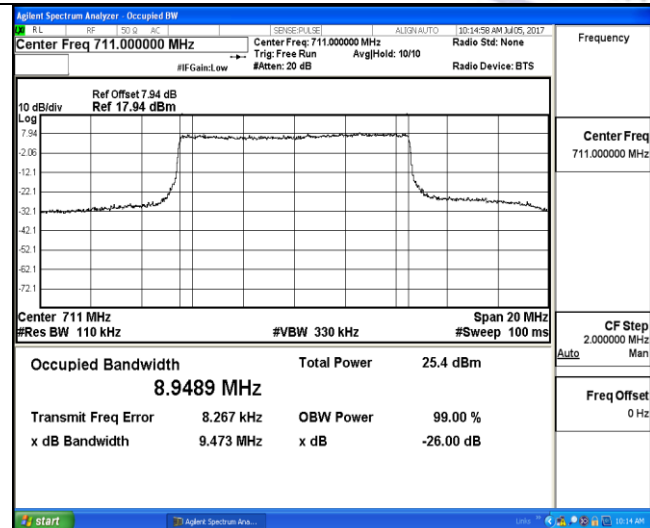

50RB#0

50RB#0

High Channel

3.4. Band Edge compliance

LIMIT

According to Part §27.53(h) specify that the power of any emission outside of the authorized operating frequency ranges must be attenuated below the transmitting power (P) by a factor of at least $43 + 10 \log(P)$ dB.

The specification that emissions shall be attenuated below the transmitter power (P) by at least $43 + 10 \log(P)$ dB, translates in the relevant power range (1 to 0.001 W) to -13 dBm. At 1 W the specified minimum attenuation becomes 43 dB and relative to a 30 dBm (1 W) carrier becomes a limit of -13 dBm. At 0.001 W (0 dBm) the minimum attenuation is 13 dB, which again yields a limit of -13 dBm. In this way a translation of the specification from relative to absolute terms is carried out.

TEST CONFIGURATION

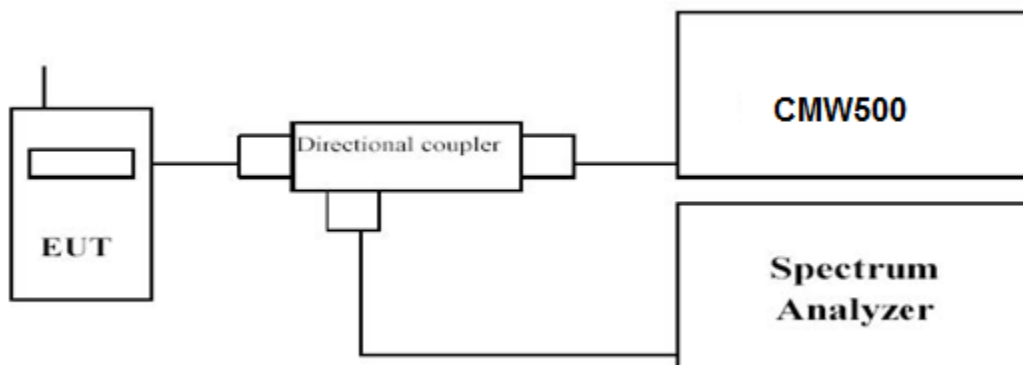

TEST PROCEDURE

1. The transmitter output port was connected to base station.
2. The RF output of EUT was connected to the power meter by RF cable and attenuator, the path loss was compensated to the results for each measurement.
3. Set EUT at maximum power through base station.
4. Select lowest and highest channels for each band and different modulation.
5. Measure Band edge using RMS (Average) detector by spectrum

TEST RESULTS

Remark:

1. We were tested all RB Configuration refer 3GPP TS136 521 for each Channel Bandwidth of LTE FDD Band 12; recorded worst case for each Channel Bandwidth of LTE FDD Band 12.

LTE FDD Band 12-1.4MHz Channel Bandwidth Band Edge Compliance

QPSK

16QAM

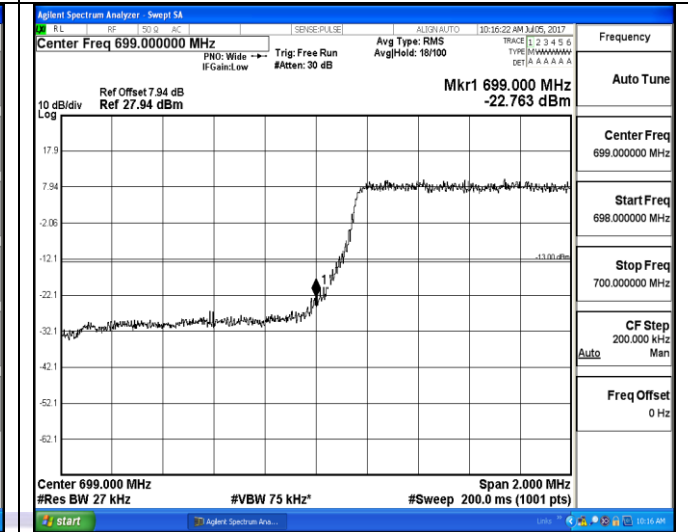
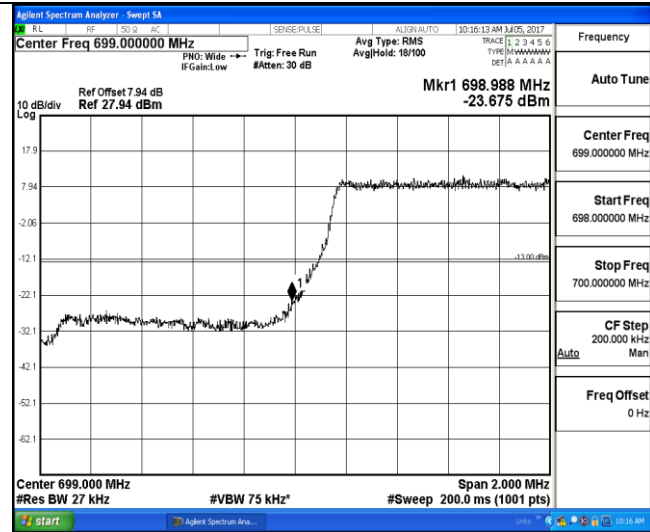

1RB#0

1RB#0

Low Channel

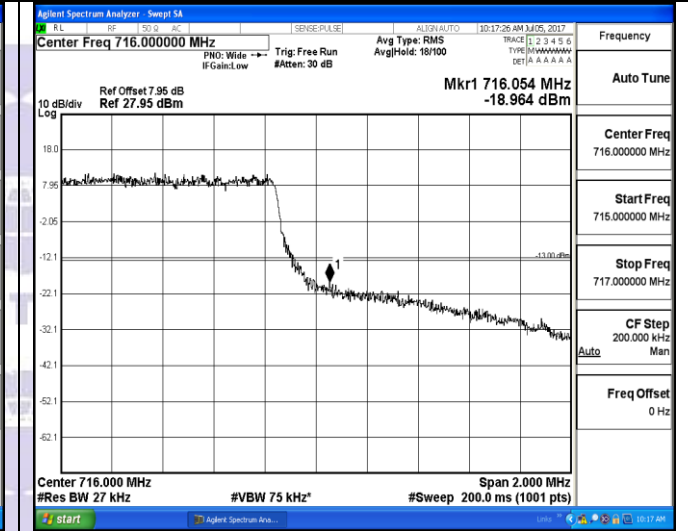
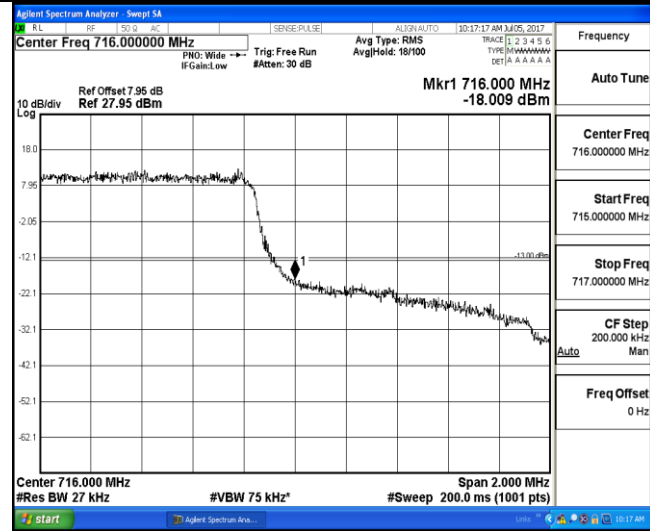

1RB#0

1RB#0

High Channel



LTE FDD Band 12-3MHz Channel Bandwidth Band Edge Compliance

QPSK

16QAM

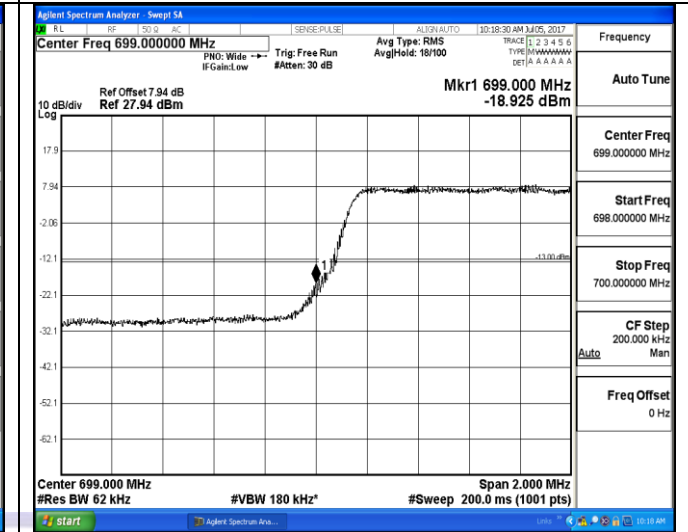
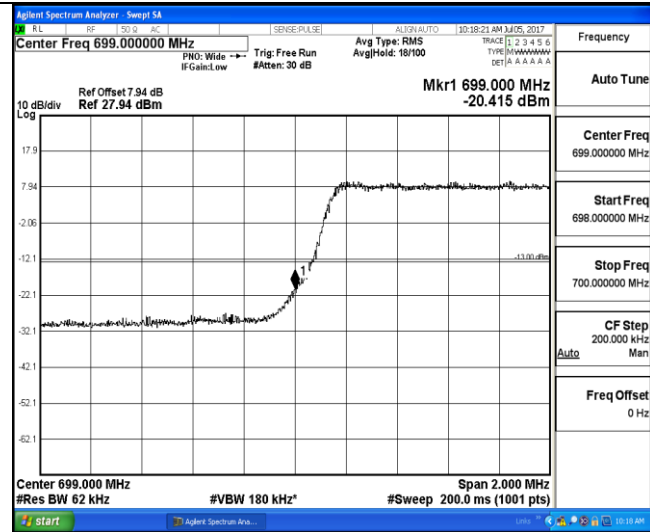

1RB#0

1RB#0

Low Channel

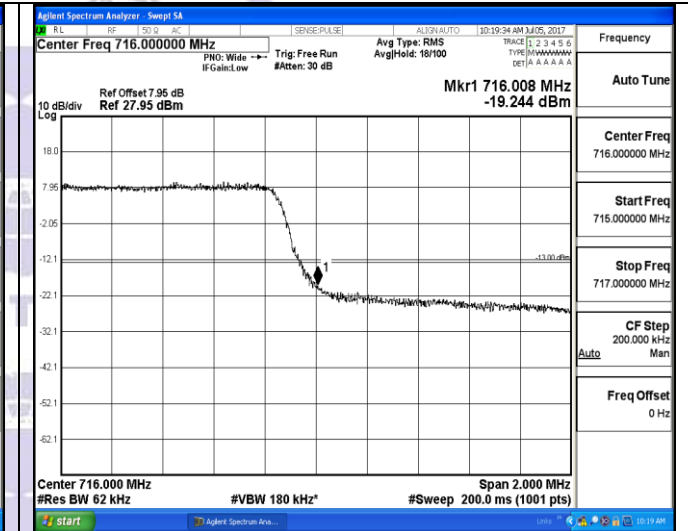
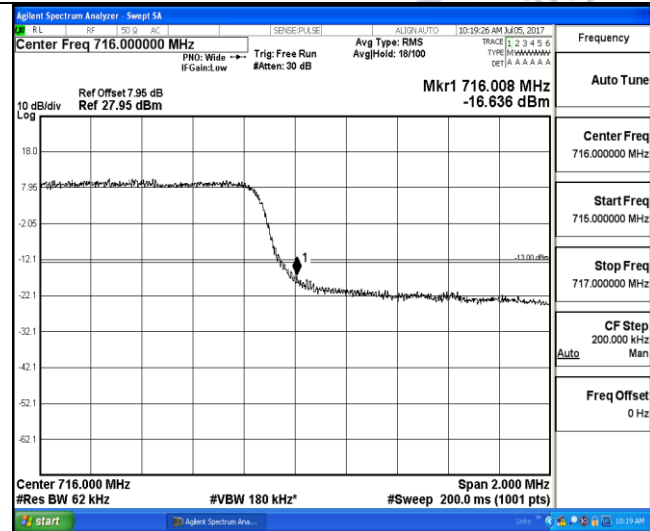

1RB#0

1RB#0

High Channel



LTE FDD Band 12-5MHz Channel Bandwidth Band Edge Compliance

QPSK

16QAM

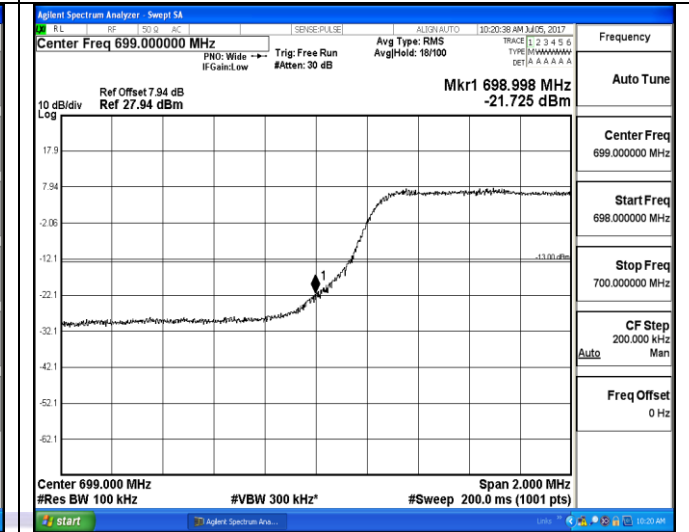
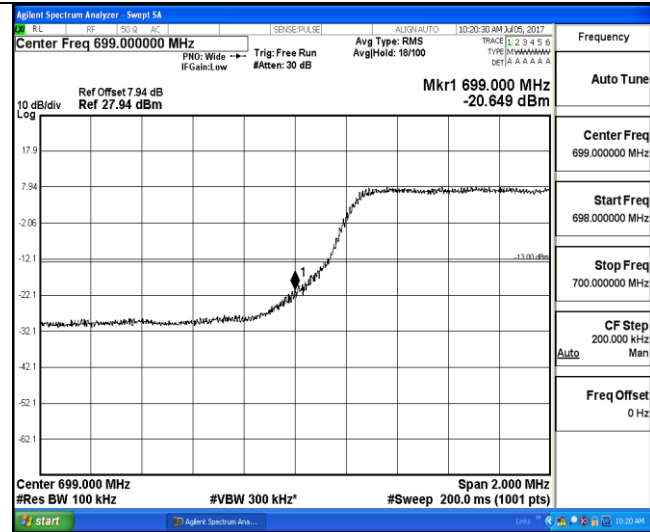

1RB#0

1RB#0

Low Channel

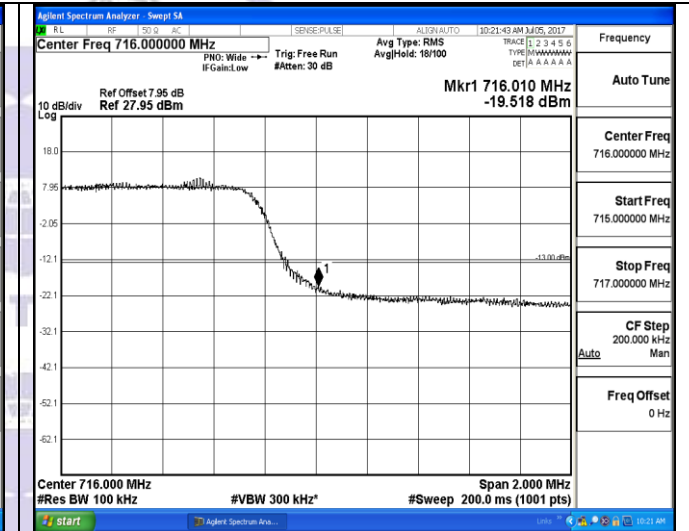
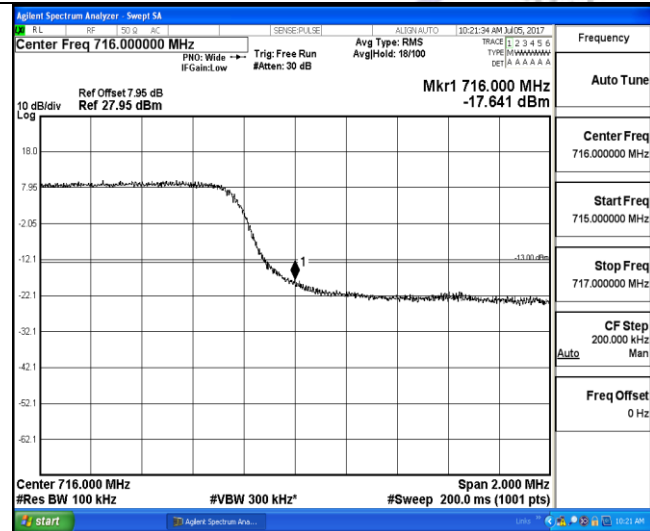

1RB#0

1RB#0

High Channel



LTE FDD Band 12-10MHz Channel Bandwidth Band Edge Compliance

QPSK

16QAM

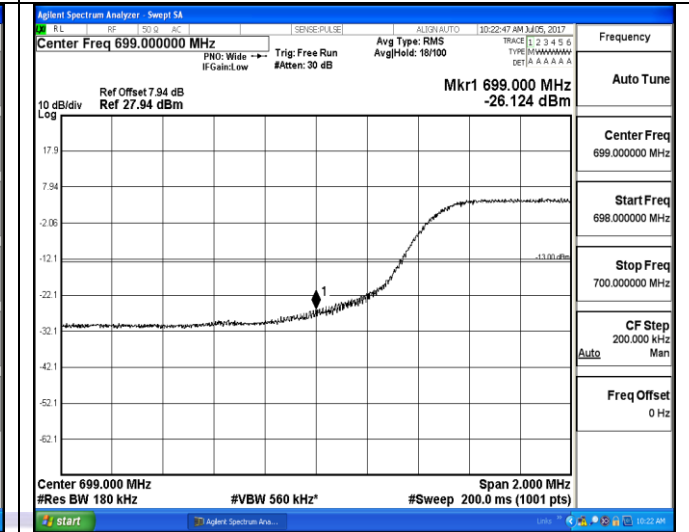
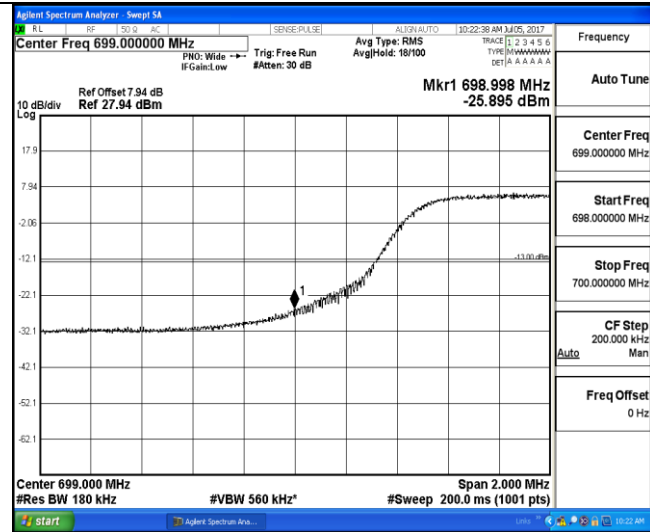

1RB#0

1RB#0

Low Channel

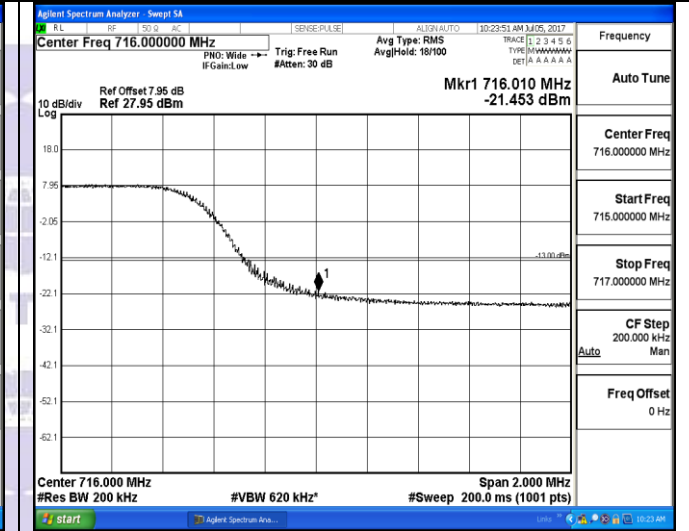
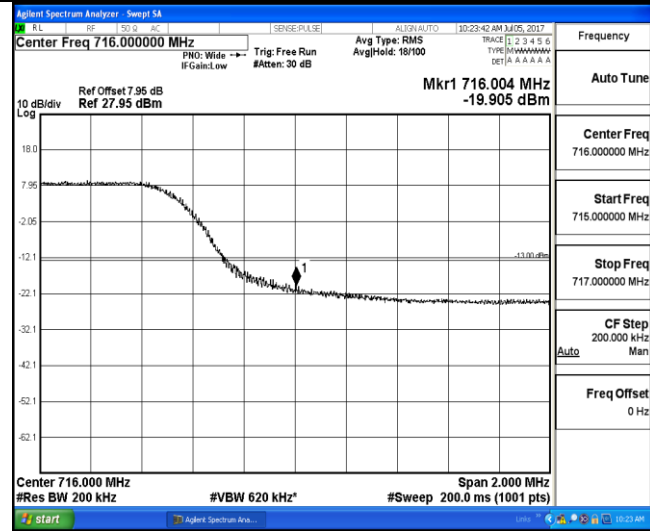

1RB#0

1RB#0

High Channel



3.5. Spurious Emission

LIMIT

According to Part §27.53(h) specify that the power of any emission outside of the authorized operating frequency ranges must be attenuated below the transmitting power (P) by a factor of at least $43 + 10 \log (P)$ dB.

The specification that emissions shall be attenuated below the transmitter power (P) by at least $43 + 10 \log (P)$ dB, translates in the relevant power range (1 to 0.001 W) to -13 dBm. At 1 W the specified minimum attenuation becomes 43 dB and relative to a 30 dBm (1 W) carrier becomes a limit of -13 dBm. At 0.001 W (0 dBm) the minimum attenuation is 13 dB, which again yields a limit of -13 dBm. In this way a translation of the specification from relative to absolute terms is carried out.

TEST CONFIGURATION

Conducted Spurious Measurement:

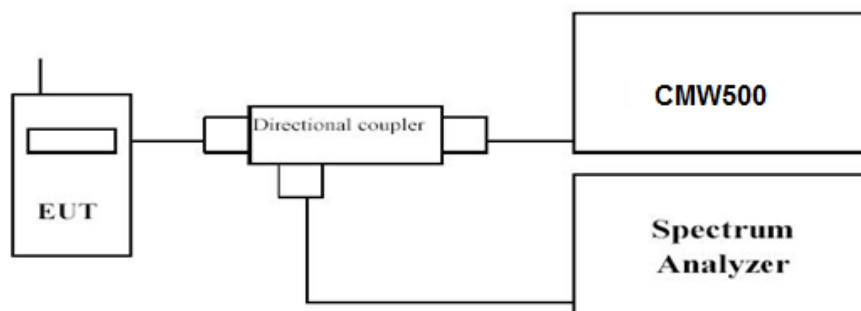

Radiated Spurious Measurement:

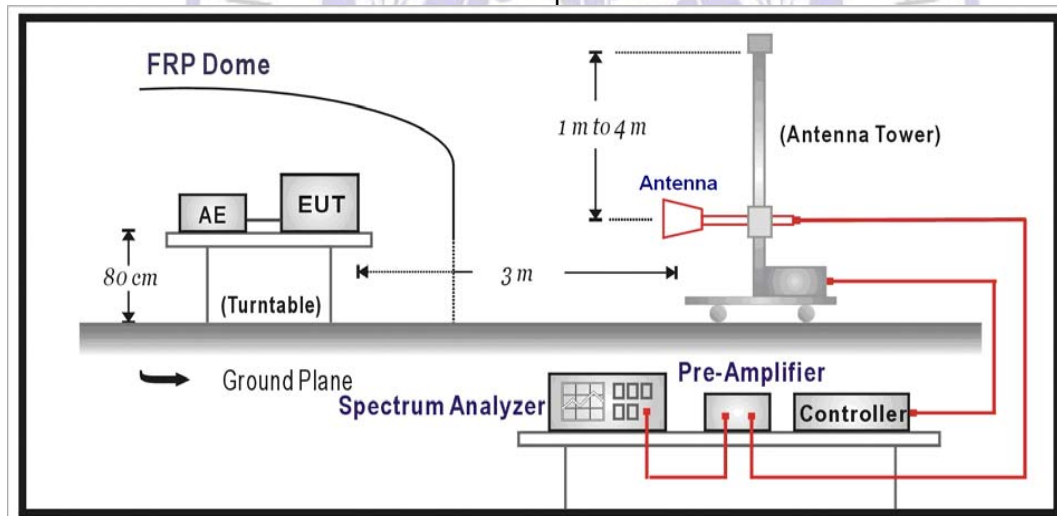

TEST PROCEDURE

The EUT was setup according to EIA/TIA 603D

Conducted Spurious Measurement:

- Place the EUT on a bench and set it in transmitting mode.
- Connect a low loss RF cable from the antenna port to a spectrum analyzer and CMW500 by a Directional Coupler.
- EUT Communicate with CMW500 then selects a channel for testing.
- Add a correction factor to the display of spectrum, and then test.
- The resolution bandwidth of the spectrum analyzer was set sufficient scans were taken to show the out of band Emission if any up to 10th harmonic.

Radiated Spurious Measurement:

- a. The EUT shall be placed at the specified height on a support, and in the position closest to normal use as declared by provider.
- b. The test antenna shall be oriented initially for vertical polarization and shall be chosen to correspond to the frequency of the transmitter
- c. The output of the test antenna shall be connected to the measuring receiver.
- d. The transmitter shall be switched on and the measuring receiver shall be tuned to the frequency of the transmitter under test.
- e. The test antenna shall be raised and lowered through the specified range of height until a maximum signal level is detected by the measuring receiver.
- f. The transmitter shall then be rotated through 360° in the horizontal plane, until the maximum signal level is detected by the measuring receiver.
- g. The test antenna shall be raised and lowered again through the specified range of height until a maximum signal level is detected by the measuring receiver.
- h. The maximum signal level detected by the measuring receiver shall be noted.
- i. The transmitter shall be replaced by a substitution antenna.
- j. The substitution antenna shall be orientated for vertical polarization and the length of the substitution antenna shall be adjusted to correspond to the frequency of the transmitter.
- k. The substitution antenna shall be connected to a calibrated signal generator.
- l. If necessary, the input attenuator setting of the measuring receiver shall be adjusted in order to increase the sensitivity of the measuring receiver.
- m. The test antenna shall be raised and lowered through the specified range of height to ensure that the maximum signal is received.
- n. The input signal to the substitution antenna shall be adjusted to the level that produces a level detected by the measuring receiver, that is equal to the level noted while the transmitter radiated power was measured, corrected for the change of input attenuator setting of the measuring receiver.
- o. The measurement shall be repeated with the test antenna and the substitution antenna orientated for horizontal polarization.
- p. The measure of the effective radiated power is the larger of the two levels recorded at the input to the substitution antenna, corrected for gain of the substitution antenna if necessary.
- q. The resolution bandwidth of the spectrum analyzer was set at 100 kHz for Part 22 and 1MHz for Part 24. The frequency range was checked up to 10th harmonic.
- r. Test site anechoic chamber refer to ANSI C63.

TEST RESULTS**Remark:**

1. We were tested all RB Configuration refer 3GPP TS136 521 for each Channel Bandwidth of LTE FDD Band 12; recorded worst case for each Channel Bandwidth of LTE FDD Band 12.