

LTE FDD Band 4-20MHz Channel Bandwidth Band Edge Compliance

QPSK

16QAM

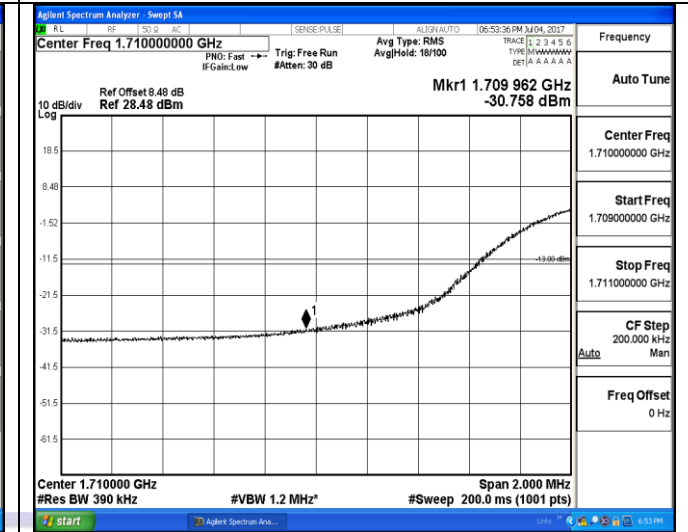
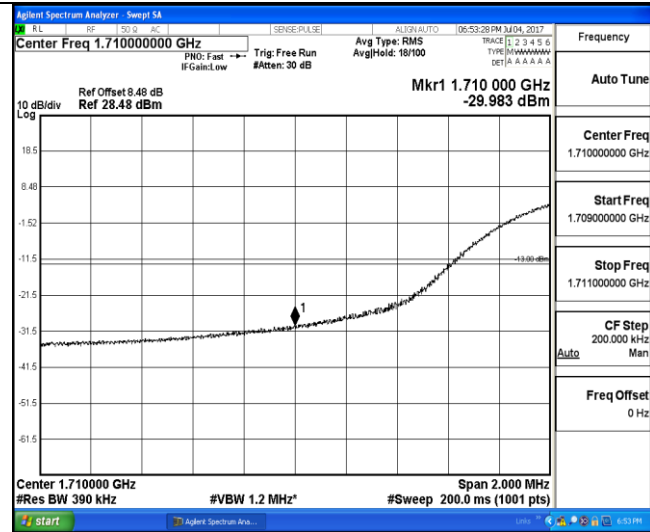

1RB#0

1RB#0

Low Channel

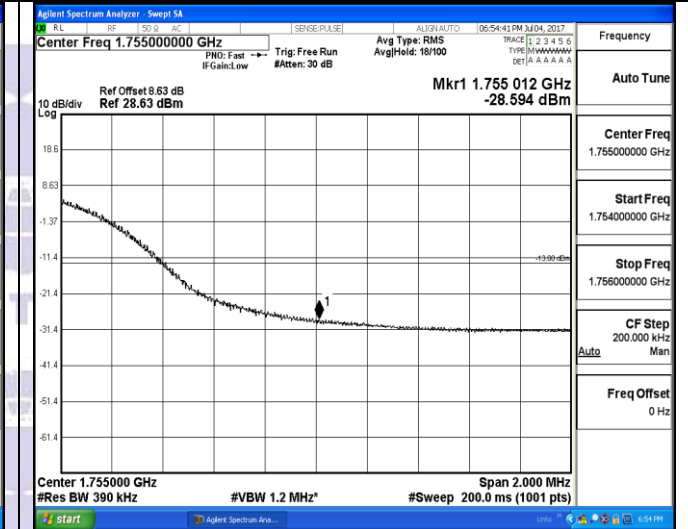
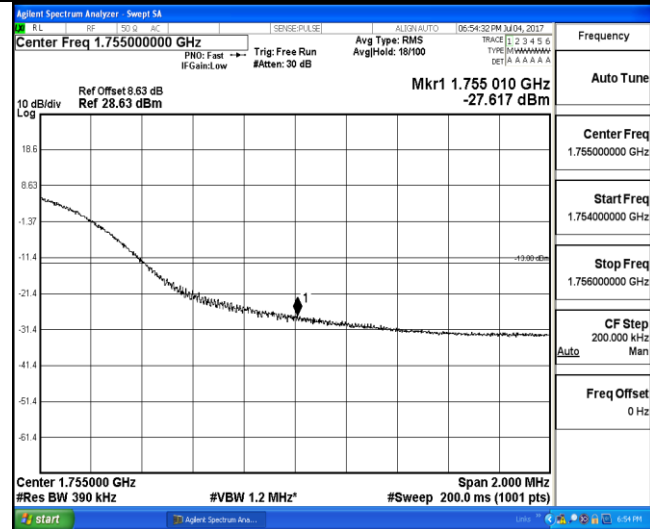

1RB#0

1RB#0

High Channel



### 3.5. Spurious Emission

#### LIMIT

According to §27.53 (h): For operations in the 1710–1755 MHz and 2110–2155 MHz bands, the power of any emission outside a licensee's frequency block shall be attenuated below the transmitter power (P) by at least  $43 + 10 \log_{10}(P)$  dB.

#### TEST CONFIGURATION

Conducted Spurious Measurement:

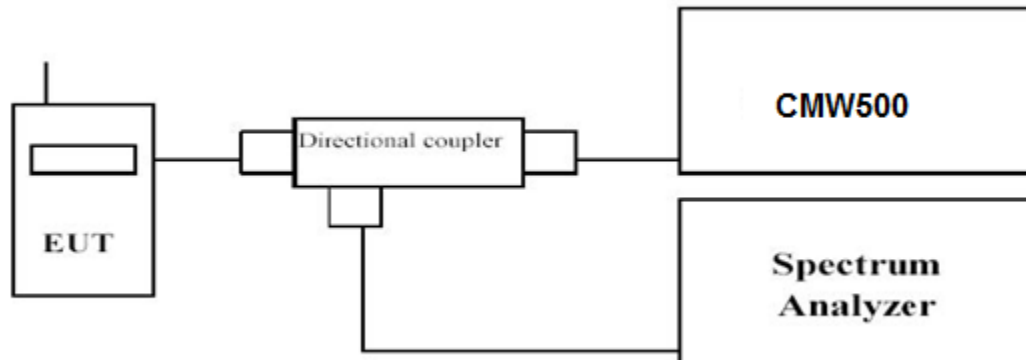

Radiated Spurious Measurement:

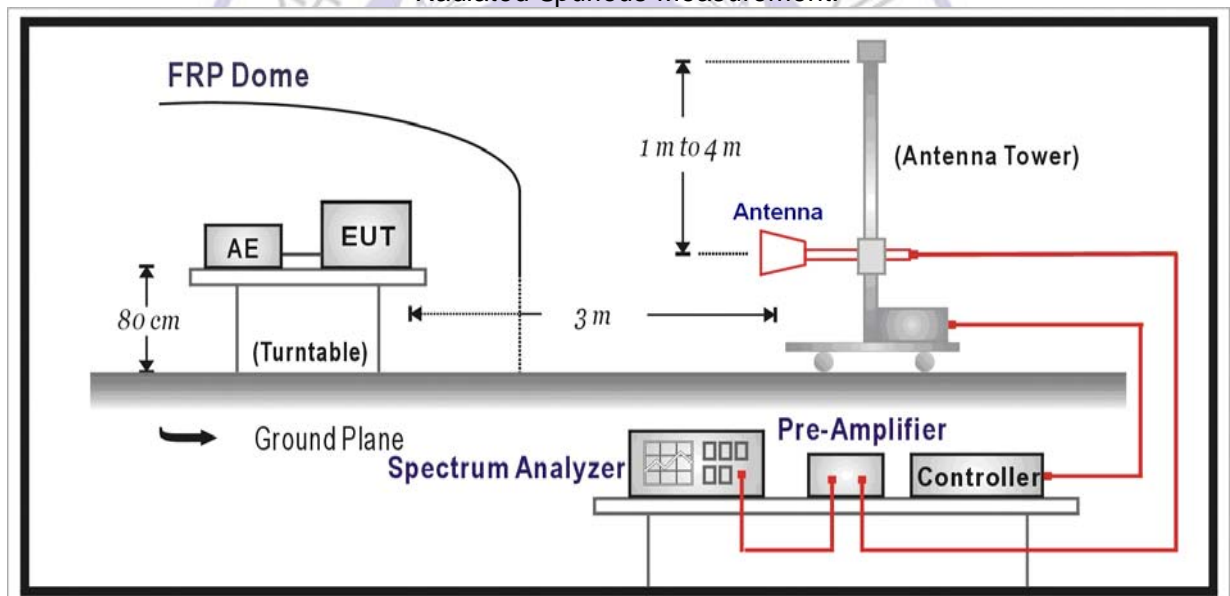

#### TEST PROCEDURE

The EUT was setup according to EIA/TIA 603D

##### **Conducted Spurious Measurement:**

- Place the EUT on a bench and set it in transmitting mode.
- Connect a low loss RF cable from the antenna port to a spectrum analyzer and CMW500 by a Directional Couple.
- EUT Communicate with CMW500 then selects a channel for testing.
- Add a correction factor to the display of spectrum, and then test.
- The resolution bandwidth of the spectrum analyzer was set sufficient scans were taken to show the out of band Emission if any up to 10th harmonic.

**Radiated Spurious Measurement:**

- a. The EUT shall be placed at the specified height on a support, and in the position closest to normal use as declared by provider.
- b. The test antenna shall be oriented initially for vertical polarization and shall be chosen to correspond to the frequency of the transmitter
- c. The output of the test antenna shall be connected to the measuring receiver.
- d. The transmitter shall be switched on and the measuring receiver shall be tuned to the frequency of the transmitter under test.
- e. The test antenna shall be raised and lowered through the specified range of height until a maximum signal level is detected by the measuring receiver.
- f. The transmitter shall then be rotated through 360° in the horizontal plane, until the maximum signal level is detected by the measuring receiver.
- g. The test antenna shall be raised and lowered again through the specified range of height until a maximum signal level is detected by the measuring receiver.
- h. The maximum signal level detected by the measuring receiver shall be noted.
- i. The transmitter shall be replaced by a substitution antenna.
- j. The substitution antenna shall be orientated for vertical polarization and the length of the substitution antenna shall be adjusted to correspond to the frequency of the transmitter.
- k. The substitution antenna shall be connected to a calibrated signal generator.
- l. If necessary, the input attenuator setting of the measuring receiver shall be adjusted in order to increase the sensitivity of the measuring receiver.
- m. The test antenna shall be raised and lowered through the specified range of height to ensure that the maximum signal is received.
- n. The input signal to the substitution antenna shall be adjusted to the level that produces a level detected by the measuring receiver, that is equal to the level noted while the transmitter radiated power was measured, corrected for the change of input attenuator setting of the measuring receiver.
- o. The measurement shall be repeated with the test antenna and the substitution antenna orientated for horizontal polarization.
- p. The measure of the effective radiated power is the larger of the two levels recorded at the input to the substitution antenna, corrected for gain of the substitution antenna if necessary.
- q. The resolution bandwidth of the spectrum analyzer was set at 100 kHz for Part 22 and 1MHz for Part 24. The frequency range was checked up to 10th harmonic.
- r. Test site anechoic chamber refer to ANSI C63.

**TEST RESULTS****Remark:**

1. We were tested all RB Configuration refer 3GPP TS136 521 for each Channel Bandwidth of LTE FDD Band 4; recorded worst case for each Channel Bandwidth of LTE FDD Band 4.

Conducted Measurement:

LTE FDD Band 4-1.4MHz Channel Bandwidth  
Low Channel

QPSK

16QAM

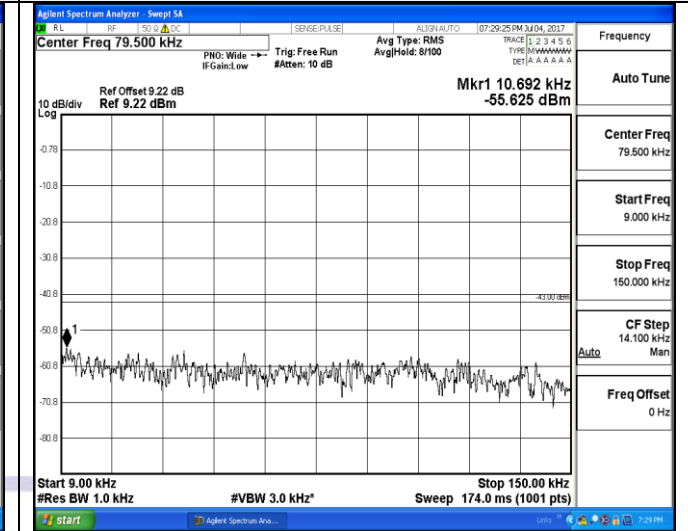
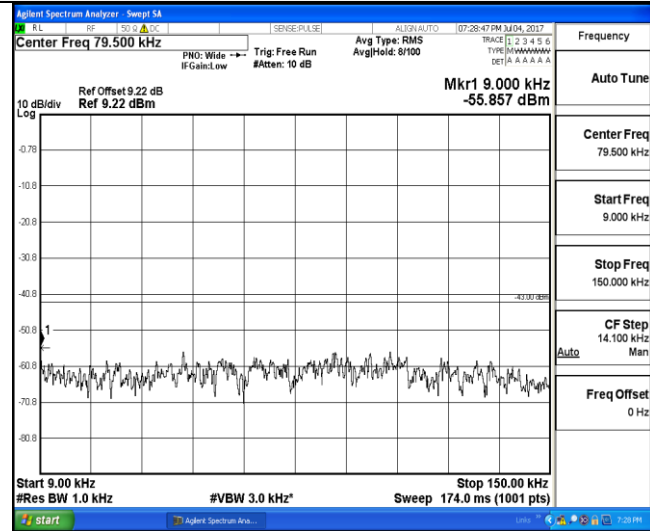

9KHz~150KHz

9KHz~150KHz

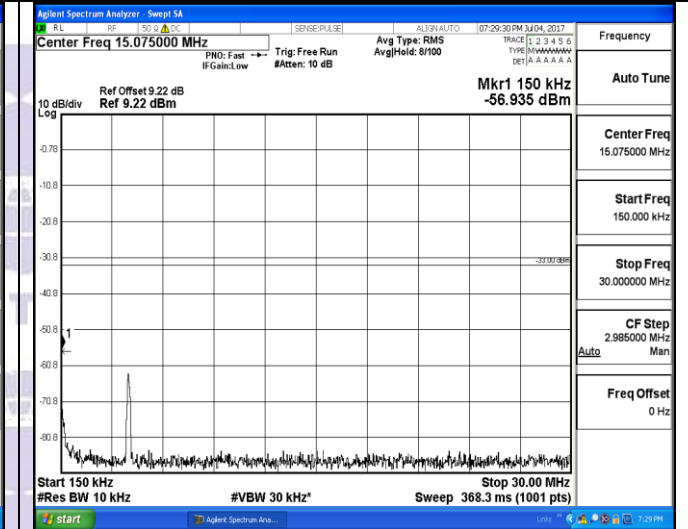
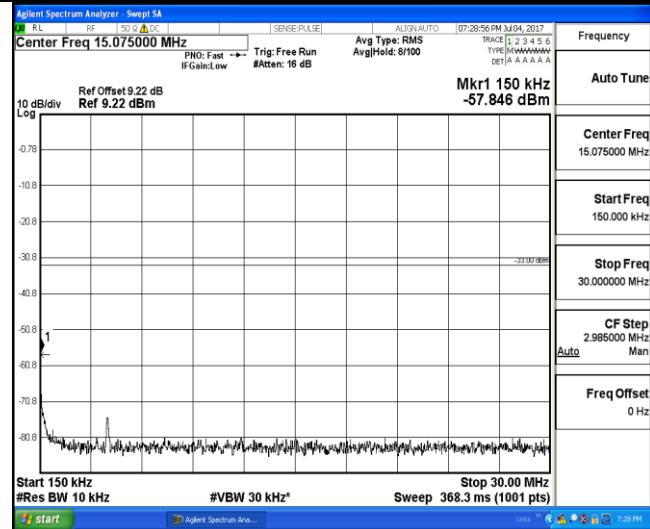

150KHz~30MHz

150KHz~30MHz

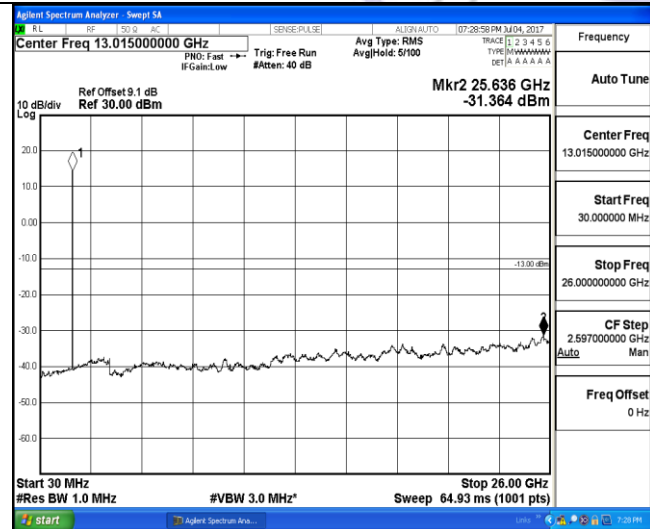

30MHz~26.5GHz

30MHz~26.5GHz

1RB#0

1RB#0

LTE FDD Band 4-1.4MHz Channel Bandwidth  
Middle Channel

QPSK

16QAM

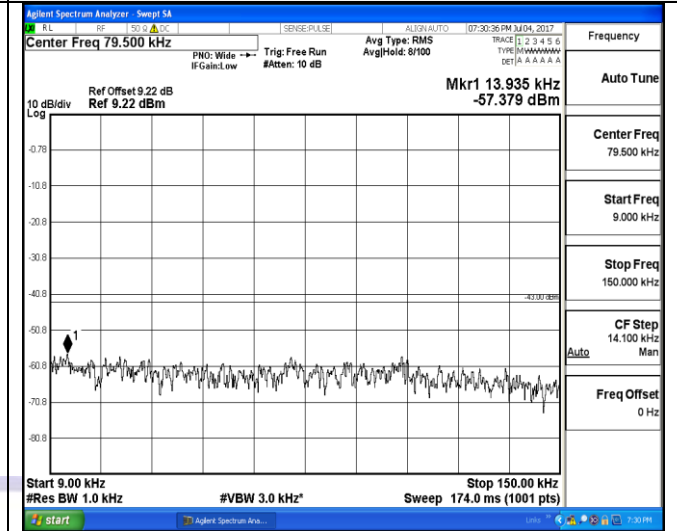
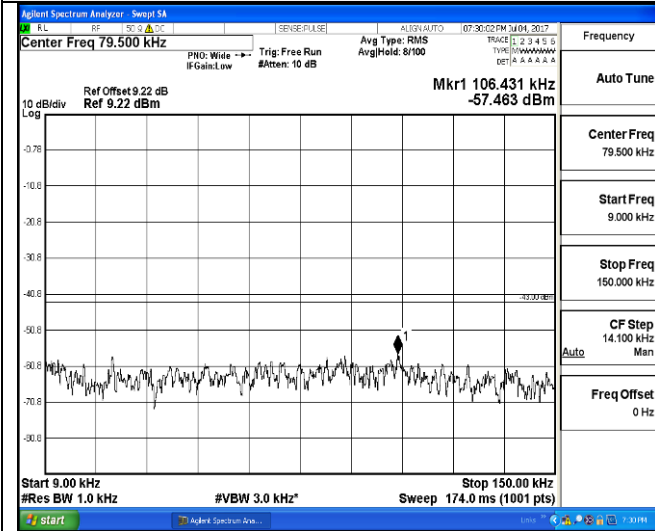

9KHz~150KHz

9KHz~150KHz

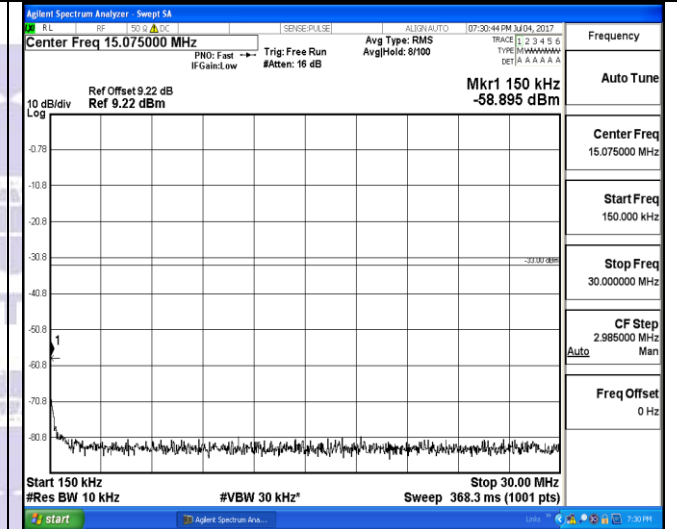
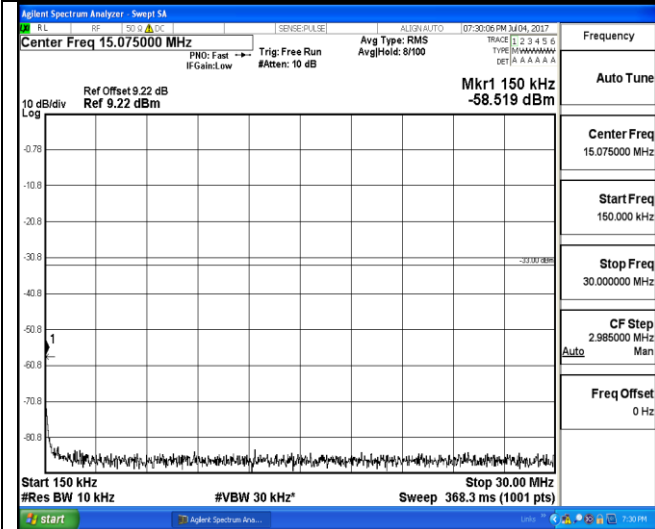

150KHz~30MHz

150KHz~30MHz



30MHz~26.5GHz

30MHz~26.5GHz

1RB#0

1RB#0

LTE FDD Band 4-1.4MHz Channel Bandwidth  
High Channel

QPSK

16QAM

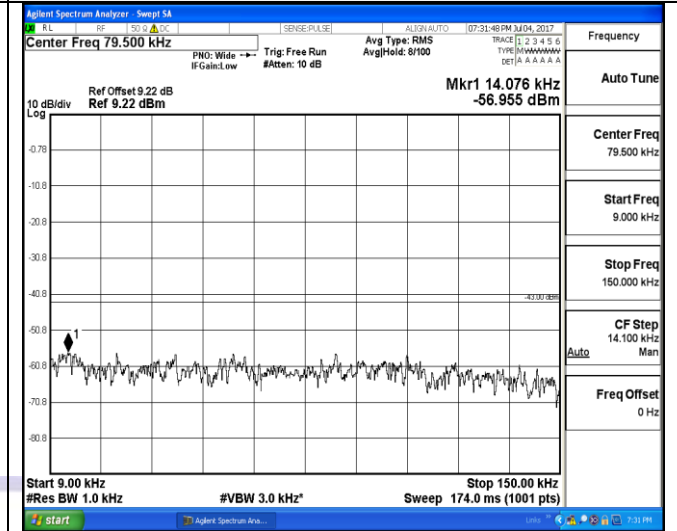
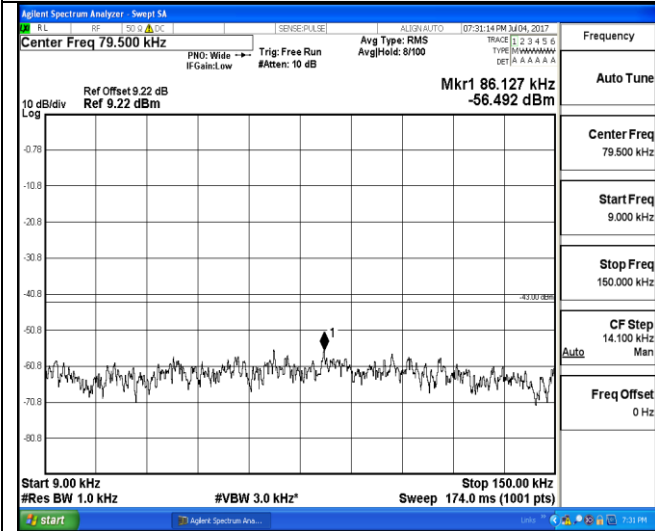

9KHz~150KHz

9KHz~150KHz

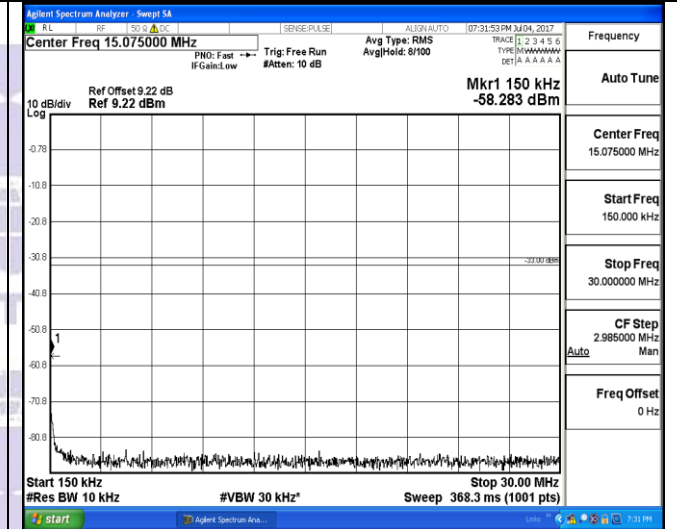
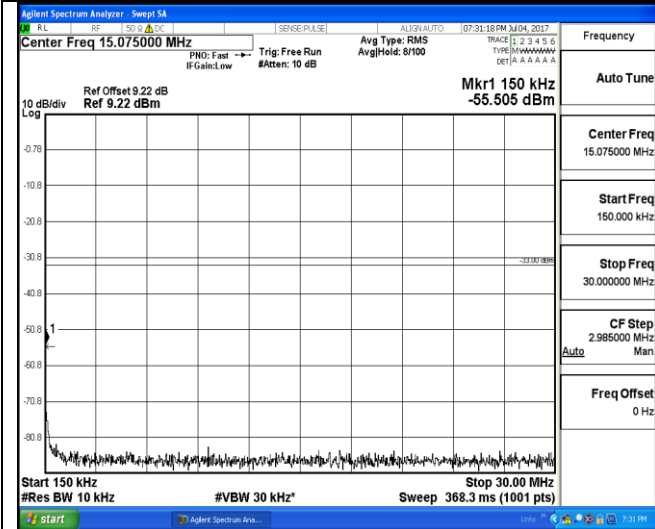

150KHz~30MHz

150KHz~30MHz



30MHz~26.5GHz

30MHz~26.5GHz

1RB#0

1RB#0



LTE FDD Band 4-3MHz Channel Bandwidth  
Low Channel

QPSK

16QAM

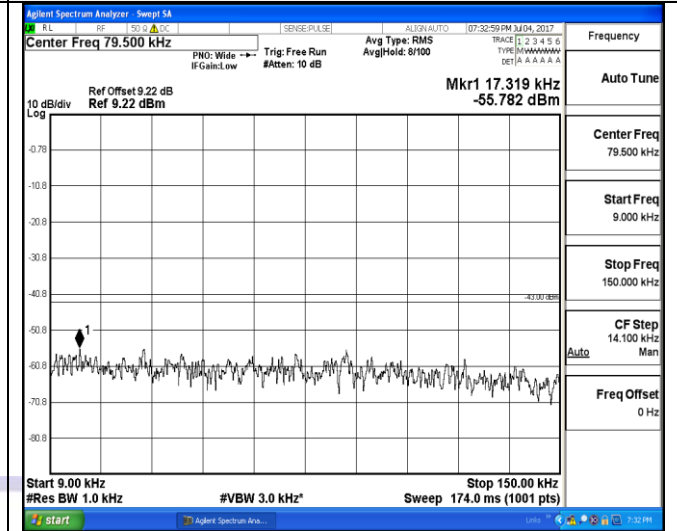
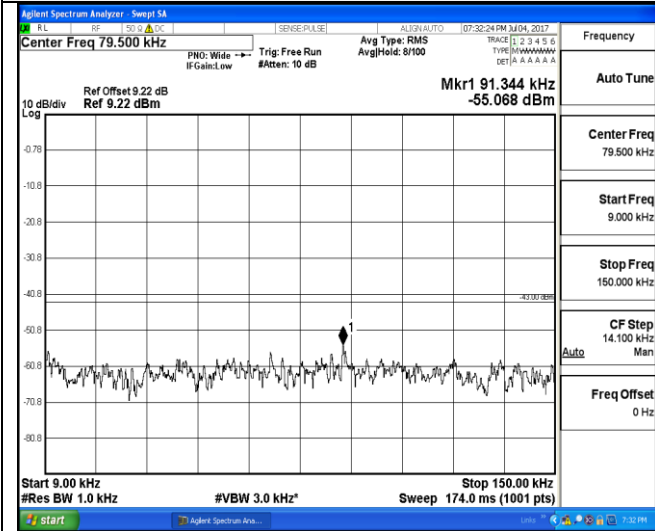

9KHz~150KHz

9KHz~150KHz

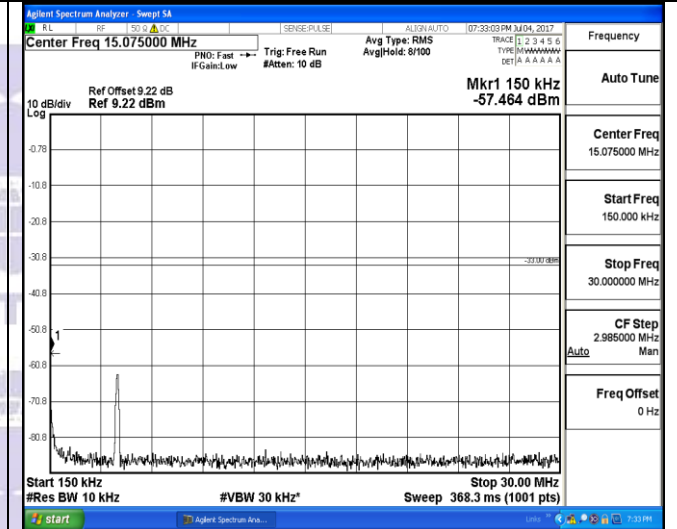
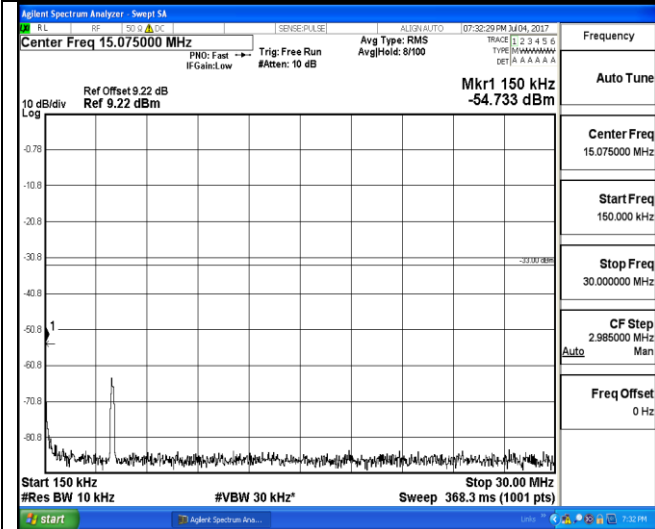

150KHz~30MHz

150KHz~30MHz

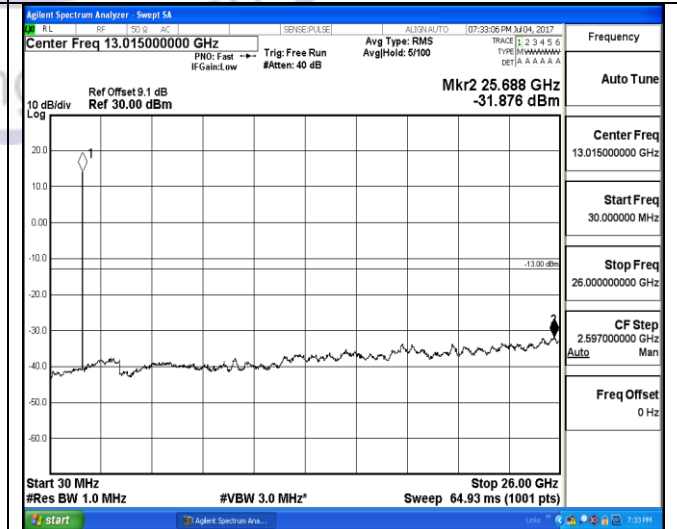

30MHz~26.5GHz  
1RB#0

30MHz~26.5GHz  
1RB#0

LTE FDD Band 4-3MHz Channel Bandwidth  
Middle Channel

QPSK

16QAM

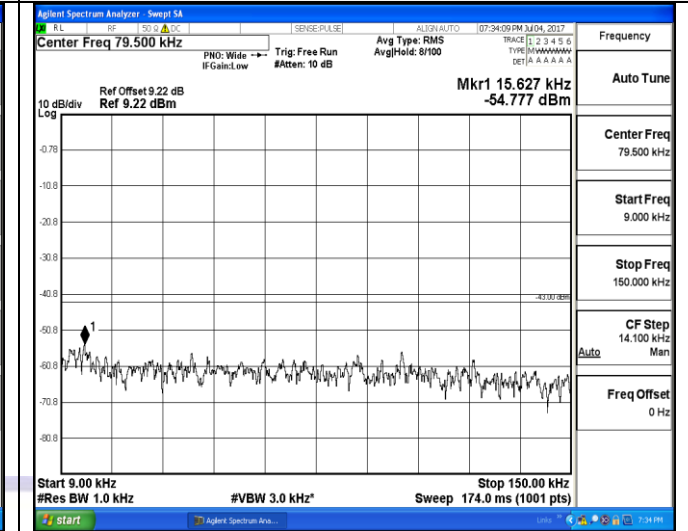
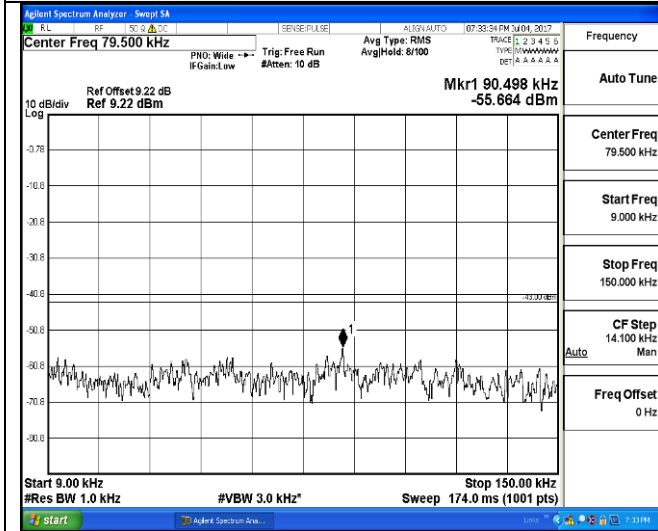

9KHz~150KHz

9KHz~150KHz

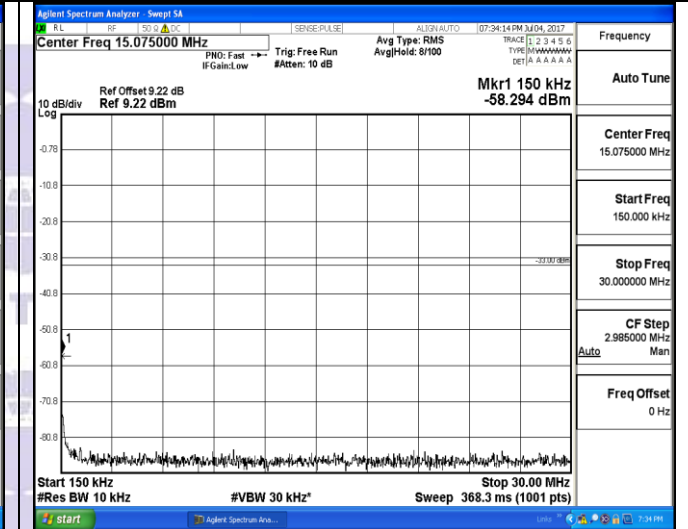
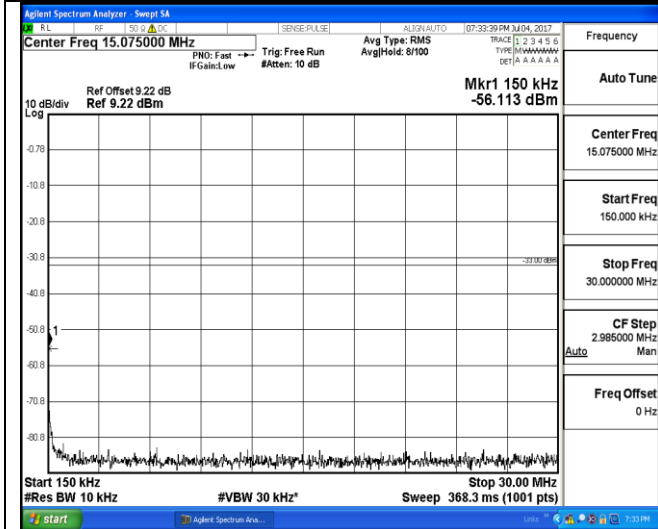

150KHz~30MHz

150KHz~30MHz



30MHz~26.5GHz

30MHz~26.5GHz

1RB#0

1RB#0



LTE FDD Band 4-3MHz Channel Bandwidth  
High Channel

QPSK

16QAM

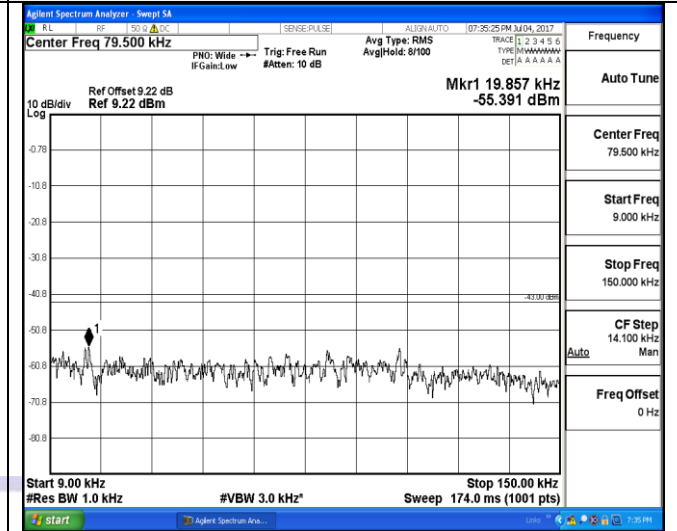
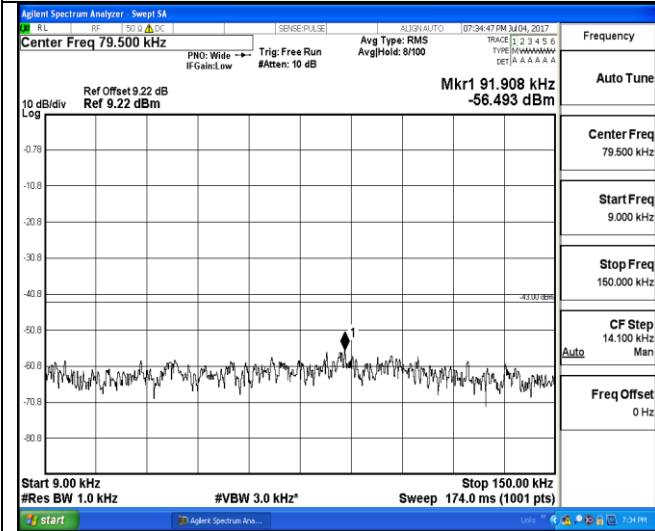

9KHz~150KHz

9KHz~150KHz

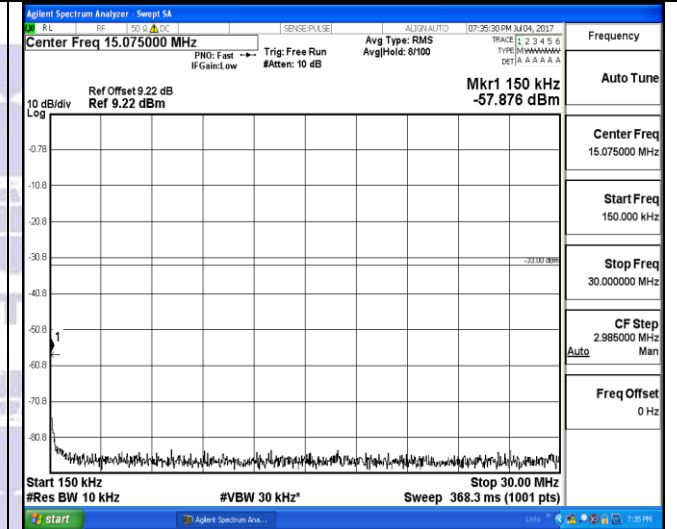
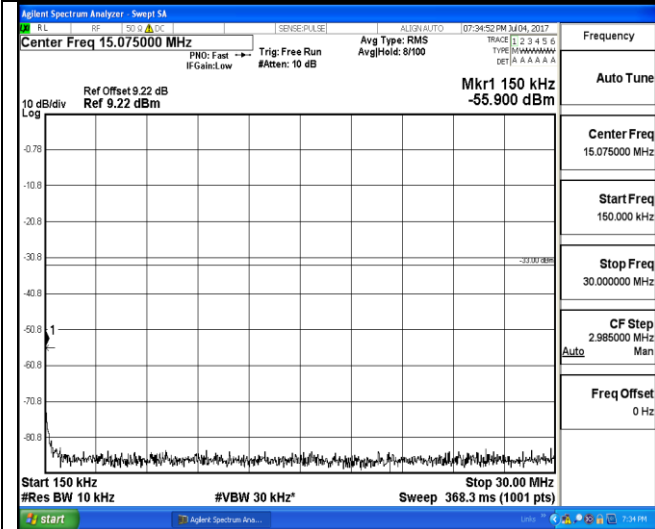

150KHz~30MHz

150KHz~30MHz

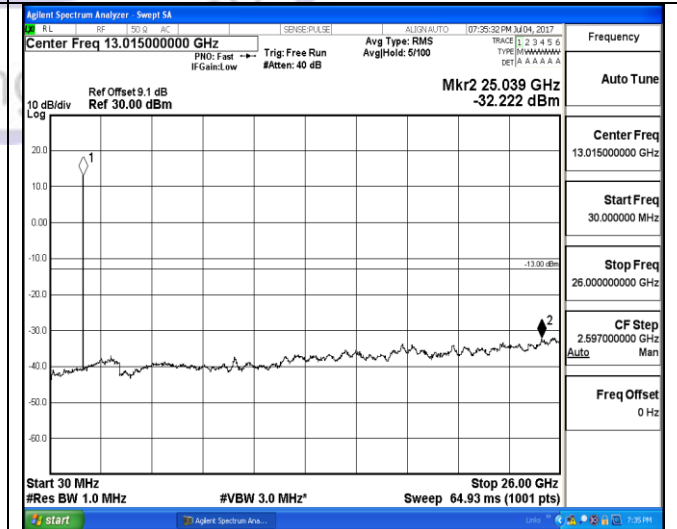

30MHz~26.5GHz  
1RB#0

30MHz~26.5GHz  
1RB#0

LTE FDD Band 4-5MHz Channel Bandwidth  
Low Channel

QPSK

16QAM

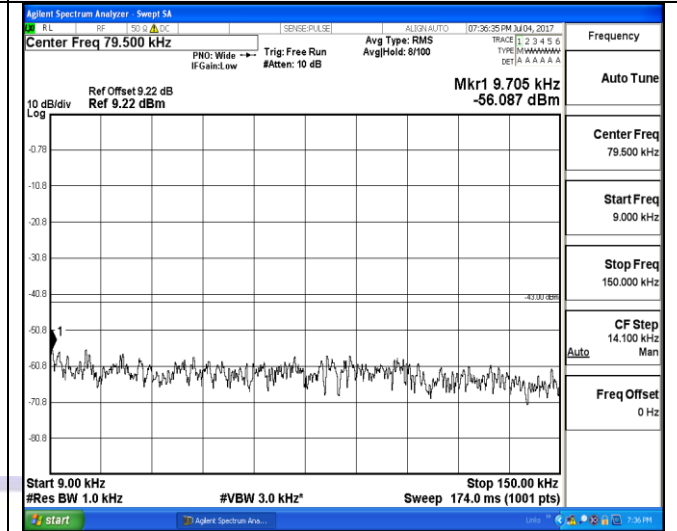
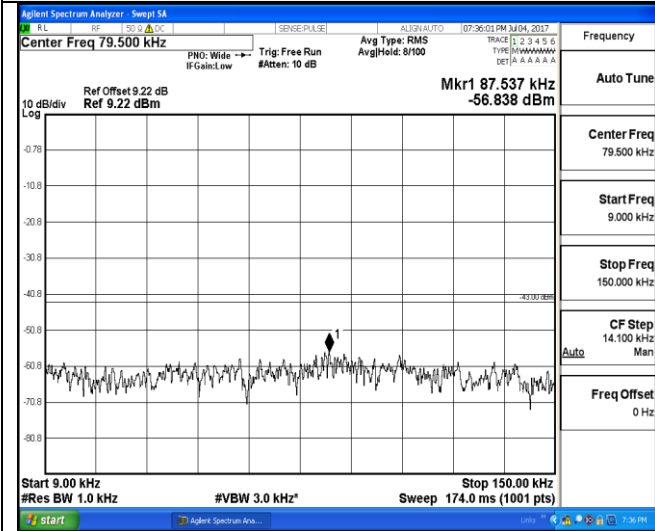

9KHz~150KHz

9KHz~150KHz

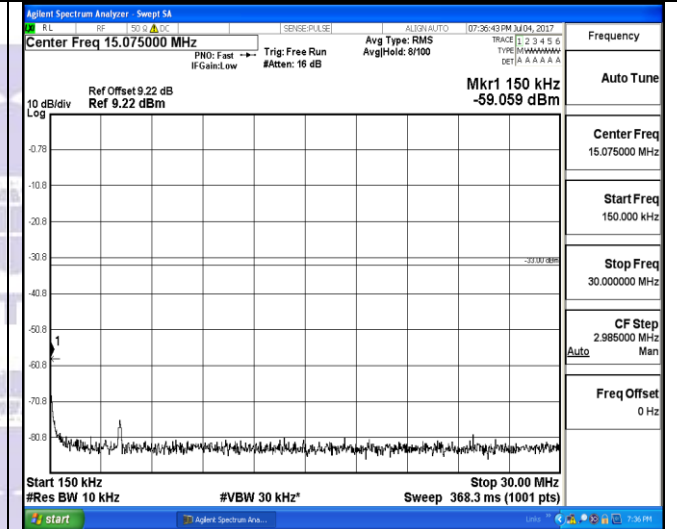
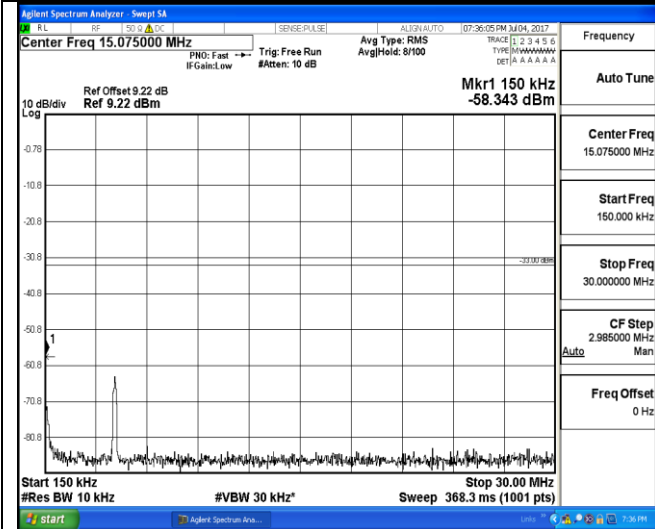

150KHz~30MHz

150KHz~30MHz



30MHz~26.5GHz

30MHz~26.5GHz

1RB#0

1RB#0

LTE FDD Band 4-5MHz Channel Bandwidth  
Middle Channel

QPSK

16QAM

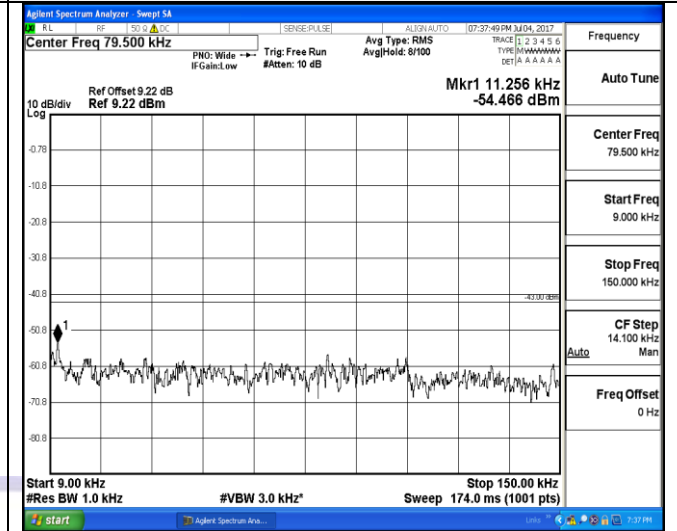
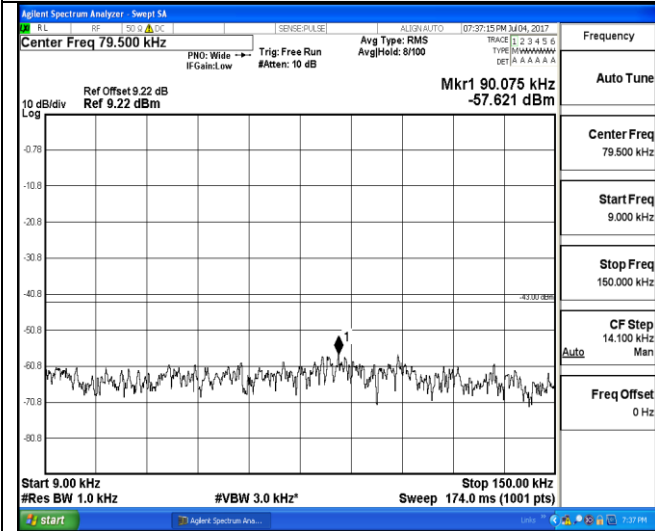

9KHz~150KHz

9KHz~150KHz

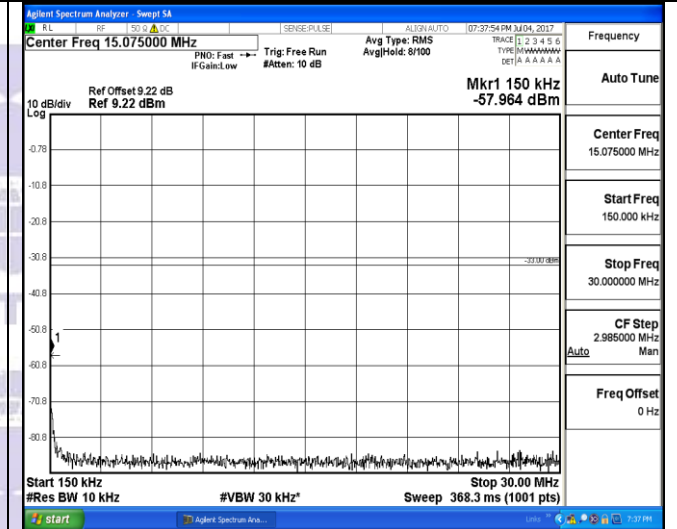
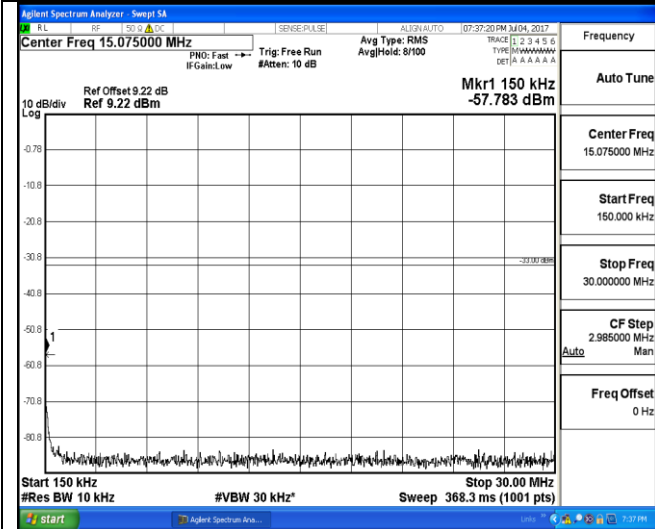

150KHz~30MHz

150KHz~30MHz

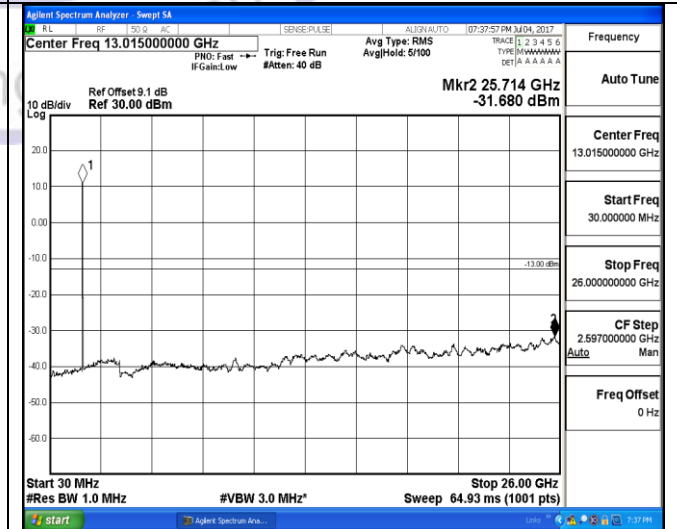

30MHz~26.5GHz

30MHz~26.5GHz

1RB#0

1RB#0

LTE FDD Band 4-5MHz Channel Bandwidth  
High Channel

QPSK

16QAM

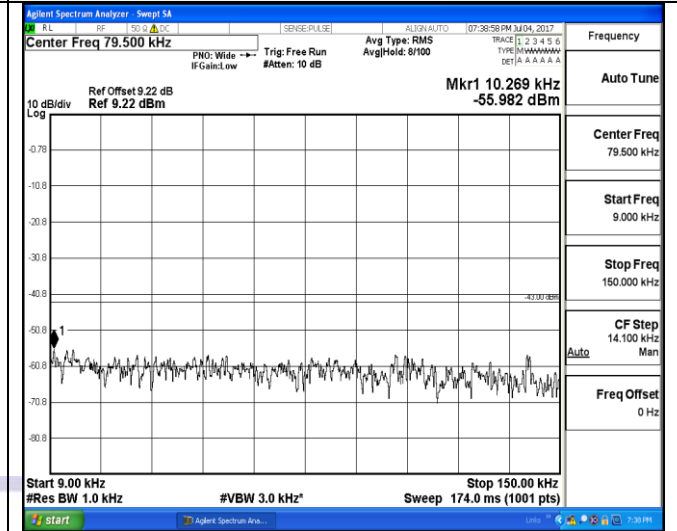
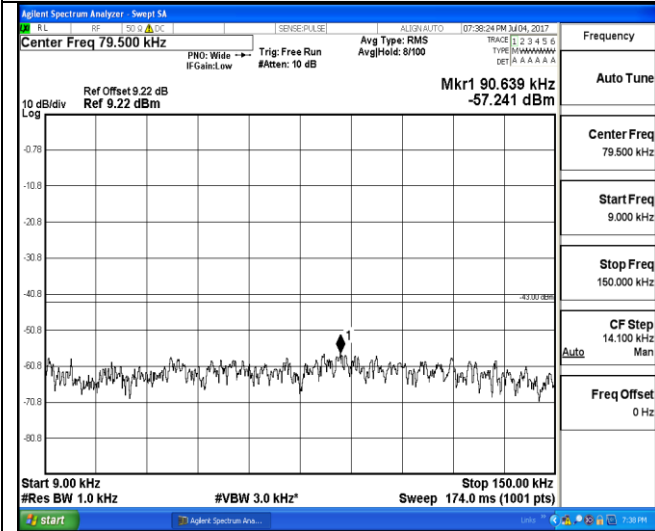

9KHz~150KHz

9KHz~150KHz

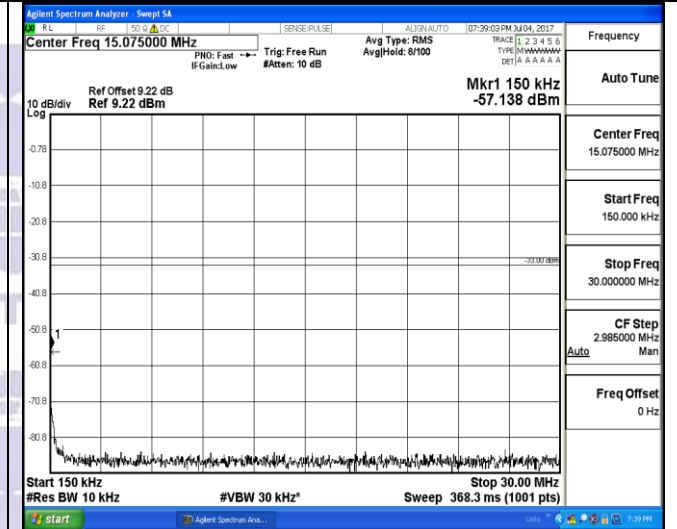
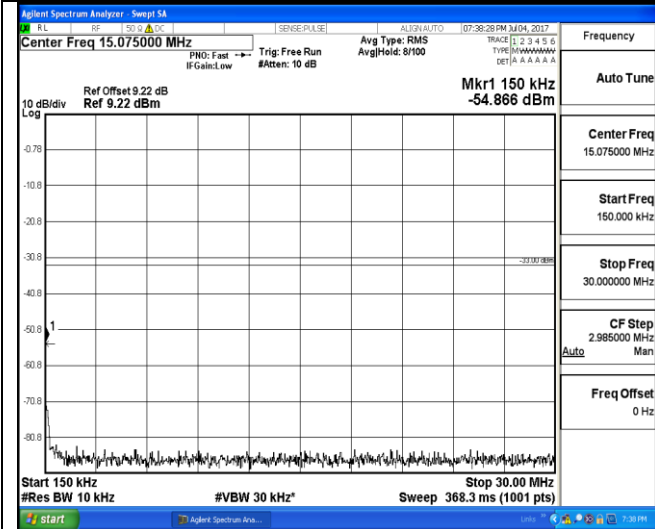

150KHz~30MHz

150KHz~30MHz

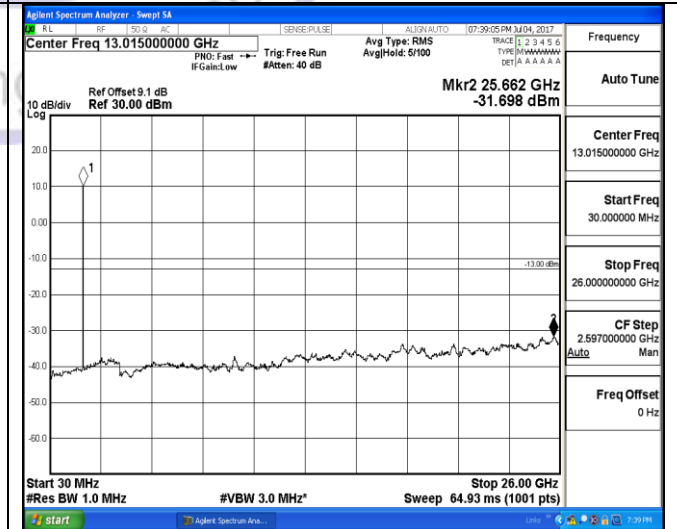

30MHz~26.5GHz

30MHz~26.5GHz

1RB#0

1RB#0

LTE FDD Band 4-10MHz Channel Bandwidth  
Low Channel

QPSK

16QAM

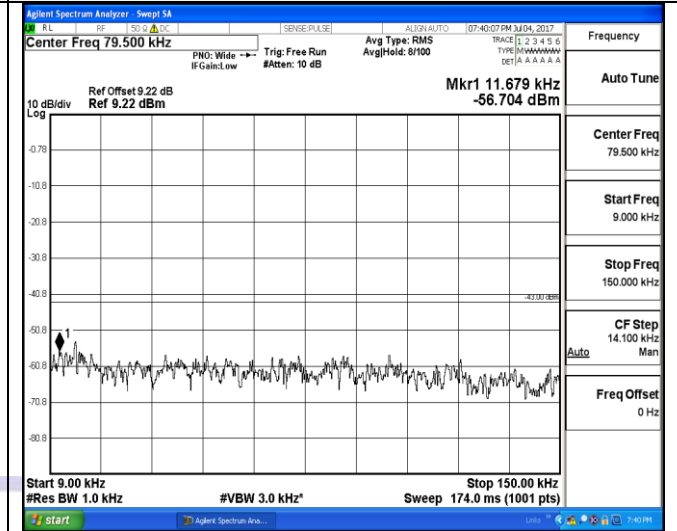
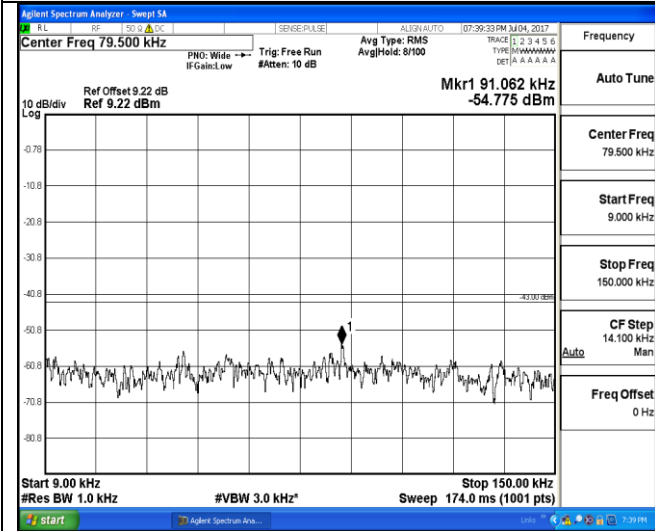

9KHz~150KHz

9KHz~150KHz

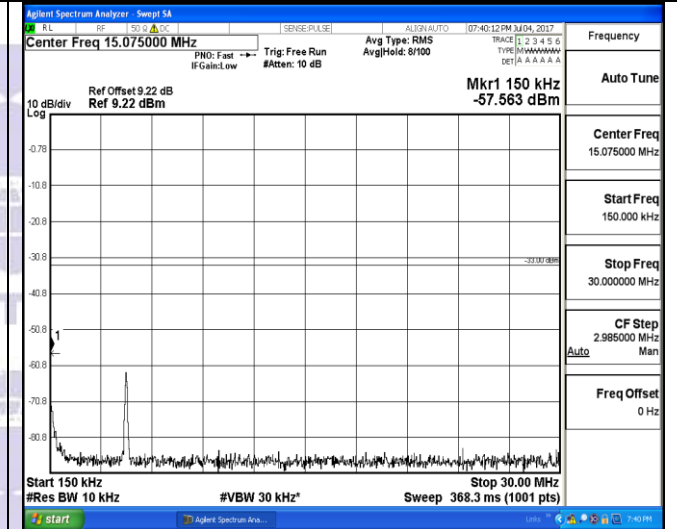
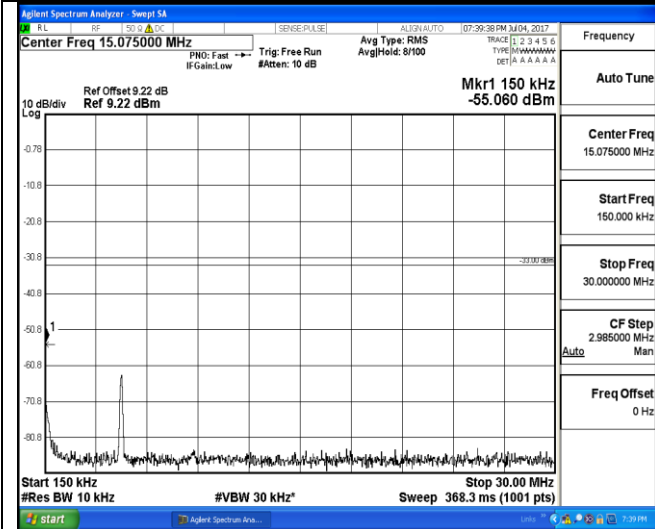

150KHz~30MHz

150KHz~30MHz

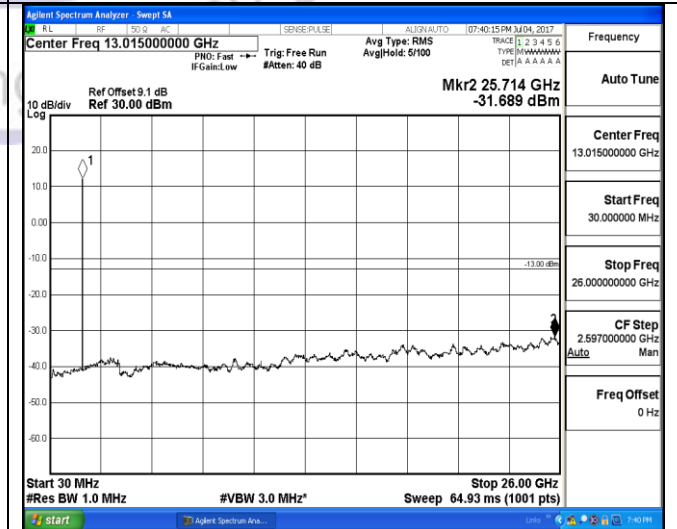

30MHz~26.5GHz  
1RB#0

30MHz~26.5GHz  
1RB#0

LTE FDD Band 4-10MHz Channel Bandwidth  
Middle Channel

QPSK

16QAM

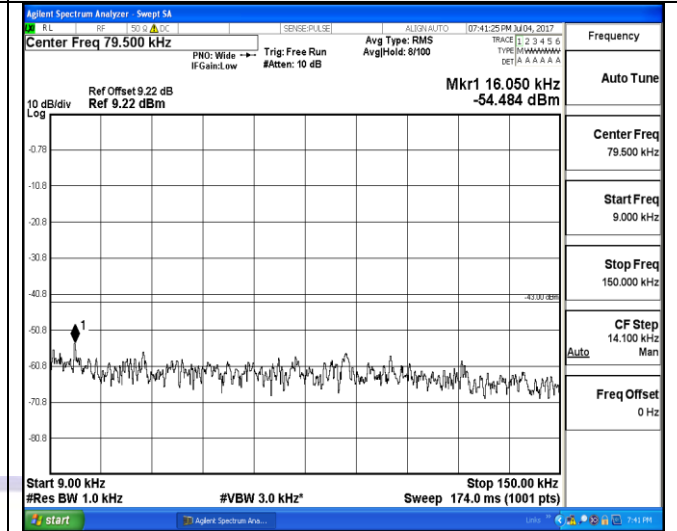
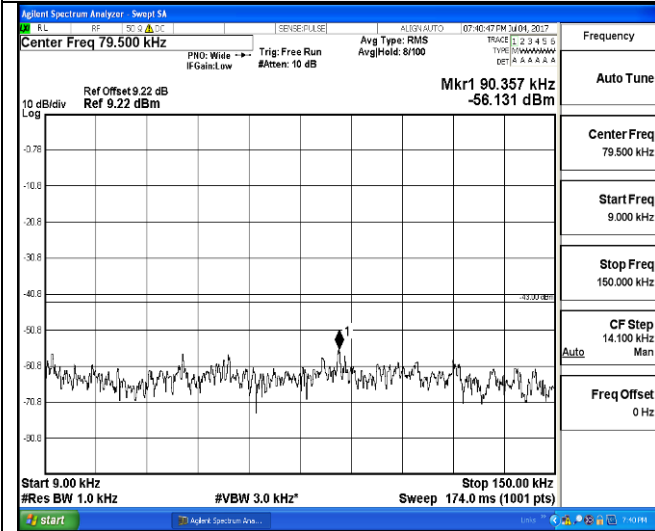

9KHz~150KHz

9KHz~150KHz

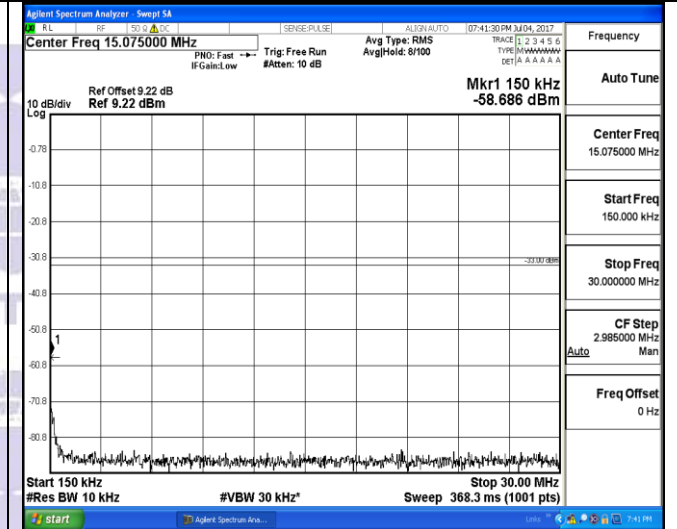
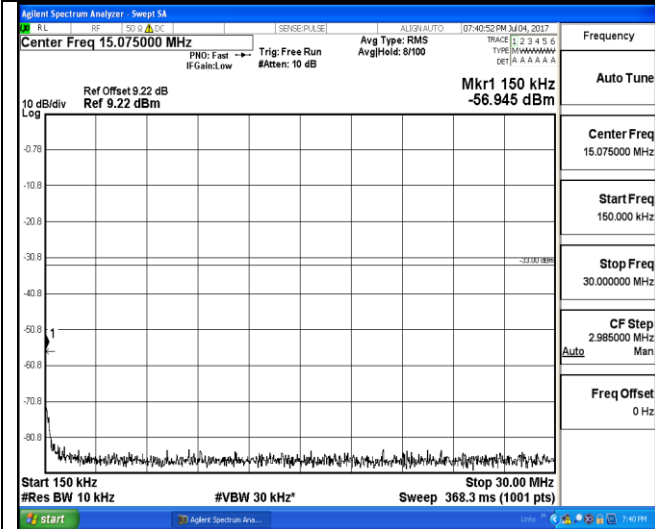

150KHz~30MHz

150KHz~30MHz

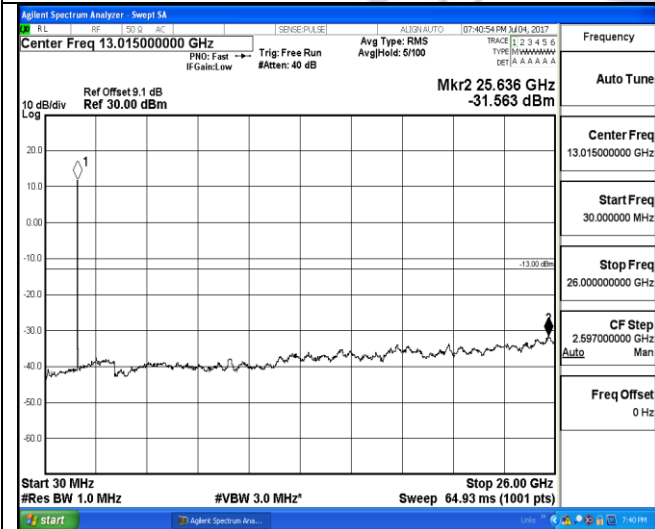

30MHz~26.5GHz

30MHz~26.5GHz

1RB#0

1RB#0



LTE FDD Band 4-10MHz Channel Bandwidth  
High Channel

QPSK

16QAM

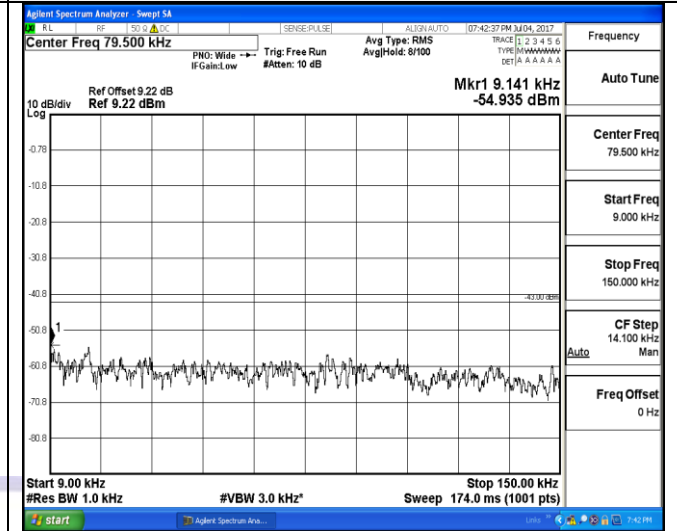
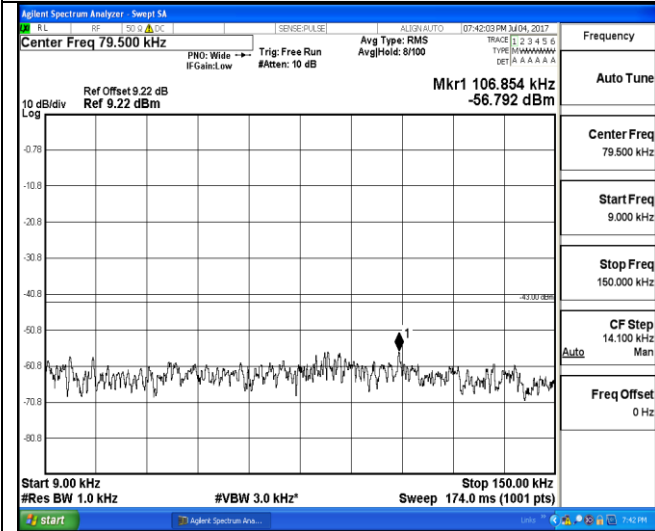

9KHz~150KHz

9KHz~150KHz

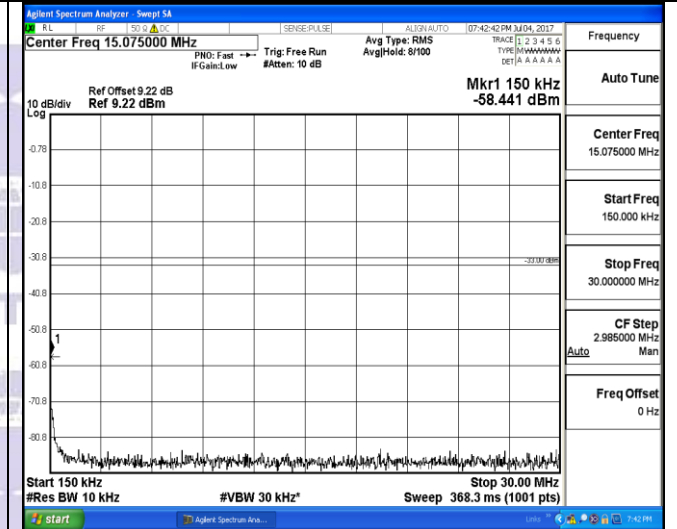
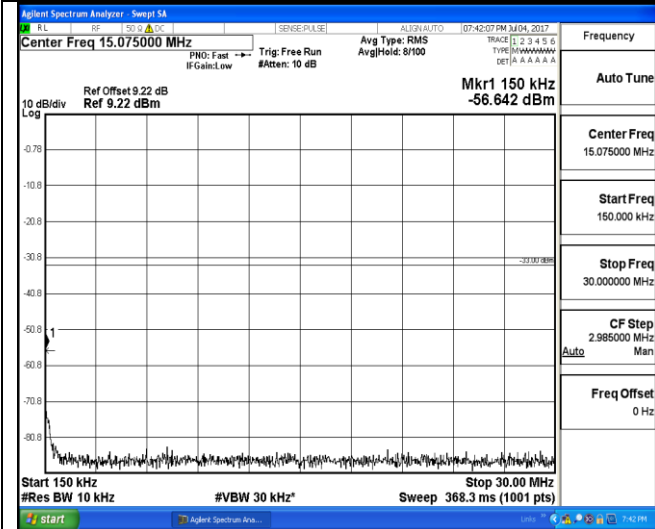

150KHz~30MHz

150KHz~30MHz



30MHz~26.5GHz  
1RB#0

30MHz~26.5GHz  
1RB#0