



Test report No:
2430175R-RF-US-P06V01

FCC & ISED TEST REPORT

Product Name	LED lamp
Trademark	PHILIPS hue 
Model and /or type reference	9290034794
FCC ID	2AGBW9290034794AX
IC	20812-34794AX
Applicant's name / address	Signify (China) Investment Co., Ltd No.9, Lane 888, Tian Lin Road, 200233, Shanghai, China
Test method requested, standard	47 CFR FCC Part 15 (Section 15.247) ANSI C63.10: 2013 RSS-Gen Issue 5 RSS-247 Issue 3
Verdict Summary	IN COMPLIANCE
Documented by (name / position & signature)	Jun Xu/ Project Engineer 
Approved by (name / position & signature)	Jack Zhang/ Manager 
Date of issue	2024-05-24
Report Version	V1.0
Report template No	Template_FCC Part 15C-RF-V1.0

INDEX

	page
General conditions	5
Environmental conditions	5
Possible test case verdicts	6
Abbreviations	6
Document History	7
Remarks and Comments.....	7
Used Equipment	8
Uncertainty	11
1 General Information.....	12
1.1 General Description of the Item(s)	12
1.2 Antenna Information	13
1.3 Channel List	14
2 Description of Test Setup	15
2.1 Operating mode(s) used for tests.....	15
2.2 Auxiliary equipment / Test software for the EUT.....	15
2.3 Test Configuration / Block diagram used for tests	16
2.4 Testing process	18
3 Verdict summary section	19
3.1 Standards.....	19
3.2 Deviation(s) from the Standard(s) / Test Specification(s).....	19
3.3 Overview of results.....	20
3.4 Power setting in test	22
3.5 Test Matrix	22
3.6 Test Facility.....	23
4 Test Items Of Limit/Setup/Procedure	24
4.1 DTS Bandwidth	24
4.1.1 Limit	24
4.1.2 Test Setup.....	24
4.1.3 Test Procedure	24
4.2 Occupied Channel Bandwidth.....	25
4.2.1 Limit	25
4.2.2 Test Setup.....	25
4.2.3 Test Procedure	25
4.3 Maximum Conducted Output Power	26

4.3.1	Limit	26
4.3.2	Test Setup	26
4.3.3	Test Procedure	27
4.4	Maximum Power Spectral Density	28
4.4.1	Limit	28
4.4.2	Test Setup	28
4.4.3	Test Procedure	28
4.5	Band Edge Measurements	29
4.5.1	Limit	29
4.5.2	Test Setup	29
4.5.3	Test Procedure	29
4.6	Conducted Spurious Emission	30
4.6.1	Limit	30
4.6.2	Test Setup	30
4.6.3	Test Procedure	30
4.7	Duty cycle	31
4.7.1	Limit	31
4.7.2	Test Setup	31
4.7.3	Test Procedure	31
4.8	Emissions in Restricted Bands	32
4.8.1	Limit	32
4.8.2	Test Setup	34
4.8.3	Test Procedure	35
4.9	AC Power Line Conducted Emission	36
4.9.1	Limit	36
4.9.2	Test Setup	36
4.9.3	Test Procedure	36
4.10	Antenna Requirement.....	37
4.10.1	Limit:	37
4.10.2	Antenna Connector Construction:	37
5	Test setup photo and EUT Photo.....	37
6	Test Result.....	38
	Appendix A: DTS Bandwidth	38
	Appendix B: Occupied Channel Bandwidth.....	45
	Appendix C: Maximum conducted output power	51
	Appendix D: Maximum power spectral density.....	52
	Appendix E: Band edge measurements.....	59

Appendix F: Conducted Spurious Emission	91
Appendix G: Duty Cycle	183
Appendix H: Emissions in Restricted Bands	190
Appendix I: AC Power Line Conducted Emission	216

COMPETENCES AND GUARANTEES

DEKRA is a testing laboratory competent to carry out the tests described in this report.

In order to assure the traceability to other national and international laboratories, DEKRA has a calibration and maintenance program for its measurement equipment.

DEKRA guarantees the reliability of the data presented in this report, which is the result of the measurements and the tests performed to the item under test on the date and under the conditions stated in the report and it is based on the knowledge and technical facilities available at DEKRA at the time of performance of the test.

DEKRA is liable to the client for the maintenance of the confidentiality of all information related to the item under test and the results of the test.

The results presented in this Test Report apply only to the particular item under test established in this document.

IMPORTANT: No parts of this report may be reproduced or quoted out of context, in any form or by any means, except in full, without the previous written permission of DEKRA.

GENERAL CONDITIONS

Test Location	No. 99, Hongye Road, Suzhou Industrial Park Suzhou, 215006, P.R. China
Date(receive sample)	Mar. 06, 2024
Date (start test)	Apr. 08, 2024
Date (finish test)	Apr. 26, 2024

1. This report is only referred to the item that has undergone the test.
2. This report does not constitute or imply on its own an approval of the product by the Certification Bodies or Competent Authorities.
3. This document is only valid if complete; no partial reproduction can be made without previous written permission of DEKRA.
4. This test report cannot be used partially or in full for publicity and/or promotional purposes without previous written permission of DEKRA.

ENVIRONMENTAL CONDITIONS

The climatic conditions during the tests are within the limits specified by the manufacturer for the operation of the EUT and the test equipment. The climatic conditions during the tests were within the following limits:

Ambient temperature	15 °C – 35 °C
Relative Humidity air	30% - 60%

If explicitly required in the basic standard or applied product / product family standard the climatic values are recorded and documented separately in this test report.

POSSIBLE TEST CASE VERDICTS

Test case does not apply to test object	N/A
Test object does meet requirement	P (Pass) / PASS
Test object does not meet requirement	F (Fail) / FAIL
Not measured	N/M

ABBREVIATIONS

For the purposes of the present document, the following abbreviations apply:

EUT	: Equipment Under Test
QP	: Quasi-Peak
CAV	: CISPR Average
AV	: Average
CDN	: Coupling Decoupling Network
SAC	: Semi-Anechoic Chamber
OATS	: Open Area Test Site
BW	: Bandwidth
AM	: Amplitude Modulation
PM	: Pulse Modulation
HCP	: Horizontal Coupling Plane
VCP	: Vertical Coupling Plane
U_N	: Nominal voltage
T_x	: Transmitter
R_x	: Receiver
N/A	: Not Applicable
N/M	: Not Measured

DOCUMENT HISTORY

Report No.	Version	Description	Issued Date
2430175R-RF-US-P06V01	V1.0	Initial issue of report.	2024-05-24

REMARKS AND COMMENTS

1. The equipment under test (EUT) does meet the essential requirements of the stated standard(s)/test(s).
2. These test results on a sample of the device are for the purpose of demonstrating Compliance with 47 CFR FCC Part 15 (Section 15.247),RSS-247 Issue 3. RSS-Gen Issue 5.
3. The measurement result is considered in conformance with the requirement if it is within the prescribed limit, It is not necessary to account the uncertainty associated with the measurement result.
4. The test results presented in this report relate only to the object tested.
5. The test report shall not be reproduced without the written approval of DEKRA Testing and Certification (Suzhou) Co., Ltd.
6. This report will not be used for social proof function in China market.
7. DEKRA declines any responsibility with the following test data provided by customer that may affect the validity of result:
 - Chapter 1.1 General Description of the Item(s);
 - Chapter 1.2 Antenna Informaion;
 - Chapter 1.3 Channel List.

Note: The General Description of the Item , antenna information and Channel List for the EUT in clause 1 are provided and confirmed by the client.

USED EQUIPMENT

Conducted Test/ TR8

Instrument	Manufacturer	Model No.	Serial No.	Cal. Date	Next Cal. Date	Firmware Version	Software version
Wireless Connectivity Tester	R&S	CMW 270	102593	2023.05.20	2024.05.19	V 4.0.60	N/A
Coaxial Cable	N/A	N/A	2477	2023.06.08	2024.06.07	N/A	N/A
Coaxial Cable	N/A	N/A	2478	2023.06.08	2024.06.07	N/A	N/A
High and low temperature and fast temperature change test box	ASTUOD	ASTD-FBT-225K	N/A	2023.05.20	2024.05.19	N/A	N/A
Temperature/Humidity Meter	RTS	RTS-8S	RF08	2023.08.25	2024.08.24	N/A	N/A
Test system							
Instrument	Manufacturer	Model No.	Serial No.	Cal. Date	Next Cal. Date	Firmware Version	Software version
MAX Signal Analyzer	Keysight	N9010A	MY48030494	2023.11.08	2024.11.07	A.14.03	N/A
RF Control Unit	Tonscend	JS0806-2	22G8060594	2024.02.06	2025.02.05	N/A	N/A
RF Control Unit	Tonscend	JS0806-2	22G8060594	2024.01.31	2025.01.30	N/A	N/A
MXG-B RF Vector Signal Generator	Keysight	N5182B	MY61252529	2023.05.20	2024.05.19	B.01.96	N/A
Frequency extender for EXG or MXG	Keysight	N5182BX07	MY59362500	2023.05.20	2024.05.19	N/A	N/A
EXG-B MW Analog Signal Generator	Keysight	N5173B	MY61252566	2023.08.26	2024.08.25	B.01.95	N/A
Test Software	Tonscend	TS1120	JS1120-3	N/A	N/A	N/A	V3.0.22

AC Power Line Conducted Emission / TR1

Instrument	Manufacturer	Model No.	Serial No.	Cal. Date	Next Cal. Date	Firmware Versiom	Software version
EMI Test Receiver	R&S	ESCI	100726	2023.08.26	2024.08.25	4.42 SP1	N/A
Two-Line V-Network	R&S	ENV 216	101044	2023.11.08	2024.11.07	N/A	N/A
Two-Line V-Network	R&S	ENV 216	101189	2023.05.14	2024.05.13	N/A	N/A
50ohm Coaxial Switch	Anritsu	MP59B	6200464462	2023.05.14	2024.05.13	N/A	N/A
Coaxial Cable	Huber+Suhner	RG 223	TR1-C1	2023.05.14	2024.05.13	N/A	N/A
Impedance Stabilization Network	Teseq GmbH	ISN T800	57318	2024.01.20	2025.01.19	N/A	N/A
Temperature/Humidity Meter	RTS	RTS-8S	EMC01	2023.05.19	2024.05.18	N/A	N/A
Dekra test software	Dekra	N/A	N/A	N/A	N/A	N/A	N/A

Radiated Emission(9KHz-1GHz) / AC2

Instrument	Manufacturer	Model No.	Serial No.	Cal. Date	Next Cal. Date	Firmware Versiom	Software version
EMI Test Receiver	R&S	ESCI	100573	2023.09.15	2024.09.14	4.42 SP3	N/A
Loop Antenna	R&S	HFH2-Z2E	101149	2023.04.25	2024.04.24	N/A	N/A
Bilog Antenna	Teseq GmbH	CBL6112D	27611	2023.09.13	2024.09.12	N/A	N/A
Temperature/Humidity Meter	RTS	RTS-8S	AC2-TH	2023.05.19	2024.05.18	N/A	N/A
Coaxial Cable	Huber+Suhner	SUCOFLEX 106	AC2-C	2023.05.21	2024.05.20	N/A	N/A
Dekra test software	Dekra	N/A	N/A	N/A	N/A	N/A	3

Radiated Emission (1GHz-40GHz) / AC5

Instrument	Manufacturer	Model No.	Serial No.	Cal. Date	Next Cal. Date	Firmware Version	Software version
EXA Spectrum Analyzer	Keysight	N9020B	MY60112218	2023.11.08	2024.11.07	A.31.05	N/A
Pre-Amplifier	SKET	LNPA_0118G-45	SK2021090101	2023.05.14	2024.05.13	N/A	N/A
Preamplifier	CHENGYI	EMC184045SE	980263	2023.07.09	2024.07.08	N/A	N/A
DRG Horn	ETS-Lindgren	3117	00123988	2023.09.16	2024.09.15	N/A	N/A
Broad-Band Horn Antenna	Schwarzbeck	BBHA9170	294	2023.05.31	2024.05.30	N/A	N/A
Filter Switch Box	MVE	MSW-F196	C070001S	2023.05.21	2024.05.20	N/A	N/A
Temperature/Humidity Meter	RTS	RTS-8S	AC5-TH	2023.05.19	2024.05.18	N/A	N/A
Coaxial Cable	ROSENBERGER	LA1-C011-2000/3000	AC5-40G	2024.01.25	2025.01.24	N/A	N/A
Coaxial Cable	ROSENBERGER	LA1-C011-2000/3000	AC5-40G-2	2023.05.21	2024.05.20	N/A	N/A
Cable	Rosenberger	LA1-C011-1000	0523	2023.05.21	2024.05.20	N/A	N/A
Dekra test software	Dekra	N/A	N/A	N/A	N/A	N/A	3

UNCERTAINTY

Uncertainties have been calculated according to the DEKRA internal document. The reported expanded uncertainties are based on a standard uncertainty multiplied by a coverage factor of $k=2$, providing a level of confidence of approximately 95% .

Test item	Uncertainty
AC Power Line Conducted Emission	9kHz~150kHz: 2.80dB 150kHz~30MHz: 2.40dB
Peak Power Output	± 1.27 dB
Radiated Emission(30MHz~1GHz)	Horizontal: 30MHz~200MHz: 3.50 dB 300MHz~1GHz: 3.60 dB Vertical: 30MHz~200MHz: 3.60 dB 300MHz~1GHz: 3.50 dB
Radiated Emission(1GHz~26.5GHz)	Horizontal: 1GHz~18GHz: 5.00 dB Vertical: 1GHz~18GHz: 4.80 dB Horizontal: 18GHz~26.5GHz: 5.30 dB Vertical: 18GHz~26.5GHz: 4.90 dB
RF antenna conducted test	± 1.27 dB
Radiated Emission Band Edge	± 3.9 dB
DTS Bandwidth	± 150 Hz
Occupied Bandwidth	± 150 Hz
Power Density	± 1.27 dB

1 GENERAL INFORMATION

1.1 General Description of the Item(s)

Product Name..... :	LED lamp
Model No. :	9290034794
Trademark. :	PHILIPS hue 
FCC ID :	2AGBW9290034794AX
IC..... :	20812-34794AX
Manufacturer..... :	Signify (China) Investment Co., Ltd
Manufacturer Address..... :	No.9, Lane 888, Tian Lin Road, 200233, Shanghai, China

Wireless specification..... :	Bluetooth (LE)					
Operating frequency range(s)	2402~2480MHz					
Type of Modulation..... :	GFSK					
PHYs	<input checked="" type="checkbox"/>	LE 1M	<input checked="" type="checkbox"/>	LE 2M	<input checked="" type="checkbox"/>	LE Coded S=2/8
Data Rate	<input checked="" type="checkbox"/>	1Mbit/s	<input checked="" type="checkbox"/>	2Mbit/s	<input checked="" type="checkbox"/>	500/125 Kbit/s
Number of channel..... :	40					

Rated power supply	Voltage and Frequency					
	<input type="checkbox"/>	AC: 220 - 240 V, 50/60 Hz				
	<input checked="" type="checkbox"/>	AC: 110 - 130 V, 50/60 Hz				
	<input type="checkbox"/>	DC: 24 Vdc				
	<input type="checkbox"/>	Poe:				
	<input type="checkbox"/>	Adapter:				
Mounting position..... :	<input type="checkbox"/>	Tabletop equipment				
	<input checked="" type="checkbox"/>	Wall/Ceiling mounted equipment				
	<input type="checkbox"/>	Floor standing equipment				
	<input type="checkbox"/>	Hand-held/Portable equipment				
	<input type="checkbox"/>	Other:				

1.2 Antenna Information

Antenna model / type number.....:	N/A		
Antenna serial number	N/A		
Antenna Delivery	<input checked="" type="checkbox"/>	1TX + 1RX	
	<input type="checkbox"/>	2TX + 2RX	
	<input type="checkbox"/>	Others:	
Antenna technology.....:	<input checked="" type="checkbox"/>	SISO	
	<input type="checkbox"/>	MIMO	<input type="checkbox"/> CDD
			<input type="checkbox"/> Beam-forming
Antenna Type.....:	<input type="checkbox"/>	External	<input type="checkbox"/> Dipole
			<input type="checkbox"/> Sectorized
			<input type="checkbox"/> Ceramic Chip
	<input checked="" type="checkbox"/>	Internal	<input type="checkbox"/> PIFA
			<input checked="" type="checkbox"/> PCB
			<input type="checkbox"/> Others.....
Antenna Gain.....:	2.5dBi		

1.3 Channel List

Bluetooth Working Frequency of Each Channel: (For LE)							
Channel	Frequency	Channel	Frequency	Channel	Frequency	Channel	Frequency
00	2402 MHz	01	2404 MHz	02	2406 MHz	03	2408 MHz
04	2410 MHz	05	2412 MHz	06	2414 MHz	07	2416 MHz
08	2418 MHz	09	2420 MHz	10	2422 MHz	11	2424 MHz
12	2426 MHz	13	2428 MHz	14	2430 MHz	15	2432 MHz
16	2434 MHz	17	2436 MHz	18	2438 MHz	19	2440 MHz
20	2442 MHz	21	2444 MHz	22	2446 MHz	23	2448 MHz
24	2450 MHz	25	2452 MHz	26	2454 MHz	27	2456 MHz
28	2458 MHz	29	2460 MHz	30	2462 MHz	31	2464 MHz
32	2466 MHz	33	2468 MHz	34	2470 MHz	35	2472 MHz
36	2474 MHz	37	2476 MHz	38	2478 MHz	39	2480 MHz

2 DESCRIPTION OF TEST SETUP

2.1 Operating mode(s) used for tests

During the tests the following operating mode(s) has(have) been used.

Test Mode For Bluetooth	Mode 1: Transmit by LE_1Mbps
	Mode 2: Transmit by LE_2Mbps
	Mode 3: Transmit by LE Coded S=8
	Mode 4: Transmit by LE Coded S=2

Note 1: Regards to the frequency band operation: the lowest, middle and highest frequency channel were selected to perform the test, then shown on this report.

2.2 Auxiliary equipment / Test software for the EUT

Auxiliary equipment	Type / Version	Manufacturer	Supplied by
(1) Notebook	Think pad x220	Lenovo	Adapter
(2) USB Control Cable	N/A	N/A	N/A
(3) USB Control Cable	N/A	N/A	N/A
software	Type / Version	Manufacturer	Supplied by
HeuApprobatonTool	N/A	N/A	N/A

Accessories Information	Cable		
	Length used during test [m]	Attached during test	Shielded
(2)USB Control Cable	1	<input checked="" type="checkbox"/>	<input checked="" type="checkbox"/>
(3)USB Control Cable	8	<input checked="" type="checkbox"/>	<input checked="" type="checkbox"/>

2.3 Test Configuration / Block diagram used for tests

Test setup Diagram- AC Line Conducted Emission Test

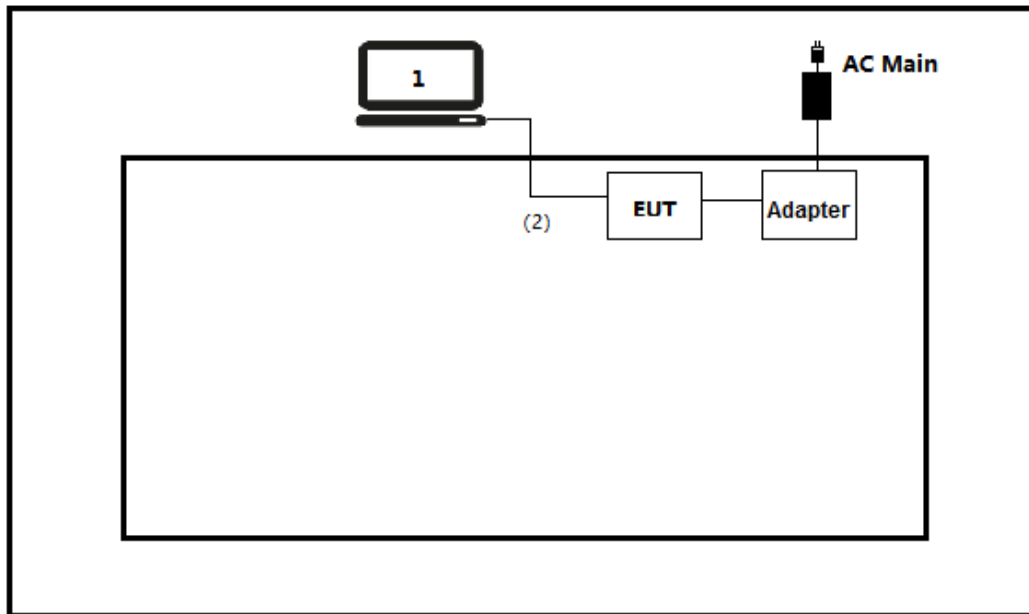

Test setup Diagram- Conducted test

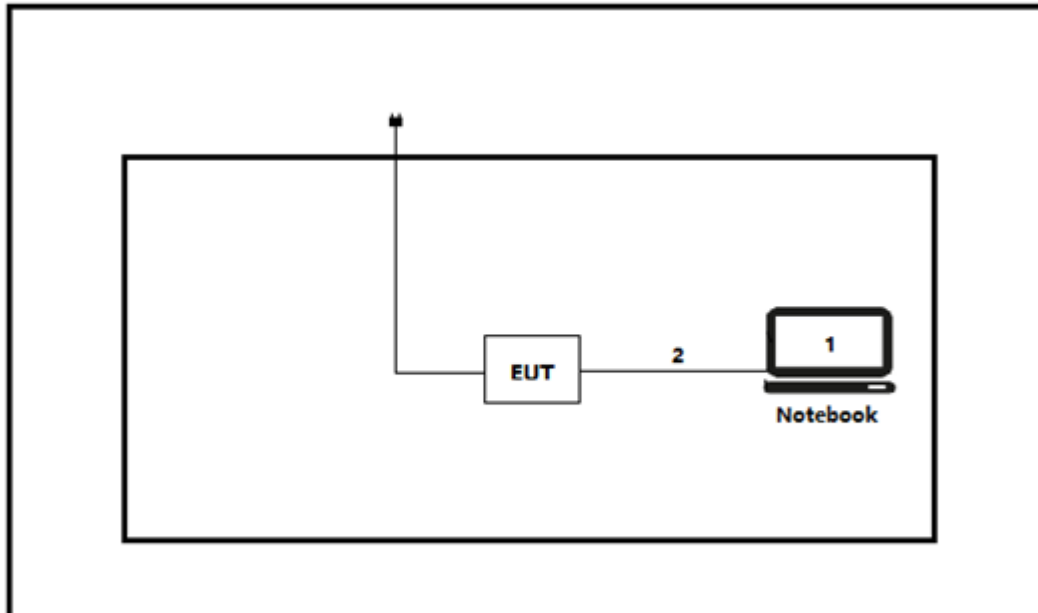

Test setup Diagram- Radiated Emission

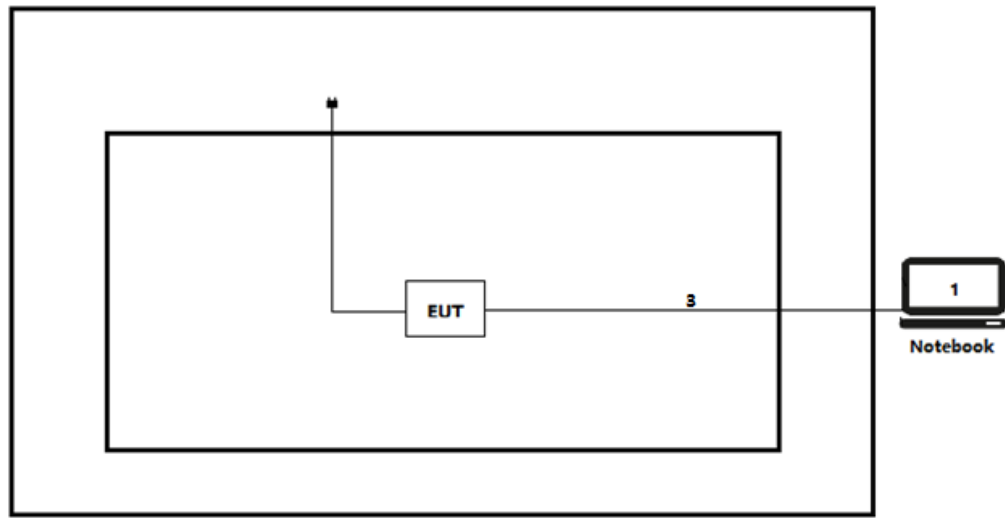

2.4 Testing process

1	Setup the EUT shown in Section 2.3.
2	Execute the [HeuApprobationTool] on the notebook.
3	Configure the test mode, the test channel, and the data rate.
4	Verify that the EUT works properly.

3 VERDICT SUMMARY SECTION

This chapter presents an overview of standards and results. Refer to the next chapters for details of measured test results and applied test levels.

3.1 Standards

Standard	Year	Description
CFR 47, FCC Part 15 C	2024	Operation within the bands 902–928 MHz, 2400–2483.5 MHz, and 5725–5850 MHz.
ANSI C63.10	2013	American National Standard of Procedures for Compliance Testing of Unlicensed Wireless Devices
RSS-Gen Issue 5 Amendment 2	2021	General Requirements for Compliance of Radio Apparatus
RSS-247 Issue 3	2023	Digital Transmission Systems (DTSS), Frequency Hopping Systems (FHSs) and Licence-Exempt Local Area Network (LE-LAN) Devices

3.2 Deviation(s) from the Standard(s) / Test Specification(s)

The following deviation(s) was / were made from the published requirements of the listed standards: N/A.

(Please define the deviations from the standard(s) if applicable)

3.3 Overview of results

Requirement – Test Item of FCC	Standard(s)	Verdict	Remark
20dB Emission Bandwidth	FCC 15.247(a)(2)	PASS	Test data please refer to Appendix A
Maximum conducted output power	15.247 (b)(3)	PASS	Test data please refer to Appendix C
Maximum power spectral density	FCC 15.247(e)	PASS	Test data please refer to Appendix D
Band edge measurements	FCC 15.247(d) FCC 15.205 FCC 15.209	PASS	Test data please refer to Appendix E
Conducted Spurious Emission	FCC 15.247(d), FCC 15.209	PASS	Test data please refer to Appendix F
Duty cycle	ANSI C63.10:2013	PASS	Test data please refer to Appendix G
Emissions in Restricted Bands	FCC 15.205 FCC 15.209	PASS	Test data please refer to Appendix H
AC Power Line Conducted Emission	FCC 15.207	PASS	Test data please refer to Appendix I
Antenna Requirement	FCC 15.203	PASS	---

Requirement – Test case of ISED	Standard(s)	Verdict	Remark
DTS Bandwidth	RSS-Gen Issue 5 Paragraph 6.7 RSS-247 Issue 3 Paragraph 5.2	PASS	Test data please refer to Appendix A
Occupied Channel Bandwidth	RSS-Gen Issue 5 Paragraph 6.7 RSS-247 Issue 3 Paragraph 5.2	PASS	Test data please refer to Appendix B
Maximum conducted output power	RSS-247 Issue 3 Paragraph 5.4(d)	PASS	Test data please refer to Appendix C
Maximum power spectral density	RSS-247 Issue 3 Paragraph 5.2(b)	PASS	Test data please refer to Appendix D
Band edge measurements	RSS-Gen Issue 5 Paragraph 8.10	PASS	Test data please refer to Appendix E
Conducted Spurious Emission	RSS-247 Issue 3 Paragraph 5.5	PASS	Test data please refer to Appendix F
Duty cycle	ANSI C63.10:2013	PASS	Test data please refer to Appendix G
Emissions in Restricted Bands	RSS-Gen Issue 5 Paragraph 8.9	PASS	Test data please refer to Appendix H
AC Power Line Conducted Emission	RSS-Gen Issue 5 Paragraph 8.8	PASS	Test data please refer to Appendix I
Antenna Requirement	RSS-Gen Issue 5 Paragraph 6.8	PASS	---

3.4 Power setting in test

Mode	Channel	Frequency (MHz)	Power setting
Mode1	00	2402	8
	19	2440	8
	39	2480	8
Mode2	00	2402	8
	19	2440	8
	39	2480	8
Mode3	00	2402	8
	19	2440	8
	39	2480	8
Mode4	00	2402	8
	19	2440	8
	39	2480	8

3.5 Test Matrix

Test item	Model: 9290034794	
	1(#1)	2(#2)
DTS Bandwidth	<input checked="" type="checkbox"/>	<input type="checkbox"/>
Occupied Channel Bandwidth	<input checked="" type="checkbox"/>	<input type="checkbox"/>
Maximum conducted output power	<input checked="" type="checkbox"/>	<input type="checkbox"/>
Maximum power spectral density	<input checked="" type="checkbox"/>	<input type="checkbox"/>
Band edge measurements	<input type="checkbox"/>	<input checked="" type="checkbox"/>
Conducted Spurious Emission	<input checked="" type="checkbox"/>	<input type="checkbox"/>
Duty cycle	<input checked="" type="checkbox"/>	<input type="checkbox"/>
Emissions in Restricted Bands	<input type="checkbox"/>	<input checked="" type="checkbox"/>
AC Power Line Conducted Emission	<input type="checkbox"/>	<input checked="" type="checkbox"/>

Note1: The only difference between sample #1 and sample #2 is whether to keep the original antenna, sample #1 is a conduction test product that removes the original antenna and is equipped with SMA wires, and sample #2 is a complete product that retains the original antenna.

3.6 Test Facility

USA	:	FCC Designation Number: CN1199
CA	:	ISED CAB identifier: CN0040

4 TEST ITEMS OF LIMIT/SETUP/PROCEDURE

4.1 DTS Bandwidth

VERDICT: PASS

4.1.1 Limit

Standard

FCC Part 15 Subpart C Paragraph 15.247 (a)(2); RSS-247 Issue 3 Paragraph 5.2.

Systems using digital modulation techniques operate in the 2400-2483.5 MHz. The minimum 6 dB bandwidth shall be at least 500 kHz

4.1.2 Test Setup

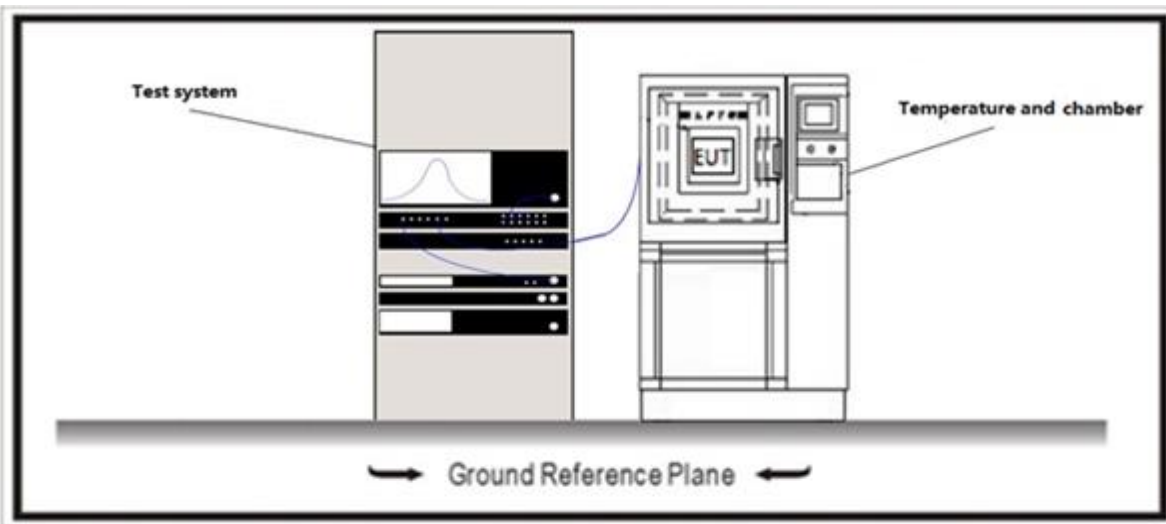

4.1.3 Test Procedure

	Reference Rule	Chapter	Description
<input checked="" type="checkbox"/>	ANSI C63.10	11.8	DTS bandwidth
<input checked="" type="checkbox"/>	ANSI C63.10	11.8.1	Option 1
<input type="checkbox"/>	ANSI C63.10	11.8.2	Option 2

4.2 Occupied Channel Bandwidth

VERDICT: PASS

4.2.1 Limit

Standard RSS-Gen Issue 5 Paragraph 6.7

The occupied bandwidth or the “99% emission bandwidth” is defined as the frequency range between two points, one above and the other below the carrier frequency, within which 99% of the total transmitted power of the fundamental transmitted emission is contained. The occupied bandwidth shall be reported for all equipment in addition to the specified bandwidth required in the applicable RSSs

4.2.2 Test Setup

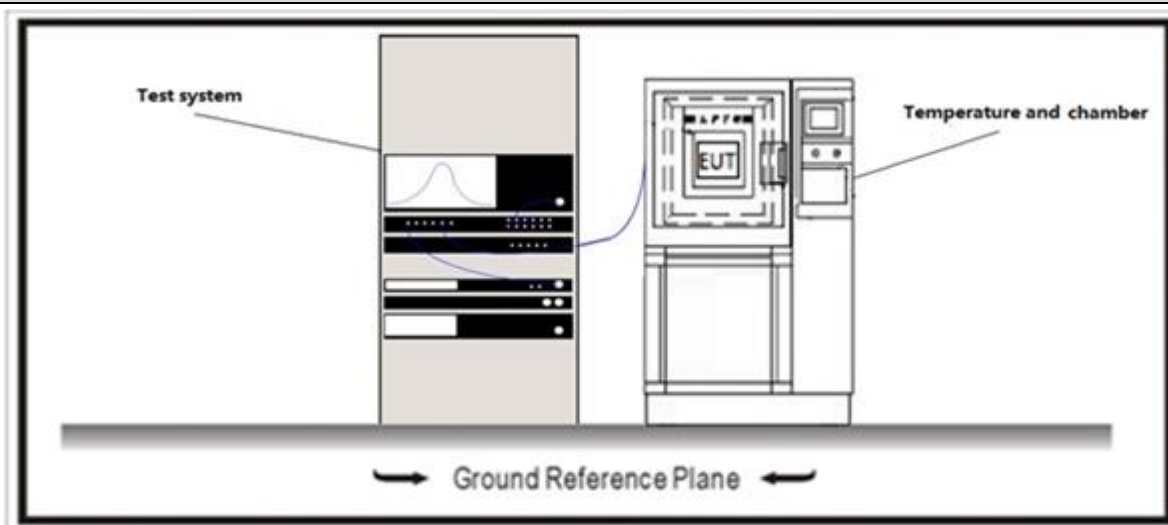

4.2.3 Test Procedure

	Reference Rule	Chapter	Description
<input checked="" type="checkbox"/>	ANSI C63.10	6.9	Occupied bandwidth tests
<input type="checkbox"/>	ANSI C63.10	6.9.2	Option 1
<input checked="" type="checkbox"/>	ANSI C63.10	6.9.3	Option 2

4.3 Maximum Conducted Output Power	VERDICT: PASS
---	----------------------

4.3.1 Limit

Standard	FCC Part 15 Subpart C Paragraph 15.247 (b)(3); RSS-247 Issue 3 Paragraph 5.4(d).	
<input checked="" type="checkbox"/>	GTX < 6dBi	$P_{out} \leq 30 \text{ dBm}$
<input type="checkbox"/>	GTX > 6dBi	
<input type="checkbox"/>	Non-Fix point-point	$P_{out} \leq 30 - (GTX - 6)$
<input type="checkbox"/>	Fix point-point	$P_{out} \leq 30 - [(GTX - 6)]/3$
<input type="checkbox"/>	Point-to-multipoint	$P_{out} \leq 30 - (GTX - 6)$
<input type="checkbox"/>	Overlap Beams	$P_{out} \leq 30 - [(GTX - 6)]/3$
<input type="checkbox"/>	Aggregate power transmitted simultaneously on all beams	$P_{out} \leq 30 - [(GTX - 6)]/3$
<input type="checkbox"/>	single directional beam	$P_{out} \leq 30 - [(GTX - 6)]/3 + 8 \text{ dB}$

Note 1 : GTX directional gain of transmitting antennas.

Note 2 : Pout is maximum peak conducted output power .

4.3.2 Test Setup

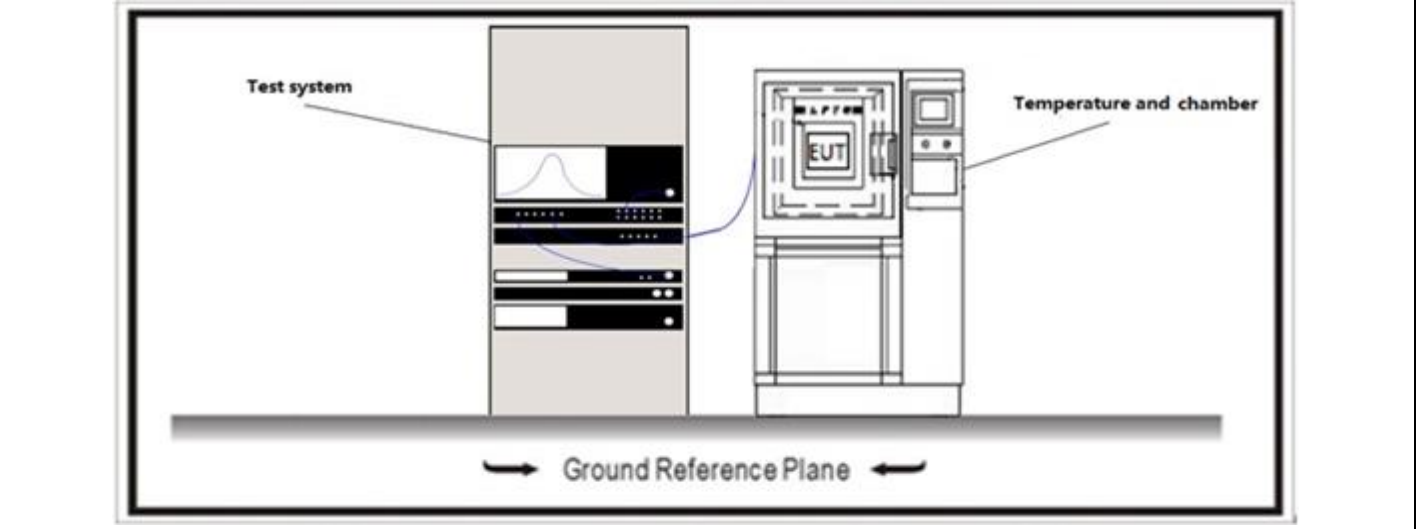

4.3.3 Test Procedure				
	References Rule		Chapter	Description
<input checked="" type="checkbox"/>	ANSI C63.10		11.9	Fundamental emission output power
<input type="checkbox"/>	ANSI C63.10		11.9.1	Maximum peak conducted output power
	<input type="checkbox"/>	ANSI C63.10	11.9.1.1	RBW \geq DTS bandwidth
	<input type="checkbox"/>	ANSI C63.10	11.9.1.2	Integrated band power method
	<input type="checkbox"/>	ANSI C63.10	11.9.1.3	PKPM1 Peak power meter method
<input checked="" type="checkbox"/>	ANSI C63.10		11.9.2	Maximum conducted (average) output power
	<input type="checkbox"/>	ANSI C63.10	11.9.2.2	Measurement using a spectrum analyzer (SA)
	<input type="checkbox"/>	ANSI C63.10	11.9.2.2.2	Method AVGSA-1(Duty cycle \geq 98%)
	<input type="checkbox"/>	ANSI C63.10	11.9.2.2.3	Method AVGSA-1A(Duty cycle \geq 98%)
	<input type="checkbox"/>	ANSI C63.10	11.9.2.2.4	Method AVGSA-2(Duty cycle \leq 98%)
	<input type="checkbox"/>	ANSI C63.10	11.9.2.2.5	Method AVGSA-2A(Duty cycle \leq 98%)
	<input type="checkbox"/>	ANSI C63.10	11.9.2.2.4	Method AVGSA-3
	<input type="checkbox"/>	ANSI C63.10	11.9.2.2.5	Method AVGSA-3A
	<input checked="" type="checkbox"/>	ANSI C63.10	11.9.2.3	Measurement using a power meter (PM)
	<input checked="" type="checkbox"/>	ANSI C63.10	11.9.2.3.1	Method AVGPM
	<input type="checkbox"/>	ANSI C63.10	11.9.2.3.2	Method AVGPM-G

4.4 Maximum Power Spectral Density	VERDICT: PASS
---	----------------------

4.4.1 Limit

Standard	FCC Part 15 Subpart C Paragraph 15.247 (b)(3); RSS-247 Issue 3 Paragraph 5.2(b).
-----------------	---

Power Spectral Density ≤ 8dBm/3kHz

4.4.2 Test Setup

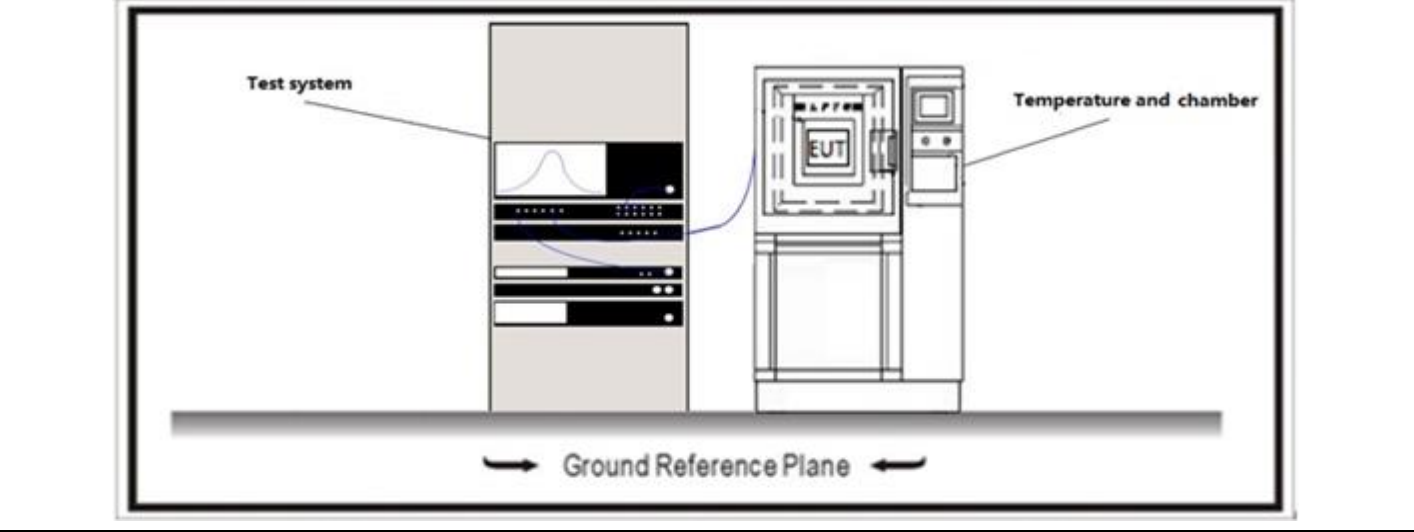

4.4.3 Test Procedure

	References Rule	Chapter	Description
<input checked="" type="checkbox"/>	ANSI C63.10	11.10	Maximum power spectral density level in the fundamental emission
<input checked="" type="checkbox"/>	ANSI C63.10	11.10.2	Method PKPSD (peak PSD)
<input type="checkbox"/>	ANSI C63.10	11.10.3	Method AVGPSD-1(Duty cycle ≥ 98%)
<input type="checkbox"/>	ANSI C63.10	11.10.4	Method AVGPSD-1A(Duty cycle ≥ 98%)
<input type="checkbox"/>	ANSI C63.10	11.10.5	Method AVGPSD-2(Duty cycle < 98%)
<input type="checkbox"/>	ANSI C63.10	11.10.6	Method AVGPSD-2A(Duty cycle < 98%)
<input type="checkbox"/>	ANSI C63.10	11.10.7	Method AVGPSD-3
<input type="checkbox"/>	ANSI C63.10	11.10.8	Method AVGPSD-3A

4.5 Band Edge Measurements	VERDICT: PASS
-----------------------------------	----------------------

4.5.1 Limit

Standard	FCC Part 15 Subpart C Paragraph 15.247(d) , 15.209; RSS-Gen Issue 5 Paragraph 8.10.			
Frequency bands (MHz)	Detector	Limit (dBµV/m)	RBW (MHz)	Distance (m)
2310-2390	PK	74	1	3
2483.5-2500	AV	54	1	3

Note: The field strength of emissions appearing within these frequency bands shall not exceed the limits.

4.5.2 Test Setup

Above 1GHz Test Setup:

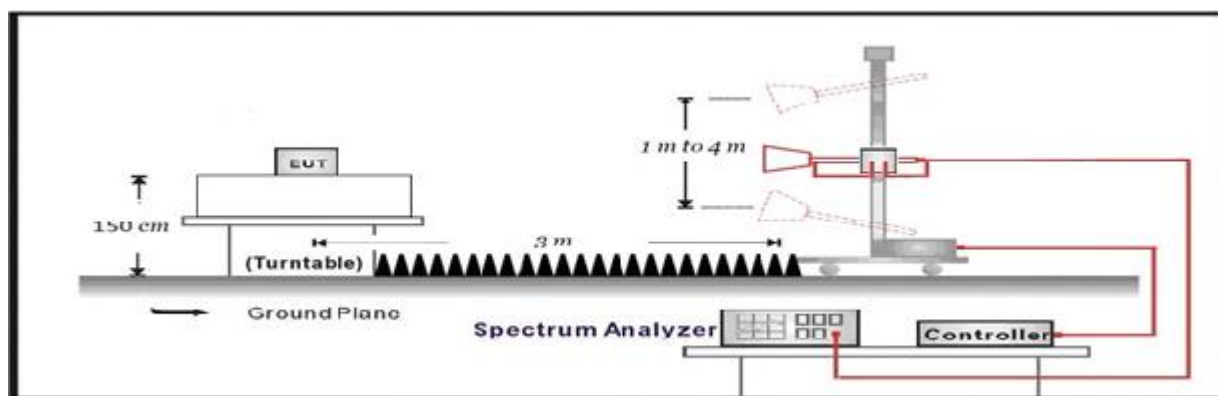

4.5.3 Test Procedure

	References Rule	Chapter	Description
<input checked="" type="checkbox"/>	ANSI C63.10	6.10	Band-edge testing
	<input checked="" type="checkbox"/> ANSI C63.10	6.10.5	Restricted-band band-edge measurements
	<input type="checkbox"/> ANSI C63.10	6.10.6	Marker-delta method
<input checked="" type="checkbox"/>	ANSI C63.10	11.12	Emissions in restricted frequency bands
	<input checked="" type="checkbox"/> ANSI C63.10	11.12.1	Radiated emission measurements
	<input checked="" type="checkbox"/> ANSI C63.10	11.12.2.7	Radiated spurious emission test
<input type="checkbox"/>	ANSI C63.10	6.4	Radiated emissions from unlicensed wireless devices below 30 MHz
<input type="checkbox"/>	ANSI C63.10	6.5	Radiated emissions from unlicensed wireless devices in the frequency range of 30 MHz to 1000 MHz
<input checked="" type="checkbox"/>	ANSI C63.10	6.6	Radiated emissions from unlicensed wireless devices above 1 GHz

4.6 Conducted Spurious Emission	VERDICT: PASS
--	----------------------

4.6.1 Limit

Standard	FCC Part 15 Subpart C Paragraph 15.247(d); RSS-247 Issue 3 Paragraph 5.5.
RF Output power (Detection methods)	Limit(dB)
RF Output power(Average detector)	30dBc(Note1)
RF Output power(PK detector)	20dBc(Note2)

Note 1: If maximum conducted (average) output power was used to demonstrate compliance as described in 9.2, then the peak power in any 100 kHz bandwidth outside of the authorized frequency band shall be attenuated by at least 30 dB relative to the maximum in-band peak PSD level in 100 kHz (i.e., 30 dBc).

Note 2: If the maximum peak conducted output power procedure was used, then the peak output power measured in any 100 kHz bandwidth outside of the authorized frequency band shall be attenuated by at least 20 dB relative to the maximum in-band peak PSD level in 100 kHz (i.e., 20 dBc).

4.6.2 Test Setup

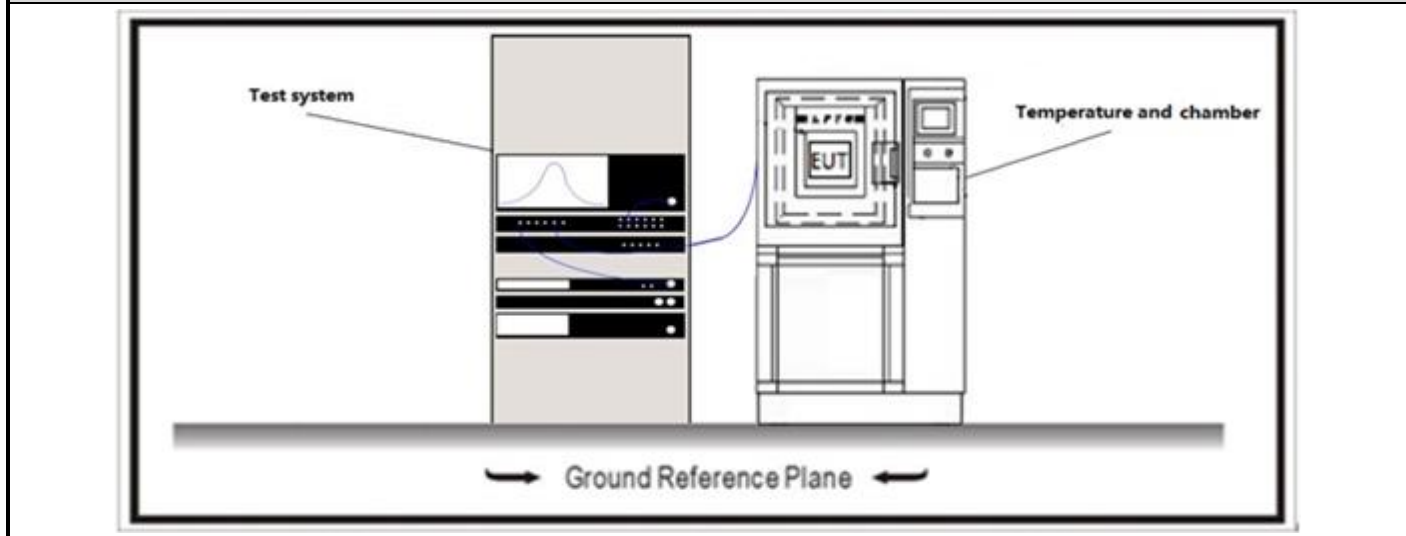

4.6.3 Test Procedure

References Rule	Chapter	Description
<input checked="" type="checkbox"/> ANSI C63.10	11.11	Emissions in non-restricted frequency bands
<input checked="" type="checkbox"/> ANSI C63.10	11.11.1	General
<input checked="" type="checkbox"/> ANSI C63.10	11.11.2	Reference level measurement
<input checked="" type="checkbox"/> ANSI C63.10	11.11.3	Emission level measurement

4.7 Duty cycle	VERDICT: PASS
-----------------------	----------------------

4.7.1 Limit

N/A

4.7.2 Test Setup

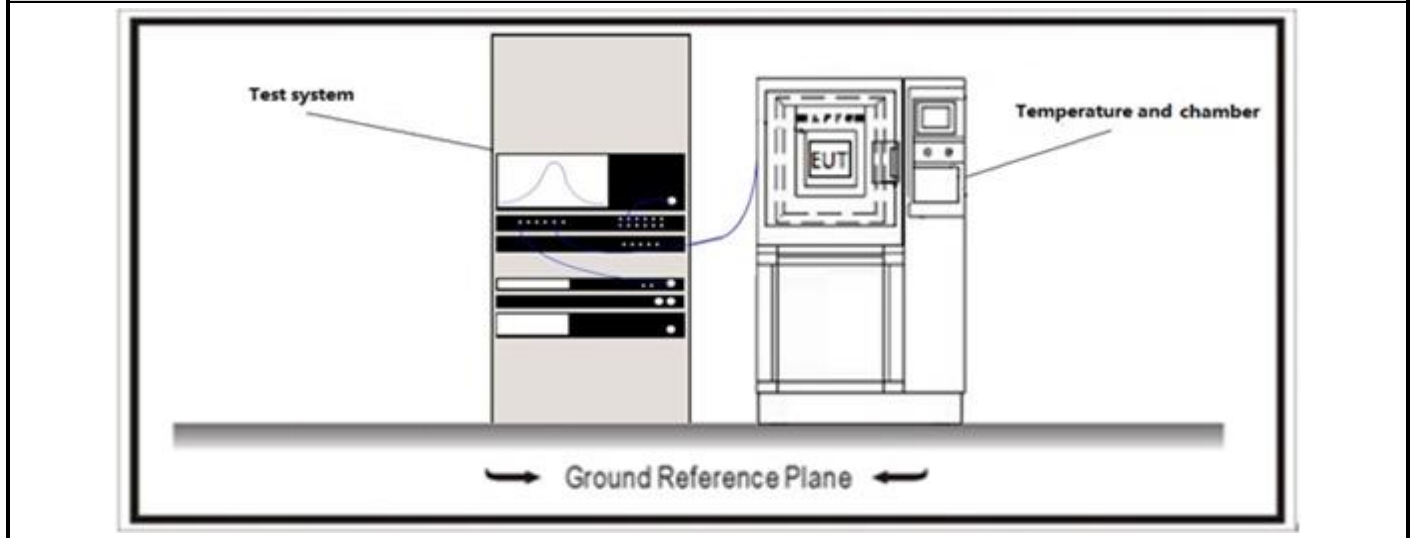

4.7.3 Test Procedure

References Rule	Chapter	Description
<input checked="" type="checkbox"/> ANSI C63.10	11.6	Duty cycle (D), transmission duration (T), and maximum power control level

4.8 Emissions in Restricted Bands**VERDICT: PASS****4.8.1 Limit****Standard**

FCC Part 15 Subpart C Paragraph 15.205

Restricted Bands of operation

Frequency (MHz)	Frequency (MHz)	Frequency (MHz)	Frequency (GHz)
0.090 – 0.110	16.42 – 16.423	399.9 – 410	4.5 – 5.15
0.495 – 0.505	16.69475 – 16.69525	608 – 614	5.35 – 5.46
2.1735 – 2.1905	16.80425 – 16.80475	960 – 1240	7.25 – 7.75
4.125 – 4.128	25.5 – 25.67	1300 – 1427	8.025 – 8.5
4.17725 – 4.17775	37.5 – 38.25	1435 – 1626.5	9.0 – 9.2
4.20725 – 4.20775	73 – 74.6	1645.5 – 1646.5	9.3 – 9.5
6.215 – 6.218	74.8 – 75.2	1660 – 1710	10.6 – 12.7
6.26775 – 6.26825	108 – 121.94	1718.8 – 1722.2	13.25 – 13.4
6.31175 – 6.31225	123 – 138	2200 – 2300	14.47 – 14.5
8.291 – 8.294	149.9 – 150.05	2310 – 2390	15.35 – 16.2
8.362 – 8.366	156.52475 – 156.52525	2483.5 – 2500	17.7 – 21.4
8.37625 – 8.38675	156.7 – 156.9	2690 – 2900	22.01 – 23.12
8.81425 – 8.81475	162.0125 – 167.17	3260 – 3267	23.6 – 24.0
12.29 – 12.293	167.72 – 173.2	3332 – 3339	31.2 – 31.8
12.51975 – 12.52025	240 – 285	3345.8 – 3358	36.43 – 36.5
12.57675 – 12.57725	322 – 335.4	3600 – 4400	
13.36 – 13.41			

Standard

RSS-Gen Issue 5 Paragraph 8.10

Restricted Bands of operation for IC

0.090 - 0.110	13.36 - 13.41	960 - 1427	9.0 - 9.2
0.495 - 0.505	16.42 - 16.423	1435 - 1626.5	9.3 - 9.5
2.1735 - 2.1905	16.69475 - 16.69525	1645.5 - 1646.5	10.6 - 12.7
3.020 - 3.026	16.80425 - 16.80475	1660 - 1710	13.25 - 13.4
4.125 - 4.128	25.5 - 25.67	1718.8 - 1722.2	14.47 - 14.5
4.17725 - 4.17775	37.5 - 38.25	2200 - 2300	15.35 - 16.2
4.20725 - 4.20775	73 - 74.6	2310 - 2390	17.7 - 21.4
5.677 - 5.683	74.8 - 75.2	2483.5 - 2500	22.01 - 23.12
6.215 - 6.218	108 - 138	2655 - 2900	23.6 - 24.0
6.26775 - 6.26825	149.9 - 150.05	3260 - 3267	31.2 - 31.8
6.31175 - 6.31225	156.52475 - 156.52525	3332 - 3339	36.43 - 36.5
8.291 - 8.294	156.7 - 156.9	3345.8 - 3358	Above 38.6
8.362 - 8.366	162.0125 - 167.17	3500 - 4400	
8.37625 - 8.38675	167.72 - 173.2	4500 - 5150	
8.41425 - 8.41475	240 - 285	5350 - 5460	
12.29 - 12.293	322 - 335.4	7250 - 7750	
12.51975 - 12.52025	399.9 - 410	8025 - 8500	
12.57675 - 12.57725	608 - 614	--	

Restricted Band Emissions Limit			
FCC Part 15 Subpart C Paragraph 15.209			
Frequency (MHz)	Field strength (µV/m)	Field strength (dBµV/m)	Measurement distance (m)
0.009 - 0.49	2400/F(kHz)	48.5 – 13.8	300 ^(Note 1)
0.49 - 1.705	24000/F(kHz)	33.8 - 23	30 ^(Note 1)
1.705 - 30	30	29.5	30 ^(Note 1)
30 - 88	100	40	3 ^(Note 2)
88 - 216	150	43.5	3 ^(Note 2)
216 - 960	200	46	3 ^(Note 2)
Above 960	500	54	3 ^(Note 2)
RSS-Gen Issue 5 Paragraph 8.9.			
Frequency (MHz)	Field strength	Field strength (dBµV/m)	Measurement distance (m)
0.009 - 0.49	6.37/F(kHz) µA/m	48.5 – 13.8	300 ^(Note 1)
0.49 - 1.705	63.7/F(kHz) µA/m	33.8 - 23	30 ^(Note 1)
1.705 - 30	30 µV/m	29.5	30 ^(Note 1)
30 - 88	100 µV/m	40	3 ^(Note 2)
88 - 216	150 µV/m	43.5	3 ^(Note 2)
216 - 960	200 µV/m	46	3 ^(Note 2)
Above 960	500 µV/m	54	3 ^(Note 2)
<p>Note 1: At frequencies below 30 MHz, measurements may be performed at a distance closer than that specified in the regulations; however, an attempt should be made to avoid making measurements in the near field. Pending the development of an appropriate measurement procedure for measurements performed below 30 MHz, when performing measurements at a closer distance than specified, the results shall be extrapolated to the specified distance by either making measurements at a minimum of two distances on at least one radial to determine the proper extrapolation factor or by using the square of an inverse linear distance extrapolation factor (40 dB/decade).</p> <p>Note 2: At frequencies at or above 30 MHz, measurements may be performed at a distance other than what is specified provided: measurements are not made in the near field except where it can be shown that near field measurements are appropriate due to the characteristics of the device; and it can be demonstrated that the signal levels needed to be measured at the distance employed can be detected by the measurement equipment. Measurements shall not be performed at a distance greater than 30 meters unless it can be further demonstrated that measurements at a distance of 30 meters or less are impractical. When performing measurements at a distance other than that specified, the results shall be extrapolated to the specified distance using an extrapolation factor of 20 dB/decade (inverse linear-distance for field strength measurements; inverse-linear-distance-squared for power density measurements).</p>			

4.8.2 Test Setup

Below 30MHz Test Setup:

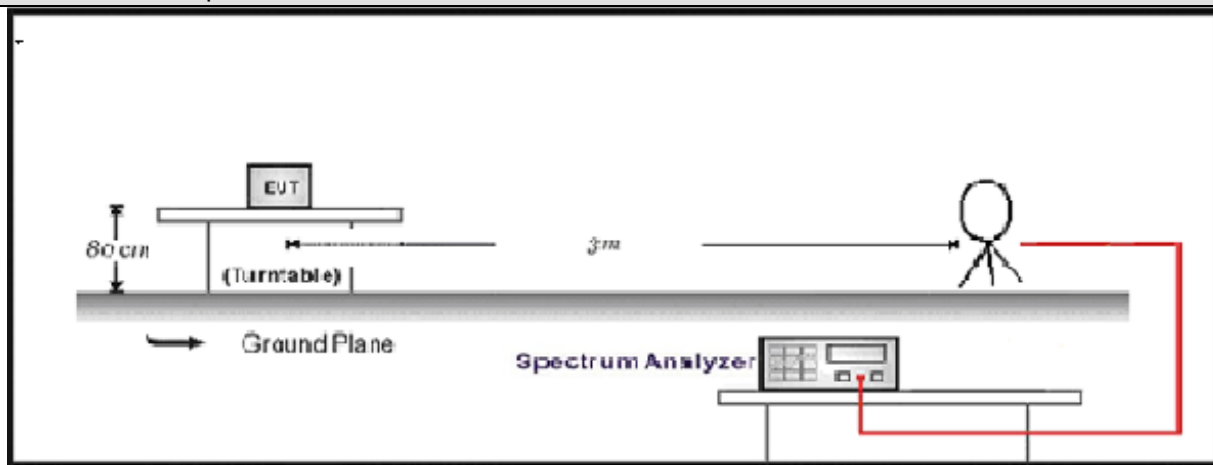

30MHz-1GHz Test Setup:

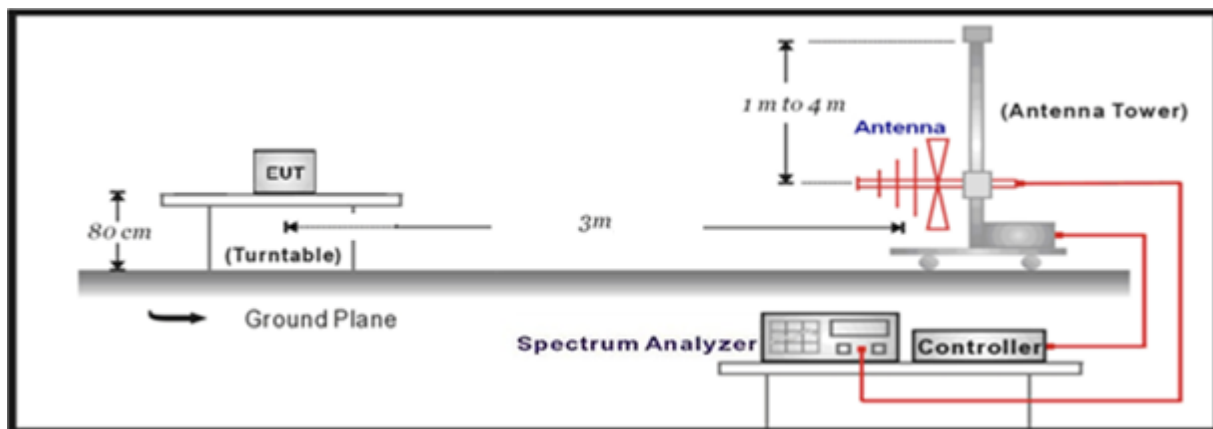

Above 1GHz Test Setup:

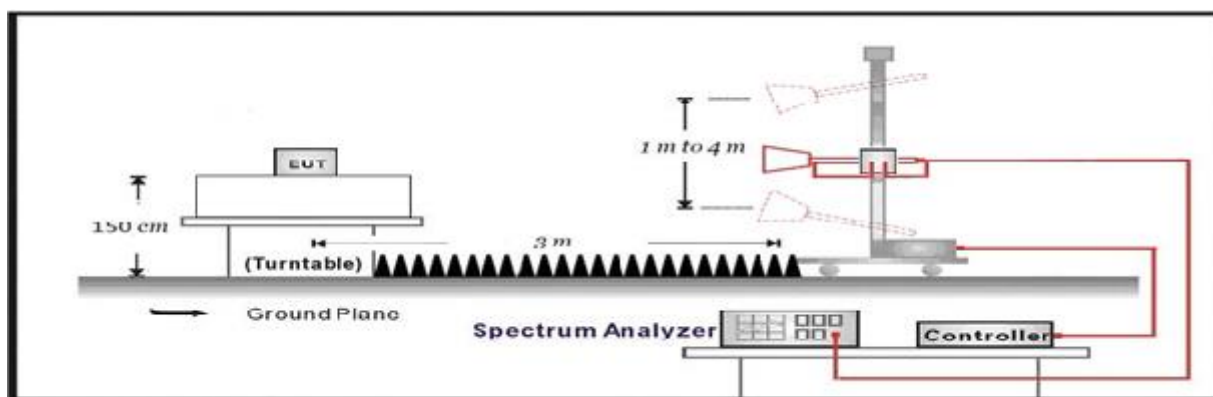

4.8.3 Test Procedure			
	References Rule	Chapter	Description
<input checked="" type="checkbox"/>	ANSI C63.10	11.12	Emissions in restricted frequency bands
<input checked="" type="checkbox"/>	<input checked="" type="checkbox"/> ANSI C63.10	11.12.1	Radiated emission measurements
<input checked="" type="checkbox"/>	<input checked="" type="checkbox"/> ANSI C63.10	11.12.2.7	Radiated spurious emission test
	<input checked="" type="checkbox"/> ANSI C63.10	6.4	Radiated emissions from unlicensed wireless devices below 30 MHz
	<input checked="" type="checkbox"/> ANSI C63.10	6.5	Radiated emissions from unlicensed wireless devices in the frequency range of 30 MHz to 1000 MHz
	<input checked="" type="checkbox"/> ANSI C63.10	6.6	Radiated emissions from unlicensed wireless devices above 1 GHz

4.9 AC Power Line Conducted Emission

VERDICT: PASS

4.9.1 Limit

Standard FCC Part 15 Subpart C Paragraph 15.207; RSS-Gen Issue 5 Paragraph 8.8.

Frequency range [MHz]	Limit: QP [dB(μV) ¹⁾	Limit: AV [dB(μV) ¹⁾
0,15 - 0,50	66 - 56 ²⁾	56 - 46 ²⁾
0,50 - 5,0	56	46
5,0 - 30	60	50

¹⁾ At the transition frequency, the lower limit applies.

²⁾ The limit decreases linearly with the logarithm of the frequency.

NOTE 1: The exclusion band for transmitters shall be considered for transmitters operating at frequencies below 30 MHz.

NOTE 2: Where the AC output port is directly connected (or via a circuit breaker) to the AC power input port of the EUT the AC power output port need not to be tested.

4.9.2 Test Setup

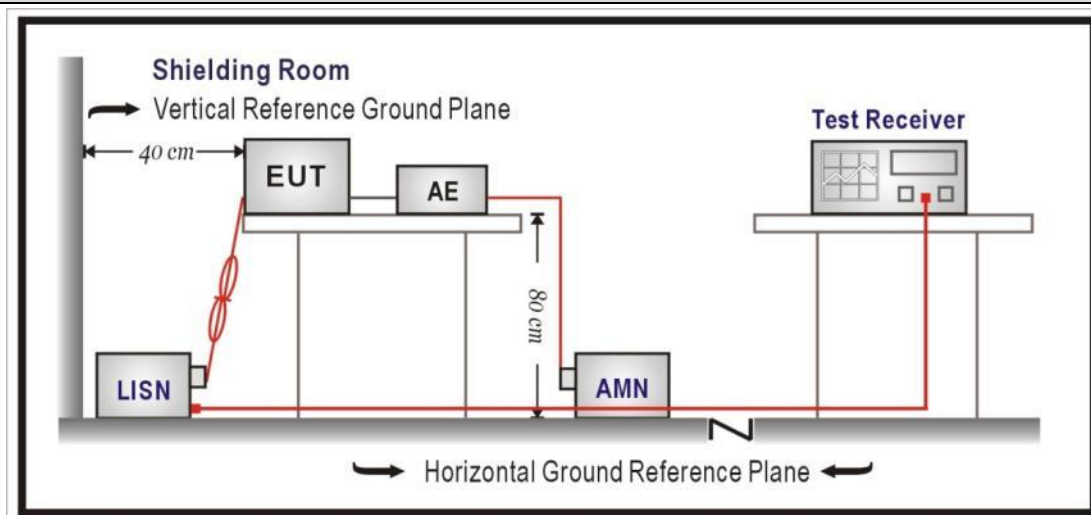

4.9.3 Test Procedure

	References Rule	Chapter	Item
<input checked="" type="checkbox"/>	ANSI C63.10-2013	6.2	Standard test method for ac power-line conducted emissions from unlicensed wireless devices

4.10 Antenna Requirement

VERDICT: PASS

4.10.1 Limit:

Standard	FCC Part 15 Subpart C Paragraph 15.203; RSS-Gen Issue 5 Paragraph 6.8.
<p>An intentional radiator shall be designed to ensure that no antenna other than that furnished by the responsible party shall be used with the device. The use of a permanently attached antenna or of an antenna that uses a unique coupling to the intentional radiator shall be considered sufficient to comply with the provisions of this section. The manufacturer may design the unit so that a broken antenna can be replaced by the user, but the use of a standard antenna jack or electrical connector is prohibited. This requirement does not apply to carrier current devices or to devices operated under the provisions of §15.211, §15.213, §15.217, §15.219, or §15.221. Further, this requirement does not apply to intentional radiators that must be professionally installed, such as perimeter protection systems and some field disturbance sensors, or to other intentional radiators which, in accordance with §15.31(d), must be measured at the installation site. However, the installer shall be responsible for ensuring that the proper antenna is employed so that the limits in this part are not exceeded.</p>	

4.10.2 Antenna Connector Construction:

<input checked="" type="checkbox"/>	The use of a permanently attached antenna
<input type="checkbox"/>	The antenna use of a unique coupling to the intentional radiator
<input type="checkbox"/>	The use of a nonstandard antenna jack or electrical connector
Please refer to the attached document "Internal Photograph" to show the antenna connector.	

5 TEST SETUP PHOTO AND EUT PHOTO

Remark: The test setup photo and EUT Photo please see appendix.

6 TEST RESULT

Appendix A: DTS Bandwidth

TestMode	Antenna	Frequency[MHz]	DTS BW [MHz]	FL[MHz]	FH[MHz]	Limit[MHz]	Verdict
BLE_1M	Ant1	2402	0.664	2401.668	2402.332	0.5	PASS
BLE_1M	Ant1	2440	0.684	2439.668	2440.352	0.5	PASS
BLE_1M	Ant1	2480	0.668	2479.680	2480.348	0.5	PASS
BLE_2M	Ant1	2402	1.344	2401.344	2402.688	0.5	PASS
BLE_2M	Ant1	2440	1.332	2439.352	2440.684	0.5	PASS
BLE_2M	Ant1	2480	1.344	2479.340	2480.684	0.5	PASS
BLE_125K	Ant1	2402	0.744	2401.636	2402.380	0.5	PASS
BLE_125K	Ant1	2440	0.740	2439.636	2440.376	0.5	PASS
BLE_125K	Ant1	2480	0.736	2479.640	2480.376	0.5	PASS
BLE_500K	Ant1	2402	0.780	2401.608	2402.388	0.5	PASS
BLE_500K	Ant1	2440	0.752	2439.632	2440.384	0.5	PASS
BLE_500K	Ant1	2480	0.788	2479.612	2480.400	0.5	PASS



BLE_1M-Ant1-2402-PASS

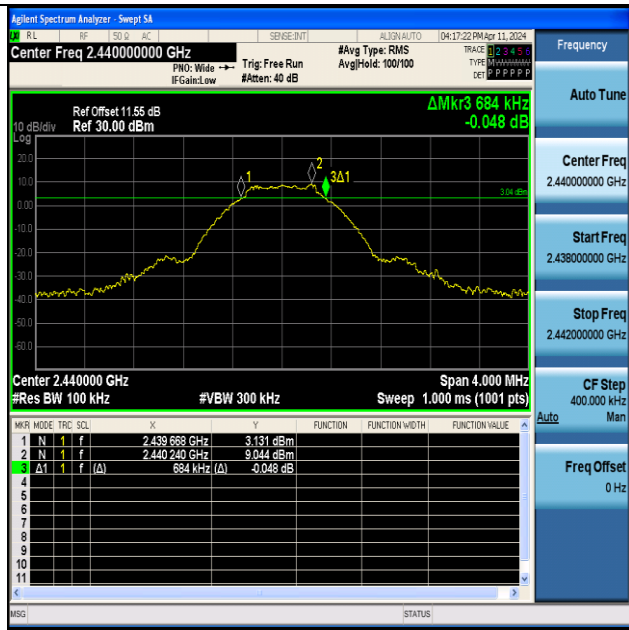

BLE_1M-Ant1-2440-PASS

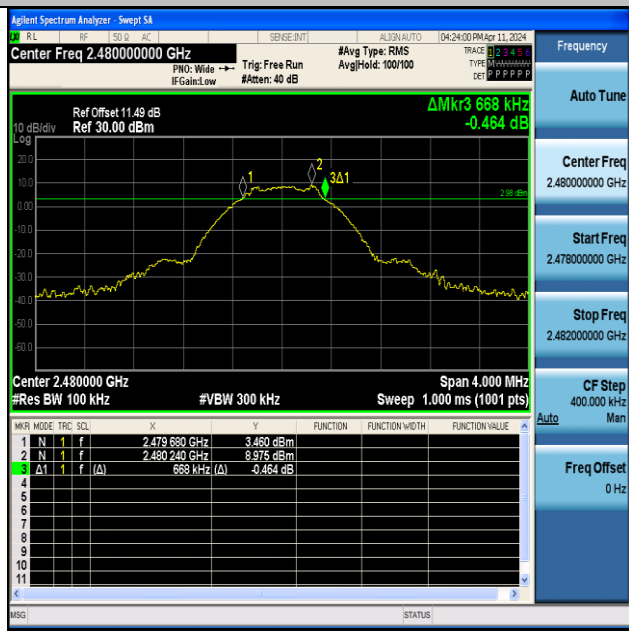

BLE_1M-Ant1-2480-PASS

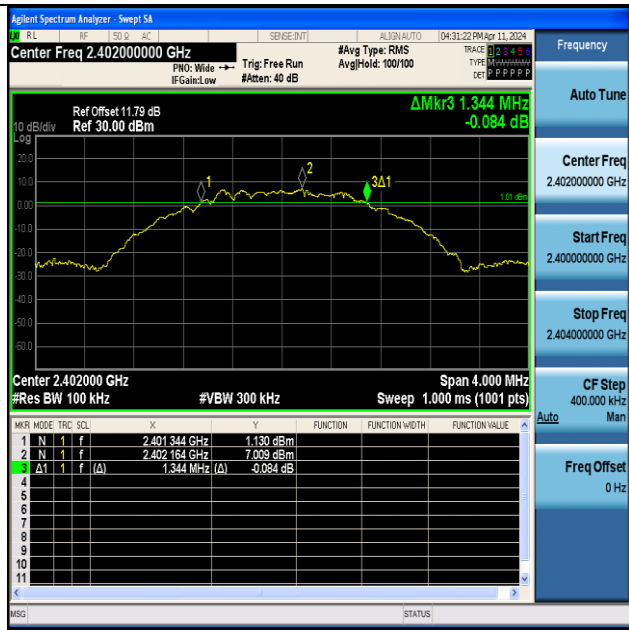

BLE_2M-Ant1-2402-PASS



BLE_2M-Ant1-2440-PASS

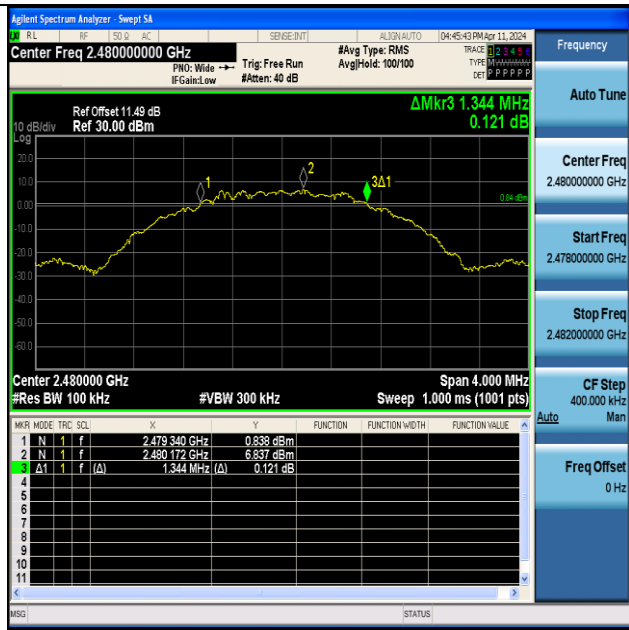

BLE_2M-Ant1-2480-PASS

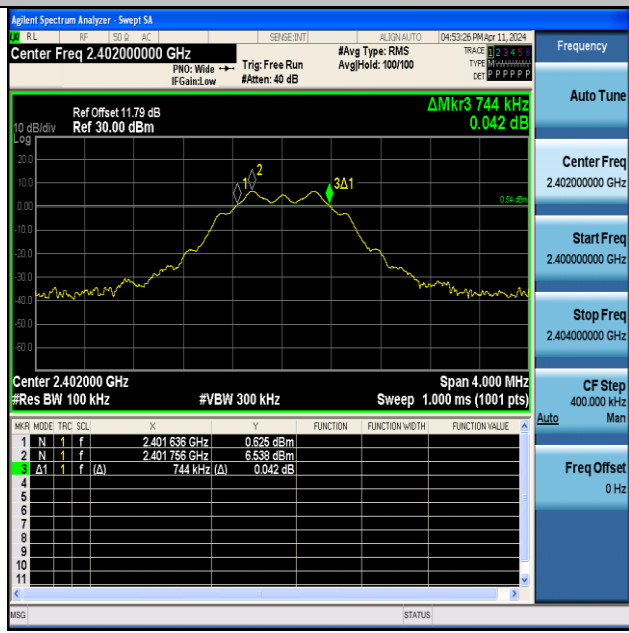

BLE_125K-Ant1-2402-PASS



BLE_125K-Ant1-2440-PASS



BLE_125K-Ant1-2480-PASS

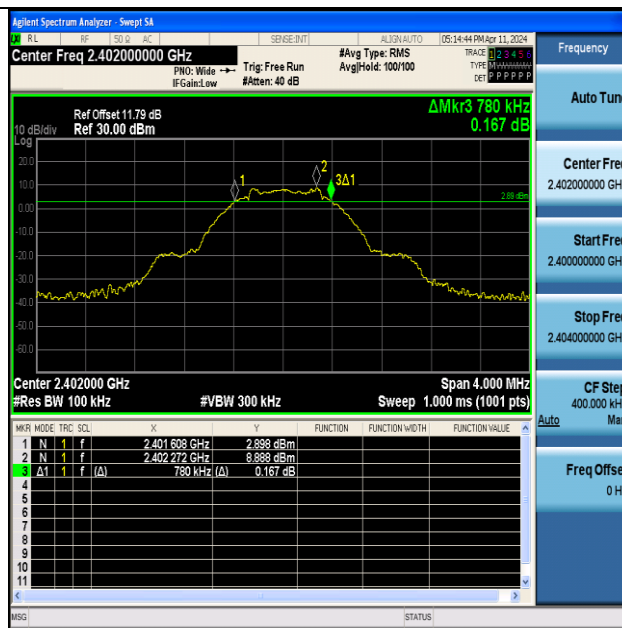

BLE_500K-Ant1-2402-PASS

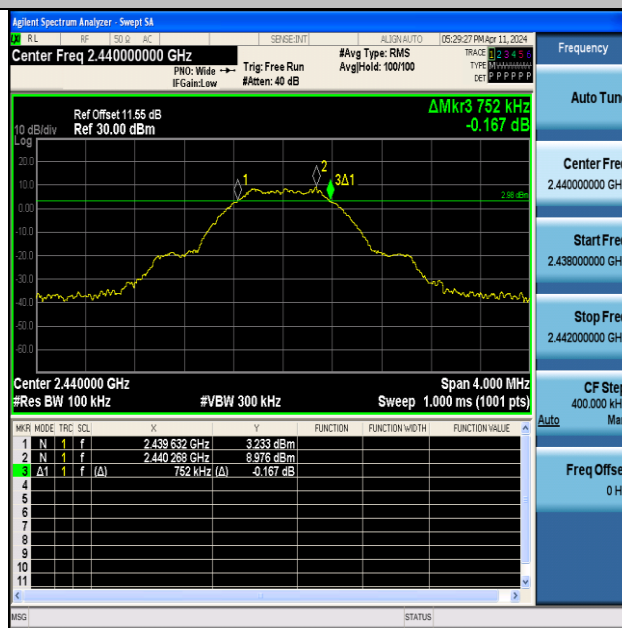

BLE_500K-Ant1-2440-PASS



BLE_500K-Ant1-2480-PASS

Appendix B: Occupied Channel Bandwidth

TestMode	Antenna	Frequency[MHz]	OCB [MHz]	FL[MHz]	FH[MHz]	Limit[MHz]	Verdict
BLE_1M	Ant1	2402	1.0365	2401.4940	2402.5305	N/A	Pass
BLE_1M	Ant1	2440	1.0373	2439.4928	2440.5301	N/A	Pass
BLE_1M	Ant1	2480	1.0375	2479.4924	2480.5299	N/A	Pass
BLE_2M	Ant1	2402	2.1171	2400.9663	2403.0834	N/A	Pass
BLE_2M	Ant1	2440	2.1205	2438.9642	2441.0847	N/A	Pass
BLE_2M	Ant1	2480	2.1259	2478.9614	2481.0873	N/A	Pass
BLE_125K	Ant1	2402	1.1222	2401.4465	2402.5687	N/A	Pass
BLE_125K	Ant1	2440	1.1234	2439.4466	2440.5700	N/A	Pass
BLE_125K	Ant1	2480	1.1203	2479.4494	2480.5697	N/A	Pass
BLE_500K	Ant1	2402	1.0964	2401.4615	2402.5579	N/A	Pass
BLE_500K	Ant1	2440	1.0909	2439.4653	2440.5562	N/A	Pass
BLE_500K	Ant1	2480	1.0925	2479.4638	2480.5563	N/A	Pass

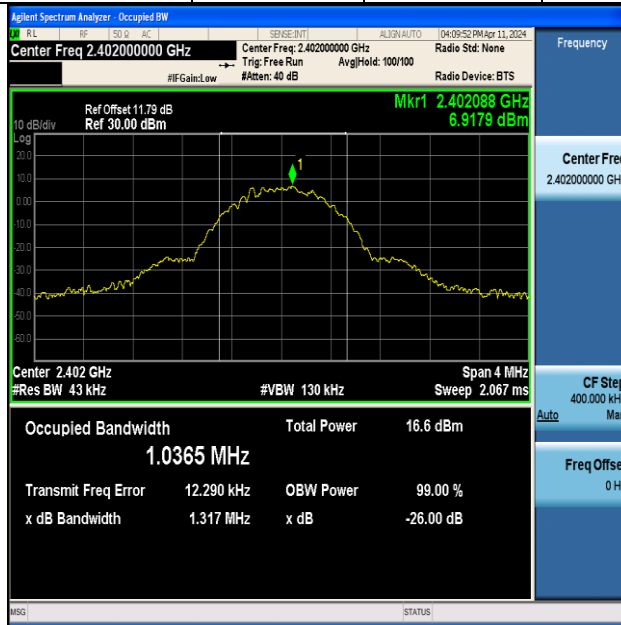

BLE_1M-Ant1-2402

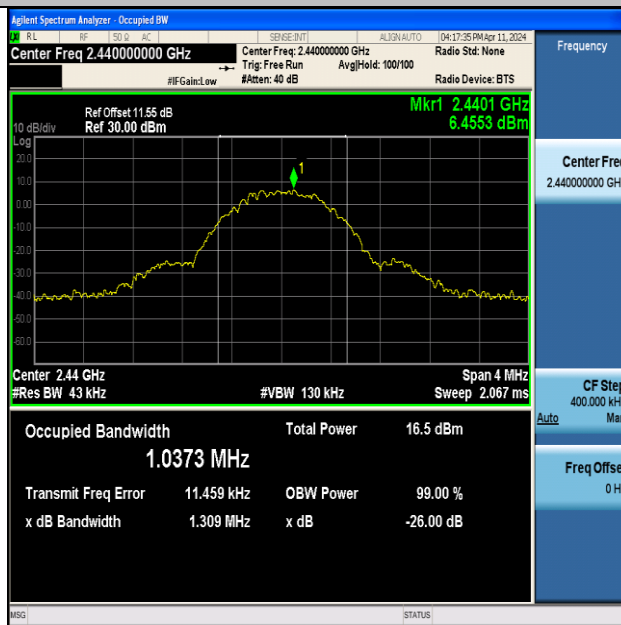

BLE_1M-Ant1-2440

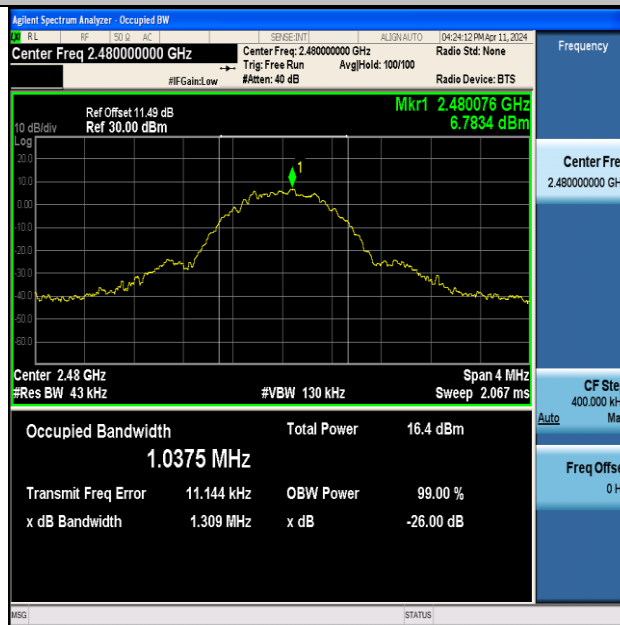

BLE_1M-Ant1-2480

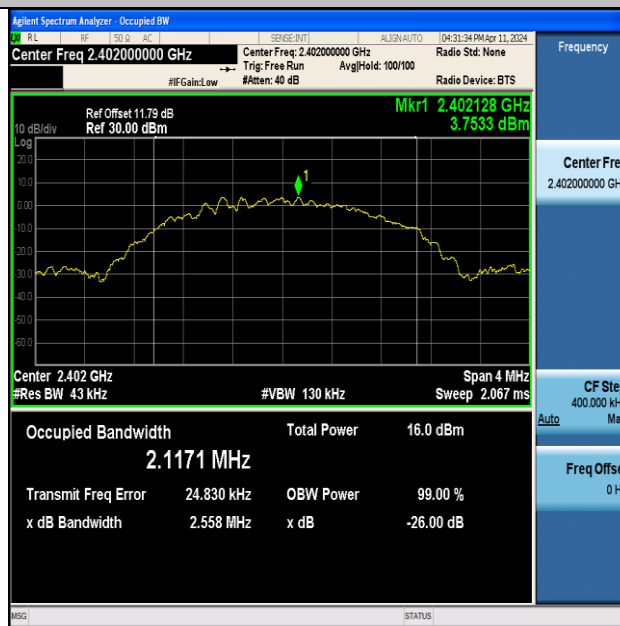

BLE_2M-Ant1-2402



BLE_2M-Ant1-2440



BLE_2M-Ant1-2480



BLE_125K-Ant1-2402



BLE_125K-Ant1-2440



BLE_125K-Ant1-2480

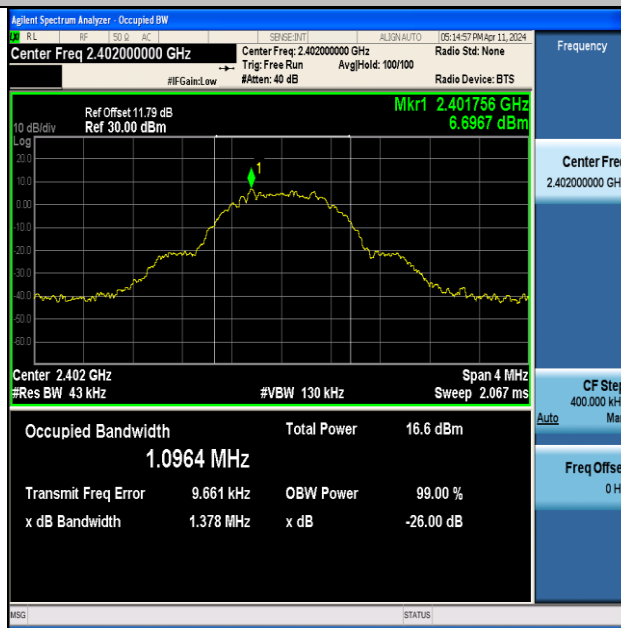

BLE_500K-Ant1-2402

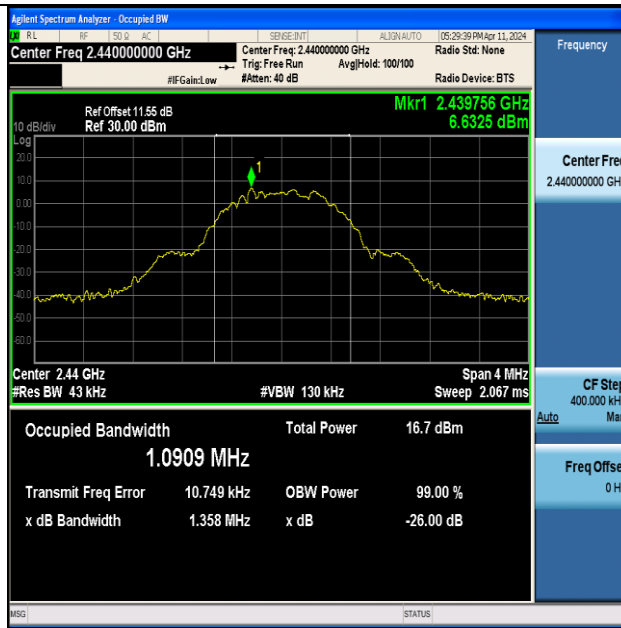

BLE_500K-Ant1-2440

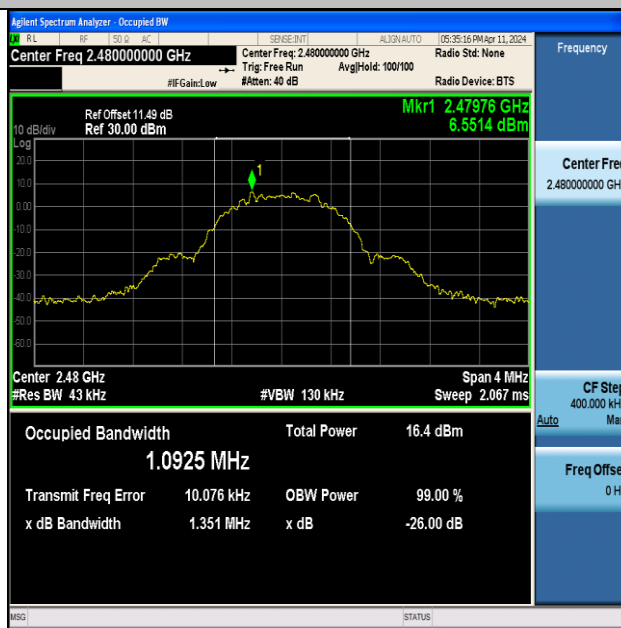

BLE_500K-Ant1-2480

Appendix C: Maximum conducted output power

Test Mode	Frequency (MHz)	Measured Power (dBm)	EIRP (dBm)	Conducted Limit[dBm]	EIRP Limit (dBm)
Mode1	2402	7.98	10.48	≤30	≤36
	2440	7.98	10.48	≤30	≤36
	2480	8.03	10.53	≤30	≤36
Mode2	2402	8.14	10.64	≤30	≤36
	2440	8.10	10.6	≤30	≤36
	2480	8.16	10.66	≤30	≤36
Mode3	2402	8.03	10.53	≤30	≤36
	2440	8.16	10.66	≤30	≤36
	2480	8.24	10.74	≤30	≤36
Mode4	2402	8.00	10.5	≤30	≤36
	2440	8.09	10.59	≤30	≤36
	2480	8.23	10.73	≤30	≤36
Note 1: EIRP=Measured power+Antenna gain					
Note 2: The antenna gain please refer to clause 1.2					

Appendix D: Maximum power spectral density

TestMode	Antenna	Frequency[MHz]	Result[dBm/3kHz]	Limit[dBm/3kHz]	Verdict
BLE_1M	Ant1	2402	-7.12	≤8.00	PASS
BLE_1M	Ant1	2440	-7.04	≤8.00	PASS
BLE_1M	Ant1	2480	-6.89	≤8.00	PASS
BLE_2M	Ant1	2402	-9.48	≤8.00	PASS
BLE_2M	Ant1	2440	-9.47	≤8.00	PASS
BLE_2M	Ant1	2480	-9.35	≤8.00	PASS
BLE_125K	Ant1	2402	2.62	≤8.00	PASS
BLE_125K	Ant1	2440	2.65	≤8.00	PASS
BLE_125K	Ant1	2480	2.74	≤8.00	PASS
BLE_500K	Ant1	2402	-9.39	≤8.00	PASS
BLE_500K	Ant1	2440	-9.28	≤8.00	PASS
BLE_500K	Ant1	2480	-9.16	≤8.00	PASS

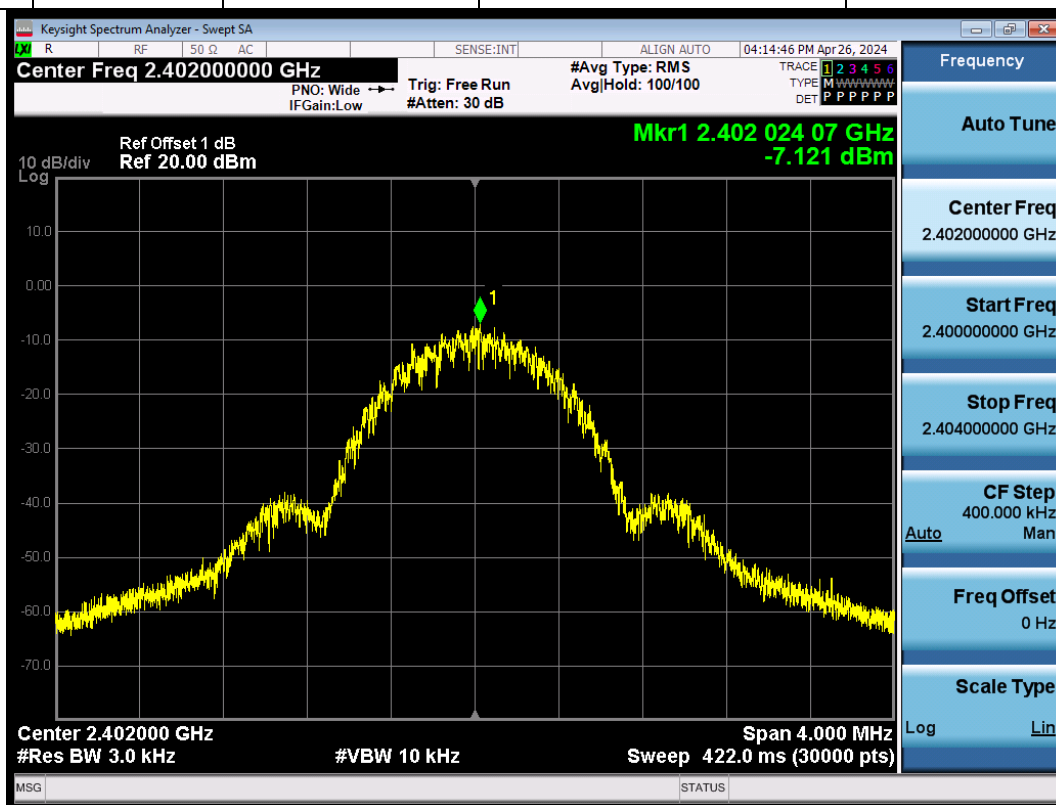

BLE_1M-Ant1-2402-PASS

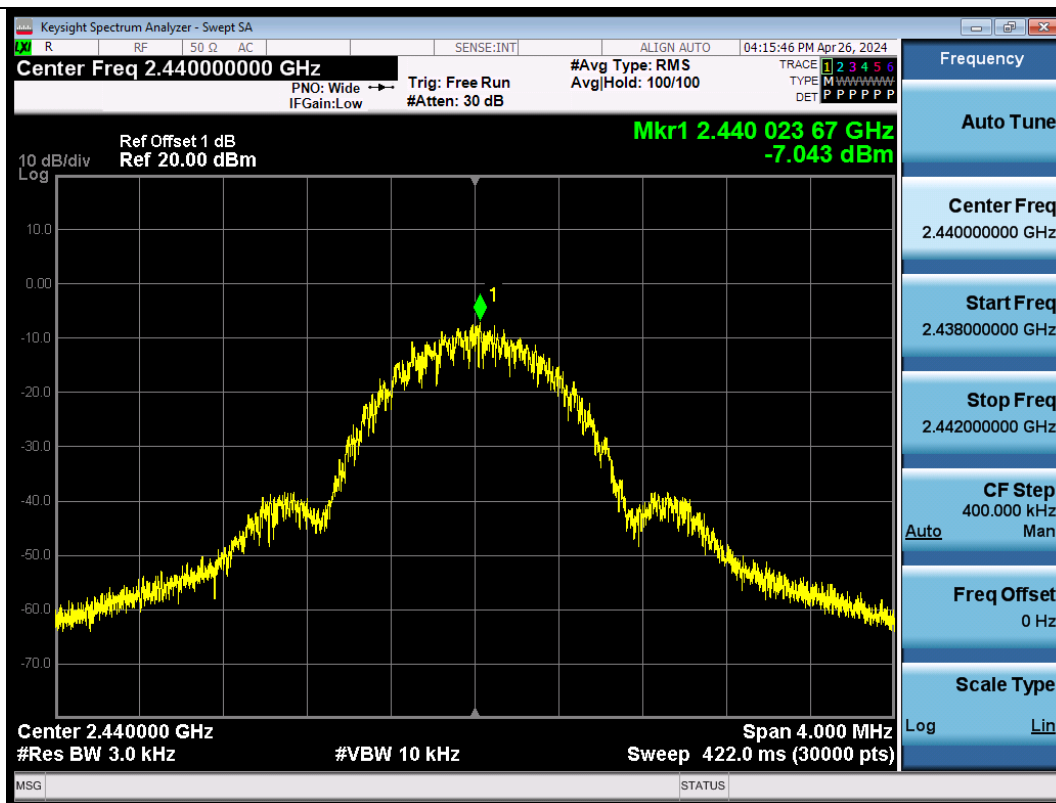

BLE_1M-Ant1-2440-PASS

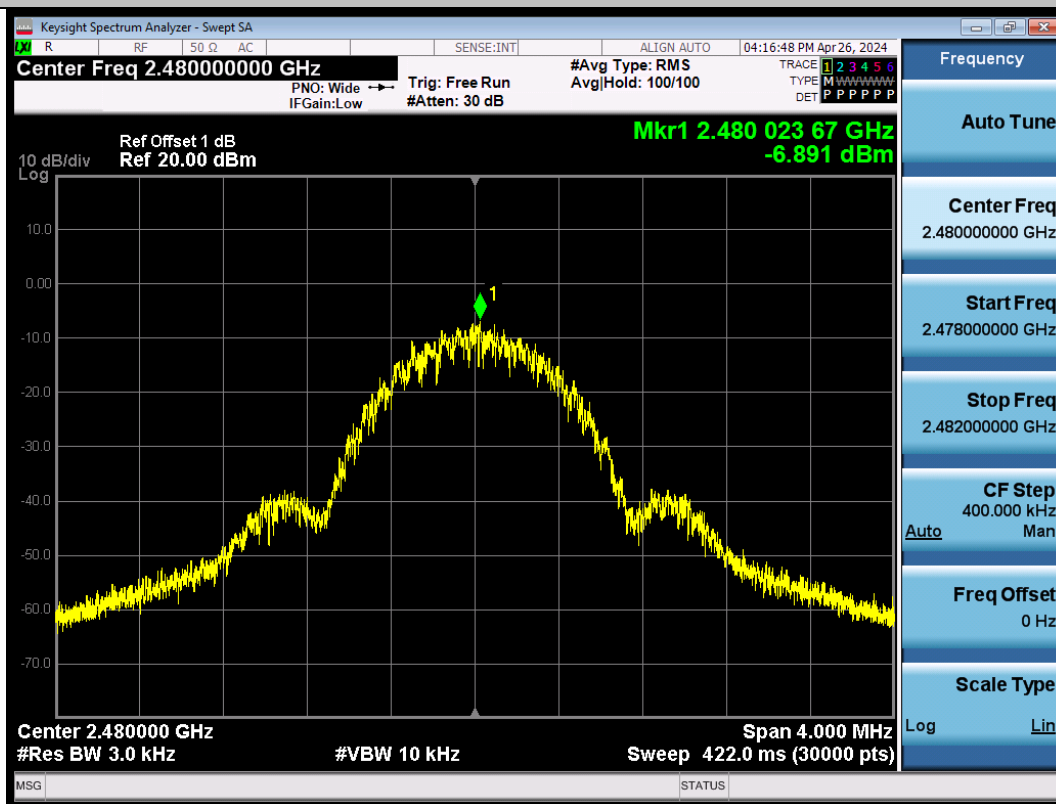

BLE_1M-Ant1-2480-PASS

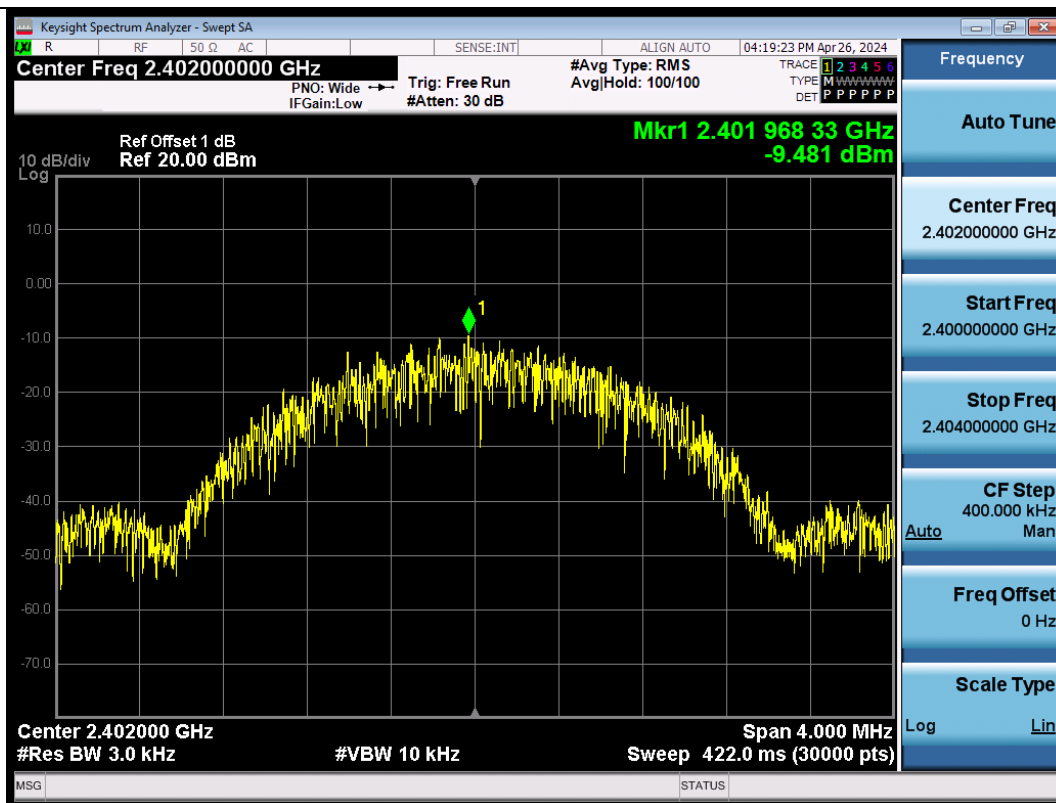

BLE_2M-Ant1-2402-PASS

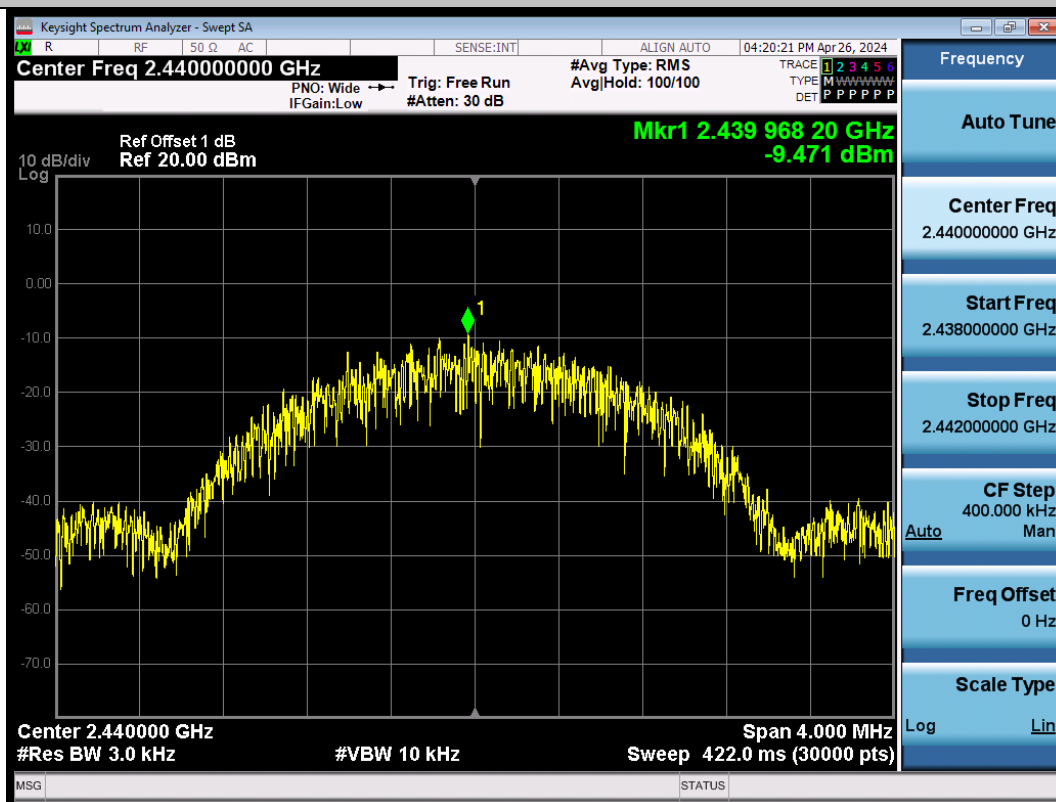

BLE_2M-Ant1-2440-PASS

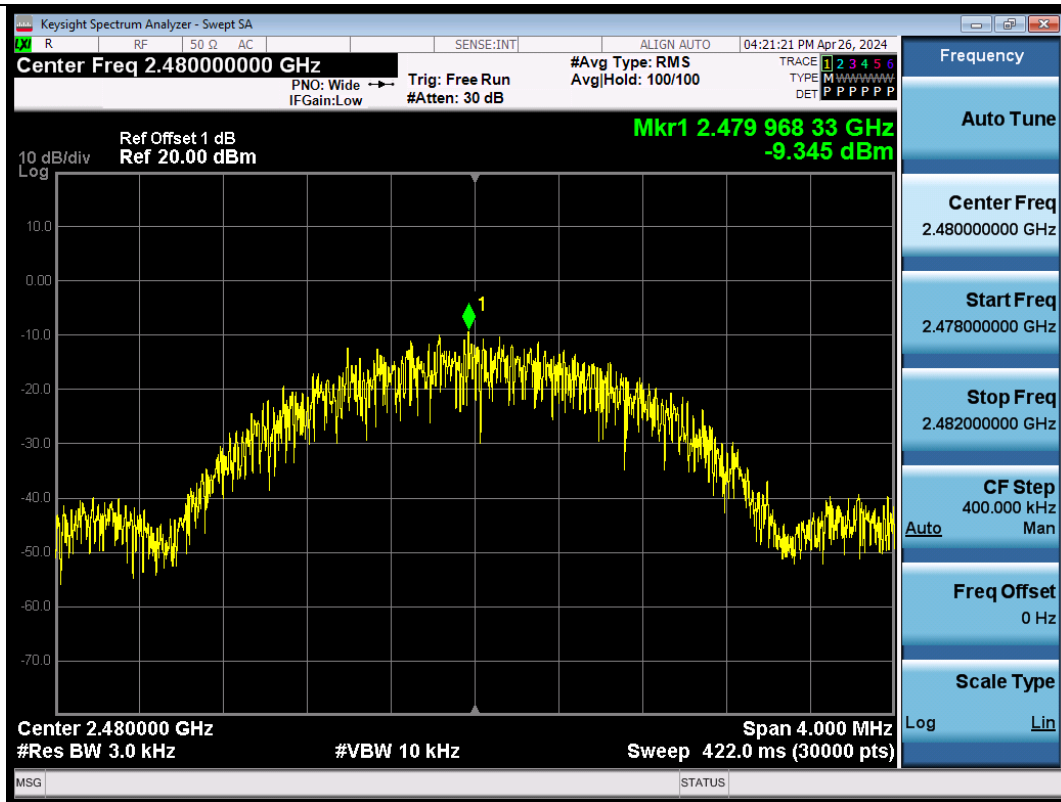

BLE_2M-Ant1-2480-PASS

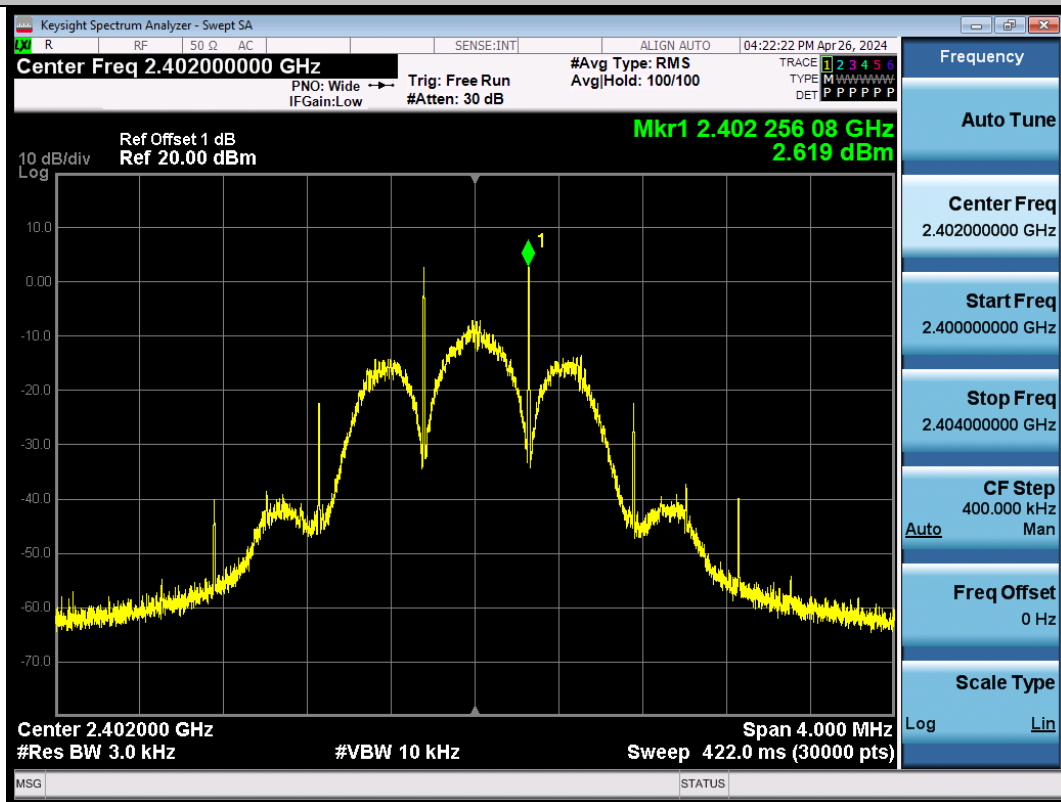

BLE_125K-Ant1-2402-PASS

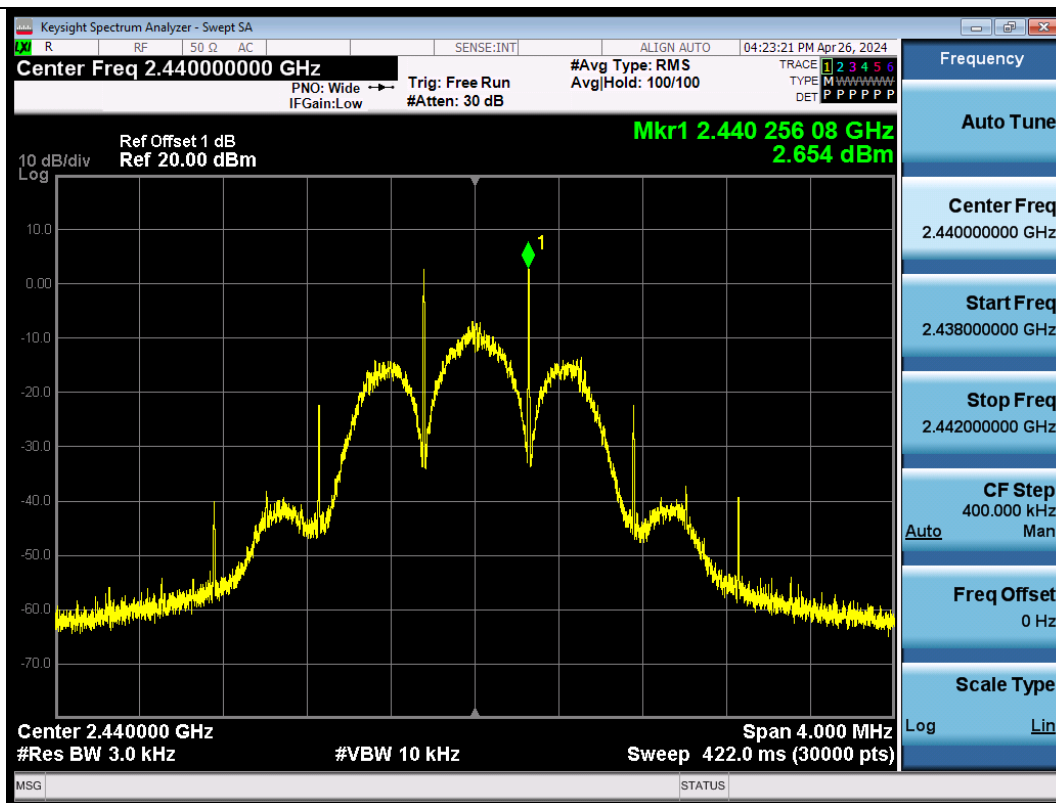

BLE_125K-Ant1-2440-PASS

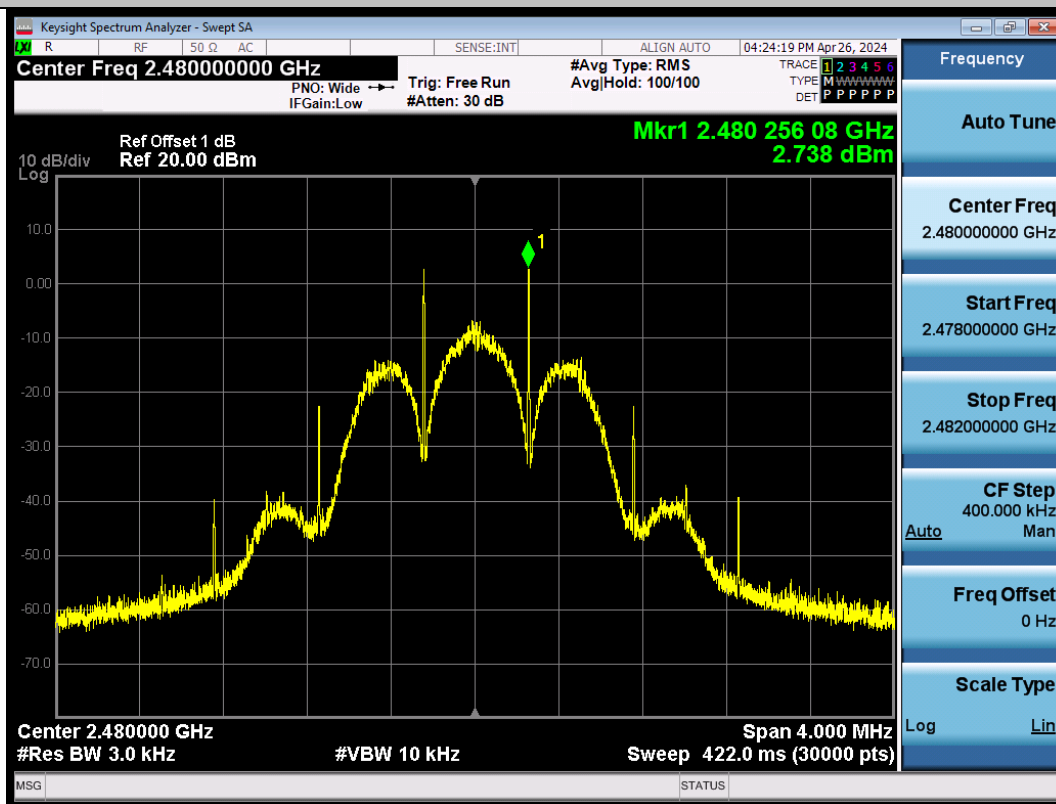

BLE_125K-Ant1-2480-PASS

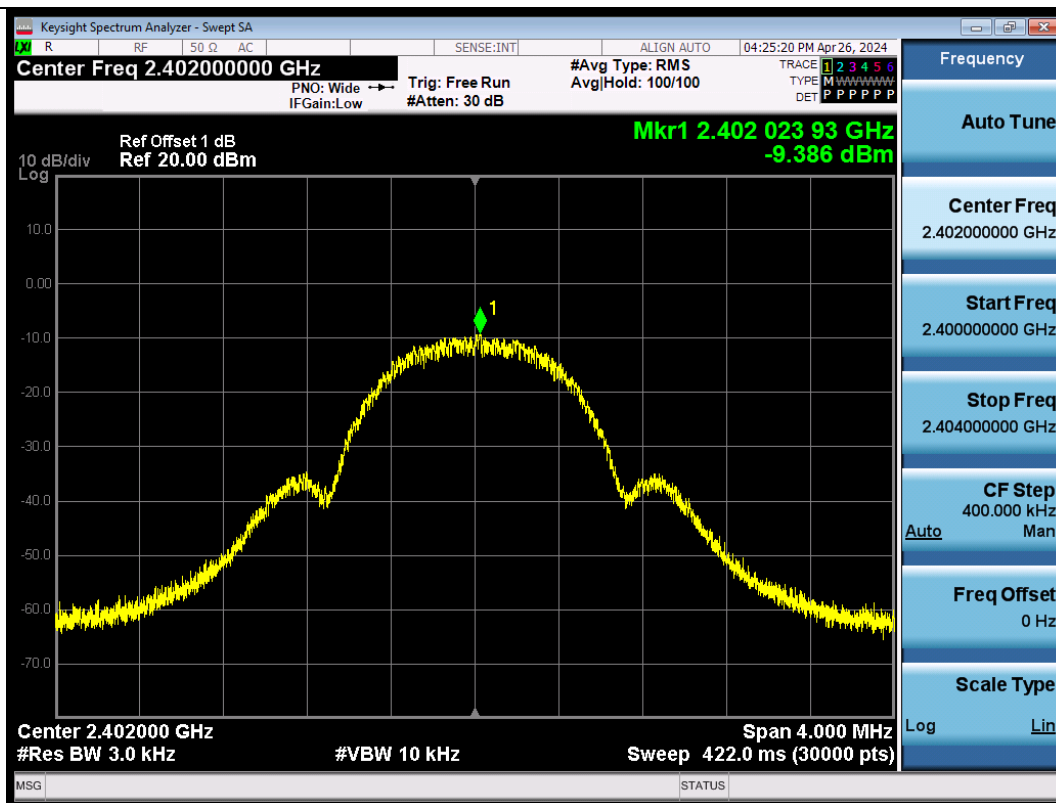

BLE_500K-Ant1-2402-PASS

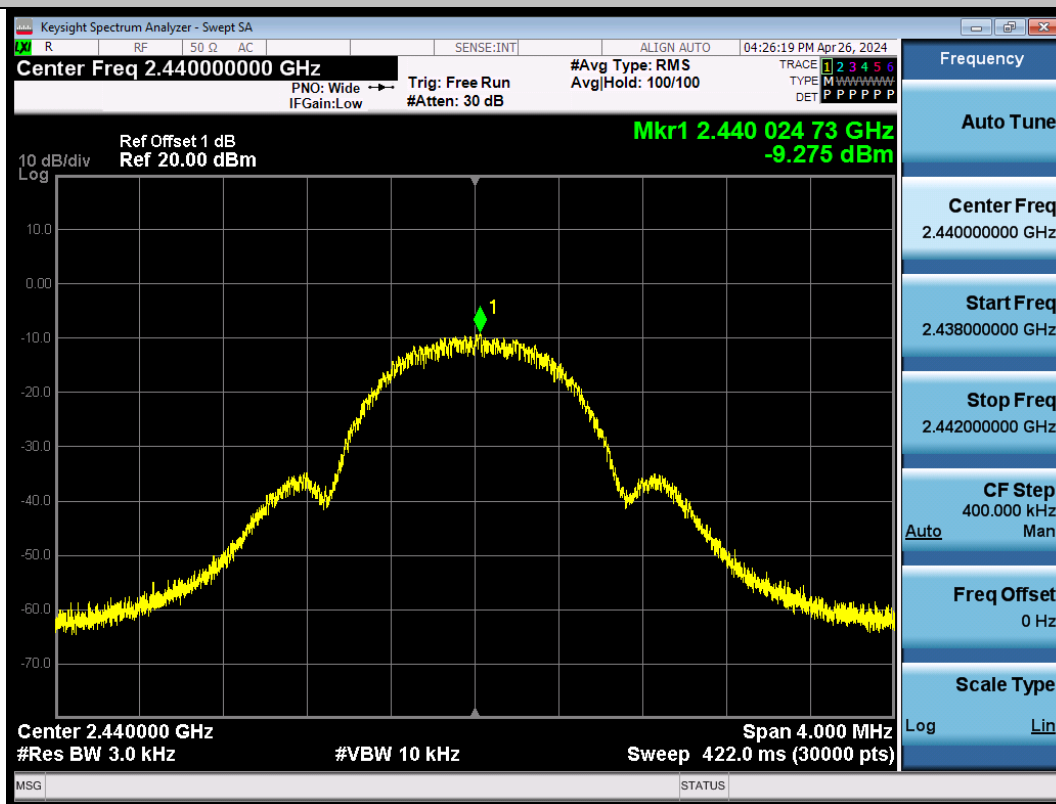

BLE_500K-Ant1-2440-PASS

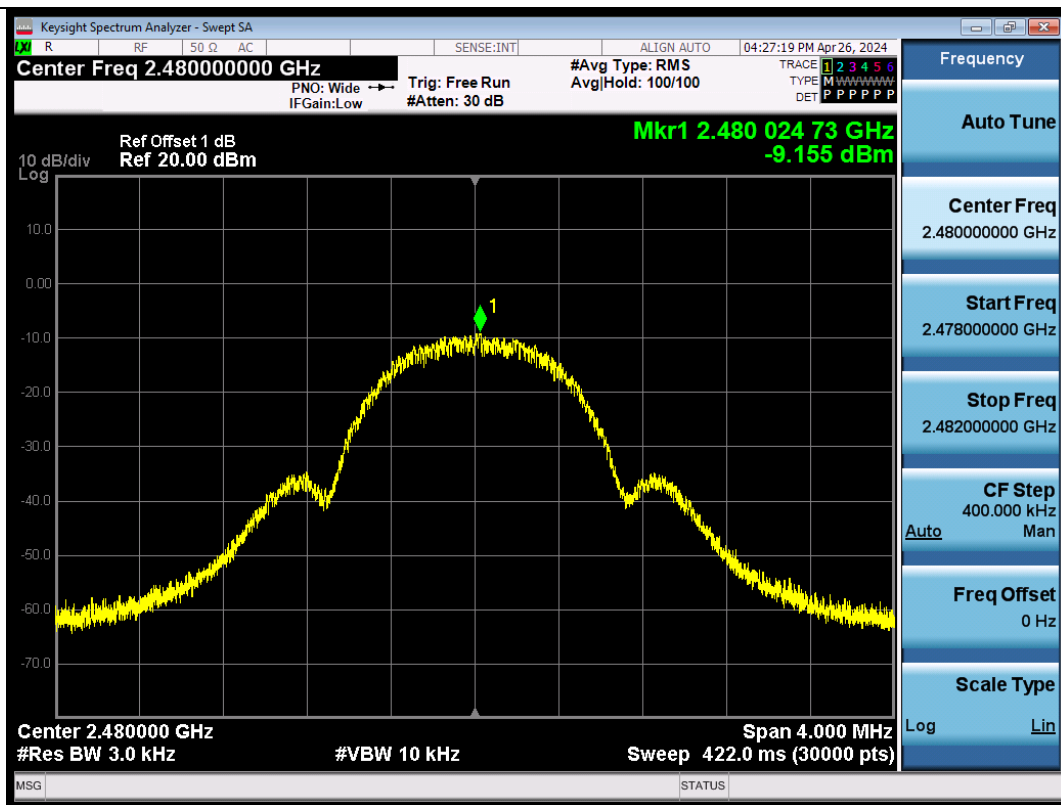

BLE_500K-Ant1-2480-PASS

Appendix E: Band edge measurements

Profile: 2430175R	Page No.: 1
Engineer: Pengchengyang	
Site: AC5	Time: 2024/04/10 - 09:05
Limit: FCC_Part15.209_RE(3m)	Margin: 0
Probe: Horn_3117_00167055(1-18GHz)	Polarity: Horizontal
EUT: LED lamp	Power: AC 120V/60Hz
Note: Mode 1 : Transmit at 2402MHz by LE_1Mbps	

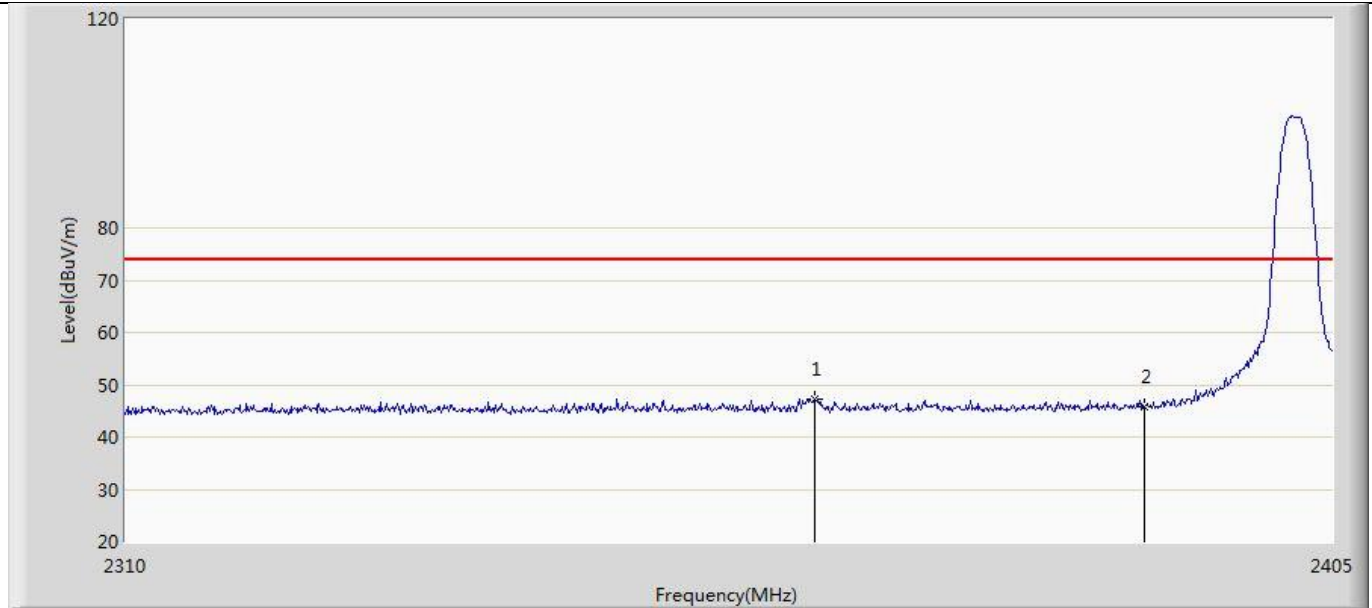

No	Mark	Frequency (MHz)	Measure Level (dBuV/m)	Reading Level (dBuV)	Over Limit (dB)	Limit (dBuV/m)	Factor (dB)	Type
1	*	2363.770	47.206	13.199	-26.794	74.000	34.007	PK
2		2390.000	45.938	11.787	-28.062	74.000	34.151	PK

Profile: 2430175R	Page No.: 2
Engineer: Pengchengyang	
Site: AC5	Time: 2024/04/10 - 09:06
Limit: FCC_Part15.209_RE(3m)	Margin: 0
Probe: Horn_3117_00167055(1-18GHz)	Polarity: Horizontal
EUT: LED lamp	Power: AC 120V/60Hz
Note: Mode 1 : Transmit at 2402MHz by LE_1Mbps	

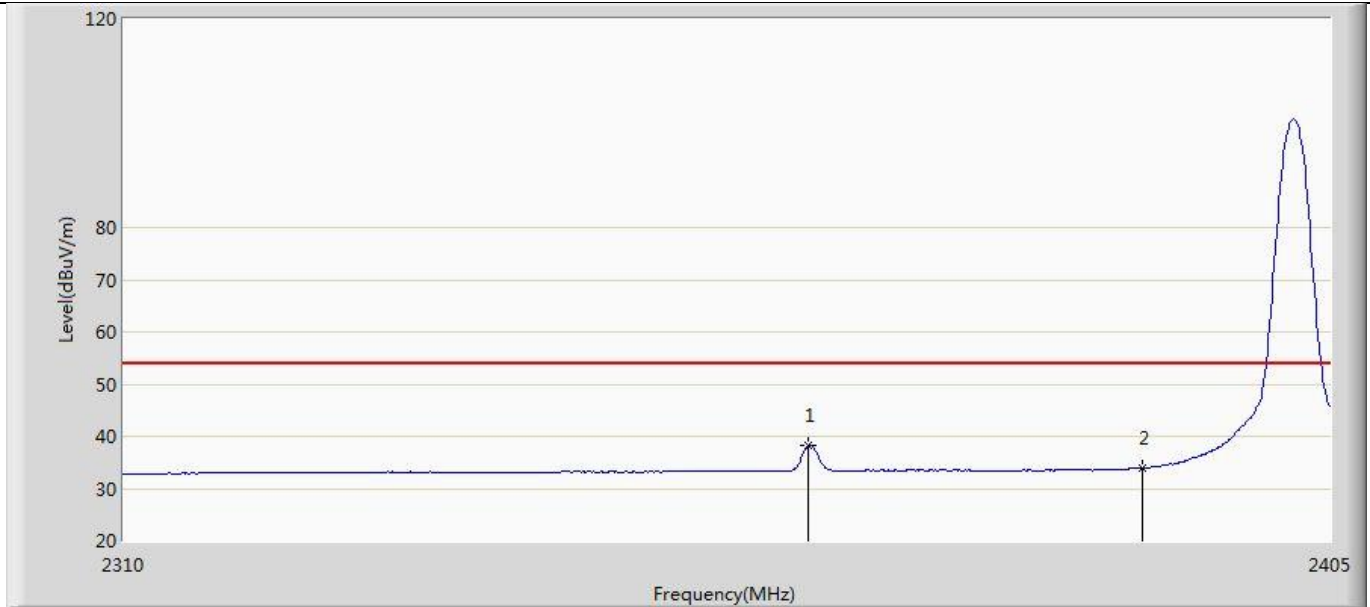

No	Mark	Frequency (MHz)	Measure Level (dBuV/m)	Reading Level (dBuV)	Over Limit (dB)	Limit (dBuV/m)	Factor (dB)	Type
1	*	2363.485	38.190	4.185	-15.810	54.000	34.005	AV
2		2390.000	33.917	-0.234	-20.083	54.000	34.151	AV

Profile: 2430175R	Page No.: 3
Engineer: Pengchengyang	
Site: AC5	Time: 2024/04/10 - 09:07
Limit: FCC_Part15.209_RE(3m)	Margin: 0
Probe: Horn_3117_00167055(1-18GHz)	Polarity: Vertical
EUT: LED lamp	Power: AC 120V/60Hz
Note: Mode 1 : Transmit at 2402MHz by LE_1Mbps	

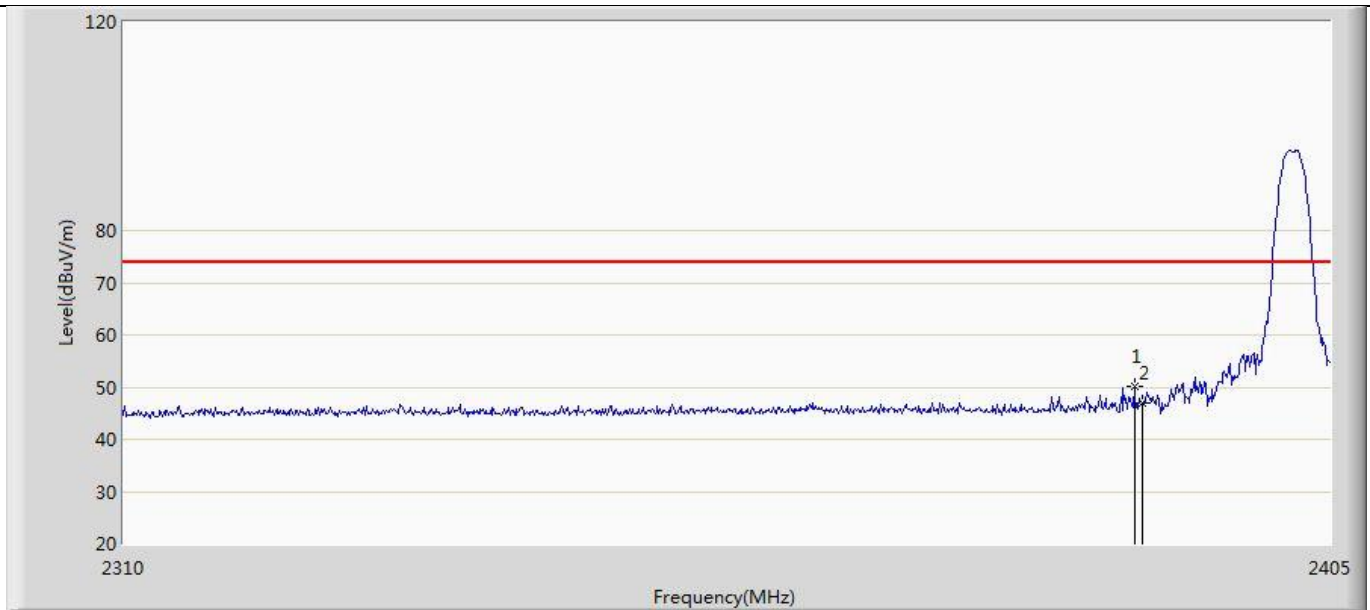

No	Mark	Frequency (MHz)	Measure Level (dBuV/m)	Reading Level (dBuV)	Over Limit (dB)	Limit (dBuV/m)	Factor (dB)	Type
1	*	2389.325	50.128	15.980	-23.872	74.000	34.148	PK
2		2390.000	47.046	12.895	-26.954	74.000	34.151	PK

Profile: 2430175R	Page No.: 4
Engineer: Pengchengyang	
Site: AC5	Time: 2024/04/10 - 09:08
Limit: FCC_Part15.209_RE(3m)	Margin: 0
Probe: Horn_3117_00167055(1-18GHz)	Polarity: Vertical
EUT: LED lamp	Power: AC 120V/60Hz
Note: Mode 1 : Transmit at 2402MHz by LE_1Mbps	

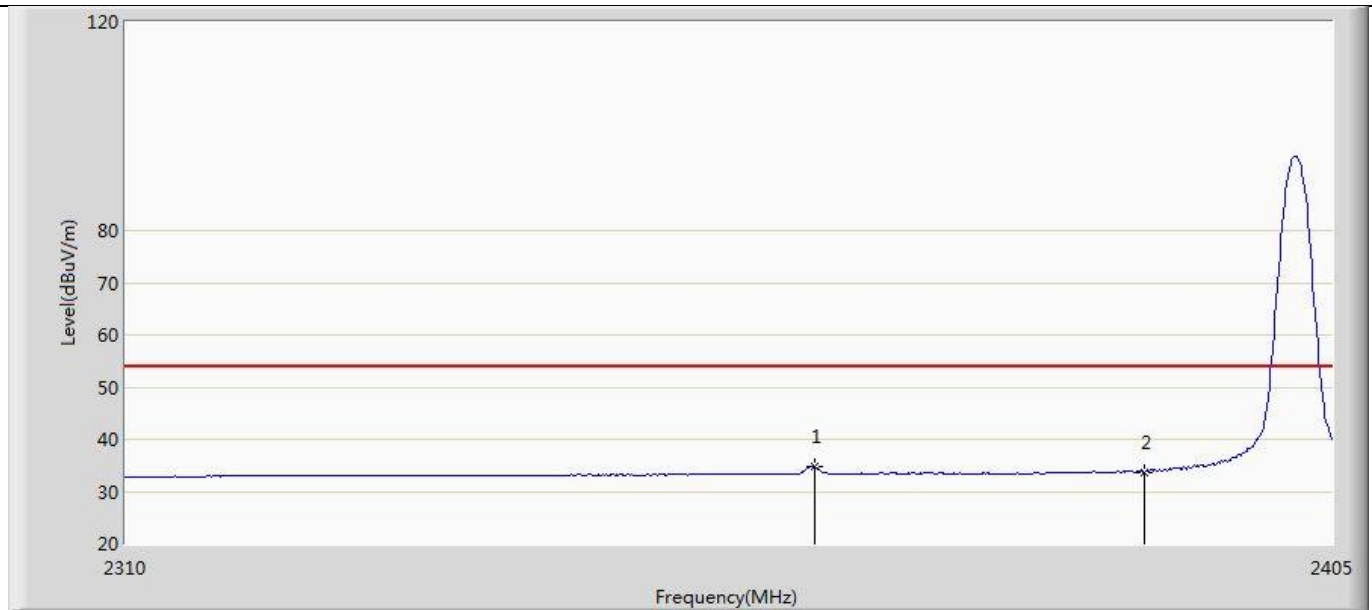

No	Mark	Frequency (MHz)	Measure Level (dBuV/m)	Reading Level (dBuV)	Over Limit (dB)	Limit (dBuV/m)	Factor (dB)	Type
1	*	2363.770	34.783	0.776	-19.217	54.000	34.007	AV
2		2390.000	33.727	-0.424	-20.273	54.000	34.151	AV

Profile: 2430175R	Page No.: 5
Engineer: Pengchengyang	
Site: AC5	Time: 2024/04/10 - 09:09
Limit: FCC_Part15.209_RE(3m)	Margin: 0
Probe: Horn_3117_00167055(1-18GHz)	Polarity: Horizontal
EUT: LED lamp	Power: AC 120V/60Hz
Note: Mode 1 : Transmit at 2480MHz by LE_1Mbps	

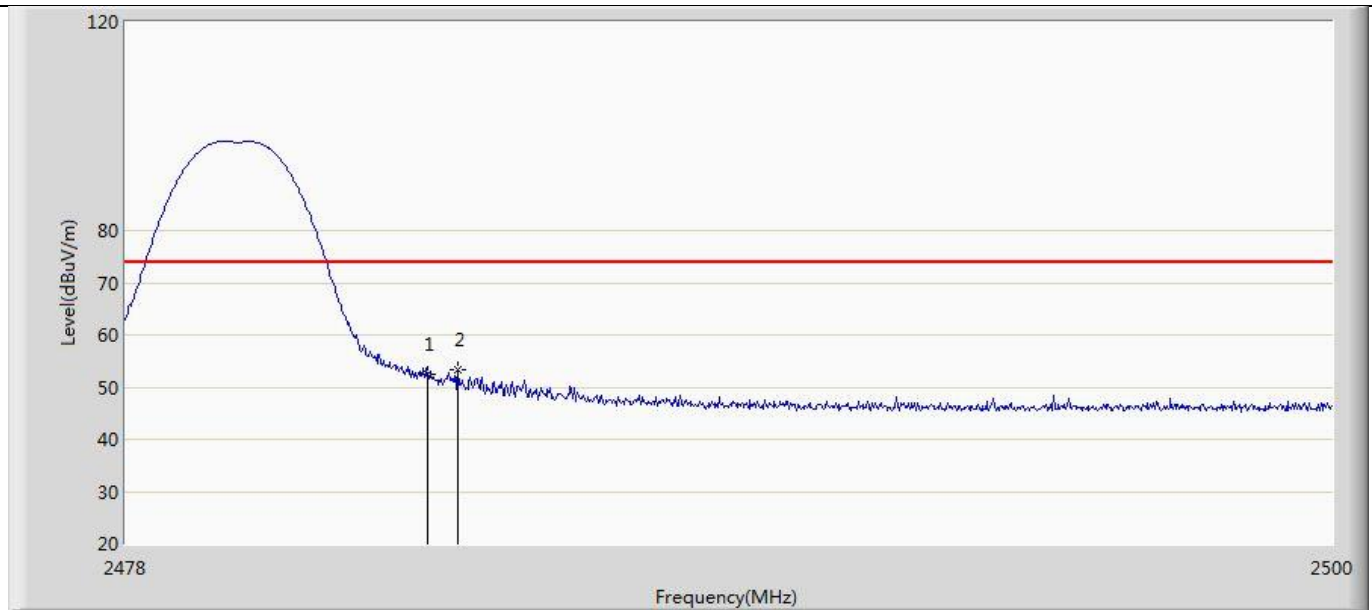

No	Mark	Frequency (MHz)	Measure Level (dBuV/m)	Reading Level (dBuV)	Over Limit (dB)	Limit (dBuV/m)	Factor (dB)	Type
1		2483.500	52.578	18.122	-21.422	74.000	34.456	PK
2	*	2484.050	53.254	18.792	-20.746	74.000	34.462	PK

Profile: 2430175R	Page No.: 6
Engineer: Pengchengyang	
Site: AC5	Time: 2024/04/10 - 09:11
Limit: FCC_Part15.209_RE(3m)	Margin: 0
Probe: Horn_3117_00167055(1-18GHz)	Polarity: Horizontal
EUT: LED lamp	Power: AC 120V/60Hz
Note: Mode 1 : Transmit at 2480MHz by LE_1Mbps	

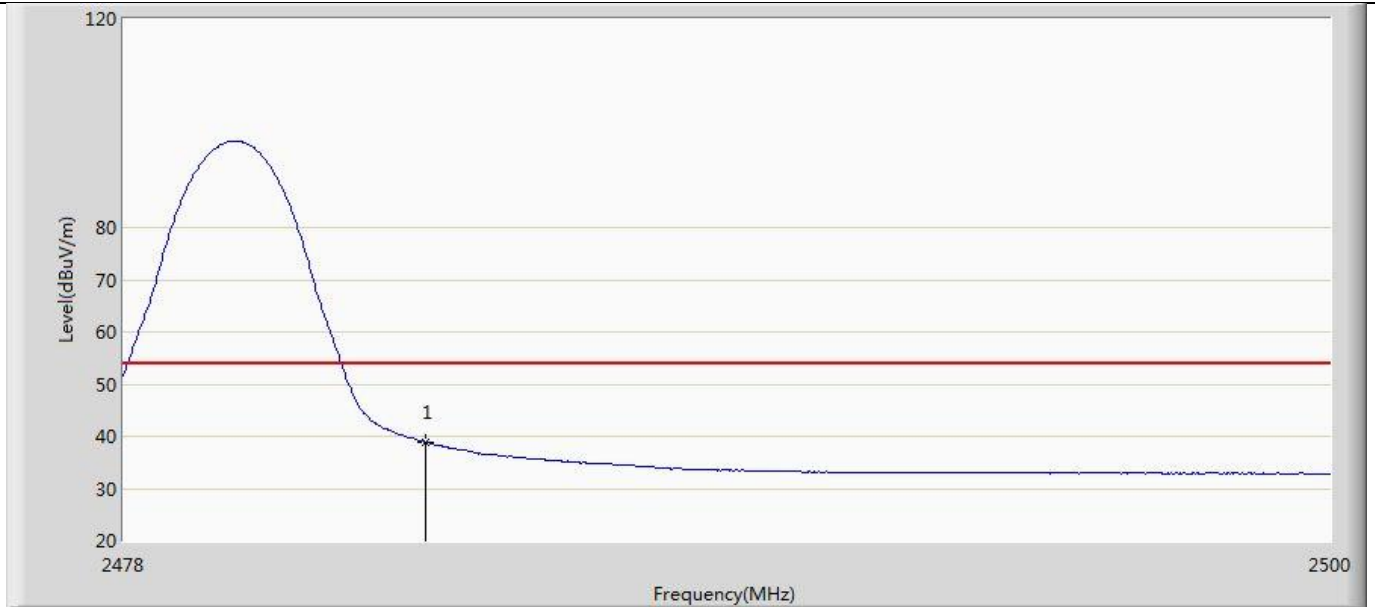

No	Mark	Frequency (MHz)	Measure Level (dBuV/m)	Reading Level (dBuV)	Over Limit (dB)	Limit (dBuV/m)	Factor (dB)	Type
1	*	2483.500	38.928	4.472	-15.072	54.000	34.456	AV

Profile: 2430175R	Page No.: 7
Engineer: Pengchengyang	
Site: AC5	Time: 2024/04/10 - 09:12
Limit: FCC_Part15.209_RE(3m)	Margin: 0
Probe: Horn_3117_00167055(1-18GHz)	Polarity: Vertical
EUT: LED lamp	Power: AC 120V/60Hz
Note: Mode 1 : Transmit at 2480MHz by LE_1Mbps	

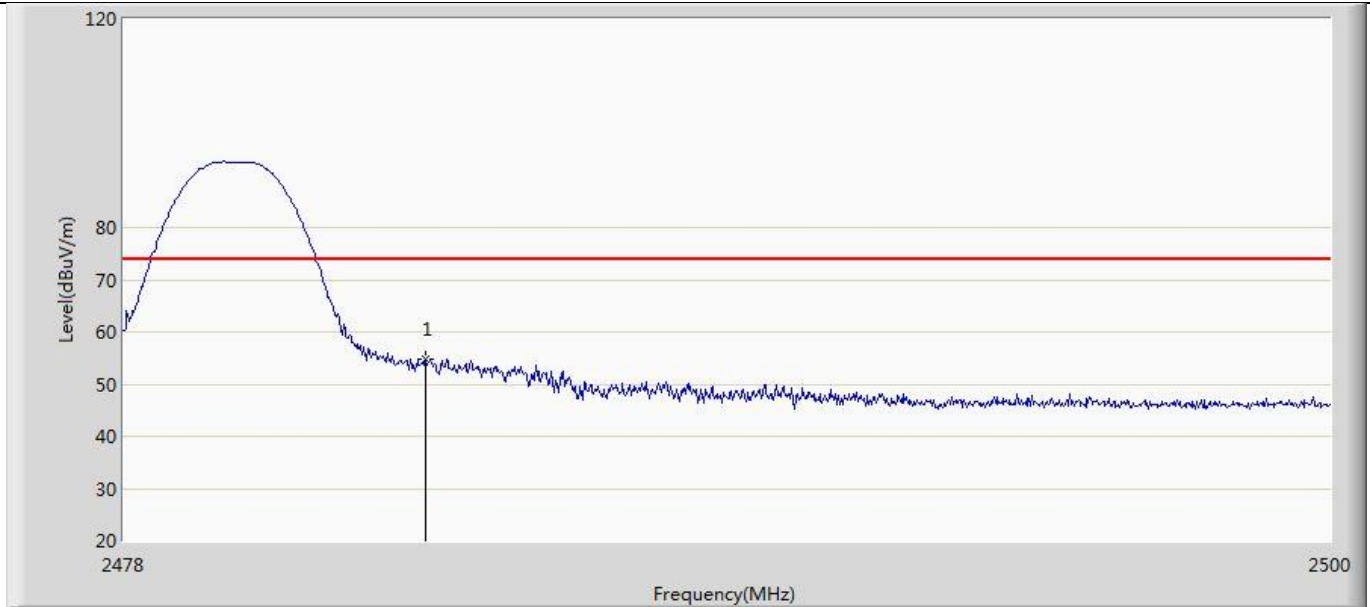

No	Mark	Frequency (MHz)	Measure Level (dBuV/m)	Reading Level (dBuV)	Over Limit (dB)	Limit (dBuV/m)	Factor (dB)	Type
1	*	2483.500	54.688	20.232	-19.312	74.000	34.456	PK

Profile: 2430175R	Page No.: 8
Engineer: Pengchengyang	
Site: AC5	Time: 2024/04/10 - 09:13
Limit: FCC_Part15.209_RE(3m)	Margin: 0
Probe: Horn_3117_00167055(1-18GHz)	Polarity: Vertical
EUT: LED lamp	Power: AC 120V/60Hz
Note: Mode 1 : Transmit at 2480MHz by LE_1Mbps	

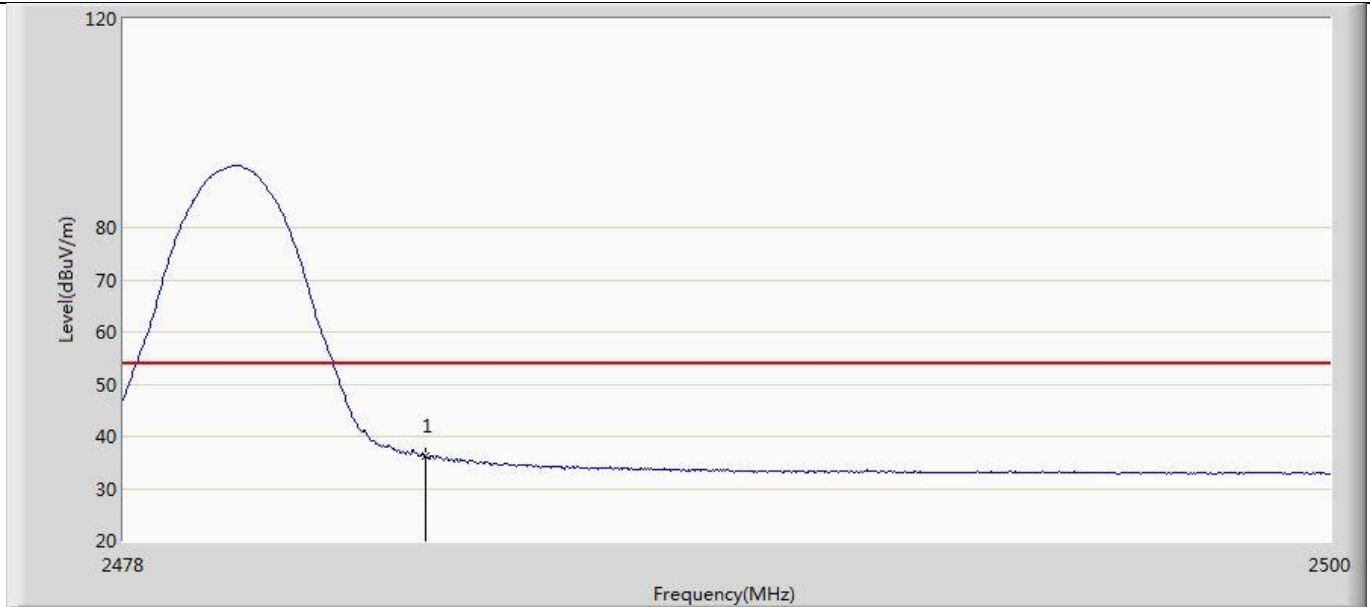

No	Mark	Frequency (MHz)	Measure Level (dBuV/m)	Reading Level (dBuV)	Over Limit (dB)	Limit (dBuV/m)	Factor (dB)	Type
1	*	2483.500	36.113	1.657	-17.887	54.000	34.456	AV

Profile: 2430175R	Page No.: 9
Engineer: Pengchengyang	
Site: AC5	Time: 2024/04/10 - 09:15
Limit: FCC_Part15.209_RE(3m)	Margin: 0
Probe: Horn_3117_00167055(1-18GHz)	Polarity: Horizontal
EUT: LED lamp	Power: AC 120V/60Hz
Note: Mode 2 : Transmit at 2402MHz by LE_2Mbps	

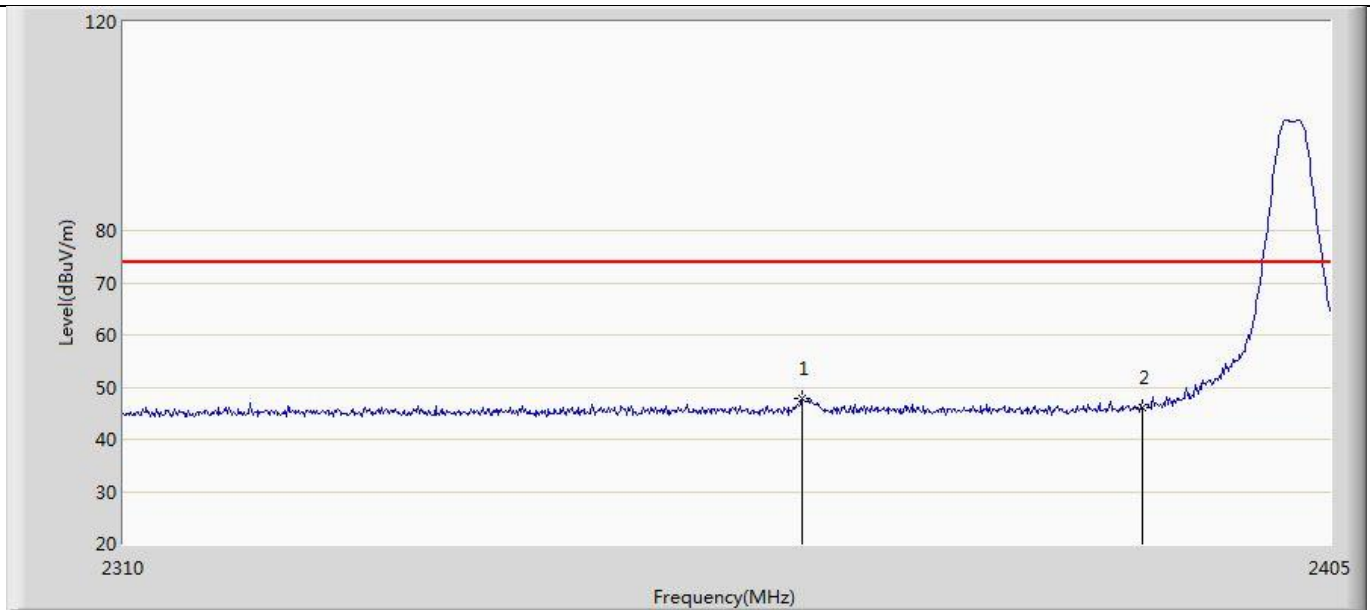

No	Mark	Frequency (MHz)	Measure Level (dBuV/m)	Reading Level (dBuV)	Over Limit (dB)	Limit (dBuV/m)	Factor (dB)	Type
1	*	2363.010	47.865	13.863	-26.135	74.000	34.002	PK
2		2390.000	46.067	11.916	-27.933	74.000	34.151	PK

Profile: 2430175R	Page No.: 10
Engineer: Pengchengyang	
Site: AC5	Time: 2024/04/10 - 09:16
Limit: FCC_Part15.209_RE(3m)	Margin: 0
Probe: Horn_3117_00167055(1-18GHz)	Polarity: Horizontal
EUT: LED lamp	Power: AC 120V/60Hz
Note: Mode 2 : Transmit at 2402MHz by LE_2Mbps	

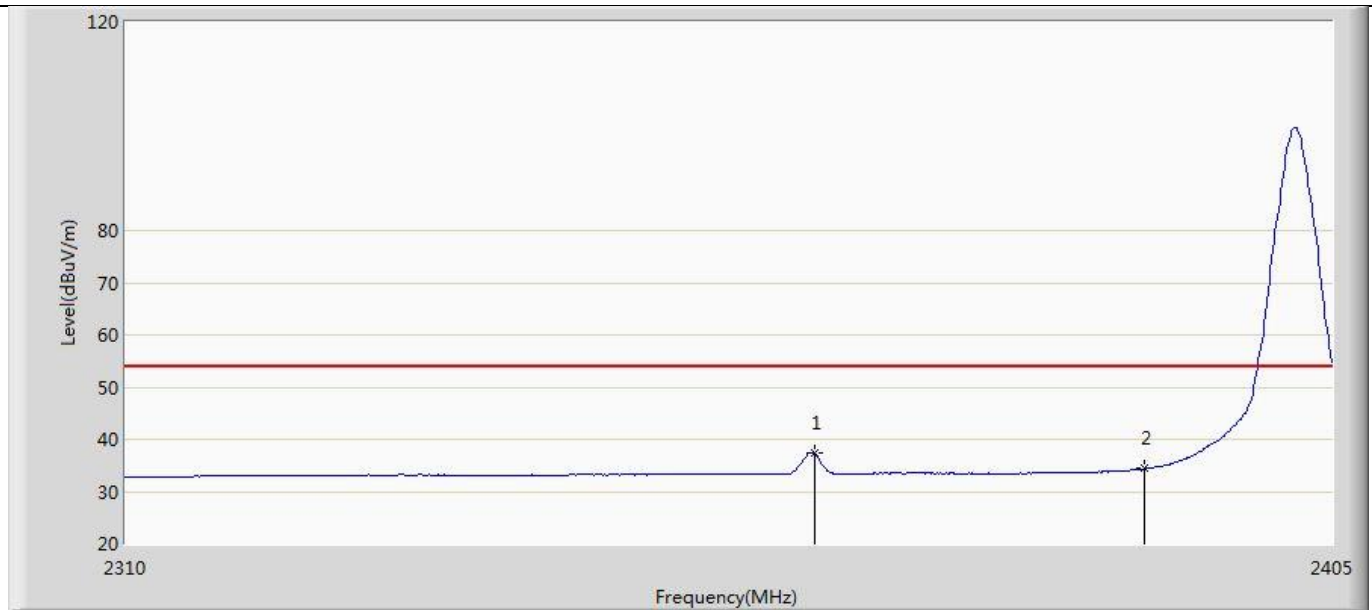

No	Mark	Frequency (MHz)	Measure Level (dBuV/m)	Reading Level (dBuV)	Over Limit (dB)	Limit (dBuV/m)	Factor (dB)	Type
1	*	2363.770	37.276	3.269	-16.724	54.000	34.007	AV
2		2390.000	34.359	0.208	-19.641	54.000	34.151	AV

Profile: 2430175R	Page No.: 11
Engineer: Pengchengyang	
Site: AC5	Time: 2024/04/10 - 09:18
Limit: FCC_Part15.209_RE(3m)	Margin: 0
Probe: Horn_3117_00167055(1-18GHz)	Polarity: Vertical
EUT: LED lamp	Power: AC 120V/60Hz
Note: Mode 2 : Transmit at 2402MHz by LE_2Mbps	

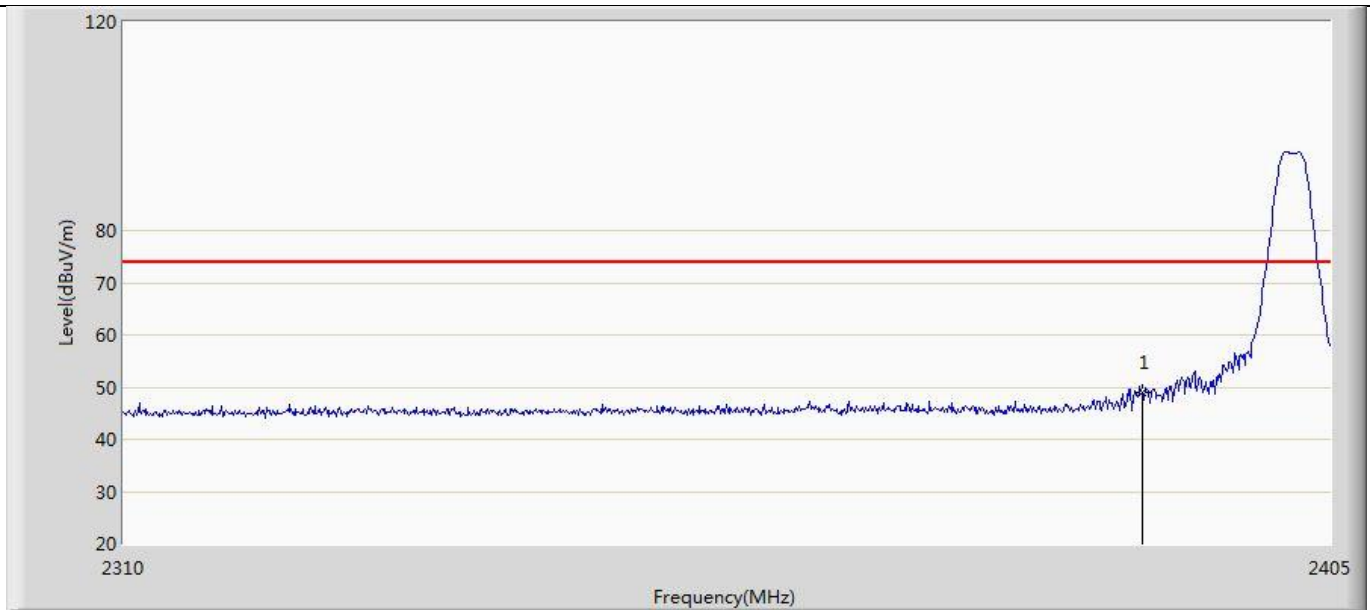

No	Mark	Frequency (MHz)	Measure Level (dBuV/m)	Reading Level (dBuV)	Over Limit (dB)	Limit (dBuV/m)	Factor (dB)	Type
1	*	2390.000	48.868	14.717	-25.132	74.000	34.151	PK

Profile: 2430175R	Page No.: 12
Engineer: Pengchengyang	
Site: AC5	Time: 2024/04/10 - 09:19
Limit: FCC_Part15.209_RE(3m)	Margin: 0
Probe: Horn_3117_00167055(1-18GHz)	Polarity: Vertical
EUT: LED lamp	Power: AC 120V/60Hz
Note: Mode 2 : Transmit at 2402MHz by LE_2Mbps	

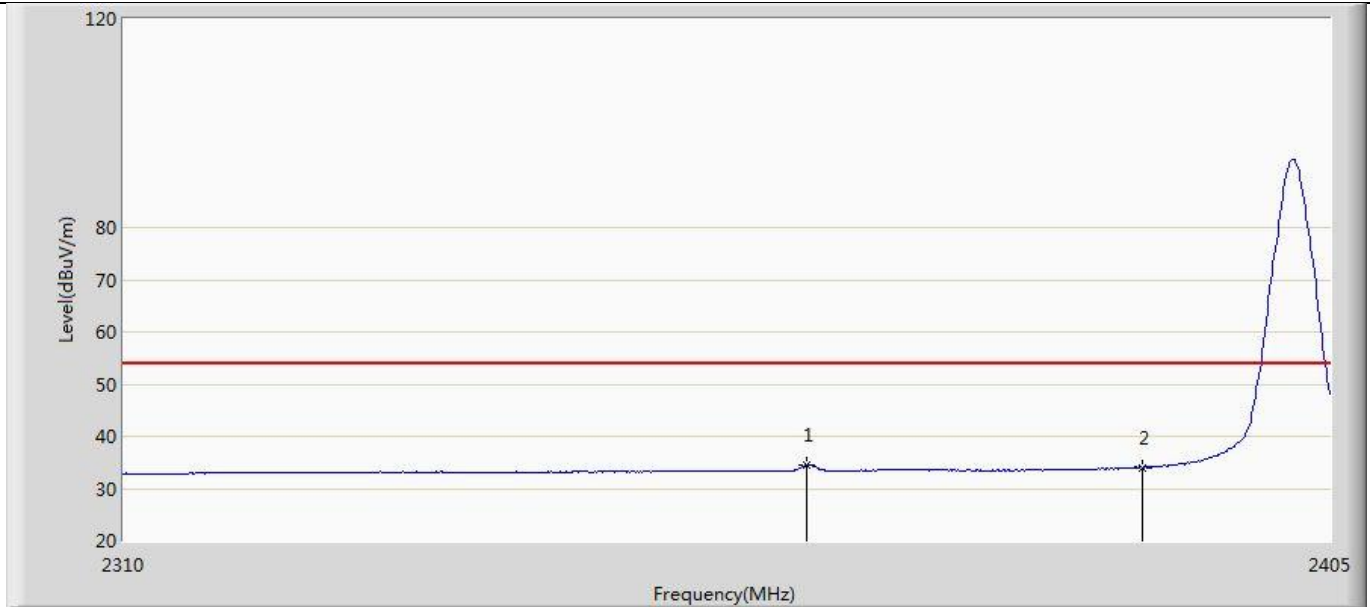

No	Mark	Frequency (MHz)	Measure Level (dBuV/m)	Reading Level (dBuV)	Over Limit (dB)	Limit (dBuV/m)	Factor (dB)	Type
1	*	2363.390	34.463	0.458	-19.537	54.000	34.005	AV
2		2390.000	33.961	-0.190	-20.039	54.000	34.151	AV

Profile: 2430175R	Page No.: 13
Engineer: Pengchengyang	
Site: AC5	Time: 2024/04/10 - 09:20
Limit: FCC_Part15.209_RE(3m)	Margin: 0
Probe: Horn_3117_00167055(1-18GHz)	Polarity: Horizontal
EUT: LED lamp	Power: AC 120V/60Hz
Note: Mode 2 : Transmit at 2480MHz by LE_2Mbps	

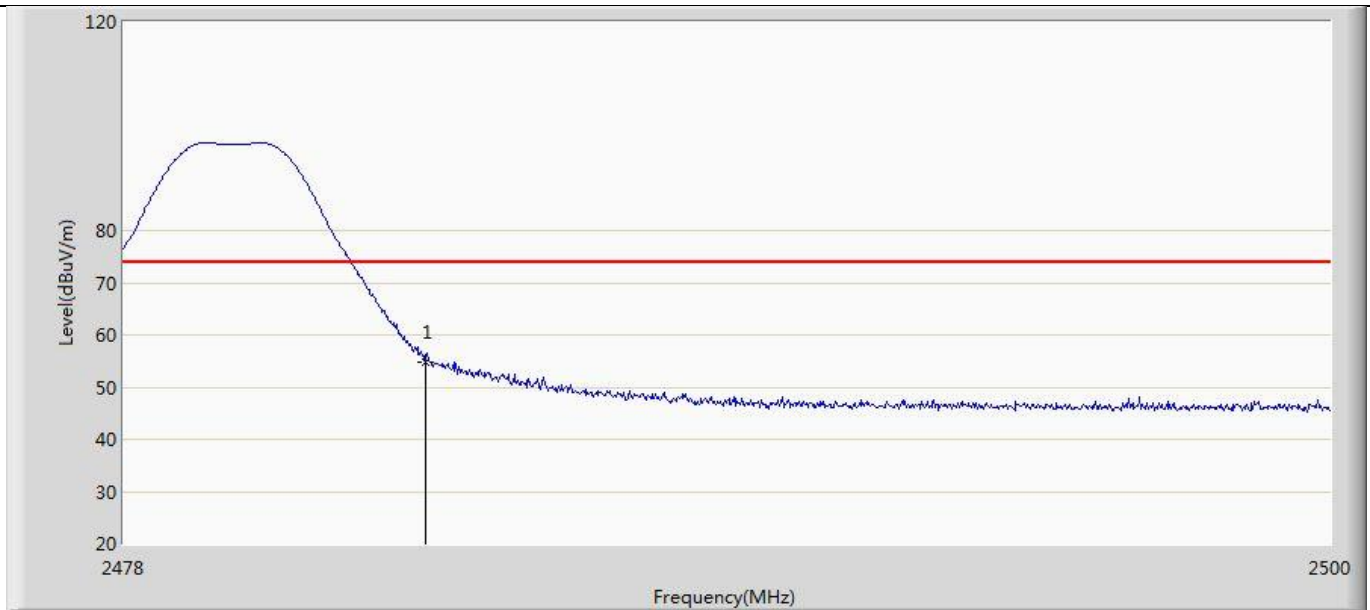

No	Mark	Frequency (MHz)	Measure Level (dBuV/m)	Reading Level (dBuV)	Over Limit (dB)	Limit (dBuV/m)	Factor (dB)	Type
1	*	2483.500	54.688	20.232	-19.312	74.000	34.456	PK

Profile: 2430175R	Page No.: 14
Engineer: Pengchengyang	
Site: AC5	Time: 2024/04/10 - 09:21
Limit: FCC_Part15.209_RE(3m)	Margin: 0
Probe: Horn_3117_00167055(1-18GHz)	Polarity: Horizontal
EUT: LED lamp	Power: AC 120V/60Hz
Note: Mode 2 : Transmit at 2480MHz by LE_2Mbps	

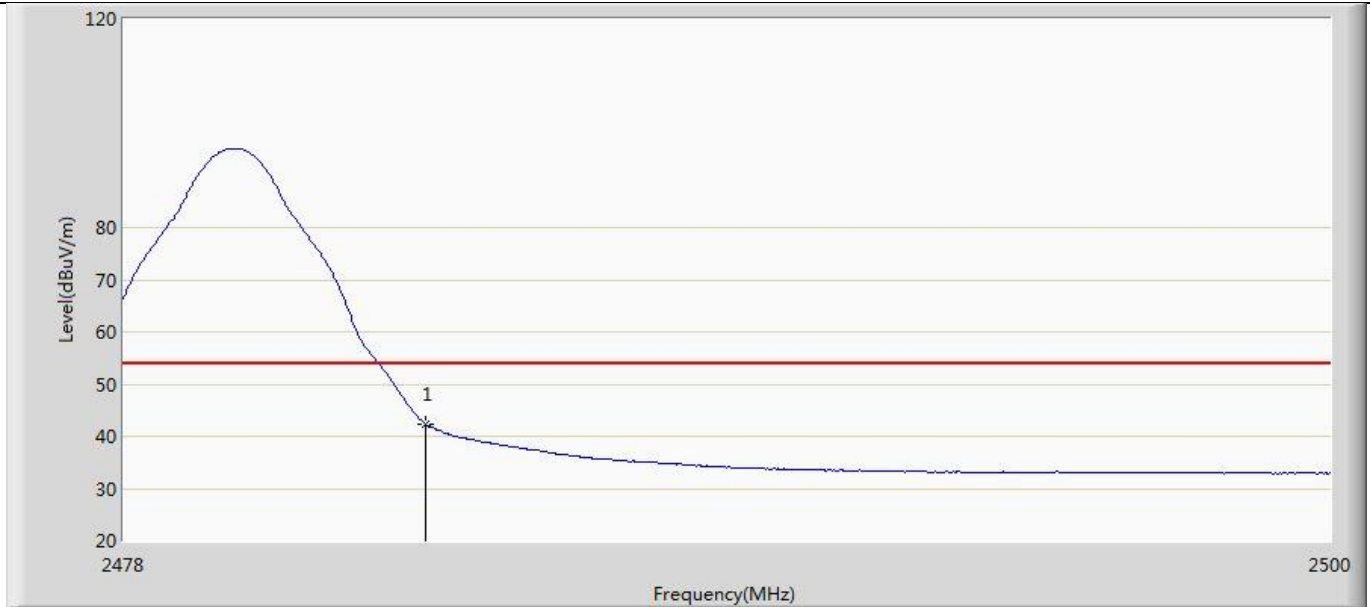

No	Mark	Frequency (MHz)	Measure Level (dBuV/m)	Reading Level (dBuV)	Over Limit (dB)	Limit (dBuV/m)	Factor (dB)	Type
1	*	2483.500	42.305	7.849	-11.695	54.000	34.456	AV

Profile: 2430175R	Page No.: 15
Engineer: Pengchengyang	
Site: AC5	Time: 2024/04/10 - 09:23
Limit: FCC_Part15.209_RE(3m)	Margin: 0
Probe: Horn_3117_00167055(1-18GHz)	Polarity: Vertical
EUT: LED lamp	Power: AC 120V/60Hz
Note: Mode 2 : Transmit at 2480MHz by LE_2Mbps	

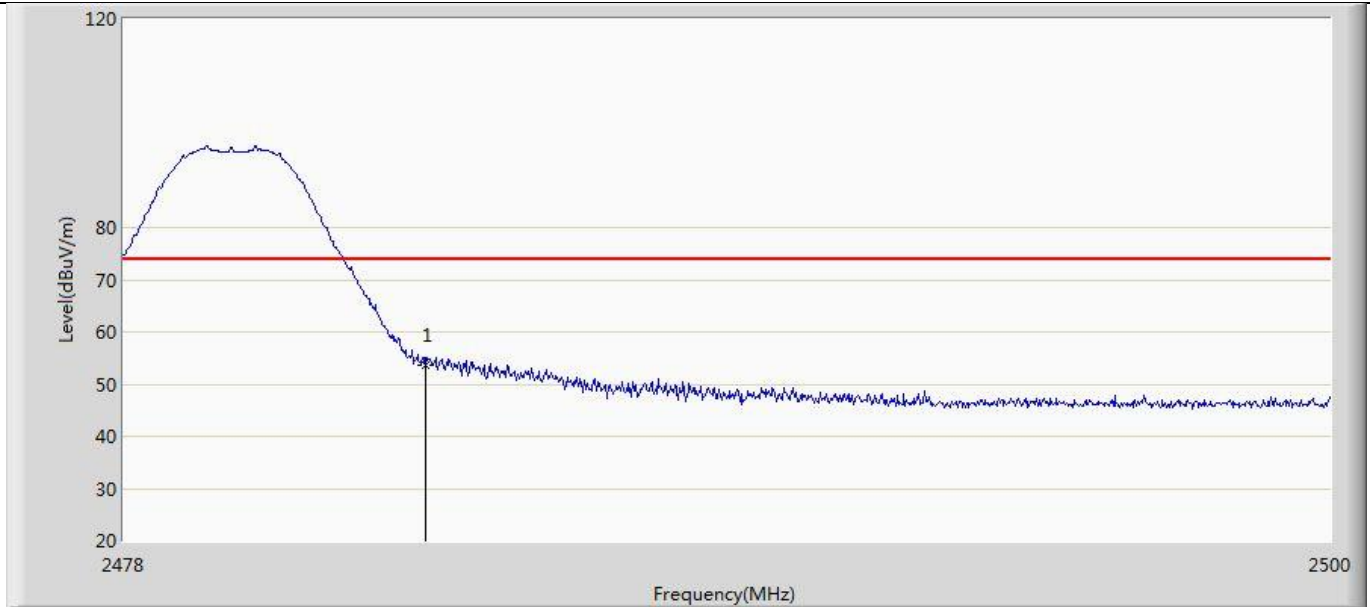

No	Mark	Frequency (MHz)	Measure Level (dBuV/m)	Reading Level (dBuV)	Over Limit (dB)	Limit (dBuV/m)	Factor (dB)	Type
1	*	2483.500	53.545	19.089	-20.455	74.000	34.456	PK

Profile: 2430175R	Page No.: 16
Engineer: Pengchengyang	
Site: AC5	Time: 2024/04/10 - 09:24
Limit: FCC_Part15.209_RE(3m)	Margin: 0
Probe: Horn_3117_00167055(1-18GHz)	Polarity: Vertical
EUT: LED lamp	Power: AC 120V/60Hz
Note: Mode 2 : Transmit at 2480MHz by LE_2Mbps	

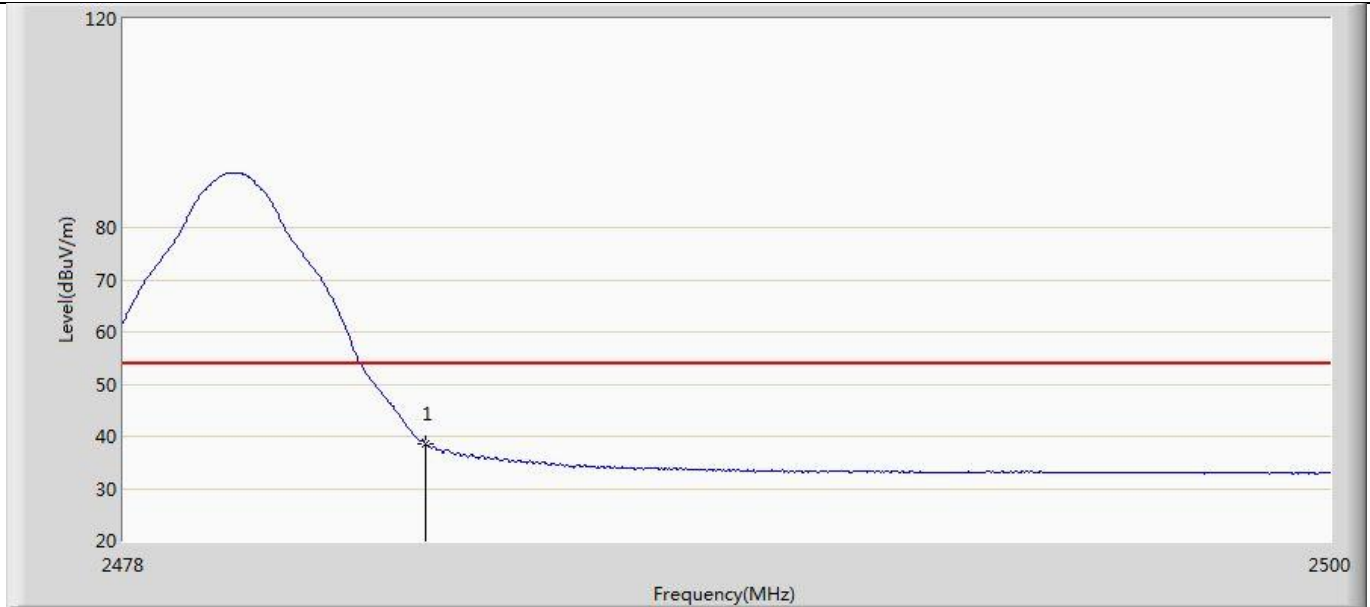

No	Mark	Frequency (MHz)	Measure Level (dBuV/m)	Reading Level (dBuV)	Over Limit (dB)	Limit (dBuV/m)	Factor (dB)	Type
1	*	2483.500	38.654	4.198	-15.346	54.000	34.456	AV

Profile: 2430175R	Page No.: 17
Engineer: Pengchengyang	
Site: AC5	Time: 2024/04/10 - 09:25
Limit: FCC_Part15.209_RE(3m)	Margin: 0
Probe: Horn_3117_00167055(1-18GHz)	Polarity: Horizontal
EUT: LED lamp	Power: AC 120V/60Hz
Note: Mode 3 : Transmit at 2402MHz by LE_Coded S=8	

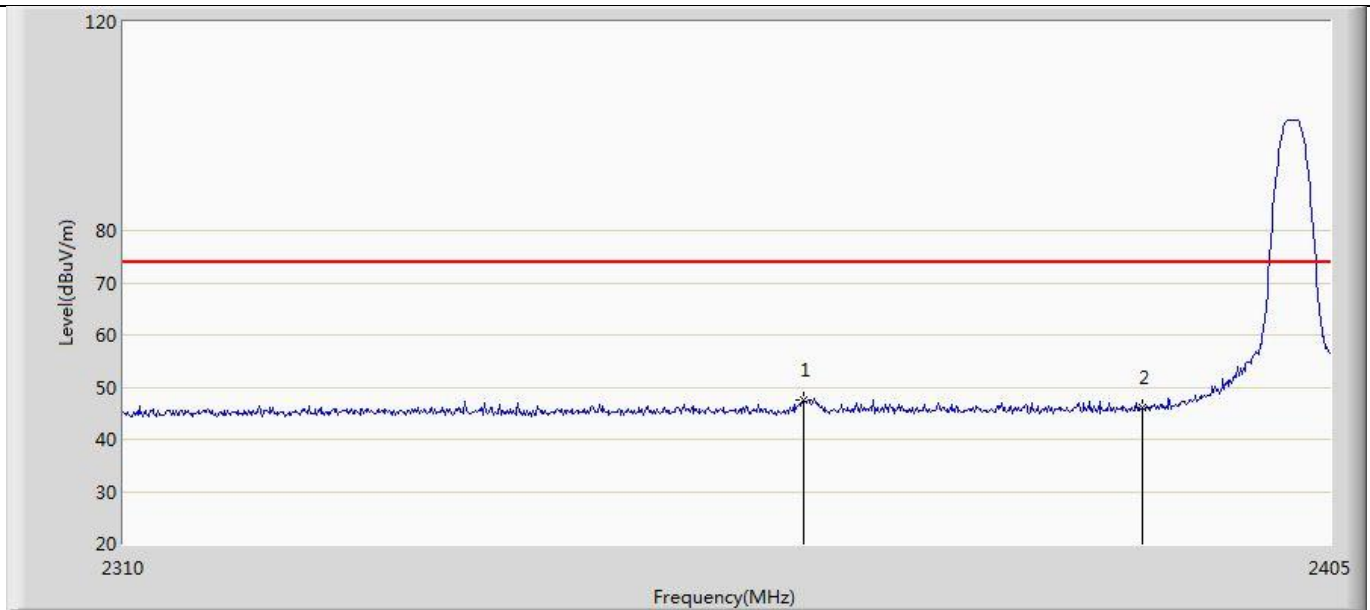

No	Mark	Frequency (MHz)	Measure Level (dBuV/m)	Reading Level (dBuV)	Over Limit (dB)	Limit (dBuV/m)	Factor (dB)	Type
1	*	2363.105	47.500	13.497	-26.500	74.000	34.003	PK
2		2390.000	46.012	11.861	-27.988	74.000	34.151	PK

Profile: 2430175R	Page No.: 18
Engineer: Pengchengyang	
Site: AC5	Time: 2024/04/10 - 09:27
Limit: FCC_Part15.209_RE(3m)	Margin: 0
Probe: Horn_3117_00167055(1-18GHz)	Polarity: Horizontal
EUT: LED lamp	Power: AC 120V/60Hz
Note: Mode 3 : Transmit at 2402MHz by LE_Coded S=8	

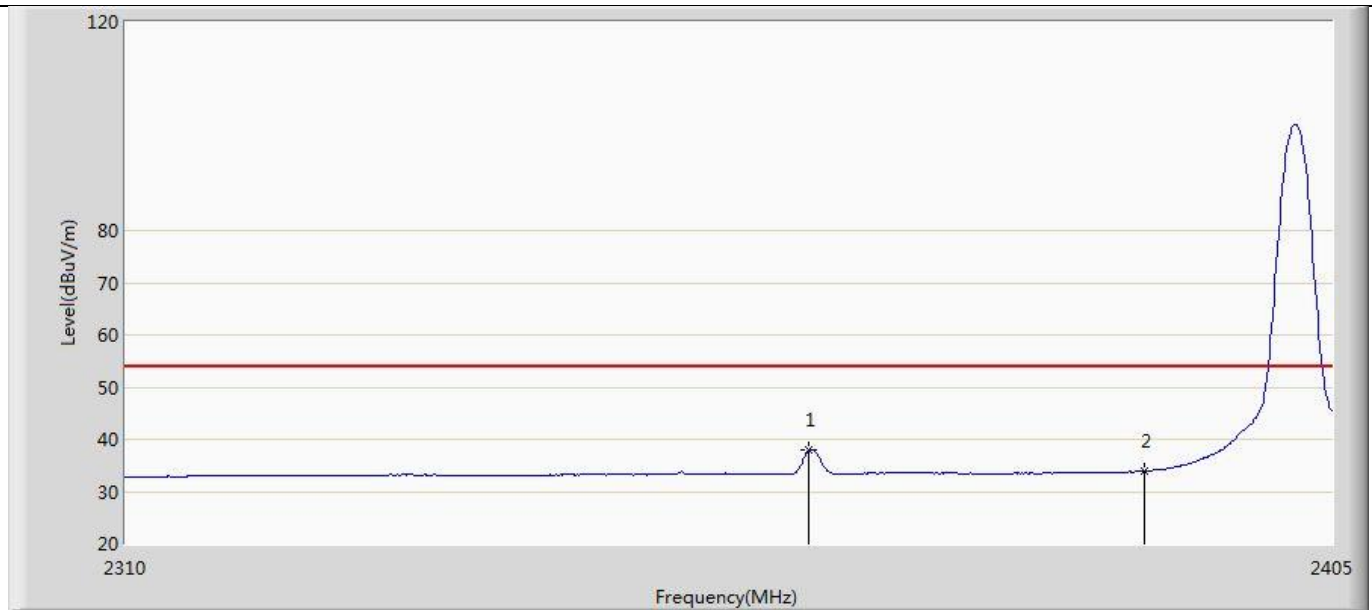

No	Mark	Frequency (MHz)	Measure Level (dBuV/m)	Reading Level (dBuV)	Over Limit (dB)	Limit (dBuV/m)	Factor (dB)	Type
1	*	2363.390	37.953	3.948	-16.047	54.000	34.005	AV
2		2390.000	33.916	-0.235	-20.084	54.000	34.151	AV

Profile: 2430175R	Page No.: 19
Engineer: Pengchengyang	
Site: AC5	Time: 2024/04/10 - 09:29
Limit: FCC_Part15.209_RE(3m)	Margin: 0
Probe: Horn_3117_00167055(1-18GHz)	Polarity: Vertical
EUT: LED lamp	Power: AC 120V/60Hz
Note: Mode 3 : Transmit at 2402MHz by LE_Coded S=8	

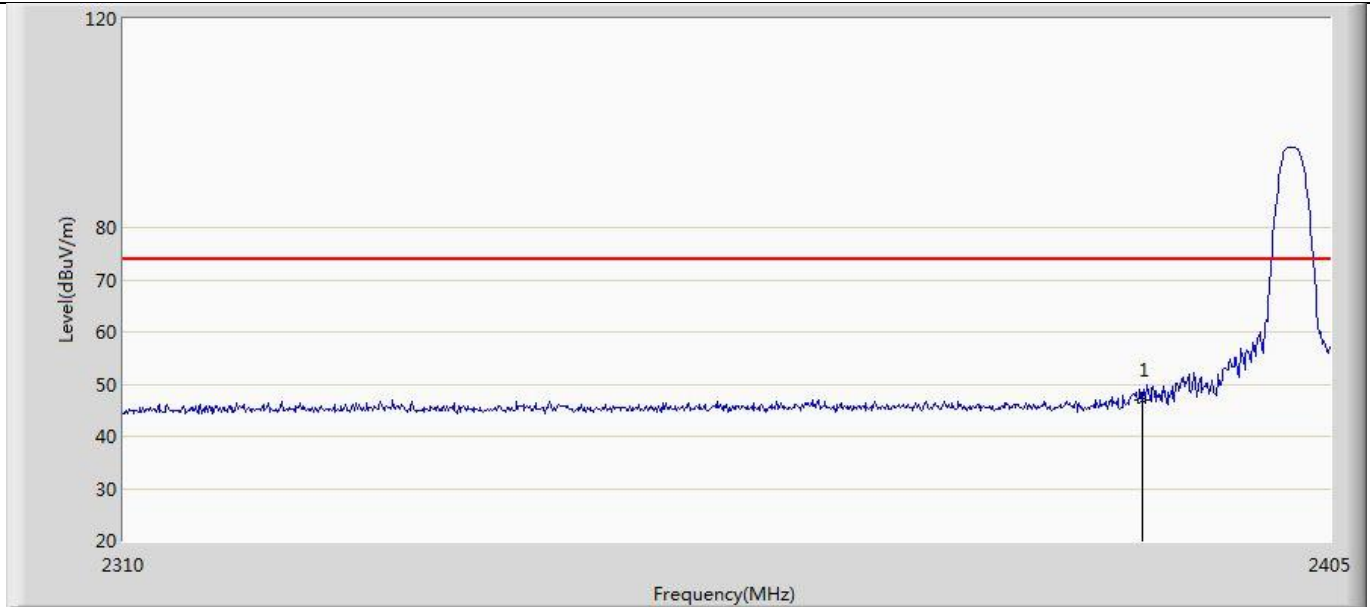

No	Mark	Frequency (MHz)	Measure Level (dBuV/m)	Reading Level (dBuV)	Over Limit (dB)	Limit (dBuV/m)	Factor (dB)	Type
1	*	2390.000	46.882	12.731	-27.118	74.000	34.151	PK

Profile: 2430175R	Page No.: 20
Engineer: Pengchengyang	
Site: AC5	Time: 2024/04/10 - 09:30
Limit: FCC_Part15.209_RE(3m)	Margin: 0
Probe: Horn_3117_00167055(1-18GHz)	Polarity: Vertical
EUT: LED lamp	Power: AC 120V/60Hz
Note: Mode 3 : Transmit at 2402MHz by LE_Coded S=8	

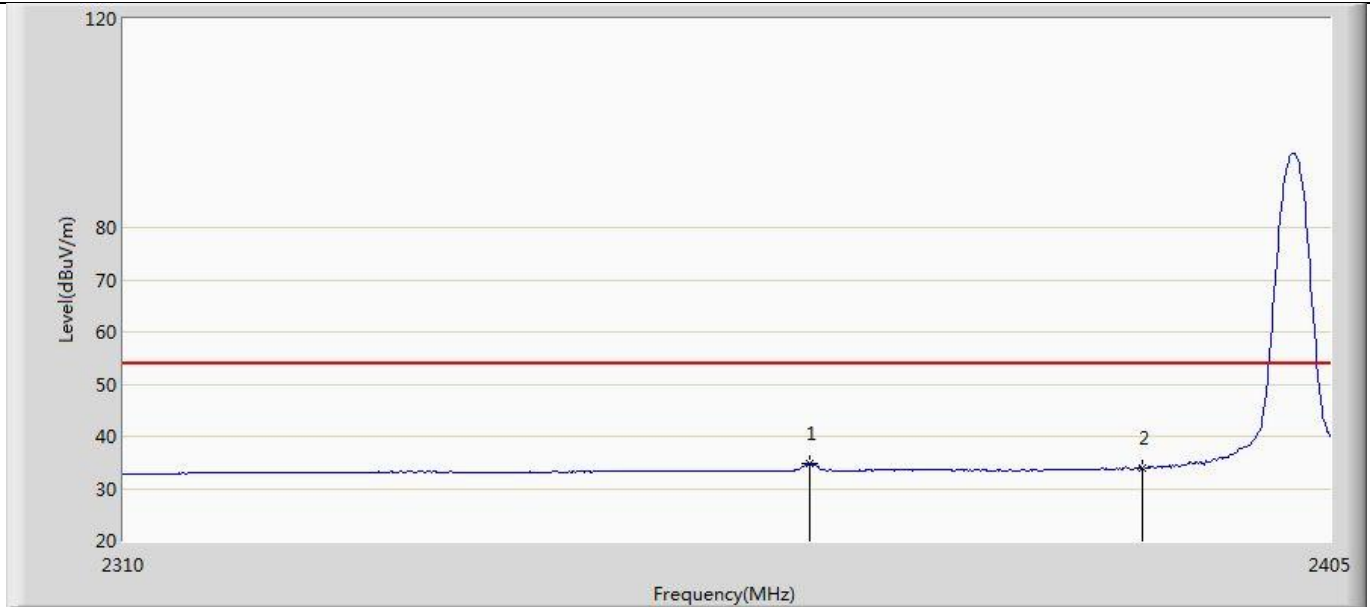

No	Mark	Frequency (MHz)	Measure Level (dBuV/m)	Reading Level (dBuV)	Over Limit (dB)	Limit (dBuV/m)	Factor (dB)	Type
1	*	2363.580	34.774	0.768	-19.226	54.000	34.006	AV
2		2390.000	33.975	-0.176	-20.025	54.000	34.151	AV

Profile: 2430175R	Page No.: 21
Engineer: Pengchengyang	
Site: AC5	Time: 2024/04/10 - 09:31
Limit: FCC_Part15.209_RE(3m)	Margin: 0
Probe: Horn_3117_00167055(1-18GHz)	Polarity: Horizontal
EUT: LED lamp	Power: AC 120V/60Hz
Note: Mode 3 : Transmit at 2480MHz by LE_Coded S=8	

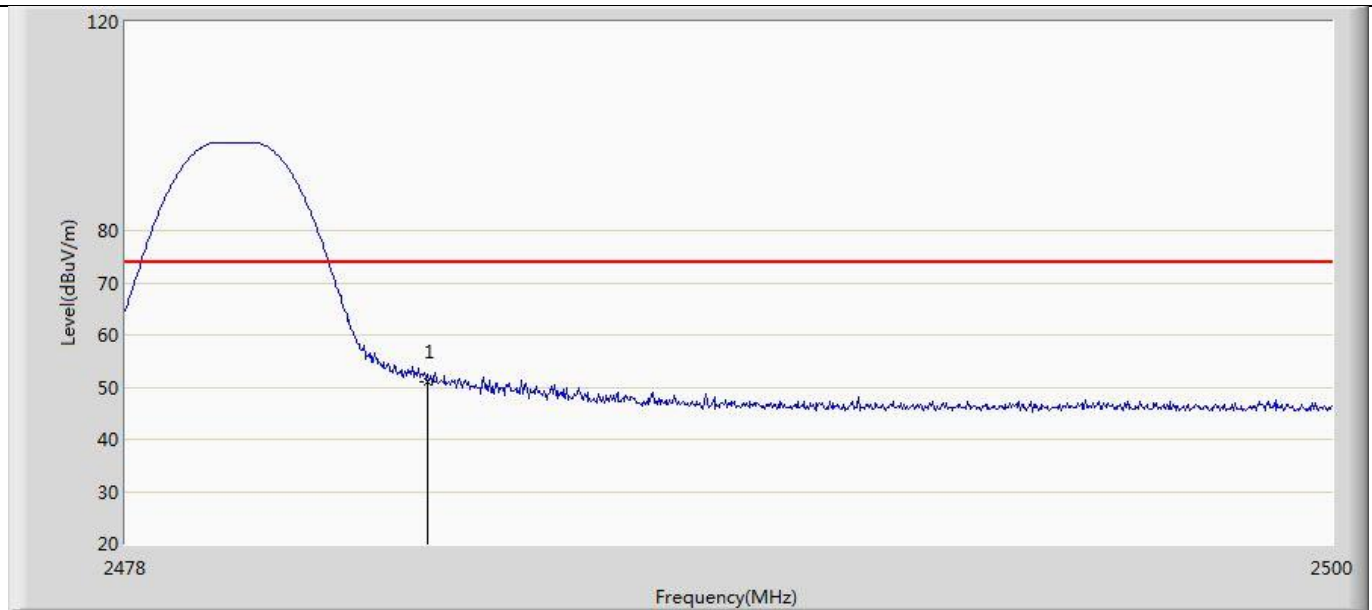

No	Mark	Frequency (MHz)	Measure Level (dBuV/m)	Reading Level (dBuV)	Over Limit (dB)	Limit (dBuV/m)	Factor (dB)	Type
1	*	2483.500	51.034	16.578	-22.966	74.000	34.456	PK

Profile: 2430175R	Page No.: 22
Engineer: Pengchengyang	
Site: AC5	Time: 2024/04/10 - 09:34
Limit: FCC_Part15.209_RE(3m)	Margin: 0
Probe: Horn_3117_00167055(1-18GHz)	Polarity: Horizontal
EUT: LED lamp	Power: AC 120V/60Hz
Note: Mode 3 : Transmit at 2480MHz by LE_Coded S=8	

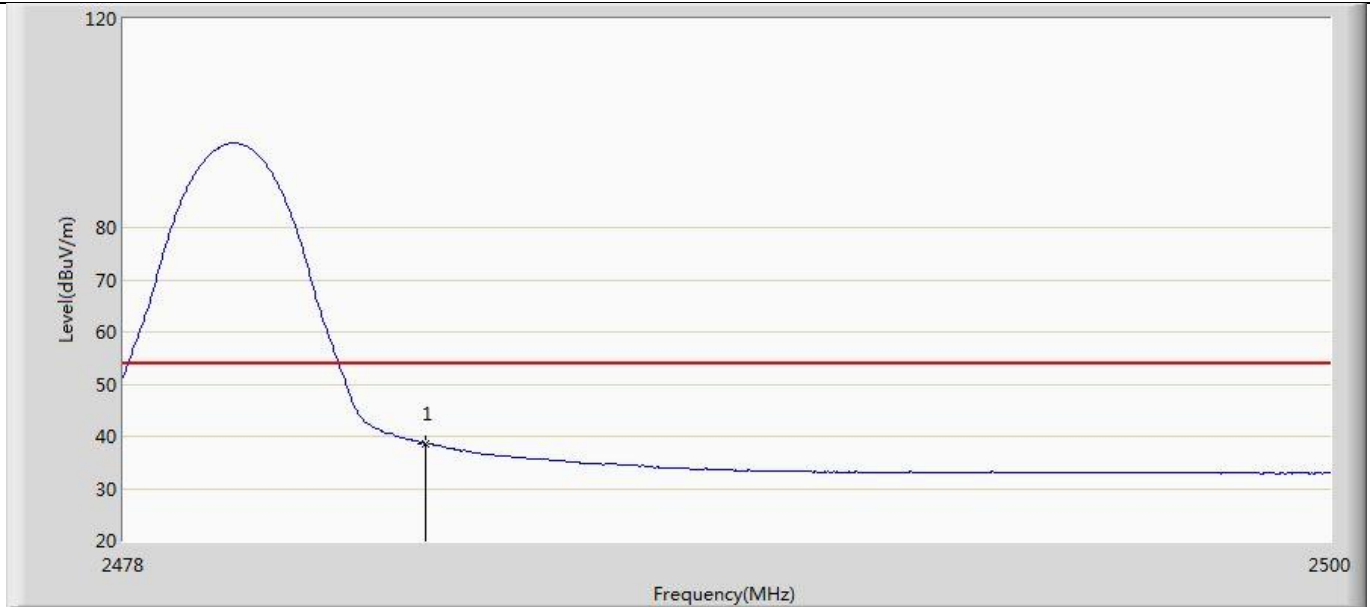

No	Mark	Frequency (MHz)	Measure Level (dBuV/m)	Reading Level (dBuV)	Over Limit (dB)	Limit (dBuV/m)	Factor (dB)	Type
1	*	2483.500	38.674	4.218	-15.326	54.000	34.456	AV

Profile: 2430175R	Page No.: 23
Engineer: Pengchengyang	
Site: AC5	Time: 2024/04/10 - 09:35
Limit: FCC_Part15.209_RE(3m)	Margin: 0
Probe: Horn_3117_00167055(1-18GHz)	Polarity: Vertical
EUT: LED lamp	Power: AC 120V/60Hz
Note: Mode 3 : Transmit at 2480MHz by LE_Coded S=8	

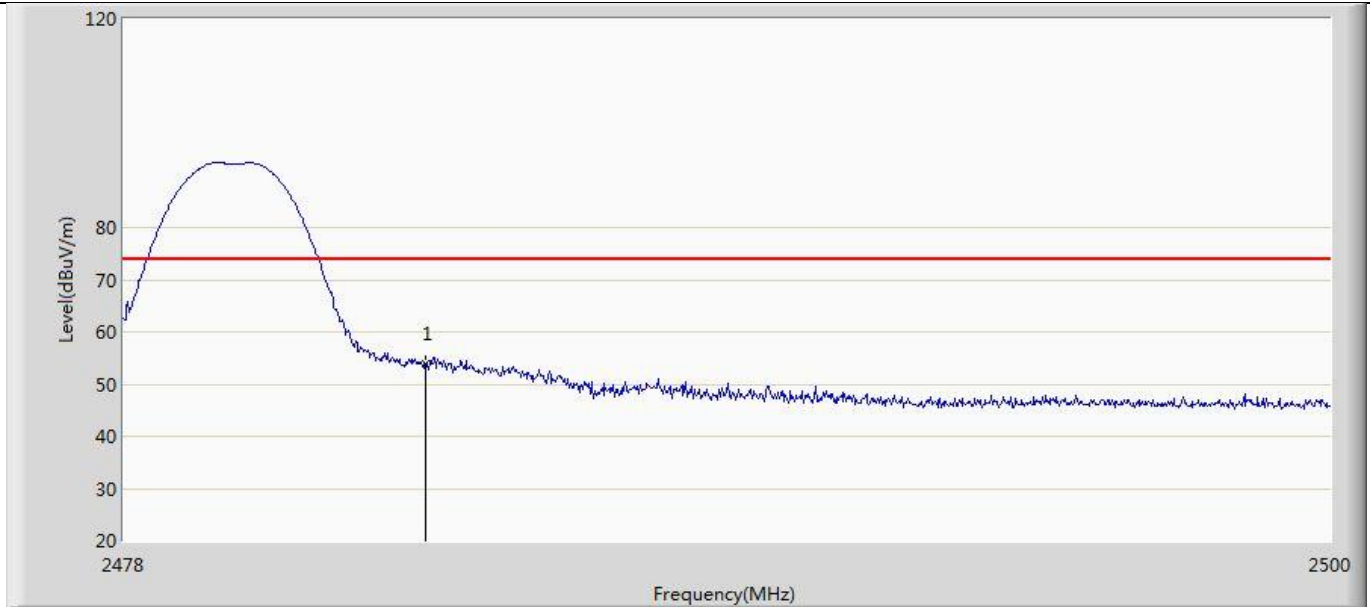

No	Mark	Frequency (MHz)	Measure Level (dBuV/m)	Reading Level (dBuV)	Over Limit (dB)	Limit (dBuV/m)	Factor (dB)	Type
1	*	2483.500	53.978	19.522	-20.022	74.000	34.456	PK

Profile: 2430175R	Page No.: 24
Engineer: Pengchengyang	
Site: AC5	Time: 2024/04/10 - 09:36
Limit: FCC_Part15.209_RE(3m)	Margin: 0
Probe: Horn_3117_00167055(1-18GHz)	Polarity: Vertical
EUT: LED lamp	Power: AC 120V/60Hz
Note: Mode 3 : Transmit at 2480MHz by LE_Coded S=8	

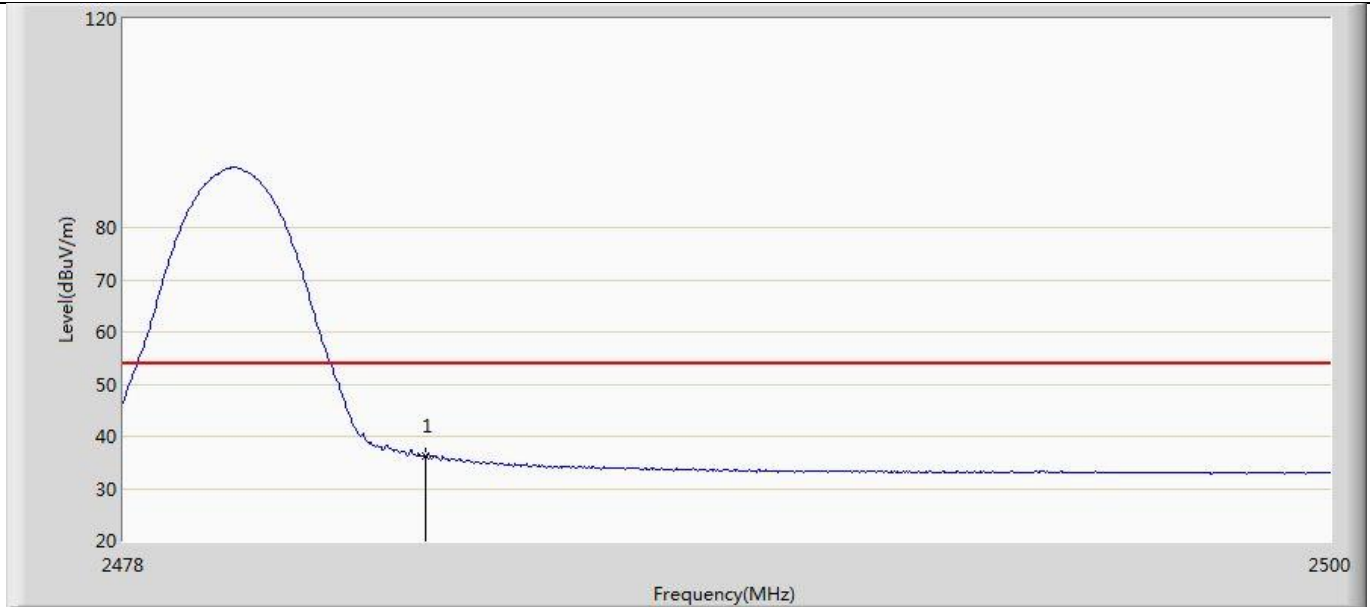

No	Mark	Frequency (MHz)	Measure Level (dBuV/m)	Reading Level (dBuV)	Over Limit (dB)	Limit (dBuV/m)	Factor (dB)	Type
1	*	2483.500	36.205	1.749	-17.795	54.000	34.456	AV

Profile: 2430175R	Page No.: 25
Engineer: Pengchengyang	
Site: AC5	Time: 2024/04/10 - 09:37
Limit: FCC_Part15.209_RE(3m)	Margin: 0
Probe: Horn_3117_00167055(1-18GHz)	Polarity: Horizontal
EUT: LED lamp	Power: AC 120V/60Hz
Note: Mode 4 : Transmit at 2402MHz by LE_Coded S=2	

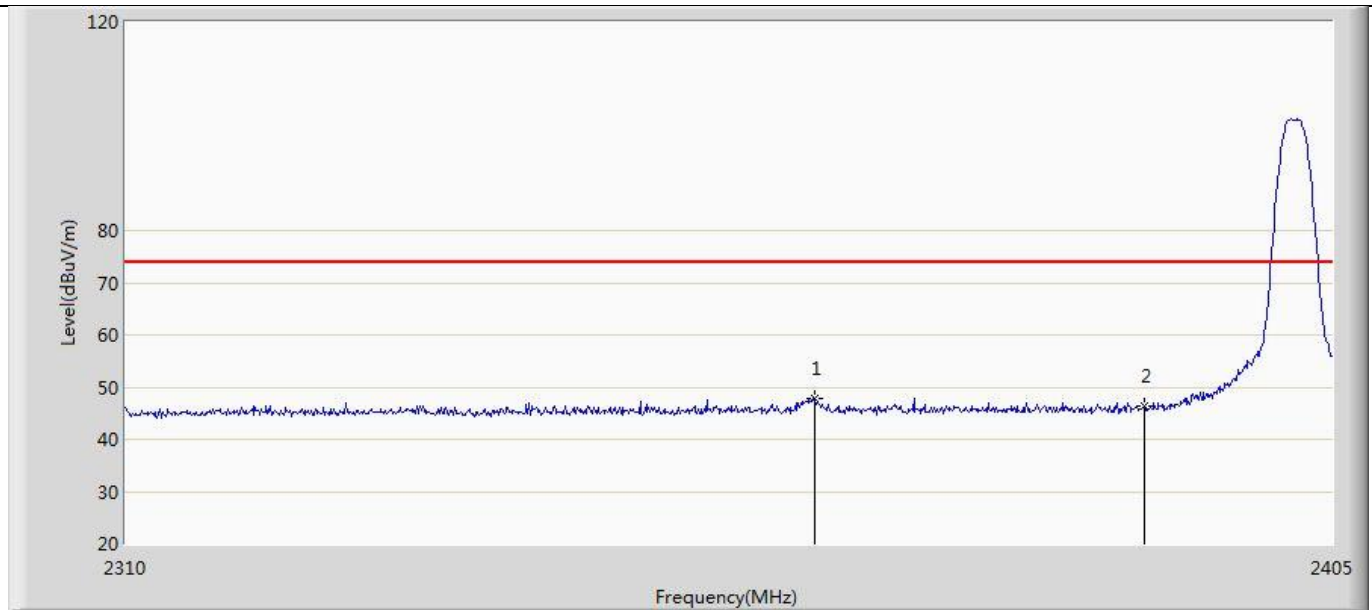

No	Mark	Frequency (MHz)	Measure Level (dBuV/m)	Reading Level (dBuV)	Over Limit (dB)	Limit (dBuV/m)	Factor (dB)	Type
1	*	2363.865	47.848	13.840	-26.152	74.000	34.007	PK
2		2390.000	46.245	12.094	-27.755	74.000	34.151	PK

Profile: 2430175R	Page No.: 26
Engineer: Pengchengyang	
Site: AC5	Time: 2024/04/10 - 09:39
Limit: FCC_Part15.209_RE(3m)	Margin: 0
Probe: Horn_3117_00167055(1-18GHz)	Polarity: Horizontal
EUT: LED lamp	Power: AC 120V/60Hz
Note: Mode 4 : Transmit at 2402MHz by LE_Coded S=2	

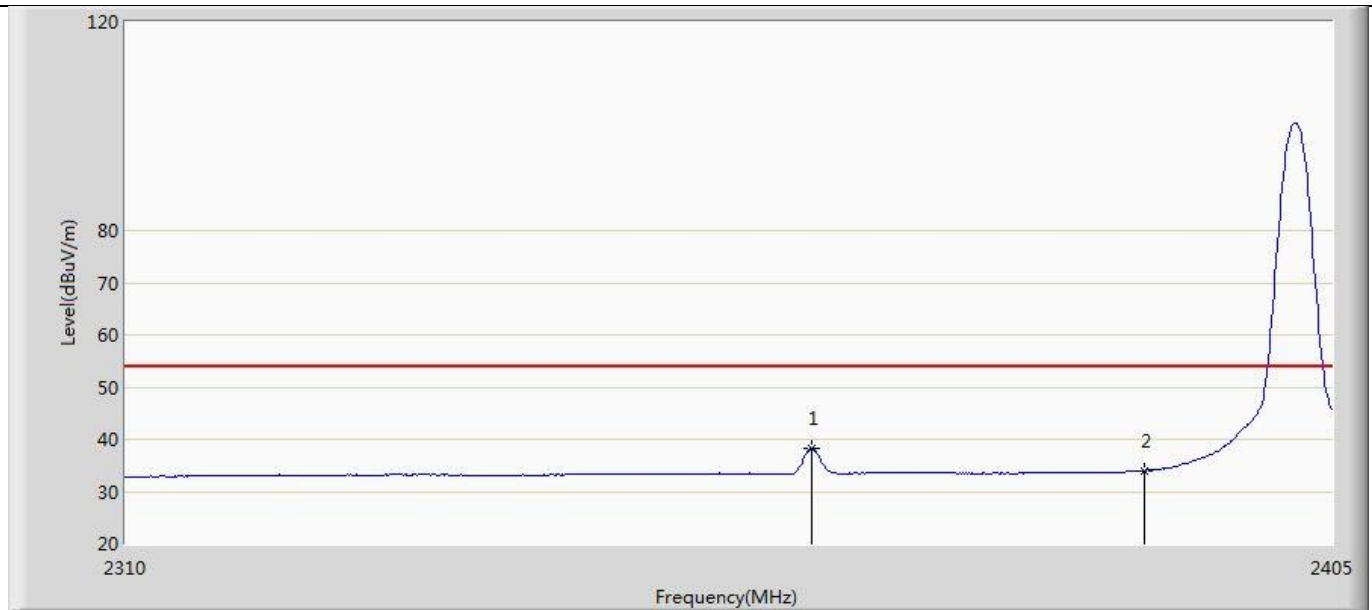

No	Mark	Frequency (MHz)	Measure Level (dBuV/m)	Reading Level (dBuV)	Over Limit (dB)	Limit (dBuV/m)	Factor (dB)	Type
1	*	2363.580	38.282	4.276	-15.718	54.000	34.006	AV
2		2390.000	34.026	-0.125	-19.974	54.000	34.151	AV

Profile: 2430175R	Page No.: 27
Engineer: Pengchengyang	
Site: AC5	Time: 2024/04/10 - 09:40
Limit: FCC_Part15.209_RE(3m)	Margin: 0
Probe: Horn_3117_00167055(1-18GHz)	Polarity: Vertical
EUT: LED lamp	Power: AC 120V/60Hz
Note: Mode 4 : Transmit at 2402MHz by LE_Coded S=2	

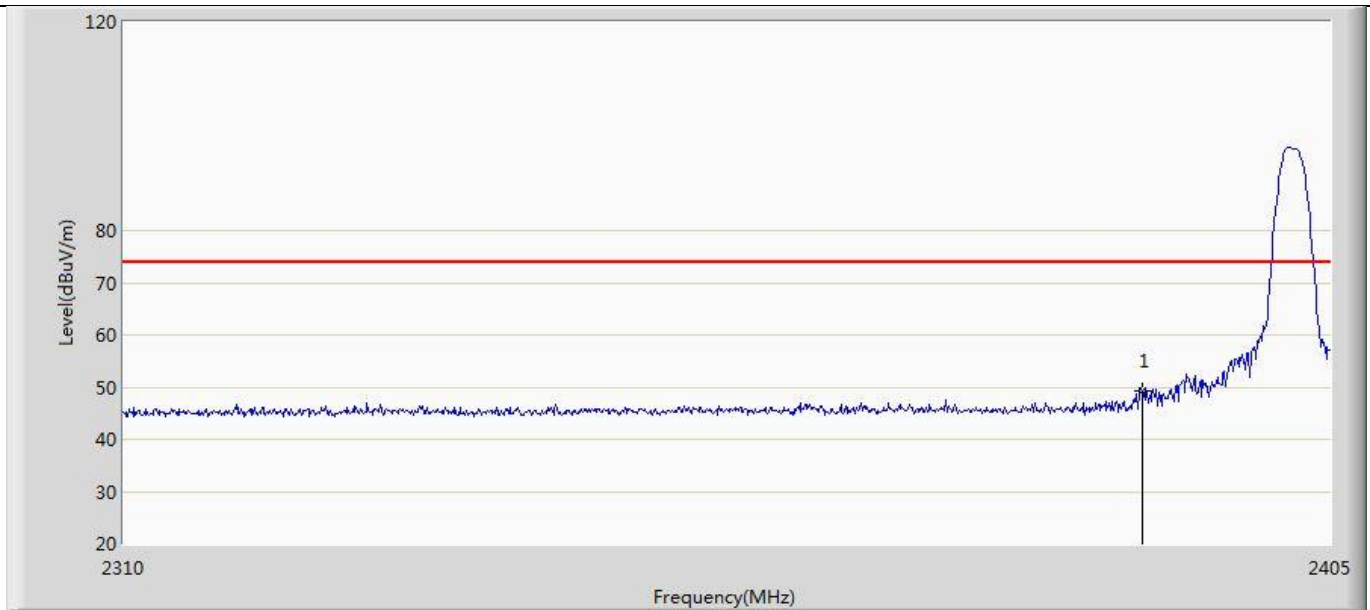

No	Mark	Frequency (MHz)	Measure Level (dBuV/m)	Reading Level (dBuV)	Over Limit (dB)	Limit (dBuV/m)	Factor (dB)	Type
1	*	2390.000	49.144	14.993	-24.856	74.000	34.151	PK

Profile: 2430175R	Page No.: 28
Engineer: Pengchengyang	
Site: AC5	Time: 2024/04/10 - 09:41
Limit: FCC_Part15.209_RE(3m)	Margin: 0
Probe: Horn_3117_00167055(1-18GHz)	Polarity: Vertical
EUT: LED lamp	Power: AC 120V/60Hz
Note: Mode 4 : Transmit at 2402MHz by LE_Coded S=2	

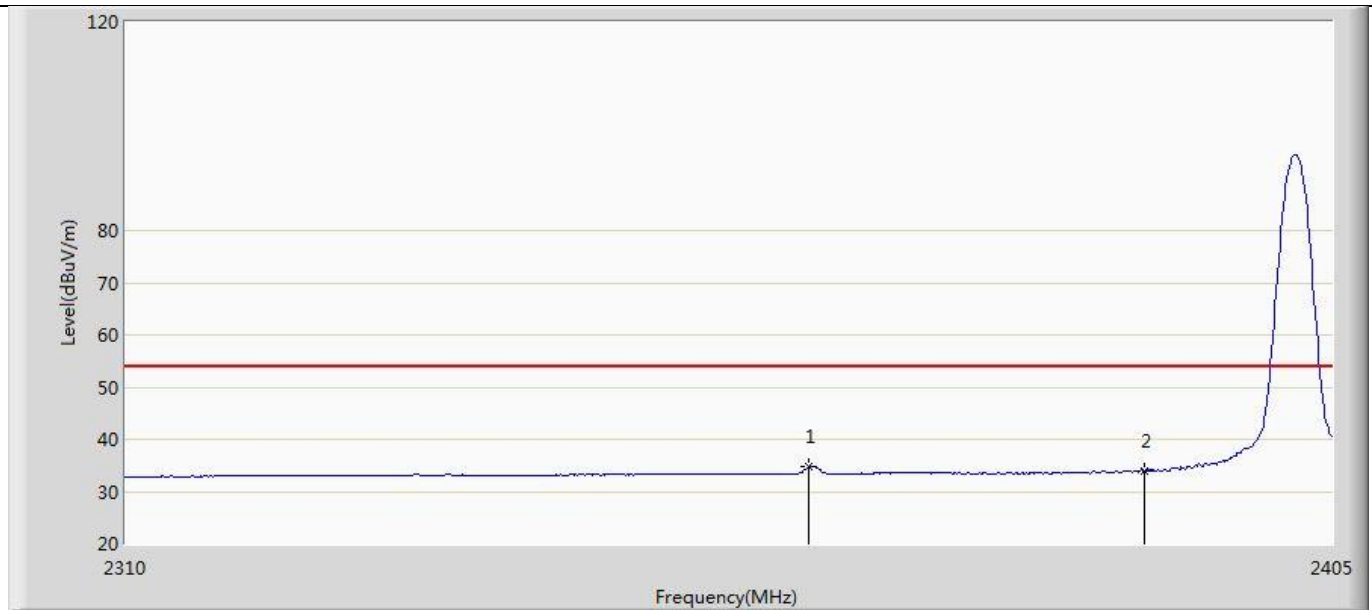

No	Mark	Frequency (MHz)	Measure Level (dBuV/m)	Reading Level (dBuV)	Over Limit (dB)	Limit (dBuV/m)	Factor (dB)	Type
1	*	2363.390	34.767	0.762	-19.233	54.000	34.005	AV
2		2390.000	33.799	-0.352	-20.201	54.000	34.151	AV

Profile: 2430175R	Page No.: 29
Engineer: Pengchengyang	
Site: AC5	Time: 2024/04/10 - 09:43
Limit: FCC_Part15.209_RE(3m)	Margin: 0
Probe: Horn_3117_00167055(1-18GHz)	Polarity: Horizontal
EUT: LED lamp	Power: AC 120V/60Hz
Note: Mode 4 : Transmit at 2480MHz by LE_Coded S=2	

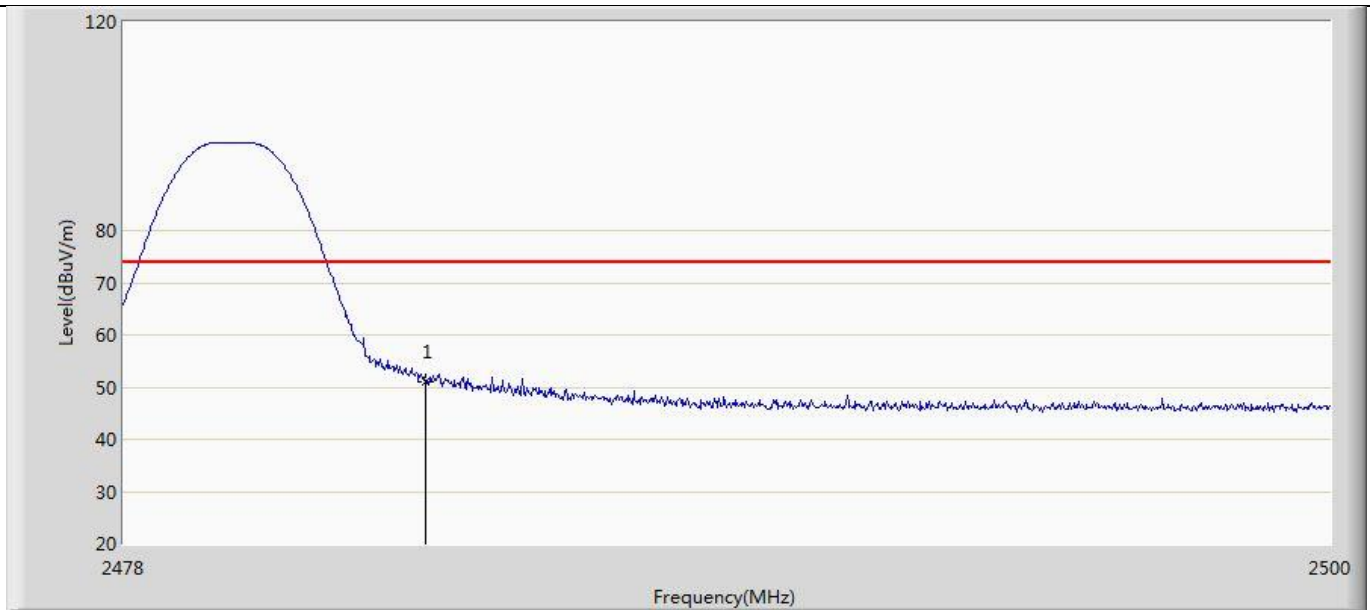

No	Mark	Frequency (MHz)	Measure Level (dBuV/m)	Reading Level (dBuV)	Over Limit (dB)	Limit (dBuV/m)	Factor (dB)	Type
1	*	2483.500	51.089	16.633	-22.911	74.000	34.456	PK

Profile: 2430175R	Page No.: 30
Engineer: Pengchengyang	
Site: AC5	Time: 2024/04/10 - 09:46
Limit: FCC_Part15.209_RE(3m)	Margin: 0
Probe: Horn_3117_00167055(1-18GHz)	Polarity: Horizontal
EUT: LED lamp	Power: AC 120V/60Hz
Note: Mode 4 : Transmit at 2480MHz by LE_Coded S=2	

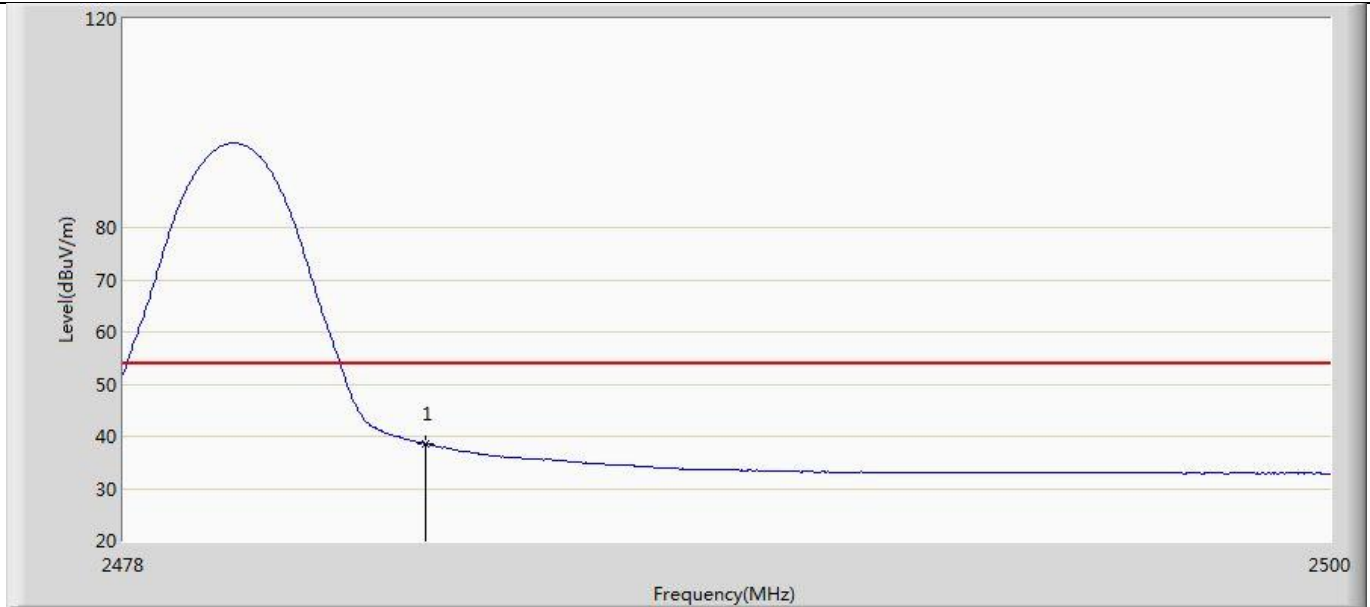

No	Mark	Frequency (MHz)	Measure Level (dBuV/m)	Reading Level (dBuV)	Over Limit (dB)	Limit (dBuV/m)	Factor (dB)	Type
1	*	2483.500	38.580	4.124	-15.420	54.000	34.456	AV

Profile: 2430175R	Page No.: 31
Engineer: Pengchengyang	
Site: AC5	Time: 2024/04/10 - 09:47
Limit: FCC_Part15.209_RE(3m)	Margin: 0
Probe: Horn_3117_00167055(1-18GHz)	Polarity: Vertical
EUT: LED lamp	Power: AC 120V/60Hz
Note: Mode 4 : Transmit at 2480MHz by LE_Coded S=2	

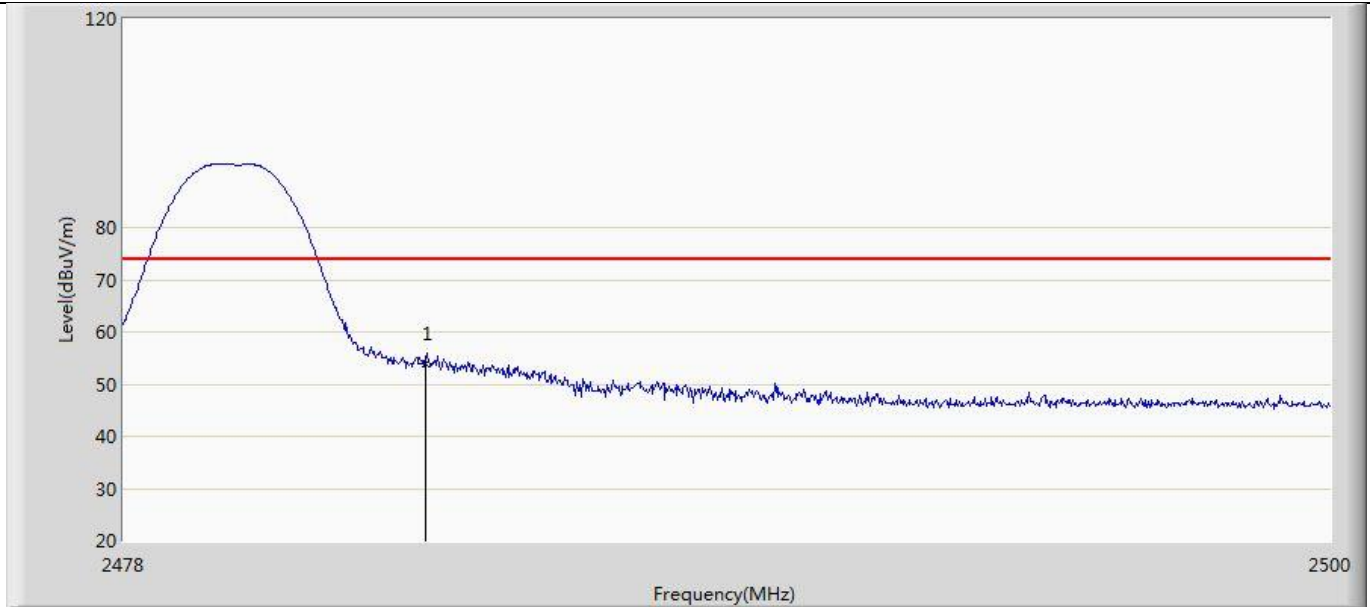

No	Mark	Frequency (MHz)	Measure Level (dBuV/m)	Reading Level (dBuV)	Over Limit (dB)	Limit (dBuV/m)	Factor (dB)	Type
1	*	2483.500	53.904	19.448	-20.096	74.000	34.456	PK

Profile: 2430175R	Page No.: 32
Engineer: Pengchengyang	
Site: AC5	Time: 2024/04/10 - 09:48
Limit: FCC_Part15.209_RE(3m)	Margin: 0
Probe: Horn_3117_00167055(1-18GHz)	Polarity: Vertical
EUT: LED lamp	Power: AC 120V/60Hz
Note: Mode 4 : Transmit at 2480MHz by LE_Coded S=2	

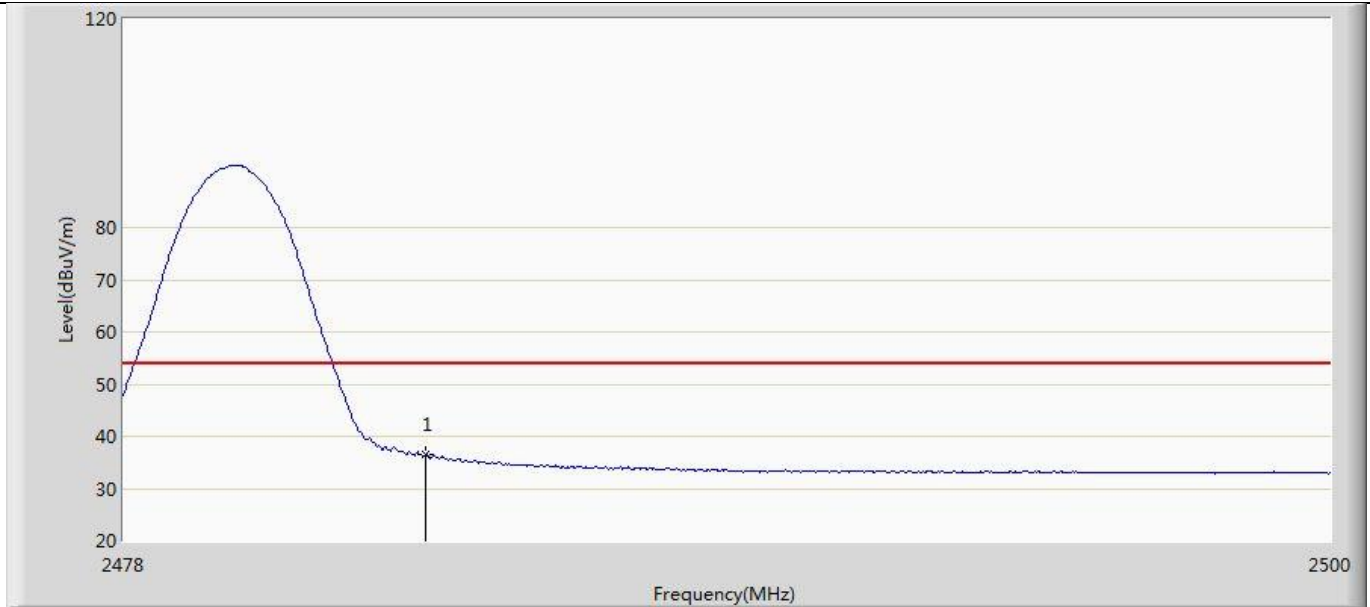

No	Mark	Frequency (MHz)	Measure Level (dBuV/m)	Reading Level (dBuV)	Over Limit (dB)	Limit (dBuV/m)	Factor (dB)	Type
1	*	2483.500	36.406	1.950	-17.594	54.000	34.456	AV

Appendix F: Conducted Spurious Emission

Reference level measurement :

TestMode	Antenna	Freq(MHz)	Max.Point[MHz]	Result[dBm]
BLE_1M	Ant1	2402	2402.24	9.04
BLE_1M	Ant1	2440	2440.24	8.99
BLE_1M	Ant1	2480	2480.24	8.97
BLE_2M	Ant1	2402	2402.17	6.81
BLE_2M	Ant1	2440	2440.17	6.82
BLE_2M	Ant1	2480	2480.18	6.74
BLE_125K	Ant1	2402	2401.76	6.49
BLE_125K	Ant1	2440	2439.76	6.44
BLE_125K	Ant1	2480	2479.76	6.40
BLE_500K	Ant1	2402	2402.26	9.02
BLE_500K	Ant1	2440	2440.26	8.98
BLE_500K	Ant1	2480	2480.25	8.90



BLE_1M-Ant1-2402-PASS

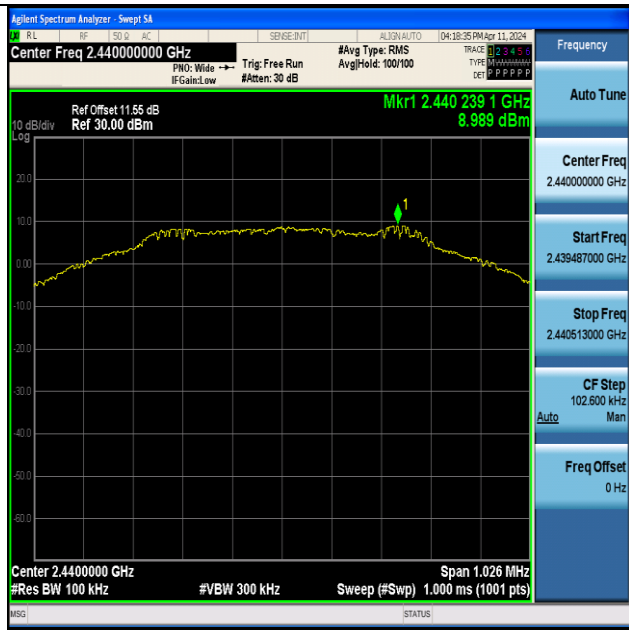

BLE_1M-Ant1-2440-PASS



BLE_1M-Ant1-2480-PASS



BLE_2M-Ant1-2402-PASS

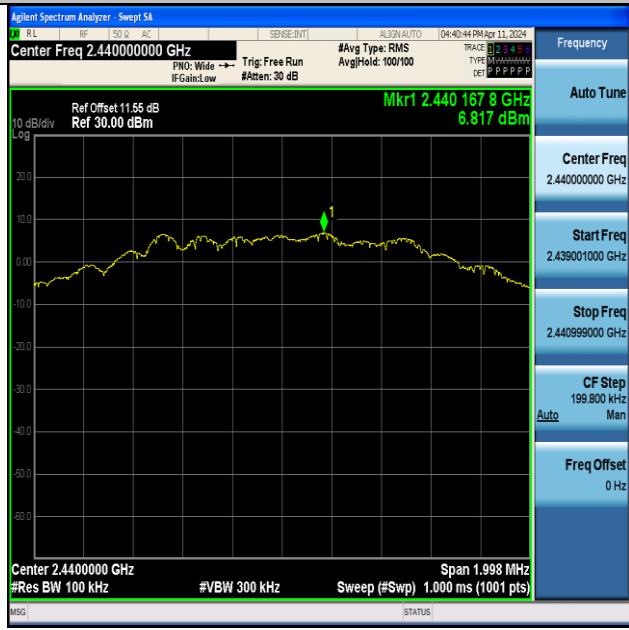

BLE_2M-Ant1-2440-PASS

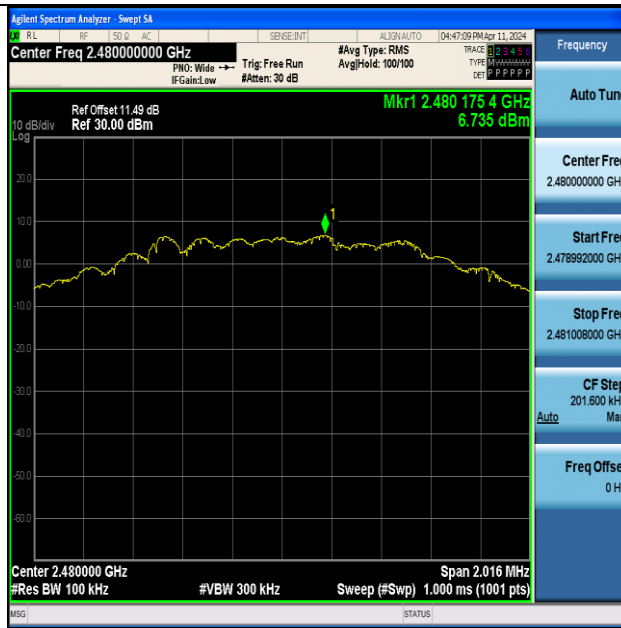

BLE_2M-Ant1-2480-PASS

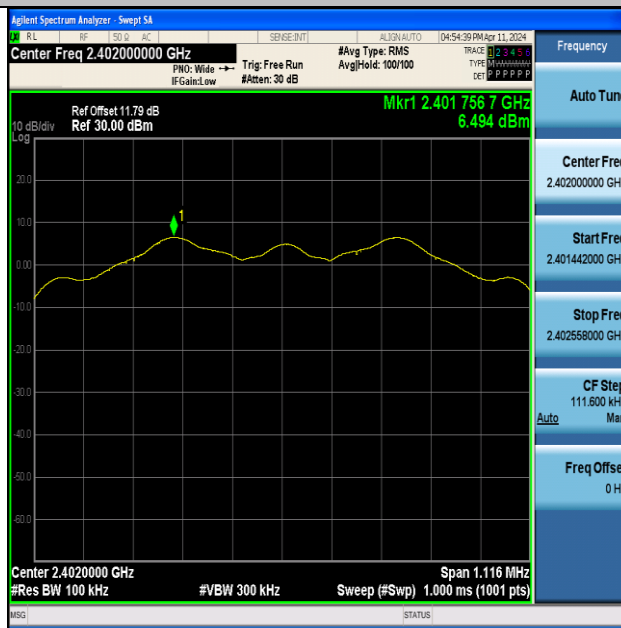

BLE_125K-Ant1-2402-PASS

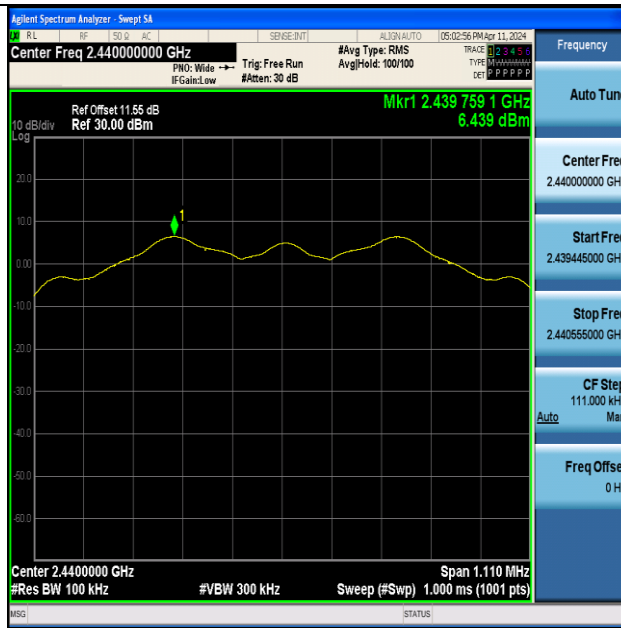

BLE_125K-Ant1-2440-PASS



BLE_125K-Ant1-2480-PASS



BLE_500K-Ant1-2402-PASS

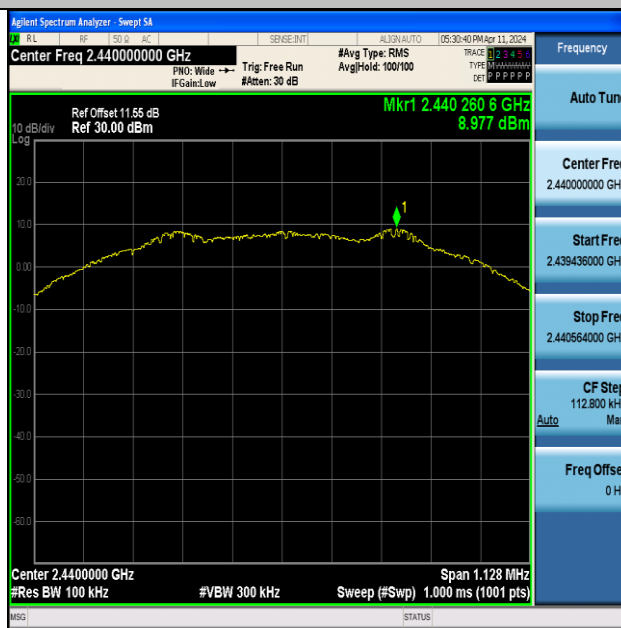

BLE_500K-Ant1-2440-PASS



BLE_500K-Ant1-2480-PASS

Band edge measurements :

TestMode	Antenna	ChName	Frequency[MHz]	RefLevel[dBm]	Result[dBm]	Limit[dBm]	Verdict
BLE_1M	Ant1	Low	2402	9.04	-41.9	≤-10.96	PASS
BLE_1M	Ant1	High	2480	8.97	-43.89	≤-11.03	PASS
BLE_2M	Ant1	Low	2402	6.81	-25.15	≤-13.19	PASS
BLE_2M	Ant1	High	2480	6.74	-42.8	≤-13.26	PASS
BLE_125K	Ant1	Low	2402	6.49	-41.46	≤-13.51	PASS
BLE_125K	Ant1	High	2480	6.40	-43.84	≤-13.6	PASS
BLE_500K	Ant1	Low	2402	9.02	-41.56	≤-10.98	PASS
BLE_500K	Ant1	High	2480	8.90	-44.15	≤-11.1	PASS

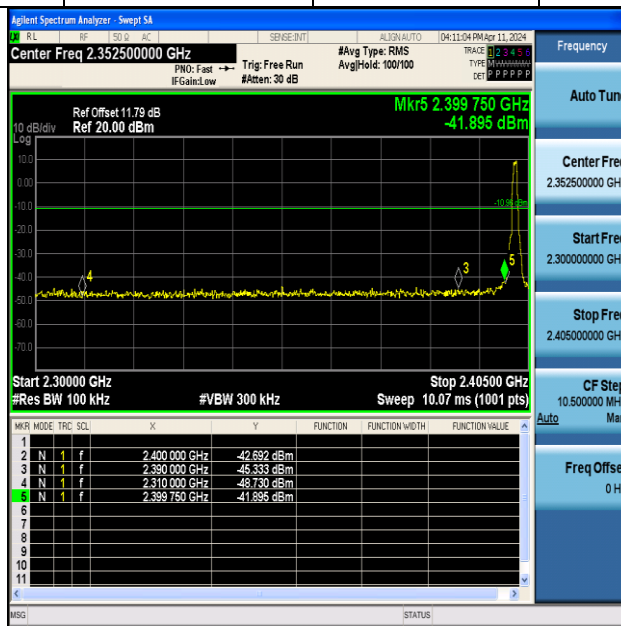

BLE_1M-Ant1-2402-PASS

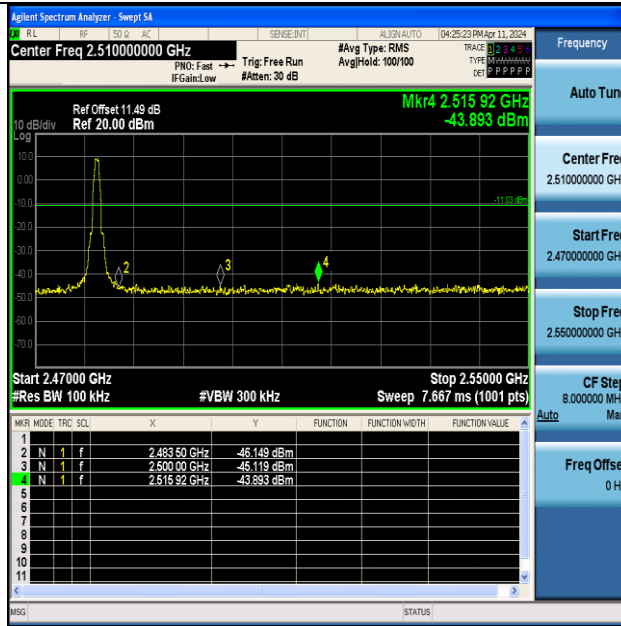

BLE_1M-Ant1-2480-PASS

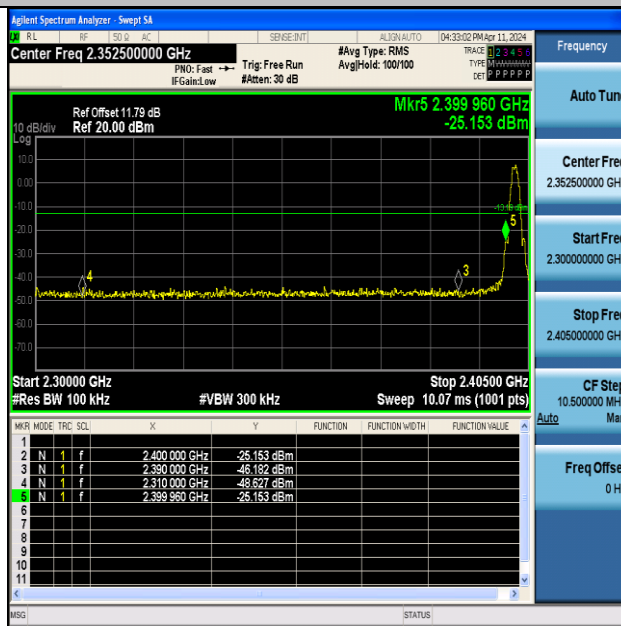

BLE_2M-Ant1-2402-PASS