



Test report No:  
2430177R-RF-US-P06V02

## FCC & ISED TEST REPORT

Product Name	LED lamp
Trademark	<b>PHILIPS</b> hue 
Model and /or type reference	9290034793
FCC ID	2AGBW9290034793AX
IC	20812-34793AX
Applicant's name / address	Signify (China) Investment Co., Ltd No.9, Lane 888, Tian Lin Road, 200233, Shanghai, China
Test method requested, standard	47 CFR FCC Part 15 (Section 15.247) ANSI C63.10: 2013 RSS-Gen Issue 5 RSS-247 Issue 3
Verdict Summary	IN COMPLIANCE
Documented by (name / position & signature)	Jun Xu/ Project Engineer 
Approved by (name / position & signature)	Jack Zhang/ Manager 
Date of issue	2024-05-24
Report Version	V1.0
Report template No	Template_FCC Part 15C-RF-V1.0

## INDEX

	page
General conditions .....	5
Environmental conditions .....	5
Possible test case verdicts .....	6
Abbreviations .....	6
Document History .....	7
Remarks and Comments.....	7
Used Equipment .....	8
Uncertainty .....	11
1 General Information.....	12
1.1 General Description of the Item(s) .....	12
1.2 Antenna Information .....	13
1.3 Channel List .....	14
2 Description of Test Setup .....	15
2.1 Operating mode(s) used for tests.....	15
2.2 Auxiliary equipment / Test software for the EUT.....	15
2.3 Test Configuration / Block diagram used for tests .....	16
2.4 Testing process .....	18
3 Verdict summary section .....	19
3.1 Standards.....	19
3.2 Deviation(s) from the Standard(s) / Test Specification(s).....	19
3.3 Overview of results.....	20
3.4 Power setting in test .....	22
3.5 Test Matrix .....	22
3.6 Test Facility.....	23
4 Test Items Of Limit/Setup/Procedure .....	24
4.1 DTS Bandwidth .....	24
4.1.1 Limit .....	24
4.1.2 Test Setup.....	24
4.1.3 Test Procedure .....	24
4.2 Occupied Channel Bandwidth.....	25
4.2.1 Limit .....	25
4.2.2 Test Setup.....	25
4.2.3 Test Procedure .....	25
4.3 Maximum Conducted Output Power .....	26

---

4.3.1	Limit .....	26
4.3.2	Test Setup .....	26
4.3.3	Test Procedure .....	27
4.4	Maximum Power Spectral Density .....	28
4.4.1	Limit .....	28
4.4.2	Test Setup .....	28
4.4.3	Test Procedure .....	28
4.5	Band Edge Measurements .....	29
4.5.1	Limit .....	29
4.5.2	Test Setup .....	29
4.5.3	Test Procedure .....	29
4.6	Conducted Spurious Emission .....	30
4.6.1	Limit .....	30
4.6.2	Test Setup .....	30
4.6.3	Test Procedure .....	30
4.7	Duty cycle .....	31
4.7.1	Limit .....	31
4.7.2	Test Setup .....	31
4.7.3	Test Procedure .....	31
4.8	Emissions in Restricted Bands .....	32
4.8.1	Limit .....	32
4.8.2	Test Setup .....	34
4.8.3	Test Procedure .....	35
4.9	AC Power Line Conducted Emission .....	36
4.9.1	Limit .....	36
4.9.2	Test Setup .....	36
4.9.3	Test Procedure .....	36
4.10	Antenna Requirement.....	37
4.10.1	Limit: .....	37
4.10.2	Antenna Connector Construction: .....	37
5	Test setup photo and EUT Photo.....	37
6	Test Result.....	38
	Appendix A: DTS Bandwidth .....	38
	Appendix B: Occupied Channel Bandwidth.....	40
	Appendix C: Maximum conducted output power .....	42
	Appendix D: Maximum power spectral density.....	43
	Appendix E: Band edge measurements.....	45

---

Appendix F Conducted Spurious Emission .....	53
Appendix G: Duty Cycle .....	77
Appendix H: Emissions in Restricted Bands .....	79
Appendix I: AC Power Line Conducted Emission .....	87

## COMPETENCES AND GUARANTEES

DEKRA is a testing laboratory competent to carry out the tests described in this report.

In order to assure the traceability to other national and international laboratories, DEKRA has a calibration and maintenance program for its measurement equipment.

DEKRA guarantees the reliability of the data presented in this report, which is the result of the measurements and the tests performed to the item under test on the date and under the conditions stated in the report and it is based on the knowledge and technical facilities available at DEKRA at the time of performance of the test.

DEKRA is liable to the client for the maintenance of the confidentiality of all information related to the item under test and the results of the test.

The results presented in this Test Report apply only to the particular item under test established in this document.

**IMPORTANT:** No parts of this report may be reproduced or quoted out of context, in any form or by any means, except in full, without the previous written permission of DEKRA.

## GENERAL CONDITIONS

Test Location	No. 99, Hongye Road, Suzhou Industrial Park Suzhou, 215006, P.R. China
Date(receive sample)	Mar. 06, 2024
Date (start test)	Apr. 08, 2024
Date (finish test)	Apr. 26, 2024

1. This report is only referred to the item that has undergone the test.
2. This report does not constitute or imply on its own an approval of the product by the Certification Bodies or Competent Authorities.
3. This document is only valid if complete; no partial reproduction can be made without previous written permission of DEKRA.
4. This test report cannot be used partially or in full for publicity and/or promotional purposes without previous written permission of DEKRA.

## ENVIRONMENTAL CONDITIONS

The climatic conditions during the tests are within the limits specified by the manufacturer for the operation of the EUT and the test equipment. The climatic conditions during the tests were within the following limits:

Ambient temperature	15 °C – 35 °C
Relative Humidity air	30% - 60%

If explicitly required in the basic standard or applied product / product family standard the climatic values are recorded and documented separately in this test report.

## POSSIBLE TEST CASE VERDICTS

Test case does not apply to test object	N/A
Test object does meet requirement	P (Pass) / PASS
Test object does not meet requirement	F (Fail) / FAIL
Not measured	N/M

## ABBREVIATIONS

For the purposes of the present document, the following abbreviations apply:

EUT	: Equipment Under Test
QP	: Quasi-Peak
CAV	: CISPR Average
AV	: Average
CDN	: Coupling Decoupling Network
SAC	: Semi-Anechoic Chamber
OATS	: Open Area Test Site
BW	: Bandwidth
AM	: Amplitude Modulation
PM	: Pulse Modulation
HCP	: Horizontal Coupling Plane
VCP	: Vertical Coupling Plane
$U_N$	: Nominal voltage
$T_x$	: Transmitter
$R_x$	: Receiver
N/A	: Not Applicable
N/M	: Not Measured

## DOCUMENT HISTORY

Report No.	Version	Description	Issued Date
2430177R-RF-US-P06V02	V1.0	Initial issue of report.	2024-05-24

## REMARKS AND COMMENTS

1. The equipment under test (EUT) does meet the essential requirements of the stated standard(s)/test(s).
2. These test results on a sample of the device are for the purpose of demonstrating Compliance with 47 CFR FCC Part 15 (Section 15.247),RSS-247 Issue 3. RSS-Gen Issue 5.
3. The measurement result is considered in conformance with the requirement if it is within the prescribed limit, It is not necessary to account the uncertainty associated with the measurement result.
4. The test results presented in this report relate only to the object tested.
5. The test report shall not be reproduced without the written approval of DEKRA Testing and Certification (Suzhou) Co., Ltd.
6. This report will not be used for social proof function in China market.
7. DEKRA declines any responsibility with the following test data provided by customer that may affect the validity of result:
  - Chapter 1.1 General Description of the Item(s);
  - Chapter 1.2 Antenna Informaion;
  - Chapter 1.3 Channel List.

## USED EQUIPMENT

Conducted Test/ TR8

Instrument	Manufacturer	Model No.	Serial No.	Cal. Date	Next Cal. Date	Firmware Version	Software version
Wireless Connectivity Tester	R&S	CMW 270	102593	2023.05.20	2024.05.19	V 4.0.60	N/A
Coaxial Cable	N/A	N/A	2477	2023.06.08	2024.06.07	N/A	N/A
Coaxial Cable	N/A	N/A	2478	2023.06.08	2024.06.07	N/A	N/A
High and low temperature and fast temperature change test box	ASTUOD	ASTD-FBT-225K	N/A	2023.05.20	2024.05.19	N/A	N/A
Temperature/Humidity Meter	RTS	RTS-8S	RF08	2023.08.25	2024.08.24	N/A	N/A
Test system							
Instrument	Manufacturer	Model No.	Serial No.	Cal. Date	Next Cal. Date	Firmware Version	Software version
MAX Signal Analyzer	Keysight	N9010A	MY48030494	2023.11.08	2024.11.07	A.14.03	N/A
RF Control Unit	Tonscend	JS0806-2	22G8060594	2024.02.06	2025.02.05	N/A	N/A
RF Control Unit	Tonscend	JS0806-2	22G8060594	2024.01.31	2025.01.30	N/A	N/A
MXG-B RF Vector Signal Generator	Keysight	N5182B	MY61252529	2023.05.20	2024.05.19	B.01.96	N/A
Frequency extender for EXG or MXG	Keysight	N5182BX07	MY59362500	2023.05.20	2024.05.19	N/A	N/A
EXG-B MW Analog Signal Generator	Keysight	N5173B	MY61252566	2023.08.26	2024.08.25	B.01.95	N/A
Test Software	Tonscend	TS1120	JS1120-3	N/A	N/A	N/A	V3.0.22



## AC Power Line Conducted Emission / TR1

Instrument	Manufacturer	Model No.	Serial No.	Cal. Date	Next Cal. Date	Firmware Version	Software version
EMI Test Receiver	R&S	ESCI	100726	2023.08.26	2024.08.25	4.42 SP1	N/A
Two-Line V-Network	R&S	ENV 216	101044	2023.11.08	2024.11.07	N/A	N/A
Two-Line V-Network	R&S	ENV 216	101189	2023.05.14	2024.05.13	N/A	N/A
50ohm Coaxial Switch	Anritsu	MP59B	6200464462	2023.05.14	2024.05.13	N/A	N/A
Coaxial Cable	Huber+Suhner	RG 223	TR1-C1	2023.05.14	2024.05.13	N/A	N/A
Impedance Stabilization Network	Teseq GmbH	ISN T800	57318	2024.01.20	2025.01.19	N/A	N/A
Temperature/Humidity Meter	RTS	RTS-8S	EMC01	2023.05.19	2024.05.18	N/A	N/A
Dekra test software	Dekra	N/A	N/A	N/A	N/A	N/A	N/A

## Radiated Emission(9KHz-1GHz) / AC2

Instrument	Manufacturer	Model No.	Serial No.	Cal. Date	Next Cal. Date	Firmware Version	Software version
EMI Test Receiver	R&S	ESCI	100573	2023.09.15	2024.09.14	4.42 SP3	N/A
Loop Antenna	R&S	HFH2-Z2E	101149	2023.04.25	2024.04.24	N/A	N/A
Bilog Antenna	Teseq GmbH	CBL6112D	27611	2023.09.13	2024.09.12	N/A	N/A
Temperature/Humidity Meter	RTS	RTS-8S	AC2-TH	2023.05.19	2024.05.18	N/A	N/A
Coaxial Cable	Huber+Suhner	SUCOFLEX 106	AC2-C	2023.05.21	2024.05.20	N/A	N/A
Dekra test software	Dekra	N/A	N/A	N/A	N/A	N/A	3

## Radiated Emission (1GHz-40GHz) / AC5

Instrument	Manufacturer	Model No.	Serial No.	Cal. Date	Next Cal. Date	Firmware Version	Software version
EXA Spectrum Analyzer	Keysight	N9020B	MY60112218	2023.11.08	2024.11.07	A.31.05	N/A
Pre-Amplifier	SKET	LNPA_0118G-45	SK2021090101	2023.05.14	2024.05.13	N/A	N/A
Preamplifier	CHENGYI	EMC184045SE	980263	2023.07.09	2024.07.08	N/A	N/A
DRG Horn	ETS-Lindgren	3117	00123988	2023.09.16	2024.09.15	N/A	N/A
Broad-Band Horn Antenna	Schwarzbeck	BBHA9170	294	2023.05.31	2024.05.30	N/A	N/A
Filter Switch Box	MVE	MSW-F196	C070001S	2023.05.21	2024.05.20	N/A	N/A
Temperature/Humidity Meter	RTS	RTS-8S	AC5-TH	2023.05.19	2024.05.18	N/A	N/A
Coaxial Cable	ROSENBERGER	LA1-C011-2000/3000	AC5-40G	2024.01.25	2025.01.24	N/A	N/A
Coaxial Cable	ROSENBERGER	LA1-C011-2000/3000	AC5-40G-2	2023.05.21	2024.05.20	N/A	N/A
Cable	Rosenberger	LA1-C011-1000	0523	2023.05.21	2024.05.20	N/A	N/A
Dekra test software	Dekra	N/A	N/A	N/A	N/A	N/A	3

## UNCERTAINTY

Uncertainties have been calculated according to the DEKRA internal document. The reported expanded uncertainties are based on a standard uncertainty multiplied by a coverage factor of  $k=2$ , providing a level of confidence of approximately 95% .

Test item	Uncertainty
AC Power Line Conducted Emission	9kHz~150kHz: 2.80dB 150kHz~30MHz: 2.40dB
Peak Power Output	$\pm 1.27$ dB
Radiated Emission(30MHz~1GHz)	Horizontal: 30MHz~200MHz: 3.50 dB 300MHz~1GHz: 3.60 dB Vertical: 30MHz~200MHz: 3.60 dB 300MHz~1GHz: 3.50 dB
Radiated Emission(1GHz~26.5GHz)	Horizontal: 1GHz~18GHz: 5.00 dB Vertical: 1GHz~18GHz: 4.80 dB Horizontal: 18GHz~26.5GHz: 5.30 dB Vertical: 18GHz~26.5GHz: 4.90 dB
RF antenna conducted test	$\pm 1.27$ dB
Radiated Emission Band Edge	$\pm 3.9$ dB
DTS Bandwidth	$\pm 150$ Hz
Occupied Bandwidth	$\pm 150$ Hz
Power Density	$\pm 1.27$ dB

# 1 GENERAL INFORMATION

## 1.1 General Description of the Item(s)

Product Name..... :	LED lamp
Model No. .... :	9290034793
Trademark. .... :	<b>PHILIPS</b> hue 
FCC ID ..... :	2AGBW9290034793AX
IC..... :	20812-34793AX
Manufacturer..... :	Signify (China) Investment Co., Ltd
Manufacturer Address..... :	No.9, Lane 888, Tian Lin Road, 200233, Shanghai, China

Wireless specification..... :	Zigbee
Operating frequency range(s)	2405~2480MHz
Type of Modulation..... :	O-QPSK
Data Rate ..... :	250kbps
Number of channel..... :	16

Rated power supply .....	Voltage and Frequency	
	<input type="checkbox"/>	AC: 220 - 240 V, 50/60 Hz
	<input checked="" type="checkbox"/>	AC: 110 - 130 V, 50/60 Hz
	<input type="checkbox"/>	DC: 24 Vdc
	<input type="checkbox"/>	Poe:
	<input type="checkbox"/>	Adapter:
Mounting position..... :	<input type="checkbox"/>	Tabletop equipment
	<input checked="" type="checkbox"/>	Wall/Ceiling mounted equipment
	<input type="checkbox"/>	Floor standing equipment
	<input type="checkbox"/>	Hand-held/Portable equipment
	<input type="checkbox"/>	Other:

## 1.2 Antenna Information

Antenna model / type number.....:	N/A		
Antenna serial number .....	N/A		
Antenna Delivery .....	<input checked="" type="checkbox"/>	1TX + 1RX	
	<input type="checkbox"/>	2TX + 2RX	
	<input type="checkbox"/>	Others: .....	
Antenna technology.....:	<input checked="" type="checkbox"/>	SISO	
	<input type="checkbox"/>	MIMO	<input type="checkbox"/> CDD
			<input type="checkbox"/> Beam-forming
Antenna Type.....:	<input type="checkbox"/>	External	<input type="checkbox"/> Dipole
			<input type="checkbox"/> Sectorized
			<input type="checkbox"/> Ceramic Chip
	<input checked="" type="checkbox"/>	Internal	<input type="checkbox"/> PIFA
			<input checked="" type="checkbox"/> PCB
			<input type="checkbox"/> Others.....
Antenna Gain.....:	3.0dBi		

### 1.3 Channel List

Working Frequency of Each Channel: For Zigbee							
Channel	Frequency	Channel	Frequency	Channel	Frequency	Channel	Frequency
11	2405 MHz	12	2410 MHz	13	2415 MHz	14	2420 MHz
15	2425 MHz	16	2430 MHz	17	2435 MHz	18	2440 MHz
19	2445 MHz	20	2450 MHz	21	2455 MHz	22	2460 MHz
23	2465 MHz	24	2470 MHz	25	2475 MHz	26	2480 MHz

Note: The General Description of the Item , antenna information and Channel List for the EUT in clause 1 are provided and confirmed by the client.

## 2 DESCRIPTION OF TEST SETUP

### 2.1 Operating mode(s) used for tests

During the tests the following operating mode(s) has(have) been used.

Test Mode For Bluetooth	Mode 1: Transmit by Zigbee
-------------------------	----------------------------

Note : Regards to the frequency band operation: the lowest, middle and highest frequency channel were selected to perform the test, then shown on this report.

### 2.2 Auxiliary equipment / Test software for the EUT

Auxiliary equipment	Type / Version	Manufacturer	Supplied by
(1) Notebook	Think pad x220	Lenovo	Adapter
(2) USB Control Cable	N/A	N/A	N/A
(3) USB Control Cable	N/A	N/A	N/A
software	Type / Version	Manufacturer	Supplied by
HueApprobationTool	N/A	N/A	N/A

Accessories Information	Cable		
	Length used during test [m]	Attached during test	Shielded
(2)USB Control Cable	1	<input checked="" type="checkbox"/>	<input checked="" type="checkbox"/>
(3)USB Control Cable	8	<input checked="" type="checkbox"/>	<input checked="" type="checkbox"/>

### 2.3 Test Configuration / Block diagram used for tests

Test setup Diagram- AC Line Conducted Emission Test

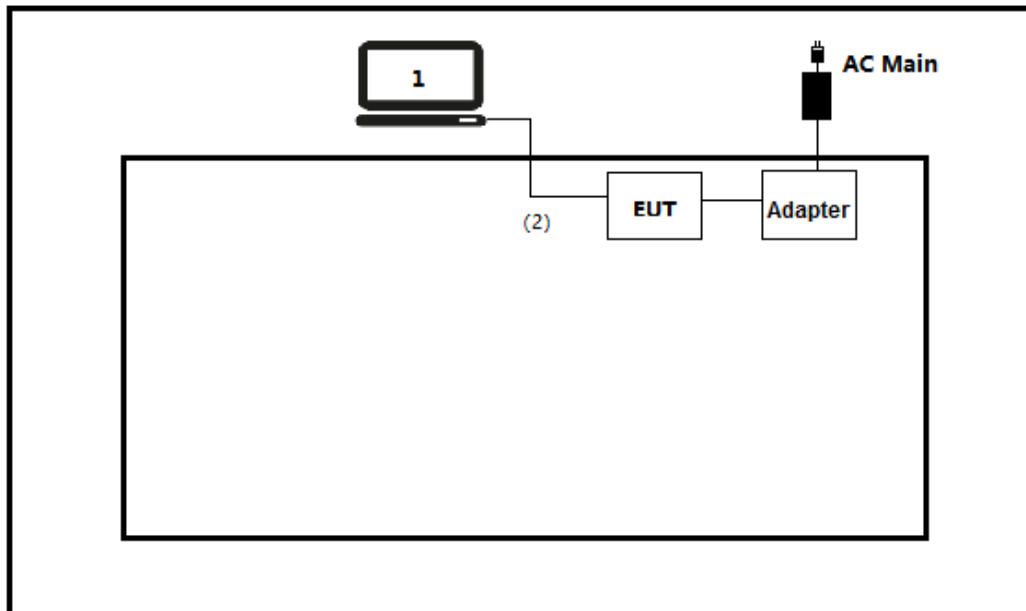

Test setup Diagram- Conducted test

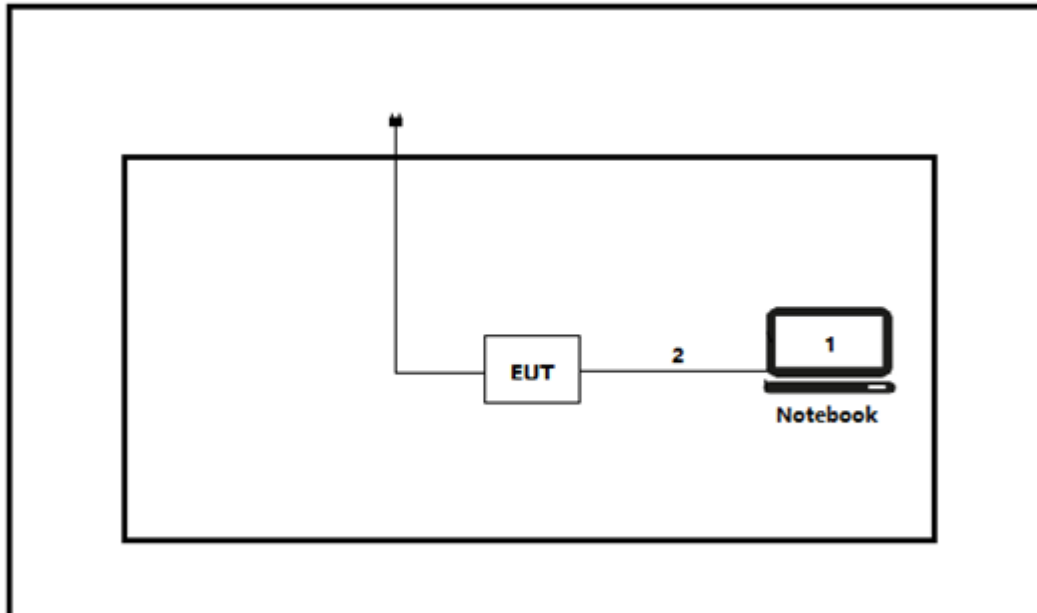



Test setup Diagram- Radiated Emission

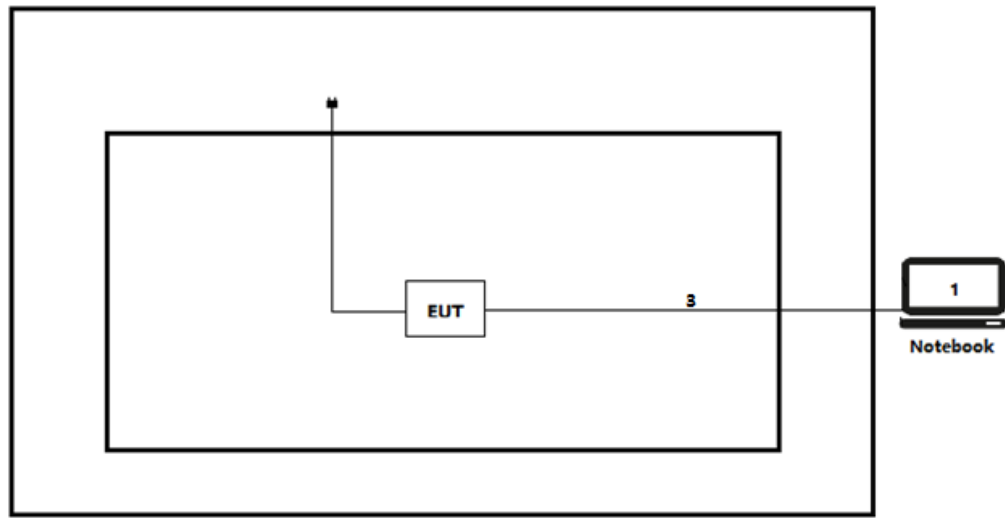

## 2.4 Testing process

1	Setup the EUT shown in Section 2.3.
2	Execute the [HueApprobationTool]on the notebook.
3	Configure the test mode, the test channel, and the data rate.
4	Verify that the EUT works properly.

### 3 VERDICT SUMMARY SECTION

This chapter presents an overview of standards and results. Refer to the next chapters for details of measured test results and applied test levels.

#### 3.1 Standards

Standard	Year	Description
CFR 47, FCC Part 15 C	2024	Operation within the bands 902–928 MHz, 2400–2483.5 MHz, and 5725–5850 MHz.
ANSI C63.10	2013	American National Standard of Procedures for Compliance Testing of Unlicensed Wireless Devices
RSS-Gen Issue 5 Amendment 2	2021	General Requirements for Compliance of Radio Apparatus
RSS-247 Issue 3	2023	Digital Transmission Systems (DTSS), Frequency Hopping Systems (FHSs) and Licence-Exempt Local Area Network (LE-LAN) Devices

#### 3.2 Deviation(s) from the Standard(s) / Test Specification(s)

The following deviation(s) was / were made from the published requirements of the listed standards: N/A.

*(Please define the deviations from the standard(s) if applicable)*

### 3.3 Overview of results

Requirement – Test Item of FCC	Standard(s)	Verdict	Remark
20dB Emission Bandwidth	FCC 15.247(a)(2)	PASS	Test data please refer to <b>Appendix A</b>
Maximum conducted output power	15.247 (b)(3)	PASS	Test data please refer to <b>Appendix C</b>
Maximum power spectral density	FCC 15.247(e)	PASS	Test data please refer to <b>Appendix D</b>
Band edge measurements	FCC 15.247(d) FCC 15.205 FCC 15.209	PASS	Test data please refer to <b>Appendix E</b>
Conducted Spurious Emission	FCC 15.247(d), FCC 15.209	PASS	Test data please refer to <b>Appendix F</b>
Duty cycle	ANSI C63.10:2013	PASS	Test data please refer to <b>Appendix G</b>
Emissions in Restricted Bands	FCC 15.205 FCC 15.209	PASS	Test data please refer to <b>Appendix H</b>
AC Power Line Conducted Emission	FCC 15.207	PASS	Test data please refer to <b>Appendix I</b>
Antenna Requirement	FCC 15.203	PASS	---

Requirement – Test case of ISED	Standard(s)	Verdict	Remark
DTS Bandwidth	RSS-Gen Issue 5 Paragraph 6.7 RSS-247 Issue 3 Paragraph 5.2	PASS	Test data please refer to <b>Appendix A</b>
Occupied Channel Bandwidth	RSS-Gen Issue 5 Paragraph 6.7 RSS-247 Issue 3 Paragraph 5.2	PASS	Test data please refer to <b>Appendix B</b>
Maximum conducted output power	RSS-247 Issue 3 Paragraph 5.4(d)	PASS	Test data please refer to <b>Appendix C</b>
Maximum power spectral density	RSS-247 Issue 3 Paragraph 5.2(b)	PASS	Test data please refer to <b>Appendix D</b>
Band edge measurements	RSS-Gen Issue 5 Paragraph 8.10	PASS	Test data please refer to <b>Appendix E</b>
Conducted Spurious Emission	RSS-247 Issue 3 Paragraph 5.5	PASS	Test data please refer to <b>Appendix F</b>
Duty cycle	ANSI C63.10:2013	PASS	Test data please refer to <b>Appendix G</b>
Emissions in Restricted Bands	RSS-Gen Issue 5 Paragraph 8.9	PASS	Test data please refer to <b>Appendix H</b>
AC Power Line Conducted Emission	RSS-Gen Issue 5 Paragraph 8.8	PASS	Test data please refer to <b>Appendix I</b>
Antenna Requirement	RSS-Gen Issue 5 Paragraph 6.8	PASS	---

### 3.4 Power setting in test

Mode	Channel	Frequency (MHz)	Power setting
Mode1	00	2405	8
	19	2440	8
	39	2480	8

### 3.5 Test Matrix

Test item	Model: 9290034793	
	1(#1)	2(#2)
DTS Bandwidth	<input checked="" type="checkbox"/>	<input type="checkbox"/>
Occupied Channel Bandwidth	<input checked="" type="checkbox"/>	<input type="checkbox"/>
Maximum conducted output power	<input checked="" type="checkbox"/>	<input type="checkbox"/>
Maximum power spectral density	<input checked="" type="checkbox"/>	<input type="checkbox"/>
Band edge measurements	<input type="checkbox"/>	<input checked="" type="checkbox"/>
Conducted Spurious Emission	<input checked="" type="checkbox"/>	<input type="checkbox"/>
Duty cycle	<input checked="" type="checkbox"/>	<input type="checkbox"/>
Emissions in Restricted Bands	<input type="checkbox"/>	<input checked="" type="checkbox"/>
AC Power Line Conducted Emission	<input type="checkbox"/>	<input checked="" type="checkbox"/>

Note1: The only difference between sample #1 and sample #2 is whether to keep the original antenna, sample #1 is a conduction test product that removes the original antenna and is equipped with SMA wires, and sample #2 is a complete product that retains the original antenna.

### 3.6 Test Facility

USA	:	FCC Designation Number: CN1199
CA	:	ISED CAB identifier: CN0040

## 4 TEST ITEMS OF LIMIT/SETUP/PROCEDURE

### 4.1 DTS Bandwidth

VERDICT: PASS

#### 4.1.1 Limit

**Standard**

FCC Part 15 Subpart C Paragraph 15.247 (a)(2); RSS-247 Issue 3 Paragraph 5.2.

Systems using digital modulation techniques operate in the 2400-2483.5 MHz. The minimum 6 dB bandwidth shall be at least 500 kHz

#### 4.1.2 Test Setup

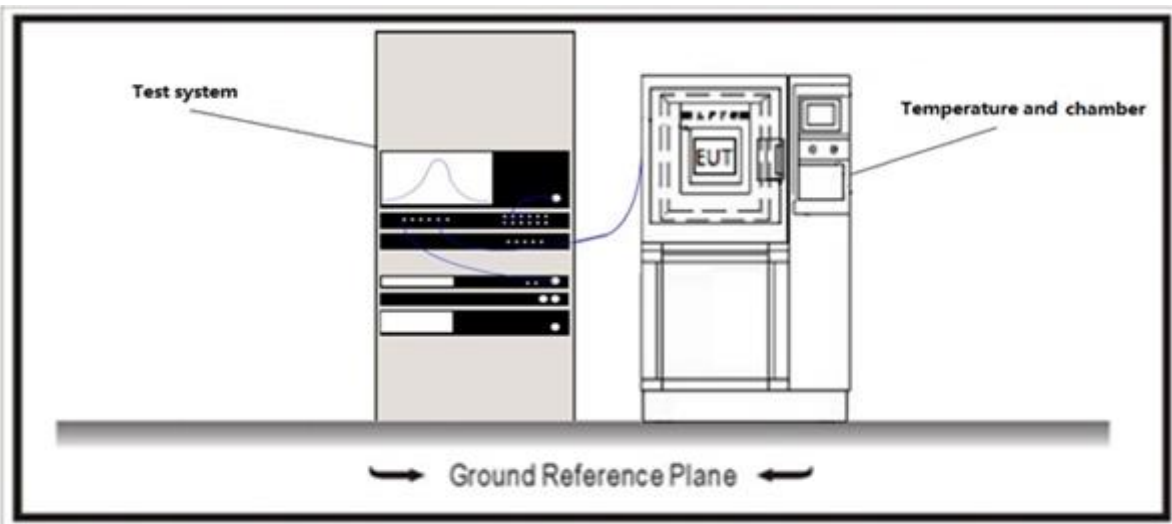

#### 4.1.3 Test Procedure

	Reference Rule	Chapter	Description
<input checked="" type="checkbox"/>	ANSI C63.10	11.8	DTS bandwidth
<input checked="" type="checkbox"/>	ANSI C63.10	11.8.1	Option 1
<input type="checkbox"/>	ANSI C63.10	11.8.2	Option 2



**4.2 Occupied Channel Bandwidth**

**VERDICT: PASS**

**4.2.1 Limit**

**Standard** RSS-Gen Issue 5 Paragraph 6.7

The occupied bandwidth or the “99% emission bandwidth” is defined as the frequency range between two points, one above and the other below the carrier frequency, within which 99% of the total transmitted power of the fundamental transmitted emission is contained. The occupied bandwidth shall be reported for all equipment in addition to the specified bandwidth required in the applicable RSSs

**4.2.2 Test Setup**

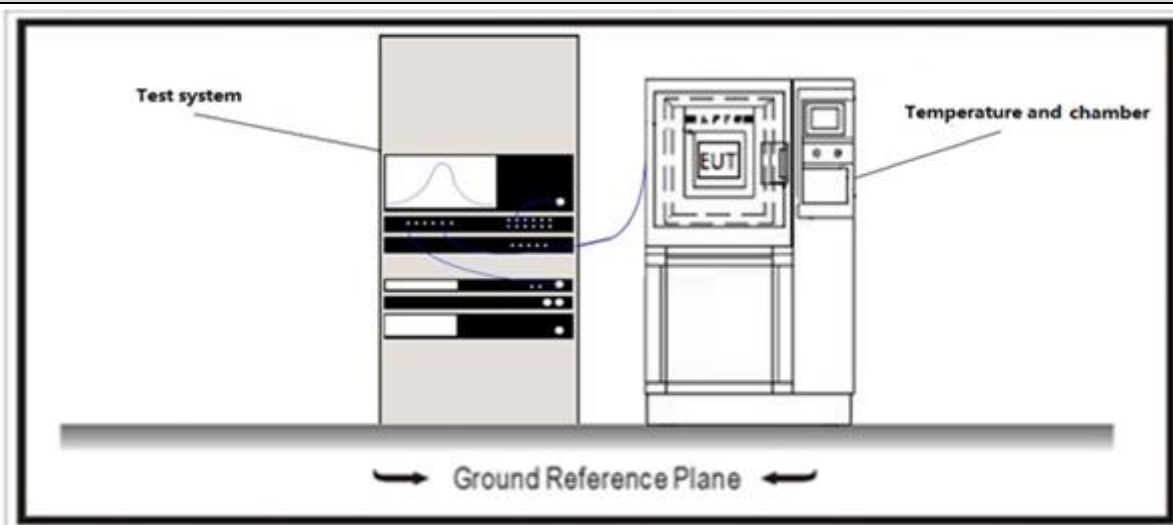

**4.2.3 Test Procedure**

	Reference Rule	Chapter	Description
<input checked="" type="checkbox"/>	ANSI C63.10	6.9	Occupied bandwidth tests
<input type="checkbox"/>	ANSI C63.10	6.9.2	Option 1
<input checked="" type="checkbox"/>	ANSI C63.10	6.9.3	Option 2

**4.3 Maximum Conducted Output Power**

**VERDICT: PASS**

**4.3.1 Limit**

<b>Standard</b>		FCC Part 15 Subpart C Paragraph 15.247 (b)(3); RSS-247 Issue 3 Paragraph 5.4(d).
<input checked="" type="checkbox"/>	GTX < 6dBi	Pout ≤ 30dBm
<input type="checkbox"/>	GTX > 6dBi	
<input type="checkbox"/>	Non-Fix point-point	Pout ≤ 30 - (GTX - 6)
<input type="checkbox"/>	Fix point-point	Pout ≤ 30 - [(GTX - 6)]/3
<input type="checkbox"/>	Point-to-multipoint	Pout ≤ 30 - (GTX - 6)
<input type="checkbox"/>	Overlap Beams	Pout ≤ 30 - [(GTX - 6)]/3
<input type="checkbox"/>	Aggregate power transmitted simultaneously on all beams	Pout ≤ 30 - [(GTX - 6)]/3
<input type="checkbox"/>	single directional beam	Pout ≤ 30 - [(GTX - 6)]/3 + 8dB

Note 1 : GTX directional gain of transmitting antennas.  
Note 2 : Pout is maximum peak conducted output power .

**4.3.2 Test Setup**

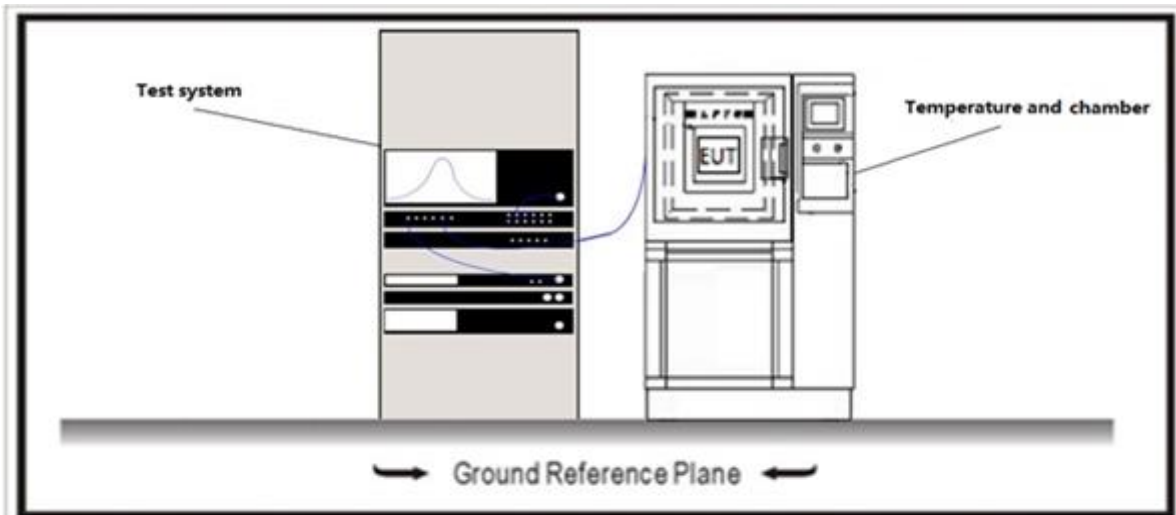

**4.3.3 Test Procedure**

	References Rule		Chapter	Description	
<input checked="" type="checkbox"/>	ANSI C63.10		11.9	Fundamental emission output power	
<input type="checkbox"/>	<input checked="" type="checkbox"/>	ANSI C63.10	11.9.1	Maximum peak conducted output power	
	<input type="checkbox"/>	ANSI C63.10	11.9.1.1	RBW $\geq$ DTS bandwidth	
	<input type="checkbox"/>	ANSI C63.10	11.9.1.2	Integrated band power method	
	<input checked="" type="checkbox"/>	ANSI C63.10	11.9.1.3	PKPM1 Peak power meter method	
	<input type="checkbox"/>	ANSI C63.10		11.9.2	Maximum conducted (average) output power
	<input type="checkbox"/>	ANSI C63.10	11.9.2.2	Measurement using a spectrum analyzer (SA)	
	<input type="checkbox"/>	ANSI C63.10	11.9.2.2.2	Method AVGSA-1(Duty cycle $\geq$ 98%)	
	<input type="checkbox"/>	ANSI C63.10	11.9.2.2.3	Method AVGSA-1A(Duty cycle $\geq$ 98%)	
	<input type="checkbox"/>	ANSI C63.10	11.9.2.2.4	Method AVGSA-2(Duty cycle $\leq$ 98%)	
	<input type="checkbox"/>	ANSI C63.10	11.9.2.2.5	Method AVGSA-2A(Duty cycle $\leq$ 98%)	
	<input type="checkbox"/>	ANSI C63.10	11.9.2.2.4	Method AVGSA-3	
	<input type="checkbox"/>	ANSI C63.10	11.9.2.2.5	Method AVGSA-3A	
	<input type="checkbox"/>	ANSI C63.10		11.9.2.3	Measurement using a power meter (PM)
	<input type="checkbox"/>	ANSI C63.10	11.9.2.3.1	Method AVGPM	
<input type="checkbox"/>	ANSI C63.10	11.9.2.3.2	Method AVGPM-G		

**4.4 Maximum Power Spectral Density**

**VERDICT: PASS**

**4.4.1 Limit**

**Standard**

FCC Part 15 Subpart C Paragraph 15.247 (b)(3);  
RSS-247 Issue 3 Paragraph 5.2(b).

Power Spectral Density ≤ 8dBm/3kHz

**4.4.2 Test Setup**

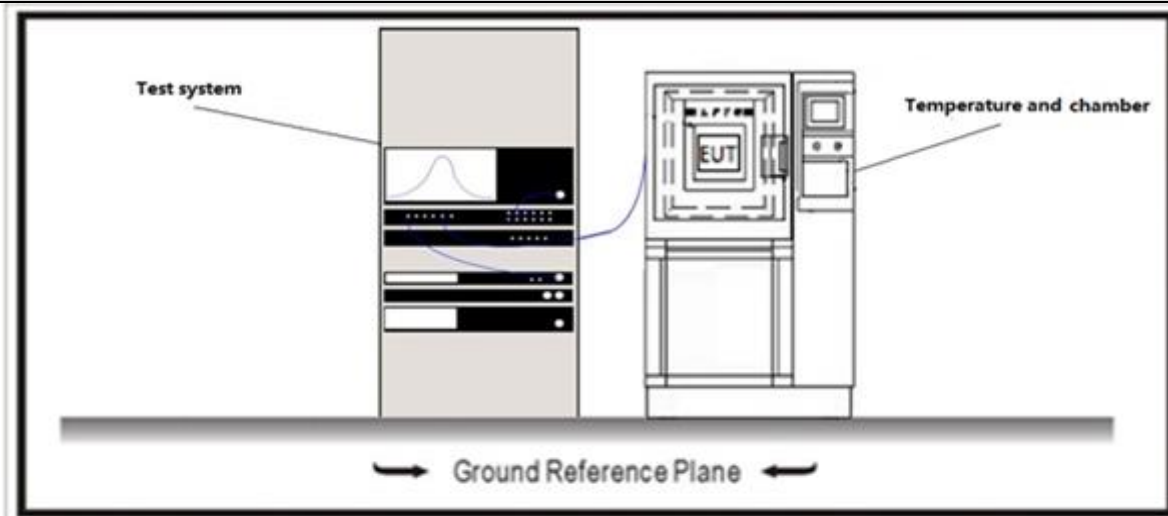

**4.4.3 Test Procedure**

	References Rule	Chapter	Description
<input checked="" type="checkbox"/>	ANSI C63.10	11.10	Maximum power spectral density level in the fundamental emission
<input checked="" type="checkbox"/>	ANSI C63.10	11.10.2	Method PKPSD (peak PSD)
<input type="checkbox"/>	ANSI C63.10	11.10.3	Method AVGPSD-1(Duty cycle ≥ 98%)
<input type="checkbox"/>	ANSI C63.10	11.10.4	Method AVGPSD-1A(Duty cycle ≥ 98%)
<input type="checkbox"/>	ANSI C63.10	11.10.5	Method AVGPSD-2(Duty cycle < 98%)
<input type="checkbox"/>	ANSI C63.10	11.10.6	Method AVGPSD-2A(Duty cycle < 98%)
<input type="checkbox"/>	ANSI C63.10	11.10.7	Method AVGPSD-3
<input type="checkbox"/>	ANSI C63.10	11.10.8	Method AVGPSD-3A

<b>4.5 Band Edge Measurements</b>	<b>VERDICT: PASS</b>
-----------------------------------	----------------------

**4.5.1 Limit**

<b>Standard</b>	FCC Part 15 Subpart C Paragraph 15.247(d) , 15.209; RSS-Gen Issue 5 Paragraph 8.10.			
Frequency bands (MHz)	Detector	Limit (dBµV/m)	RBW (MHz)	Distance (m)
2310-2390	PK	74	1	3
2483.5-2500	AV	54	1	3

Note: The field strength of emissions appearing within these frequency bands shall not exceed the limits.

**4.5.2 Test Setup**

Above 1GHz Test Setup:

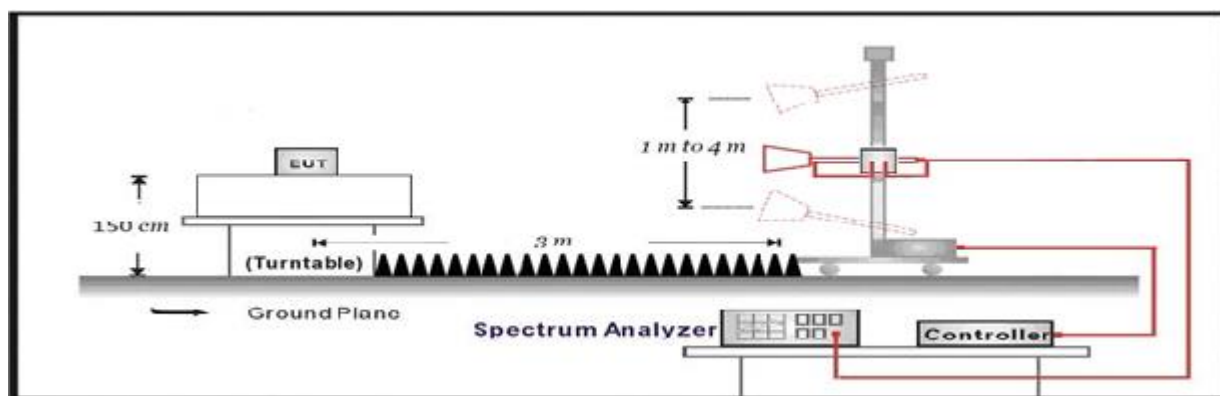

**4.5.3 Test Procedure**

	References Rule	Chapter	Description
<input checked="" type="checkbox"/>	ANSI C63.10	6.10	Band-edge testing
	<input checked="" type="checkbox"/> ANSI C63.10	6.10.5	Restricted-band band-edge measurements
	<input type="checkbox"/> ANSI C63.10	6.10.6	Marker-delta method
<input checked="" type="checkbox"/>	ANSI C63.10	11.12	Emissions in restricted frequency bands
	<input checked="" type="checkbox"/> ANSI C63.10	11.12.1	Radiated emission measurements
	<input checked="" type="checkbox"/> ANSI C63.10	11.12.2.7	Radiated spurious emission test
<input type="checkbox"/>	ANSI C63.10	6.4	Radiated emissions from unlicensed wireless devices below 30 MHz
<input type="checkbox"/>	ANSI C63.10	6.5	Radiated emissions from unlicensed wireless devices in the frequency range of 30 MHz to 1000 MHz
<input checked="" type="checkbox"/>	ANSI C63.10	6.6	Radiated emissions from unlicensed wireless devices above 1 GHz

<b>4.6 Conducted Spurious Emission</b>	<b>VERDICT: PASS</b>
--	----------------------

**4.6.1 Limit**

<b>Standard</b>	FCC Part 15 Subpart C Paragraph 15.247(d); RSS-247 Issue 3 Paragraph 5.5.	
RF Output power (Detection methods)	Limit(dB)	
RF Output power(Average detector)	30dBc(Note1)	
RF Output power(PK detector)	20dBc(Note2)	

Note 1: If maximum conducted (average) output power was used to demonstrate compliance as described in 9.2, then the peak power in any 100 kHz bandwidth outside of the authorized frequency band shall be attenuated by at least 30 dB relative to the maximum in-band peak PSD level in 100 kHz (i.e., 30 dBc).

Note 2: If the maximum peak conducted output power procedure was used, then the peak output power measured in any 100 kHz bandwidth outside of the authorized frequency band shall be attenuated by at least 20 dB relative to the maximum in-band peak PSD level in 100 kHz (i.e., 20 dBc).

**4.6.2 Test Setup**

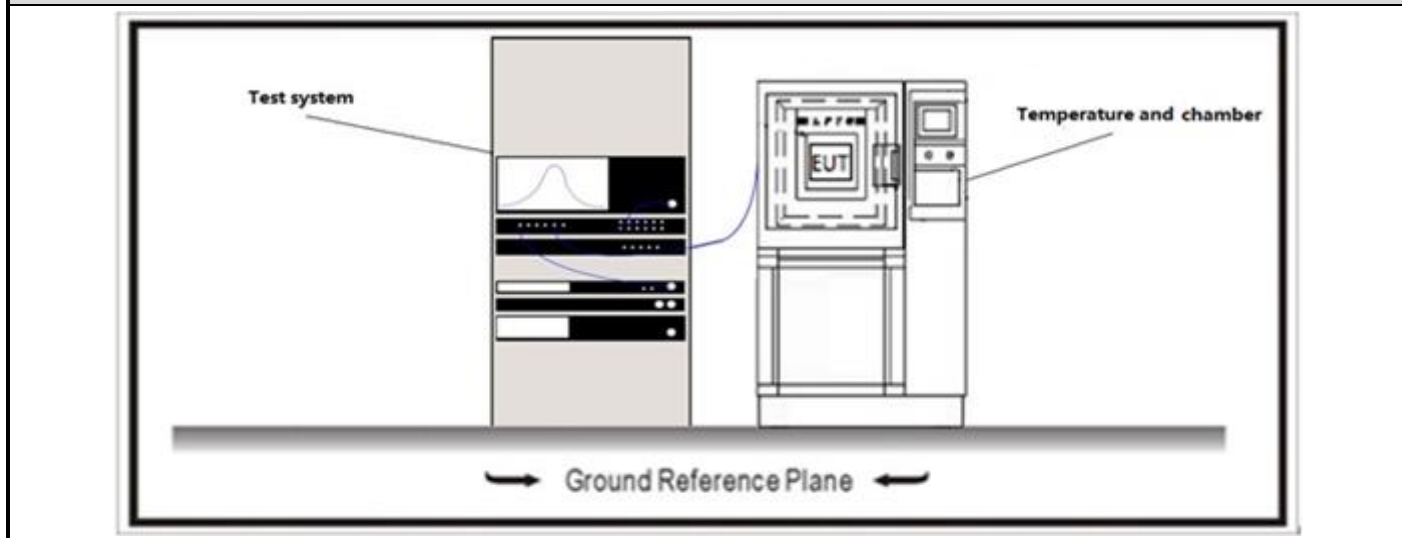

**4.6.3 Test Procedure**

References	Rule	Chapter	Description
<input checked="" type="checkbox"/>	ANSI C63.10	11.11	Emissions in non-restricted frequency bands
	<input checked="" type="checkbox"/> ANSI C63.10	11.11.1	General
	<input checked="" type="checkbox"/> ANSI C63.10	11.11.2	Reference level measurement
	<input checked="" type="checkbox"/> ANSI C63.10	11.11.3	Emission level measurement

<b>4.7 Duty cycle</b>	<b>VERDICT: PASS</b>
-----------------------	----------------------

**4.7.1 Limit**

N/A

**4.7.2 Test Setup**

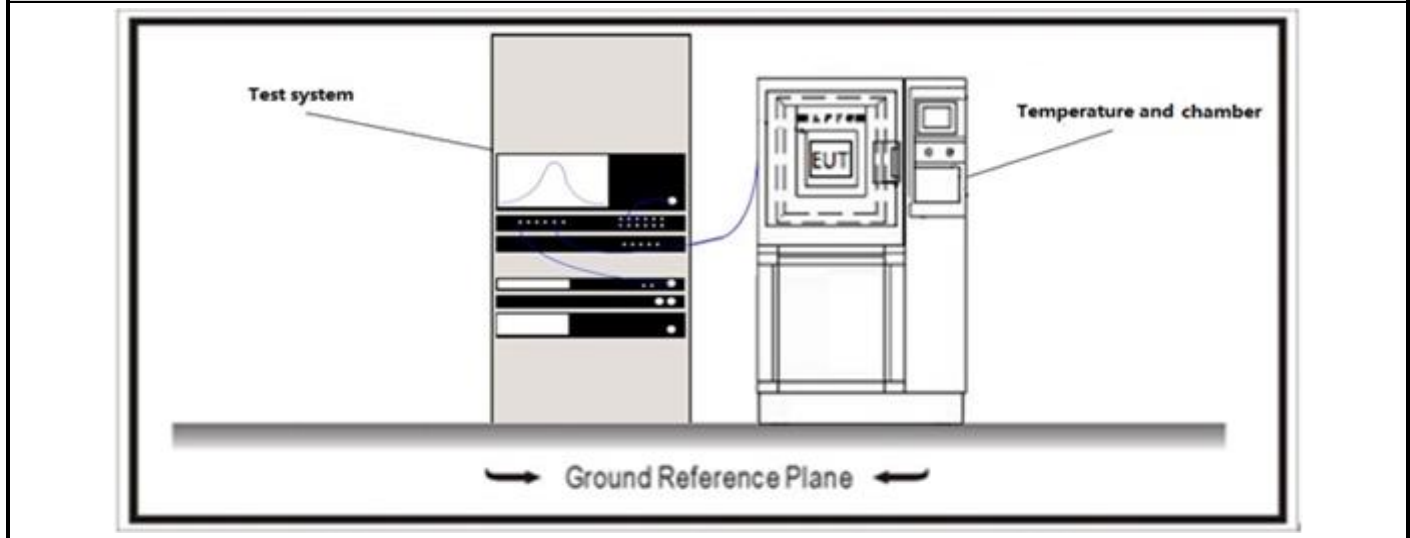

**4.7.3 Test Procedure**

References Rule	Chapter	Description
<input checked="" type="checkbox"/> ANSI C63.10	11.6	Duty cycle (D), transmission duration (T), and maximum power control level

<b>4.8 Emissions in Restricted Bands</b>	<b>VERDICT: PASS</b>
--	----------------------

**4.8.1 Limit**

<b>Standard</b>	FCC Part 15 Subpart C Paragraph 15.205
-----------------	--

Restricted Bands of operation

Frequency (MHz)	Frequency (MHz)	Frequency (MHz)	Frequency (GHz)
0.090 – 0.110	16.42 – 16.423	399.9 – 410	4.5 – 5.15
0.495 – 0.505	16.69475 – 16.69525	608 – 614	5.35 – 5.46
2.1735 – 2.1905	16.80425 – 16.80475	960 – 1240	7.25 – 7.75
4.125 – 4.128	25.5 – 25.67	1300 – 1427	8.025 – 8.5
4.17725 – 4.17775	37.5 – 38.25	1435 – 1626.5	9.0 – 9.2
4.20725 – 4.20775	73 – 74.6	1645.5 – 1646.5	9.3 – 9.5
6.215 – 6.218	74.8 – 75.2	1660 – 1710	10.6 – 12.7
6.26775 – 6.26825	108 – 121.94	1718.8 – 1722.2	13.25 – 13.4
6.31175 – 6.31225	123 – 138	2200 – 2300	14.47 – 14.5
8.291 – 8.294	149.9 – 150.05	2310 – 2390	15.35 – 16.2
8.362 – 8.366	156.52475 – 156.52525	2483.5 – 2500	17.7 – 21.4
8.37625 – 8.38675	156.7 – 156.9	2690 – 2900	22.01 – 23.12
8.81425 – 8.81475	162.0125 – 167.17	3260 – 3267	23.6 – 24.0
12.29 – 12.293	167.72 – 173.2	3332 – 3339	31.2 – 31.8
12.51975 – 12.52025	240 – 285	3345.8 – 3358	36.43 – 36.5
12.57675 – 12.57725	322 – 335.4	3600 – 4400	
13.36 – 13.41			

<b>Standard</b>	RSS-Gen Issue 5 Paragraph 8.10
-----------------	--------------------------------

Restricted Bands of operation for IC

0.090 - 0.110	13.36 - 13.41	960 - 1427	9.0 - 9.2
0.495 - 0.505	16.42 - 16.423	1435 - 1626.5	9.3 - 9.5
2.1735 - 2.1905	16.69475 - 16.69525	1645.5 - 1646.5	10.6 - 12.7
3.020 - 3.026	16.80425 - 16.80475	1660 - 1710	13.25 - 13.4
4.125 - 4.128	25.5 - 25.67	1718.8 - 1722.2	14.47 - 14.5
4.17725 - 4.17775	37.5 - 38.25	2200 - 2300	15.35 - 16.2
4.20725 - 4.20775	73 - 74.6	2310 - 2390	17.7 - 21.4
5.677 - 5.683	74.8 - 75.2	2483.5 - 2500	22.01 - 23.12
6.215 - 6.218	108 - 138	2655 - 2900	23.6 - 24.0
6.26775 - 6.26825	149.9 - 150.05	3260 - 3267	31.2 - 31.8
6.31175 - 6.31225	156.52475 - 156.52525	3332 - 3339	36.43 - 36.5
8.291 - 8.294	156.7 - 156.9	3345.8 - 3358	Above 38.6
8.362 - 8.366	162.0125 - 167.17	3500 - 4400	
8.37625 - 8.38675	167.72 - 173.2	4500 - 5150	
8.41425 - 8.41475	240 - 285	5350 - 5460	
12.29 - 12.293	322 - 335.4	7250 - 7750	
12.51975 - 12.52025	399.9 - 410	8025 - 8500	
12.57675 - 12.57725	608 - 614	--	



Restricted Band Emissions Limit			
FCC Part 15 Subpart C Paragraph 15.209			
Frequency (MHz)	Field strength (μV/m)	Field strength (dBμV/m)	Measurement distance (m)
0.009 - 0.49	2400/F(kHz)	48.5 – 13.8	300 <sub>(Note 1)</sub>
0.49 - 1.705	24000/F(kHz)	33.8 - 23	30 <sub>(Note 1)</sub>
1.705 - 30	30	29.5	30 <sub>(Note 1)</sub>
30 - 88	100	40	3 <sub>(Note 2)</sub>
88 - 216	150	43.5	3 <sub>(Note 2)</sub>
216 - 960	200	46	3 <sub>(Note 2)</sub>
Above 960	500	54	3 <sub>(Note 2)</sub>
RSS-Gen Issue 5 Paragraph 8.9.			
Frequency (MHz)	Field strength	Field strength (dBμV/m)	Measurement distance (m)
0.009 - 0.49	6.37/F(kHz) μA/m	48.5 – 13.8	300 <sub>(Note 1)</sub>
0.49 - 1.705	63.7/F(kHz) μA/m	33.8 - 23	30 <sub>(Note 1)</sub>
1.705 - 30	30 μV/m	29.5	30 <sub>(Note 1)</sub>
30 - 88	100 μV/m	40	3 <sub>(Note 2)</sub>
88 - 216	150 μV/m	43.5	3 <sub>(Note 2)</sub>
216 - 960	200 μV/m	46	3 <sub>(Note 2)</sub>
Above 960	500 μV/m	54	3 <sub>(Note 2)</sub>
<p>Note 1: At frequencies below 30 MHz, measurements may be performed at a distance closer than that specified in the regulations; however, an attempt should be made to avoid making measurements in the near field. Pending the development of an appropriate measurement procedure for measurements performed below 30 MHz, when performing measurements at a closer distance than specified, the results shall be extrapolated to the specified distance by either making measurements at a minimum of two distances on at least one radial to determine the proper extrapolation factor or by using the square of an inverse linear distance extrapolation factor (40 dB/decade).</p> <p>Note 2: At frequencies at or above 30 MHz, measurements may be performed at a distance other than what is specified provided: measurements are not made in the near field except where it can be shown that near field measurements are appropriate due to the characteristics of the device; and it can be demonstrated that the signal levels needed to be measured at the distance employed can be detected by the measurement equipment. Measurements shall not be performed at a distance greater than 30 meters unless it can be further demonstrated that measurements at a distance of 30 meters or less are impractical. When performing measurements at a distance other than that specified, the results shall be extrapolated to the specified distance using an extrapolation factor of 20 dB/decade (inverse linear-distance for field strength measurements; inverse-linear-distance-squared for power density measurements).</p>			

### 4.8.2 Test Setup

Below 30MHz Test Setup:

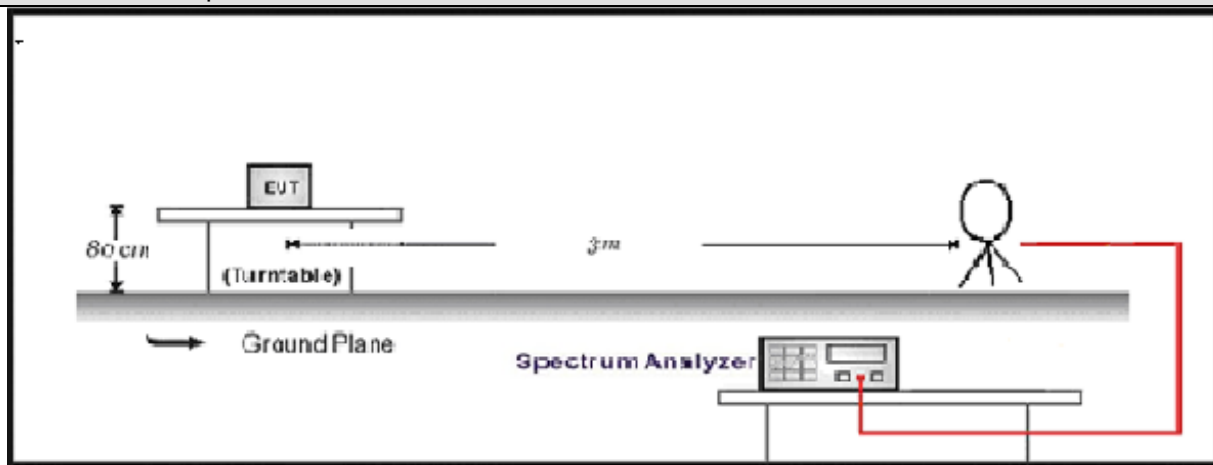

30MHz-1GHz Test Setup:

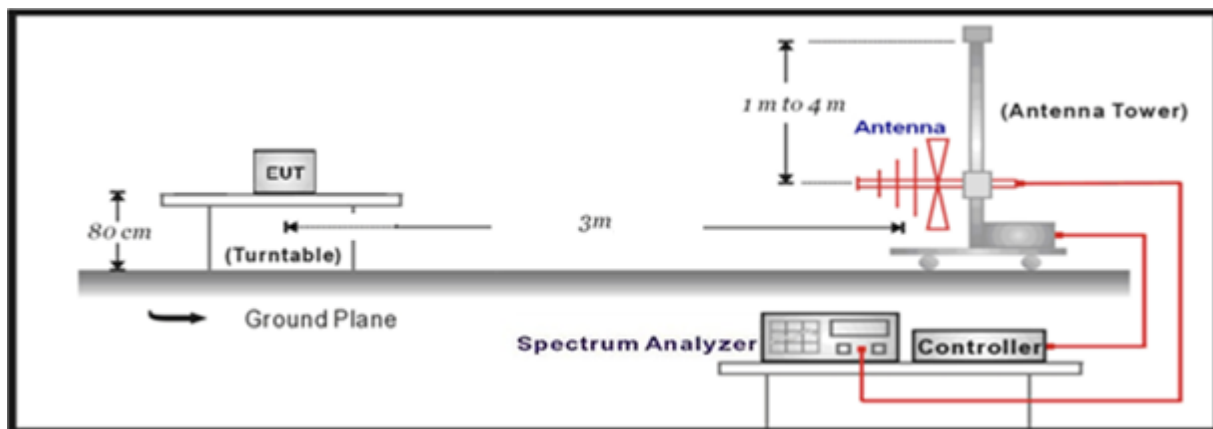

Above 1GHz Test Setup:

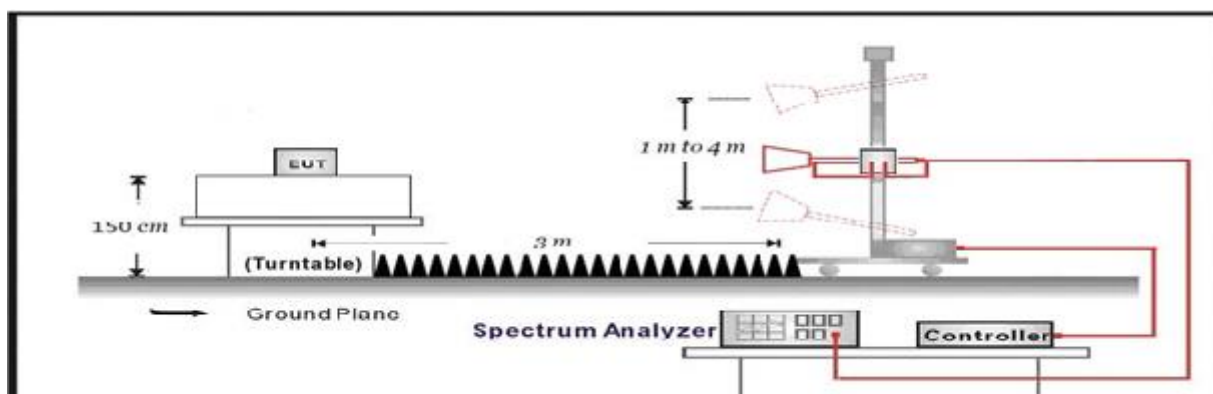

4.8.3 Test Procedure			
	References Rule	Chapter	Description
<input checked="" type="checkbox"/>	ANSI C63.10	11.12	Emissions in restricted frequency bands
	<input checked="" type="checkbox"/> ANSI C63.10	11.12.1	Radiated emission measurements
	<input checked="" type="checkbox"/> ANSI C63.10	11.12.2.7	Radiated spurious emission test
	<input checked="" type="checkbox"/> ANSI C63.10	6.4	Radiated emissions from unlicensed wireless devices below 30 MHz
	<input checked="" type="checkbox"/> ANSI C63.10	6.5	Radiated emissions from unlicensed wireless devices in the frequency range of 30 MHz to 1000 MHz
	<input checked="" type="checkbox"/> ANSI C63.10	6.6	Radiated emissions from unlicensed wireless devices above 1 GHz

<b>4.9 AC Power Line Conducted Emission</b>	<b>VERDICT: PASS</b>
---	----------------------

**4.9.1 Limit**

<b>Standard</b>	FCC Part 15 Subpart C Paragraph 15.207; RSS-Gen Issue 5 Paragraph 8.8.	
Frequency range [MHz]	Limit: QP [dB(μV) <sup>1)</sup>	Limit: AV [dB(μV) <sup>1)</sup>
0,15 - 0,50	66 - 56 <sup>2)</sup>	56 - 46 <sup>2)</sup>
0,50 - 5,0	56	46
5,0 - 30	60	50

<sup>1)</sup> At the transition frequency, the lower limit applies.  
<sup>2)</sup> The limit decreases linearly with the logarithm of the frequency.  
**NOTE 1:** The exclusion band for transmitters shall be considered for transmitters operating at frequencies below 30 MHz.  
**NOTE 2:** Where the AC output port is directly connected (or via a circuit breaker) to the AC power input port of the EUT the AC power output port need not to be tested.

**4.9.2 Test Setup**

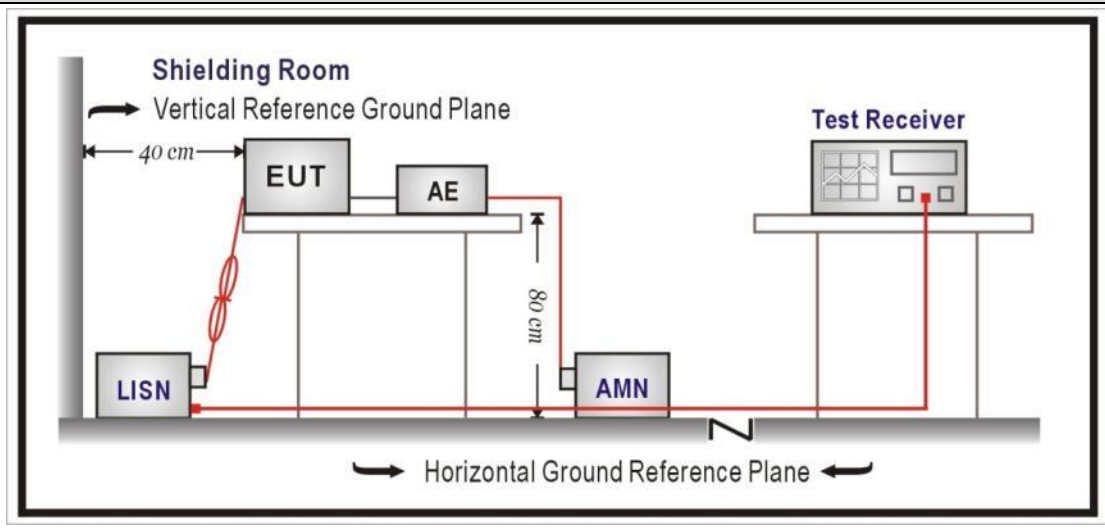

**4.9.3 Test Procedure**

	References Rule	Chapter	Item
☒	ANSI C63.10-2013	6.2	Standard test method for ac power-line conducted emissions from unlicensed wireless devices

**4.10 Antenna Requirement**

**VERDICT: PASS**

**4.10.1 Limit:**

<b>Standard</b>	FCC Part 15 Subpart C Paragraph 15.203; RSS-Gen Issue 5 Paragraph 6.8.
<p>An intentional radiator shall be designed to ensure that no antenna other than that furnished by the responsible party shall be used with the device. The use of a permanently attached antenna or of an antenna that uses a unique coupling to the intentional radiator shall be considered sufficient to comply with the provisions of this section. The manufacturer may design the unit so that a broken antenna can be replaced by the user, but the use of a standard antenna jack or electrical connector is prohibited. This requirement does not apply to carrier current devices or to devices operated under the provisions of §15.211, §15.213, §15.217, §15.219, or §15.221. Further, this requirement does not apply to intentional radiators that must be professionally installed, such as perimeter protection systems and some field disturbance sensors, or to other intentional radiators which, in accordance with §15.31(d), must be measured at the installation site. However, the installer shall be responsible for ensuring that the proper antenna is employed so that the limits in this part are not exceeded.</p>	

**4.10.2 Antenna Connector Construction:**

<input checked="" type="checkbox"/>	The use of a permanently attached antenna
<input type="checkbox"/>	The antenna use of a unique coupling to the intentional radiator
<input type="checkbox"/>	The use of a nonstandard antenna jack or electrical connector
Please refer to the attached document "Internal Photograph" to show the antenna connector.	

**5 TEST SETUP PHOTO AND EUT PHOTO**

Remark: The test setup photo and EUT Photo please see appendix.

## 6 TEST RESULT

### Appendix A: DTS Bandwidth

TestMode	Antenna	Frequency[MHz]	DTS BW [MHz]	FL[MHz]	FH[MHz]	Limit[MHz]	Verdict
ZIGB	Ant1	2405	1.670	2404.190	2405.860	0.5	PASS
ZIGB	Ant1	2440	1.640	2439.190	2440.830	0.5	PASS
ZIGB	Ant1	2480	1.670	2479.180	2480.850	0.5	PASS



ZIGB-Ant1-2405-PASS



ZIGB-Ant1-2440-PASS

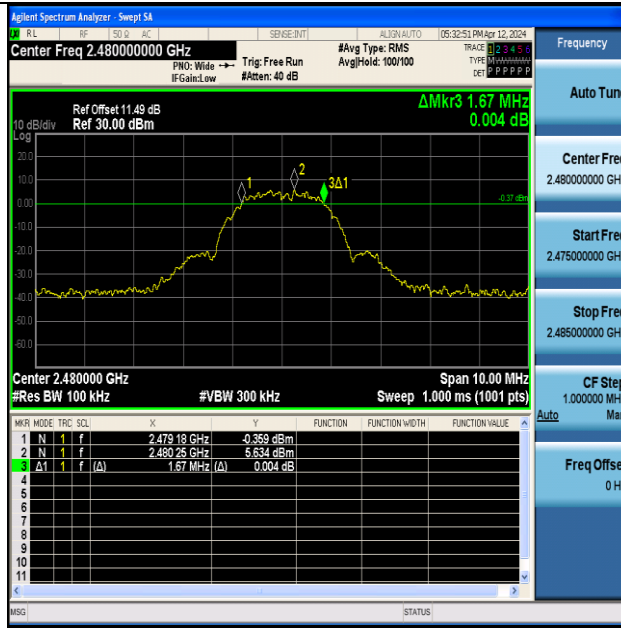

ZIGB-Ant1-2480-PASS

## Appendix B: Occupied Channel Bandwidth

TestMode	Antenna	Frequency[MHz]	OCB [MHz]	FL[MHz]	FH[MHz]	Limit[MHz]	Verdict
ZIGB	Ant1	2405	2.2672	2403.8667	2406.1339	N/A	Pass
ZIGB	Ant1	2440	2.2826	2438.8585	2441.1411	N/A	Pass
ZIGB	Ant1	2480	2.2723	2478.8610	2481.1333	N/A	Pass

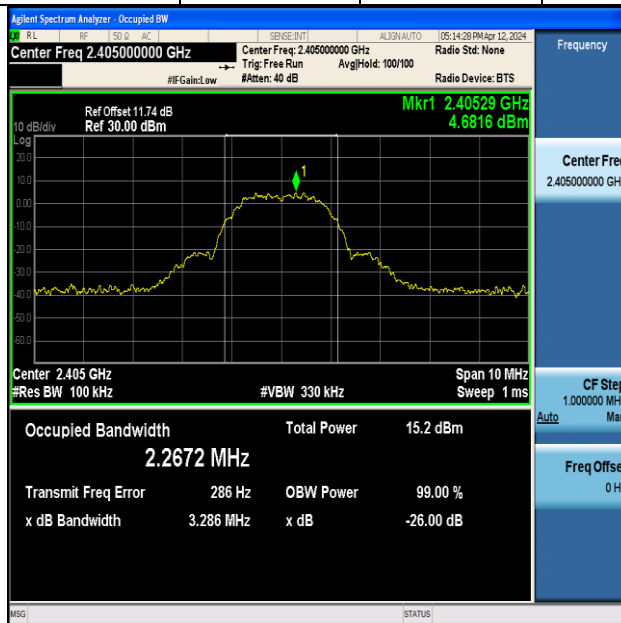

ZIGB-Ant1-2405

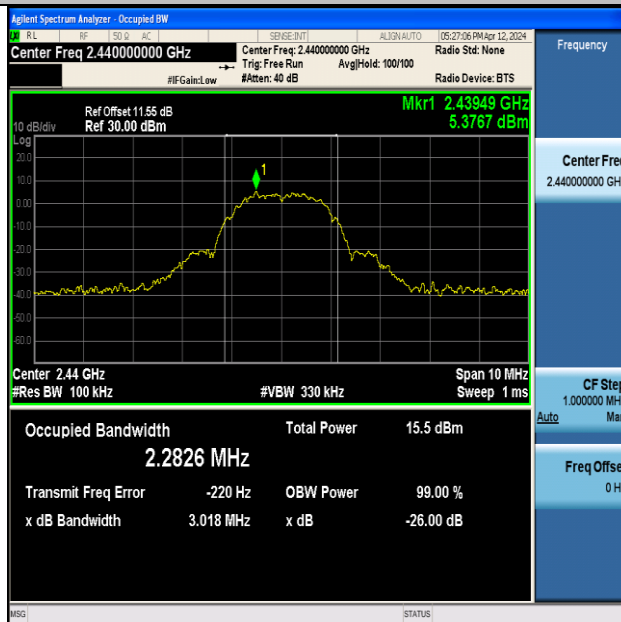

ZIGB-Ant1-2440



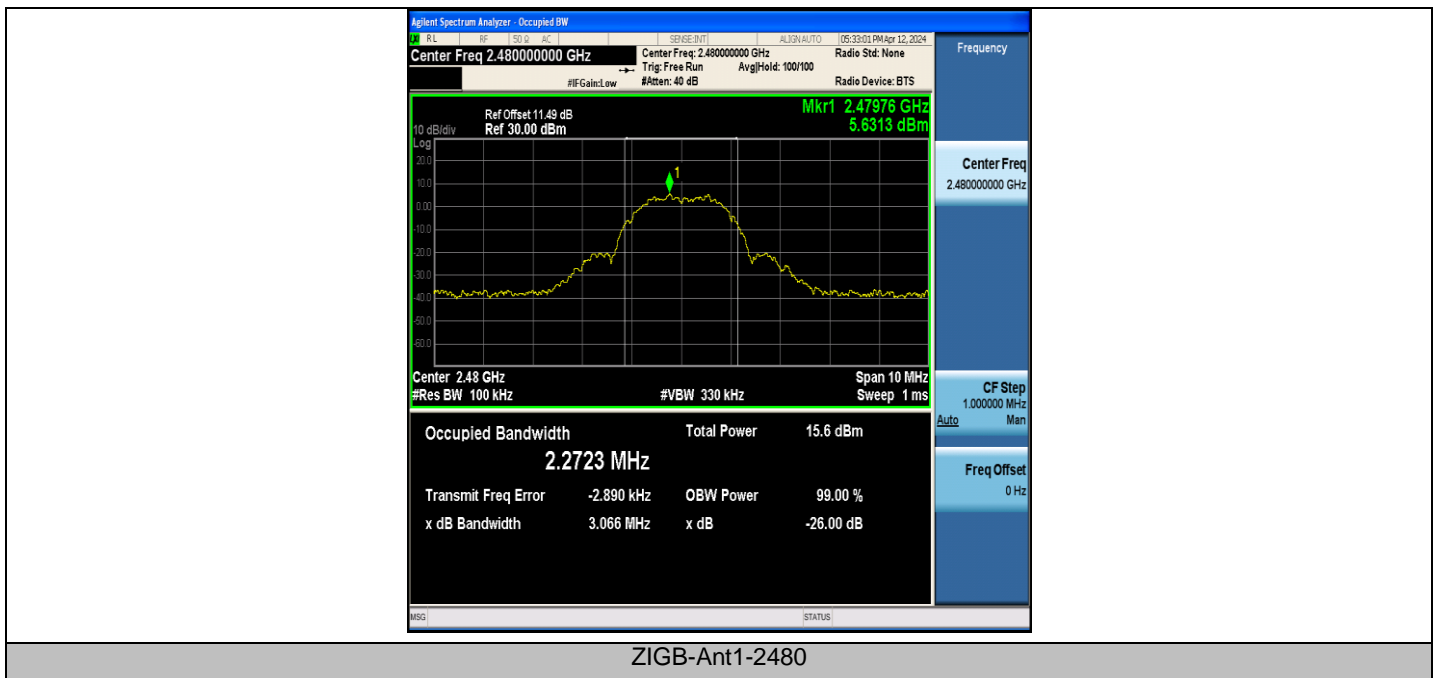

**Appendix C: Maximum conducted output power**

Test Mode	Frequency (MHz)	Measured Power (dBm)	EIRP (dBm)	Conducted Limit[dBm]	EIRP Limit (dBm)
Mode1	2405	8.07	11.07	≤30	≤36
	2440	8.08	11.08	≤30	≤36
	2480	8.08	11.08	≤30	≤36

Note 1: EIRP=Measured power+Antenna gain

Note 2: The antenna gain please refer to clause 1.2

### Appendix D: Maximum power spectral density

TestMode	Antenna	Frequency[MHz]	Result[dBm/3-100kHz]	Limit[dBm/3kHz]	Verdict
ZIGB	Ant1	2405	-6.91	≤8.00	PASS
ZIGB	Ant1	2440	-7.22	≤8.00	PASS
ZIGB	Ant1	2480	-7.00	≤8.00	PASS

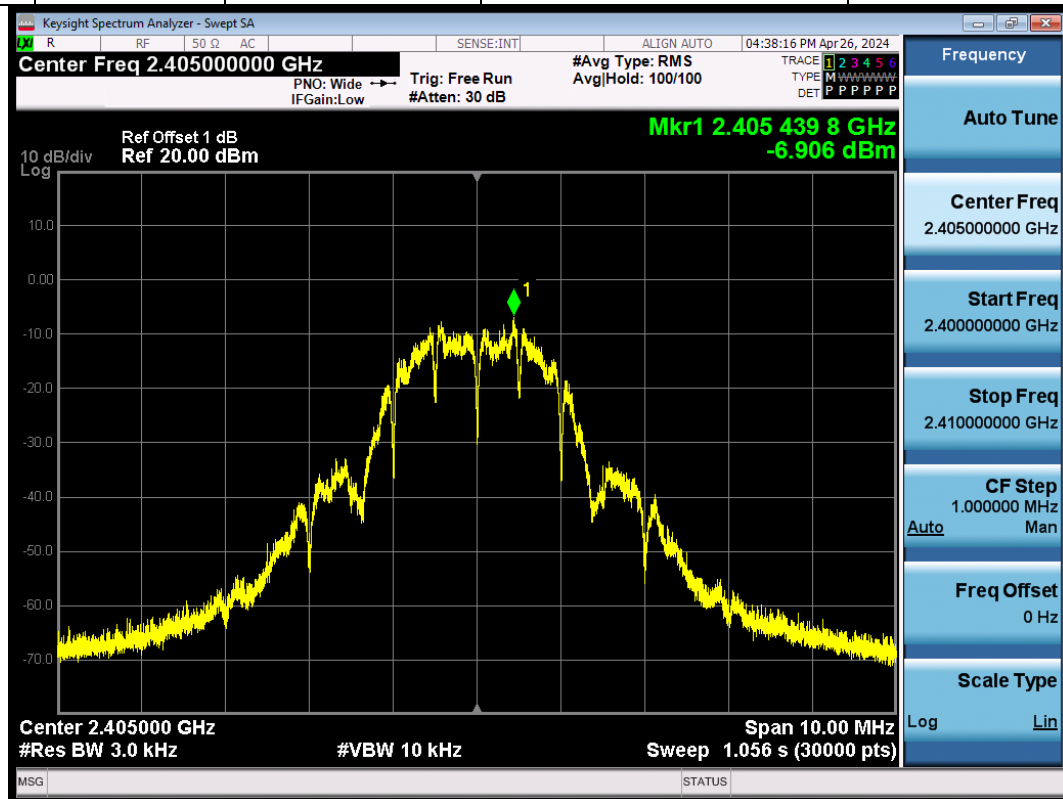

ZIGB-Ant1-2405-PASS

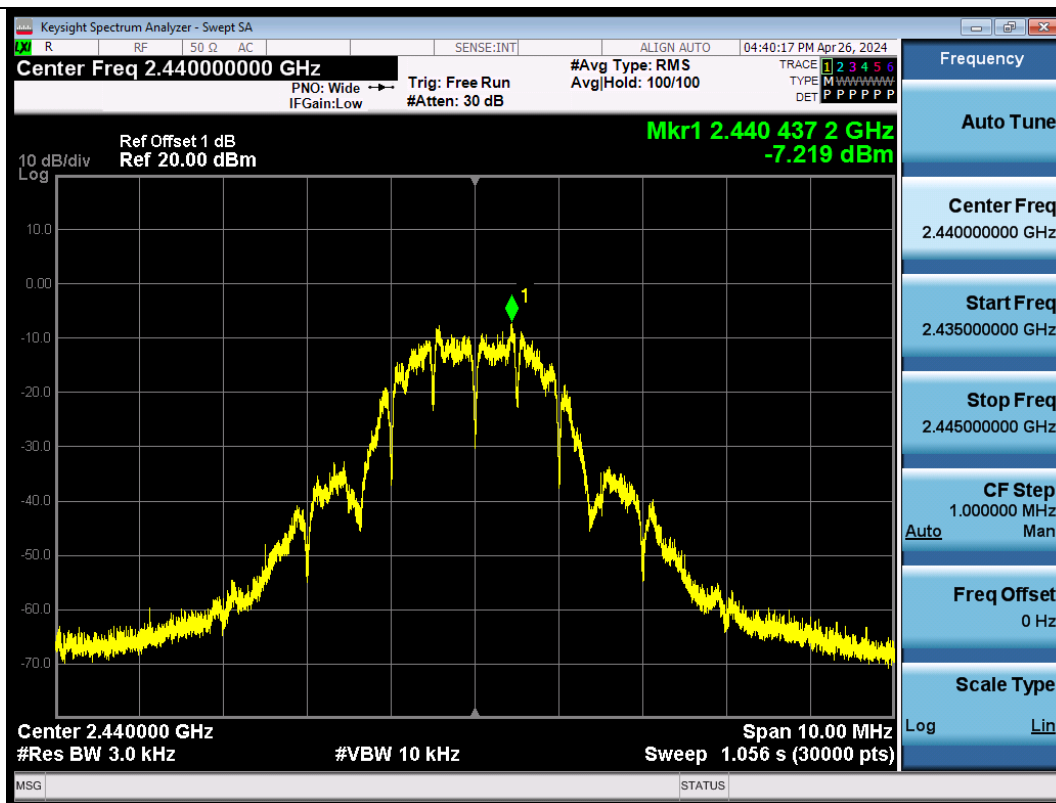

ZIGB-Ant1-2440-PASS

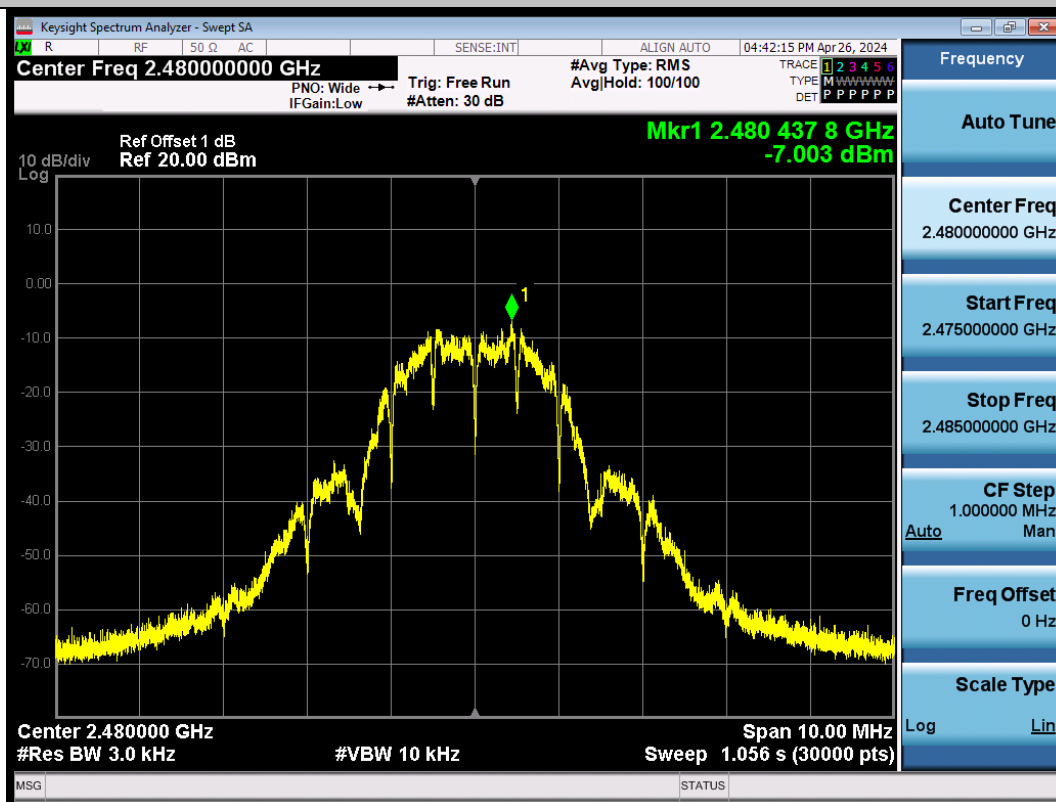

ZIGB-Ant1-2480-PASS

### Appendix E: Band edge measurements

Profile: 2430177R	Page No.: 33
Engineer: Pengchengyang	
Site: AC5	Time: 2024/04/10 - 09:51
Limit: FCC_Part15.209_RE(3m)	Margin: 0
Probe: Horn_3117_00167055(1-18GHz)	Polarity: Horizontal
EUT: LED lamp	Power: AC 120V/60Hz
Note: Mode 1 : Transmit at 2405MHz by Zigbee	

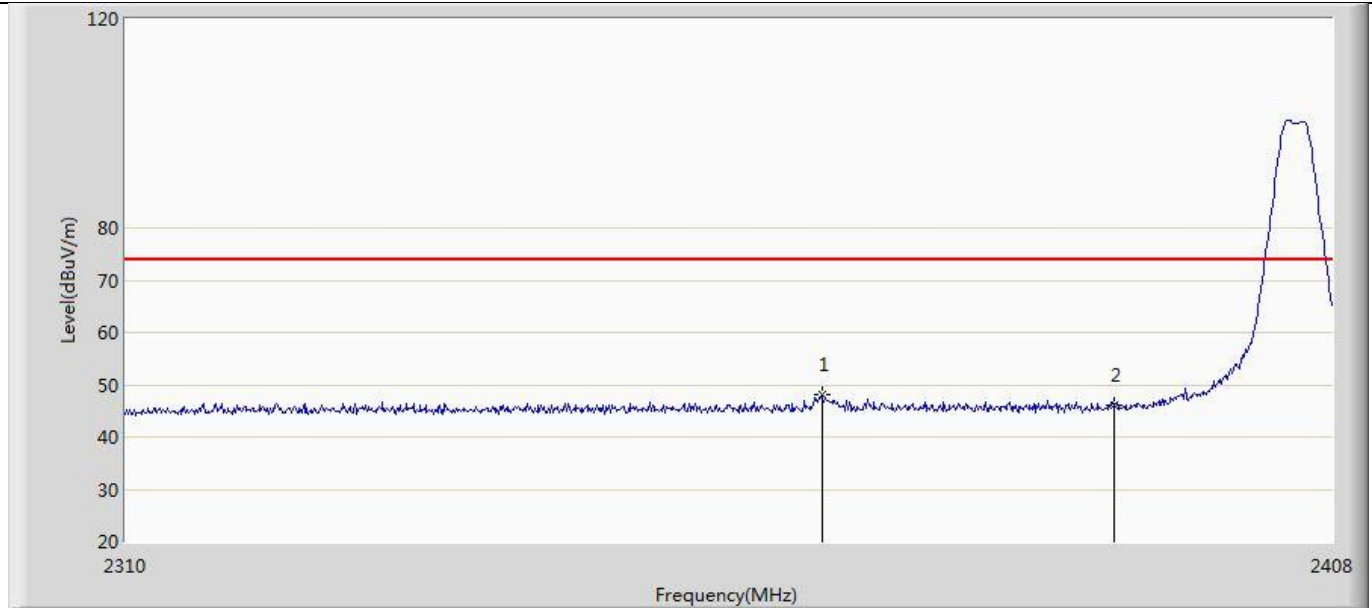

No	Mark	Frequency (MHz)	Measure Level (dBuV/m)	Reading Level (dBuV)	Over Limit (dB)	Limit (dBuV/m)	Factor (dB)	Type
1	*	2366.056	48.002	13.980	-25.998	74.000	34.022	PK
2		2390.000	46.207	12.056	-27.793	74.000	34.151	PK

Profile: 2430177R	Page No.: 34
Engineer: Pengchengyang	
Site: AC5	Time: 2024/04/10 - 09:53
Limit: FCC_Part15.209_RE(3m)	Margin: 0
Probe: Horn_3117_00167055(1-18GHz)	Polarity: Horizontal
EUT: LED lamp	Power: AC 120V/60Hz
Note: Mode 1 : Transmit at 2405MHz by Zigbee	

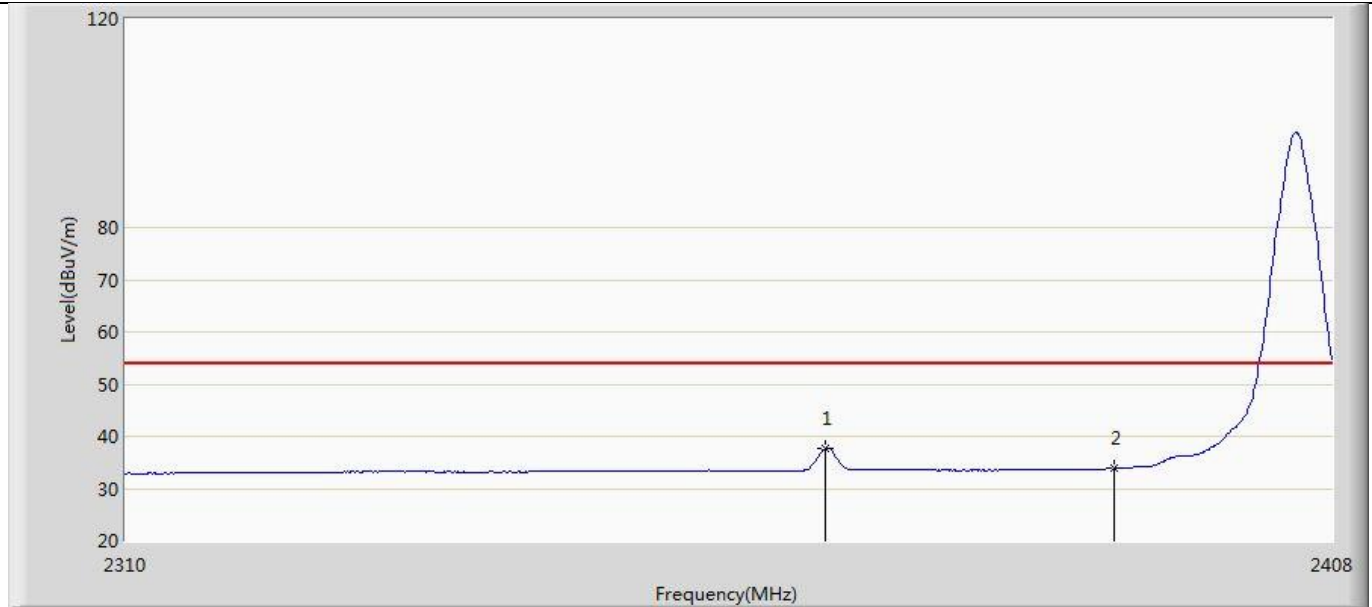

No	Mark	Frequency (MHz)	Measure Level (dBuV/m)	Reading Level (dBuV)	Over Limit (dB)	Limit (dBuV/m)	Factor (dB)	Type
1	*	2366.350	37.648	3.624	-16.352	54.000	34.025	AV
2		2390.000	33.781	-0.370	-20.219	54.000	34.151	AV

Profile: 2430177R	Page No.: 35
Engineer: Pengchengyang	
Site: AC5	Time: 2024/04/10 - 09:54
Limit: FCC_Part15.209_RE(3m)	Margin: 0
Probe: Horn_3117_00167055(1-18GHz)	Polarity: Vertical
EUT: LED lamp	Power: AC 120V/60Hz
Note: Mode 1 : Transmit at 2405MHz by Zigbee	

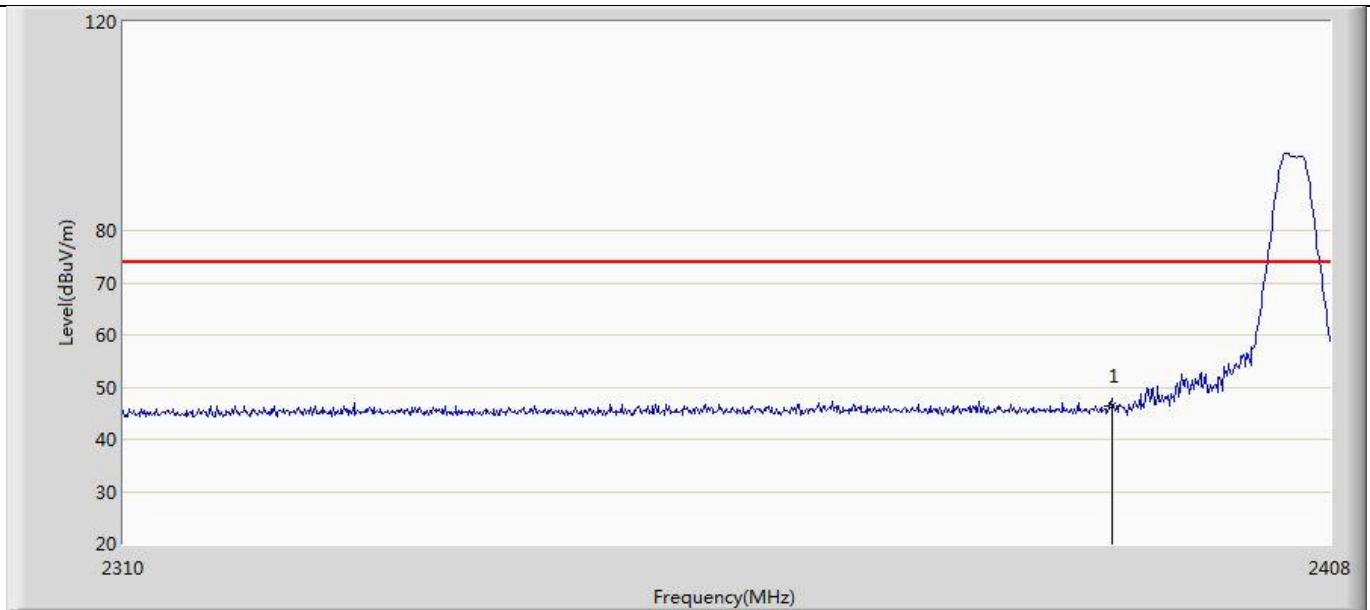

No	Mark	Frequency (MHz)	Measure Level (dBuV/m)	Reading Level (dBuV)	Over Limit (dB)	Limit (dBuV/m)	Factor (dB)	Type
1	*	2390.000	46.281	12.130	-27.719	74.000	34.151	PK

Profile: 2430177R	Page No.: 36
Engineer: Pengchengyang	
Site: AC5	Time: 2024/04/10 - 09:55
Limit: FCC_Part15.209_RE(3m)	Margin: 0
Probe: Horn_3117_00167055(1-18GHz)	Polarity: Vertical
EUT: LED lamp	Power: AC 120V/60Hz
Note: Mode 5=1 : Transmit at 2405MHz by Zigbee	

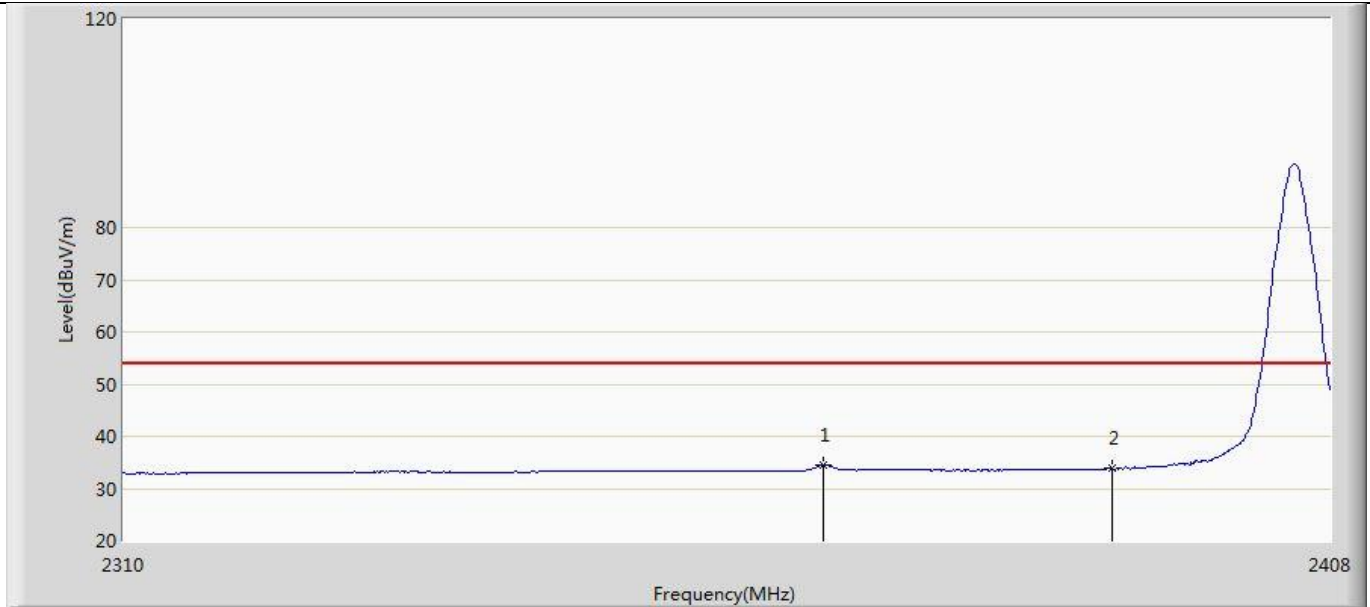

No	Mark	Frequency (MHz)	Measure Level (dBuV/m)	Reading Level (dBuV)	Over Limit (dB)	Limit (dBuV/m)	Factor (dB)	Type
1	*	2366.350	34.458	0.434	-19.542	54.000	34.025	AV
2		2390.000	33.798	-0.353	-20.202	54.000	34.151	AV



Profile: 2430177R	Page No.: 37
Engineer: Pengchengyang	
Site: AC5	Time: 2024/04/10 - 09:57
Limit: FCC_Part15.209_RE(3m)	Margin: 0
Probe: Horn_3117_00167055(1-18GHz)	Polarity: Horizontal
EUT: LED lamp	Power: AC 120V/60Hz
Note: Mode 1 : Transmit at 2480MHz by Zigbee	

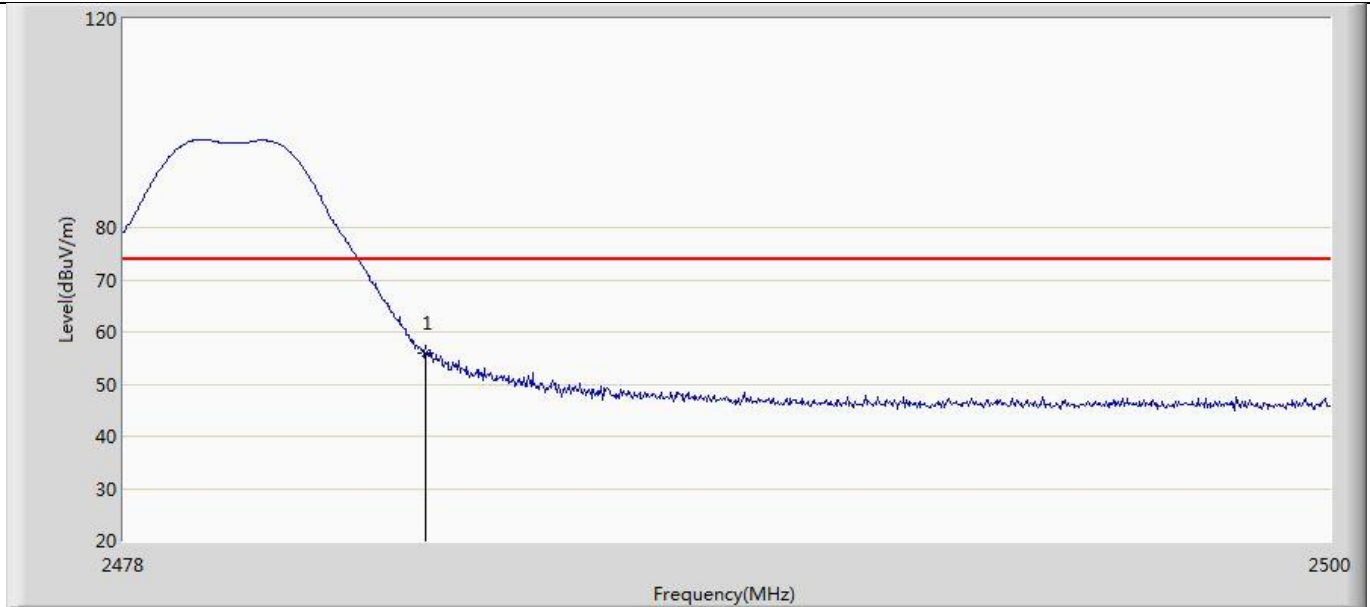

No	Mark	Frequency (MHz)	Measure Level (dBuV/m)	Reading Level (dBuV)	Over Limit (dB)	Limit (dBuV/m)	Factor (dB)	Type
1	*	2483.500	55.955	21.499	-18.045	74.000	34.456	PK

Profile: 2430177R	Page No.: 38
Engineer: Pengchengyang	
Site: AC5	Time: 2024/04/10 - 09:58
Limit: FCC_Part15.209_RE(3m)	Margin: 0
Probe: Horn_3117_00167055(1-18GHz)	Polarity: Horizontal
EUT: LED lamp	Power: AC 120V/60Hz
Note: Mode 1 : Transmit at 2480MHz by Zigbee	

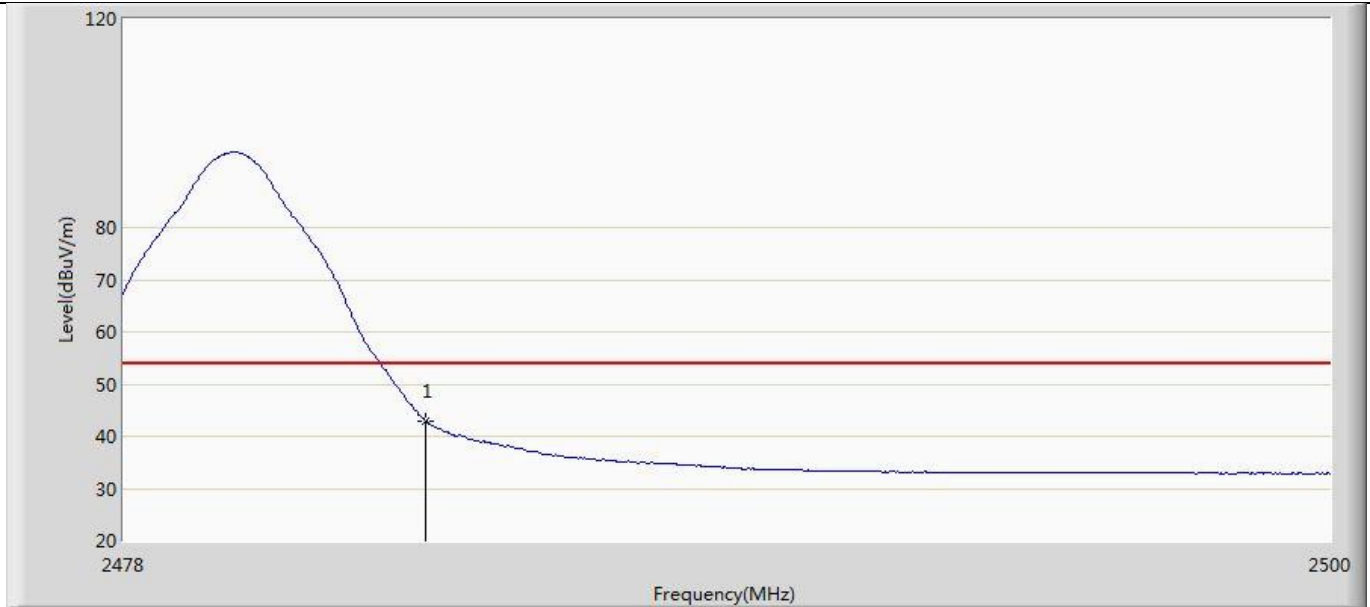

No	Mark	Frequency (MHz)	Measure Level (dBuV/m)	Reading Level (dBuV)	Over Limit (dB)	Limit (dBuV/m)	Factor (dB)	Type
1	*	2483.500	43.032	8.576	-10.968	54.000	34.456	AV

Profile: 2430177R	Page No.: 39
Engineer: Pengchengyang	
Site: AC5	Time: 2024/04/10 - 09:59
Limit: FCC_Part15.209_RE(3m)	Margin: 0
Probe: Horn_3117_00167055(1-18GHz)	Polarity: Vertical
EUT: LED lamp	Power: AC 120V/60Hz
Note: Mode 1 : Transmit at 2480MHz by Zigbee	

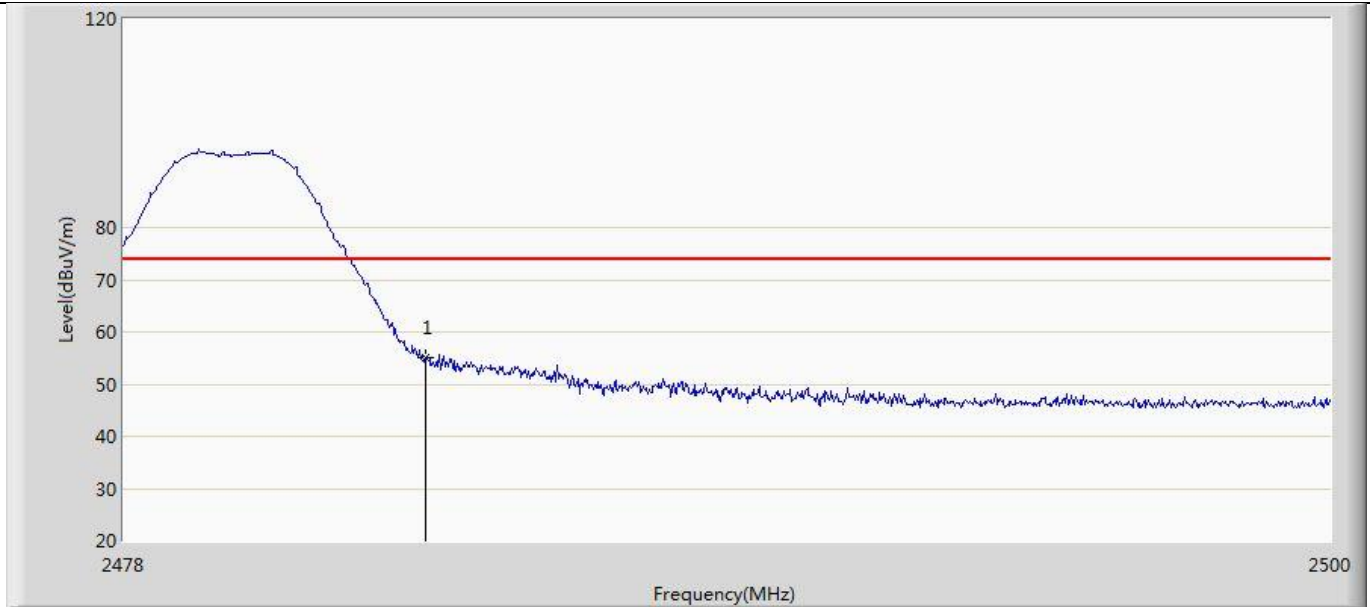

No	Mark	Frequency (MHz)	Measure Level (dBuV/m)	Reading Level (dBuV)	Over Limit (dB)	Limit (dBuV/m)	Factor (dB)	Type
1	*	2483.500	55.085	20.629	-18.915	74.000	34.456	PK

Profile: 2430177R	Page No.: 40
Engineer: Pengchengyang	
Site: AC5	Time: 2024/04/10 - 10:00
Limit: FCC_Part15.209_RE(3m)	Margin: 0
Probe: Horn_3117_00167055(1-18GHz)	Polarity: Vertical
EUT: LED lamp	Power: AC 120V/60Hz
Note: Mode 1 : Transmit at 2480MHz by Zigbee	

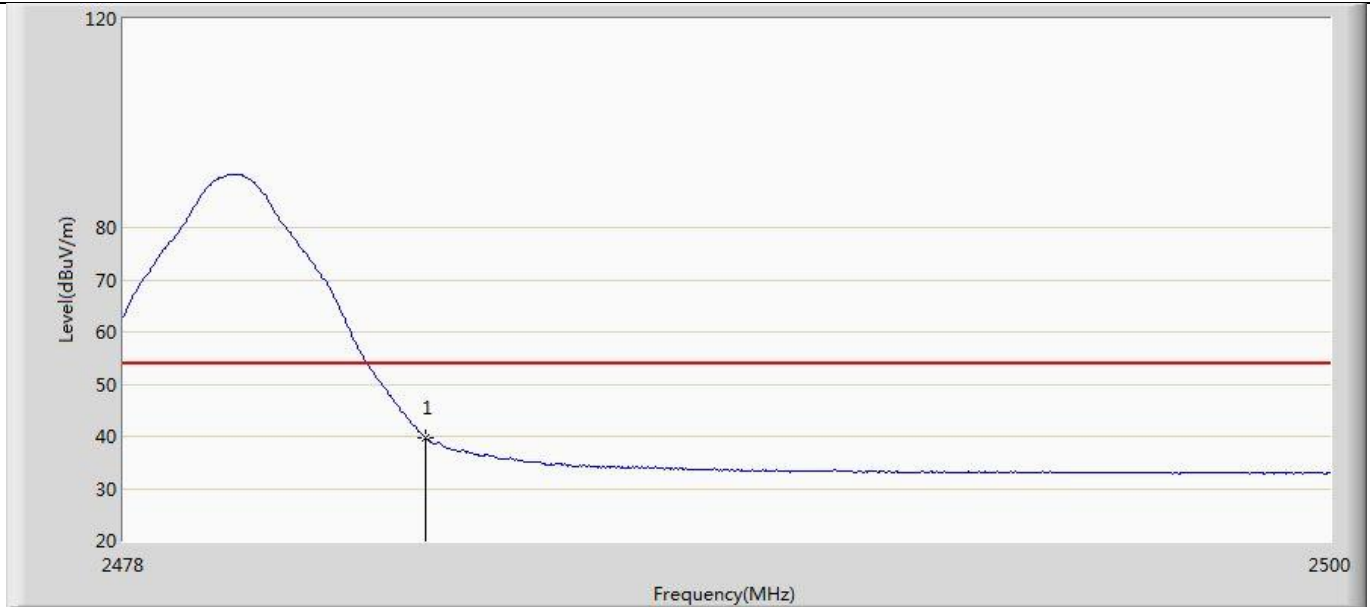

No	Mark	Frequency (MHz)	Measure Level (dBuV/m)	Reading Level (dBuV)	Over Limit (dB)	Limit (dBuV/m)	Factor (dB)	Type
1	*	2483.500	39.729	5.273	-14.271	54.000	34.456	AV

## Appendix F Conducted Spurious Emission

Test Result for Reference level

TestMode	Antenna	Freq(MHz)	Max.Point[MHz]	Result[dBm]
ZIGB	Ant1	2405	2405.50	4.39
ZIGB	Ant1	2440	2439.73	5.83
ZIGB	Ant1	2480	2480.51	5.05



ZIGB-Ant1-2405-PASS



ZIGB-Ant1-2440-PASS

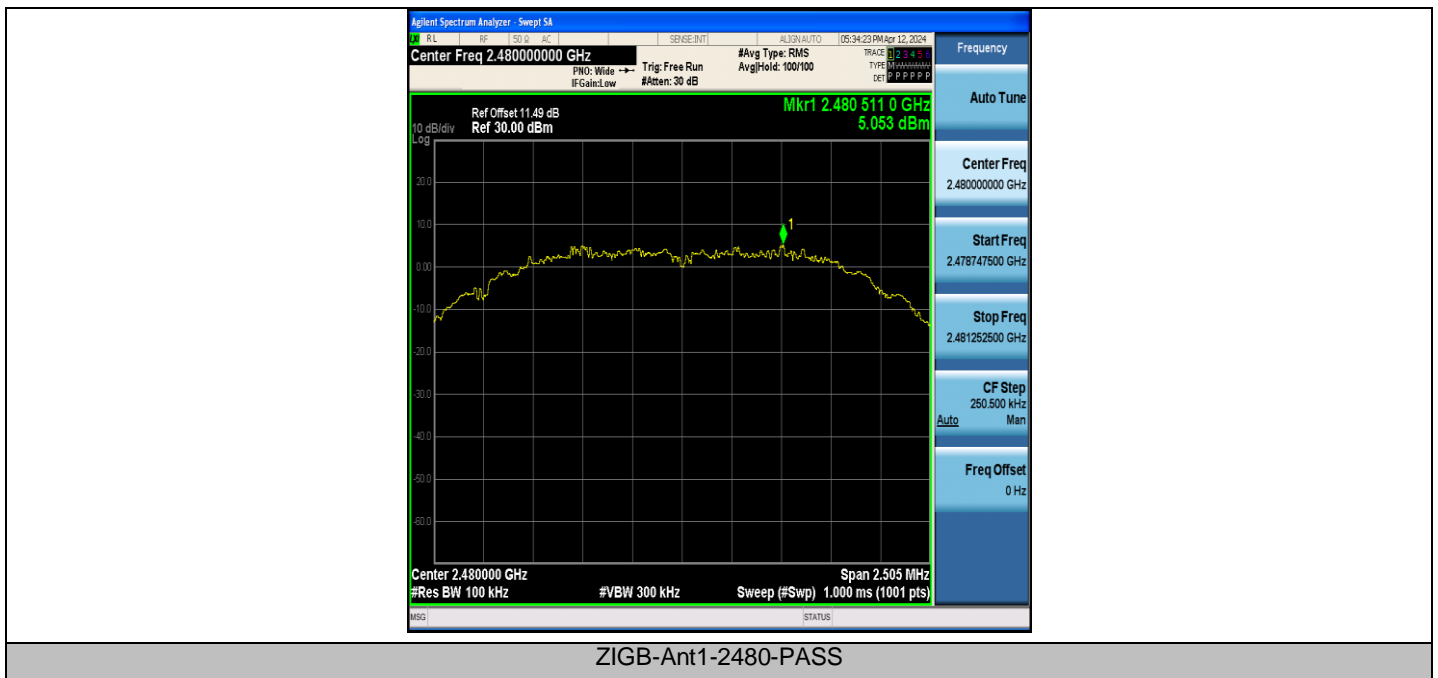

ZIGB-Ant1-2480-PASS

Test Result for Band edge

TestMode	Antenna	ChName	Frequency[MHz]	RefLevel[dBm]	Result[dBm]	Limit[dBm]	Verdict
ZIGB	Ant1	Low	2405	4.39	-44.04	≤-15.61	PASS
ZIGB	Ant1	High	2480	5.05	-42.42	≤-14.95	PASS

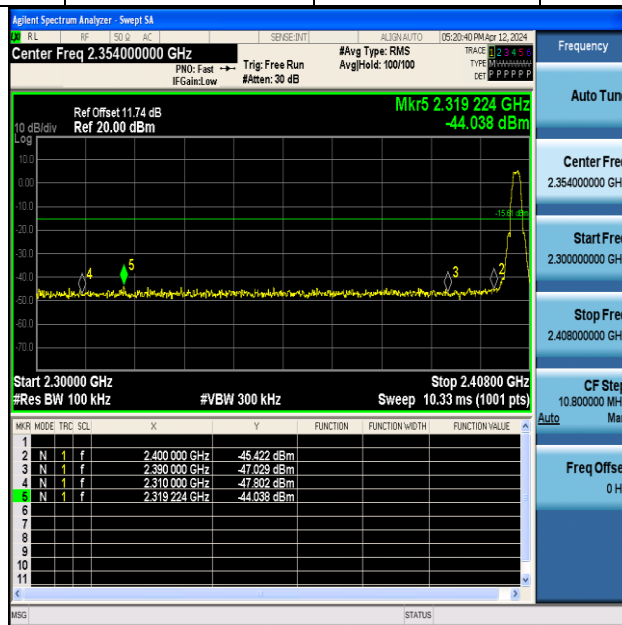

ZIGB-Ant1-2405-PASS

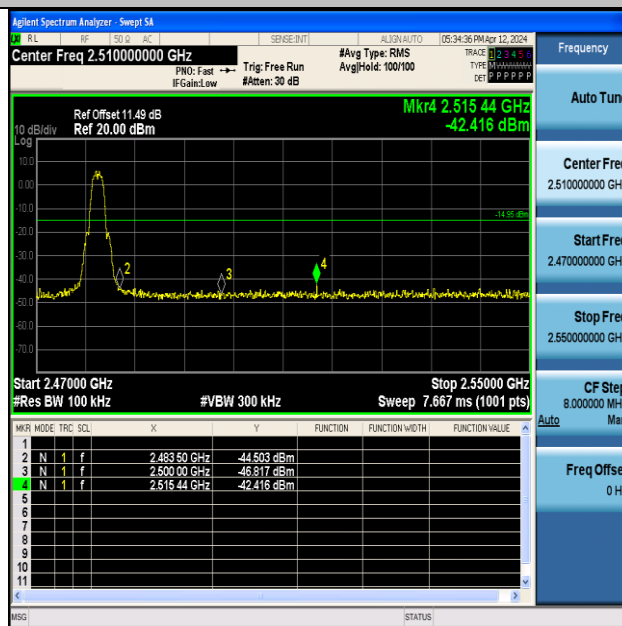

ZIGB-Ant1-2480-PASS

## Conducted Spurious Emission

TestMode	Antenna	Frequency[MHz]	FreqRange [MHz]	RefLevel [dBm]	Result[dBm]	Limit[dBm]	Verdict
ZIGB	Ant1	2405	30~1000	4.39	-53.24	≤-15.61	PASS
ZIGB	Ant1	2405	1000~3000	4.39	-51.72	≤-15.61	PASS
ZIGB	Ant1	2405	3000~5000	4.39	-50.3	≤-15.61	PASS
ZIGB	Ant1	2405	5000~7000	4.39	-51.19	≤-15.61	PASS
ZIGB	Ant1	2405	7000~9000	4.39	-51.83	≤-15.61	PASS
ZIGB	Ant1	2405	9000~11000	4.39	-51.76	≤-15.61	PASS
ZIGB	Ant1	2405	11000~13000	4.39	-50.48	≤-15.61	PASS
ZIGB	Ant1	2405	13000~15000	4.39	-46.12	≤-15.61	PASS
ZIGB	Ant1	2405	15000~17000	4.39	-45.72	≤-15.61	PASS
ZIGB	Ant1	2405	17000~19000	4.39	-45.11	≤-15.61	PASS
ZIGB	Ant1	2405	19000~21000	4.39	-43.03	≤-15.61	PASS
ZIGB	Ant1	2405	21000~23000	4.39	-42.72	≤-15.61	PASS
ZIGB	Ant1	2405	23000~25000	4.39	-41.32	≤-15.61	PASS
ZIGB	Ant1	2440	30~1000	5.83	-53.53	≤-14.17	PASS
ZIGB	Ant1	2440	1000~3000	5.83	-51.61	≤-14.17	PASS
ZIGB	Ant1	2440	3000~5000	5.83	-50.3	≤-14.17	PASS
ZIGB	Ant1	2440	5000~7000	5.83	-50.92	≤-14.17	PASS
ZIGB	Ant1	2440	7000~9000	5.83	-52.21	≤-14.17	PASS
ZIGB	Ant1	2440	9000~11000	5.83	-51.11	≤-14.17	PASS
ZIGB	Ant1	2440	11000~13000	5.83	-50.21	≤-14.17	PASS
ZIGB	Ant1	2440	13000~15000	5.83	-47	≤-14.17	PASS
ZIGB	Ant1	2440	15000~17000	5.83	-45.51	≤-14.17	PASS
ZIGB	Ant1	2440	17000~19000	5.83	-44.67	≤-14.17	PASS
ZIGB	Ant1	2440	19000~21000	5.83	-43.28	≤-14.17	PASS
ZIGB	Ant1	2440	21000~23000	5.83	-43.32	≤-14.17	PASS
ZIGB	Ant1	2440	23000~25000	5.83	-42.04	≤-14.17	PASS
ZIGB	Ant1	2480	30~1000	5.05	-53.89	≤-14.95	PASS
ZIGB	Ant1	2480	1000~3000	5.05	-51.17	≤-14.95	PASS
ZIGB	Ant1	2480	3000~5000	5.05	-50.26	≤-14.95	PASS
ZIGB	Ant1	2480	5000~7000	5.05	-51.58	≤-14.95	PASS
ZIGB	Ant1	2480	7000~9000	5.05	-52.41	≤-14.95	PASS
ZIGB	Ant1	2480	9000~11000	5.05	-51.64	≤-14.95	PASS
ZIGB	Ant1	2480	11000~13000	5.05	-50.61	≤-14.95	PASS
ZIGB	Ant1	2480	13000~15000	5.05	-46.92	≤-14.95	PASS
ZIGB	Ant1	2480	15000~17000	5.05	-45.86	≤-14.95	PASS
ZIGB	Ant1	2480	17000~19000	5.05	-45.31	≤-14.95	PASS
ZIGB	Ant1	2480	19000~21000	5.05	-43.79	≤-14.95	PASS
ZIGB	Ant1	2480	21000~23000	5.05	-42.55	≤-14.95	PASS
ZIGB	Ant1	2480	23000~25000	5.05	-42.25	≤-14.95	PASS



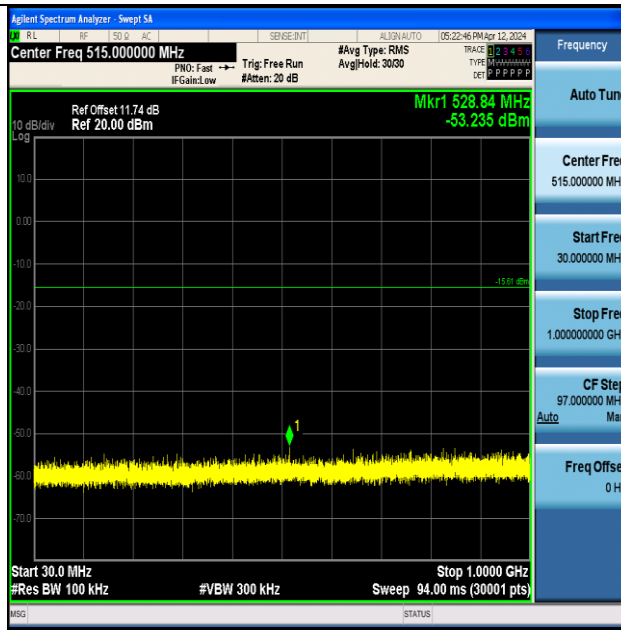

ZIGB-Ant1-2405-30~1000-PASS

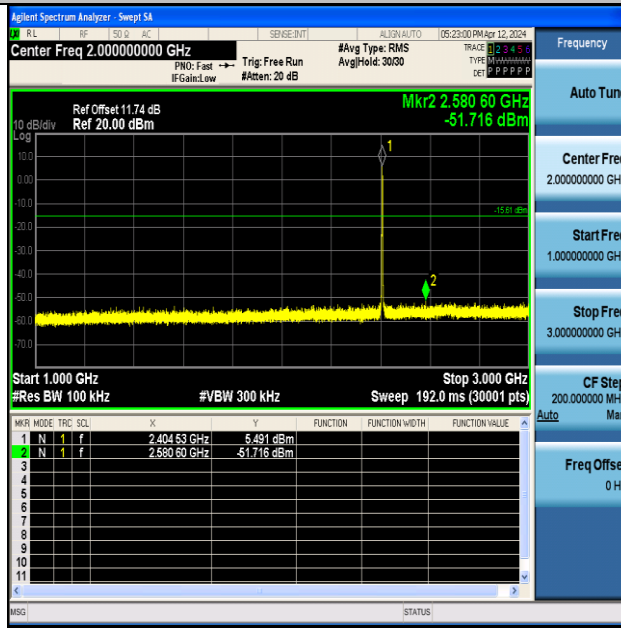

ZIGB-Ant1-2405-1000~3000-PASS

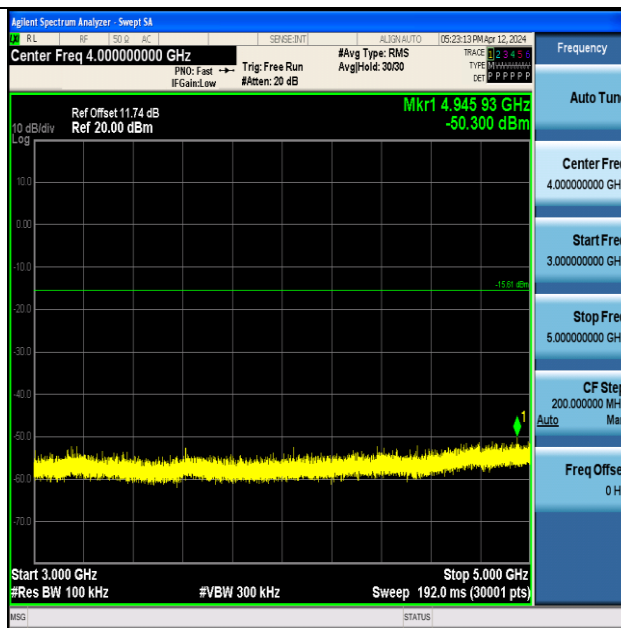

ZIGB-Ant1-2405-3000~5000-PASS

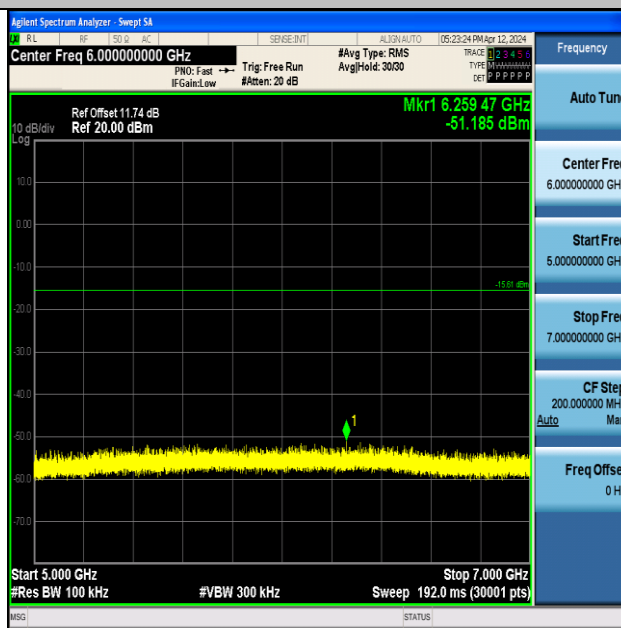

ZIGB-Ant1-2405-5000~7000-PASS

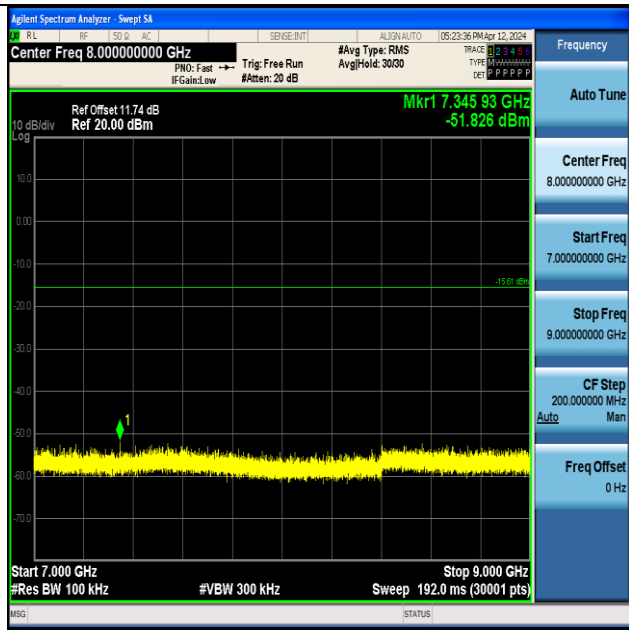

ZIGB-Ant1-2405-7000~9000-PASS

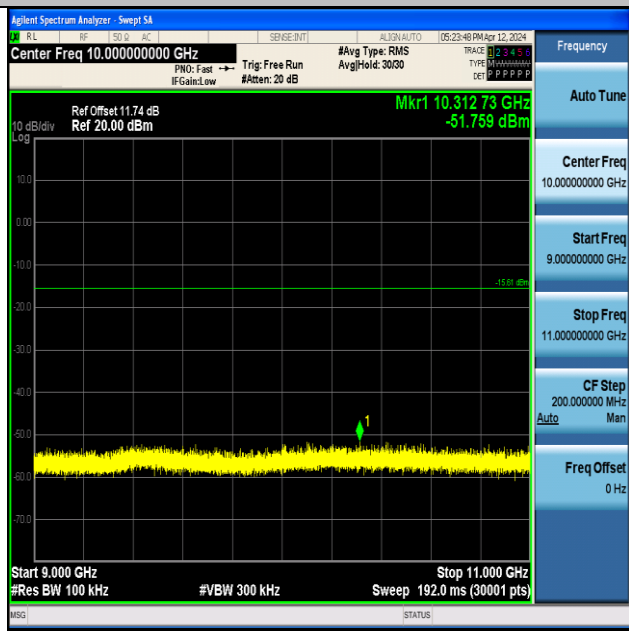

ZIGB-Ant1-2405-9000~11000-PASS

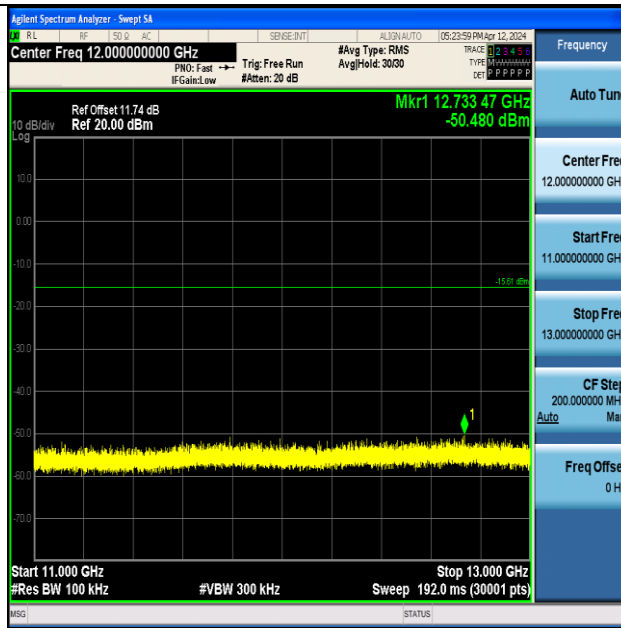

ZIGB-Ant1-2405-11000~13000-PASS



ZIGB-Ant1-2405-13000~15000-PASS

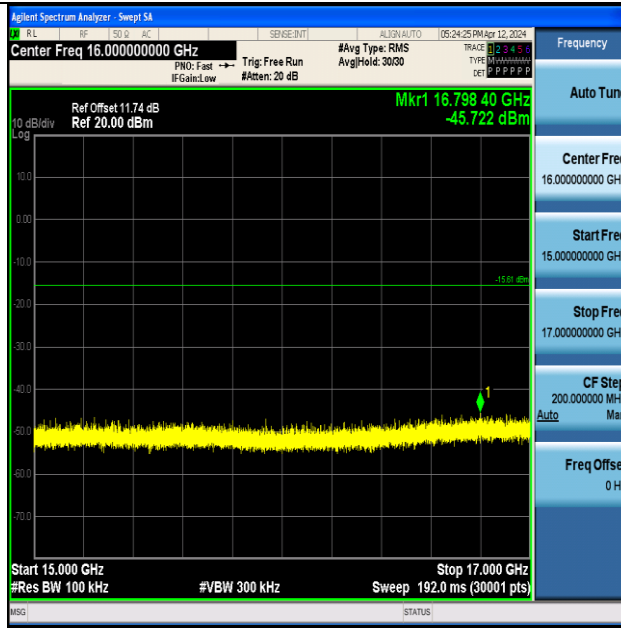

ZIGB-Ant1-2405-15000~17000-PASS



ZIGB-Ant1-2405-17000~19000-PASS

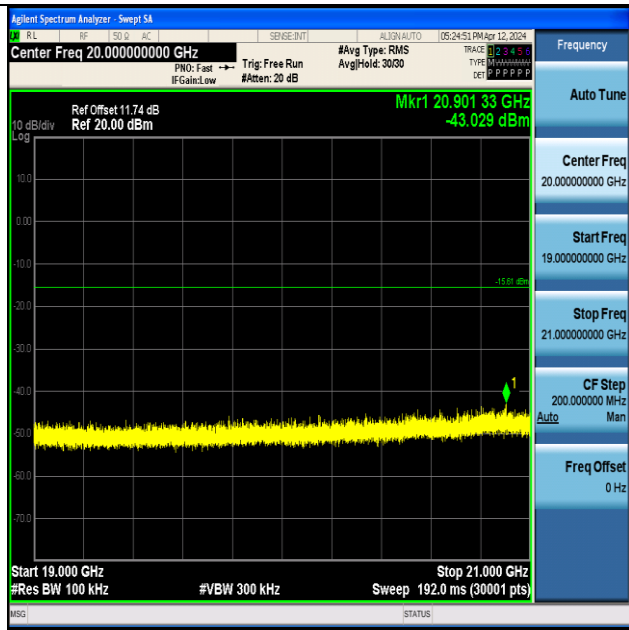

ZIGB-Ant1-2405-19000~21000-PASS

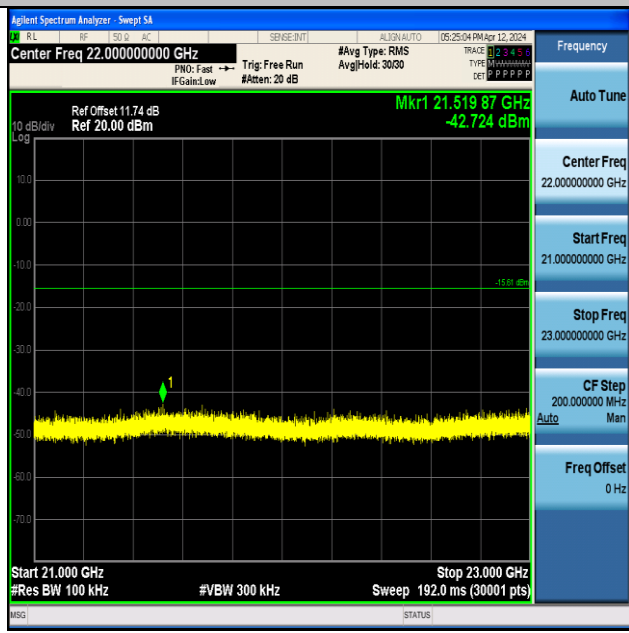

ZIGB-Ant1-2405-21000~23000-PASS

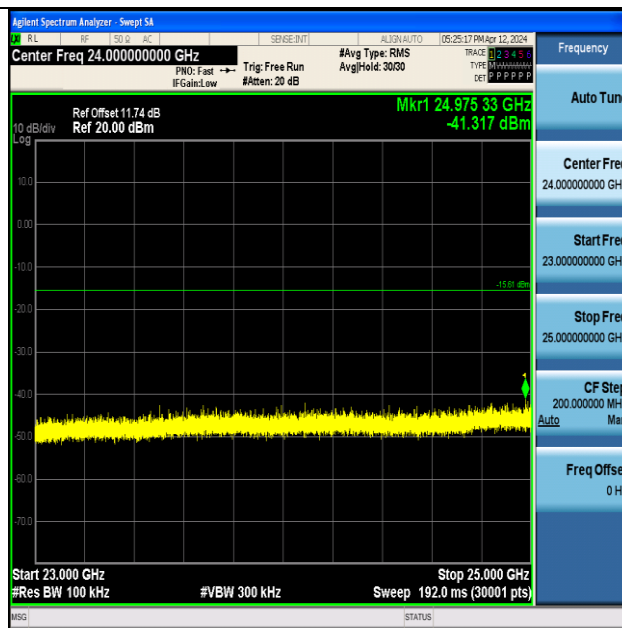

ZIGB-Ant1-2405-23000~25000-PASS

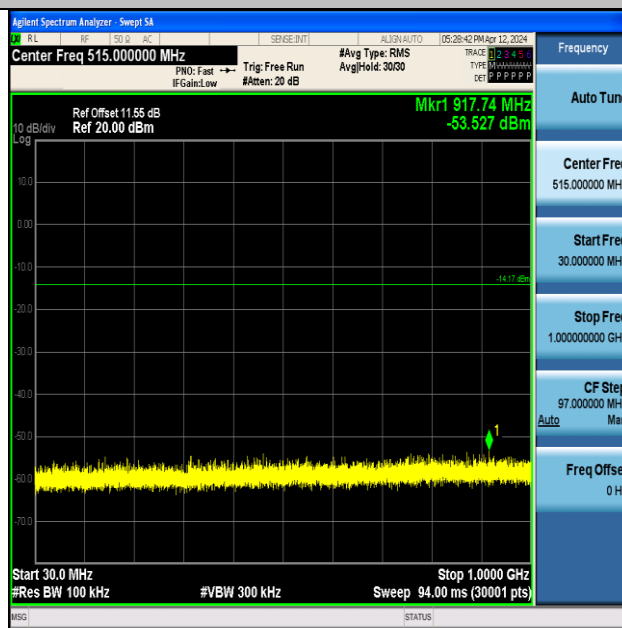

ZIGB-Ant1-2440-30~1000-PASS

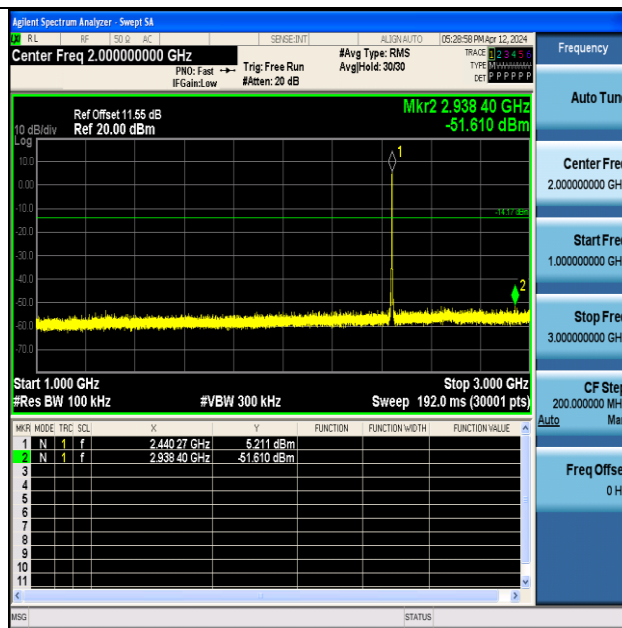

ZIGB-Ant1-2440-1000~3000-PASS

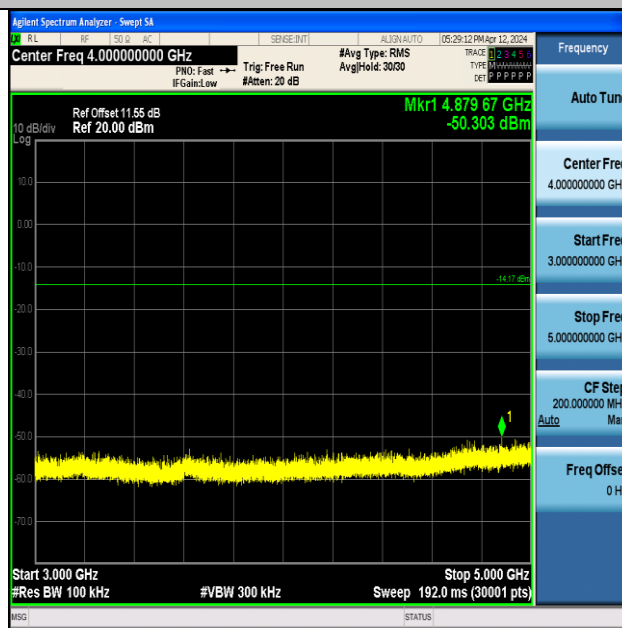

ZIGB-Ant1-2440-3000~5000-PASS