

ARTWORK

Master Ref: **PHL502304**
 TR Ref: **TR2355768**
 Brand: PHILIPS
 Brand execution: HUE White and Color Ambiance
 Product name:
 Article Number: N/A
 Region: Trident UK
 Template Ref: As Previous
 Artwork 12NC: 440402911712
 Die cut 12NC:
 Barcode: N/A
 CRC Number:
 Action: **B**
 Date: 17/01/2022

Project Manager: Margarita Papoutsis

Trident Artist: Samantha Reilly

Technical & Non Printing Items

Dieline Guides

Colours:

Black	1
	2%

PHILIPS



TRIDENT

Trident UK, Connaught House, Connaught Road,
 Kingswood Business Park, Hull, HU7 3AP, England.
 T: +44 (0) 01482 828100

Please note that any low resolution paper Canon colour
 copies associated with this job should be referred to for
 content, layout and colour separation only.

UNDER NO CIRCUMSTANCES SHOULD THIS
 ARTWORK BE ALTERED WITHOUT PRIOR
 PERMISSION FROM TRIDENT.

ARTWORK

Master Ref: **PHL502304**
TR Ref: **TR2355768**
Brand: PHILIPS
Brand execution: HUE White and Color Ambiance
Product name:
Article Number: N/A
Region: Trident UK
Template Ref: As Previous
Artwork 12NC: 440402911712
Die cut 12NC:
Barcode: N/A
CRC Number:
Action: **B**
Date: 17/01/2022

Project Manager: Margarita Papoutsis

Trident Artist: Samantha Reilly

Technical & Non Printing Items

■ Dieline ■ Guides

Colours:

Black	1
	3th

PHILIPS



Trident UK, Connaught House, Connaught Road,
Kingswood Business Park, Hull, HU7 3AP, England.
T: +44 (0) 01482 828100

Please note that any low resolution paper Canon colour
copies associated with this job should be referred to for
content, layout and colour separation only.

UNDER NO CIRCUMSTANCES SHOULD THIS
ARTWORK BE ALTERED WITHOUT PRIOR
PERMISSION FROM TRIDENT.

100 mm

120 mm

Incl.

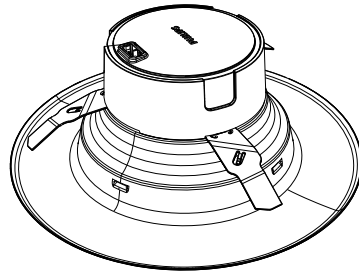

Excl.

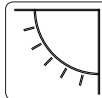
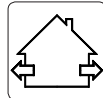
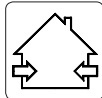
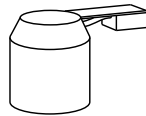

2

ARTWORK

Master Ref: **PHL502304**
TR Ref: **TR2355768**
Brand: PHILIPS
Brand execution: HUE White and Color Ambiance
Product name:
Article Number: N/A
Region: Trident UK
Template Ref: As Previous
Artwork Ref: 440402911712
Die cut 12NC:
Barcode: N/A
CRC Number:
Action: **B**
Date: 17/01/2022

Project Manager: Margarita Papoutsis

Trident Artist: Samantha Reilly

Technical & Non Printing Items

■ Dieline ■ Guides

Colours:



PHILIPS



TRIDENT

Trident UK, Connaught House, Connaught Road,
Kingswood Business Park, Hull, HU7 3AP, England.
T: +44 (0) 01482 828100

Please note that any low resolution paper Canon colour
copies associated with this job should be referred to for
content, layout and colour separation only.

UNDER NO CIRCUMSTANCES SHOULD THIS
ARTWORK BE ALTERED WITHOUT PRIOR
PERMISSION FROM TRIDENT.

100 mm

120 mm

EN **WARNING – Risk of fire or electric shock. LED Retrofit Kit installation requires knowledge of luminaires electrical systems. If not qualified, do not attempt installation. Contact a qualified electrician.**

WARNING – Risk of fire or electric shock. Install this kit only in luminaires that have the construction features and dimensions shown in the photographs and/or drawings and where the input rating of the retrofit kit does not exceed the input ratings of the luminaire.

Do not make or alter any open holes in an enclosure of wiring or electrical components during kit installation.

WARNING – To prevent wiring damage or abrasion, do not expose wiring to edges of sheet metal or other sharp objects.

THIS RETROFIT KIT IS ACCEPTED AS A COMPONENT OF A LUMINAIRE WHERE THE SUITABILITY OF THE COMBINATION SHALL BE DETERMINED BY AUTHORITIES HAVING JURISDICTION. PRODUCT MUST BE INSTALLED BY A QUALIFIED ELECTRICIAN IN ACCORDANCE WITH THE APPLICABLE AND APPROPRIATE ELECTRICAL CODES. THE INSTALLATION GUIDE DOES NOT SUPERSEDE LOCAL OR NATIONAL REGULATIONS FOR ELECTRICAL INSTALLATIONS.

Installers should examine all parts that are not intended to be replaced by the retrofit kit for damage and replace any damaged parts prior to installation of the retrofit kit.

THIS DEVICE IS NOT INTENDED FOR USE WITH EMERGENCY EXITS OR NOT FOR EMERGENCY LIGHTING

SUITABLE FOR TYPE IC OR NON-IC LUMINAIRES

This lamp is only compatible with provided or other specified controls listed in these instructions for proper functionality. This lamp will not operate properly when connected to a standard incandescent dimmer or other off-shelf dimming controls.

The Hue Retrofit Recessed Downlight is designed to install into most recessed can fixtures. However, please be aware that it may not be compatible with some models. Always ensure a secure fit into the can and ensure that the Hue Retrofit Recessed Downlight fits firmly against the ceiling and does not sag out of the fixture.

The retrofit down light should be used only with metal housing, and the metal housing should be grounded

3

Master Ref: **PHL502304**
 TR Ref: **TR2355768**
 Brand: PHILIPS
 Brand execution: HUE White and Color Ambiance
 Product name:
 Article Number: N/A
 Region: Trident UK
 Template Ref: As Previous
 Artwork Ref: 440402911712
 Die cut 12NC:
 Barcode: N/A
 CRC Number:
 Action: **B**
 Date: 17/01/2022

Project Manager: Margarita Papoutsis

Trident Artist: Samantha Reilly

Technical & Non Printing Items

■ Dieline ■ Guides

Colours:



PHILIPS



TRIDENT
 Trident UK, Connaught House, Connaught Road,
 Kingswood Business Park, Hull, HU7 3AP, England.
 T: +44 (0) 01482 828100

Please note that any low resolution paper Canon colour copies associated with this job should be referred to for content, layout and colour separation only.

UNDER NO CIRCUMSTANCES SHOULD THIS ARTWORK BE ALTERED WITHOUT PRIOR PERMISSION FROM TRIDENT.

100 mm

120 mm

FR **AVERTISSEMENT – Risques d'incendie ou de décharge électrique.** L'ensemble de modernisation DEL requiert une connaissance des systèmes de luminaires électriques. Ne pas procéder à l'installation à moins de disposer des compétences appropriées. Communiquez avec un électricien qualifié.

AVERTISSEMENT – Risques d'incendie ou de décharge électrique. Cet ensemble ne doit être installé que sur les luminaires possédant les caractéristiques de constructions et les dimensions indiquées sur les photos ou les dessins. La tension d'entrée de l'ensemble de modernisation ne doit pas dépasser celle du luminaire.

Ne pas percer ou modifier des ouvertures dans un boîtier de câblage ou de composants électriques au cours de l'installation de l'ensemble.

AVERTISSEMENT – Pour éviter les dommages aux câbles et les abrasions, les câbles ne doivent pas être exposés aux bordures en tôle ou autres objets tranchants.5

LE KIT DE RÉNOVATION EST ACCEPTÉ COMME COMPOSANT D'UN LUMINAIRE OU LA CONVENANCE DE LA COMBINAISON EST DÉTERMINÉE PAR LES AUTORITÉS COMPÉTENTES. LE PRODUIT DOIT ÊTRE INSTALLÉ PAR UN ÉLECTRICIEN QUALIFIÉ CONFORMÉMENT AUX CODES ÉLECTRIQUES APPLICABLES ET APPROPRIÉS. LE GUIDE D'INSTALLATION NE REMPLACE PAS LES RÉGLEMENTS LOCAUX OU NATIONAUX POUR LES INSTALLATIONS ÉLECTRIQUES.

Les installateurs doivent examiner toutes les pièces qui ne sont pas destinées à être remplacées par le kit de rénovation pour les dommages et remplacer toutes les pièces endommagées avant l'installation du kit de rénovation.

CET APPAREIL N'EST PAS CONÇU POUR UNE UTILISATION AVEC LES SORTIES DE SECOURS ou PAS POUR L'ÉCLAIRAGE DE SECOURS

CONVIENT AUX LUMINAIRES DE TYPES IC OU NON-IC.

Afin d'en assurer un fonctionnement adéquat, cette lampe est **SEULEMENT** compatible avec les contrôles inclus ou d'autres contrôles spécifiés dans ces directives. Cette lampe ne fonctionnera pas correctement avec un gradateur incandescent régulier ou d'autres contrôles de gradation en vente libre.

Le produit Hue Éclairage direct encastré de rénovation est conçu pour installation dans la plupart des luminaires encastrés.

Toutefois, sachez qu'il se peut qu'il ne soit pas compatible avec certains modèles. On doit donc toujours s'assurer d'un bon ajustement dans le luminaire et que Hue Éclairage direct encastré de rénovation est fixé solidement au plafond, sans dépasser ou pendre du luminaire.



Cet éclairage encastré pour installation en rattrapage doit être utilisé avec le boîtier en métal et ce boîtier doit être mis à la terre.

Master Ref: **PHL502304**
 TR Ref: **TR2355768**
 Brand: PHILIPS
 Brand execution: HUE White and Color Ambiance
 Product name:
 Article Number: N/A
 Region: Trident UK
 Template Ref: As Previous
 Artwork Ref: 440402911712
 Die cut 12NC:
 Barcode: N/A
 CRC Number:
 Action: **B**
 Date: 17/01/2022

Project Manager: Margarita Papoutsis

Trident Artist: Samantha Reilly

Technical & Non Printing Items

 Dieline  Guides

Colours:



PHILIPS



TRIDENT
 Trident UK, Connaught House, Connaught Road,
 Kingswood Business Park, Hull, HU7 3AP, England.
 T: +44 (0) 01482 828100

Please note that any low resolution paper Canon colour copies associated with this job should be referred to for content, layout and colour separation only.

UNDER NO CIRCUMSTANCES SHOULD THIS ARTWORK BE ALTERED WITHOUT PRIOR PERMISSION FROM TRIDENT.

100 mm

120 mm

ES **ADVERTENCIA:** Riesgo de incendio o descarga eléctrica. La instalación del kit de retroajuste LED requiere que el electricista conozca los sistemas eléctricos de las luminarias. Si no está calificado, no intente realizar la instalación. Comuníquese con un electricista calificado.

ADVERTENCIA: Riesgo de incendio o descarga eléctrica. Instale este kit solo en las luminarias que cumplen con las características y dimensiones de construcción que se muestran en las fotografías o dibujos, y en donde la potencia de entrada del kit de retroajuste no exceda la potencia de entrada de la luminaria.

No haga ni altere orificios abiertos en un recinto donde haya cableado o componentes eléctricos durante la instalación del kit.

ADVERTENCIA: Para prevenir daños o abrasión en el cableado, no lo exponga a bordes afilados o a láminas de metal, o a otros objetos puntiagudos.

Este kit de retroajuste LED es aceptado como un componente de una luminaria donde la combinación idónea será determinada por las autoridades con jurisdicción competente. **UN ELECTRICISTA CALIFICADO DEBE INSTALAR EL PRODUCTO DE ACUERDO CON LOS CÓDIGOS ELÉCTRICOS APLICABLES Y APROPIADOS. LA GUÍA DE INSTALACIÓN NO SUSTITUYE LAS NORMAS LOCALES O NACIONALES PARA INSTALACIONES ELÉCTRICAS.**

Los instaladores deben examinar todas las piezas que no están previstas para reemplazarse mediante el kit de actualización para detectar daños y reemplazar las piezas dañadas antes de la instalación del kit de actualización.

ESTE DISPOSITIVO NO ESTÁ DISEÑADO PARA USARSE CON SALIDAS DE EMERGENCIA o NO PARA ILUMINACIÓN DE EMERGENCIA

APROPIADA PARA LUMINARIAS CON O SIN CONTACTO AISLADO

Utilice solamente los controles provistos o indicados en las instrucciones para controlar esta lámpara. Este producto no operara de manera correcta conectado a un dimmer estándar.

El Hue Downlight empotrado blanco está diseñado para instalarse en bote integrado. Toma en cuenta que existen modelos no compatibles. Siempre asegúrate de que las dimensiones del bote integrado sean compatibles con el luminario Hue Downlight empotrado blanco y que ajuste firmemente contra el techo.

El reacondicionamiento de luminarias debe usarse sólo con bote integrado, asegurarse que el bote integrado haga contacto a tierra.

ARTWORK

Master Ref: **PHL502304**
TR Ref: **TR2355768**
Brand: PHILIPS
Brand execution: HUE White and Color Ambiance
Product name:
Article Number: N/A
Region: Trident UK
Template Ref: As Previous
Artwork Ref: 440402911712
Die cut 12NC:
Barcode: N/A
CRC Number:
Action: **B**
Date: 17/01/2022

Project Manager: Margarita Papoutsis

Trident Artist: Samantha Reilly

Technical & Non Printing Items

■ Dieline ■ Guides

Colours:



PHILIPS



TRIDENT
Trident UK, Connaught House, Connaught Road,
Kingswood Business Park, Hull, HU7 3AP, England.
T: +44 (0) 01482 828100

Please note that any low resolution paper Canon colour copies associated with this job should be referred to for content, layout and colour separation only.

UNDER NO CIRCUMSTANCES SHOULD THIS ARTWORK BE ALTERED WITHOUT PRIOR PERMISSION FROM TRIDENT.

100 mm

120 mm

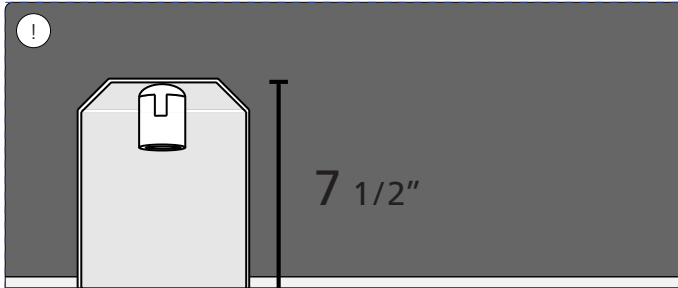

Ø5/6"

Depth of the metal can
Profondeur du boîtier de 6 po en métal
Profundidad del tacho de metal de 6"

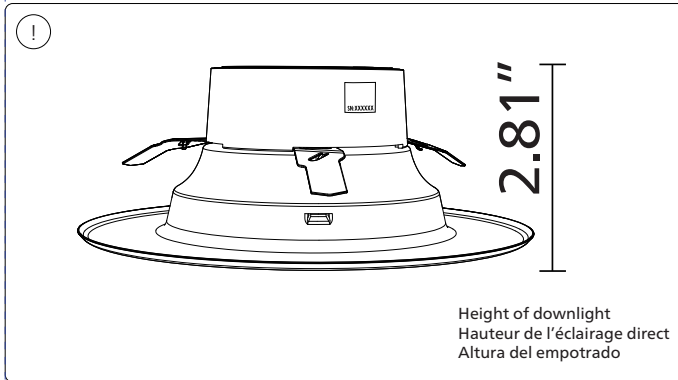

Height of downlight
Hauteur de l'éclairage direct
Altura del empotrado

6

Master Ref: **PHL502304**
 TR Ref: **TR2355768**
 Brand: PHILIPS
 Brand execution: HUE White and Color Ambiance
 Product name:
 Article Number: N/A
 Region: Trident UK
 Template Ref: As Previous
 Artwork 12NC: 440402911712
 Die cut 12NC:
 Barcode: N/A
 CRC Number:
 Action: **B**
 Date: 17/01/2022

Project Manager: Margarita Papoutsis

Trident Artist: Samantha Reilly

Technical & Non Printing Items

■ Dieline ■ Guides

Colours:



PHILIPS



Trident UK, Connaught House, Connaught Road,
 Kingswood Business Park, Hull, HU7 3AP, England.
 T: +44 (0) 01482 828100

Please note that any low resolution paper Canon colour
 copies associated with this job should be referred to for
 content, layout and colour separation only.

UNDER NO CIRCUMSTANCES SHOULD THIS
 ARTWORK BE ALTERED WITHOUT PRIOR
 PERMISSION FROM TRIDENT.

100 mm

120 mm

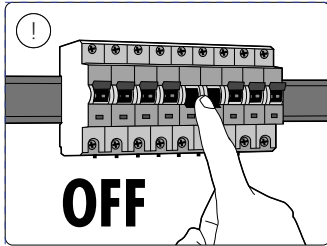

Switch off the mains before starting installation.

Couper le courant d'alimentation avant de commencer l'installation

Apague la electricidad antes de empezar la instalación

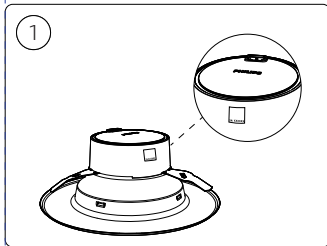

Step 1 - Please read and copy the serial number on the Hue downlight. You may need this number later to pair this product with the Hue Bridge.

Veuillez lire attentivement et copier le numéro de série sur l'éclairage direct Hue. Ce numéro pourrait vous être nécessaire plus tard pour appairer ce produit au pont Hue.

Por favor, lea y copie el número de serie en la luminaria Hue Downlight. Necesitará este número luego para emparejarlo con el Hue Bridge

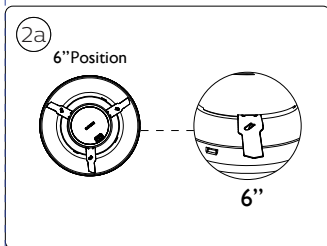

Step 2a - If your metal can is 6 inch in size, keep the 3 springs of the downlight in fully open position as shown.

Si votre boîtier en métal a une taille de 6 po, conserver les 3 ressorts sur l'éclairage direct entièrement ouverts, comme l'illustration.

Si su tacho de metal es de 6 pulgadas, deje las 3 clavijas de la luminaria en la posición abierta como se muestra

7

Master Ref: **PHL502304**
 TR Ref: **TR2355768**
 Brand: PHILIPS
 Brand execution: HUE White and Color Ambiance
 Product name:
 Article Number: N/A
 Region: Trident UK
 Template Ref: As Previous
 Artwork Ref: 440402911712
 Die cut 12NC:
 Barcode: N/A
 CRC Number:
 Action: **B**
 Date: 17/01/2022

Project Manager: Margarita Papoutsis

Trident Artist: Samantha Reilly

Technical & Non Printing Items

■ Dieline ■ Guides

Colours:



PHILIPS



Trident UK, Connaught House, Connaught Road,
 Kingswood Business Park, Hull, HU7 3AP, England.
 T: +44 (0) 01482 828100

Please note that any low resolution paper Canon colour
 copies associated with this job should be referred to for
 content, layout and colour separation only.

UNDER NO CIRCUMSTANCES SHOULD THIS
 ARTWORK BE ALTERED WITHOUT PRIOR
 PERMISSION FROM TRIDENT.

100 mm

120 mm

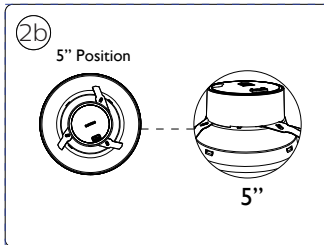

Step 2b - If your metal can is 5 inch in size, push the 3 springs in an angled position as shown.

Si votre boîtier en métal a une taille de 5 po, pousser les 3 ressorts en angle, comme l'illustration.

Si su tacho de metal es de 5 pulgadas, deje las 3 clavijas de la luminaria en la posición en ángulo como se muestra

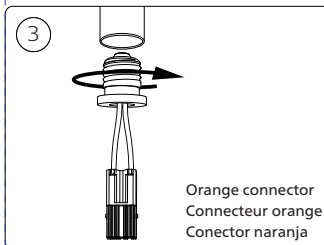

Step 3 - The E26 base with connector is included in the Hue Downlight package. Screw in the E26 base into the metal can, rotating it in an anti-clockwise direction in the holder.

Le culot E26 avec connecteur est inclus dans l'emballage de l'éclairage direct Hue. Visser le culot dans le boîtier en métal, le tournant dans la douille en sens contraire aux aiguilles d'une montre.

El conector con base E26 está incluido en el paquete de la luminaria. Enrosque la base E26 en el tacho de metal, rotando en sentido anti-horario

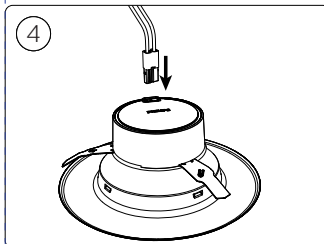

Step 4 - Plug the orange connector in to the base of the downlight

Brancher le connecteur orange dans le culot de l'éclairage direct.

Enchufe el conector naranja en la base de la luminaria

8

Master Ref: **PHL502304**
 TR Ref: **TR2355768**
 Brand: PHILIPS
 Brand execution: HUE White and Color Ambiance
 Product name:
 Article Number: N/A
 Region: Trident UK
 Template Ref: As Previous
 Artwork 12NC: 440402911712
 Die cut 12NC:
 Barcode: N/A
 CRC Number:
 Action: **B**
 Date: 17/01/2022

Project Manager: Margarita Papoutsis

Trident Artist: Samantha Reilly

Technical & Non Printing Items

■ Dieline ■ Guides

Colours:



PHILIPS



TRIDENT
 Trident UK, Connaught House, Connaught Road,
 Kingswood Business Park, Hull, HU7 3AP, England.
 T: +44 (0) 01482 828100

Please note that any low resolution paper Canon colour copies associated with this job should be referred to for content, layout and colour separation only.

UNDER NO CIRCUMSTANCES SHOULD THIS ARTWORK BE ALTERED WITHOUT PRIOR PERMISSION FROM TRIDENT.

100 mm

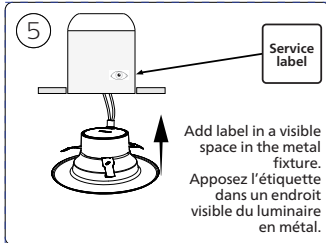

Step 5 - Push the downlight upwards through the cut out towards the metal can. Your Hue Downlight is installed.

Pousser l'éclairage direct vers le haut à travers la découpe, vers le boîtier en métal. Votre éclairage direct Hue est maintenant installé.

Empuje la luminaria hacia arriba a través del agujero del tacho de metal. Su luminaria empotrada Hue Downlight está instalada

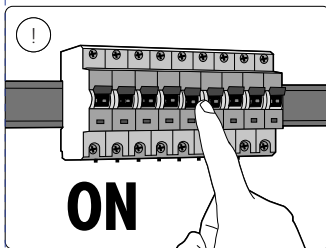

Switch on the mains.

There are 2 ways of controlling your Hue Downlight:

1. Pair it with the Hue Bridge (sold separately) to control via the Philips Hue App for advance control such as room setup, routines. You can control up to 50 lights in your home with a Hue Bridge. 2. You can connect via Bluetooth on the Philips Hue Bluetooth App. You can control maximum 10 lights with this.

Rétablir le courant d'alimentation.

Il existe deux façons de contrôler votre éclairage direct Hue:

1. L'appareiller au pont Hue (vendu

séparément) pour contrôler au moyen de l'application Philips Hue et obtenir un contrôle prédéfini comme le réglage et les routines des pièces. Vous pouvez contrôler jusqu'à 50 lumières de votre maison avec un pont Hue. 2. Vous pouvez choisir une connexion par Bluetooth sur l'application Bluetooth Philips Hue. Vous pouvez contrôler un maximum de 10 lumières de cette façon.

Encienda la electricidad

Hay dos maneras de controlar su empotrado Hue Downlight:

1. Empareje con un Hue Bridge (vendido por separado) para controlar vía la app Philips Hue y tener un control avanzado con control por habitaciones o rutinas. Puede controlar hasta 50 luces en su hogar con un bridge Hue 2. Puede conectar vía Bluetooth con la app Philips Hue Bluetooth. Puede controlar un máximo de 10 luces.

Master Ref: **PHL502304**
 TR Ref: **TR2355768**
 Brand: PHILIPS
 Brand execution: HUE White and Color Ambiance
 Product name:
 Article Number: N/A
 Region: Trident UK
 Template Ref: As Previous
 Artwork Ref: 440402911712
 Die cut 12NC:
 Barcode: N/A
 CRC Number:
 Action: **B**
 Date: 17/01/2022

Project Manager: Margarita Papoutsis

Trident Artist: Samantha Reilly

Technical & Non Printing Items

■ Dieline ■ Guides

Colours:

Black	1
	2%

PHILIPS



TRIDENT

Trident UK, Connaught House, Connaught Road,
 Kingswood Business Park, Hull, HU7 3AP, England.
 T: +44 (0) 01482 828100

Please note that any low resolution paper Canon colour
 copies associated with this job should be referred to for
 content, layout and colour separation only.

UNDER NO CIRCUMSTANCES SHOULD THIS
 ARTWORK BE ALTERED WITHOUT PRIOR
 PERMISSION FROM TRIDENT.

100 mm

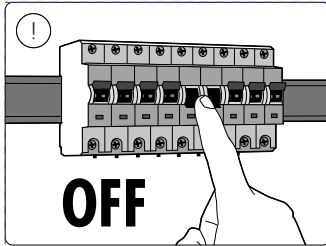

To uninstal - switch off the mains.

Pour désinstaller - couper le courant
 d'alimentation

Para desinstalar - apague la electricidad

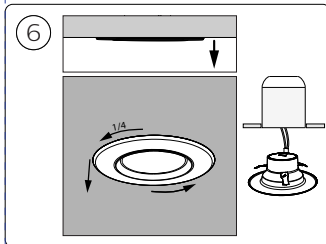

Step 6 - Rotate the downlight anti-clockwise
 1/4th of the circumference and pull it out.

Tourner l'éclairage direct en sens contraire
 aux aiguilles d'une montre sur ¼ de la
 circonférence, puis le tirer vers l'extérieur.

Rote la luminaria empotrada en sentido
 anti-horario ¼ de la circunferencia y tire
 hacia abajo

10

120 mm

ARTWORK

Master Ref: **PHL502304**
TR Ref: **TR2355768**
Brand: PHILIPS
Brand execution: HUE White and Color Ambiance
Product name:
Article Number: N/A
Region: Trident UK
Template Ref: As Previous
Artwork 12NC: 440402911712
Die cut 12NC:
Barcode: N/A
CRC Number:
Action: **B**
Date: 17/01/2022

Project Manager: Margarita Papoutsis

Trident Artist: Samantha Reilly

Technical & Non Printing Items

■ Dieline ■ Guides

Colours:



PHILIPS



TRIDENT
Trident UK, Connaught House, Connaught Road,
Kingswood Business Park, Hull, HU7 3AP, England.
T: +44 (0) 01482 828100

Please note that any low resolution paper Canon colour copies associated with this job should be referred to for content, layout and colour separation only.

UNDER NO CIRCUMSTANCES SHOULD THIS ARTWORK BE ALTERED WITHOUT PRIOR PERMISSION FROM TRIDENT.

100 mm

120 mm

EN How to get started
FR Commencez
ES Cómo empezar

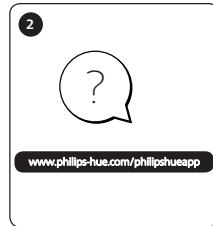
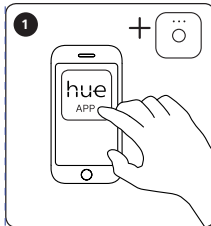
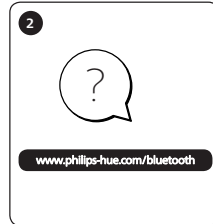
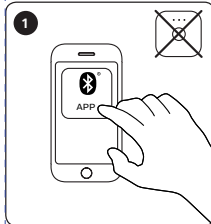

ARTWORK

Master Ref: **PHL502304**
TR Ref: **TR2355768**
Brand: PHILIPS
Brand execution: HUE White and Color Ambiance
Product name:
Article Number: N/A
Region: Trident UK
Template Ref: As Previous
Artwork Ref: 440402911712
Die cut 12NC:
Barcode: N/A
CRC Number:
Action: **B**
Date: 17/01/2022

Project Manager: Margarita Papoutsi

Trident Artist: Samantha Reilly

Technical & Non Printing Items

■ Dieline ■ Guides

Colours:



PHILIPS



TRIDENT

Trident UK, Connaught House, Connaught Road,
Kingswood Business Park, Hull, HU7 3AP, England.
T: +44 (0) 01482 828100

Please note that any low resolution paper Canon colour
copies associated with this job should be referred to for
content, layout and colour separation only.

UNDER NO CIRCUMSTANCES SHOULD THIS
ARTWORK BE ALTERED WITHOUT PRIOR
PERMISSION FROM TRIDENT.

100 mm

120 mm



Signify North America Corporation
400 Crossing Blvd, Suite 600
Bridgewater, NJ 08807, USA

Signify Canada Ltd./Signify Canada Ltée.
281 Hillmount Road,
Markham, ON, Canada L6C 2S3

Questions or Comments / Questions ou commentaires :
1-800-555-0050

© 2022 Signify Holding
All rights reserved

www.philips-hue.com

4404 029 11712
Last update: 01/2022