



Test report No:
2150357R-RF-US-P06V01

FCC & ISED TEST REPORT

| | |
|---|--|
| Product Name | LED lamp |
| Trademark | PHILIPS |
| Model and /or type reference | 9290030516, 9290030518, 9290030520 |
| FCC ID | 9290030516: 2AGBW9290030516X 9290030518: 2AGBW9290030518X 9290030520: 2AGBW9290030520X |
| IC | 9290030516: 20812-30516X 9290030518: 20812-30518X 9290030520: 20812-30520X |
| Applicant's name / address | Signify (China) Investment Co., Ltd Building no.9, Lane 888, Tianlin Road, Minhang District, Shanghai, China |
| Test method requested, standard | FCC CFR Title 47 Part 15 Subpart C Section 15.247 ANSI C63.10: 2013 KD558074 D01 15.247 Meas Guidance v05r02 RSS-Gen Issue 5 RSS-247 Issue 2 |
| Verdict Summary | IN COMPLIANCE |
| Tested by (name / position & signature) | Scott Shen/Project Engineer  |
| Approved by (name / position & signature) | Jack Zhang/Supervisor  |
| Date of issue | 2021-07-05 |
| Report Version | V1.0 |
| Report template No | Template_FCC 15.247-RF-V1.0 |

INDEX

| | page |
|--|------|
| General conditions | 4 |
| Environmental conditions | 4 |
| Possible test case verdicts | 5 |
| Abbreviations..... | 5 |
| Document History..... | 6 |
| Remarks and Comments | 6 |
| Used Equipment..... | 7 |
| Uncertainty | 9 |
| 1 General Information | 10 |
| 1.1 General Description of the Item(s)..... | 10 |
| 1.2 Antenna Information | 11 |
| 1.3 Channel List..... | 12 |
| 2 Description of Test Setup..... | 13 |
| 2.1 Operating mode(s) used for tests | 13 |
| 2.2 Auxiliary equipment / Test software for the EUT | 13 |
| 2.3 Test Configuration / Block diagram used for tests..... | 14 |
| 2.4 Testing process | 15 |
| 3 Verdict summary section..... | 16 |
| 3.1 Standards | 16 |
| 3.2 Deviation(s) from the Standard(s) / Test Specification(s)..... | 16 |
| 3.3 Overview of results | 17 |
| 3.4 Test Facility..... | 18 |
| 4 Test Results | 19 |
| 4.1 AC Power Line Conducted Emission..... | 19 |
| 4.1.1 Limit | 19 |
| 4.1.2 Test Setup | 19 |
| 4.1.3 Test Procedure | 19 |
| 4.1.4 Test Data | 20 |
| 4.2 Emissions in restricted frequency bands | 22 |
| 4.2.1 Limit | 22 |
| 4.2.2 Test Setup | 24 |
| 4.2.3 Test Procedure | 24 |
| 4.2.4 Test Data | 25 |
| 4.3 Emissions in non-restricted frequency band | 33 |

| | | |
|-------|---|----|
| 4.3.1 | Limit | 33 |
| 4.3.2 | Test Setup | 33 |
| 4.3.3 | Test Procedure | 33 |
| 4.3.4 | Test Data | 34 |
| 4.4 | Duty cycle | 35 |
| 4.4.1 | Limit | 35 |
| 4.4.2 | Test Setup | 35 |
| 4.4.3 | Test Procedure | 35 |
| 4.4.4 | Test Data | 36 |
| 4.5 | Radiated Emission Band Edge | 37 |
| 4.5.1 | Limit | 37 |
| 4.5.2 | Test Setup | 37 |
| 4.5.3 | Test Procedure | 37 |
| 4.5.4 | Test Data | 38 |
| 4.6 | DTS Bandwidth | 46 |
| 4.6.1 | Limit | 46 |
| 4.6.2 | Test Setup | 46 |
| 4.6.3 | Test Procedure | 46 |
| 4.6.4 | Test Data | 47 |
| 4.7 | Fundamental emission output power | 48 |
| 4.7.1 | Limit | 48 |
| 4.7.2 | Test Setup | 48 |
| 4.7.3 | Test Procedure | 49 |
| 4.7.4 | Test Data | 50 |
| 4.8 | Power Density | 51 |
| 4.8.1 | Limit: | 51 |
| 4.8.2 | Test Setup | 51 |
| 4.8.3 | Test Procedure | 51 |
| 4.8.4 | Test Data | 52 |
| 4.9 | Antenna Requirement | 53 |
| 4.9.1 | Limit: | 53 |
| 4.9.2 | Antenna Connector Construction: | 53 |
| 5 | Test setup photo and EUT Photo | 54 |

COMPETENCES AND GUARANTEES

DEKRA is a testing laboratory competent to carry out the tests described in this report.

In order to assure the traceability to other national and international laboratories, DEKRA has a calibration and maintenance program for its measurement equipment.

DEKRA guarantees the reliability of the data presented in this report, which is the result of the measurements and the tests performed to the item under test on the date and under the conditions stated in the report and it is based on the knowledge and technical facilities available at DEKRA at the time of performance of the test.

DEKRA is liable to the client for the maintenance of the confidentiality of all information related to the item under test and the results of the test.

The results presented in this Test Report apply only to the particular item under test established in this document.

IMPORTANT: No parts of this report may be reproduced or quoted out of context, in any form or by any means, except in full, without the previous written permission of DEKRA.

GENERAL CONDITIONS

| | |
|----------------------|--|
| Test Location | No. 99, Hongye Road, Suzhou Industrial Park Suzhou, 215006, P.R. China |
| Date(receive sample) | May. 12, 2021 |
| Date (start test) | May. 13, 2021 |
| Date (finish test) | Jun. 10, 2021 |

1. This report is only referred to the item that has undergone the test.
2. This report does not constitute or imply on its own an approval of the product by the Certification Bodies or Competent Authorities.
3. This document is only valid if complete; no partial reproduction can be made without previous written permission of DEKRA.
4. This test report cannot be used partially or in full for publicity and/or promotional purposes without previous written permission of DEKRA.

ENVIRONMENTAL CONDITIONS

The climatic conditions during the tests are within the limits specified by the manufacturer for the operation of the EUT and the test equipment. The climatic conditions during the tests were within the following limits:

| | |
|-----------------------|---------------|
| Ambient temperature | 15 °C – 35 °C |
| Relative Humidity air | 30% - 60% |

If explicitly required in the basic standard or applied product / product family standard the climatic values are recorded and documented separately in this test report.

POSSIBLE TEST CASE VERDICTS

| | |
|---|-----------------|
| Test case does not apply to test object | N/A |
| Test object does meet requirement | P (Pass) / PASS |
| Test object does not meet requirement | F (Fail) / FAIL |
| Not measured | N/M |

ABBREVIATIONS

For the purposes of the present document, the following abbreviations apply:

| | |
|-------|-------------------------------|
| EUT | : Equipment Under Test |
| QP | : Quasi-Peak |
| CAV | : CISPR Average |
| AV | : Average |
| CDN | : Coupling Decoupling Network |
| SAC | : Semi-Anechoic Chamber |
| OATS | : Open Area Test Site |
| BW | : Bandwidth |
| AM | : Amplitude Modulation |
| PM | : Pulse Modulation |
| HCP | : Horizontal Coupling Plane |
| VCP | : Vertical Coupling Plane |
| U_N | : Nominal voltage |
| T_x | : Transmitter |
| R_x | : Receiver |
| N/A | : Not Applicable |
| N/M | : Not Measured |

DOCUMENT HISTORY

| Report No. | Version | Description | Issued Date |
|-----------------------|---------|--------------------------|-------------|
| 2150357R-RF-US-P06V01 | V1.0 | Initial issue of report. | 2021-07-05 |
| | | | |
| | | | |
| | | | |
| | | | |
| | | | |
| | | | |
| | | | |
| | | | |

REMARKS AND COMMENTS

1. The equipment under test (EUT) does meet the essential requirements of the stated standard(s)/test(s).
2. These test results on a sample of the device are for the purpose of demonstrating Compliance with Part 15 Subpart C Paragraph 15.247, RSS-Gen Issue 5, RSS-247 Issue 2.
3. The measurement result is considered in conformance with the requirement if it is within the prescribed limit, It is not necessary to account the uncertainty associated with the measurement result.
4. The test results presented in this report relate only to the object tested.
5. The test report shall not be reproduced without the written approval of DEKRA Testing and Certification (Suzhou) Co., Ltd.
6. This report will not be used for social proof function in China market.
7. DEKRA declines any responsibility with the following test data provided by customer that may affect the validity of result:
 - Chapter 1.1 General Description of the Item(s);
 - Chapter 1.2 Antenna Information;
 - Chapter 1.3 Channel List.

USED EQUIPMENT

AC Power Line Conducted Emission / TR1

| Instrument | Manufacturer | Model No. | Serial No. | Cal. Date | Next Cal. Date |
|----------------------------|--------------|-----------|------------|------------|----------------|
| Two-Line V-Network | R&S | ENV216 | 101044 | 2021.03.20 | 2022.03.19 |
| 50ohm Termination | SHX | TF2 | 7081402 | 2020.09.23 | 2021.09.22 |
| 50ohm Termination | SHX | TF2 | 7081403 | 2020.09.23 | 2021.09.22 |
| 50ohm Coaxial Switch | Anritsu | MP59B | 6200464462 | N/A | N/A |
| Temperature/Humidity Meter | RTS | RTS-8S | TR1-TH | 2020.08.23 | 2021.08.22 |
| Dekra test software | Dekra | - | - | - | - |

Emissions in non-restricted frequency bands/ Occupied Bandwidth/ Fundamental emission output power/ Power Spectral Density / TR8

| Instrument | Manufacturer | Model No. | Serial No. | Cal. Date | Next Cal. Date |
|----------------------------|--------------|-----------|----------------|------------|----------------|
| Spectrum Analyzer | Agilent | N9010A | MY48030494 | 2020.08.15 | 2021.08.14 |
| EXA Spectrum Analyzer | Keysight | N9010A | MY55370495 | 2021.03.20 | 2022.03.19 |
| MXA Signal Analyzer | Keysight | N9020A | MY56060147 | 2020.08.15 | 2021.08.14 |
| 4TX MIMO Power Sensor | Keysight | X8750A | MY59400102 | 2021.02.11 | 2022.02.10 |
| Coaxial Cable | Woken | SFL402 | F02-150410-044 | 2021.01.01 | 2021.12.31 |
| Temperature/Humidity Meter | RTS | RTS-8S | RF08 | 2020.08.13 | 2021.08.12 |

Radiated Emission(30MHz-1GHz) / AC3

| Instrument | Manufacturer | Model No. | Serial No. | Cal. Date | Next Cal. Date |
|----------------------------|--------------|-----------|------------|------------|----------------|
| EMI Test Receiver | R&S | ESCI | 100176 | 2020.08.15 | 2021.08.14 |
| Bilog Antenna | Teseq GmbH | CBL6112D | 27613 | 2020.08.19 | 2021.08.18 |
| Coaxial Cable | Huber+Suhner | RG 214 | AC3-C | 2021.03.31 | 2022.03.30 |
| Temperature/Humidity Meter | RTS | RTS-8S | AC3-TH | 2020.08.13 | 2021.08.12 |
| Dekra test software | Dekra | - | - | - | - |

Radiated Emission(1GHz-40GHz) / AC5

| Instrument | Manufacturer | Model No. | Serial No. | Cal. Date | Next Cal. Date |
|----------------------------|--------------|------------------------|------------|------------|----------------|
| EXA Spectrum Analyzer | Keysight | N9010A | MY55370495 | 2021.03.20 | 2022.03.19 |
| Amplifier | Keleto | LNPA | SK20190225 | 2020.09.25 | 2021.09.24 |
| Preamplifier | EMCI | EMC184045SE | 980263 | 2021.05.22 | 2022.05.21 |
| DRG Horn Antenna | ETS-Lindgren | 3117 | 00167055 | 2020.08.06 | 2021.08.05 |
| Broad-Band Horn Antenna | Schwarzbeck | BBHA9170 | 294 | 2021.04.14 | 2023.04.13 |
| Coaxial Cable | Huber+Suhner | SUCOFLEX 106 | AC5-C2 | 2021.03.31 | 2022.03.30 |
| Coaxial Cable | ROSENBERGER | LA1-C011- 2000/3000 | AC5-40G | 2021.03.20 | 2022.03.19 |
| Temperature/Humidity Meter | RTS | RTS-8S | AC5-TH | 2020.08.13 | 2021.08.12 |
| Dekra test software | Dekra | - | - | - | - |

UNCERTAINTY

Uncertainties have been calculated according to the DEKRA internal document. The reported expanded uncertainties are based on a standard uncertainty multiplied by a coverage factor of $k=2$, providing a level of confidence of approximately 95%. The Uncertainties is comply with standard required as below.

| Test item | Uncertainty |
|----------------------------------|--|
| AC Power Line Conducted Emission | 9kHz~150kHz: 2.80dB 150kHz~30MHz: 2.40dB |
| Peak Power Output | ± 1.27 dB |
| Radiated Emission(30MHz~1GHz) | Horizontal: 30MHz~200MHz: 3.50 dB 300MHz~1GHz: 3.60 dB Vertical: 30MHz~200MHz: 3.60 dB 300MHz~1GHz: 3.50 dB |
| Radiated Emission(1GHz~26.5GHz) | Horizontal: 1GHz~18GHz: 5.00 dB Vertical: 1GHz~18GHz: 4.80 dB |
| RF antenna conducted test | ± 1.27 dB |
| Radiated Emission Band Edge | ± 3.9 dB |
| DTS Bandwidth | ± 150 Hz |
| Occupied Bandwidth | ± 1 kHz |
| Power Density | ± 1.27 dB |

1 GENERAL INFORMATION

1.1 General Description of the Item(s)

| | |
|----------------------------|--|
| Product Name | LED lamp |
| Model No. | 9290030516, 9290030518, 9290030520 |
| FCC ID | 9290030516: 2AGBW9290030516X 9290030518: 2AGBW9290030518X 9290030520: 2AGBW9290030520X |
| IC | 9290030516: 20812-30516X 9290030518: 20812-30518X 9290030520: 20812-30520X |
| Manufacturer | Signify (China) Investment Co., Ltd |
| Manufacturer Address | Building no.9, Lane 888, Tianlin Road, Minhang District, Shanghai, China |

| | |
|------------------------------------|-----------------|
| Wireless specification | Zigbee |
| Operating frequency range(s) | 2400~2483.5 MHz |
| Type of Modulation | DSSS-OQPSK |
| Number of channel | 16 |
| Date Rate | 250kbps max |

| | | |
|--------------------------|-------------------------------------|-----------------------------|
| Rated power supply | Voltage and Frequency | |
| | <input type="checkbox"/> | AC: 220 – 240 V, 50/60 Hz |
| | <input checked="" type="checkbox"/> | AC: 110 – 130 Vac, 50/60 Hz |
| | <input type="checkbox"/> | DC: 24 Vdc |
| | <input type="checkbox"/> | Battery: |

| Model name | Lamp cap | Rated power | Rated voltage |
|------------|----------|-------------|--------------------------|
| 9290030516 | E26 | 7W | 110-130 Vac, 50/60 Hz |
| 9290030518 | E26 | | |
| 9290030520 | E26 | | |

1.2 Antenna Information

| | | | |
|-----------------------------------|-------------------------------------|--------------------------------------|--|
| Antenna model / type number | N/A | | |
| Antenna serial number | N/A | | |
| Antenna Delivery | <input checked="" type="checkbox"/> | 1TX + 1RX | |
| | <input type="checkbox"/> | 2TX + 2RX | |
| Antenna technology | <input checked="" type="checkbox"/> | SISO | |
| | <input type="checkbox"/> | MIMO | <input type="checkbox"/> CDD <input type="checkbox"/> Beam-forming |
| Antenna Type | <input type="checkbox"/> | External | <input type="checkbox"/> Dipole <input type="checkbox"/> Sectorized |
| | <input checked="" type="checkbox"/> | Internal | <input type="checkbox"/> PIFA |
| | | | <input checked="" type="checkbox"/> PCB |
| | | | <input type="checkbox"/> Metal Monopole Antenna |
| | | <input type="checkbox"/> Others..... | |
| Antenna Gain | -0.36 dBi | | |

1.3 Channel List

| Working Frequency of Each Channel: For Zigbee | | | | | | | |
|---|-----------|---------|-----------|---------|-----------|---------|-----------|
| Channel | Frequency | Channel | Frequency | Channel | Frequency | Channel | Frequency |
| 11 | 2405 MHz | 12 | 2410 MHz | 13 | 2415 MHz | 14 | 2420 MHz |
| 15 | 2425 MHz | 16 | 2430 MHz | 17 | 2435 MHz | 18 | 2440 MHz |
| 19 | 2445 MHz | 20 | 2450 MHz | 21 | 2455 MHz | 22 | 2460 MHz |
| 23 | 2465 MHz | 24 | 2470 MHz | 25 | 2475 MHz | 26 | 2480 MHz |

Note: The general description of the Item(s), antenna information and channel list in clause 1 are provided and confirmed by the client.

2 DESCRIPTION OF TEST SETUP

2.1 Operating mode(s) used for tests

During the tests the following operating mode(s) has(have) been used.

| | |
|----------------------|---------------------------|
| Test Mode For Zigbee | Mode1: Transmit by Zigbee |
|----------------------|---------------------------|

2.2 Auxiliary equipment / Test software for the EUT

| Auxiliary equipment | Type / Version | Manufacturer | Supplied by |
|---------------------|----------------|--------------|-------------|
| Notebook | Think pad x220 | Lenovo | Adapter |
| Software | Type / Version | Manufacturer | Supplied by |
| ApprobationTool | N/A | N/A | N/A |

2.3 Test Configuration / Block diagram used for tests

Test setup Diagram- AC Line Conducted Emission Test

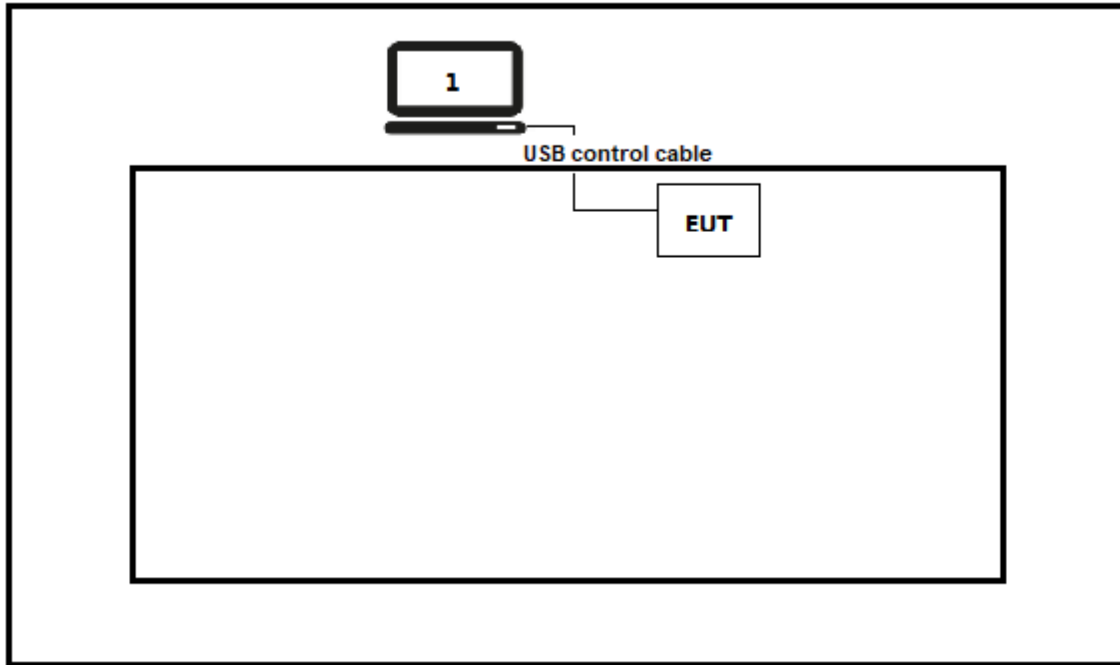

Test setup Diagram- Radiated Emission

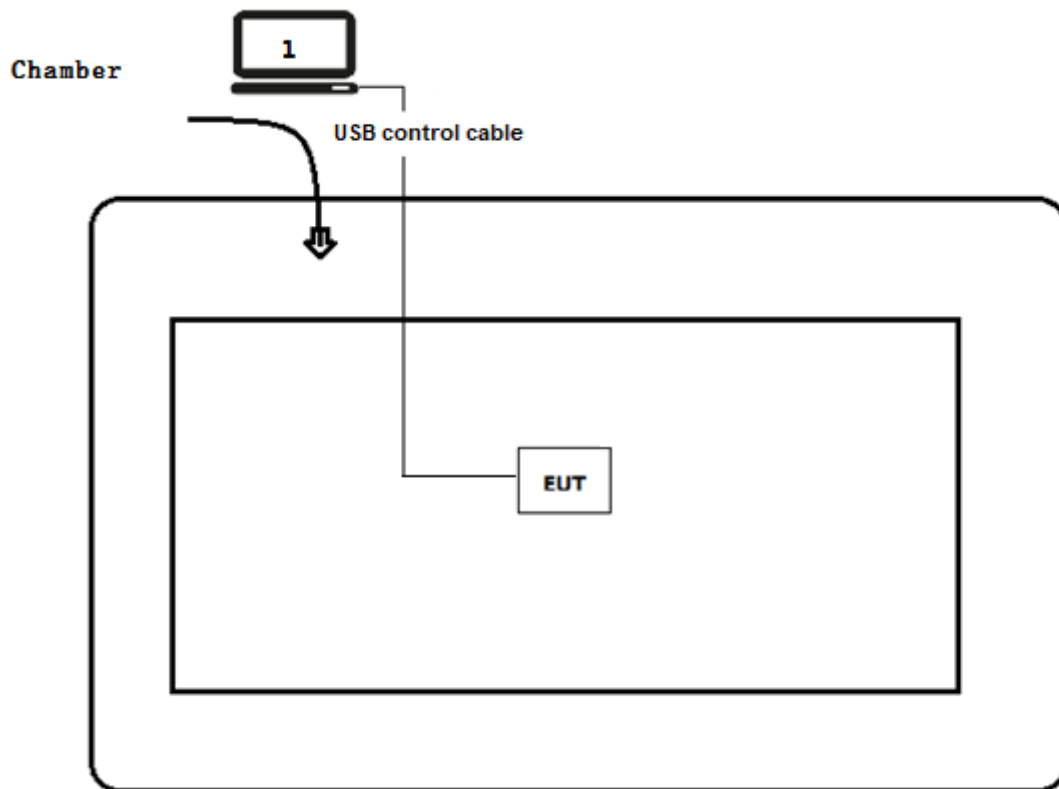

2.4 Testing process

| | |
|---|---|
| 1 | Setup the EUT as shown in Section 2.3. |
| 2 | Execute test software "ApprobationTool" on the notebook. |
| 3 | Configure the test mode, the test channel, and the data rate. |
| 4 | Verify that the EUT works properly. |

3 VERDICT SUMMARY SECTION

This chapter presents an overview of standards and results. Refer to the next chapters for details of measured test results and applied test levels.

3.1 Standards

| Standard | Year | Description |
|---|------|--|
| FCC CFR Title 47 Part 15 Subpart C Section 15.247 | 2021 | Operation within the bands 902–928 MHz, 2400–2483.5 MHz, and 5725–5850 MHz. |
| ANSI C63.10 | 2013 | American National Standard of Procedures for Compliance Testing of Unlicensed Wireless Devices |
| KDB558074 D01 v05r02 | 2019 | Guidance for performing compliance measurements on Digital Transmission System (DTS) operating under section 15.247 |
| RSS-Gen Issue 5 Amendment 2 | 2021 | General Requirements for Compliance of Radio Apparatus |
| RSS-247 Issue 2 | 2017 | Digital Transmission Systems (DTSs), Frequency Hopping Systems (FHSs) and Licence-Exempt Local Area Network (LE-LAN) Devices |

3.2 Deviation(s) from the Standard(s) / Test Specification(s)

The following deviation(s) was / were made from the published requirements of the listed standards: N/A.

(Please define the deviations from the standard(s) if applicable)

3.3 Overview of results

For FCC

| Requirement – Test case | Basic standard(s) | Verdict | Remark |
|---|---------------------------|---------|--------|
| AC Power Line Conducted Emission | FCC 15.207 | PASS | --- |
| Emissions in restricted frequency bands | FCC 15.247(b)(3) | PASS | --- |
| Duty cycle | ANSI C63.10:2013 | PASS | --- |
| Emissions in non-restricted frequency bands | FCC 15.247(d), FCC 15.209 | PASS | --- |
| Radiated Emission Band Edge | FCC 15.247(d) | PASS | --- |
| Fundamental emission output power | FCC 15.247(d), FCC 15.209 | PASS | --- |
| DTS Bandwidth | FCC 15.247(a)(2) | PASS | --- |
| Power Spectral Density | FCC 15.247(e) | PASS | --- |
| Antenna Requirement | FCC 15.203 | PASS | --- |

For ISED

| Requirement – Test case | Basic standard(s) | Verdict | Remark |
|---|--------------------------------|---------|--------|
| AC Power Line Conducted Emission | RSS-Gen Issue 5 Section 8.8 | PASS | --- |
| Emissions in restricted frequency bands | RSS-Gen Issue 5 Section 8.9 | PASS | --- |
| Duty cycle | ANSI C63.10:2013 | PASS | --- |
| Emissions in non-restricted frequency bands | RSS-247 Issue 2 Section 5.5 | PASS | --- |
| Radiated Emission Band Edge | RSS-Gen Issue 5 Section 8.10 | PASS | --- |
| Fundamental emission output power | RSS-247 Issue 2 Section 5.4(d) | PASS | --- |
| DTS Bandwidth | RSS-Gen Issue 5 Section 6.7 | PASS | --- |
| Power Spectral Density | RSS-247 Issue 2 Section 5.2(b) | PASS | --- |
| Antenna Requirement | RSS-Gen Issue 5 Section 6.8 | PASS | --- |

3.4 Test Facility

| | | |
|------------|----------|---------------------------------------|
| USA | : | FCC Designation Number: CN1199 |
| CA | : | ISED CAB identifier: CN0040 |

4 TEST RESULTS

4.1 AC Power Line Conducted Emission

VERDICT: PASS

4.1.1 Limit

| Standard | | |
|--|---------------------------------|---------------------------------|
| FCC Part 15 Subpart C Paragraph 15.207 | | |
| Frequency range [MHz] | Limit: QP [dB(μV) ¹⁾ | Limit: AV [dB(μV) ¹⁾ |
| 0,15 - 0,50 | 66 - 56 ²⁾ | 56 - 46 ²⁾ |
| 0,50 - 5,0 | 56 | 46 |
| 5,0 - 30 | 60 | 50 |

¹⁾ At the transition frequency, the lower limit applies.

²⁾ The limit decreases linearly with the logarithm of the frequency.

NOTE 1: The exclusion band for transmitters shall be considered for transmitters operating at frequencies below 30 MHz.

NOTE 2: Where the AC output port is directly connected (or via a circuit breaker) to the AC power input port of the EUT the AC power output port need not to be tested.

4.1.2 Test Setup

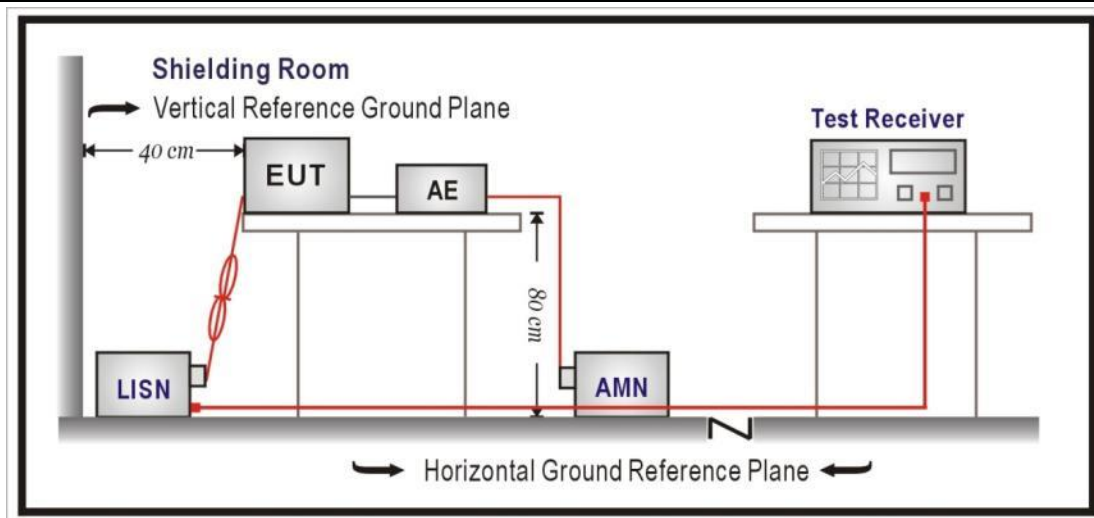

4.1.3 Test Procedure

| | References Rule | Chapter | Item |
|-------------------------------------|------------------|---------|---|
| <input checked="" type="checkbox"/> | ANSI C63.10-2013 | 6.2 | Standard test method for ac power-line conducted emissions from unlicensed wireless devices |

4.1.4 Test Data

| | |
|-----------------------------------|--------------------------|
| Profile: 2150357R | Page No.: 15 |
| Engineer: Jun | |
| Site: TR1 | Time: 2021/06/02 - 23:47 |
| Limit: FCC_Part15.207_CE_AC Power | Margin: 0 |
| Probe: ENV216_101190(0.009-30MHz) | Polarity: Line |
| EUT: LED lamp | Power: AC 120V/60Hz |
| Note: Mode 1 | |

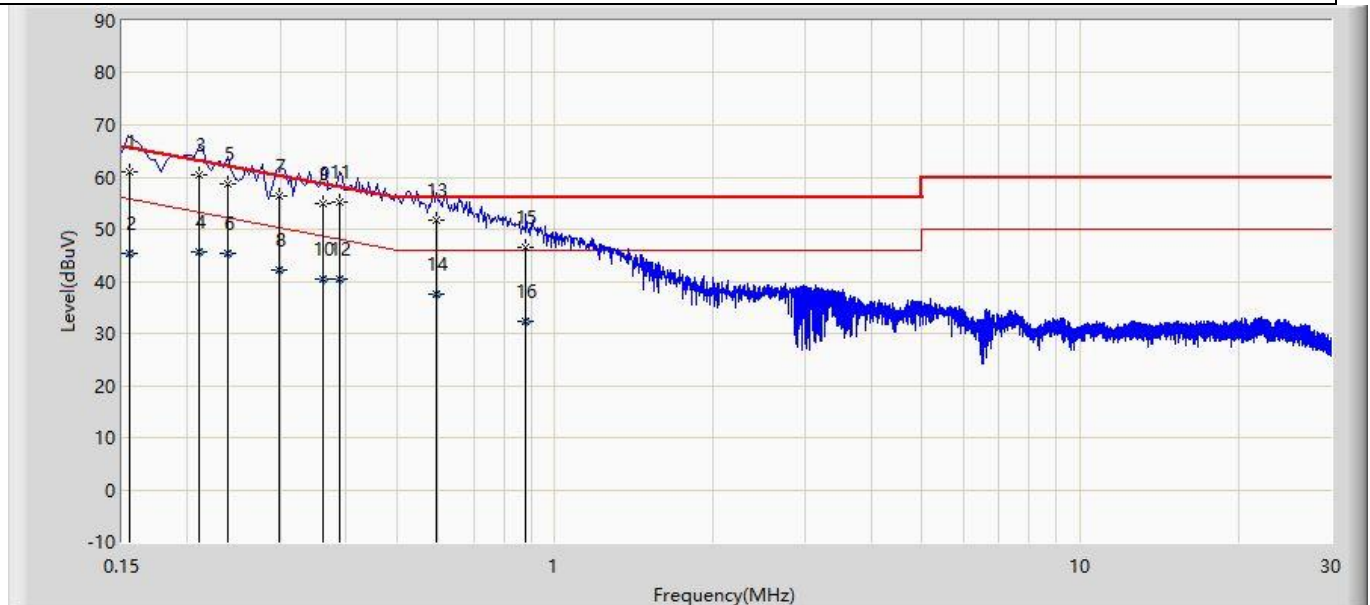

| No | Mark | Frequency (MHz) | Measure Level (dBuV) | Reading Level (dBuV) | Over Limit (dB) | Limit (dBuV) | Factor (dB) | Ant Pos (cm) | Table Pos (deg) | Type |
|----|------|-----------------|----------------------|----------------------|-----------------|--------------|-------------|--------------|-----------------|------|
| 1 | | 0.155 | 61.004 | 51.346 | -4.720 | 65.725 | 9.658 | 0 | 0 | QP |
| 2 | | 0.155 | 45.414 | 35.756 | -10.310 | 55.725 | 9.658 | 0 | 0 | AV |
| 3 | * | 0.210 | 60.464 | 50.771 | -2.741 | 63.205 | 9.694 | 0 | 0 | QP |
| 4 | | 0.210 | 45.633 | 35.939 | -7.573 | 53.205 | 9.694 | 0 | 0 | AV |
| 5 | | 0.238 | 58.706 | 49.001 | -3.459 | 62.166 | 9.705 | 0 | 0 | QP |
| 6 | | 0.238 | 45.285 | 35.580 | -6.881 | 52.166 | 9.705 | 0 | 0 | AV |
| 7 | | 0.298 | 56.451 | 46.714 | -3.848 | 60.298 | 9.736 | 0 | 0 | QP |
| 8 | | 0.298 | 42.257 | 32.521 | -8.042 | 50.298 | 9.736 | 0 | 0 | AV |
| 9 | | 0.362 | 55.019 | 45.253 | -3.664 | 58.682 | 9.766 | 0 | 0 | QP |
| 10 | | 0.362 | 40.446 | 30.680 | -8.236 | 48.682 | 9.766 | 0 | 0 | AV |
| 11 | | 0.390 | 55.073 | 45.292 | -2.991 | 58.064 | 9.781 | 0 | 0 | QP |
| 12 | | 0.390 | 40.494 | 30.713 | -7.570 | 48.064 | 9.781 | 0 | 0 | AV |
| 13 | | 0.594 | 51.712 | 41.845 | -4.288 | 56.000 | 9.867 | 0 | 0 | QP |
| 14 | | 0.594 | 37.464 | 27.597 | -8.536 | 46.000 | 9.867 | 0 | 0 | AV |
| 15 | | 0.882 | 46.571 | 36.627 | -9.429 | 56.000 | 9.945 | 0 | 0 | QP |
| 16 | | 0.882 | 32.232 | 22.287 | -13.768 | 46.000 | 9.945 | 0 | 0 | AV |

| | |
|-----------------------------------|--------------------------|
| Profile: 2150357R | Page No.: 16 |
| Engineer: Jun | |
| Site: TR1 | Time: 2021/06/02 - 23:53 |
| Limit: FCC_Part15.207_CE_AC Power | Margin: 0 |
| Probe: ENV216_101190(0.009-30MHz) | Polarity: Neutral |
| EUT: LED lamp | Power: AC 120V/60Hz |
| Note: Mode 1 | |

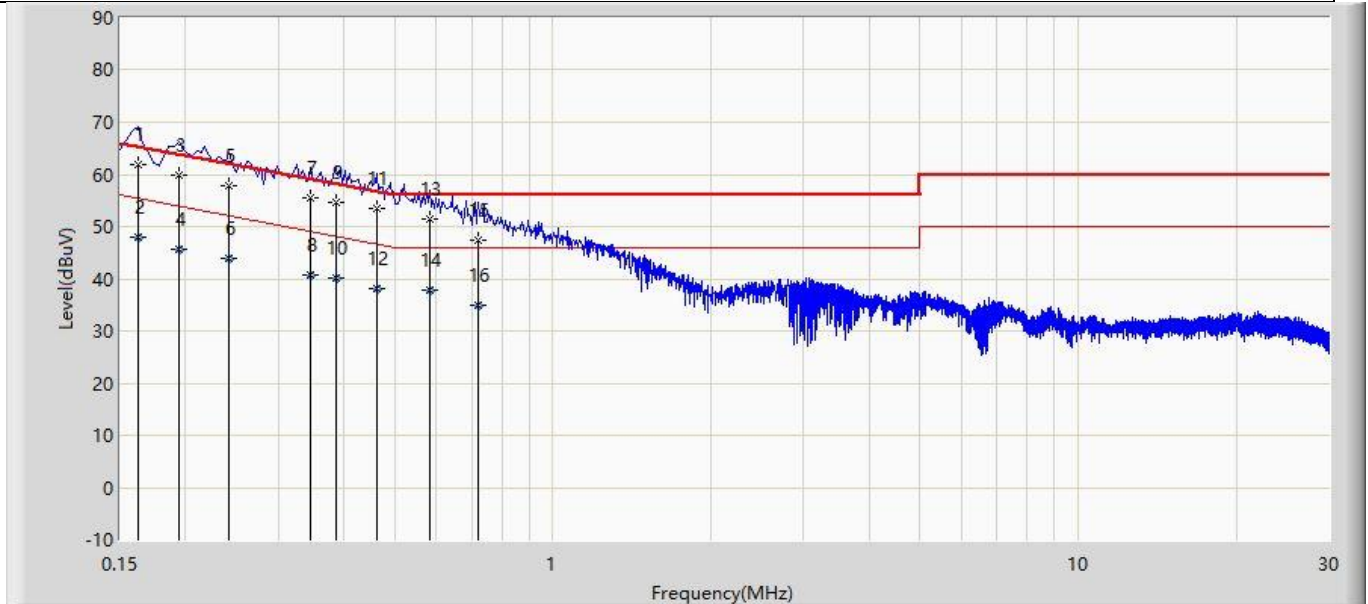

| No | Mark | Frequency (MHz) | Measure Level (dBuV) | Reading Level (dBuV) | Over Limit (dB) | Limit (dBuV) | Factor (dB) | Ant Pos (cm) | Table Pos (deg) | Type |
|----|------|-----------------|----------------------|----------------------|-----------------|--------------|-------------|--------------|-----------------|------|
| 1 | | 0.162 | 61.921 | 52.179 | -3.440 | 65.361 | 9.742 | 0 | 0 | QP |
| 2 | | 0.162 | 48.039 | 38.296 | -7.322 | 55.361 | 9.742 | 0 | 0 | AV |
| 3 | | 0.194 | 59.716 | 49.953 | -4.148 | 63.864 | 9.763 | 0 | 0 | QP |
| 4 | | 0.194 | 45.603 | 35.841 | -8.261 | 53.864 | 9.763 | 0 | 0 | AV |
| 5 | | 0.242 | 57.907 | 48.129 | -4.120 | 62.027 | 9.778 | 0 | 0 | QP |
| 6 | | 0.242 | 43.971 | 34.193 | -8.056 | 52.027 | 9.778 | 0 | 0 | AV |
| 7 | | 0.346 | 55.521 | 45.716 | -3.537 | 59.058 | 9.804 | 0 | 0 | QP |
| 8 | | 0.346 | 40.800 | 30.995 | -8.258 | 49.058 | 9.804 | 0 | 0 | AV |
| 9 | | 0.386 | 54.597 | 44.781 | -3.553 | 58.149 | 9.815 | 0 | 0 | QP |
| 10 | | 0.386 | 40.163 | 30.347 | -7.986 | 48.149 | 9.815 | 0 | 0 | AV |
| 11 | * | 0.462 | 53.349 | 43.517 | -3.307 | 56.657 | 9.832 | 0 | 0 | QP |
| 12 | | 0.462 | 37.973 | 28.141 | -8.684 | 46.657 | 9.832 | 0 | 0 | AV |
| 13 | | 0.582 | 51.519 | 41.668 | -4.481 | 56.000 | 9.851 | 0 | 0 | QP |
| 14 | | 0.582 | 37.871 | 28.020 | -8.129 | 46.000 | 9.851 | 0 | 0 | AV |
| 15 | | 0.722 | 47.293 | 37.419 | -8.707 | 56.000 | 9.874 | 0 | 0 | QP |
| 16 | | 0.722 | 35.037 | 25.163 | -10.963 | 46.000 | 9.874 | 0 | 0 | AV |

| | |
|--|----------------------|
| 4.2 Emissions in restricted frequency bands | VERDICT: PASS |
|--|----------------------|

| 4.2.1 Limit | | | |
|---------------------------------------|-----------------------|--|-----------------|
| Standard | | FCC Part 15 Subpart C Paragraph 15.209 | |
| Restricted Bands of operation for FCC | | | |
| Frequency (MHz) | Frequency (MHz) | Frequency (MHz) | Frequency (GHz) |
| 0.090 – 0.110 | 16.42 – 16.423 | 399.9 – 410 | 4.5 – 5.15 |
| 0.495 – 0.505 | 16.69475 – 16.69525 | 608 – 614 | 5.35 – 5.46 |
| 2.1735 – 2.1905 | 16.80425 – 16.80475 | 960 – 1240 | 7.25 – 7.75 |
| 4.125 – 4.128 | 25.5 – 25.67 | 1300 – 1427 | 8.025 – 8.5 |
| 4.17725 – 4.17775 | 37.5 – 38.25 | 1435 – 1626.5 | 9.0 – 9.2 |
| 4.20725 – 4.20775 | 73 – 74.6 | 1645.5 – 1646.5 | 9.3 – 9.5 |
| 6.215 – 6.218 | 74.8 – 75.2 | 1660 – 1710 | 10.6 – 12.7 |
| 6.26775 – 6.26825 | 108 – 121.94 | 1718.8 – 1722.2 | 13.25 – 13.4 |
| 6.31175 – 6.31225 | 123 – 138 | 2200 – 2300 | 14.47 – 14.5 |
| 8.291 – 8.294 | 149.9 – 150.05 | 2310 – 2390 | 15.35 – 16.2 |
| 8.362 – 8.366 | 156.52475 – 156.52525 | 2483.5 – 2500 | 17.7 – 21.4 |
| 8.37625 – 8.38675 | 156.7 – 156.9 | 2690 – 2900 | 22.01 – 23.12 |
| 8.81425 – 8.81475 | 162.0125 – 167.17 | 3260 – 3267 | 23.6 – 24.0 |
| 12.29 – 12.293 | 167.72 – 173.2 | 3332 – 3339 | 31.2 – 31.8 |
| 12.51975 – 12.52025 | 240 – 285 | 3345.8 – 3358 | 36.43 – 36.5 |
| 12.57675 – 12.57725 | 322 – 335.4 | 3600 – 4400 | |
| 13.36 – 13.41 | | | |
| Restricted Bands of operation for IC | | | |
| 0.090 - 0.110 | 13.36 - 13.41 | 960 - 1427 | 9.0 - 9.2 |
| 0.495 - 0.505 | 16.42 - 16.423 | 1435 - 1626.5 | 9.3 - 9.5 |
| 2.1735 - 2.1905 | 16.69475 - 16.69525 | 1645.5 - 1646.5 | 10.6 - 12.7 |
| 3.020 - 3.026 | 16.80425 - 16.80475 | 1660 - 1710 | 13.25 - 13.4 |
| 4.125 - 4.128 | 25.5 - 25.67 | 1718.8 - 1722.2 | 14.47 - 14.5 |
| 4.17725 - 4.17775 | 37.5 - 38.25 | 2200 - 2300 | 15.35 - 16.2 |
| 4.20725 - 4.20775 | 73 - 74.6 | 2310 - 2390 | 17.7 - 21.4 |
| 5.677 - 5.683 | 74.8 - 75.2 | 2483.5 - 2500 | 22.01 - 23.12 |
| 6.215 - 6.218 | 108 - 138 | 2655 - 2900 | 23.6 - 24.0 |
| 6.26775 - 6.26825 | 149.9 - 150.05 | 3260 - 3267 | 31.2 - 31.8 |
| 6.31175 - 6.31225 | 156.52475 - 156.52525 | 3332 - 3339 | 36.43 - 36.5 |
| 8.291 - 8.294 | 156.7 - 156.9 | 3345.8 - 3358 | Above 38.6 |
| 8.362 - 8.366 | 162.0125 - 167.17 | 3500 - 4400 | |
| 8.37625 - 8.38675 | 167.72 - 173.2 | 4500 - 5150 | |
| 8.81425 - 8.81475 | 240 - 285 | 5350 - 5460 | |
| 12.29 - 12.293 | 322 - 335.4 | 7250 - 7750 | |
| 12.51975 - 12.52025 | 399.9 - 410 | 8025 - 8500 | |
| 12.57675 - 12.57725 | 608 - 614 | -- | |

| Restricted Band Emissions Limit | | | |
|---------------------------------|-----------------------------|-------------------------------|--------------------------|
| Frequency (MHz) | Field strength (μ V/m) | Field strength (dB μ V/m) | Measurement distance (m) |
| 0.009 - 0.49 | 2400/F(kHz) | 48.5 – 13.8 | 300 _(Note 1) |
| 0.49 - 1.705 | 24000/F(kHz) | 33.8 - 23 | 30 _(Note 1) |
| 1.705 - 30 | 30 | 29.5 | 30 _(Note 1) |
| 30 -88 | 100 | 40 | 3 _(Note 2) |
| 88-216 | 150 | 43.5 | 3 _(Note 2) |
| 216 - 960 | 200 | 46 | 3 _(Note 2) |
| Above 960 | 500 | 54 | 3 _(Note 2) |

Note 1: At frequencies below 30 MHz, measurements may be performed at a distance closer than that specified in the regulations; however, an attempt should be made to avoid making measurements in the near field. Pending the development of an appropriate measurement procedure for measurements performed below 30 MHz, when performing measurements at a closer distance than specified, the results shall be extrapolated to the specified distance by either making measurements at a minimum of two distances on at least one radial to determine the proper extrapolation factor or by using the square of an inverse linear distance extrapolation factor (40 dB/decade).

Note 2: At frequencies at or above 30 MHz, measurements may be performed at a distance other than what is specified provided: measurements are not made in the near field except where it can be shown that near field measurements are appropriate due to the characteristics of the device; and it can be demonstrated that the signal levels needed to be measured at the distance employed can be detected by the measurement equipment.

Measurements shall not be performed at a distance greater than 30 meters unless it can be further demonstrated that measurements at a distance of 30 meters or less are impractical. When performing measurements at a distance other than that specified, the results shall be extrapolated to the specified distance using an extrapolation factor of 20 dB/decade (inverse linear-distance for field strength measurements; inverse-linear-distance-squared for power density measurements).

4.2.2 Test Setup

30MHz-1GHz Test Setup:

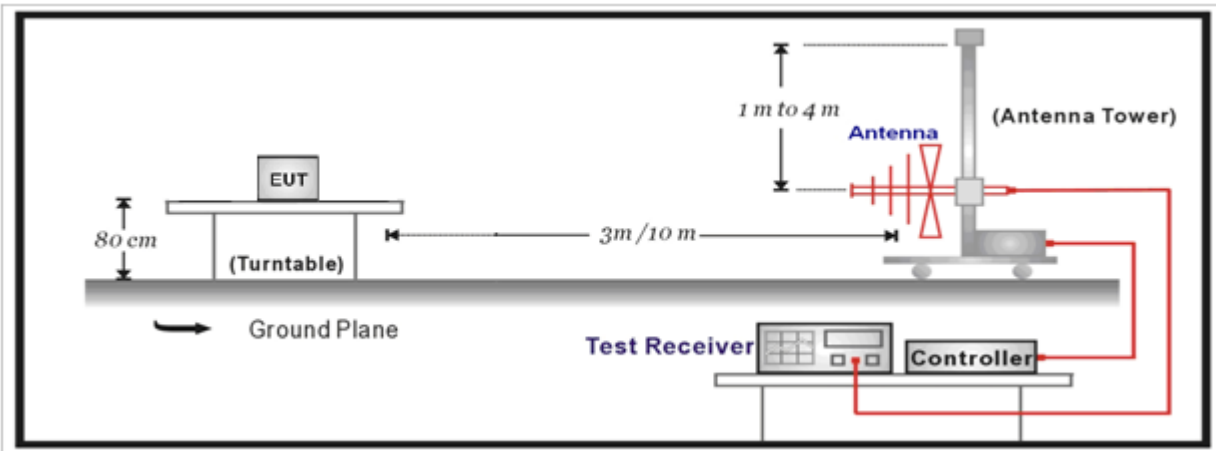

Above 1GHz Test Setup:

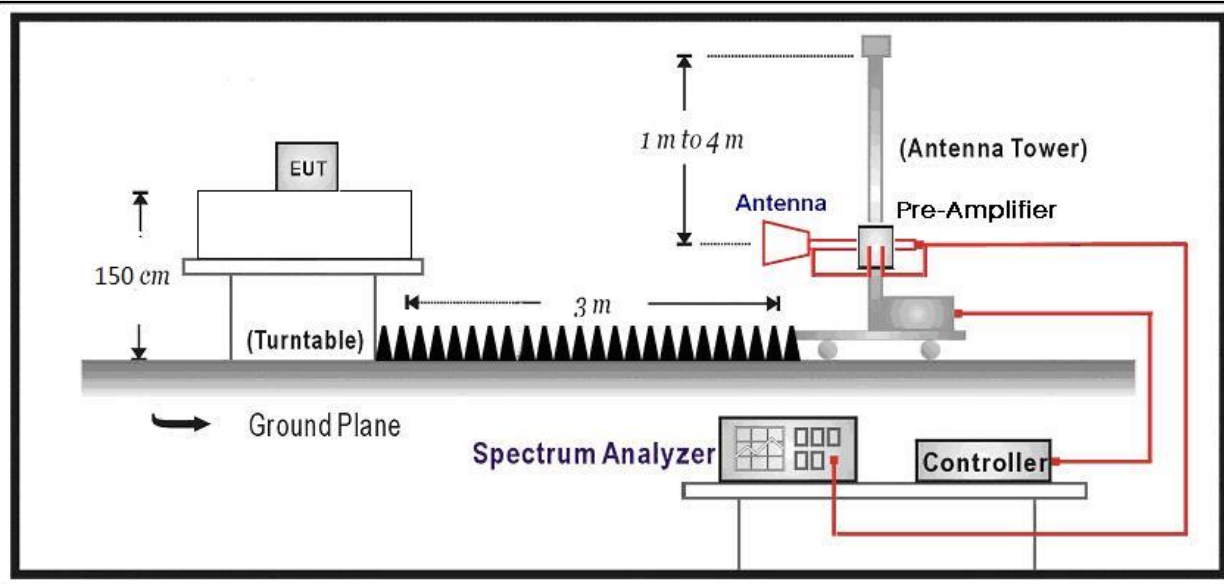

4.2.3 Test Procedure

| References Rule | Chapter | Description |
|---|-----------|--|
| <input checked="" type="checkbox"/> ANSI C63.10 | 11.12 | Emissions in restricted frequency bands |
| <input checked="" type="checkbox"/> ANSI C63.10 | 11.12.1 | Radiated emission measurements |
| <input checked="" type="checkbox"/> ANSI C63.10 | 11.12.2.7 | Radiated spurious emission test |
| <input checked="" type="checkbox"/> ANSI C63.10 | 6.4 | Radiated emissions from unlicensed wireless devices below 30 MHz |
| <input checked="" type="checkbox"/> ANSI C63.10 | 6.5 | Radiated emissions from unlicensed wireless devices in the frequency range of 30 MHz to 1000 MHz |
| <input checked="" type="checkbox"/> ANSI C63.10 | 6.6 | Radiated emissions from unlicensed wireless devices above 1 GHz |

4.2.4 Test Data

| | |
|---|--------------------------|
| Profile: 2150357R | Page No.: 71 |
| Engineer: Tongben | |
| Site: AC5 | Time: 2021/06/02 - 01:22 |
| Limit: FCC_Part15.209_RE(3m) | Margin: 0 |
| Probe: Horn_3117_00167055(1-18GHz) | Polarity: Horizontal |
| EUT: LED lamp | Power: AC 120V/60Hz |
| Note: Mode 1: Transmit at 2405MHz by Zigbee | |

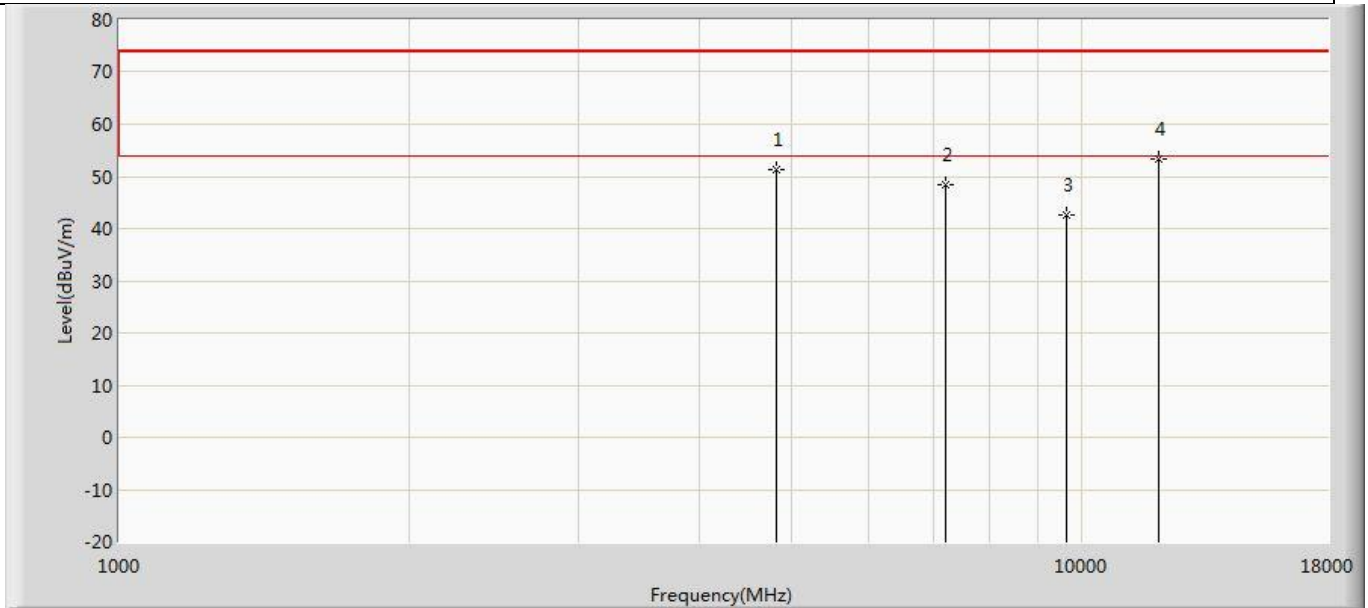

| No | Mark | Frequency (MHz) | Measure Level (dBuV/m) | Reading Level (dBuV) | Over Limit (dB) | Limit (dBuV/m) | Probe (dB/m) | Cable (dB) | Amp (dB) | Type |
|----|------|-----------------|------------------------|----------------------|-----------------|----------------|--------------|------------|----------|------|
| 1 | | 4810.000 | 51.252 | 56.255 | -22.748 | 74.000 | 34.066 | 6.542 | 45.612 | PK |
| 2 | | 7215.000 | 48.521 | 49.901 | -25.479 | 74.000 | 36.214 | 7.782 | 45.376 | PK |
| 3 | | 9620.000 | 42.630 | 41.776 | -31.370 | 74.000 | 36.872 | 9.794 | 45.812 | PK |
| 4 | * | 12025.000 | 53.223 | 48.364 | -20.777 | 74.000 | 39.685 | 11.639 | 46.465 | PK |

| | |
|--|--------------------------|
| Profile: 2150357R | Page No.: 72 |
| Engineer: Tongben | |
| Site: AC5 | Time: 2021/06/02 - 01:23 |
| Limit: FCC_Part15.209_RE(3m) | Margin: 0 |
| Probe: Horn_3117_00167055(1-18GHz) | Polarity: Vertical |
| EUT: LED lamp | Power: AC 120V/60Hz |
| Note: Mode 1:Transmit at 2405MHz by Zigbee | |

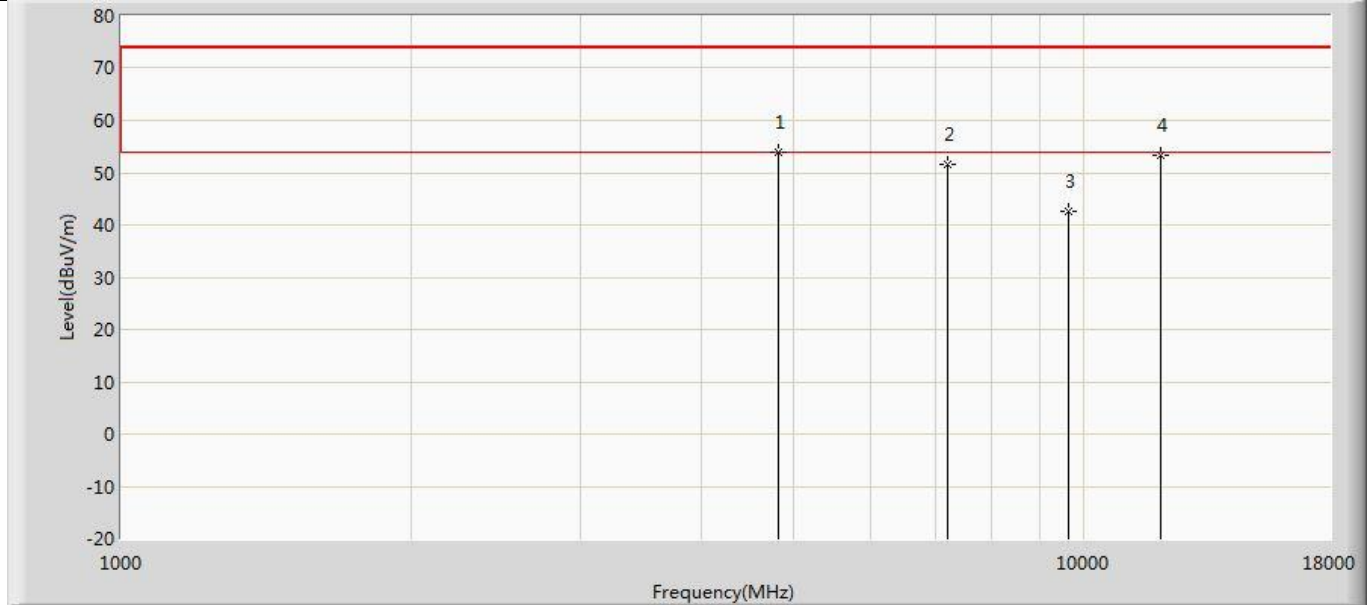

| No | Mark | Frequency (MHz) | Measure Level (dBuV/m) | Reading Level (dBuV) | Over Limit (dB) | Limit (dBuV/m) | Probe (dB/m) | Cable (dB) | Amp (dB) | Type |
|----|------|-----------------|------------------------|----------------------|-----------------|----------------|--------------|------------|----------|------|
| 1 | * | 4810.000 | 53.936 | 58.939 | -20.064 | 74.000 | 34.066 | 6.542 | 45.612 | PK |
| 2 | | 7215.000 | 51.464 | 52.844 | -22.536 | 74.000 | 36.214 | 7.782 | 45.376 | PK |
| 3 | | 9620.000 | 42.627 | 41.773 | -31.373 | 74.000 | 36.872 | 9.794 | 45.812 | PK |
| 4 | | 12025.000 | 53.219 | 48.360 | -20.781 | 74.000 | 39.685 | 11.639 | 46.465 | PK |

| | |
|--|--------------------------|
| Profile: 2150357R | Page No.: 73 |
| Engineer: Tongben | |
| Site: AC5 | Time: 2021/06/02 - 01:23 |
| Limit: FCC_Part15.209_RE(3m) | Margin: 0 |
| Probe: Horn_3117_00167055(1-18GHz) | Polarity: Horizontal |
| EUT: LED lamp | Power: AC 120V/60Hz |
| Note: Mode 1:Transmit at 2440MHz by Zigbee | |

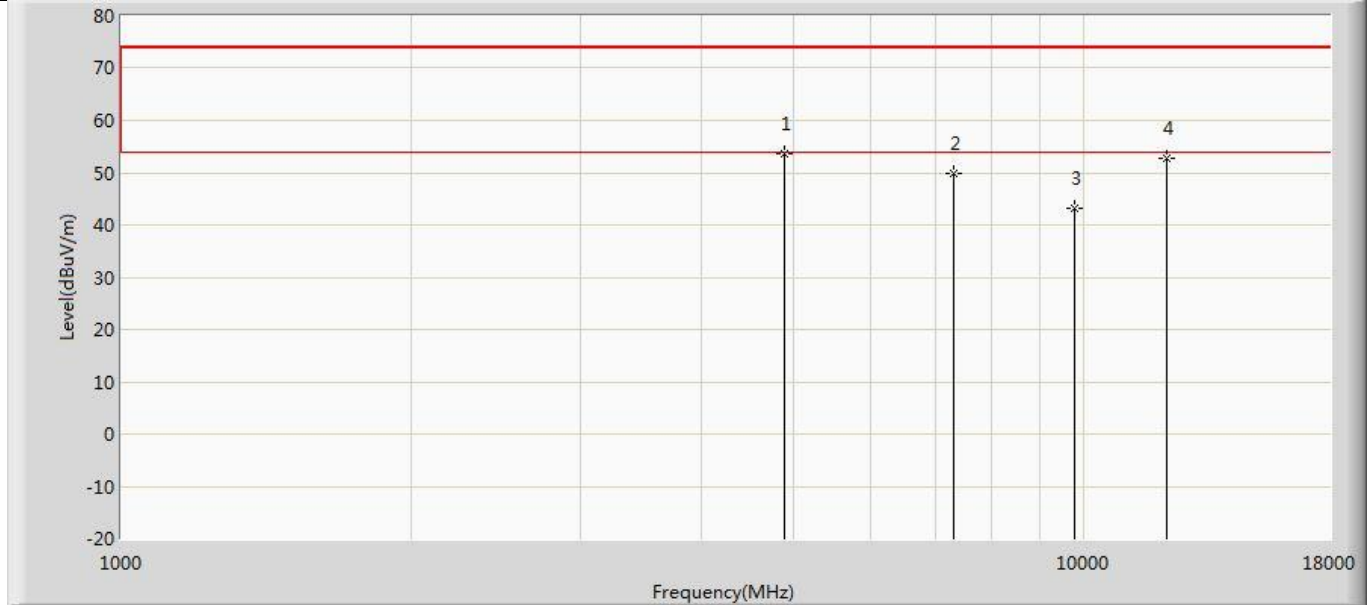

| No | Mark | Frequency (MHz) | Measure Level (dBuV/m) | Reading Level (dBuV) | Over Limit (dB) | Limit (dBuV/m) | Probe (dB/m) | Cable (dB) | Amp (dB) | Type |
|----|------|-----------------|------------------------|----------------------|-----------------|----------------|--------------|------------|----------|------|
| 1 | * | 4880.000 | 53.650 | 58.613 | -20.350 | 74.000 | 33.968 | 6.693 | 45.624 | PK |
| 2 | | 7320.000 | 49.878 | 51.184 | -24.122 | 74.000 | 36.172 | 7.970 | 45.447 | PK |
| 3 | | 9760.000 | 43.226 | 42.224 | -30.774 | 74.000 | 36.956 | 9.687 | 45.641 | PK |
| 4 | | 12200.000 | 52.694 | 48.754 | -21.306 | 74.000 | 39.580 | 10.942 | 46.582 | PK |

| | |
|--|--------------------------|
| Profile: 2150357R | Page No.: 74 |
| Engineer: Tongben | |
| Site: AC5 | Time: 2021/06/02 - 01:23 |
| Limit: FCC_Part15.209_RE(3m) | Margin: 0 |
| Probe: Horn_3117_00167055(1-18GHz) | Polarity: Vertical |
| EUT: LED lamp | Power: AC 120V/60Hz |
| Note: Mode 1:Transmit at 2440MHz by Zigbee | |

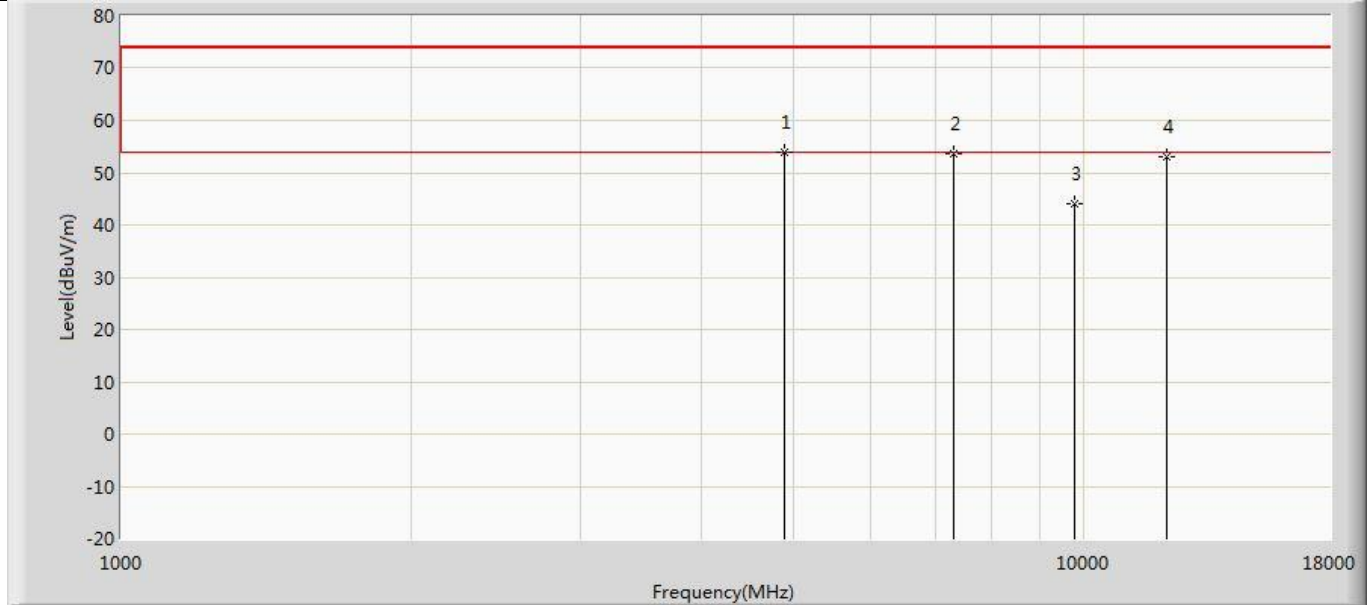

| No | Mark | Frequency (MHz) | Measure Level (dBuV/m) | Reading Level (dBuV) | Over Limit (dB) | Limit (dBuV/m) | Probe (dB/m) | Cable (dB) | Amp (dB) | Type |
|----|------|-----------------|------------------------|----------------------|-----------------|----------------|--------------|------------|----------|------|
| 1 | * | 4880.000 | 53.803 | 58.766 | -20.197 | 74.000 | 33.968 | 6.693 | 45.624 | PK |
| 2 | | 7320.000 | 53.515 | 54.821 | -20.485 | 74.000 | 36.172 | 7.970 | 45.447 | PK |
| 3 | | 9760.000 | 44.134 | 43.132 | -29.866 | 74.000 | 36.956 | 9.687 | 45.641 | PK |
| 4 | | 12200.000 | 53.048 | 49.108 | -20.952 | 74.000 | 39.580 | 10.942 | 46.582 | PK |

| | |
|--|--------------------------|
| Profile: 2150357R | Page No.: 75 |
| Engineer: Tongben | |
| Site: AC5 | Time: 2021/06/02 - 01:23 |
| Limit: FCC_Part15.209_RE(3m) | Margin: 0 |
| Probe: Horn_3117_00167055(1-18GHz) | Polarity: Horizontal |
| EUT: LED lamp | Power: AC 120V/60Hz |
| Note: Mode 1:Transmit at 2480MHz by Zigbee | |

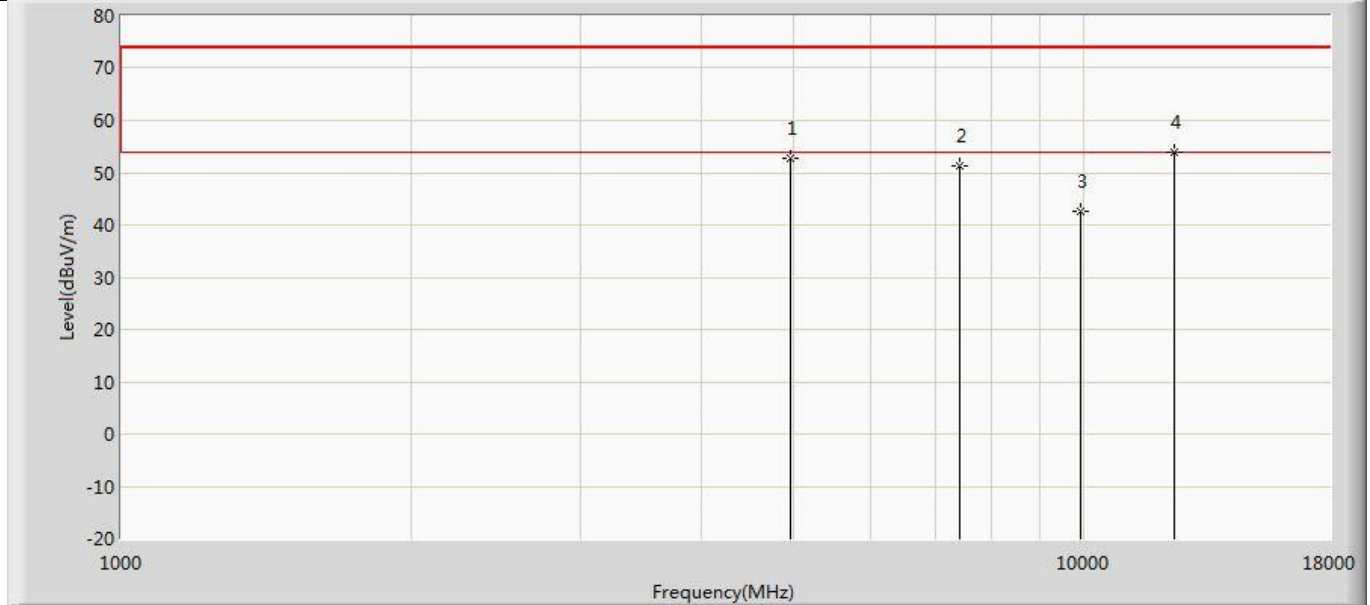

| No | Mark | Frequency (MHz) | Measure Level (dBuV/m) | Reading Level (dBuV) | Over Limit (dB) | Limit (dBuV/m) | Probe (dB/m) | Cable (dB) | Amp (dB) | Type |
|----|------|-----------------|------------------------|----------------------|-----------------|----------------|--------------|------------|----------|------|
| 1 | | 4960.000 | 52.637 | 57.610 | -21.363 | 74.000 | 33.856 | 6.670 | 45.500 | PK |
| 2 | | 7440.000 | 51.176 | 52.823 | -22.824 | 74.000 | 36.124 | 7.864 | 45.635 | PK |
| 3 | | 9920.000 | 42.716 | 41.601 | -31.284 | 74.000 | 37.052 | 9.663 | 45.600 | PK |
| 4 | * | 12400.000 | 53.776 | 48.975 | -20.224 | 74.000 | 39.460 | 11.506 | 46.165 | PK |

| | |
|--|--------------------------|
| Profile: 2150357R | Page No.: 76 |
| Engineer: Tongben | |
| Site: AC5 | Time: 2021/06/02 - 01:23 |
| Limit: FCC_Part15.209_RE(3m) | Margin: 0 |
| Probe: Horn_3117_00167055(1-18GHz) | Polarity: Vertical |
| EUT: LED lamp | Power: AC 120V/60Hz |
| Note: Mode 1:Transmit at 2480MHz by Zigbee | |

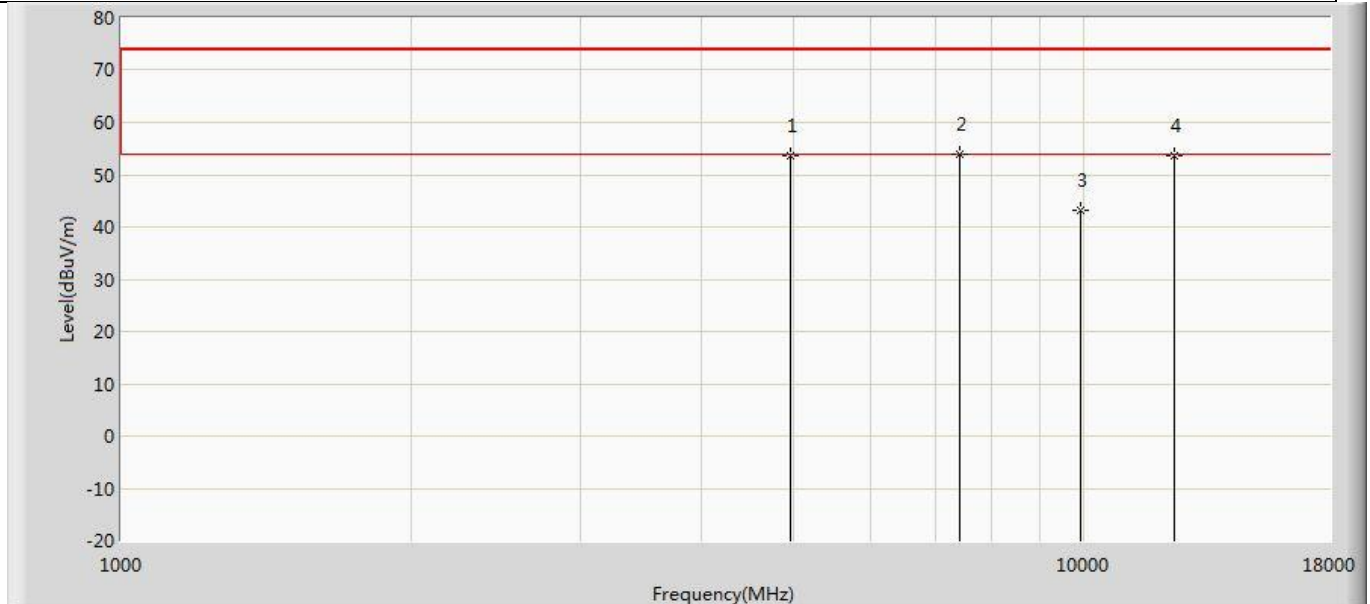

| No | Mark | Frequency (MHz) | Measure Level (dBuV/m) | Reading Level (dBuV) | Over Limit (dB) | Limit (dBuV/m) | Probe (dB/m) | Cable (dB) | Amp (dB) | Type |
|----|------|-----------------|------------------------|----------------------|-----------------|----------------|--------------|------------|----------|------|
| 1 | | 4960.000 | 53.491 | 58.464 | -20.509 | 74.000 | 33.856 | 6.670 | 45.500 | PK |
| 2 | * | 7440.000 | 53.911 | 55.558 | -20.089 | 74.000 | 36.124 | 7.864 | 45.635 | PK |
| 3 | | 9920.000 | 43.290 | 42.175 | -30.710 | 74.000 | 37.052 | 9.663 | 45.600 | PK |
| 4 | | 12400.000 | 53.563 | 48.762 | -20.437 | 74.000 | 39.460 | 11.506 | 46.165 | PK |

Note:

1. " * ", means this data is the worst emission level.
2. Measurement Level = Reading Level + Factor(Probe+Cable-Amp).
3. The test frequency range, 9kHz~30MHz and Above 18GHz worst case are at least 6dB below the limits, therefore no data appear in the report.
4. This limit applies for using average detector, if the test result of peak is lower than average limit, then average measurement needn't be performed.

The worst case of Radiated Emission below 1GHz:

| | |
|------------------------------|--------------------------|
| Profile: 2150357R | Page No.: 5 |
| Engineer: Wangyingfei | |
| Site: AC3 | Time: 2021/06/02 - 02:08 |
| Limit: FCC_Part15.209_RE(3m) | Margin: 0 |
| Probe: AC3_3m (30-1000MHz) | Polarity: Horizontal |
| EUT: LED lamp | Power: AC 120V/60Hz |
| Note: Mode 1 | |

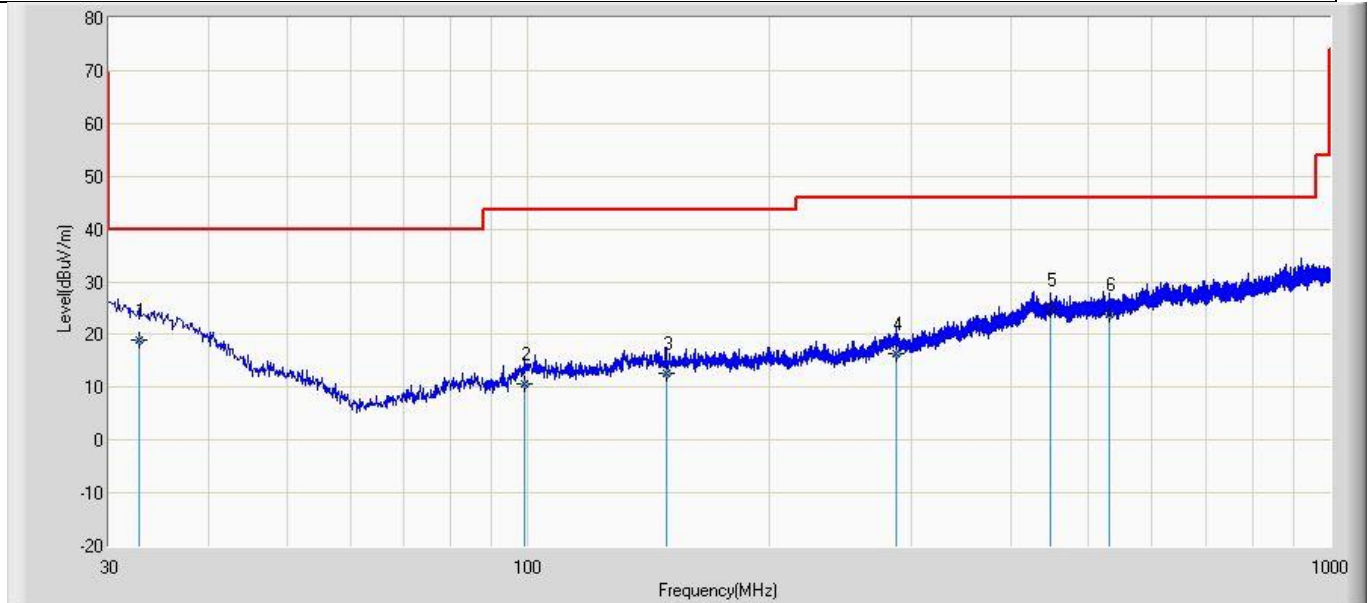

| No | Mark | Frequency (MHz) | Measure Level (dBuV/m) | Reading Level (dBuV) | Over Limit (dB) | Limit (dBuV/m) | Factor (dB) | Ant Pos (cm) | Table Pos (deg) | Type |
|----|------|-----------------|------------------------|----------------------|-----------------|----------------|-------------|--------------|-----------------|------|
| 1 | * | 32.667 | 18.956 | -7.414 | -21.044 | 40.000 | 26.370 | 200 | 275 | QP |
| 2 | | 99.113 | 10.570 | -5.904 | -32.930 | 43.500 | 16.474 | 200 | 183 | QP |
| 3 | | 148.583 | 12.578 | -4.605 | -30.922 | 43.500 | 17.183 | 200 | 335 | QP |
| 4 | | 288.020 | 16.272 | -4.428 | -29.728 | 46.000 | 20.700 | 100 | 139 | QP |
| 5 | | 447.464 | 24.806 | -1.891 | -21.194 | 46.000 | 26.697 | 200 | 82 | QP |
| 6 | | 531.005 | 23.905 | -2.645 | -22.095 | 46.000 | 26.550 | 100 | 176 | QP |

| | |
|------------------------------|--------------------------|
| Profile: 2150357R | Page No.: 6 |
| Engineer: Wangyingfei | |
| Site: AC3 | Time: 2021/06/02 - 02:10 |
| Limit: FCC_Part15.209_RE(3m) | Margin: 0 |
| Probe: AC3_3m (30-1000MHz) | Polarity: Vertical |
| EUT: LED lamp | Power: AC 120V/60Hz |
| Note: Mode 1 | |

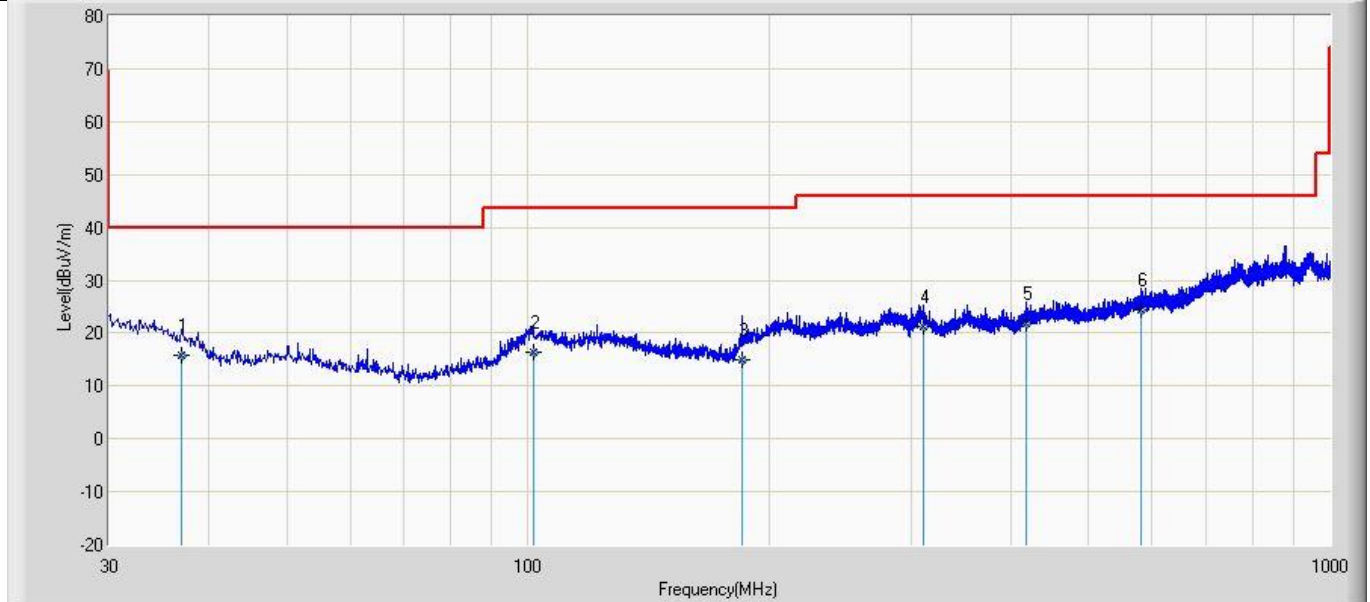

| No | Mark | Frequency (MHz) | Measure Level (dBuV/m) | Reading Level (dBuV) | Over Limit (dB) | Limit (dBuV/m) | Factor (dB) | Ant Pos (cm) | Table Pos (deg) | Type |
|----|------|-----------------|------------------------|----------------------|-----------------|----------------|-------------|--------------|-----------------|------|
| 1 | | 36.911 | 15.824 | -5.605 | -24.176 | 40.000 | 21.429 | 200 | 143 | QP |
| 2 | | 101.659 | 16.409 | -5.591 | -27.091 | 43.500 | 21.999 | 100 | 228 | QP |
| 3 | | 184.958 | 14.934 | -5.526 | -28.566 | 43.500 | 20.460 | 100 | 281 | QP |
| 4 | | 311.300 | 21.201 | -3.901 | -24.799 | 46.000 | 25.102 | 200 | 209 | QP |
| 5 | | 418.728 | 21.942 | -3.257 | -24.058 | 46.000 | 25.199 | 200 | 104 | QP |
| 6 | * | 581.687 | 24.297 | -2.449 | -21.703 | 46.000 | 26.746 | 100 | 321 | QP |

| | |
|---|----------------------|
| 4.3 Emissions in non-restricted frequency band | VERDICT: PASS |
|---|----------------------|

| 4.3.1 Limit | |
|--|---|
| Standard | FCC Part 15 Subpart C Paragraph 15.247(d) |
| RF Output power (Detection methods) | Limit(dB) |
| RF Output power(Average detector) | 30dBc(Note1) |
| RF Output power(PK detector) | 20dBc(Note2) |
| <p>Note 1: If maximum conducted (average) output power was used to demonstrate compliance as described in 9.2, then the peak power in any 100 kHz bandwidth outside of the authorized frequency band shall be attenuated by at least 30 dB relative to the maximum in-band peak PSD level in 100 kHz (i.e., 30 dBc).</p> <p>Note 2: If the maximum peak conducted output power procedure was used, then the peak output power measured in any 100 kHz bandwidth outside of the authorized frequency band shall be attenuated by at least 20 dB relative to the maximum in-band peak PSD level in 100 kHz (i.e., 20 dBc).</p> | |

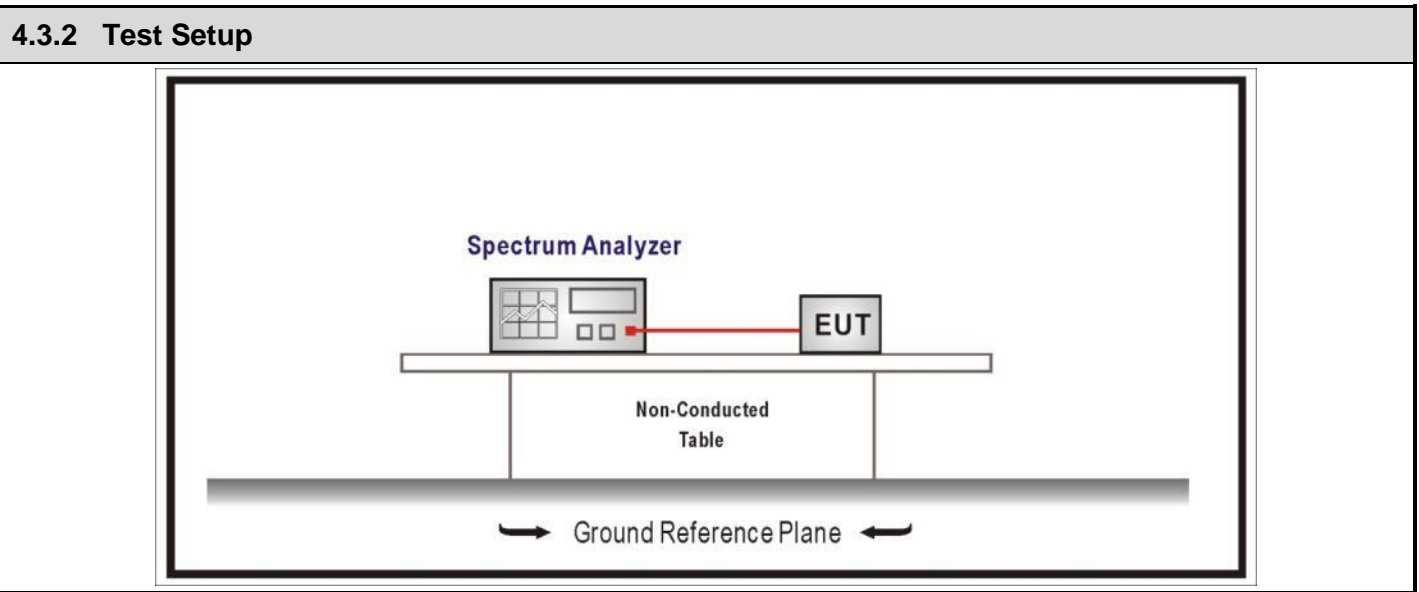

| 4.3.3 Test Procedure | | | |
|-------------------------------------|-------------|-------------|---|
| References Rule | Chapter | Description | |
| <input checked="" type="checkbox"/> | ANSI C63.10 | 11.11 | Emissions in non-restricted frequency bands |
| <input checked="" type="checkbox"/> | ANSI C63.10 | 11.11.1 | General |
| <input checked="" type="checkbox"/> | ANSI C63.10 | 11.11.2 | Reference level measurement |
| <input checked="" type="checkbox"/> | ANSI C63.10 | 11.11.3 | Emission level measurement |

4.3.4 Test Data

Mode1/CH11/2405MHz

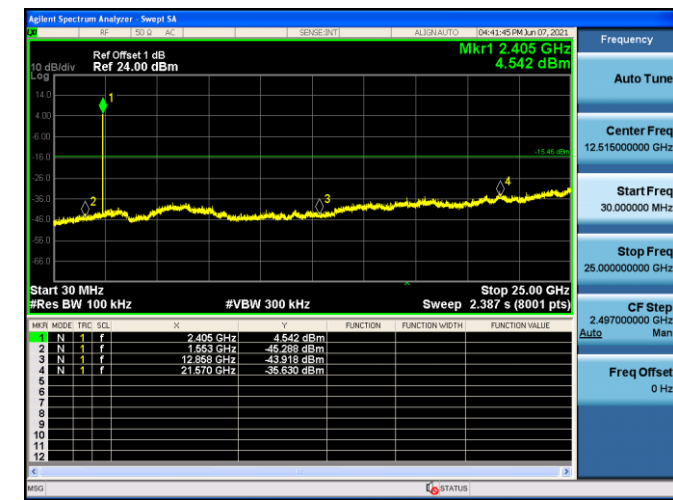

Mode1/CH26/2480MHz



| | |
|-----------------------|----------------------|
| 4.4 Duty cycle | VERDICT: PASS |
|-----------------------|----------------------|

| |
|--------------------|
| 4.4.1 Limit |
| N/A |

| |
|-------------------------|
| 4.4.2 Test Setup |
|-------------------------|

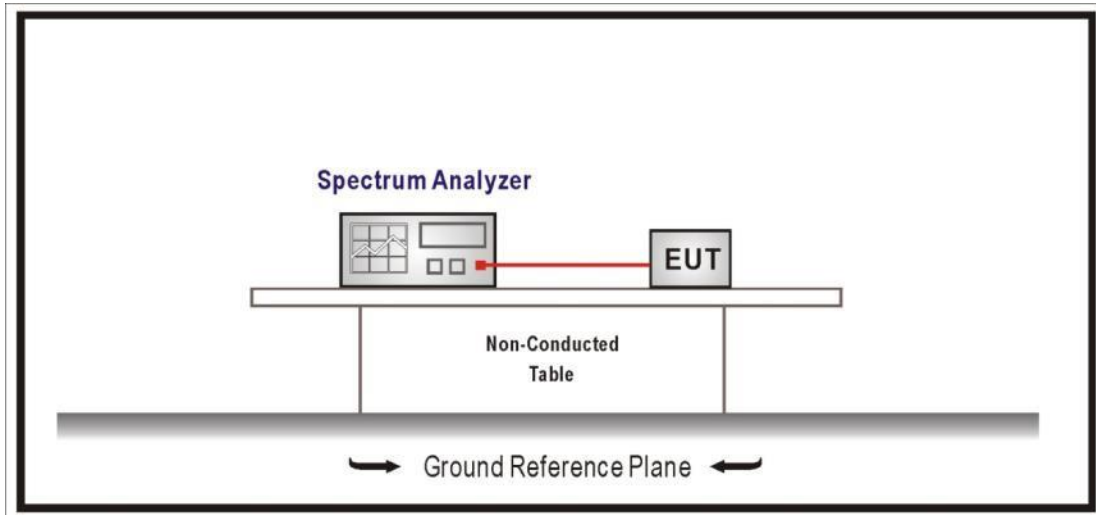

| |
|-----------------------------|
| 4.4.3 Test Procedure |
|-----------------------------|

| | References Rule | Chapter | Description |
|-------------------------------------|-----------------|---------|--|
| <input checked="" type="checkbox"/> | ANSI C63.10 | 11.6 | Duty cycle (D), transmission duration (T), and maximum power control level |

4.4.4 Test Data

| Test Mode | Tx On (us) | Tx Off (us) | VBW (kHz) | Tx On + Tx Off (us) | Duty Cycle (%) |
|-----------|------------|-------------|-----------|---------------------|----------------|
| Mode 1 | -- | -- | -- | -- | 100 |

Note 1: T means the minimum transmission duration over which the transmitter is on and is transmitting at its maximum power control level for the tested mode of operation.

Note 2: According to KDB 558074, when test for Radiated Emission Band Edge and Radiated Emission, for average detector set: $VBW \geq 1/T$ will be used.

Mode 1 CH11 2405 MHz



| | |
|--|----------------------|
| 4.5 Radiated Emission Band Edge | VERDICT: PASS |
|--|----------------------|

4.5.1 Limit

| Standard | | FCC Part 15 Subpart C Paragraph 15.247(d) ,15.209 | | |
|-----------------------|----------|---|-----------|--------------|
| Frequency bands (MHz) | Detector | Limit (dB μ V/m) | RBW (MHz) | Distance (m) |
| 2310-2390 | PK | 74 | 1 | 3 |
| 2483.5-2500 | AV | 54 | 1 | 3 |

Note: The field strength of emissions appearing within these frequency bands shall not exceed the limits.

4.5.2 Test Setup

Above 1GHz Test Setup:

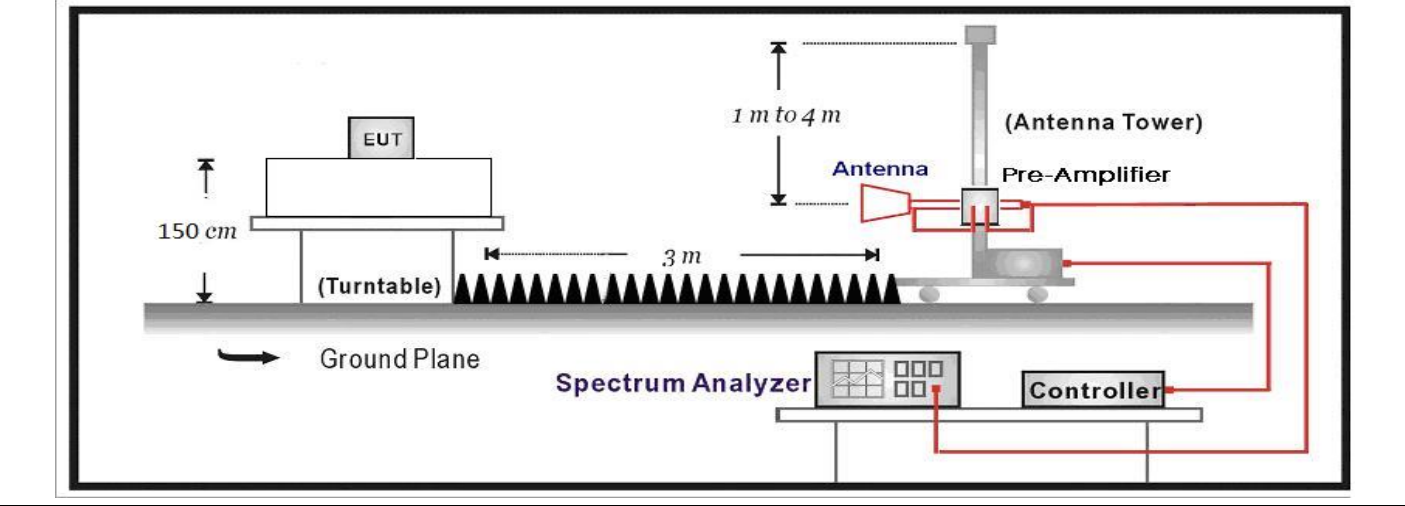

4.5.3 Test Procedure

| | References Rule | Chapter | Description |
|-------------------------------------|---|-----------|--|
| <input checked="" type="checkbox"/> | ANSI C63.10 | 6.10 | Band-edge testing |
| | <input checked="" type="checkbox"/> ANSI C63.10 | 6.10.5 | Restricted-band band-edge measurements |
| | <input type="checkbox"/> ANSI C63.10 | 6.10.6 | Marker-delta method |
| <input checked="" type="checkbox"/> | ANSI C63.10 | 11.12 | Emissions in restricted frequency bands |
| | <input checked="" type="checkbox"/> ANSI C63.10 | 11.12.1 | Radiated emission measurements |
| | <input checked="" type="checkbox"/> ANSI C63.10 | 11.12.2.7 | Radiated spurious emission test |
| <input type="checkbox"/> | ANSI C63.10 | 6.4 | Radiated emissions from unlicensed wireless devices below 30 MHz |
| <input type="checkbox"/> | ANSI C63.10 | 6.5 | Radiated emissions from unlicensed wireless devices in the frequency range of 30 MHz to 1000 MHz |
| <input checked="" type="checkbox"/> | ANSI C63.10 | 6.6 | Radiated emissions from unlicensed wireless devices above 1 GHz |

4.5.4 Test Data

| | |
|--|--------------------------|
| Profile: 2150357R | Page No.: 59 |
| Engineer: Tongben | |
| Site: AC5 | Time: 2021/06/02 - 00:28 |
| Limit: FCC_Part15.209_RE(3m) | Margin: 0 |
| Probe: Horn_3117_00167055(1-18GHz) | Polarity: Horizontal |
| EUT: LED lamp | Power: AC 120V/60Hz |
| Note: Mode 1:Transmit at 2405MHz by Zigbee | |

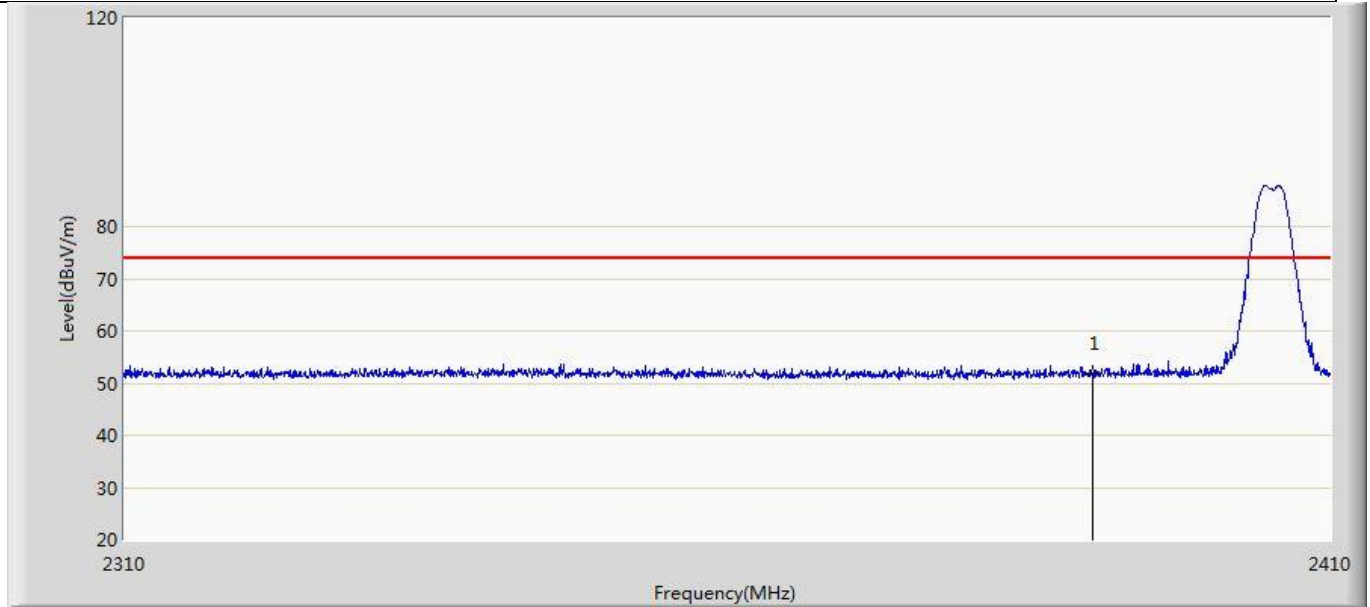

| No | Mark | Frequency (MHz) | Measure Level (dBuV/m) | Reading Level (dBuV) | Over Limit (dB) | Limit (dBuV/m) | Factor (dB) | Type |
|----|------|-----------------|------------------------|----------------------|-----------------|----------------|-------------|------|
| 1 | * | 2390.000 | 51.751 | 15.395 | -22.249 | 74.000 | 36.357 | PK |

| | |
|--|--------------------------|
| Profile: 2150357R | Page No.: 60 |
| Engineer: Tongben | |
| Site: AC5 | Time: 2021/06/02 - 00:32 |
| Limit: FCC_Part15.209_RE(3m) | Margin: 0 |
| Probe: Horn_3117_00167055(1-18GHz) | Polarity: Horizontal |
| EUT: LED lamp | Power: AC 120V/60Hz |
| Note: Mode 1:Transmit at 2405MHz by Zigbee | |

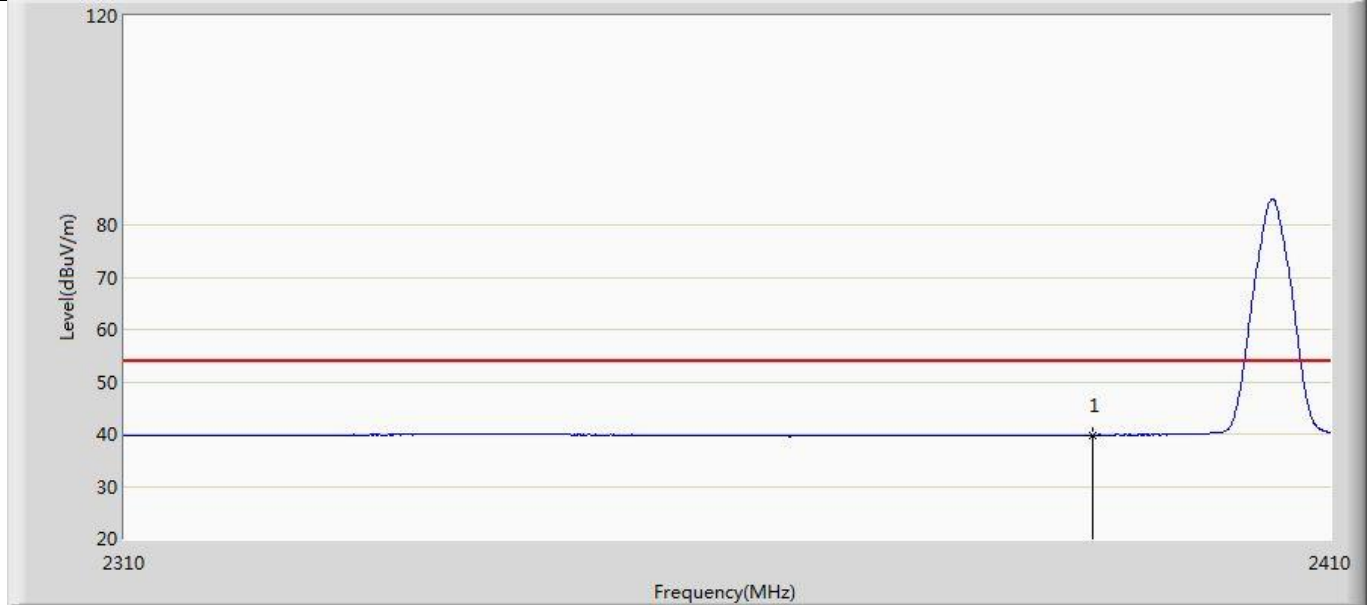

| No | Mark | Frequency (MHz) | Measure Level (dBuV/m) | Reading Level (dBuV) | Over Limit (dB) | Limit (dBuV/m) | Factor (dB) | Type |
|----|------|-----------------|------------------------|----------------------|-----------------|----------------|-------------|------|
| 1 | * | 2390.000 | 39.819 | 3.463 | -14.181 | 54.000 | 36.357 | AV |

| | |
|--|--------------------------|
| Profile: 2150357R | Page No.: 61 |
| Engineer: Tongben | |
| Site: AC5 | Time: 2021/06/02 - 00:36 |
| Limit: FCC_Part15.209_RE(3m) | Margin: 0 |
| Probe: Horn_3117_00167055(1-18GHz) | Polarity: Vertical |
| EUT: LED lamp | Power: AC 120V/60Hz |
| Note: Mode 1:Transmit at 2405MHz by Zigbee | |

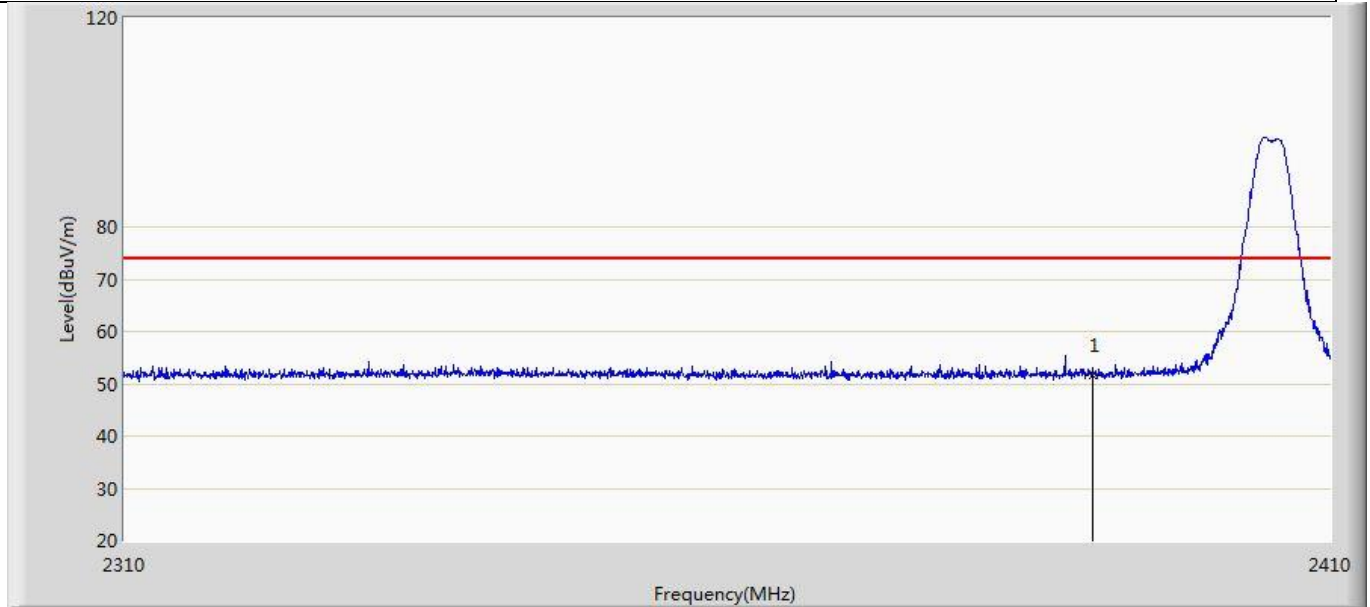

| No | Mark | Frequency (MHz) | Measure Level (dBuV/m) | Reading Level (dBuV) | Over Limit (dB) | Limit (dBuV/m) | Factor (dB) | Type |
|----|------|-----------------|------------------------|----------------------|-----------------|----------------|-------------|------|
| 1 | * | 2390.000 | 51.482 | 15.126 | -22.518 | 74.000 | 36.357 | PK |

| | |
|--|--------------------------|
| Profile: 2150357R | Page No.: 62 |
| Engineer: Tongben | |
| Site: AC5 | Time: 2021/06/02 - 00:38 |
| Limit: FCC_Part15.209_RE(3m) | Margin: 0 |
| Probe: Horn_3117_00167055(1-18GHz) | Polarity: Vertical |
| EUT: LED lamp | Power: AC 120V/60Hz |
| Note: Mode 1:Transmit at 2405MHz by Zigbee | |

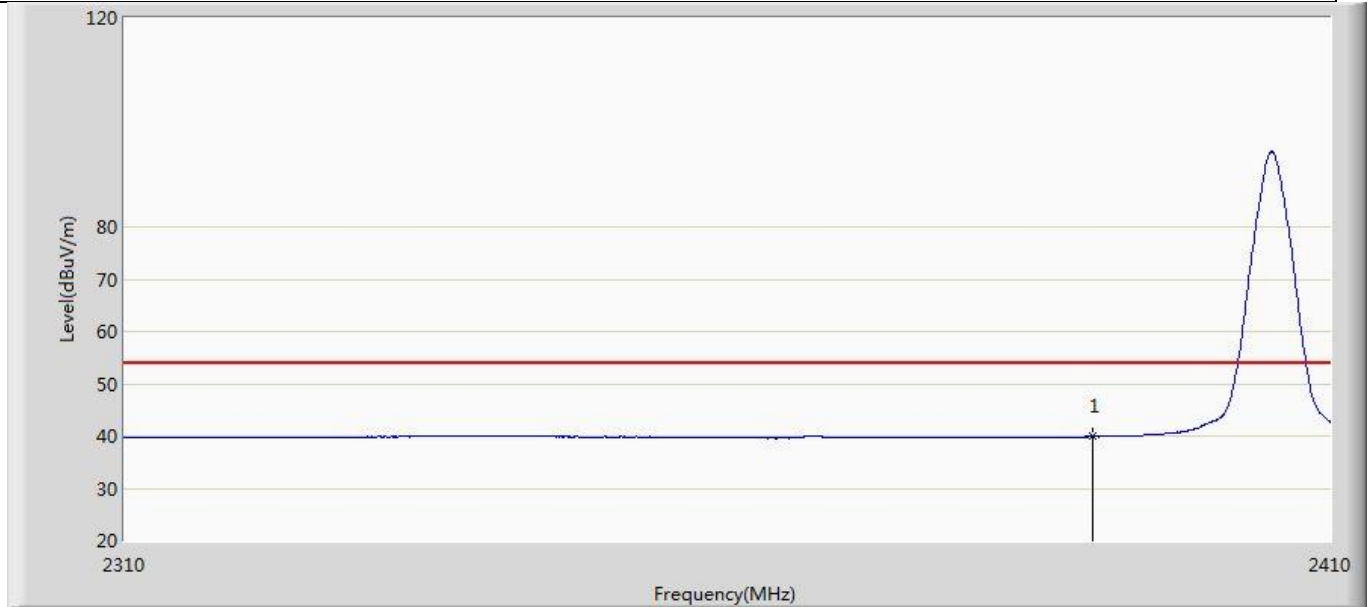

| No | Mark | Frequency (MHz) | Measure Level (dBuV/m) | Reading Level (dBuV) | Over Limit (dB) | Limit (dBuV/m) | Factor (dB) | Type |
|----|------|-----------------|------------------------|----------------------|-----------------|----------------|-------------|------|
| 1 | * | 2390.000 | 39.928 | 3.572 | -14.072 | 54.000 | 36.357 | AV |

| | |
|--|--------------------------|
| Profile: 2150357R | Page No.: 67 |
| Engineer: Tongben | |
| Site: AC5 | Time: 2021/06/02 - 00:53 |
| Limit: FCC_Part15.209_RE(3m) | Margin: 0 |
| Probe: Horn_3117_00167055(1-18GHz) | Polarity: Horizontal |
| EUT: LED lamp | Power: AC 120V/60Hz |
| Note: Mode 1:Transmit at 2480MHz by Zigbee | |

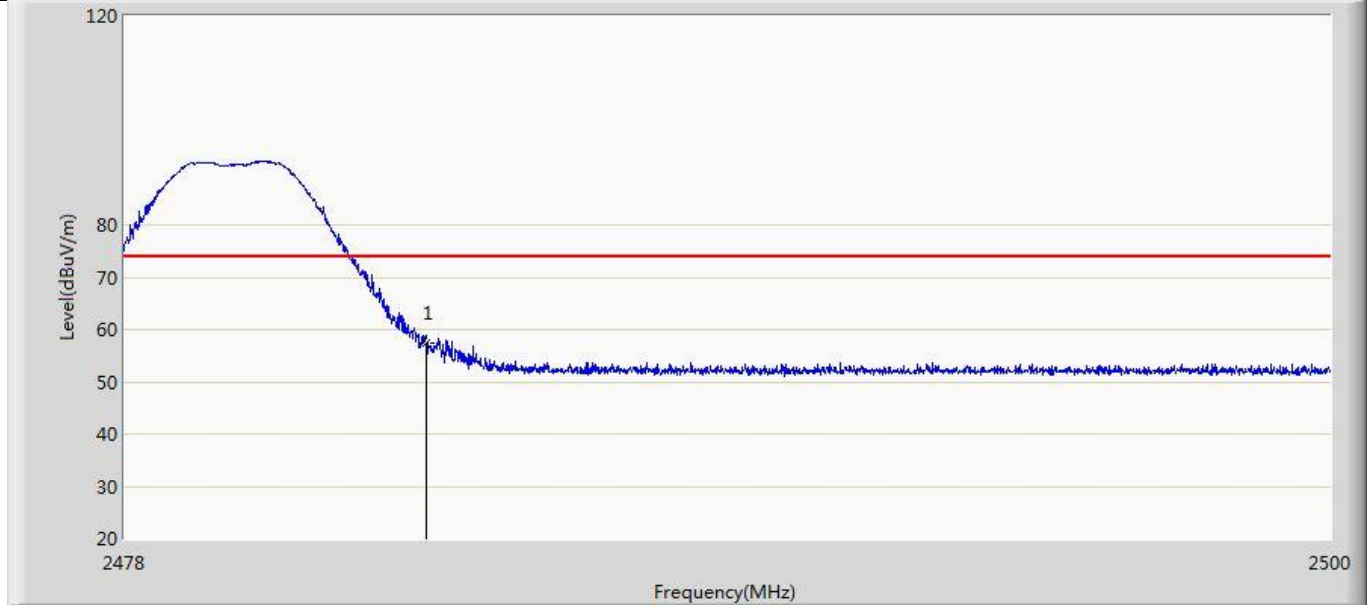

| No | Mark | Frequency (MHz) | Measure Level (dBuV/m) | Reading Level (dBuV) | Over Limit (dB) | Limit (dBuV/m) | Factor (dB) | Type |
|----|------|-----------------|------------------------|----------------------|-----------------|----------------|-------------|------|
| 1 | * | 2483.500 | 57.371 | 20.967 | -16.629 | 74.000 | 36.404 | PK |

| | |
|--|--------------------------|
| Profile: 2150357R | Page No.: 68 |
| Engineer: Tongben | |
| Site: AC5 | Time: 2021/06/02 - 00:59 |
| Limit: FCC_Part15.209_RE(3m) | Margin: 0 |
| Probe: Horn_3117_00167055(1-18GHz) | Polarity: Horizontal |
| EUT: LED lamp | Power: AC 120V/60Hz |
| Note: Mode 1:Transmit at 2480MHz by Zigbee | |

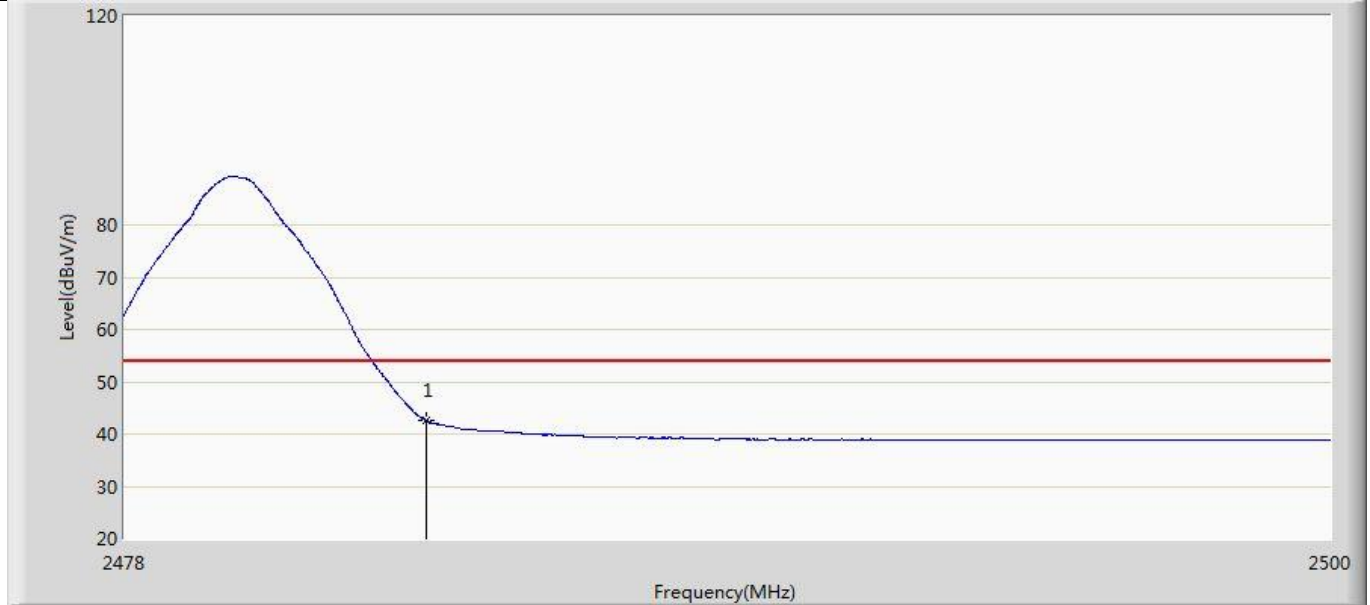

| No | Mark | Frequency (MHz) | Measure Level (dBuV/m) | Reading Level (dBuV) | Over Limit (dB) | Limit (dBuV/m) | Factor (dB) | Type |
|----|------|-----------------|------------------------|----------------------|-----------------|----------------|-------------|------|
| 1 | * | 2483.500 | 42.680 | 6.276 | -11.320 | 54.000 | 36.404 | AV |

| | |
|--|--------------------------|
| Profile: 2150357R | Page No.: 69 |
| Engineer: Tongben | |
| Site: AC5 | Time: 2021/06/02 - 01:08 |
| Limit: FCC_Part15.209_RE(3m) | Margin: 0 |
| Probe: Horn_3117_00167055(1-18GHz) | Polarity: Vertical |
| EUT: LED lamp | Power: AC 120V/60Hz |
| Note: Mode 1:Transmit at 2480MHz by Zigbee | |

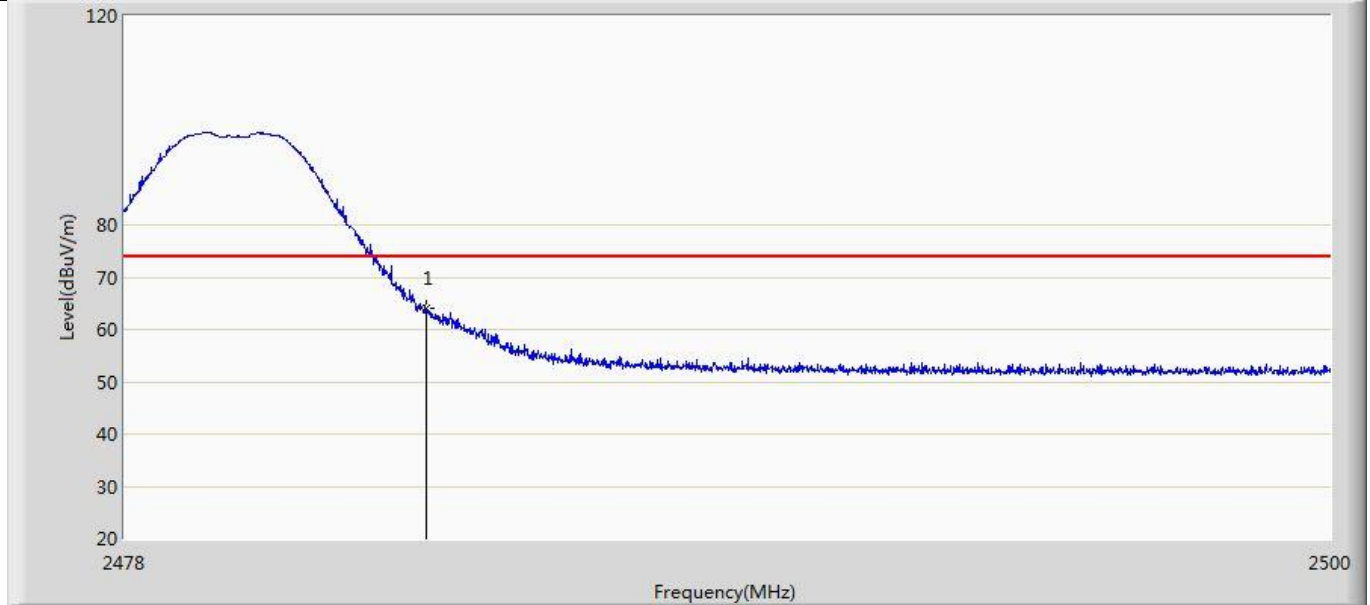

| No | Mark | Frequency (MHz) | Measure Level (dBuV/m) | Reading Level (dBuV) | Over Limit (dB) | Limit (dBuV/m) | Factor (dB) | Type |
|----|------|-----------------|------------------------|----------------------|-----------------|----------------|-------------|------|
| 1 | * | 2483.500 | 63.973 | 27.569 | -10.027 | 74.000 | 36.404 | PK |

| | |
|--|--------------------------|
| Profile: 2150357R | Page No.: 70 |
| Engineer: Tongben | |
| Site: AC5 | Time: 2021/06/02 - 01:10 |
| Limit: FCC_Part15.209_RE(3m) | Margin: 0 |
| Probe: Horn_3117_00167055(1-18GHz) | Polarity: Vertical |
| EUT: LED lamp | Power: AC 120V/60Hz |
| Note: Mode 1:Transmit at 2480MHz by Zigbee | |

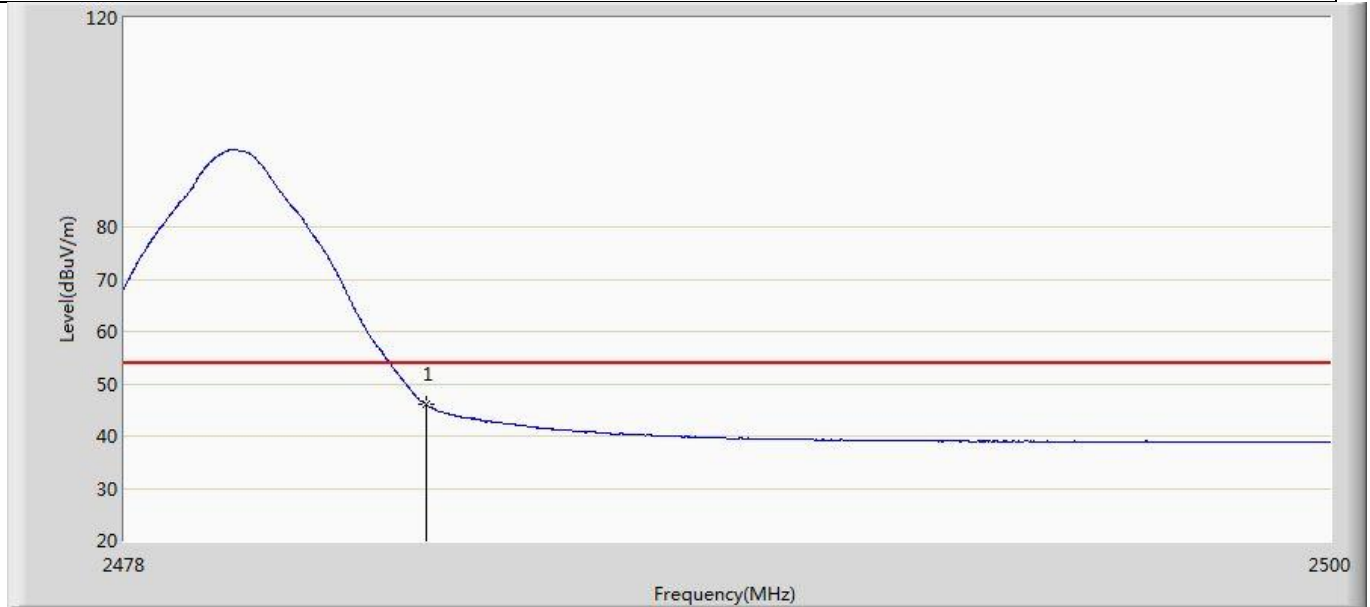

| No | Mark | Frequency (MHz) | Measure Level (dBuV/m) | Reading Level (dBuV) | Over Limit (dB) | Limit (dBuV/m) | Factor (dB) | Type |
|----|------|-----------------|------------------------|----------------------|-----------------|----------------|-------------|------|
| 1 | * | 2483.500 | 46.013 | 9.609 | -7.987 | 54.000 | 36.404 | AV |

| | |
|--------------------------|----------------------|
| 4.6 DTS Bandwidth | VERDICT: PASS |
|--------------------------|----------------------|

4.6.1 Limit

| | |
|--|---|
| Standard | FCC Part 15 Subpart C Paragraph 15.247 (a)(2) |
| Systems using digital modulation techniques operate in the 2400-2483.5 MHz. The minimum 6 dB bandwidth shall be at least 500 kHz | |

4.6.2 Test Setup

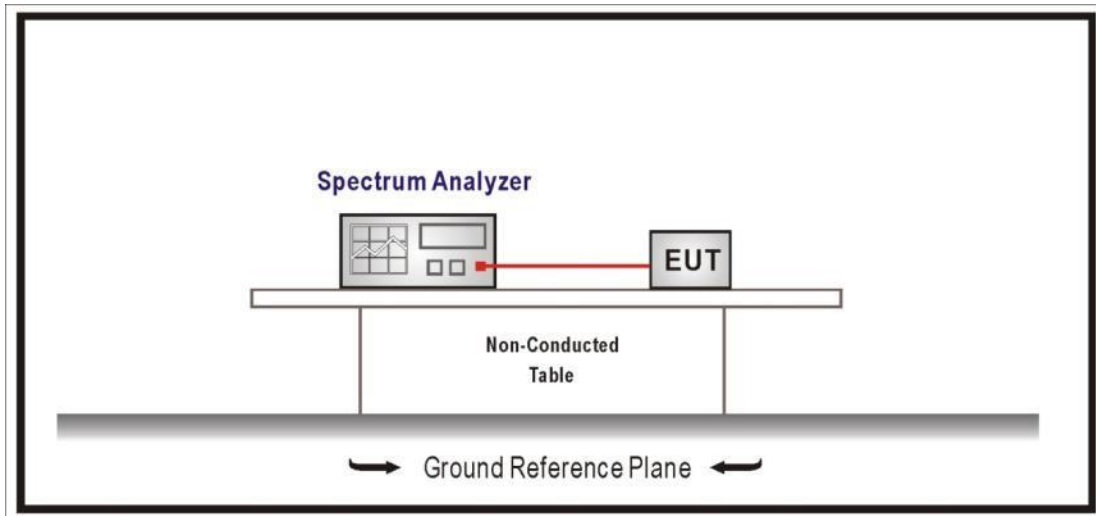

4.6.3 Test Procedure

| | Reference Rule | Chapter | Description |
|-------------------------------------|----------------|---------|---------------|
| <input checked="" type="checkbox"/> | ANSI C63.10 | 11.8 | DTS bandwidth |
| <input type="checkbox"/> | ANSI C63.10 | 11.8.1 | Option 1 |
| <input checked="" type="checkbox"/> | ANSI C63.10 | 11.8.2 | Option 2 |

4.6.4 Test Data

| Mode | CH. | Test Freq. (MHz) | 99% Occupied Bandwidth (MHz) | Limit | 6dB Occupied Bandwidth (MHz) | Limit (kHz) | Result |
|------|-----|------------------|------------------------------|-----------------------|------------------------------|-------------|--------|
| 1 | 11 | 2405 | 2.3524 | Within frequency band | 1.812 | >500 | Pass |
| | 18 | 2440 | 2.3372 | Within frequency band | 1.744 | >500 | Pass |
| | 26 | 2480 | 2.3366 | Within frequency band | 1.664 | >500 | Pass |

Note : The worst case of Occupied Bandwidth as below:

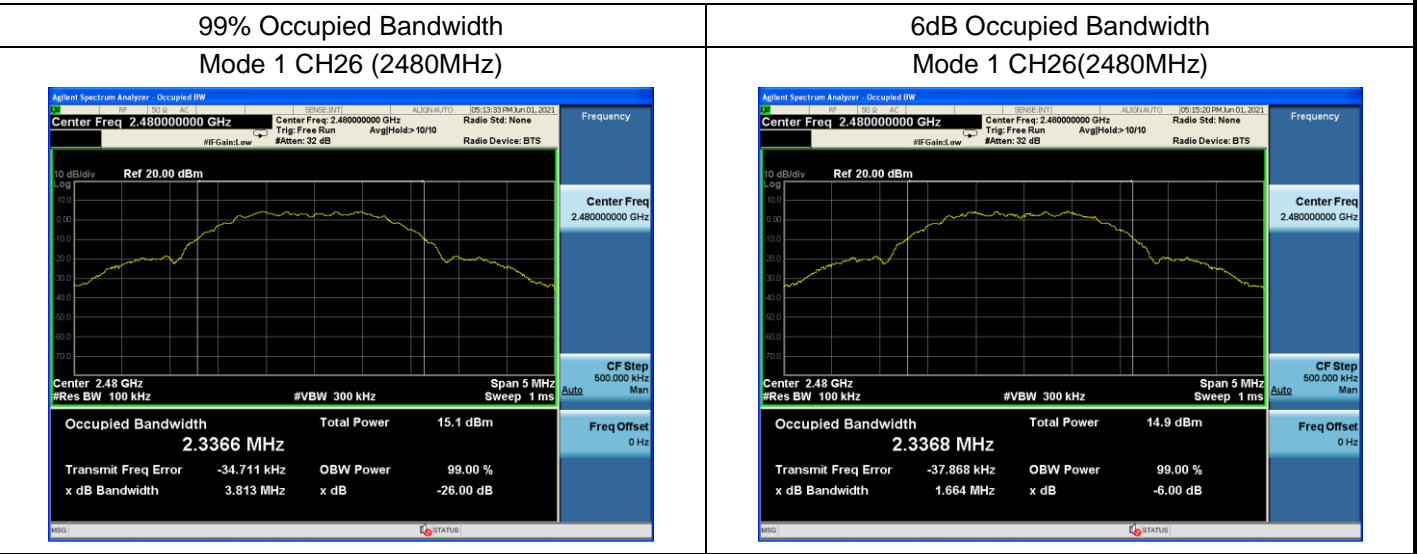

| | |
|--|----------------------|
| 4.7 Fundamental emission output power | VERDICT: PASS |
|--|----------------------|

| 4.7.1 Limit | | | |
|---|---|---------------------------------|--|
| Standard | FCC Part 15 Subpart C Paragraph 15.247 (b)(3) | | |
| <input checked="" type="checkbox"/> | GTX < 6dBi | Pout ≤ 30dBm | |
| <input type="checkbox"/> | GTX > 6dBi | | |
| <input type="checkbox"/> | Non-Fix point-point | Pout ≤ 30 - (GTX - 6) | |
| <input type="checkbox"/> | Fix point-point | Pout ≤ 30 - [(GTX - 6)]/3 | |
| <input type="checkbox"/> | Point-to-multipoint | Pout ≤ 30 - (GTX - 6) | |
| <input type="checkbox"/> | Overlap Beams | Pout ≤ 30 - [(GTX - 6)]/3 | |
| <input type="checkbox"/> | Aggregate power transmitted simultaneously on all beams | Pout ≤ 30 - [(GTX - 6)]/3 | |
| <input type="checkbox"/> | single directional beam | Pout ≤ 30 - [(GTX - 6)]/3 + 8dB | |
| Note 1 : GTX directional gain of transmitting antennas. Note 2 : Pout is maximum peak conducted output power . | | | |

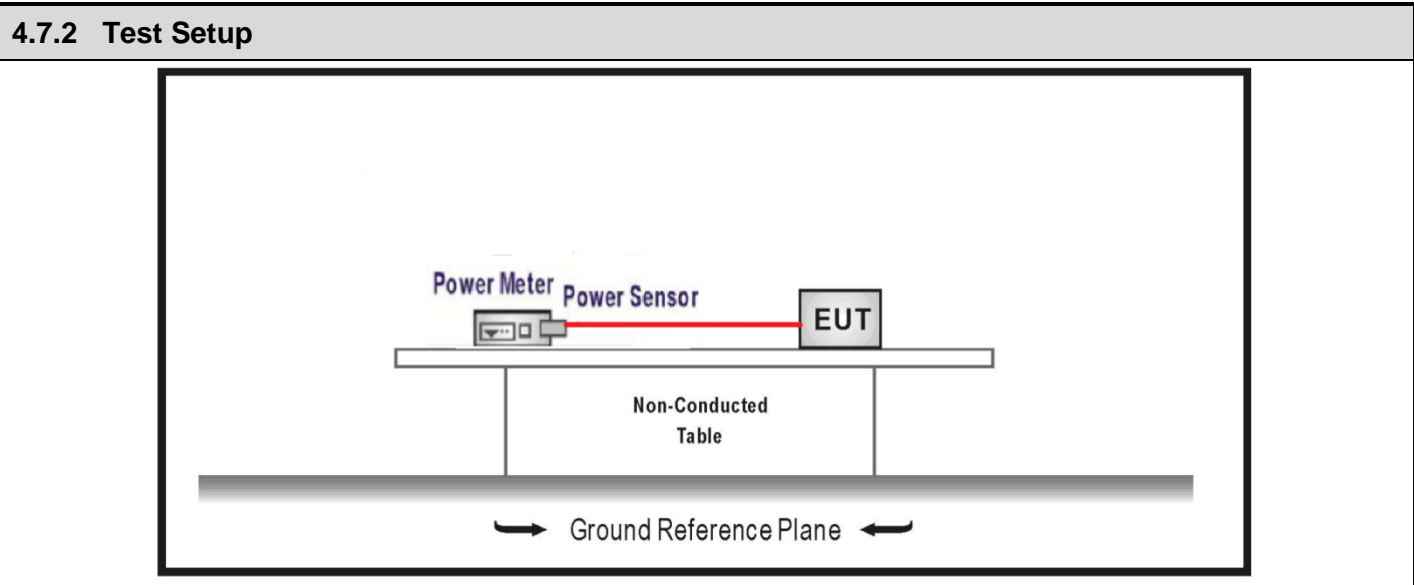

| 4.7.3 Test Procedure | | | | |
|-------------------------------------|-------------------------------------|--------------------------------------|------------|--|
| | References Rule | | Chapter | Description |
| <input checked="" type="checkbox"/> | ANSI C63.10 | | 11.9 | Fundamental emission output power |
| <input checked="" type="checkbox"/> | <input checked="" type="checkbox"/> | ANSI C63.10 | 11.9.1 | Maximum peak conducted output power |
| | <input type="checkbox"/> | ANSI C63.10 | 11.9.1.1 | RBW \geq DTS bandwidth |
| | <input type="checkbox"/> | ANSI C63.10 | 11.9.1.2 | Integrated band power method |
| | <input checked="" type="checkbox"/> | ANSI C63.10 | 11.9.1.3 | PKPM1 Peak power meter method |
| | <input type="checkbox"/> | ANSI C63.10 | 11.9.2 | Maximum conducted (average) output power |
| | <input type="checkbox"/> | ANSI C63.10 | 11.9.2.2 | Measurement using a spectrum analyzer (SA) |
| | | <input type="checkbox"/> ANSI C63.10 | 11.9.2.2.2 | Method AVGSA-1(Duty cycle \geq 98%) |
| | | <input type="checkbox"/> ANSI C63.10 | 11.9.2.2.3 | Method AVGSA-1A(Duty cycle \geq 98%) |
| | | <input type="checkbox"/> ANSI C63.10 | 11.9.2.2.4 | Method AVGSA-2(Duty cycle \leq 98%) |
| | | <input type="checkbox"/> ANSI C63.10 | 11.9.2.2.5 | Method AVGSA-2A(Duty cycle \leq 98%) |
| | | <input type="checkbox"/> ANSI C63.10 | 11.9.2.2.4 | Method AVGSA-3 |
| | | <input type="checkbox"/> ANSI C63.10 | 11.9.2.2.5 | Method AVGSA-3A |
| | <input type="checkbox"/> | ANSI C63.10 | 11.9.2.3 | Measurement using a power meter (PM) |
| | | <input type="checkbox"/> ANSI C63.10 | 11.9.2.3.1 | Method AVGPM |
| | | <input type="checkbox"/> ANSI C63.10 | 11.9.2.3.2 | Method AVGPM-G |

4.7.4 Test Data

| Mode | Channel | Test Frequency (MHz) | Conducted Power (dBm) | EIRP (dBm) | Conducted Power Limit (dBm) | EIRP Limit (dBm) | Result |
|--------|---------|----------------------|-----------------------|------------|-----------------------------|------------------|--------|
| Mode 1 | 11 | 2405 | 9.90 | 9.54 | ≤30 | ≤36 | Pass |
| | 18 | 2440 | 9.56 | 9.20 | ≤30 | ≤36 | Pass |
| | 26 | 2480 | 9.49 | 9.13 | ≤30 | ≤36 | Pass |

| | |
|--------------------------|----------------------|
| 4.8 Power Density | VERDICT: PASS |
|--------------------------|----------------------|

| | |
|---|---|
| 4.8.1 Limit | |
| Standard | FCC Part 15 Subpart C Paragraph 15.247 (b)(3) |
| Power Spectral Density $\leq 8\text{dBm}/3\text{kHz}$ | |

| |
|-------------------------|
| 4.8.2 Test Setup |
|-------------------------|

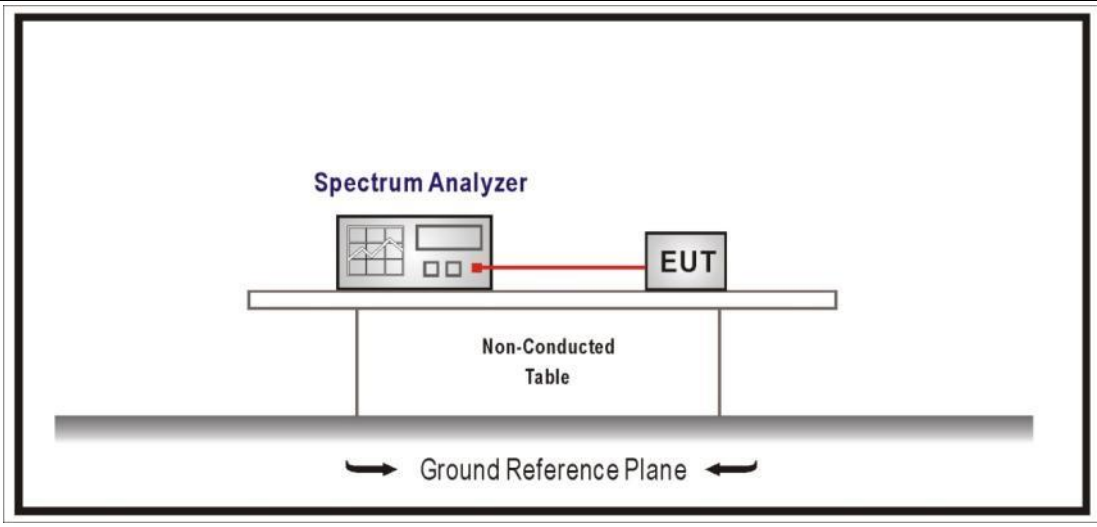

| |
|-----------------------------|
| 4.8.3 Test Procedure |
|-----------------------------|

| | References Rule | Chapter | Description |
|-------------------------------------|-----------------|---------|--|
| <input checked="" type="checkbox"/> | ANSI C63.10 | 11.10 | Maximum power spectral density level in the fundamental emission |
| <input checked="" type="checkbox"/> | ANSI C63.10 | 11.10.2 | Method PKPSD (peak PSD) |
| <input type="checkbox"/> | ANSI C63.10 | 11.10.3 | Method AVGPSD-1(Duty cycle $\geq 98\%$) |
| <input type="checkbox"/> | ANSI C63.10 | 11.10.4 | Method AVGPSD-1A(Duty cycle $\geq 98\%$) |
| <input type="checkbox"/> | ANSI C63.10 | 11.10.5 | Method AVGPSD-2(Duty cycle $< 98\%$) |
| <input type="checkbox"/> | ANSI C63.10 | 11.10.6 | Method AVGPSD-2A(Duty cycle $< 98\%$) |
| <input type="checkbox"/> | ANSI C63.10 | 11.10.7 | Method AVGPSD-3 |
| <input type="checkbox"/> | ANSI C63.10 | 11.10.8 | Method AVGPSD-3A |

4.8.4 Test Data

| Mode | Channel | Test Frequency (MHz) | Measurement PSD (dBm/3kHz) | Limit (dBm/3kHz) | Result |
|--------|---------|----------------------|----------------------------|------------------|--------|
| Mode 1 | 11 | 2405 | -6.834 | ≤8 | Pass |
| | 18 | 2440 | -8.303 | ≤8 | Pass |
| | 26 | 2480 | -8.208 | ≤8 | Pass |

Note : The worst case of PSD as below:

Mode 1 CH11(2405MHz)



| | |
|--------------------------------|----------------------|
| 4.9 Antenna Requirement | VERDICT: PASS |
|--------------------------------|----------------------|

| | |
|---|--|
| 4.9.1 Limit | |
| Standard | FCC Part 15 Subpart C Paragraph 15.203 |
| <p>An intentional radiator shall be designed to ensure that no antenna other than that furnished by the responsible party shall be used with the device. The use of a permanently attached antenna or of an antenna that uses a unique coupling to the intentional radiator shall be considered sufficient to comply with the provisions of this section. The manufacturer may design the unit so that a broken antenna can be replaced by the user, but the use of a standard antenna jack or electrical connector is prohibited. This requirement does not apply to carrier current devices or to devices operated under the provisions of §15.211, §15.213, §15.217, §15.219, or §15.221. Further, this requirement does not apply to intentional radiators that must be professionally installed, such as perimeter protection systems and some field disturbance sensors, or to other intentional radiators which, in accordance with §15.31(d), must be measured at the installation site. However, the installer shall be responsible for ensuring that the proper antenna is employed so that the limits in this part are not exceeded.</p> | |

| | |
|--|--|
| 4.9.2 Antenna Connector Construction: | |
| <input checked="" type="checkbox"/> | The use of a permanently attached antenna |
| <input type="checkbox"/> | The antenna use of a unique coupling to the intentional radiator |
| <input type="checkbox"/> | The use of a nonstandard antenna jack or electrical connector |
| Please refer to the attached document "Internal Photograph" to show the antenna connector. | |

5 TEST SETUP PHOTO AND EUT PHOTO

Remark: The test setup photo and EUT Photo please see appendix.

_____ The End _____