

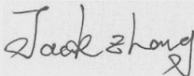

Test report No:
20C0553R-RF-US-P06V02

FCC & ISED TEST REPORT

Product Name	LED Lamp
Trademark	PHILIPS
Model and /or type reference	9290024783 9290024784 9290024785 9290029808 9290029809
FCC ID	2AGBW9290024783X 2AGBW9290024784X 2AGBW9290024785X 2AGBW9290029808X 2AGBW9290029809X
IC	20812-24783X 20812-24784X 20812-24785X 20812-29808X 20812-29809X
Applicant's name / address	Signify (China) Investment Co., Ltd Building no.9, Lane 888, Tianlin Road, Minhang District, Shanghai, 200233, China
Test method requested, standard	FCC CFR Title 47 Part 15 Subpart C Section 15.247 ANSI C63.10: 2013 RSS-Gen Issue 5 RSS-247 Issue 2
Verdict Summary	IN COMPLIANCE
Test by (name / position & signature)	Tim Cao/Project Engineer 
Approved by (name / position & signature)	Jack Zhang/Supervisor 
Date of issue	2021-03-18
Report template No	Template_FCC 15.247-RF-V1.0

INDEX

	page
General conditions	4
Environmental conditions	4
Possible test case verdicts	5
Abbreviations	5
Document History	6
Remarks and Comments.....	6
Used Equipment	7
Uncertainty	9
1 General Information.....	10
1.1 General Description of the Item(s)	10
1.2 Antenna Information	11
1.3 Channel List	12
2 Description of Test Setup	13
2.1 Operating mode(s) used for tests.....	13
2.2 Test Configuration / Block diagram used for tests	14
2.3 Testing process	15
3 Verdict summary section	16
3.1 Standards.....	16
3.2 Deviation(s) from the Standard(s) / Test Specification(s).....	16
3.3 Overview of results.....	17
3.4 Test Facility.....	18
4 Test Results	19
4.1 AC Power Line Conducted Emission	19
4.1.1 Limit	19
4.1.2 Test Setup.....	19
4.1.3 Test Procedure.....	19
4.1.4 Test Data	20
4.2 Emissions in restricted frequency bands	22
4.2.1 Limit	22
4.2.2 Test Setup.....	24
4.2.3 Test Procedure.....	24
4.2.4 Test Data	25
4.3 Emissions in non-restricted frequency band.....	51
4.3.1 Limit	51

4.3.2	Test Setup.....	51
4.3.3	Test Procedure.....	51
4.3.4	Test Data	52
4.4	Duty cycle	53
4.4.1	Limit	53
4.4.2	Test Setup.....	53
4.4.3	Test Procedure.....	53
4.4.4	Test Data	54
4.5	Radiated Emission Band Edge	55
4.5.1	Limit	55
4.5.2	Test Setup.....	55
4.5.3	Test Procedure.....	55
4.5.4	Test Data	56
4.6	DTS Bandwidth	88
4.6.1	Limit	88
4.6.2	Test Setup.....	88
4.6.3	Test Procedure.....	88
4.6.4	Test Data	89
4.7	Fundamental emission output power	90
4.7.1	Limit	90
4.7.2	Test Setup.....	90
4.7.3	Test Procedure.....	91
4.7.4	Test Data	92
4.8	Power Density	93
4.8.1	Limit:	93
4.8.2	Test Setup.....	93
4.8.3	Test Procedure.....	93
4.8.4	Test Data	94
4.9	Antenna Requirement.....	95
4.9.1	Limit:	95
4.9.2	Antenna Connector Construction:	95
5	Test setup photo and EUT Photo.....	96

COMPETENCES AND GUARANTEES

DEKRA is a testing laboratory competent to carry out the tests described in this report.

In order to assure the traceability to other national and international laboratories, DEKRA has a calibration and maintenance program for its measurement equipment.

DEKRA guarantees the reliability of the data presented in this report, which is the result of the measurements and the tests performed to the item under test on the date and under the conditions stated in the report and it is based on the knowledge and technical facilities available at DEKRA at the time of performance of the test.

DEKRA is liable to the client for the maintenance of the confidentiality of all information related to the item under test and the results of the test.

The results presented in this Test Report apply only to the particular item under test established in this document.

IMPORTANT: No parts of this report may be reproduced or quoted out of context, in any form or by any means, except in full, without the previous written permission of DEKRA.

GENERAL CONDITIONS

Test Location	No. 99, Hongye Road, Suzhou Industrial Park Suzhou, 215006, P.R. China
Date(receive sample)	Dec. 15, 2020
Date (start test)	Dec. 15, 2020
Date (finish test)	Jan. 12, 2021

1. This report is only referred to the item that has undergone the test.
2. This report does not constitute or imply on its own an approval of the product by the Certification Bodies or Competent Authorities.
3. This document is only valid if complete; no partial reproduction can be made without previous written permission of DEKRA.
4. This test report cannot be used partially or in full for publicity and/or promotional purposes without previous written permission of DEKRA.

ENVIRONMENTAL CONDITIONS

The climatic conditions during the tests are within the limits specified by the manufacturer for the operation of the EUT and the test equipment. The climatic conditions during the tests were within the following limits:

Ambient temperature	15 °C – 35 °C
Relative Humidity air	30% - 60%

If explicitly required in the basic standard or applied product / product family standard the climatic values are recorded and documented separately in this test report.

POSSIBLE TEST CASE VERDICTS

Test case does not apply to test object	N/A
Test object does meet requirement	P (Pass) / PASS
Test object does not meet requirement	F (Fail) / FAIL
Not measured	N/M

ABBREVIATIONS

For the purposes of the present document, the following abbreviations apply:

EUT	: Equipment Under Test
QP	: Quasi-Peak
CAV	: CISPR Average
AV	: Average
CDN	: Coupling Decoupling Network
SAC	: Semi-Anechoic Chamber
OATS	: Open Area Test Site
BW	: Bandwidth
AM	: Amplitude Modulation
PM	: Pulse Modulation
HCP	: Horizontal Coupling Plane
VCP	: Vertical Coupling Plane
U_N	: Nominal voltage
T_x	: Transmitter
R_x	: Receiver
N/A	: Not Applicable
N/M	: Not Measured

DOCUMENT HISTORY

Report No.	Version	Description	Issued Date
20C0553R-RF-US-P06V02	V1.0	Initial issue of report.	2021-03-18

REMARKS AND COMMENTS

1. The equipment under test (EUT) does meet the essential requirements of the stated standard(s)/test(s).
2. These test results on a sample of the device are for the purpose of demonstrating Compliance with Part 15 Subpart C Paragraph 15.247, RSS-Gen Issue 5, RSS-247 Issue 2.
3. The measurement result is considered in conformance with the requirement if it is within the prescribed limit, It is not necessary to account the uncertainty associated with the measurement result.
4. The test results presented in this report relate only to the object tested.
5. The test report shall not be reproduced without the written approval of DEKRA Testing and Certification (Suzhou) Co., Ltd.
6. This report will not be used for social proof function in China market.
7. DEKRA declines any responsibility with the following test data provided by customer that may affect the validity of result:
 - Chapter 1.1 General Description of the Item(s);
 - Chapter 1.2 Antenna Informaion;
 - Chapter 1.3 Channel List.

USED EQUIPMENT

AC Power Line Conducted Emission / TR1

Instrument	Manufacturer	Model No.	Serial No.	Cal. Date	Next Cal. Date
EMI Test Receiver	R&S	ESCI	100906	2020.04.20	2021.04.19
Two-Line V-Network	R&S	ENV216	101190	2020.12.28	2021.12.27
Two-Line V-Network	R&S	ENV216	101044	2020.12.28	2021.12.27
Current Probe	R&S	EZ-17	100678	2020.03.12	2021.04.11
50ohm Termination	SHX	TF2	07081402	2020.09.23	2021.09.22
50ohm Termination	SHX	TF2	07081403	2020.09.23	2021.09.22
50ohm Coaxial Switch	Anritsu	MP59B	6200464462	N/A	N/A
Temperature/Humidity Meter	RTS	RTS-8S	TR1-TH	2020.08.13	2021.08.12
Coaxial Cable	Suhner	RG 223	TR1-C1	2020.08.13	2021.08.12
Coaxial Cable	Suhner	RG 223	TR1-C2	2020.08.13	2021.08.12
Dekra test software	Dekra	-	-	-	-

Emissions in non-restricted frequency bands/ Occupied Bandwidth/ Fundamental emission output power Power Spectral Density / TR8

Instrument	Manufacturer	Model No.	Serial No.	Cal. Date	Next Cal. Date
Spectrum Analyzer	Agilent	N9010A	MY48030494	2020.08.15	2021.08.14
EXA Spectrum Analyzer	Keysight	N9010A	MY55370495	2020.04.17	2021.04.16
MXA Signal Analyzer	Keysight	N9020A	MY56060147	2020.08.15	2021.08.14
Temperature/Humidity Meter	RTS	RTS-8S	RF08	2020.08.13	2021.08.12
Dekra test software	Dekra	-	-	-	-

Radiated Emission(30MHz-1GHz) / AC3

Instrument	Manufacturer	Model No.	Serial No.	Cal. Date	Next Cal. Date
EMI Test Receiver	R&S	ESCI	100573	2020.03.03	2021.03.02
Bilog Antenna	Teseq GmbH	CBL6112D	27611	2020.08.19	2021.08.18
Temperature/Humidity Meter	RTS	RTS-8S	AC2-TH	2020.08.13	2021.08.12
Coaxial Cable	Huber+Suhner	RG 214	AC2-C	2020.04.05	2021.04.04
Dekra test software	Dekra	-	-	-	-

Radiated Emission / AC5(1GHz-40GHz)(Chamber details)

Instrument	Manufacturer	Model No.	Serial No.	Cal. Date	Next Cal. Date
Spectrum Analyzer	Agilent	E4446A	MY45300103	2020.05.08	2021.05.07
Preamplifier	Miteq	NSP1800-25	1364185	2020.05.06	2021.05.05
Preamplifier	QuieTek	AP-040G	CHM-0906001	2020.05.06	2021.05.05
DRG Horn	ETS-Lindgren	3117	00123988	2020.01.22	2021.01.21
Temperature/Humidity Meter	Zhichen	ZC1-2	AC5-TH	2020.08.13	2021.08.12
Coaxial Cable	Huber+Suhner	SUCOFLEX 106	AC5-C1	2020.04.05	2021.04.04
Coaxial Cable	Huber+Suhner	SUCOFLEX 106	AC5-C2	2020.04.05	2021.04.04
Coaxial Cable	Huber+Suhner	SUCOFLEX 102	AC5-C3	2020.04.05	2021.04.04
Dekra test software	Dekra	-	-	-	-

UNCERTAINTY

Uncertainties have been calculated according to the DEKRA internal document. The reported expanded uncertainties are based on a standard uncertainty multiplied by a coverage factor of $k=2$, providing a level of confidence of approximately 95%. The Uncertainties is comply with standard required as below.

Test item	Uncertainty
AC Power Line Conducted Emission	9kHz~150kHz: 2.80 dB 150kHz~30MHz: 2.40 dB
Peak Power Output	± 1.27 dB
Radiated Emission(30MHz~1GHz)	Horizontal: 30MHz~200MHz: 3.50 dB 300MHz~1GHz: 3.60 dB Vertical: 30MHz~200MHz: 3.60 dB 300MHz~1GHz: 3.50 dB
Radiated Emission(1GHz~26.5GHz)	Horizontal: 1GHz~18GHz: 5.00 dB Vertical: 1GHz~18GHz: 4.80 dB
RF antenna conducted test	± 1.27 dB
Radiated Emission Band Edge	± 3.9 dB
DTS Bandwidth	± 150 Hz
Occupied Bandwidth	± 1 kHz
Power Density	± 1.27 dB

1 GENERAL INFORMATION

1.1 General Description of the Item(s)

Product Name..... :	LED Lamp
Model No. :	9290024783 9290024784 9290024785 9290029808 9290029809
FCC ID :	2AGBW9290024783X 2AGBW9290024784X 2AGBW9290024785X 2AGBW9290029808X 2AGBW9290029809X
IC..... :	20812-24783X 20812-24784X 20812-24785X 20812-29808X 20812-29809X
Manufacturer..... :	Signify (China) Investment Co., Ltd
Manufacturer Address..... :	Building no.9, Lane 888, Tianlin Road, Minhang District, Shanghai, 200233, China
Model Differences	All models are identical but with different lamp cap and bulb shape.

Wireless specification..... :	Bluetooth 5.0				
Operating frequency range(s)	2400~2483.5MHz				
Type of Modulation..... :	GFSK				
PHYs	<input checked="" type="checkbox"/> LE 1M	<input checked="" type="checkbox"/> LE 2M	<input checked="" type="checkbox"/> LE Coded S=2/8		
Data Rate	<input checked="" type="checkbox"/> 1Mbit/s	<input checked="" type="checkbox"/> 2Mbit/s	<input checked="" type="checkbox"/> 500/125 Kbit/s		
Number of channel..... :	40				

Rated power supply	Voltage and Frequency				
	<input type="checkbox"/>	AC: 220 – 240 Vac, 50/60 Hz			
	<input checked="" type="checkbox"/>	AC: 110 – 130 Vac, 50/60 Hz			
	<input type="checkbox"/>	DC: 3.2~4.2 Vdc			
	<input type="checkbox"/>	Battery:			
Mounting position..... :	<input type="checkbox"/>	Table top equipment			
	<input checked="" type="checkbox"/>	Wall/Ceiling mounted equipment			
	<input type="checkbox"/>	Floor standing equipment			
	<input type="checkbox"/>	Head-mounted equipment			
	<input type="checkbox"/>	Other: RF module			

1.2 Antenna Information

Antenna model / type number	N/A		
Antenna serial number	N/A		
Antenna Delivery	<input checked="" type="checkbox"/>	1TX + 1RX	
	<input type="checkbox"/>	2TX + 2RX	
Antenna technology	<input checked="" type="checkbox"/>	SISO	
	<input type="checkbox"/>	MIMO	<input type="checkbox"/> CDD <input type="checkbox"/> Beam-forming
Antenna Type	<input type="checkbox"/>	External	<input type="checkbox"/> Dipole
			<input type="checkbox"/> Sectorized
	<input checked="" type="checkbox"/>	Internal	<input checked="" type="checkbox"/> PIFA
			<input type="checkbox"/> PCB
			<input type="checkbox"/> Metal Monopole Antenna
		<input type="checkbox"/> Others.....	
Antenna Gain.....	-0.36 dBi		

1.3 Channel List

Bluetooth Working Frequency of Each Channel:							
Channel	Frequency	Channel	Frequency	Channel	Frequency	Channel	Frequency
00	2402 MHz	01	2404 MHz	02	2406 MHz	03	2408 MHz
04	2410 MHz	05	2412 MHz	06	2414 MHz	07	2416 MHz
08	2418 MHz	09	2420 MHz	10	2422 MHz	11	2424 MHz
12	2426 MHz	13	2428 MHz	14	2430 MHz	15	2432 MHz
16	2434 MHz	17	2436 MHz	18	2438 MHz	19	2440 MHz
20	2442 MHz	21	2444 MHz	22	2446 MHz	23	2448 MHz
24	2450 MHz	25	2452 MHz	26	2454 MHz	27	2456 MHz
28	2458 MHz	29	2460 MHz	30	2462 MHz	31	2464 MHz
32	2466 MHz	33	2468 MHz	34	2470 MHz	35	2472 MHz
36	2474 MHz	37	2476 MHz	38	2478 MHz	39	2480 MHz

2 DESCRIPTION OF TEST SETUP

2.1 Operating mode(s) used for tests

During the tests the following operating mode(s) has(have) been used.

Test Mode For Bluetooth	Mode1: Transmit by LE_1Mbps
	Mode2: Transmit by LE_2Mbps
	Mode3: Transmit by LE_Coded S=2
	Mode4: Transmit by LE_Coded S=8

2.2 Test Configuration / Block diagram used for tests

Test setup Diagram- AC Line Conducted Emission Test

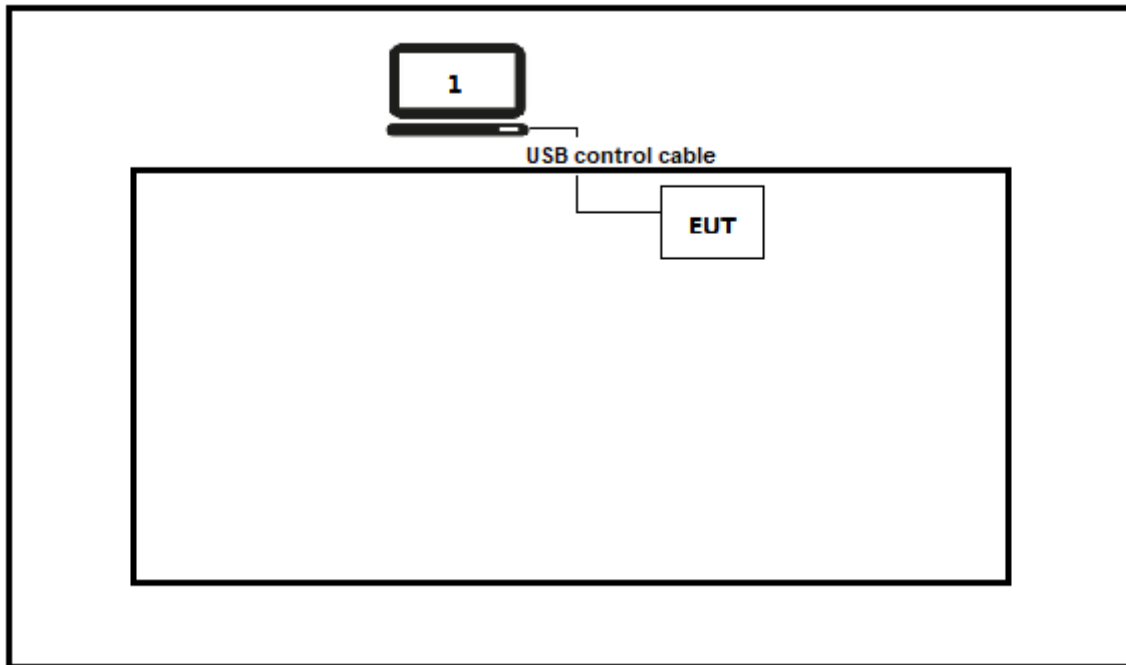

Test setup Diagram- Radiated Emission

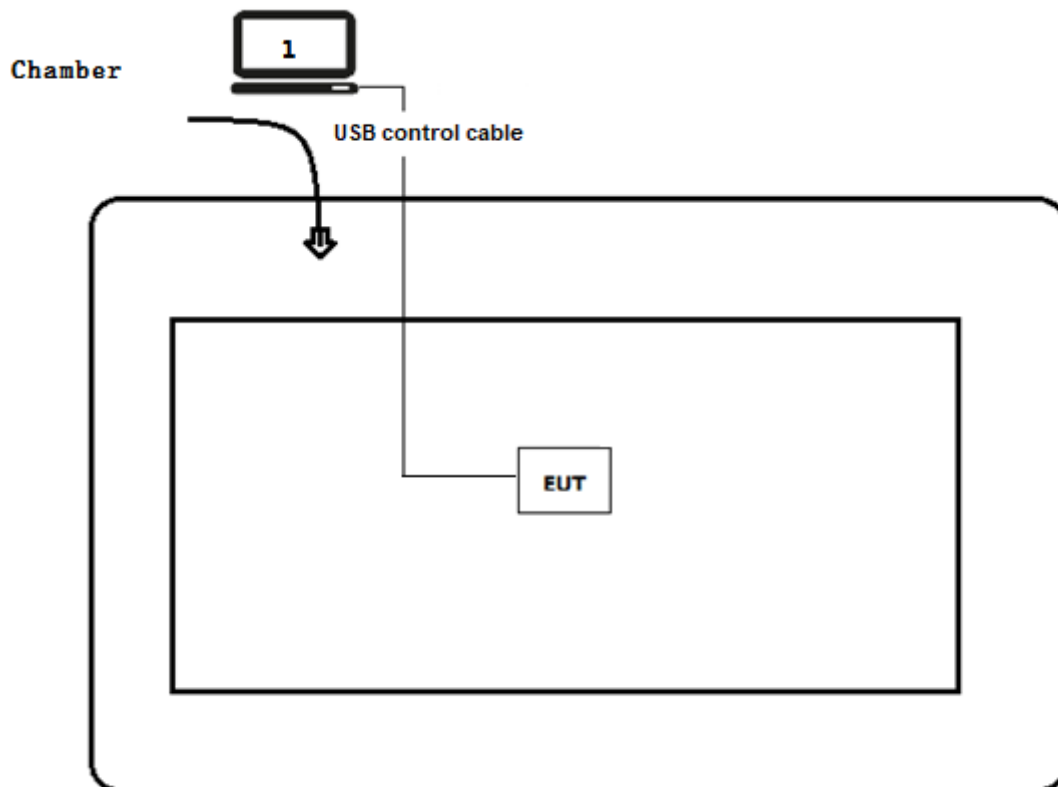

2.3 Testing process

1	Setup the EUT as shown in Section 2.2.
2	Execute Switch channel by repeating power on.
3	Configure the test mode, the test channel, and the data rate.
4	Verify that the EUT works properly.

3 VERDICT SUMMARY SECTION

This chapter presents an overview of standards and results. Refer to the next chapters for details of measured test results and applied test levels.

3.1 Standards

Standard	Year	Description
FCC CFR Title 47 Part 15 Subpart C Section 15.247	2019	Operation within the bands 902–928 MHz, 2400–2483.5 MHz, and 5725–5850 MHz.
ANSI C63.10	2013	American National Standard of Procedures for Compliance Testing of Unlicensed Wireless Devices
KDB 558074 D01 v05r02	2019	Guidance for performing compliance measurements on Digital Transmission System (DTS) operating under section 15.247
RSS-Gen Issue 5 Amendment 1	2019	General Requirements for Compliance of Radio Apparatus
RSS-247 Issue 2	2017	Digital Transmission Systems (DTSs), Frequency Hopping Systems (FHSs) and Licence-Exempt Local Area Network (LE-LAN) Devices

3.2 Deviation(s) from the Standard(s) / Test Specification(s)

The following deviation(s) was / were made from the published requirements of the listed standards: N/A.

(Please define the deviations from the standard(s) if applicable)

3.3 Overview of results

For FCC

Requirement – Test case	Basic standard(s)	Verdict	Remark
AC Power Line Conducted Emission	FCC 15.207	PASS	---
Emissions in restricted frequency bands	FCC 15.247(b)(3)	PASS	---
Duty cycle	ANSI C63.10:2013	PASS	---
Emissions in non-restricted frequency bands	FCC 15.247(d), FCC 15.209	PASS	---
Radiated Emission Band Edge	FCC 15.247(d)	PASS	---
Fundamental emission output power	FCC 15.247(d), FCC 15.209	PASS	---
DTS Bandwidth	FCC 15.247(a)(2)	PASS	---
Power Spectral Density	FCC 15.247(e)	PASS	---
Antenna Requirement	FCC 15.203	PASS	---

For ISED

Requirement – Test case	Basic standard(s)	Verdict	Remark
AC Power Line Conducted Emission	RSS-Gen Issue 5 Section 8.8	PASS	---
Emissions in restricted frequency bands	RSS-Gen Issue 5 Section 8.9	PASS	---
Duty cycle	ANSI C63.10:2013	PASS	---
Emissions in non-restricted frequency bands	RSS-247 Issue 2 Section 5.5	PASS	---
Radiated Emission Band Edge	RSS-Gen Issue 5 Section 8.10	PASS	---
Fundamental emission output power	RSS-247 Issue 2 Section 5.4(d)	PASS	---
DTS Bandwidth	RSS-Gen Issue 5 Section 6.7	PASS	---
Power Spectral Density	RSS-247 Issue 2 Section 5.2(b)	PASS	---
Antenna Requirement	RSS-Gen Issue 5 Section 6.8	PASS	---

3.4 Test Facility

USA : FCC Designation Number: CN1199

CA : ISED CAB identifier: CN0040

4 TEST RESULTS

4.1 AC Power Line Conducted Emission

VERDICT: PASS

4.1.1 Limit

Standard		
FCC Part 15 Subpart C Paragraph 15.207		
Frequency range [MHz]	Limit: QP [dB(μV) ¹⁾	Limit: AV [dB(μV) ¹⁾
0,15 - 0,50	66 - 56 ²⁾	56 - 46 ²⁾
0,50 - 5,0	56	46
5,0 - 30	60	50

¹⁾ At the transition frequency, the lower limit applies.

²⁾ The limit decreases linearly with the logarithm of the frequency.

NOTE 1: The exclusion band for transmitters shall be considered for transmitters operating at frequencies below 30 MHz.

NOTE 2: Where the AC output port is directly connected (or via a circuit breaker) to the AC power input port of the EUT the AC power output port need not to be tested.

4.1.2 Test Setup

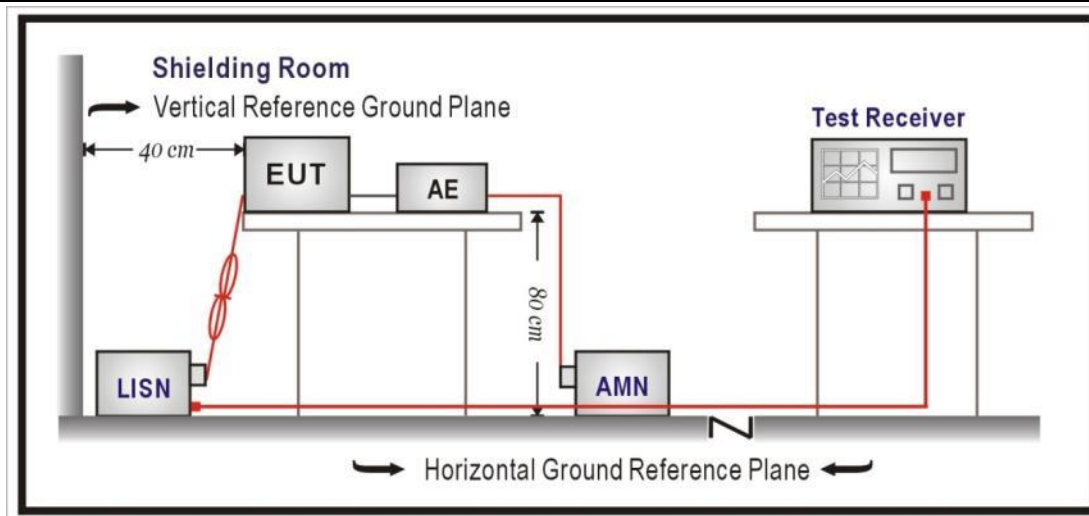

4.1.3 Test Procedure

References Rule	Chapter	Item
<input checked="" type="checkbox"/> ANSI C63.10-2013	6.2	Standard test method for ac power-line conducted emissions from unlicensed wireless devices

4.1.4 Test Data

Profile: 20C0553R	Page No.: 7
Engineer: Yingfeiwang	
Site: TR1	Time: 2021/01/06 - 01:50
Limit: FCC_Part15.207_CE_AC Power	Margin: 0
Probe: ENV216_101190(0.009-30MHz)	Polarity: Line
EUT: LED Lamp	Power: AC 120V/60Hz
Note: Mode 1	

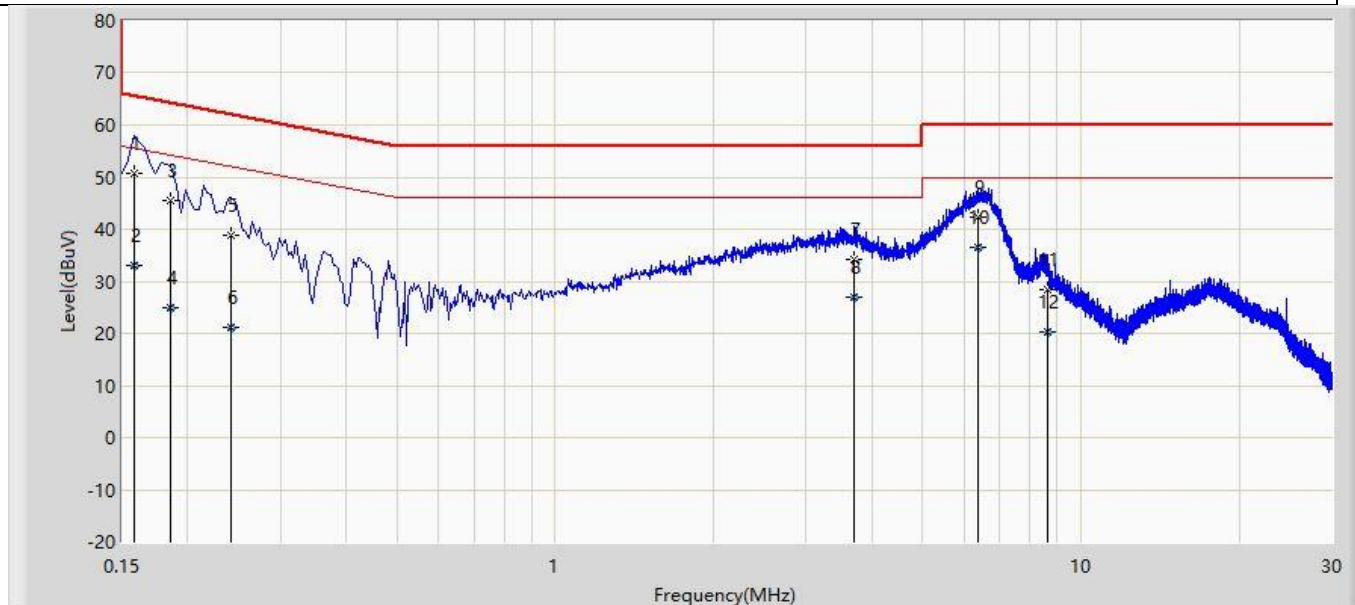

No	Mark	Frequency (MHz)	Measure Level (dBuV)	Reading Level (dBuV)	Over Limit (dB)	Limit (dBuV)	Probe (dB)	Cable (dB)	Amp (dB)	Type
1		0.158	50.802	41.200	-14.766	65.568	9.574	0.029	0.000	QP
2		0.158	32.943	23.340	-22.625	55.568	9.574	0.029	0.000	AV
3		0.186	45.590	35.977	-18.623	64.213	9.585	0.028	0.000	QP
4		0.186	24.893	15.280	-29.320	54.213	9.585	0.028	0.000	AV
5		0.242	38.706	29.083	-23.321	62.027	9.593	0.030	0.000	QP
6		0.242	21.163	11.541	-30.864	52.027	9.593	0.030	0.000	AV
7		3.706	34.118	24.316	-21.882	56.000	9.680	0.122	0.000	QP
8		3.706	26.881	17.079	-19.119	46.000	9.680	0.122	0.000	AV
9		6.374	42.405	32.493	-17.595	60.000	9.751	0.160	0.000	QP
10	*	6.374	36.539	26.627	-13.461	50.000	9.751	0.160	0.000	AV
11		8.630	28.317	18.327	-31.683	60.000	9.802	0.187	0.000	QP
12		8.630	20.345	10.356	-29.655	50.000	9.802	0.187	0.000	AV

Note:

1. All Readings below 1GHz are Quasi-Peak, above are performed with peak and/or average measurements as necessary.
2. " * ", means this data is the worst emission level.
3. Measurement Level = Reading Level + Factor(Probe+Cable-Amp).

Profile: 20C0553R	Page No.8
Engineer: Yingfeiwang	
Site: TR1	Time: 2021/01/06 - 01:50
Limit: FCC_Part15.207_CE_AC Power	Margin: 0
Probe: ENV216_101190(0.009-30MHz)	Polarity: Line
EUT: LED Lamp	Power: AC 120V/60Hz
Note: Mode 1	

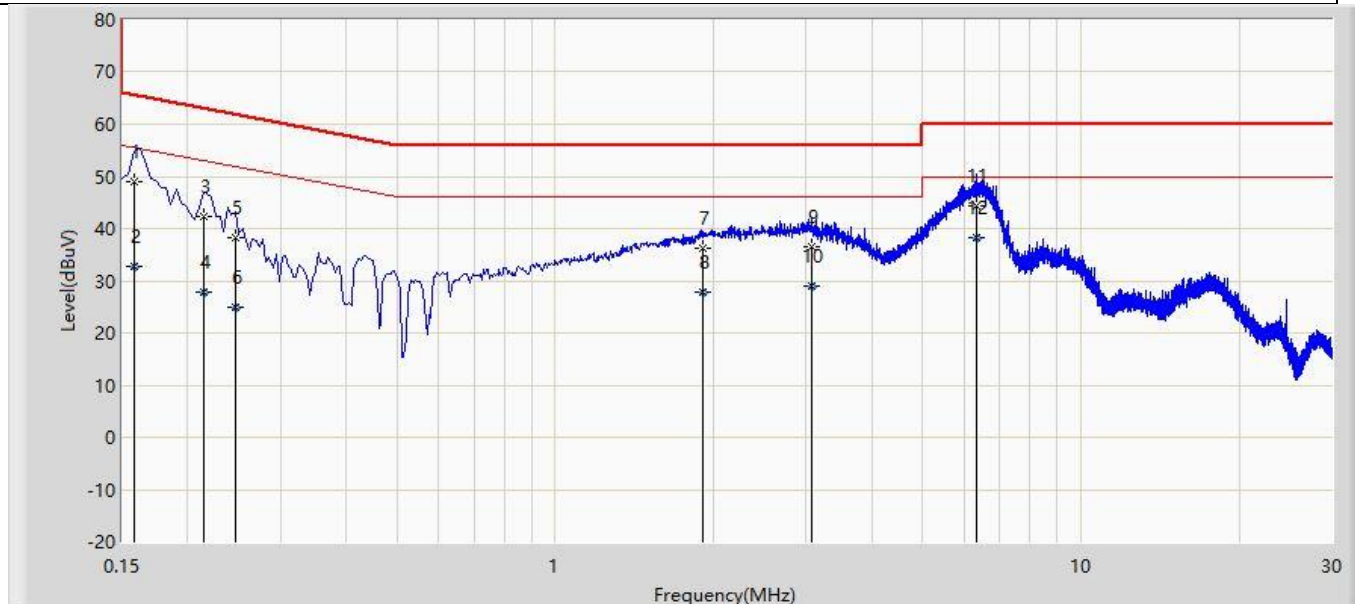

No	Mark	Frequency (MHz)	Measure Level (dBuV)	Reading Level (dBuV)	Over Limit (dB)	Limit (dBuV)	Probe (dB)	Cable (dB)	Amp (dB)	Type
1		0.158	48.989	39.387	-16.579	65.568	9.574	0.029	0.000	QP
2		0.158	32.630	23.027	-22.938	55.568	9.574	0.029	0.000	AV
3		0.214	42.180	32.560	-20.869	63.049	9.590	0.029	0.000	QP
4		0.214	27.779	18.160	-25.270	53.049	9.590	0.029	0.000	AV
5		0.246	38.283	28.660	-23.608	61.891	9.593	0.031	0.000	QP
6		0.246	25.031	15.408	-26.860	51.891	9.593	0.031	0.000	AV
7		1.910	36.167	26.452	-19.833	56.000	9.630	0.085	0.000	QP
8		1.910	27.764	18.049	-18.236	46.000	9.630	0.085	0.000	AV
9		3.082	36.430	26.661	-19.570	56.000	9.658	0.111	0.000	QP
10		3.082	28.881	19.111	-17.119	46.000	9.658	0.111	0.000	AV
11		6.346	44.247	34.329	-15.753	60.000	9.757	0.161	0.000	QP
12	*	6.346	38.314	28.396	-11.686	50.000	9.757	0.161	0.000	AV

Note:

1. All Readings below 1GHz are Quasi-Peak, above are performed with peak and/or average measurements as necessary.
2. " * ", means this data is the worst emission level.
3. Measurement Level = Reading Level + Factor(Probe+Cable-Amp).

4.2 Emissions in restricted frequency bands	VERDICT: PASS
--	----------------------

4.2.1 Limit			
Standard		FCC Part 15 Subpart C Paragraph 15.209	
Restricted Bands of operation			
Frequency (MHz)	Frequency (MHz)	Frequency (MHz)	Frequency (GHz)
0.090 – 0.110	16.42 – 16.423	399.9 – 410	4.5 – 5.15
0.495 – 0.505	16.69475 – 16.69525	608 – 614	5.35 – 5.46
2.1735 – 2.1905	16.80425 – 16.80475	960 – 1240	7.25 – 7.75
4.125 – 4.128	25.5 – 25.67	1300 – 1427	8.025 – 8.5
4.17725 – 4.17775	37.5 – 38.25	1435 – 1626.5	9.0 – 9.2
4.20725 – 4.20775	73 – 74.6	1645.5 – 1646.5	9.3 – 9.5
6.215 – 6.218	74.8 – 75.2	1660 – 1710	10.6 – 12.7
6.26775 – 6.26825	108 – 121.94	1718.8 – 1722.2	13.25 – 13.4
6.31175 – 6.31225	123 – 138	2200 – 2300	14.47 – 14.5
8.291 – 8.294	149.9 – 150.05	2310 – 2390	15.35 – 16.2
8.362 – 8.366	156.52475 – 156.52525	2483.5 – 2500	17.7 – 21.4
8.37625 – 8.38675	156.7 – 156.9	2690 – 2900	22.01 – 23.12
8.81425 – 8.81475	162.0125 – 167.17	3260 – 3267	23.6 – 24.0
12.29 – 12.293	167.72 – 173.2	3332 – 3339	31.2 – 31.8
12.51975 – 12.52025	240 – 285	3345.8 – 3358	36.43 – 36.5
12.57675 – 12.57725	322 – 335.4	3600 – 4400	
13.36 – 13.41			
Restricted Bands of operation for IC			
0.090 - 0.110	13.36 - 13.41	960 - 1427	9.0 - 9.2
0.495 - 0.505	16.42 - 16.423	1435 - 1626.5	9.3 - 9.5
2.1735 - 2.1905	16.69475 - 16.69525	1645.5 - 1646.5	10.6 - 12.7
3.020 - 3.026	16.80425 - 16.80475	1660 - 1710	13.25 - 13.4
4.125 - 4.128	25.5 - 25.67	1718.8 - 1722.2	14.47 - 14.5
4.17725 - 4.17775	37.5 - 38.25	2200 - 2300	15.35 - 16.2
4.20725 - 4.20775	73 - 74.6	2310 - 2390	17.7 - 21.4
5.677 - 5.683	74.8 - 75.2	2483.5 - 2500	22.01 - 23.12
6.215 - 6.218	108 - 138	2655 - 2900	23.6 - 24.0
6.26775 - 6.26825	149.9 - 150.05	3260 - 3267	31.2 - 31.8
6.31175 - 6.31225	156.52475 - 156.52525	3332 - 3339	36.43 - 36.5
8.291 - 8.294	156.7 - 156.9	3345.8 - 3358	Above 38.6
8.362 - 8.366	162.0125 - 167.17	3500 - 4400	
8.37625 - 8.38675	167.72 - 173.2	4500 - 5150	
8.41425 - 8.41475	240 - 285	5350 - 5460	
12.29 - 12.293	322 - 335.4	7250 - 7750	
12.51975 - 12.52025	399.9 - 410	8025 - 8500	
12.57675 - 12.57725	608 - 614	--	

Restricted Band Emissions Limit			
Frequency (MHz)	Field strength ($\mu\text{V/m}$)	Field strength ($\text{dB}\mu\text{V/m}$)	Measurement distance (m)
0.009 - 0.49	2400/F(kHz)	48.5 – 13.8	300 _(Note 1)
0.49 - 1.705	24000/F(kHz)	33.8 - 23	30 _(Note 1)
1.705 - 30	30	29.5	30 _(Note 1)
30 - 88	100	40	3 _(Note 2)
88 - 216	150	43.5	3 _(Note 2)
216 - 960	200	46	3 _(Note 2)
Above 960	500	54	3 _(Note 2)

Note 1: At frequencies below 30 MHz, measurements may be performed at a distance closer than that specified in the regulations; however, an attempt should be made to avoid making measurements in the near field. Pending the development of an appropriate measurement procedure for measurements performed below 30 MHz, when performing measurements at a closer distance than specified, the results shall be extrapolated to the specified distance by either making measurements at a minimum of two distances on at least one radial to determine the proper extrapolation factor or by using the square of an inverse linear distance extrapolation factor (40 dB/decade).

Note 2: At frequencies at or above 30 MHz, measurements may be performed at a distance other than what is specified provided: measurements are not made in the near field except where it can be shown that near field measurements are appropriate due to the characteristics of the device; and it can be demonstrated that the signal levels needed to be measured at the distance employed can be detected by the measurement equipment.

Measurements shall not be performed at a distance greater than 30 meters unless it can be further demonstrated that measurements at a distance of 30 meters or less are impractical. When performing measurements at a distance other than that specified, the results shall be extrapolated to the specified distance using an extrapolation factor of 20 dB/decade (inverse linear-distance for field strength measurements; inverse-linear-distance-squared for power density measurements).

4.2.2 Test Setup

30MHz-1GHz Test Setup:

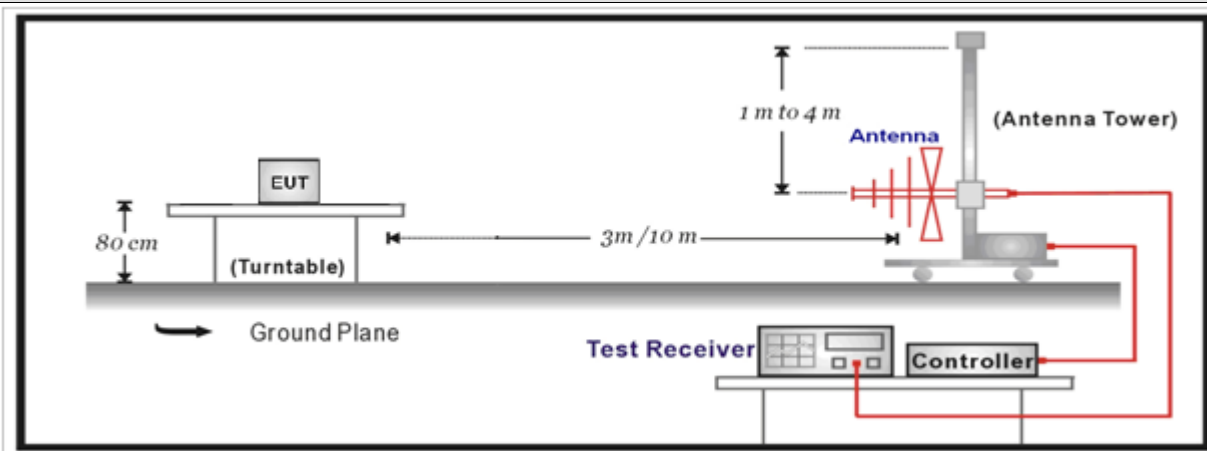

Above 1GHz Test Setup:

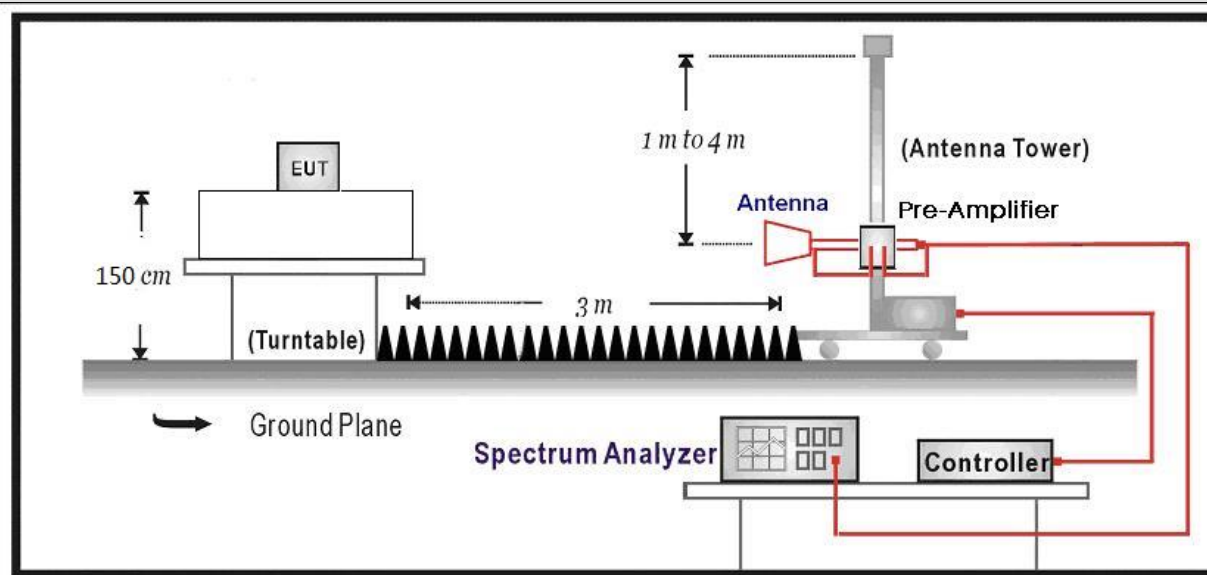

4.2.3 Test Procedure

	References Rule	Chapter	Description
<input checked="" type="checkbox"/>	ANSI C63.10	11.12	Emissions in restricted frequency bands
	<input checked="" type="checkbox"/> ANSI C63.10	11.12.1	Radiated emission measurements
	<input checked="" type="checkbox"/> ANSI C63.10	11.12.2.7	Radiated spurious emission test
	<input checked="" type="checkbox"/> ANSI C63.10	6.4	Radiated emissions from unlicensed wireless devices below 30 MHz
	<input checked="" type="checkbox"/> ANSI C63.10	6.5	Radiated emissions from unlicensed wireless devices in the frequency range of 30 MHz to 1000 MHz
	<input checked="" type="checkbox"/> ANSI C63.10	6.6	Radiated emissions from unlicensed wireless devices above 1 GHz

4.2.4 Test Data

Profile: 20C0553R	Page No.: 31
Engineer: Tongben	
Site: AC5	Time: 2021/01/11 - 23:57
Limit: FCC_Part15.209_RE(3m)	Margin: 0
Probe: Horn_3117_00167055(1-18GHz)	Polarity: Horizontal
EUT: LED Lamp	Power: AC 120V/60Hz
Note: Mode 1:Transmit at 2402MHz	

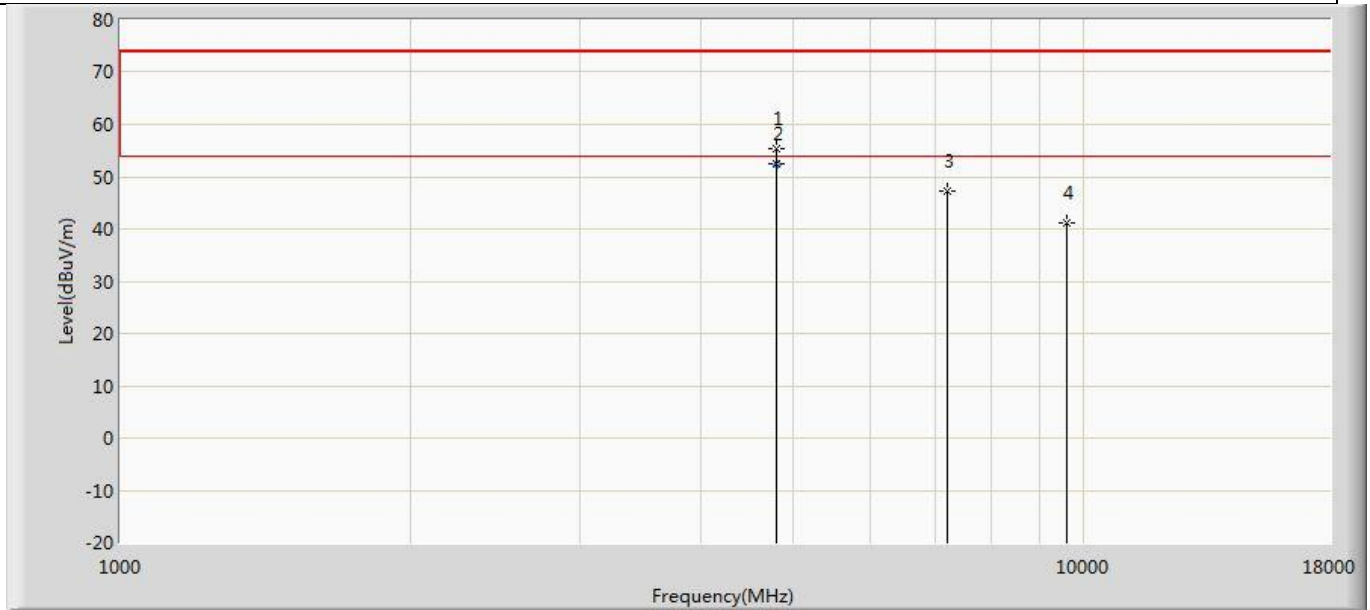

No	Mark	Frequency (MHz)	Measure Level (dBuV/m)	Reading Level (dBuV)	Over Limit (dB)	Limit (dBuV/m)	Factor (dB)	Type
1		4799.500	55.340	61.349	-18.660	74.000	-6.010	PK
2	*	4799.500	52.475	58.484	-1.525	54.000	-6.010	AV
3		7205.000	47.124	49.994	-26.876	74.000	-2.870	PK
4		9608.000	41.287	42.715	-32.713	74.000	-1.427	PK

Profile: 20C0553R	Page No.: 32
Engineer: Tongben	
Site: AC5	Time: 2021/01/11 - 23:57
Limit: FCC_Part15.209_RE(3m)	Margin: 0
Probe: Horn_3117_00167055(1-18GHz)	Polarity: Vertical
EUT: LED Lamp	Power: AC 120V/60Hz
Note: Mode 1:Transmit at 2402MHz	

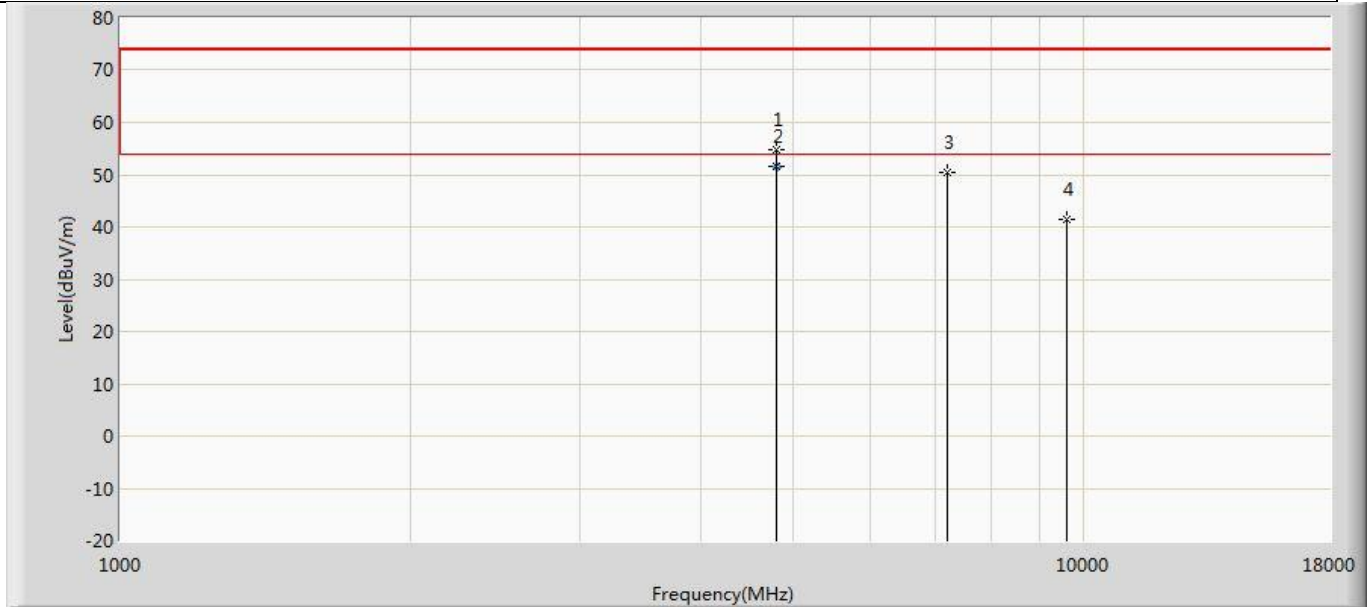

No	Mark	Frequency (MHz)	Measure Level (dBuV/m)	Reading Level (dBuV)	Over Limit (dB)	Limit (dBuV/m)	Factor (dB)	Type
1		4799.500	54.876	60.885	-19.124	74.000	-6.010	PK
2	*	4799.500	51.489	57.498	-2.511	54.000	-6.010	AV
3		7205.000	50.572	53.442	-23.428	74.000	-2.870	PK
4		9608.000	41.438	42.866	-32.562	74.000	-1.427	PK

Profile: 20C0553R	Page No.: 33
Engineer: Tongben	
Site: AC5	Time: 2021/01/11 - 23:57
Limit: FCC_Part15.209_RE(3m)	Margin: 0
Probe: Horn_3117_00167055(1-18GHz)	Polarity: Horizontal
EUT: LED Lamp	Power: AC 120V/60Hz
Note: Mode 1:Transmit at 2440MHz	

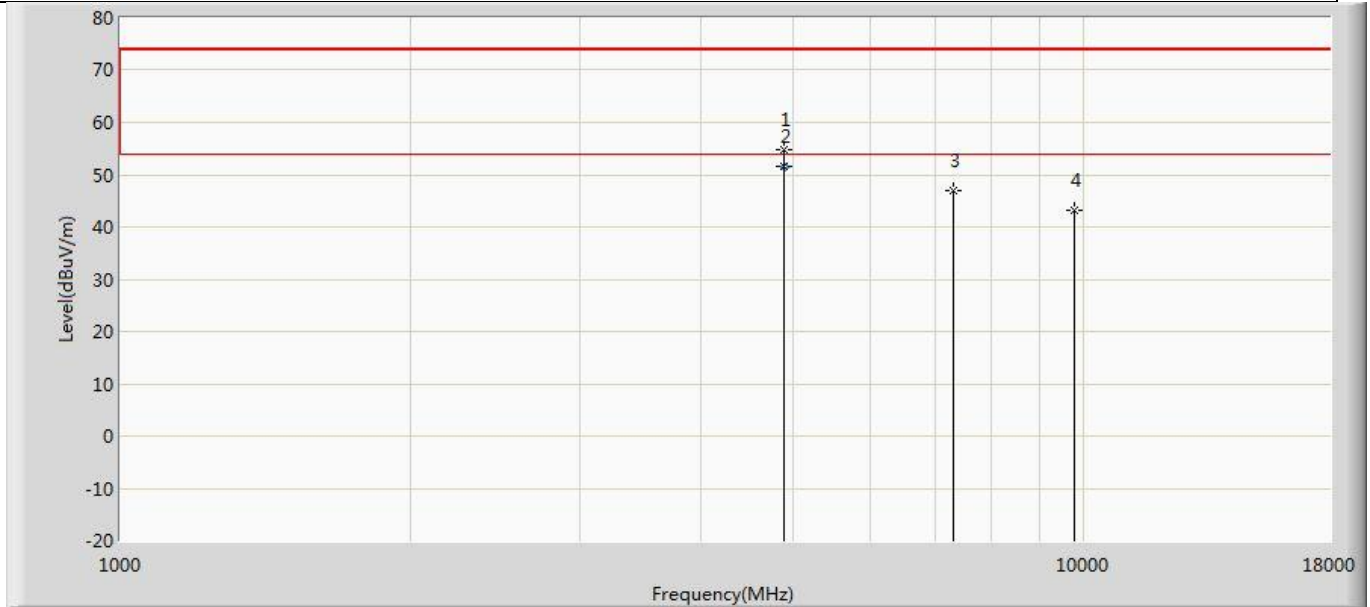

No	Mark	Frequency (MHz)	Measure Level (dBuV/m)	Reading Level (dBuV)	Over Limit (dB)	Limit (dBuV/m)	Factor (dB)	Type
1		4876.000	54.820	60.679	-19.180	74.000	-5.859	PK
2	*	4876.000	51.472	57.331	-2.528	54.000	-5.859	AV
3		7324.000	47.064	50.133	-26.936	74.000	-3.069	PK
4		9760.000	43.086	44.134	-30.914	74.000	-1.048	PK

Profile: 20C0553R	Page No.: 34
Engineer: Tongben	
Site: AC5	Time: 2021/01/11 - 23:57
Limit: FCC_Part15.209_RE(3m)	Margin: 0
Probe: Horn_3117_00167055(1-18GHz)	Polarity: Vertical
EUT: LED Lamp	Power: AC 120V/60Hz
Note: Mode 1:Transmit at 2440MHz	

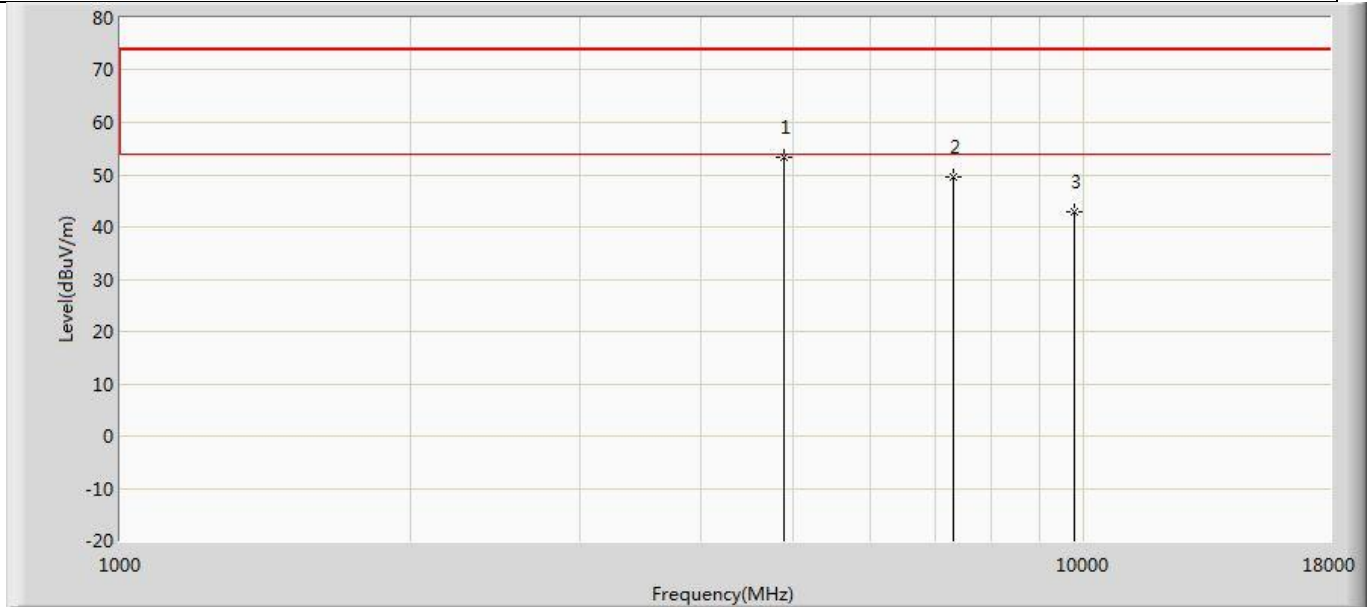

No	Mark	Frequency (MHz)	Measure Level (dBuV/m)	Reading Level (dBuV)	Over Limit (dB)	Limit (dBuV/m)	Factor (dB)	Type
1	*	4884.500	53.207	59.095	-20.793	74.000	-5.888	PK
2		7315.500	49.628	52.687	-24.372	74.000	-3.059	PK
3		9760.000	42.774	43.822	-31.226	74.000	-1.048	PK

Profile: 20C0553R	Page No.: 35
Engineer: Tongben	
Site: AC5	Time: 2021/01/11 - 23:58
Limit: FCC_Part15.209_RE(3m)	Margin: 0
Probe: Horn_3117_00167055(1-18GHz)	Polarity: Horizontal
EUT: LED Lamp	Power: AC 120V/60Hz
Note: Mode 1:Transmit at 2480MHz	

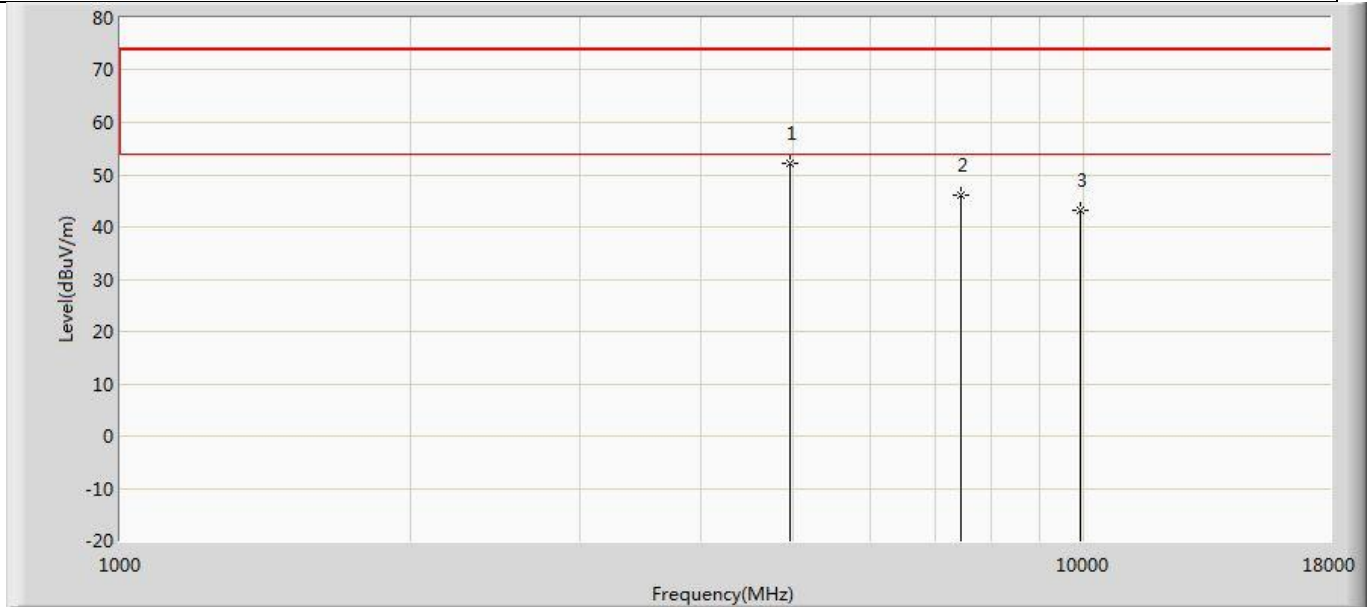

No	Mark	Frequency (MHz)	Measure Level (dBuV/m)	Reading Level (dBuV)	Over Limit (dB)	Limit (dBuV/m)	Factor (dB)	Type
1	*	4961.000	52.077	57.809	-21.923	74.000	-5.732	PK
2		7443.000	46.221	49.171	-27.779	74.000	-2.950	PK
3		9920.000	43.231	43.648	-30.769	74.000	-0.418	PK

Profile: 20C0553R	Page No.: 36
Engineer: Tongben	
Site: AC5	Time: 2021/01/11 - 23:58
Limit: FCC_Part15.209_RE(3m)	Margin: 0
Probe: Horn_3117_00167055(1-18GHz)	Polarity: Vertical
EUT: LED Lamp	Power: AC 120V/60Hz
Note: Mode 1:Transmit at 2480MHz	

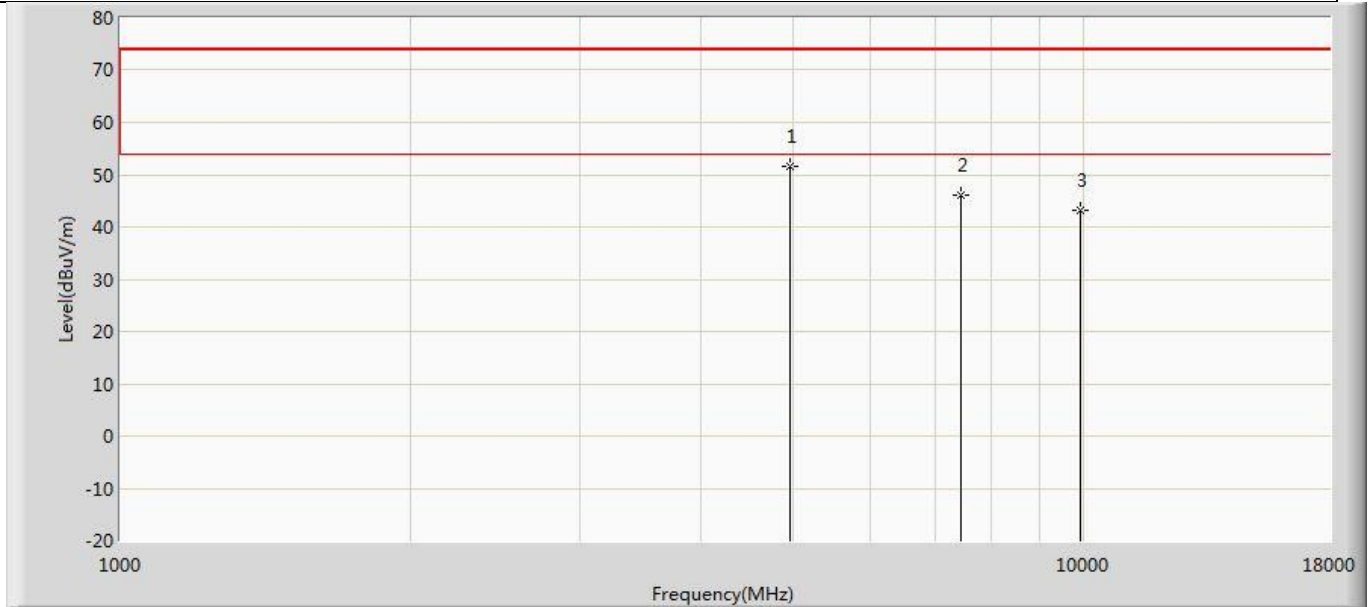

No	Mark	Frequency (MHz)	Measure Level (dBuV/m)	Reading Level (dBuV)	Over Limit (dB)	Limit (dBuV/m)	Factor (dB)	Type
1	*	4961.000	51.649	57.381	-22.351	74.000	-5.732	PK
2		7443.000	46.158	49.108	-27.842	74.000	-2.950	PK
3		9920.000	43.187	43.604	-30.813	74.000	-0.418	PK

Profile: 20C0553R	Page No.: 37
Engineer: Tongben	
Site: AC5	Time: 2021/01/11 - 23:58
Limit: FCC_Part15.209_RE(3m)	Margin: 0
Probe: Horn_3117_00167055(1-18GHz)	Polarity: Horizontal
EUT: LED Lamp	Power: AC 120V/60Hz
Note: Mode 2:Transmit at 2402MHz	

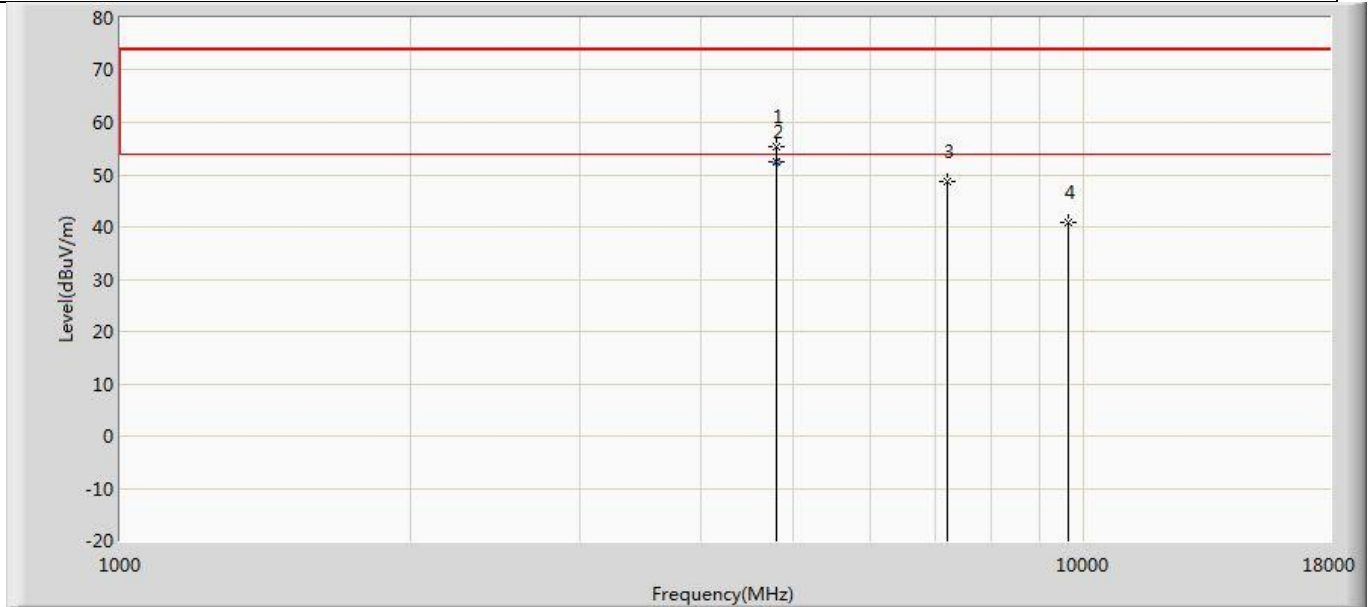

No	Mark	Frequency (MHz)	Measure Level (dBuV/m)	Reading Level (dBuV)	Over Limit (dB)	Limit (dBuV/m)	Factor (dB)	Type
1		4799.500	55.348	61.357	-18.652	74.000	-6.010	PK
2	*	4799.500	52.476	58.485	-1.524	54.000	-6.010	AV
3		7205.000	48.607	51.477	-25.393	74.000	-2.870	PK
4		9620.000	40.897	42.386	-33.103	74.000	-1.489	PK

Profile: 20C0553R	Page No.: 38
Engineer: Tongben	
Site: AC5	Time: 2021/01/11 - 23:58
Limit: FCC_Part15.209_RE(3m)	Margin: 0
Probe: Horn_3117_00167055(1-18GHz)	Polarity: Vertical
EUT: LED Lamp	Power: AC 120V/60Hz
Note: Mode 2:Transmit at 2402MHz	

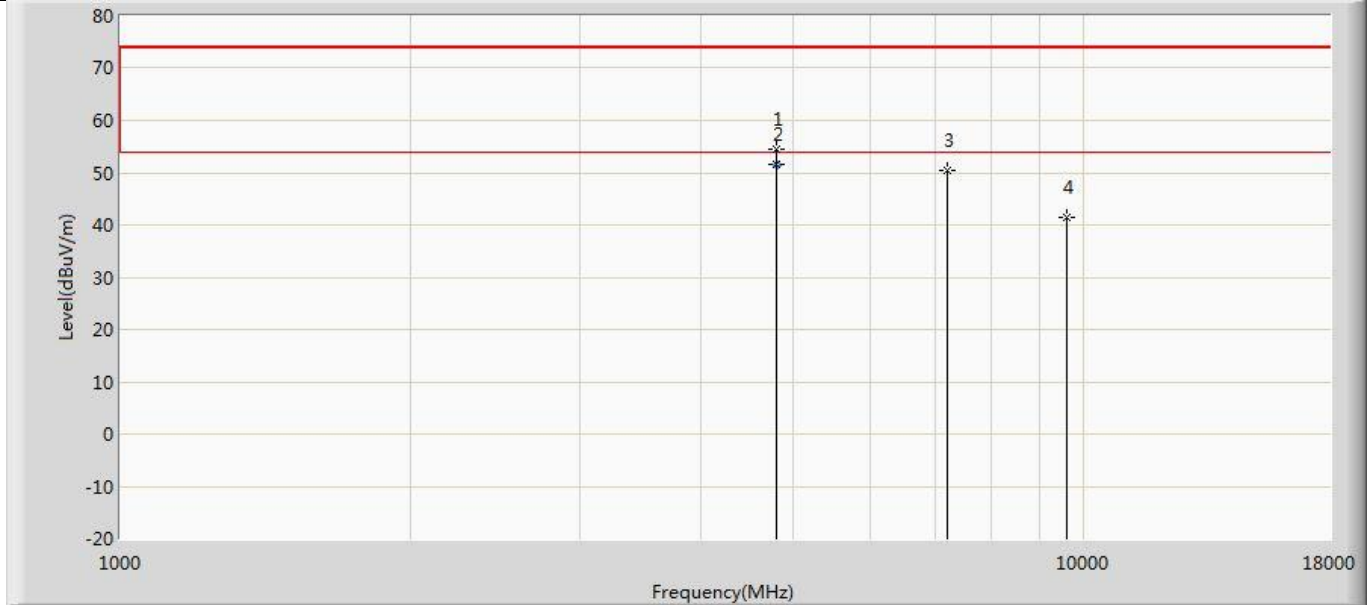

No	Mark	Frequency (MHz)	Measure Level (dBuV/m)	Reading Level (dBuV)	Over Limit (dB)	Limit (dBuV/m)	Factor (dB)	Type
1		4799.500	54.572	60.581	-19.428	74.000	-6.010	PK
2	*	4799.500	51.736	57.745	-2.264	54.000	-6.010	AV
3		7205.000	50.560	53.430	-23.440	74.000	-2.870	PK
4		9608.000	41.411	42.839	-32.589	74.000	-1.427	PK

Profile: 20C0553R	Page No.: 39
Engineer: Tongben	
Site: AC5	Time: 2021/01/11 - 23:58
Limit: FCC_Part15.209_RE(3m)	Margin: 0
Probe: Horn_3117_00167055(1-18GHz)	Polarity: Horizontal
EUT: LED Lamp	Power: AC 120V/60Hz
Note: Mode 2:Transmit at 2440MHz	

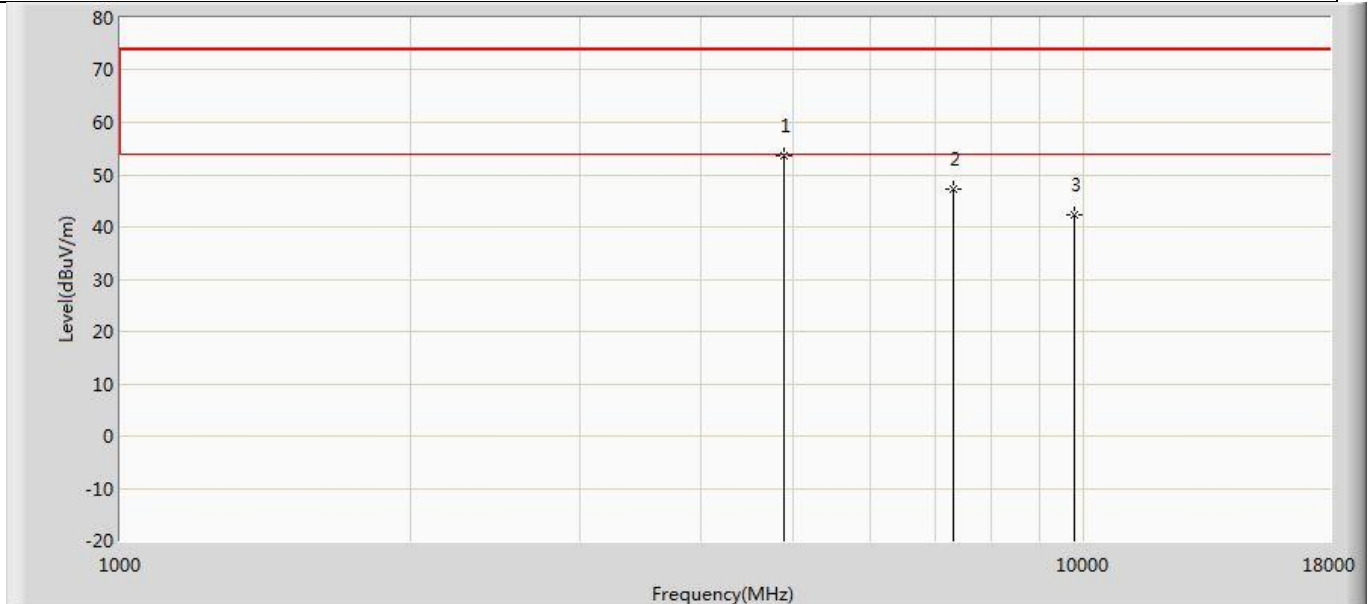

No	Mark	Frequency (MHz)	Measure Level (dBuV/m)	Reading Level (dBuV)	Over Limit (dB)	Limit (dBuV/m)	Factor (dB)	Type
1	*	4884.500	53.665	59.553	-20.335	74.000	-5.888	PK
2		7324.000	47.147	50.216	-26.853	74.000	-3.069	PK
3		9760.000	42.208	43.256	-31.792	74.000	-1.048	PK

Profile: 20C0553R	Page No.: 40
Engineer: Tongben	
Site: AC5	Time: 2021/01/11 - 23:58
Limit: FCC_Part15.209_RE(3m)	Margin: 0
Probe: Horn_3117_00167055(1-18GHz)	Polarity: Vertical
EUT: LED Lamp	Power: AC 120V/60Hz
Note: Mode 2:Transmit at 2440MHz	

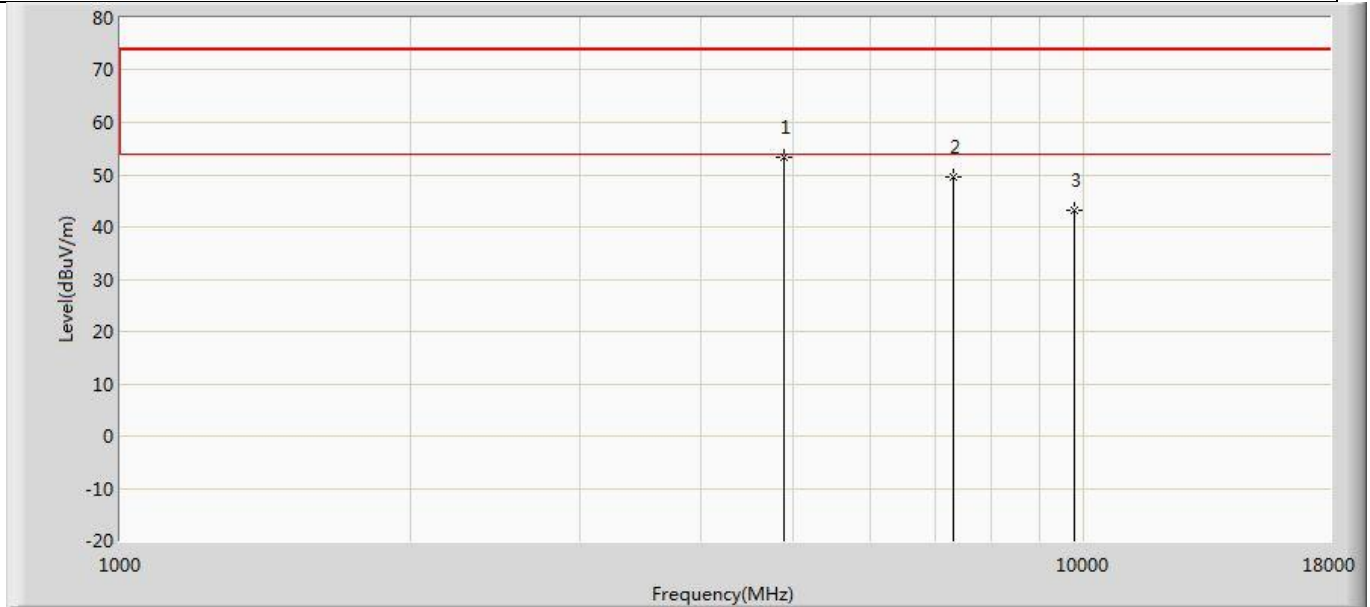

No	Mark	Frequency (MHz)	Measure Level (dBuV/m)	Reading Level (dBuV)	Over Limit (dB)	Limit (dBuV/m)	Factor (dB)	Type
1	*	4884.500	53.464	59.352	-20.536	74.000	-5.888	PK
2		7324.000	49.683	52.752	-24.317	74.000	-3.069	PK
3		9760.000	43.174	44.222	-30.826	74.000	-1.048	PK

Profile: 20C0553R	Page No.: 41
Engineer: Tongben	
Site: AC5	Time: 2021/01/11 - 23:58
Limit: FCC_Part15.209_RE(3m)	Margin: 0
Probe: Horn_3117_00167055(1-18GHz)	Polarity: Horizontal
EUT: LED Lamp	Power: AC 120V/60Hz
Note: Mode 2:Transmit at 2480MHz by	

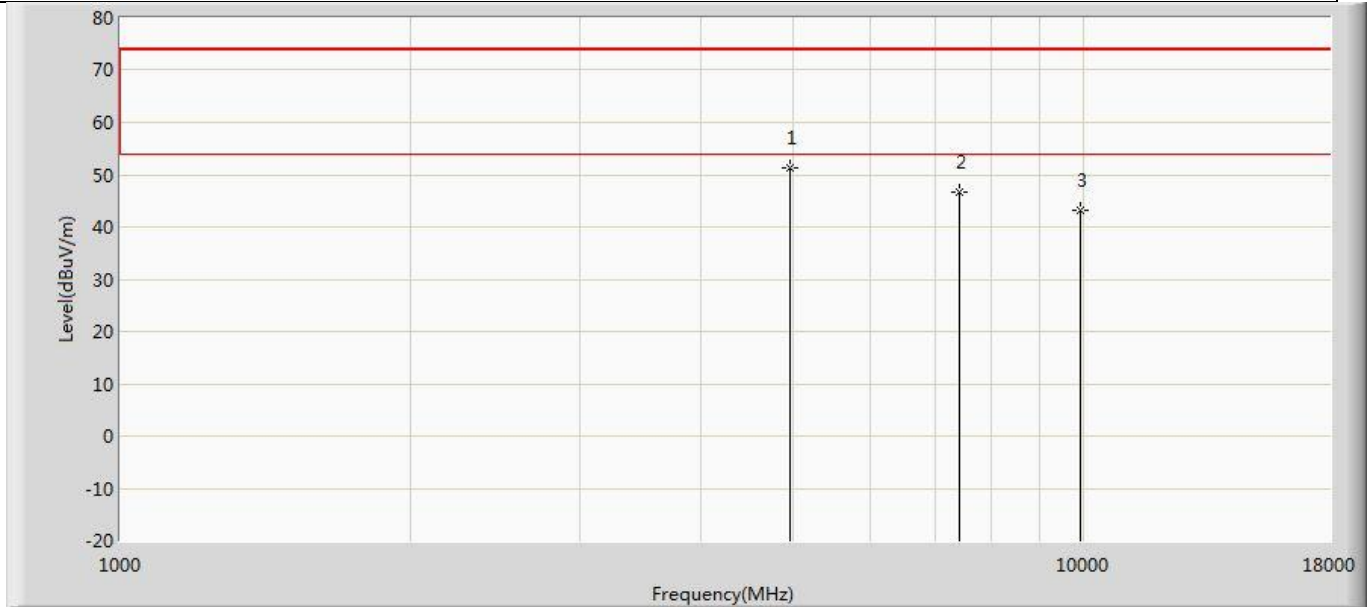

No	Mark	Frequency (MHz)	Measure Level (dBuV/m)	Reading Level (dBuV)	Over Limit (dB)	Limit (dBuV/m)	Factor (dB)	Type
1	*	4961.000	51.300	57.032	-22.700	74.000	-5.732	PK
2		7434.500	46.762	49.778	-27.238	74.000	-3.016	PK
3		9920.000	43.152	43.569	-30.848	74.000	-0.418	PK

Profile: 20C0553R	Page No.: 42
Engineer: Tongben	
Site: AC5	Time: 2021/01/11 - 23:58
Limit: FCC_Part15.209_RE(3m)	Margin: 0
Probe: Horn_3117_00167055(1-18GHz)	Polarity: Vertical
EUT: LED Lamp	Power: AC 120V/60Hz
Note: Mode 2:Transmit at 2480MHz	

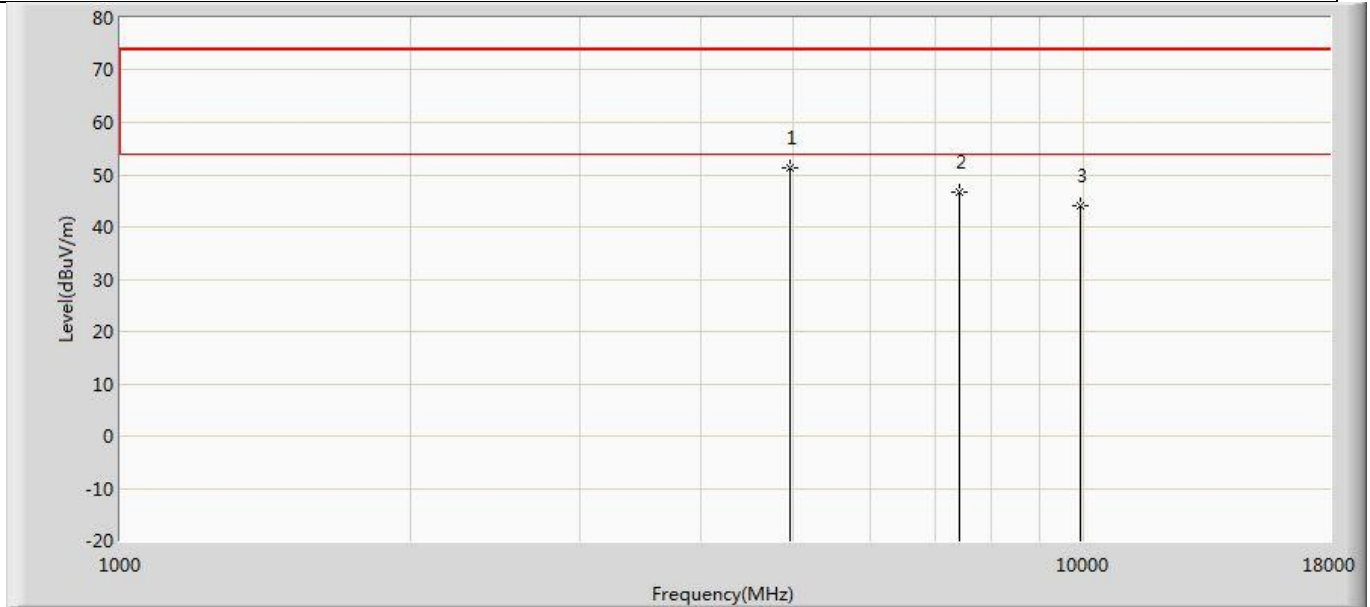

No	Mark	Frequency (MHz)	Measure Level (dBuV/m)	Reading Level (dBuV)	Over Limit (dB)	Limit (dBuV/m)	Factor (dB)	Type
1	*	4961.000	51.267	56.999	-22.733	74.000	-5.732	PK
2		7434.500	46.649	49.665	-27.351	74.000	-3.016	PK
3		9920.000	44.025	44.442	-29.975	74.000	-0.418	PK

Profile: 20C0553R	Page No.: 43
Engineer: Tongben	
Site: AC5	Time: 2021/01/11 - 23:58
Limit: FCC_Part15.209_RE(3m)	Margin: 0
Probe: Horn_3117_00167055(1-18GHz)	Polarity: Horizontal
EUT: LED Lamp	Power: AC 120V/60Hz
Note: Mode 3:Transmit at 2402MHz	

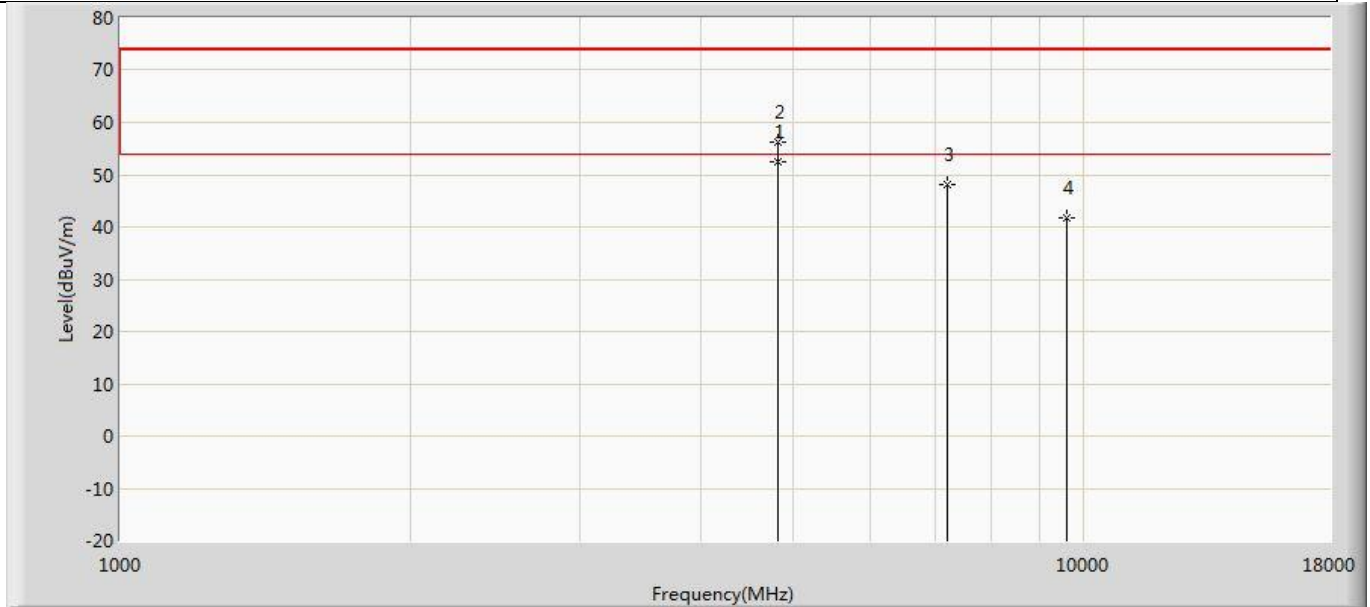

No	Mark	Frequency (MHz)	Measure Level (dBuV/m)	Reading Level (dBuV)	Over Limit (dB)	Limit (dBuV/m)	Factor (dB)	Type
1		4808.000	52.479	58.623	-21.521	74.000	-6.145	PK
2	*	4808.000	56.217	62.361	-17.783	74.000	-6.145	PK
3		7205.000	48.074	50.944	-25.926	74.000	-2.870	PK
4		9608.000	41.640	43.068	-32.360	74.000	-1.427	PK

Profile: 20C0553R	Page No.: 44
Engineer: Tongben	
Site: AC5	Time: 2021/01/11 - 23:58
Limit: FCC_Part15.209_RE(3m)	Margin: 0
Probe: Horn_3117_00167055(1-18GHz)	Polarity: Vertical
EUT: LED Lamp	Power: AC 120V/60Hz
Note: Mode 3:Transmit at 2402MHz	

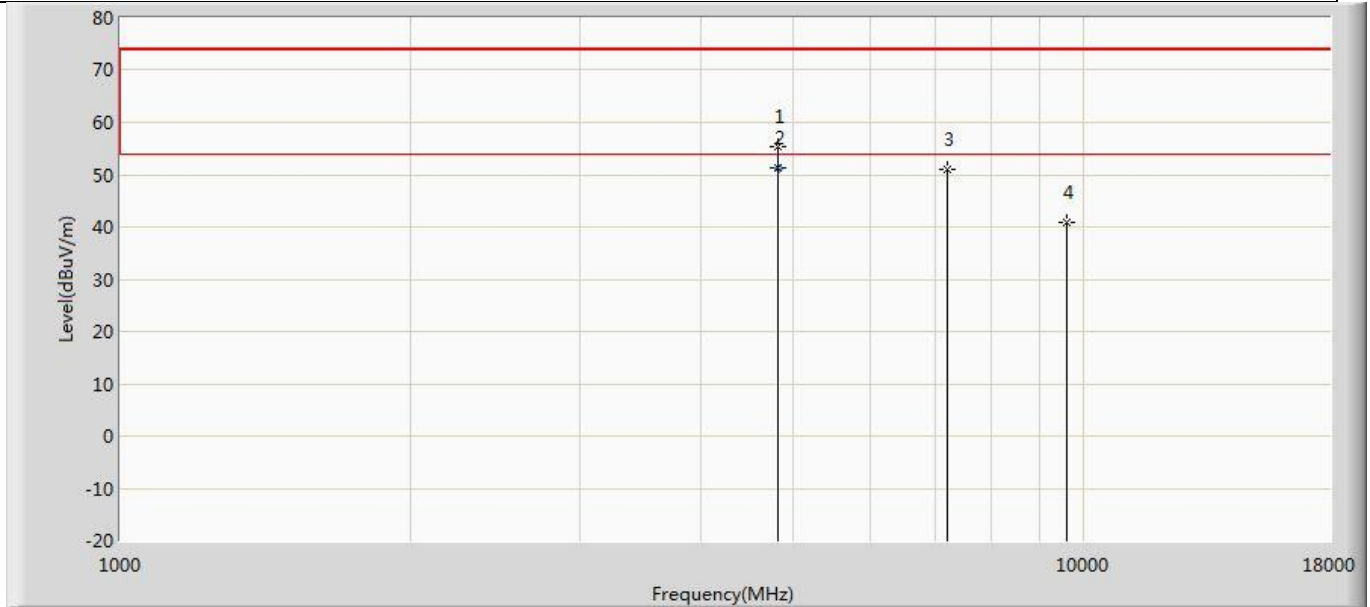

No	Mark	Frequency (MHz)	Measure Level (dBuV/m)	Reading Level (dBuV)	Over Limit (dB)	Limit (dBuV/m)	Factor (dB)	Type
1		4808.000	55.247	61.391	-18.753	74.000	-6.145	PK
2	*	4808.000	51.435	57.579	-2.565	54.000	-6.145	AV
3		7205.000	51.003	53.873	-22.997	74.000	-2.870	PK
4		9608.000	40.746	42.174	-33.254	74.000	-1.427	PK

Profile: 20C0553R	Page No.: 45
Engineer: Tongben	
Site: AC5	Time: 2021/01/11 - 23:59
Limit: FCC_Part15.209_RE(3m)	Margin: 0
Probe: Horn_3117_00167055(1-18GHz)	Polarity: Horizontal
EUT: LED Lamp	Power: AC 120V/60Hz
Note: Mode 3:Transmit at 2440MHz	

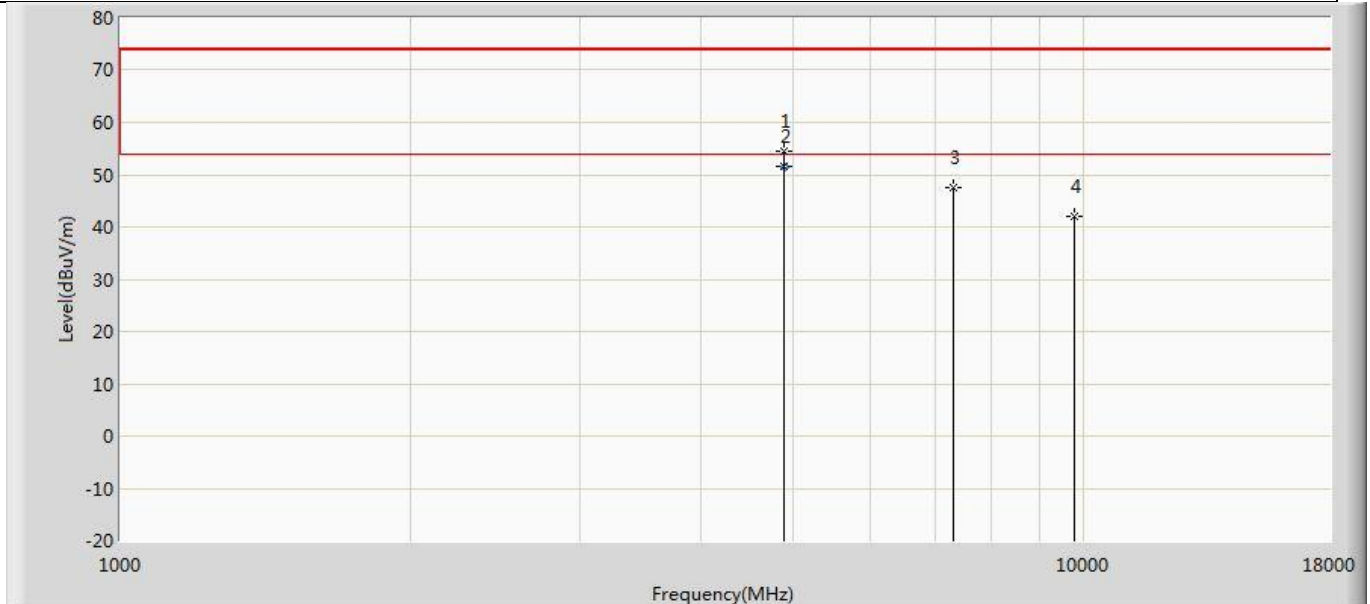

No	Mark	Frequency (MHz)	Measure Level (dBuV/m)	Reading Level (dBuV)	Over Limit (dB)	Limit (dBuV/m)	Factor (dB)	Type
1		4876.000	54.476	60.335	-19.524	74.000	-5.859	PK
2	*	4876.000	51.486	57.345	-2.514	54.000	-5.859	AV
3		7324.000	47.474	50.543	-26.526	74.000	-3.069	PK
4		9760.000	42.141	43.189	-31.859	74.000	-1.048	PK

Profile: 20C0553R	Page No.: 46
Engineer: Tongben	
Site: AC5	Time: 2021/01/11 - 23:59
Limit: FCC_Part15.209_RE(3m)	Margin: 0
Probe: Horn_3117_00167055(1-18GHz)	Polarity: Vertical
EUT: LED Lamp	Power: AC 120V/60Hz
Note: Mode 3:Transmit at 2440MHz	

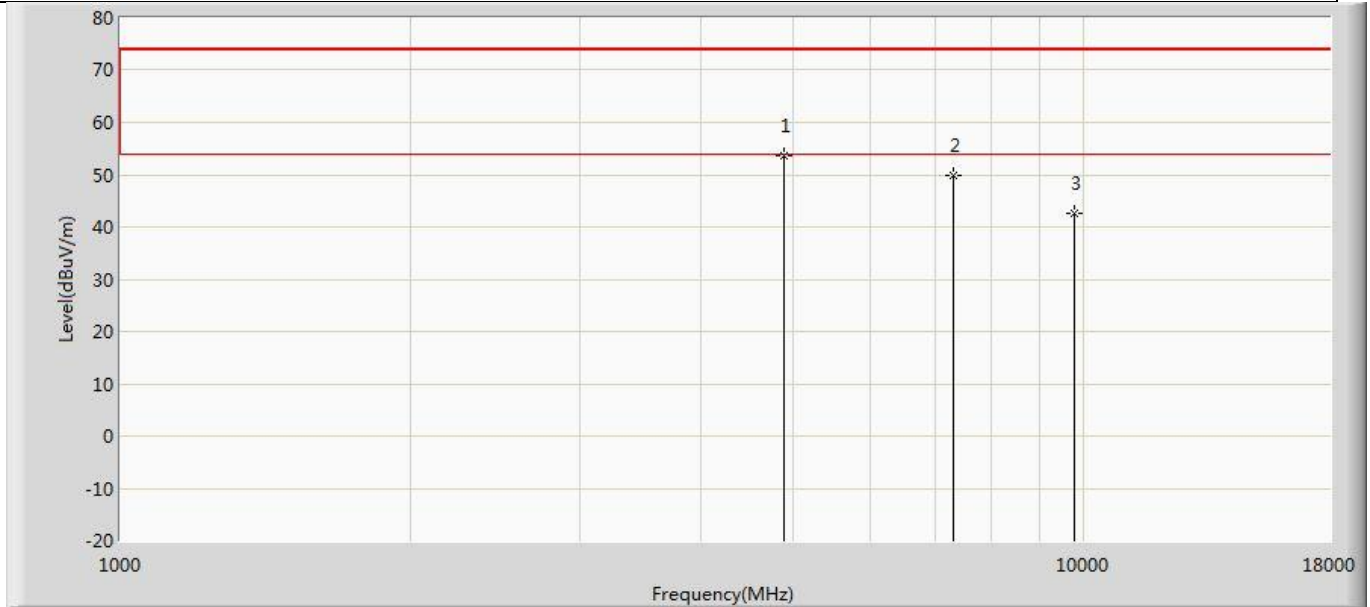

No	Mark	Frequency (MHz)	Measure Level (dBuV/m)	Reading Level (dBuV)	Over Limit (dB)	Limit (dBuV/m)	Factor (dB)	Type
1	*	4876.000	53.587	59.446	-20.413	74.000	-5.859	PK
2		7324.000	49.750	52.819	-24.250	74.000	-3.069	PK
3		9760.000	42.500	43.548	-31.500	74.000	-1.048	PK

Profile: 20C0553R	Page No.: 47
Engineer: Tongben	
Site: AC5	Time: 2021/01/11 - 23:59
Limit: FCC_Part15.209_RE(3m)	Margin: 0
Probe: Horn_3117_00167055(1-18GHz)	Polarity: Horizontal
EUT: LED Lamp	Power: AC 120V/60Hz
Note: Mode 3:Transmit at 2480MHz	

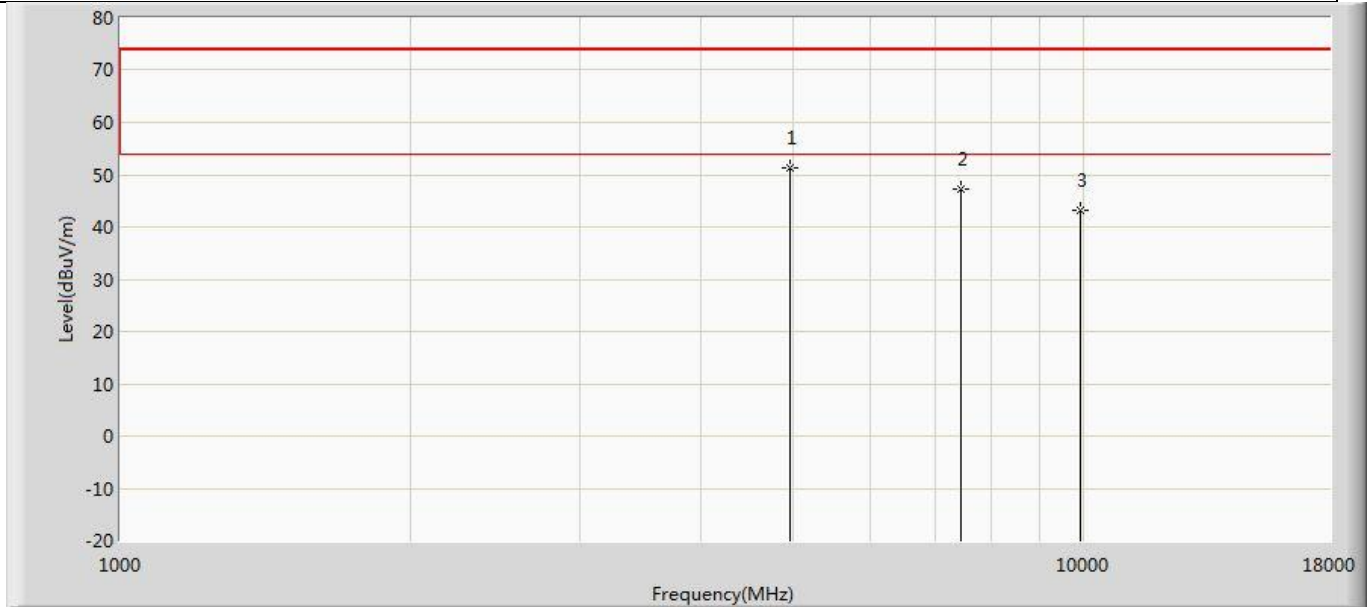

No	Mark	Frequency (MHz)	Measure Level (dBuV/m)	Reading Level (dBuV)	Over Limit (dB)	Limit (dBuV/m)	Factor (dB)	Type
1	*	4961.000	51.429	57.161	-22.571	74.000	-5.732	PK
2		7443.000	47.198	50.148	-26.802	74.000	-2.950	PK
3		9920.000	43.081	43.498	-30.919	74.000	-0.418	PK

Profile: 20C0553R	Page No.: 48
Engineer: Tongben	
Site: AC5	Time: 2021/01/11 - 23:59
Limit: FCC_Part15.209_RE(3m)	Margin: 0
Probe: Horn_3117_00167055(1-18GHz)	Polarity: Vertical
EUT: LED Lamp	Power: AC 120V/60Hz
Note: Mode 3:Transmit at 2480MHz	

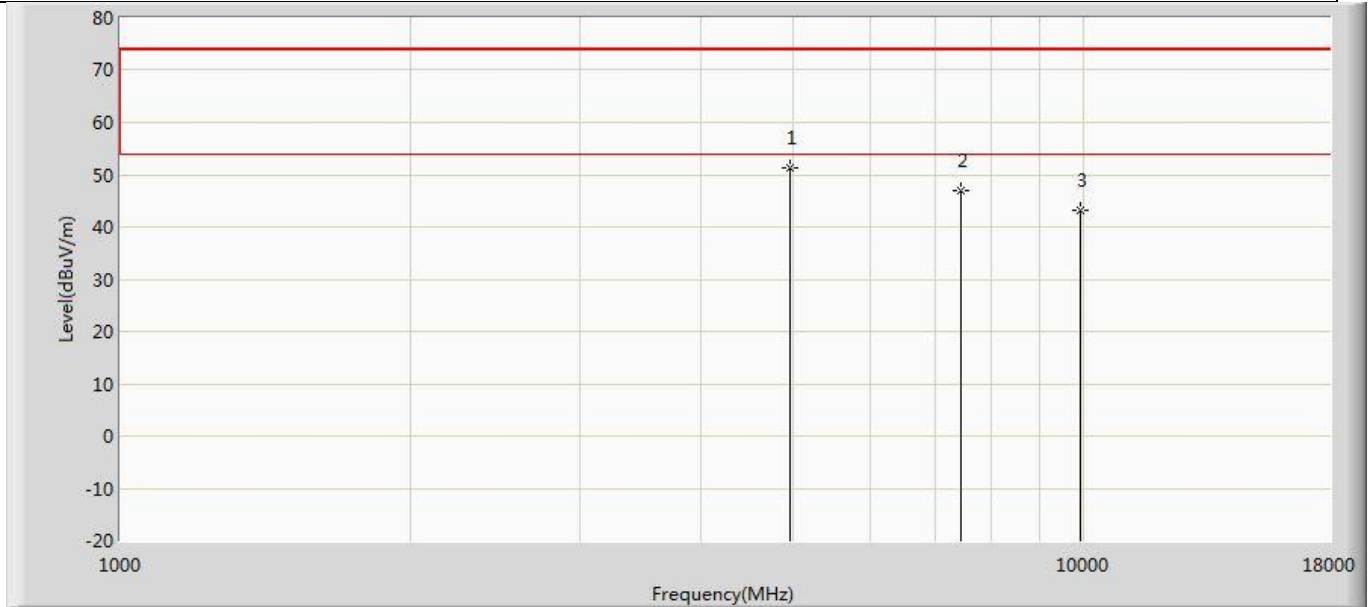

No	Mark	Frequency (MHz)	Measure Level (dBuV/m)	Reading Level (dBuV)	Over Limit (dB)	Limit (dBuV/m)	Factor (dB)	Type
1	*	4961.000	51.175	56.907	-22.825	74.000	-5.732	PK
2		7443.000	46.859	49.809	-27.141	74.000	-2.950	PK
3		9920.000	43.103	43.520	-30.897	74.000	-0.418	PK

Profile: 20C0553R	Page No.: 49
Engineer: Tongben	
Site: AC5	Time: 2021/01/11 - 23:59
Limit: FCC_Part15.209_RE(3m)	Margin: 0
Probe: Horn_3117_00167055(1-18GHz)	Polarity: Horizontal
EUT: LED Lamp	Power: AC 120V/60Hz
Note: Mode 4:Transmit at 2402MHz	

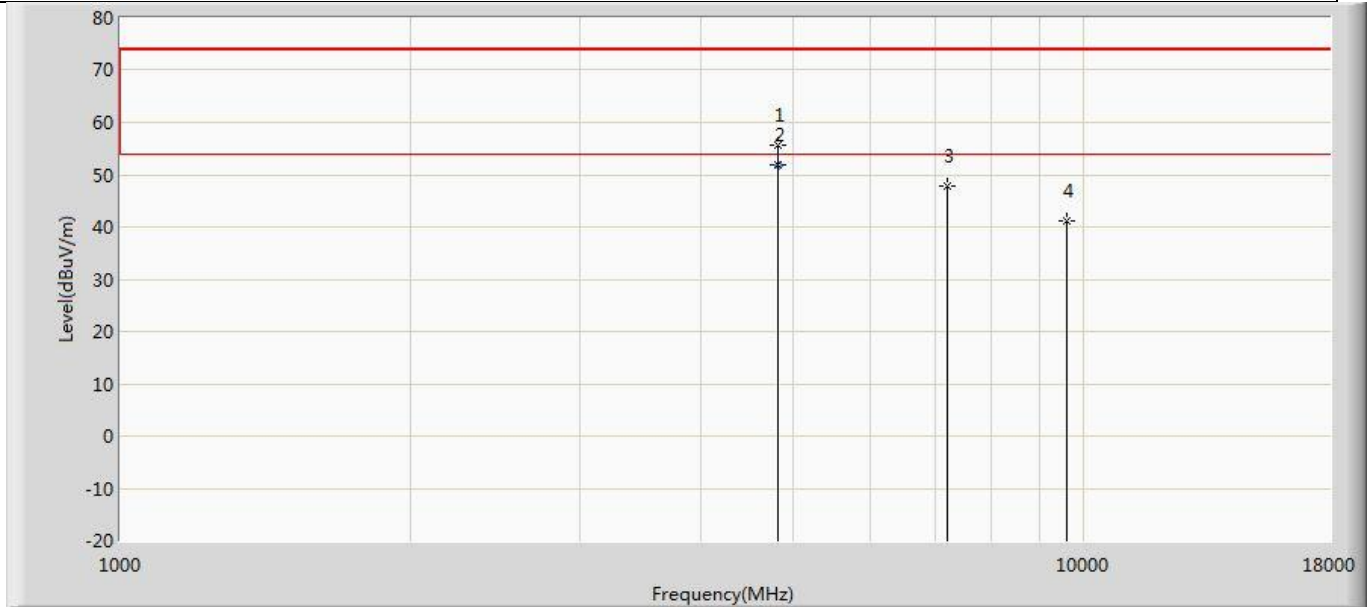

No	Mark	Frequency (MHz)	Measure Level (dBuV/m)	Reading Level (dBuV)	Over Limit (dB)	Limit (dBuV/m)	Factor (dB)	Type
1		4808.000	55.737	61.881	-18.263	74.000	-6.145	PK
2	*	4808.000	51.746	57.890	-2.254	54.000	-6.145	AV
3		7205.000	47.764	50.634	-26.236	74.000	-2.870	PK
4		9608.000	41.241	42.669	-32.759	74.000	-1.427	PK

Profile: 20C0553R	Page No.: 50
Engineer: Tongben	
Site: AC5	Time: 2021/01/11 - 23:59
Limit: FCC_Part15.209_RE(3m)	Margin: 0
Probe: Horn_3117_00167055(1-18GHz)	Polarity: Vertical
EUT: LED Lamp	Power: AC 120V/60Hz
Note: Mode 4:Transmit at 2402MHz	

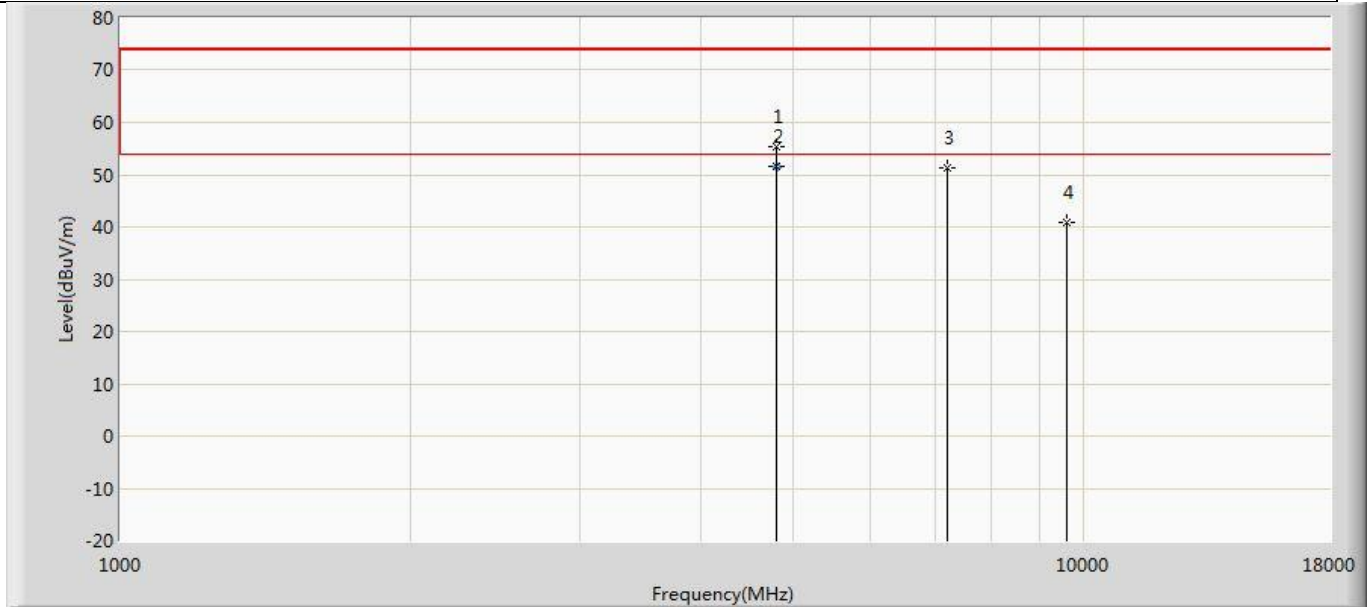

No	Mark	Frequency (MHz)	Measure Level (dBuV/m)	Reading Level (dBuV)	Over Limit (dB)	Limit (dBuV/m)	Factor (dB)	Type
1		4799.500	55.386	61.395	-18.614	74.000	-6.010	PK
2	*	4799.500	51.648	57.657	-2.352	54.000	-6.010	AV
3		7205.000	51.194	54.064	-22.806	74.000	-2.870	PK
4		9608.000	40.968	42.396	-33.032	74.000	-1.427	PK

Profile: 20C0553R	Page No.: 51
Engineer: Tongben	
Site: AC5	Time: 2021/01/11 - 23:59
Limit: FCC_Part15.209_RE(3m)	Margin: 0
Probe: Horn_3117_00167055(1-18GHz)	Polarity: Horizontal
EUT: LED Lamp	Power: AC 120V/60Hz
Note: Mode 4:Transmit at 2440MHz	

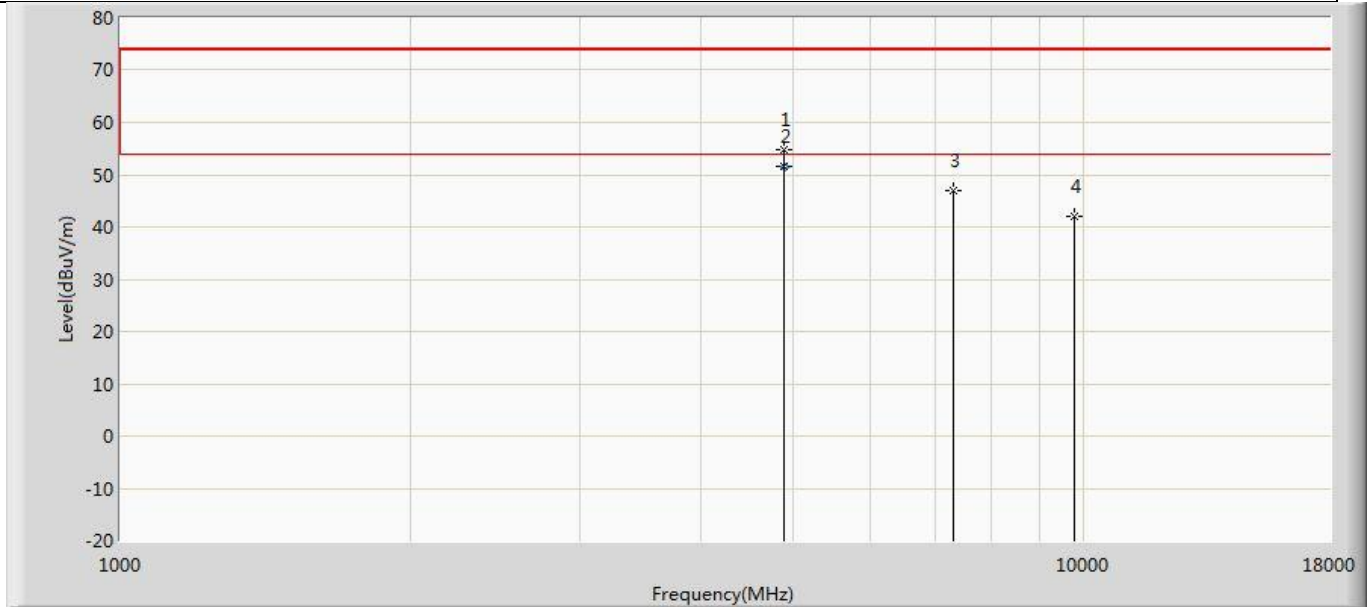

No	Mark	Frequency (MHz)	Measure Level (dBuV/m)	Reading Level (dBuV)	Over Limit (dB)	Limit (dBuV/m)	Factor (dB)	Type
1		4884.500	54.884	60.772	-19.116	74.000	-5.888	PK
2	*	4884.500	51.649	57.537	-2.351	54.000	-5.888	AV
3		7315.500	46.967	50.026	-27.033	74.000	-3.059	PK
4		9760.000	41.897	42.945	-32.103	74.000	-1.048	PK

Profile: 20C0553R	Page No.: 52
Engineer: Tongben	
Site: AC5	Time: 2021/01/11 - 23:59
Limit: FCC_Part15.209_RE(3m)	Margin: 0
Probe: Horn_3117_00167055(1-18GHz)	Polarity: Vertical
EUT: LED Lamp	Power: AC 120V/60Hz
Note: Mode 4:Transmit at 2440MHz	

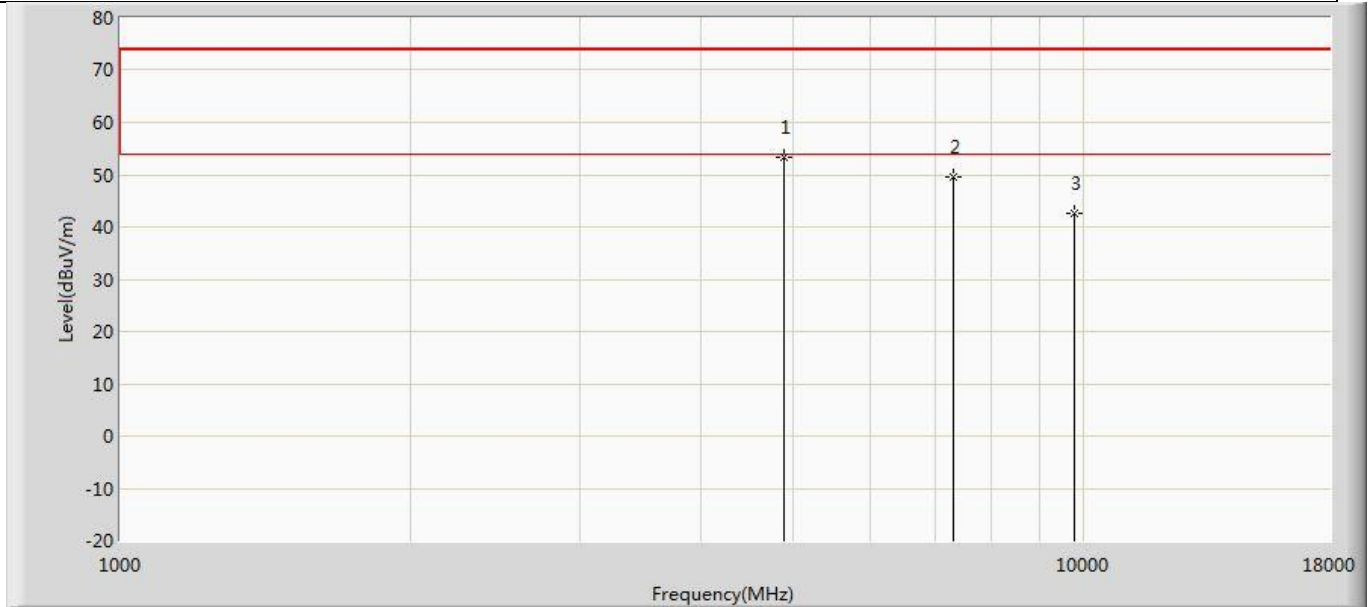

No	Mark	Frequency (MHz)	Measure Level (dBuV/m)	Reading Level (dBuV)	Over Limit (dB)	Limit (dBuV/m)	Factor (dB)	Type
1	*	4884.500	53.403	59.291	-20.597	74.000	-5.888	PK
2		7315.500	49.573	52.632	-24.427	74.000	-3.059	PK
3		9760.000	42.482	43.530	-31.518	74.000	-1.048	PK

Profile: 20C0553R	Page No.: 53
Engineer: Tongben	
Site: AC5	Time: 2021/01/11 - 23:59
Limit: FCC_Part15.209_RE(3m)	Margin: 0
Probe: Horn_3117_00167055(1-18GHz)	Polarity: Horizontal
EUT: LED Lamp	Power: AC 120V/60Hz
Note: Mode 4:Transmit at 2480MHz	

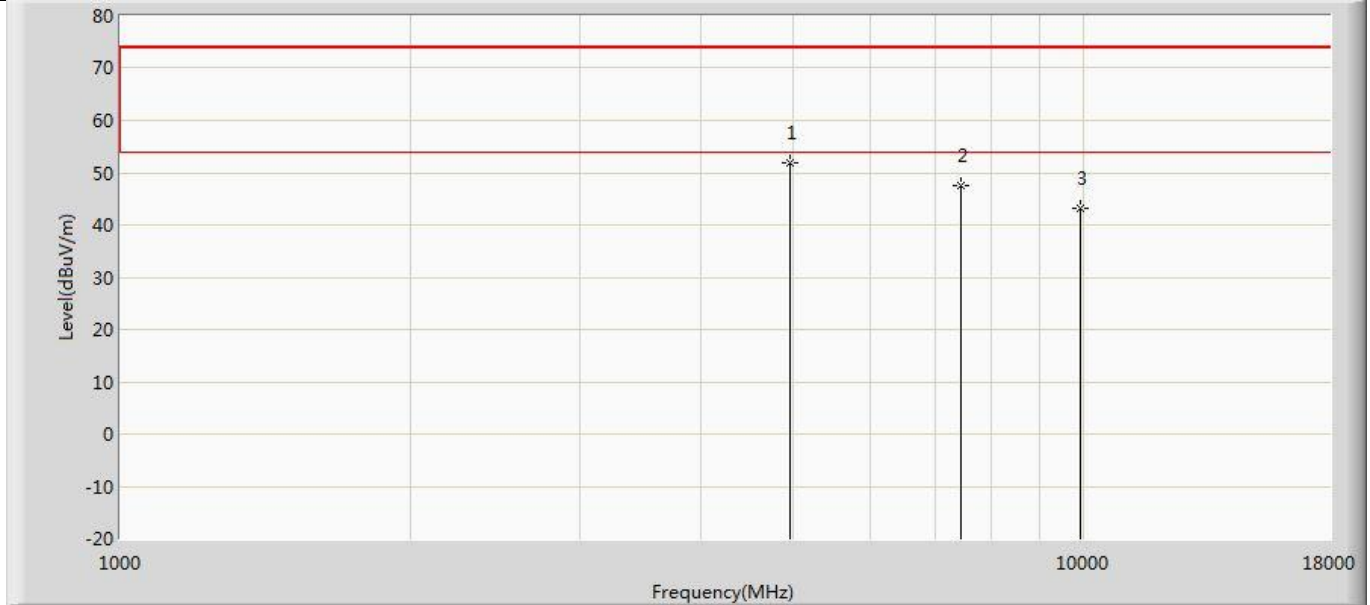

No	Mark	Frequency (MHz)	Measure Level (dBuV/m)	Reading Level (dBuV)	Over Limit (dB)	Limit (dBuV/m)	Factor (dB)	Type
1	*	4961.000	51.980	57.712	-22.020	74.000	-5.732	PK
2		7443.000	47.431	50.381	-26.569	74.000	-2.950	PK
3		9920.000	43.142	43.559	-30.858	74.000	-0.418	PK

Profile: 20C0553R	Page No.: 54
Engineer: Tongben	
Site: AC5	Time: 2021/01/12 - 00:00
Limit: FCC_Part15.209_RE(3m)	Margin: 0
Probe: Horn_3117_00167055(1-18GHz)	Polarity: Vertical
EUT: LED Lamp	Power: AC 120V/60Hz
Note: Mode 4:Transmit at 2480MHz	

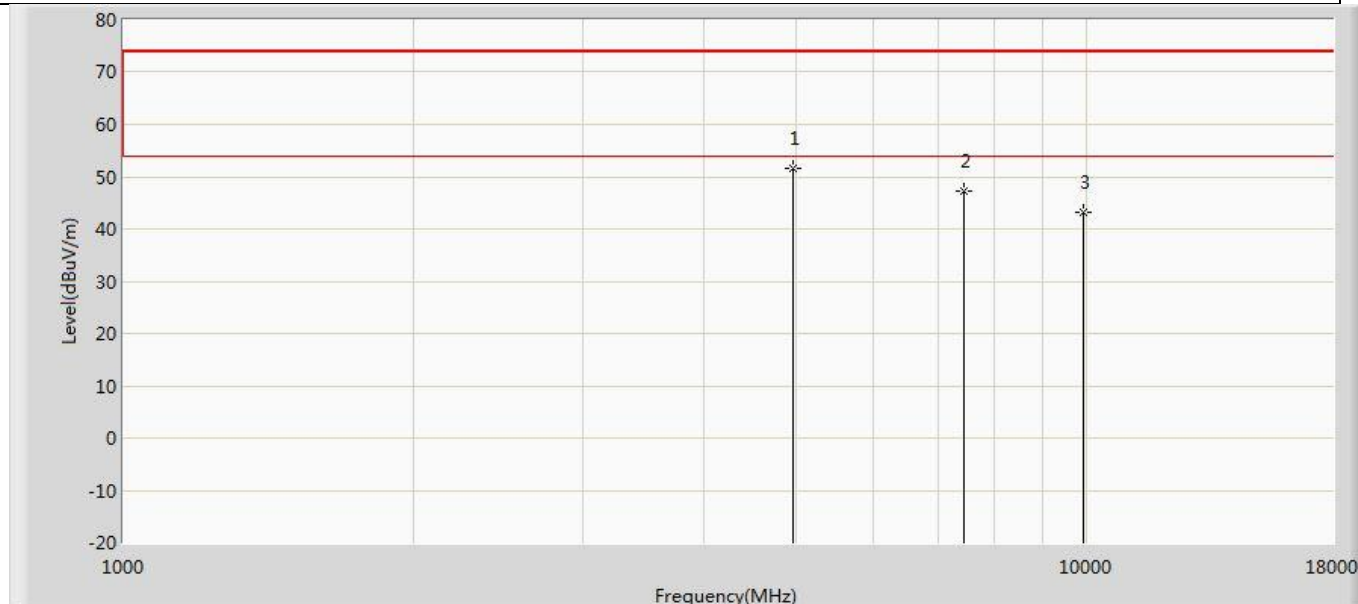

No	Mark	Frequency (MHz)	Measure Level (dBuV/m)	Reading Level (dBuV)	Over Limit (dB)	Limit (dBuV/m)	Factor (dB)	Type
1	*	4961.000	51.618	57.350	-22.382	74.000	-5.732	PK
2		7443.000	47.106	50.056	-26.894	74.000	-2.950	PK
3		9920.000	43.182	43.599	-30.818	74.000	-0.418	PK

Note:

1. Measured Level = Reading Level + Factor.
2. The test frequency range, 9kHz~30MHz, 18GHz~26GHz, both of the worst case are at least 20dB below the limits, therefore no data appear in the report.
3. This limit applies for using average detector, if the test result on peak is lower than average limit, then average measurement needn't be performed.
4. As the radiated emission was performed, so conducted emission was not tested.

The worst case of Radiated Emission below 1GHz:

Engineer: YULIU	
Site: AC2	Time: 2021/01/10 - 15:56
Limit: FCC_Part15.209_RE(3m)	Margin: 0
Probe: SuZ-2141	Polarity: Horizontal
EUT: LED Lamp	Power: AC 120V/60Hz
Note: Mode 1	

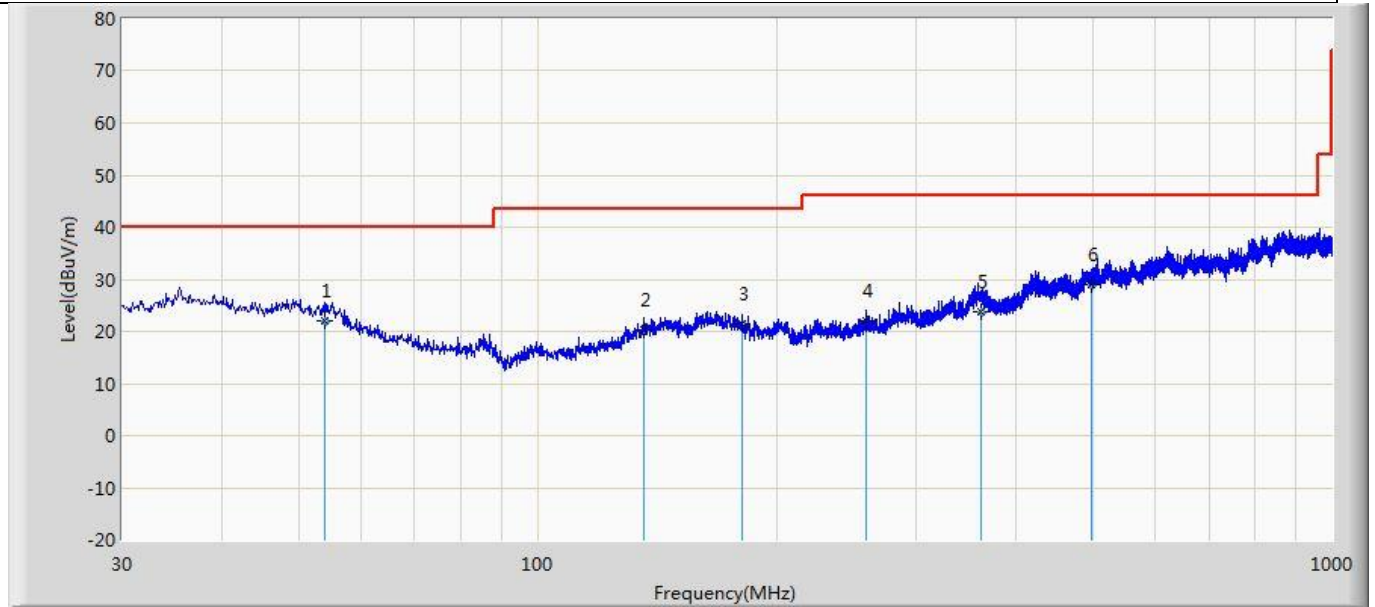

No	Mark	Frequency (MHz)	Measure Level (dBuV/m)	Reading Level (dBuV)	Over Limit (dB)	Limit (dBuV/m)	Factor (dB)	Type
1		53.886	22.164	1.284	-17.836	40.000	20.879	QP
2		136.215	20.347	3.112	-23.153	43.500	17.235	QP
3		181.077	21.485	3.058	-22.015	43.500	18.427	QP
4		259.041	21.958	3.425	-24.042	46.000	18.533	QP
5		361.376	23.845	-0.967	-22.155	46.000	24.812	QP
6	*	497.176	28.967	1.016	-17.033	46.000	27.951	QP

Engineer: YULIU	
Site: AC2	Time: 2020/01/10 - 16:05
Limit: FCC_Part15.209_RE(3m)	Margin: 0
Probe: SuZ-2141	Polarity: Vertical
EUT: LED Lamp	Power: AC 120V/60Hz
Note: Mode 1	

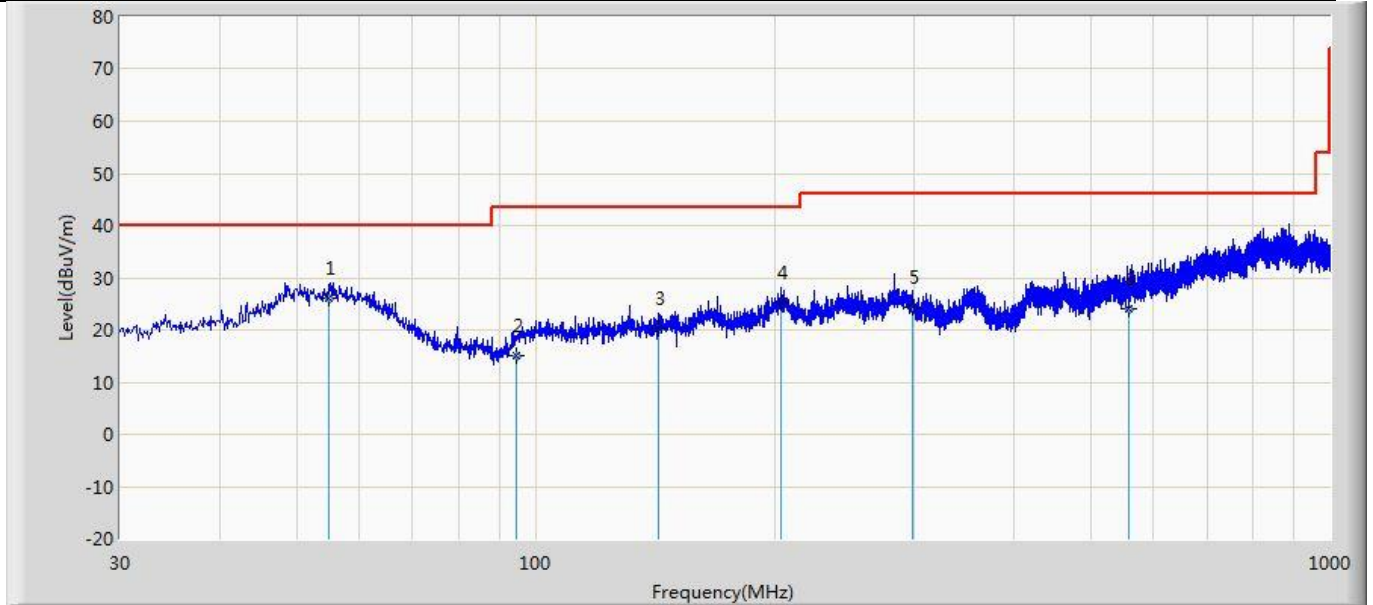

No	Mark	Frequency (MHz)	Measure Level (dBuV/m)	Reading Level (dBuV)	Over Limit (dB)	Limit (dBuV/m)	Factor (dB)	Type
1	*	54.978	26.154	1.213	-13.846	40.000	24.941	QP
2		94.747	15.164	-1.741	-28.336	43.500	16.905	QP
3		142.884	20.165	1.249	-23.335	43.500	18.916	QP
4		203.630	25.147	0.722	-18.353	43.500	24.425	QP
5		298.690	24.347	1.206	-21.653	46.000	23.141	QP
6		558.407	24.176	-3.403	-21.824	46.000	27.579	QP

Note:

1. All Readings below 1GHz are Quasi-Peak, above are performed with peak and/or average measurements as necessary.
2. " * ", means this data is the worst emission level.
3. Measurement Level = Reading Level + Factor(Probe+Cable-Amp).

4.3 Emissions in non-restricted frequency band	VERDICT: PASS
---	----------------------

4.3.1 Limit	
Standard	FCC Part 15 Subpart C Paragraph 15.247(d)
RF Output power (Detection methods)	Limit(dB)
RF Output power(Average detector)	30dBc(Note1)
RF Output power(PK detector)	20dBc(Note2)
<p>Note 1: If maximum conducted (average) output power was used to demonstrate compliance as described in 9.2, then the peak power in any 100 kHz bandwidth outside of the authorized frequency band shall be attenuated by at least 30 dB relative to the maximum in-band peak PSD level in 100 kHz (i.e., 30 dBc).</p> <p>Note 2: If the maximum peak conducted output power procedure was used, then the peak output power measured in any 100 kHz bandwidth outside of the authorized frequency band shall be attenuated by at least 20 dB relative to the maximum in-band peak PSD level in 100 kHz (i.e., 20 dBc).</p>	

4.3.2 Test Setup

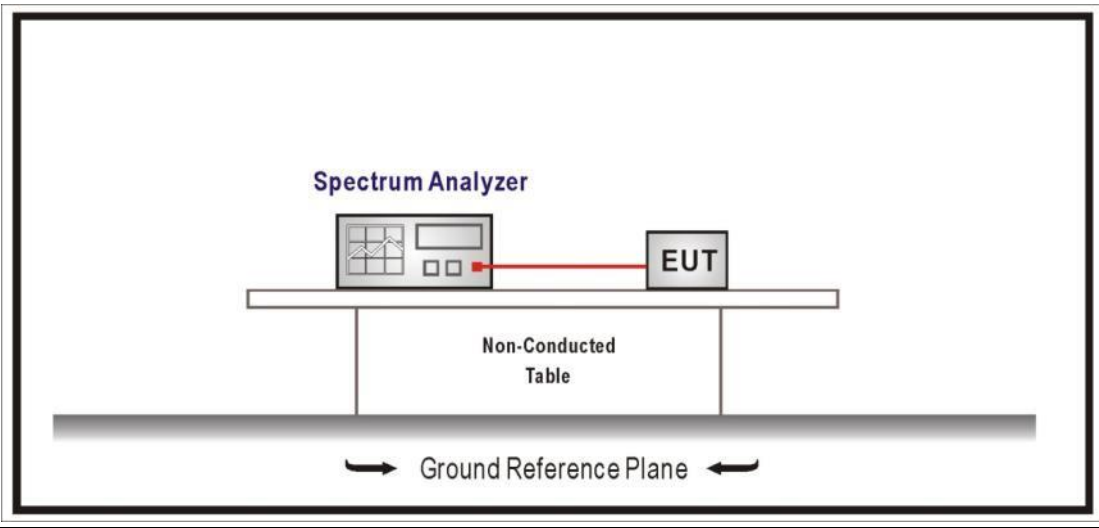

4.3.3 Test Procedure			
-----------------------------	--	--	--

References Rule	Chapter	Description
<input checked="" type="checkbox"/> ANSI C63.10	11.11	Emissions in non-restricted frequency bands
<input checked="" type="checkbox"/> ANSI C63.10	11.11.1	General
<input checked="" type="checkbox"/> ANSI C63.10	11.11.2	Reference level measurement
<input checked="" type="checkbox"/> ANSI C63.10	11.11.3	Emission level measurement

4.3.4 Test Data

Mode	Channel	Test Frequency (MHz)	Maximum In-Band PSD[a] (dBm/100kHz)	Frequency (MHz)	Out-Band PSD[b] (dBm/100kHz)	[a]-[b] (dB)	Limit (dB)	Result
1	00	2402	8.324	2400	-44.059	52.383	>20	Pass
	39	2480	7.592	2518.484	-56.097	63.689	>20	Pass
2	00	2402	6.397	2400	-23.965	30.362	>20	Pass
	39	2480	5.538	2517.828	-59.694	65.232	>20	Pass
3	00	2402	8.335	2400	-43.183	51.518	>20	Pass
	39	2480	7.513	2518.672	-55.802	63.315	>20	Pass
4	00	2402	5.684	2400	-42.800	48.484	>20	Pass
	39	2480	4.822	2518.094	-58.077	62.899	>20	Pass

Note 1: The worst data plot as below:

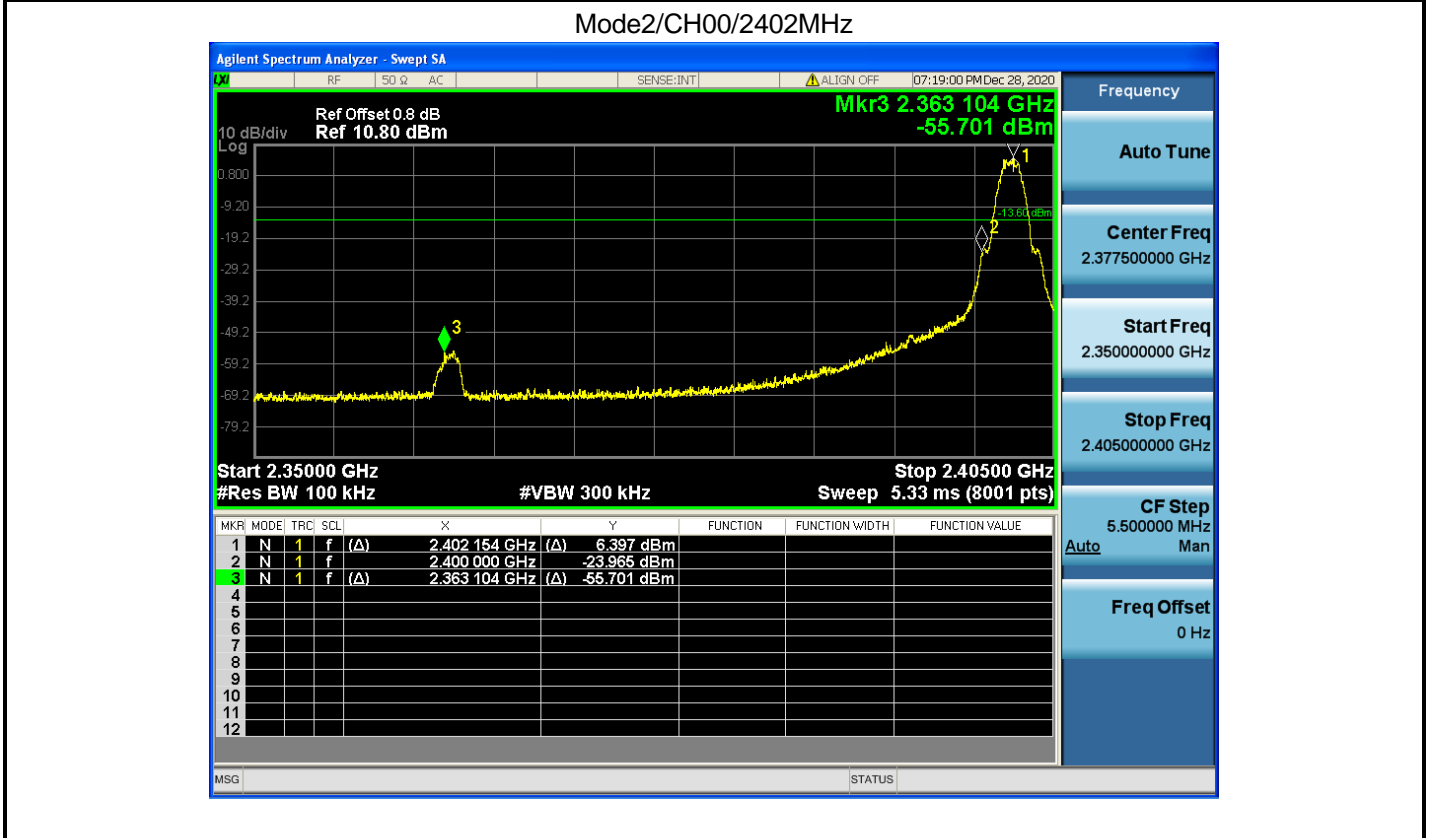

4.4 Duty cycle	VERDICT: PASS
-----------------------	----------------------

4.4.1 Limit
N/A

4.4.2 Test Setup

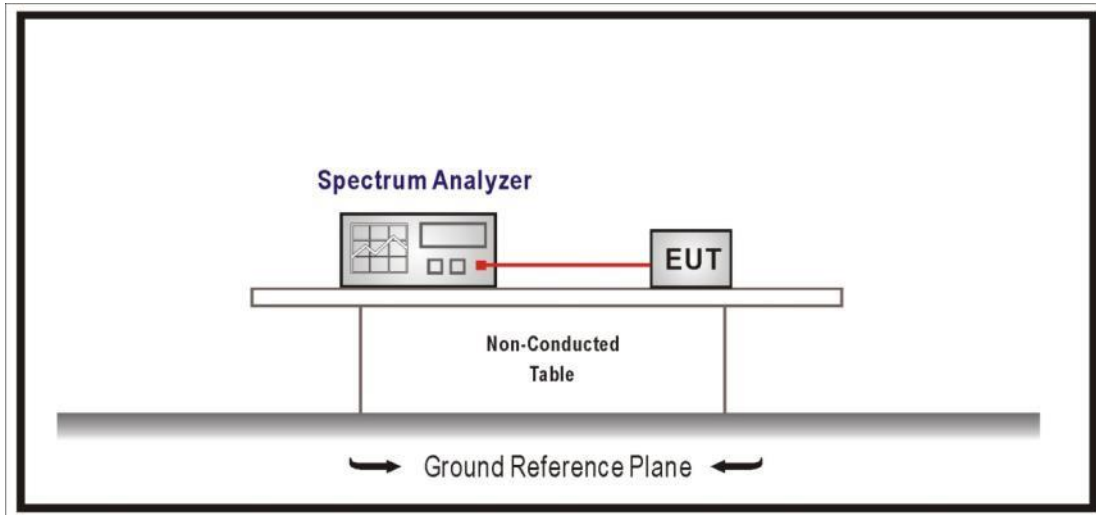

4.4.3 Test Procedure

	References Rule	Chapter	Description
<input checked="" type="checkbox"/>	ANSI C63.10	11.6	Duty cycle (D), transmission duration (T), and maximum power control level

4.4.4 Test Data

Test Mode	Tx On (us)	Tx Off (us)	VBW (kHz)	Tx On + Tx Off (us)	Duty Cycle (%)
Mode 1	--	--	--	--	100
Mode 2	--	--	--	--	100
Mode 3	--	--	--	--	100
Mode 4	--	--	--	--	100

Note 1: T means the minimum transmission duration over which the transmitter is on and is transmitting at its maximum power control level for the tested mode of operation.

Note 2: According to KDB 558074, when test for Radiated Emission Band Edge and Radiated Emission, for average detector set: $VBW \geq 1/T$ will be used.

Mode 1 CH19 2440MHz

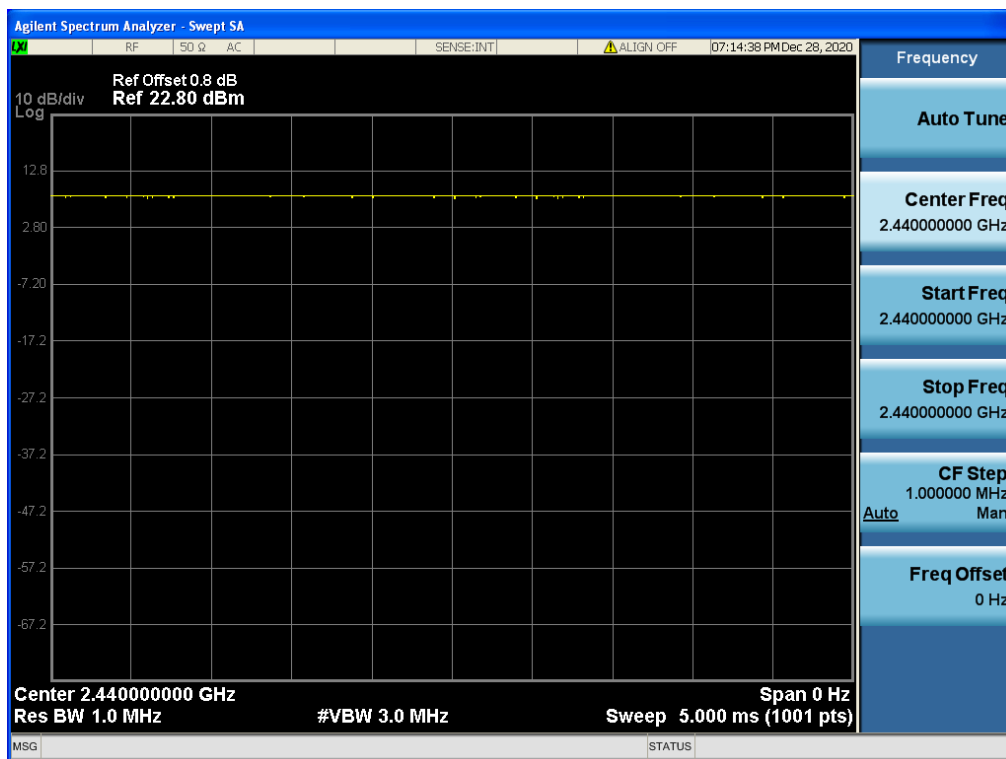

4.5 Radiated Emission Band Edge

VERDICT: PASS

4.5.1 Limit

Standard		FCC Part 15 Subpart C Paragraph 15.247(d) , 15.209		
Frequency bands (MHz)	Detector	Limit (dBµV/m)	RBW (MHz)	Distance (m)
2310-2390	PK	74	1	3
2483.5-2500	AV	54	1	3

Note: The field strength of emissions appearing within these frequency bands shall not exceed the limits.

4.5.2 Test Setup

Above 1GHz Test Setup:

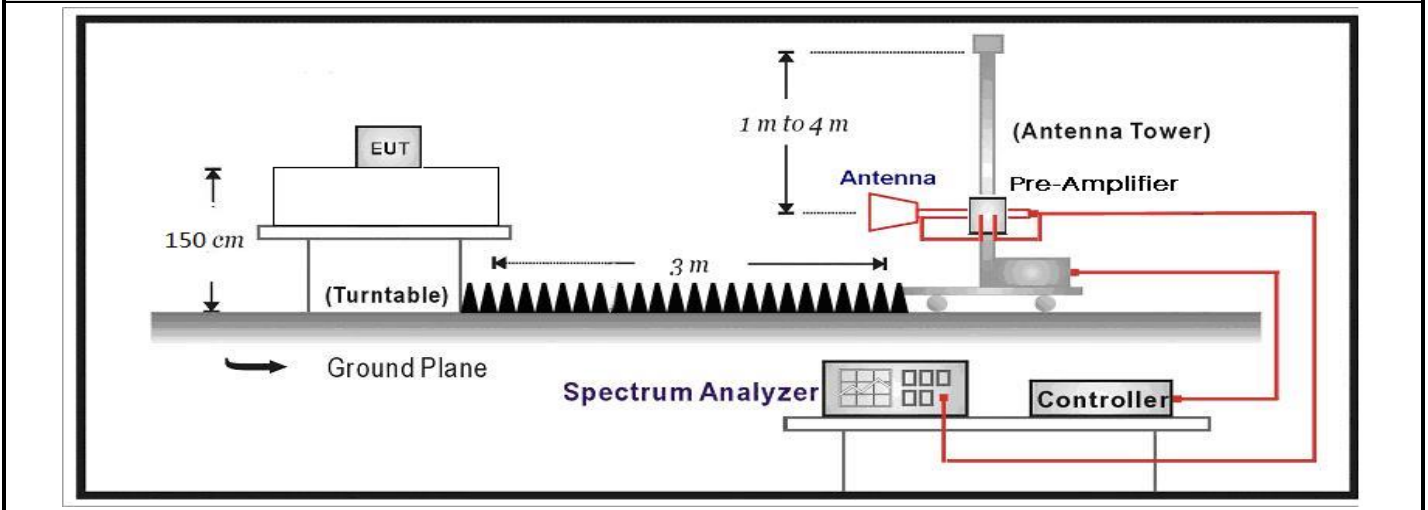

4.5.3 Test Procedure

	References Rule	Chapter	Description
<input checked="" type="checkbox"/>	ANSI C63.10	6.10	Band-edge testing
	<input checked="" type="checkbox"/> ANSI C63.10	6.10.5	Restricted-band band-edge measurements
	<input type="checkbox"/> ANSI C63.10	6.10.6	Marker-delta method
<input checked="" type="checkbox"/>	ANSI C63.10	11.12	Emissions in restricted frequency bands
	<input checked="" type="checkbox"/> ANSI C63.10	11.12.1	Radiated emission measurements
	<input checked="" type="checkbox"/> ANSI C63.10	11.12.2.7	Radiated spurious emission test
<input type="checkbox"/>	ANSI C63.10	6.4	Radiated emissions from unlicensed wireless devices below 30 MHz
<input type="checkbox"/>	ANSI C63.10	6.5	Radiated emissions from unlicensed wireless devices in the frequency range of 30 MHz to 1000 MHz
<input checked="" type="checkbox"/>	ANSI C63.10	6.6	Radiated emissions from unlicensed wireless devices above 1 GHz

4.5.4 Test Data

Profile: 20C0553R	Page No.: 1
Engineer: YULIU	
Site: AC5	Time: 2020/03/12 - 00:39
Limit: FCC_Part15.209_RE(3m)	Margin: 0
Probe: Horn_3117_00167055(1-18GHz)	Polarity: Vertical
EUT: LED Lamp	Power: AC 120V/60Hz
Note: Mode 1:Transmit at 2402MHz	

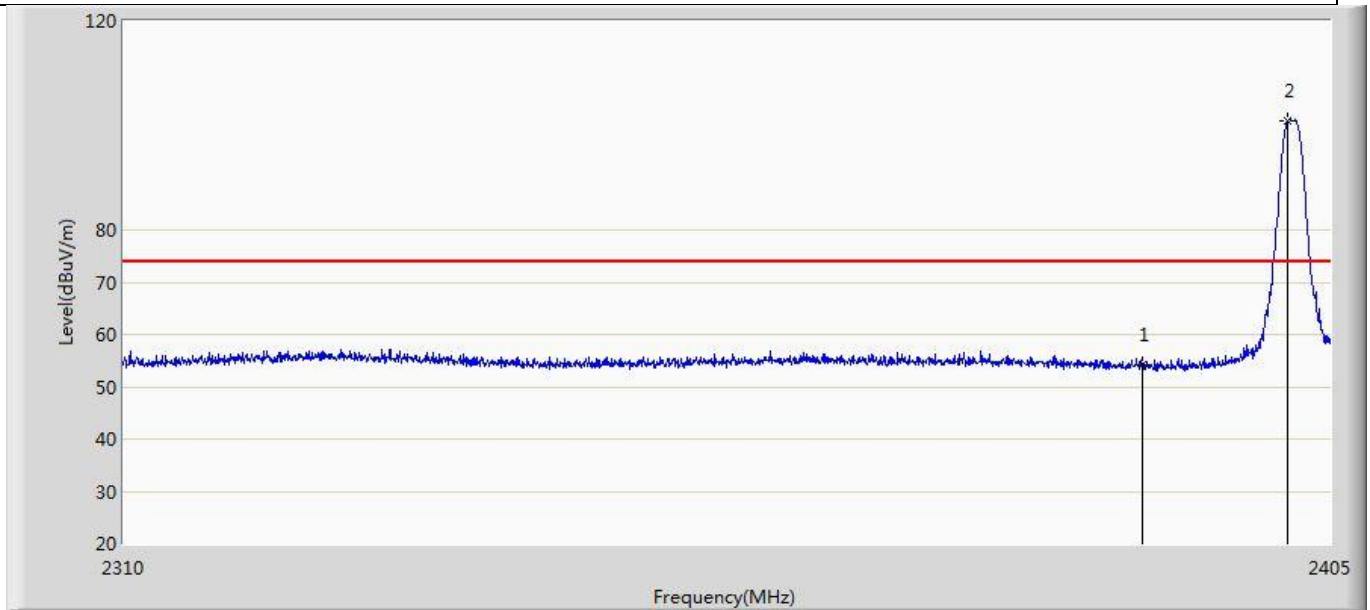

No	Mark	Frequency (MHz)	Measure Level (dBuV/m)	Reading Level (dBuV)	Over Limit (dB)	Limit (dBuV/m)	Factor (dB)	Type
1		2390.000	54.175	18.431	-19.825	74.000	35.745	PK
2	*	2401.580	100.777	64.740	26.777	74.000	36.036	PK

Profile: 20C0553R	Page No.: 2
Engineer: YULIU	
Site: AC5	Time: 2020/04/28 - 20:21
Limit: FCC_Part15.209_RE(3m)	Margin: 0
Probe: Horn_3117_00167055(1-18GHz)	Polarity: Vertical
EUT: LED Lamp	Power: AC 120V/60Hz
Note: Mode 1: Transmit at 2402MHz	



No	Mark	Frequency (MHz)	Measure Level (dBuV/m)	Reading Level (dBuV)	Over Limit (dB)	Limit (dBuV/m)	Factor (dB)	Type
1		2390.000	43.163	7.419	-10.837	54.000	35.745	AV
2	*	2401.865	101.053	64.995	47.053	54.000	36.057	AV

Profile: 20C0553R	Page No.: 3
Engineer: YULIU	
Site: AC5	Time: 2020/04/28 - 20:24
Limit: FCC_Part15.209_RE(3m)	Margin: 0
Probe: Horn_3117_00167055(1-18GHz)	Polarity: Horizontal
EUT: LED Lamp	Power: AC 120V/60Hz
Note: Mode 1:Transmit at 2402MHz	

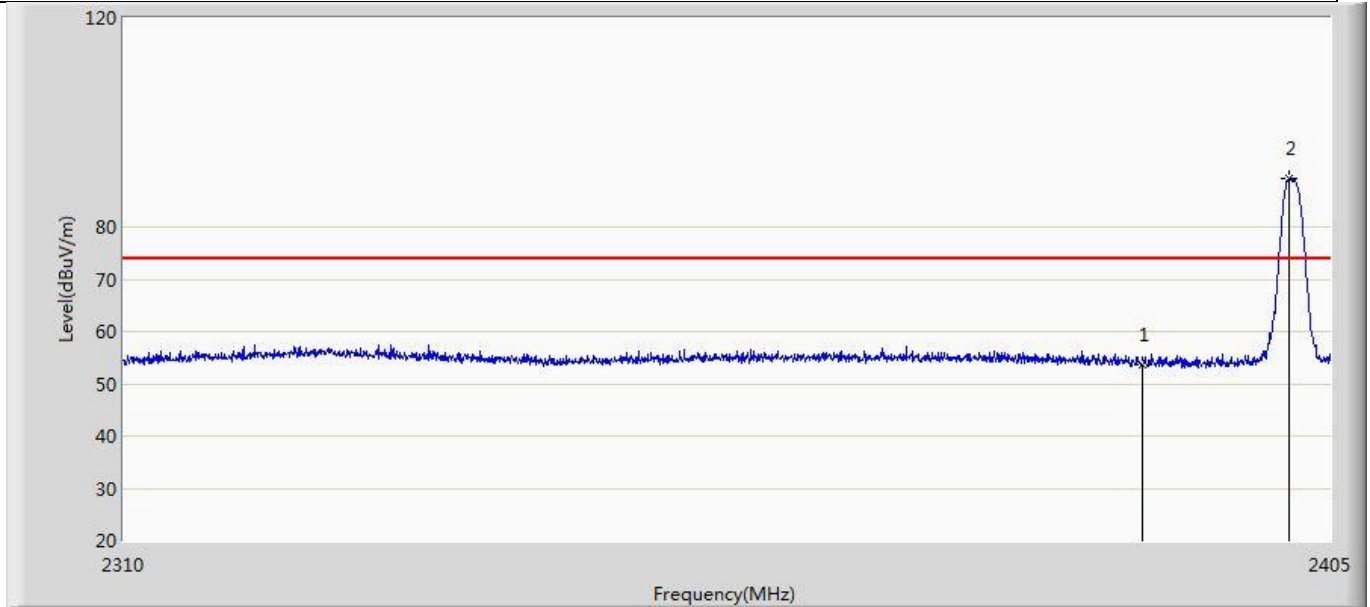

No	Mark	Frequency (MHz)	Measure Level (dBuV/m)	Reading Level (dBuV)	Over Limit (dB)	Limit (dBuV/m)	Factor (dB)	Type
1		2390.000	53.705	17.961	-20.295	74.000	35.745	PK
2	*	2401.675	89.224	53.180	15.224	74.000	36.043	PK

Profile: 20C0553R	Page No.: 4
Engineer: YULIU	
Site: AC5	Time: 2020/04/28 - 20:26
Limit: FCC_Part15.209_RE(3m)	Margin: 0
Probe: Horn_3117_00167055(1-18GHz)	Polarity: Horizontal
EUT: LED Lamp	Power: AC 120V/60Hz
Note: Mode 1:Transmit at 2402MHz	



No	Mark	Frequency (MHz)	Measure Level (dBuV/m)	Reading Level (dBuV)	Over Limit (dB)	Limit (dBuV/m)	Factor (dB)	Type
1		2390.000	43.111	7.367	-10.889	54.000	35.745	AV
2	*	2402.055	87.337	51.265	33.337	54.000	36.071	AV

Profile: 20C0553R	Page No.: 5
Engineer: YULIU	
Site: AC5	Time: 2020/04/28 - 20:28
Limit: FCC_Part15.209_RE(3m)	Margin: 0
Probe: Horn_3117_00167055(1-18GHz)	Polarity: Vertical
EUT: LED Lamp	Power: AC 120V/60Hz
Note: Mode 1:Transmit at 2480MHz	

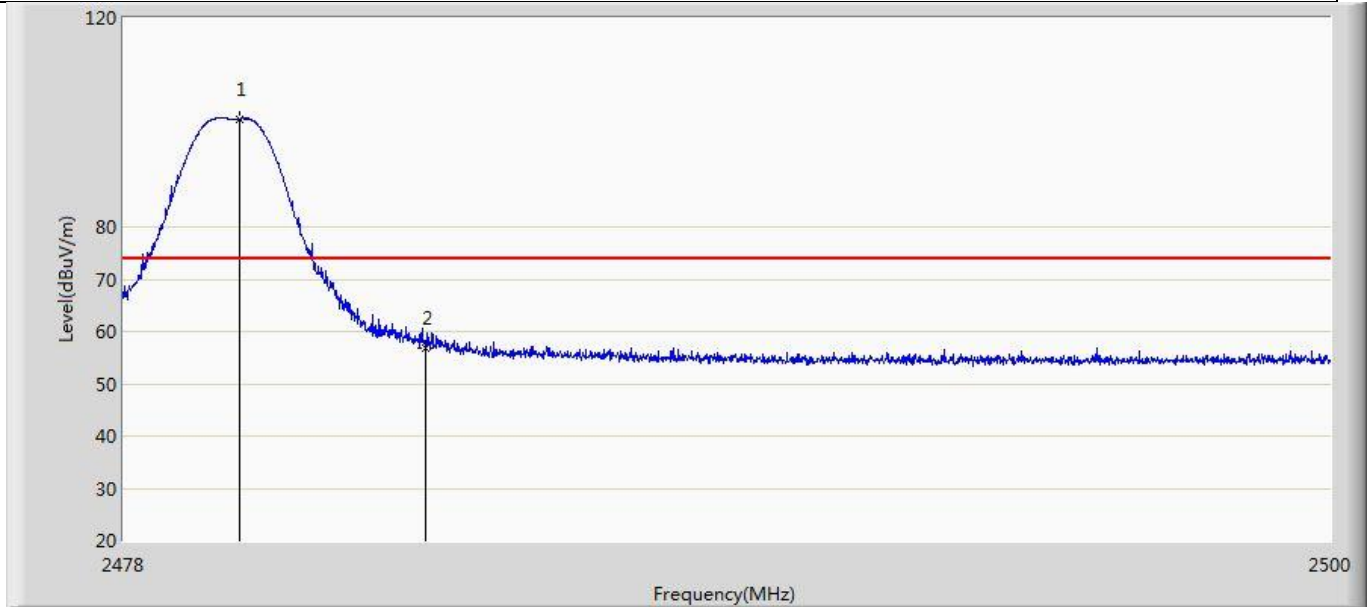

No	Mark	Frequency (MHz)	Measure Level (dBuV/m)	Reading Level (dBuV)	Over Limit (dB)	Limit (dBuV/m)	Factor (dB)	Type
1	*	2480.112	100.682	63.856	26.682	74.000	36.826	PK
2		2483.500	56.803	20.104	-17.197	74.000	36.699	PK

Profile: 20C0553R	Page No.: 6
Engineer: YULIU	
Site: AC5	Time: 2020/04/28 - 20:31
Limit: FCC_Part15.209_RE(3m)	Margin: 0
Probe: Horn_3117_00167055(1-18GHz)	Polarity: Vertical
EUT: LED Lamp	Power: AC 120V/60Hz
Note: Mode 1:Transmit at 2480MHz	

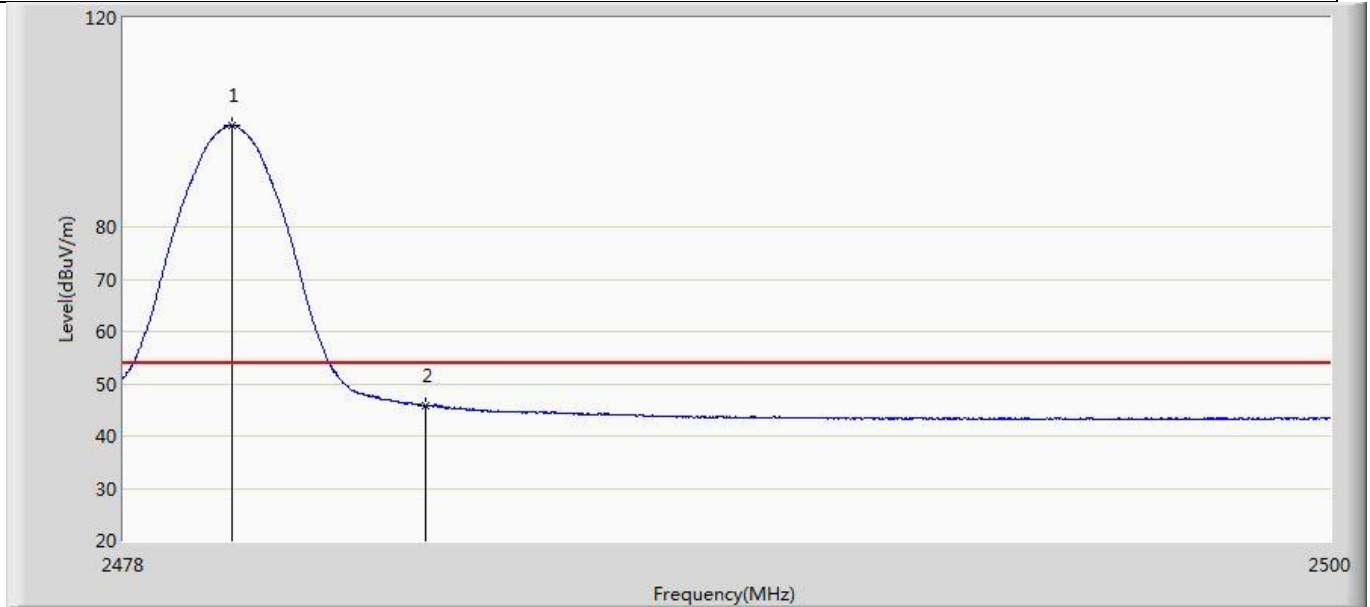

No	Mark	Frequency (MHz)	Measure Level (dBuV/m)	Reading Level (dBuV)	Over Limit (dB)	Limit (dBuV/m)	Factor (dB)	Type
1	*	2479.980	99.428	62.597	45.428	54.000	36.831	AV
2		2483.500	45.682	8.983	-8.318	54.000	36.699	AV

Profile: 20C0553R	Page No.: 7
Engineer: YULIU	
Site: AC5	Time: 2020/04/28 - 20:33
Limit: FCC_Part15.209_RE(3m)	Margin: 0
Probe: Horn_3117_00167055(1-18GHz)	Polarity: Horizontal
EUT: LED Lamp	Power: AC 120V/60Hz
Note: Mode 1:Transmit at 2480MHz	

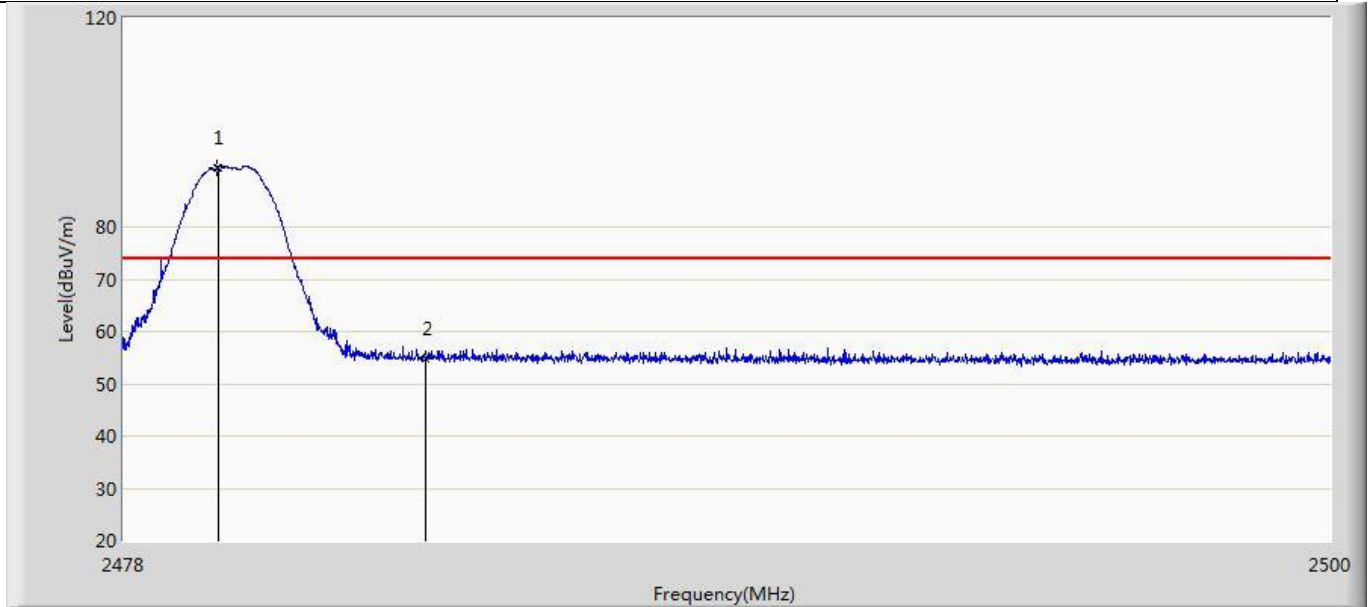

No	Mark	Frequency (MHz)	Measure Level (dBuV/m)	Reading Level (dBuV)	Over Limit (dB)	Limit (dBuV/m)	Factor (dB)	Type
1	*	2479.716	91.413	54.573	17.413	74.000	36.841	PK
2		2483.500	54.857	18.158	-19.143	74.000	36.699	PK

Profile: 20C0553R	Page No.: 8
Engineer: YULIU	
Site: AC5	Time: 2020/04/28 - 20:36
Limit: FCC_Part15.209_RE(3m)	Margin: 0
Probe: Horn_3117_00167055(1-18GHz)	Polarity: Horizontal
EUT: LED Lamp	Power: AC 120V/60Hz
Note: Mode 1:Transmit at 2480MHz	

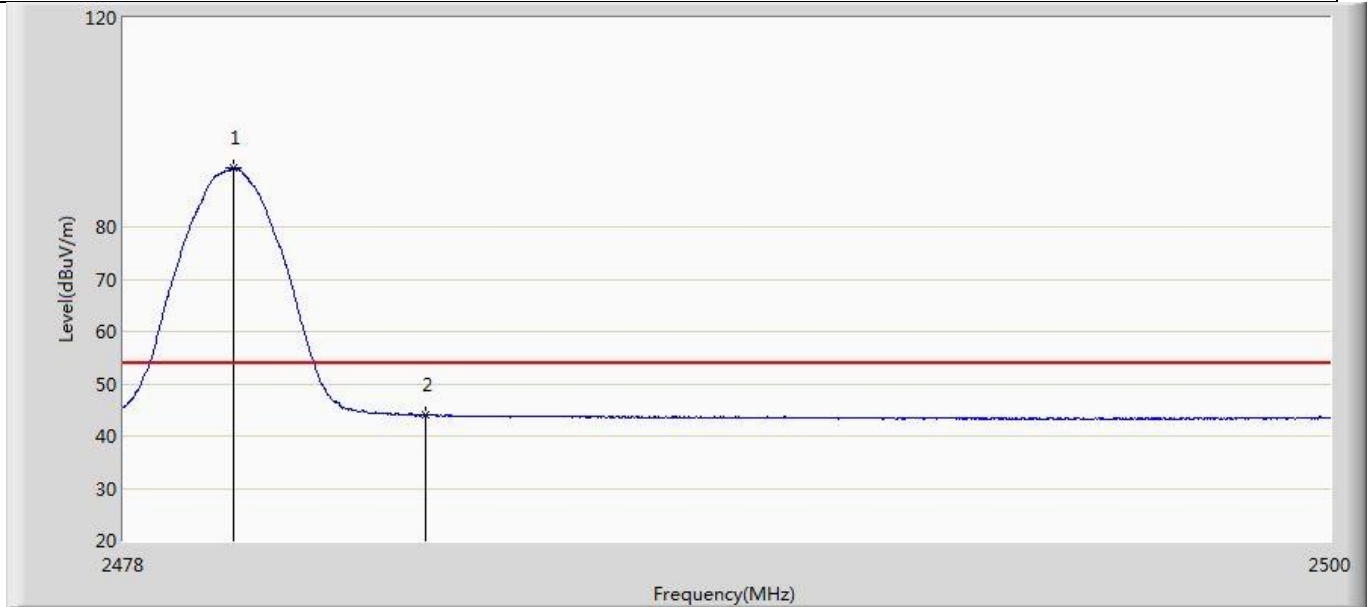

No	Mark	Frequency (MHz)	Measure Level (dBuV/m)	Reading Level (dBuV)	Over Limit (dB)	Limit (dBuV/m)	Factor (dB)	Type
1	*	2480.013	91.274	54.445	37.274	54.000	36.830	AV
2		2483.500	43.918	7.219	-10.082	54.000	36.699	AV

Profile: 20C0553R	Page No.: 9
Engineer: YULIU	
Site: AC5	Time: 2020/04/28 - 20:39
Limit: FCC_Part15.209_RE(3m)	Margin: 0
Probe: Horn_3117_00167055(1-18GHz)	Polarity: Vertical
EUT: LED Lamp	Power: AC 120V/60Hz
Note: Mode 2:Transmit at 2402MHz	

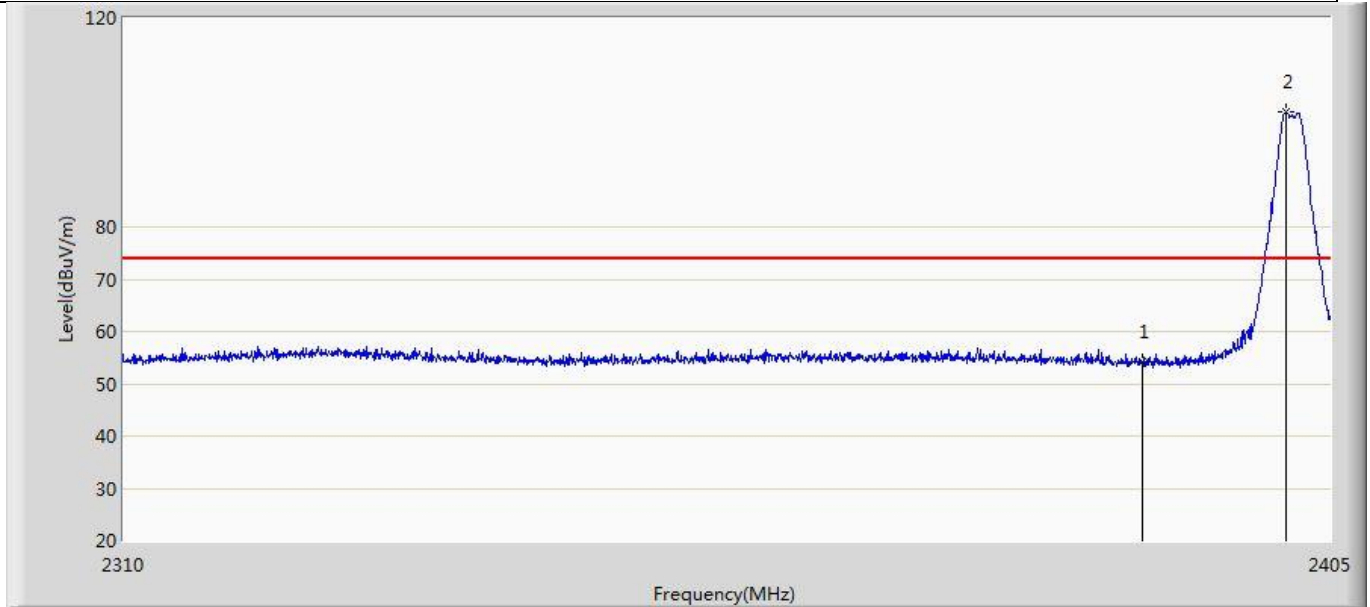

No	Mark	Frequency (MHz)	Measure Level (dBuV/m)	Reading Level (dBuV)	Over Limit (dB)	Limit (dBuV/m)	Factor (dB)	Type
1		2390.000	54.108	18.364	-19.892	74.000	35.745	PK
2	*	2401.485	102.038	66.008	28.038	74.000	36.029	PK

Profile: 20C0553R	Page No.: 10
Engineer: YULIU	
Site: AC5	Time: 2020/04/28 - 20:48
Limit: FCC_Part15.209_RE(3m)	Margin: 0
Probe: Horn_3117_00167055(1-18GHz)	Polarity: Vertical
EUT: LED Lamp	Power: AC 120V/60Hz
Note: Mode 2:Transmit at 2402MHz	

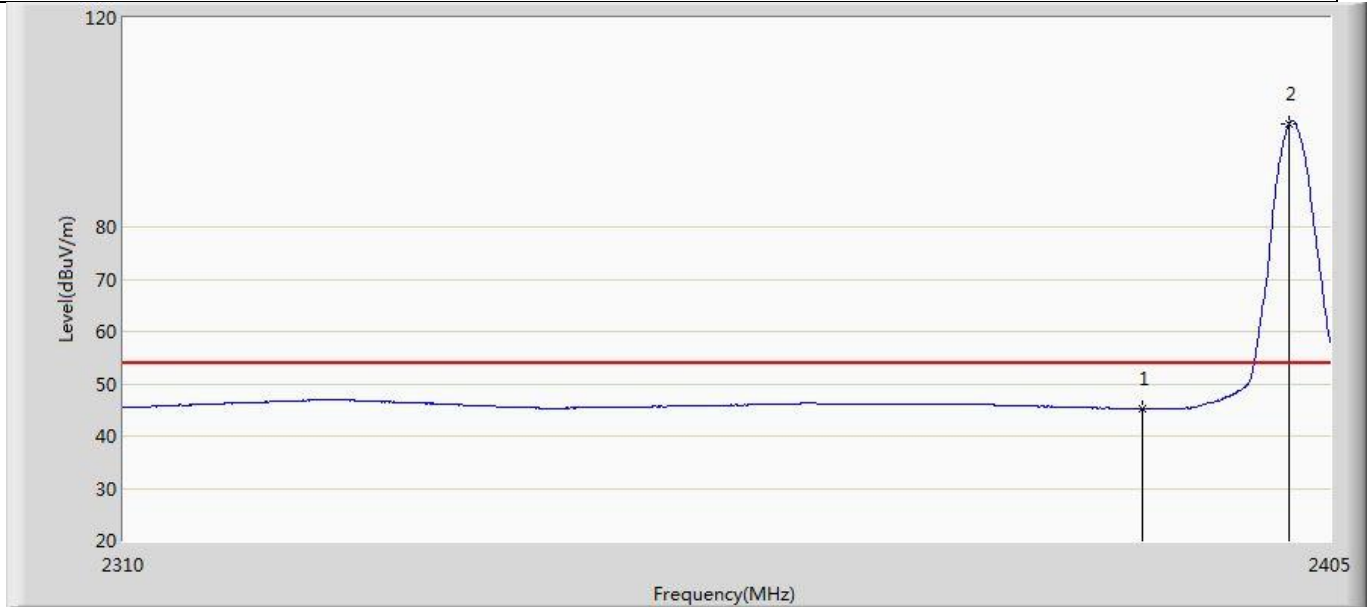

No	Mark	Frequency (MHz)	Measure Level (dBuV/m)	Reading Level (dBuV)	Over Limit (dB)	Limit (dBuV/m)	Factor (dB)	Type
1		2390.000	45.131	9.387	-8.869	54.000	35.745	AV
2	*	2401.722	99.688	63.641	45.688	54.000	36.047	AV

Profile: 20C0553R	Page No.: 11
Engineer: YULIU	
Site: AC5	Time: 2020/04/28 - 20:51
Limit: FCC_Part15.209_RE(3m)	Margin: 0
Probe: Horn_3117_00167055(1-18GHz)	Polarity: Horizontal
EUT: LED Lamp	Power: AC 120V/60Hz
Note: Mode 2:Transmit at 2402MHz	

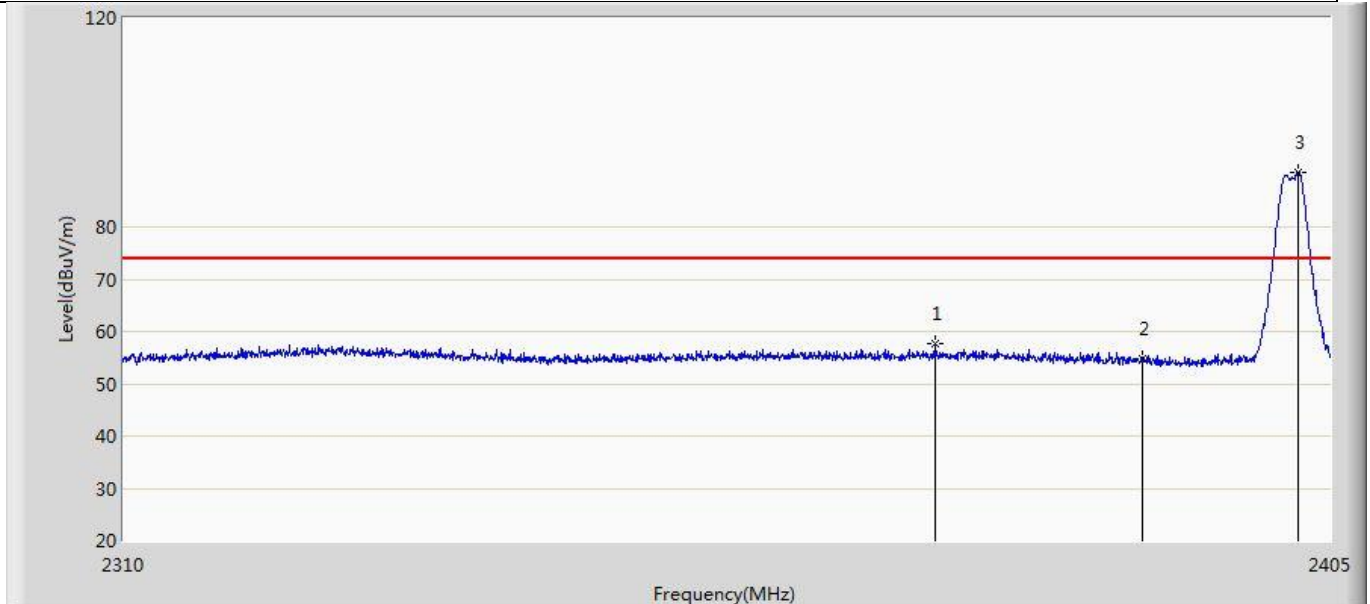

No	Mark	Frequency (MHz)	Measure Level (dBuV/m)	Reading Level (dBuV)	Over Limit (dB)	Limit (dBuV/m)	Factor (dB)	Type
1		2373.460	57.742	21.118	-16.258	74.000	36.624	PK
2		2390.000	54.881	19.137	-19.119	74.000	35.745	PK
3	*	2402.435	90.493	54.393	16.493	74.000	36.100	PK

Profile: 20C0553R	Page No.: 12
Engineer: YULIU	
Site: AC5	Time: 2020/04/28 - 20:53
Limit: FCC_Part15.209_RE(3m)	Margin: 0
Probe: Horn_3117_00167055(1-18GHz)	Polarity: Horizontal
EUT: LED Lamp	Power: AC 120V/60Hz
Note: Mode 2:Transmit at 2402MHz	

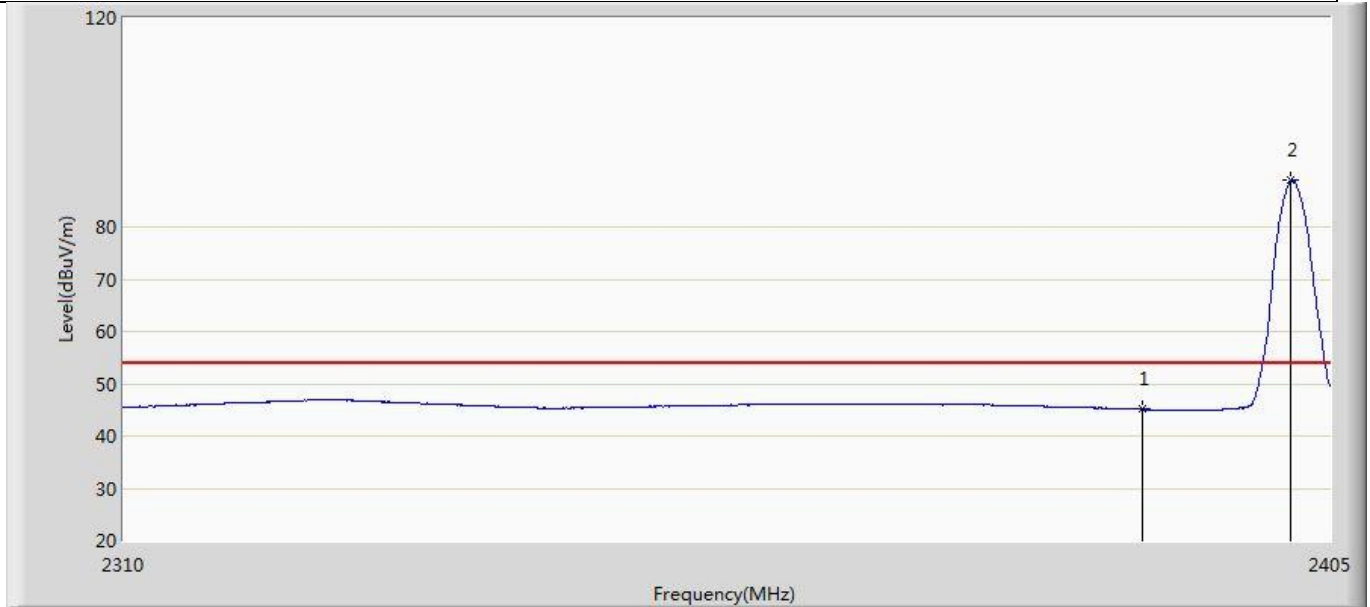

No	Mark	Frequency (MHz)	Measure Level (dBuV/m)	Reading Level (dBuV)	Over Limit (dB)	Limit (dBuV/m)	Factor (dB)	Type
1		2390.000	45.135	9.391	-8.865	54.000	35.745	AV
2	*	2401.865	88.842	52.784	34.842	54.000	36.057	AV

Profile: 20C0553R	Page No.: 13
Engineer: YULIU	
Site: AC5	Time: 2020/04/28 - 20:55
Limit: FCC_Part15.209_RE(3m)	Margin: 0
Probe: Horn_3117_00167055(1-18GHz)	Polarity: Vertical
EUT: LED Lamp	Power: AC 120V/60Hz
Note: Mode 2:Transmit at 2480MHz	

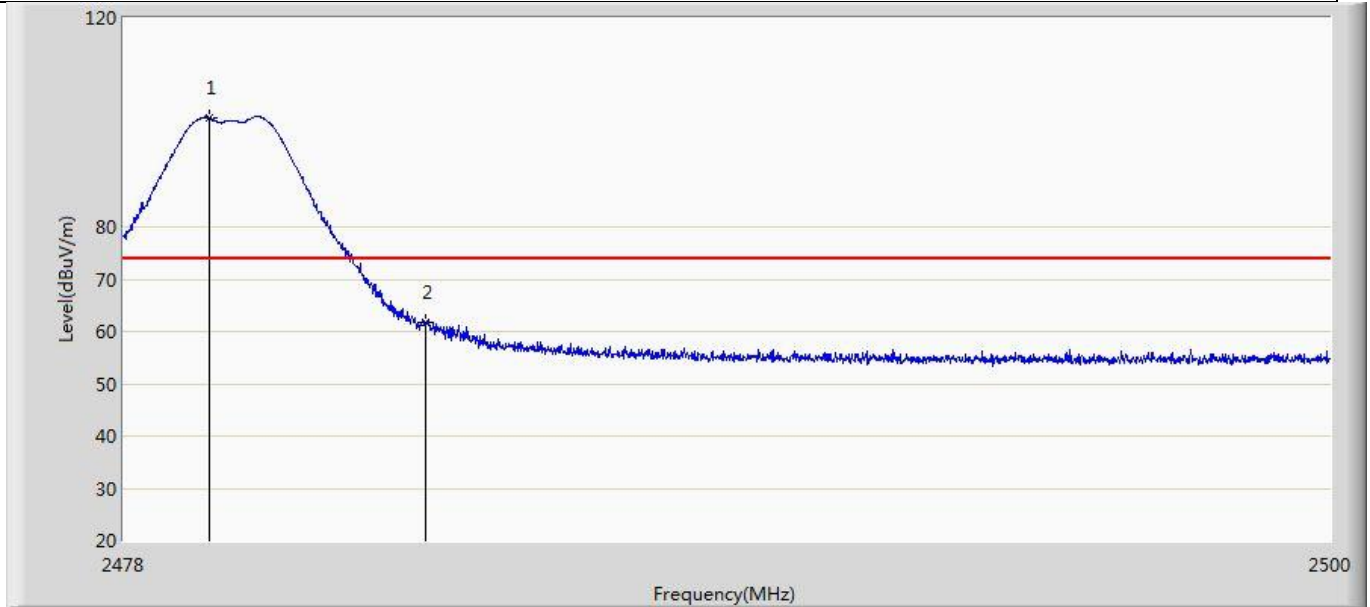

No	Mark	Frequency (MHz)	Measure Level (dBuV/m)	Reading Level (dBuV)	Over Limit (dB)	Limit (dBuV/m)	Factor (dB)	Type
1	*	2479.573	100.911	64.065	26.911	74.000	36.846	PK
2		2483.500	61.670	24.971	-12.330	74.000	36.699	PK

Profile: 20C0553R	Page No.: 14
Engineer: YULIU	
Site: AC5	Time: 2020/04/28 - 21:06
Limit: FCC_Part15.209_RE(3m)	Margin: 0
Probe: Horn_3117_00167055(1-18GHz)	Polarity: Vertical
EUT: LED Lamp	Power: AC 120V/60Hz
Note: Mode 2:Transmit at 2480MHz	

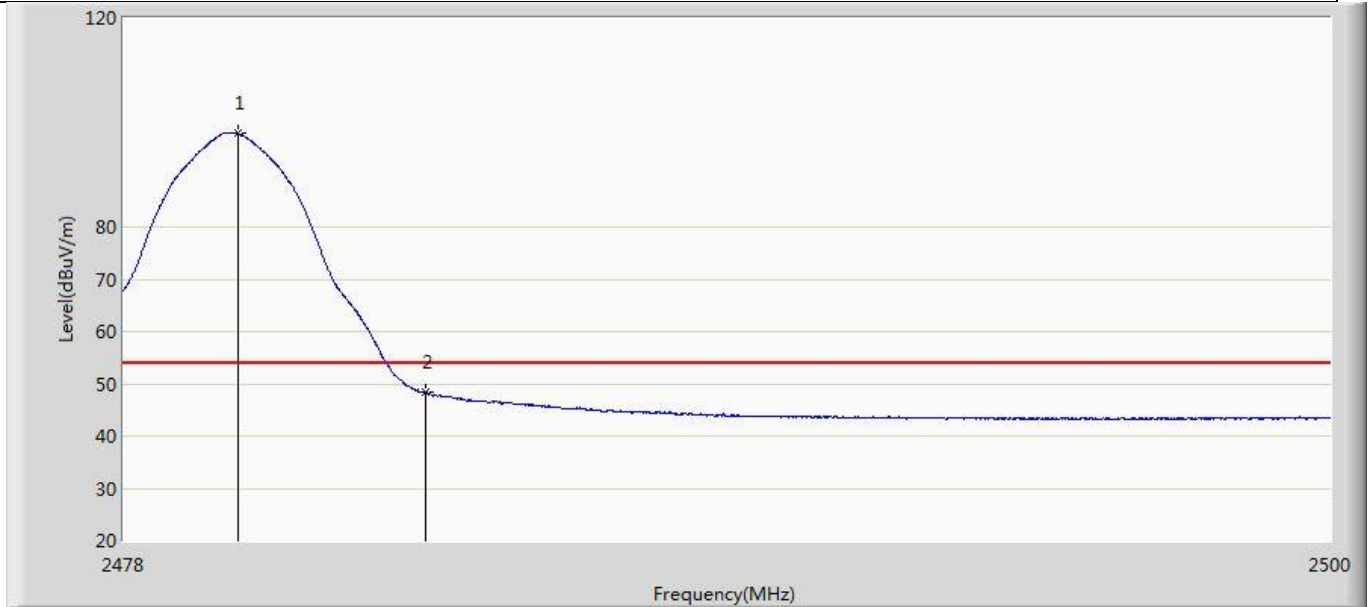

No	Mark	Frequency (MHz)	Measure Level (dBuV/m)	Reading Level (dBuV)	Over Limit (dB)	Limit (dBuV/m)	Factor (dB)	Type
1	*	2480.079	97.828	61.001	43.828	54.000	36.827	AV
2		2483.500	48.372	11.673	-5.628	54.000	36.699	AV

Profile: 20C0553R	Page No.: 15
Engineer: YULIU	
Site: AC5	Time: 2020/04/28 - 21:09
Limit: FCC_Part15.209_RE(3m)	Margin: 0
Probe: Horn_3117_00167055(1-18GHz)	Polarity: Horizontal
EUT: LED Lamp	Power: AC 120V/60Hz
Note: Mode 2:Transmit at 2480MHz	

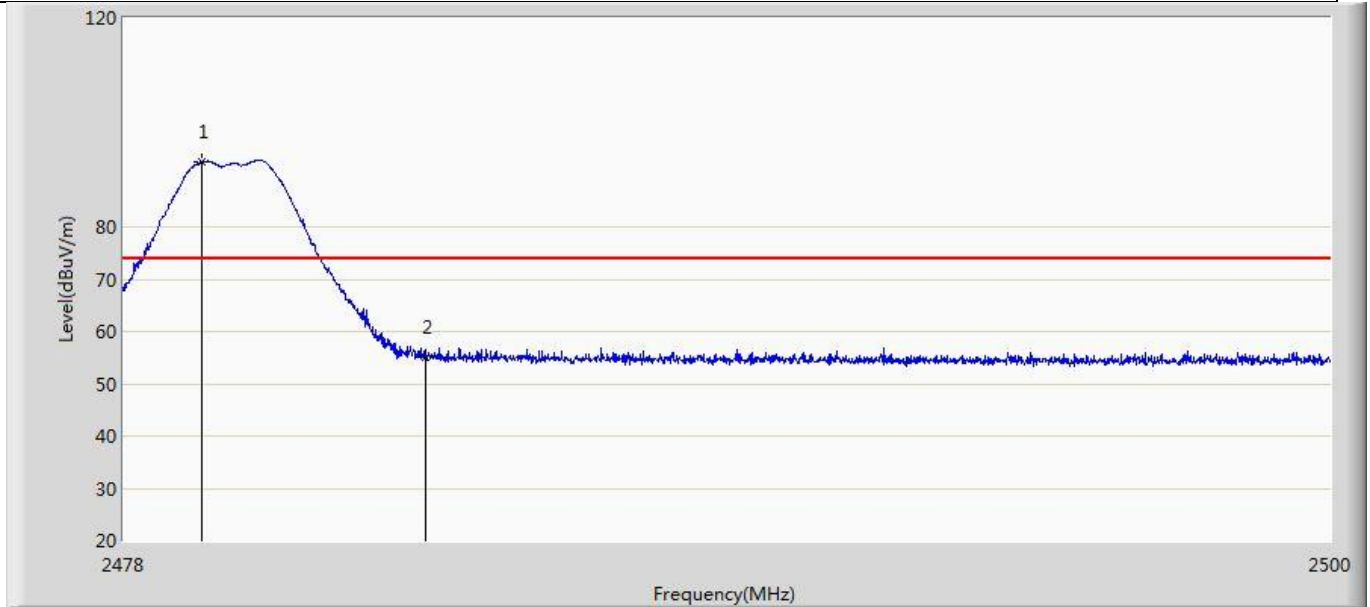

No	Mark	Frequency (MHz)	Measure Level (dBuV/m)	Reading Level (dBuV)	Over Limit (dB)	Limit (dBuV/m)	Factor (dB)	Type
1	*	2479.430	92.409	55.558	18.409	74.000	36.851	PK
2		2483.500	55.075	18.376	-18.925	74.000	36.699	PK

Profile: 20C0553R	Page No.: 16
Engineer: YULIU	
Site: AC5	Time: 2020/04/28 - 21:13
Limit: FCC_Part15.209_RE(3m)	Margin: 0
Probe: Horn_3117_00167055(1-18GHz)	Polarity: Horizontal
EUT: LED Lamp	Power: AC 120V/60Hz
Note: Mode 2:Transmit at 2480MHz	

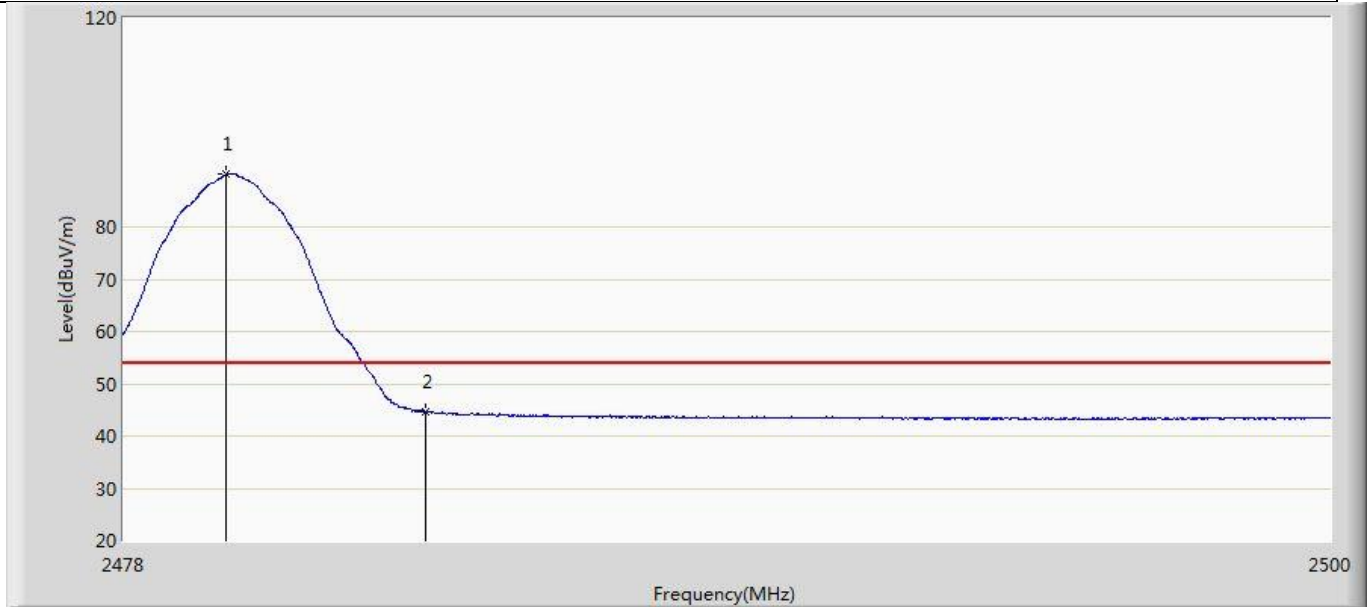

No	Mark	Frequency (MHz)	Measure Level (dBuV/m)	Reading Level (dBuV)	Over Limit (dB)	Limit (dBuV/m)	Factor (dB)	Type
1	*	2479.870	90.072	53.237	36.072	54.000	36.835	AV
2		2483.500	44.519	7.820	-9.481	54.000	36.699	AV

Profile: 20C0553R	Page No.: 17
Engineer: YULIU	
Site: AC5	Time: 2020/04/28 - 21:16
Limit: FCC_Part15.209_RE(3m)	Margin: 0
Probe: Horn_3117_00167055(1-18GHz)	Polarity: Vertical
EUT: LED Lamp	Power: AC 120V/60Hz
Note: Mode 3:Transmit at 2402MHz	

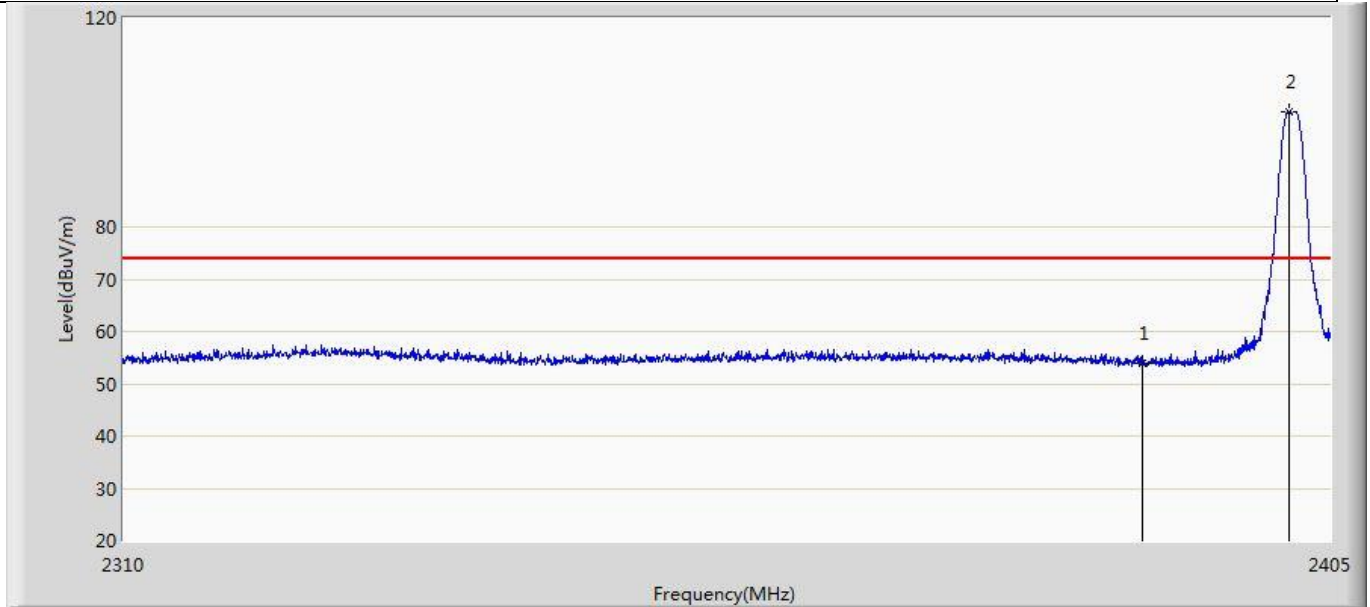

No	Mark	Frequency (MHz)	Measure Level (dBuV/m)	Reading Level (dBuV)	Over Limit (dB)	Limit (dBuV/m)	Factor (dB)	Type
1		2390.000	53.920	18.176	-20.080	74.000	35.745	PK
2	*	2401.770	102.109	66.058	28.109	74.000	36.050	PK

Profile: 20C0553R	Page No.: 18
Engineer: YULIU	
Site: AC5	Time: 2020/04/28 - 21:20
Limit: FCC_Part15.209_RE(3m)	Margin: 0
Probe: Horn_3117_00167055(1-18GHz)	Polarity: Vertical
EUT: LED Lamp	Power: AC 120V/60Hz
Note: Mode 3:Transmit at 2402MHz	

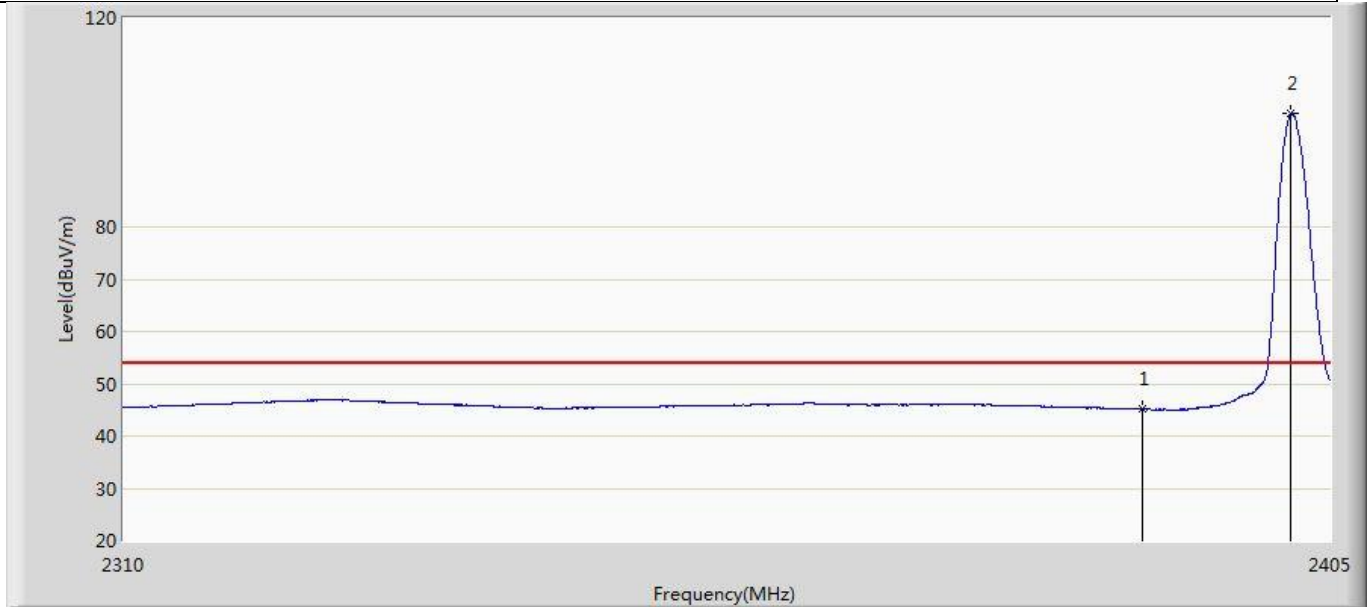

No	Mark	Frequency (MHz)	Measure Level (dBuV/m)	Reading Level (dBuV)	Over Limit (dB)	Limit (dBuV/m)	Factor (dB)	Type
1		2390.000	45.201	9.457	-8.799	54.000	35.745	AV
2	*	2401.865	101.599	65.541	47.599	54.000	36.057	AV

Profile: 20C0553R	Page No.: 19
Engineer: YULIU	
Site: AC5	Time: 2020/04/28 - 21:22
Limit: FCC_Part15.209_RE(3m)	Margin: 0
Probe: Horn_3117_00167055(1-18GHz)	Polarity: Horizontal
EUT: LED Lamp	Power: AC 120V/60Hz
Note: Mode 3:Transmit at 2402MHz	

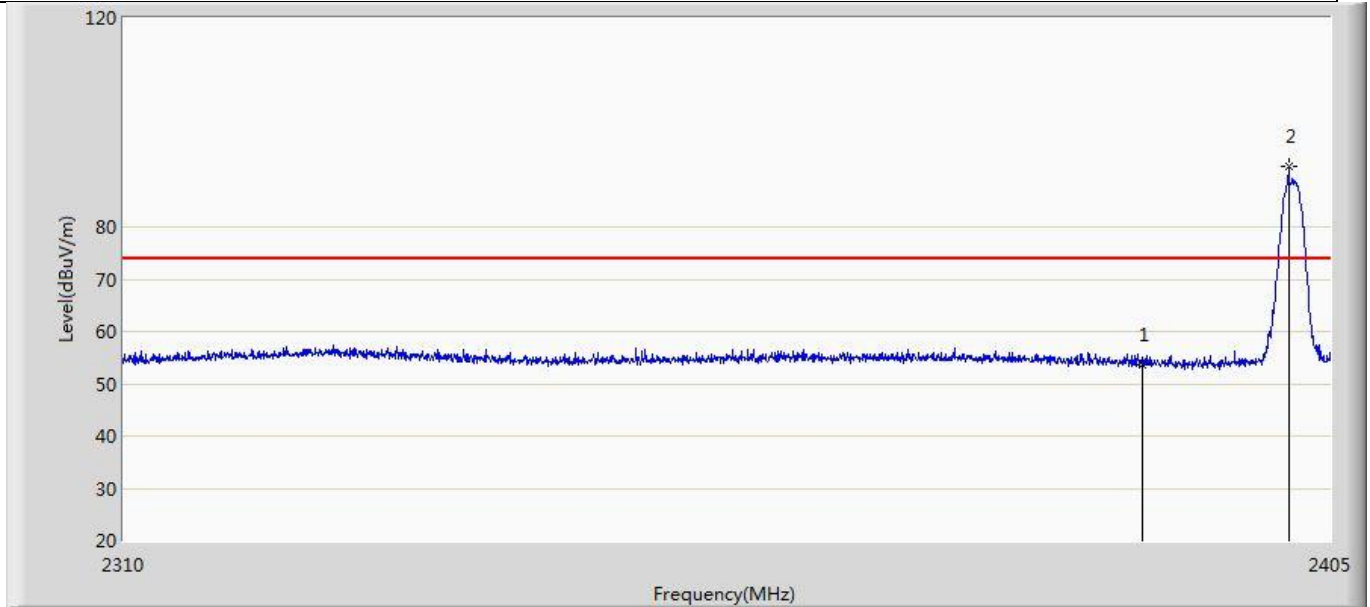

No	Mark	Frequency (MHz)	Measure Level (dBuV/m)	Reading Level (dBuV)	Over Limit (dB)	Limit (dBuV/m)	Factor (dB)	Type
1		2390.000	53.638	17.894	-20.362	74.000	35.745	PK
2	*	2401.722	91.617	55.570	17.617	74.000	36.047	PK

Profile: 20C0553R	Page No.: 20
Engineer: YULIU	
Site: AC5	Time: 2020/04/28 - 21:24
Limit: FCC_Part15.209_RE(3m)	Margin: 0
Probe: Horn_3117_00167055(1-18GHz)	Polarity: Horizontal
EUT: LED Lamp	Power: AC 120V/60Hz
Note: Mode 3:Transmit at 2402MHz	

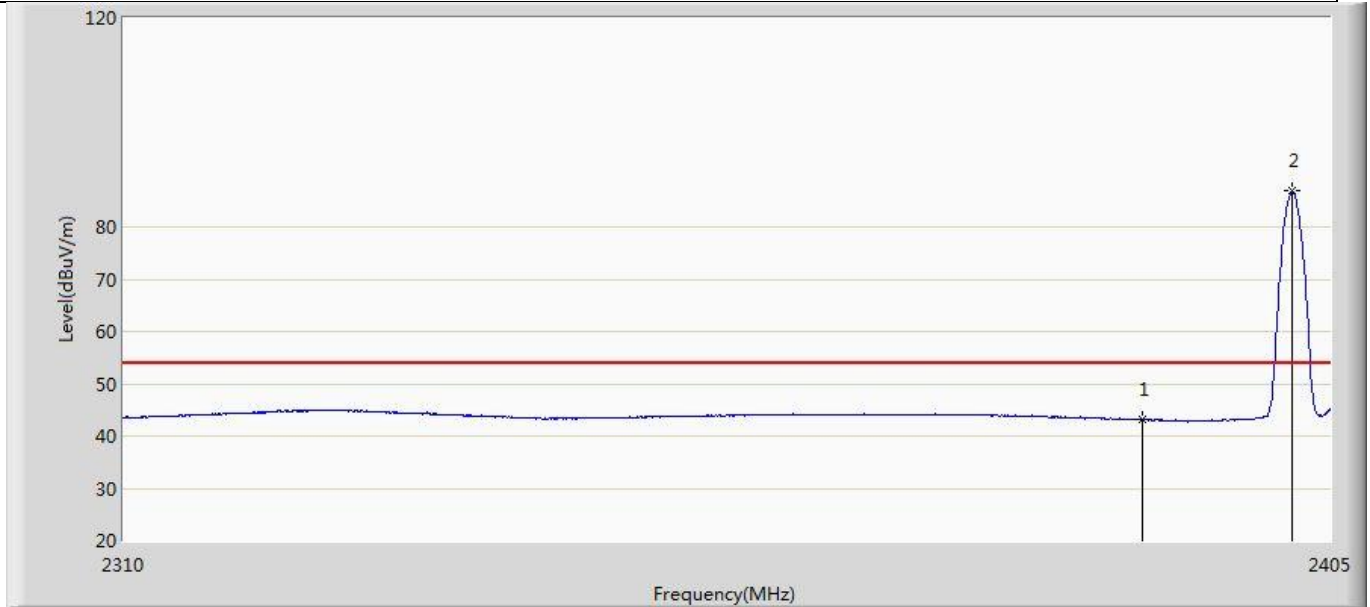

No	Mark	Frequency (MHz)	Measure Level (dBuV/m)	Reading Level (dBuV)	Over Limit (dB)	Limit (dBuV/m)	Factor (dB)	Type
1		2390.000	43.134	7.390	-10.866	54.000	35.745	AV
2	*	2401.960	86.937	50.872	32.937	54.000	36.064	AV

Profile: 20C0553R	Page No.: 21
Engineer: YULIU	
Site: AC5	Time: 2020/04/28 - 21:26
Limit: FCC_Part15.209_RE(3m)	Margin: 0
Probe: Horn_3117_00167055(1-18GHz)	Polarity: Vertical
EUT: LED Lamp	Power: AC 120V/60Hz
Note: Mode 3:Transmit at 2480MHz	

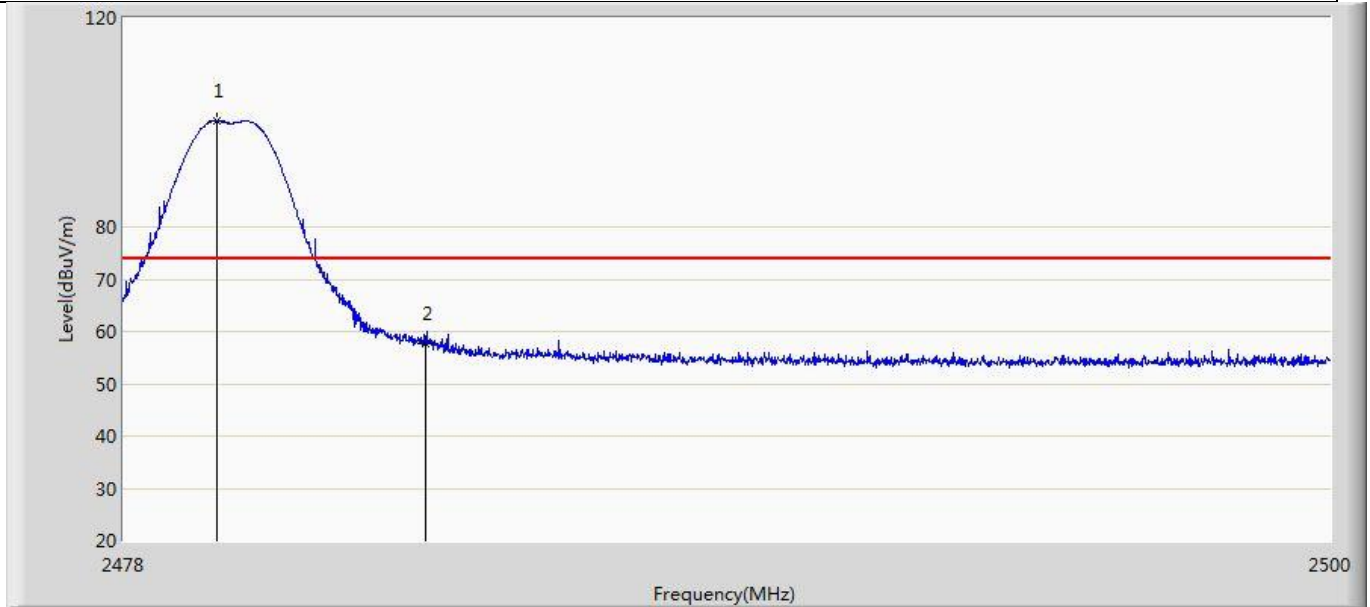

No	Mark	Frequency (MHz)	Measure Level (dBuV/m)	Reading Level (dBuV)	Over Limit (dB)	Limit (dBuV/m)	Factor (dB)	Type
1	*	2479.705	100.243	63.402	26.243	74.000	36.841	PK
2		2483.500	57.779	21.080	-16.221	74.000	36.699	PK

Profile: 20C0553R	Page No.: 22
Engineer: YULIU	
Site: AC5	Time: 2020/04/28 - 21:29
Limit: FCC_Part15.209_RE(3m)	Margin: 0
Probe: Horn_3117_00167055(1-18GHz)	Polarity: Vertical
EUT: LED Lamp	Power: AC 120V/60Hz
Note: Mode 3:Transmit at 2480MHz	

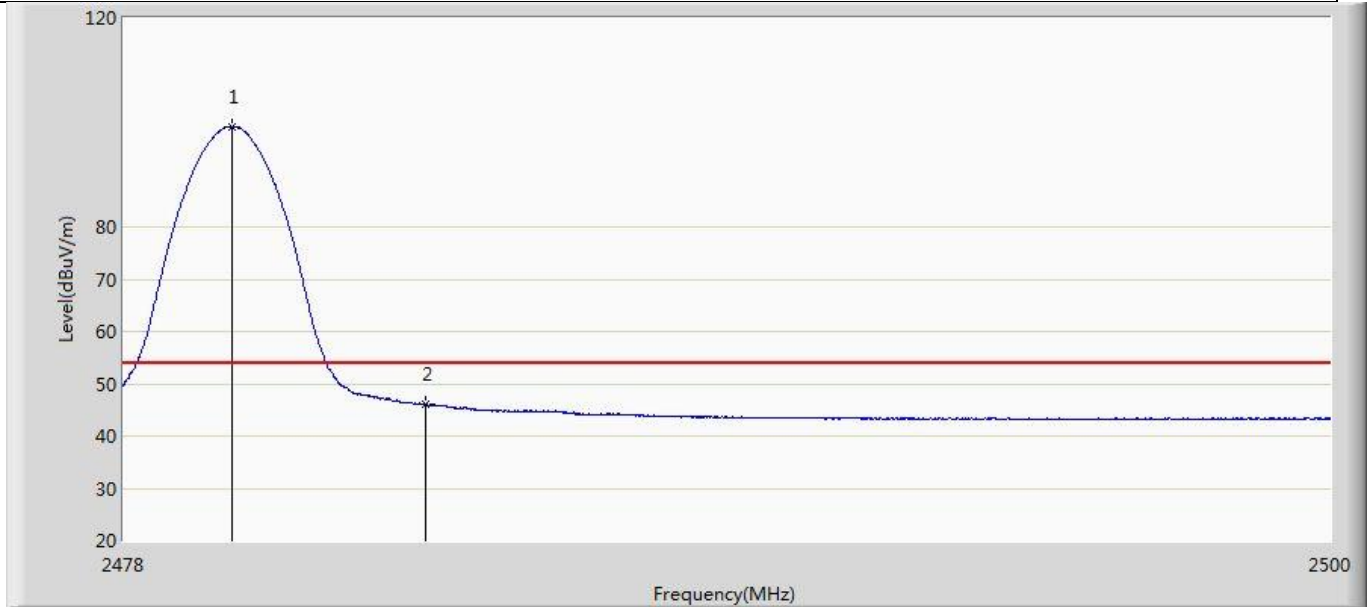

No	Mark	Frequency (MHz)	Measure Level (dBuV/m)	Reading Level (dBuV)	Over Limit (dB)	Limit (dBuV/m)	Factor (dB)	Type
1	*	2479.980	99.186	62.355	45.186	54.000	36.831	AV
2		2483.500	46.035	9.336	-7.965	54.000	36.699	AV

Profile: 20C0553R	Page No.: 23
Engineer: YULIU	
Site: AC5	Time: 2020/04/28 - 21:31
Limit: FCC_Part15.209_RE(3m)	Margin: 0
Probe: Horn_3117_00167055(1-18GHz)	Polarity: Horizontal
EUT: LED Lamp	Power: AC 120V/60Hz
Note: Mode 3:Transmit at 2480MHz	

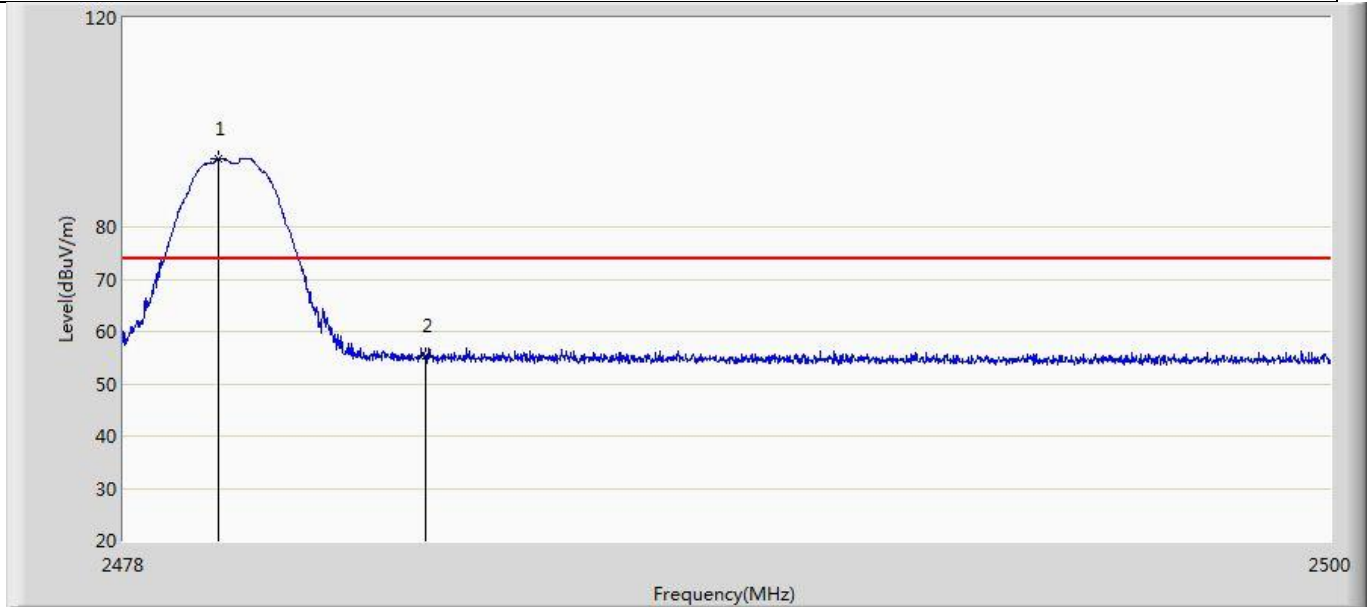

No	Mark	Frequency (MHz)	Measure Level (dBuV/m)	Reading Level (dBuV)	Over Limit (dB)	Limit (dBuV/m)	Factor (dB)	Type
1	*	2479.738	93.044	56.204	19.044	74.000	36.840	PK
2		2483.500	55.280	18.581	-18.720	74.000	36.699	PK

Profile: 20C0553R	Page No.: 24
Engineer: YULIU	
Site: AC5	Time: 2020/04/28 - 21:34
Limit: FCC_Part15.209_RE(3m)	Margin: 0
Probe: Horn_3117_00167055(1-18GHz)	Polarity: Horizontal
EUT: LED Lamp	Power: AC 120V/60Hz
Note: Mode 3:Transmit at 2480MHz	

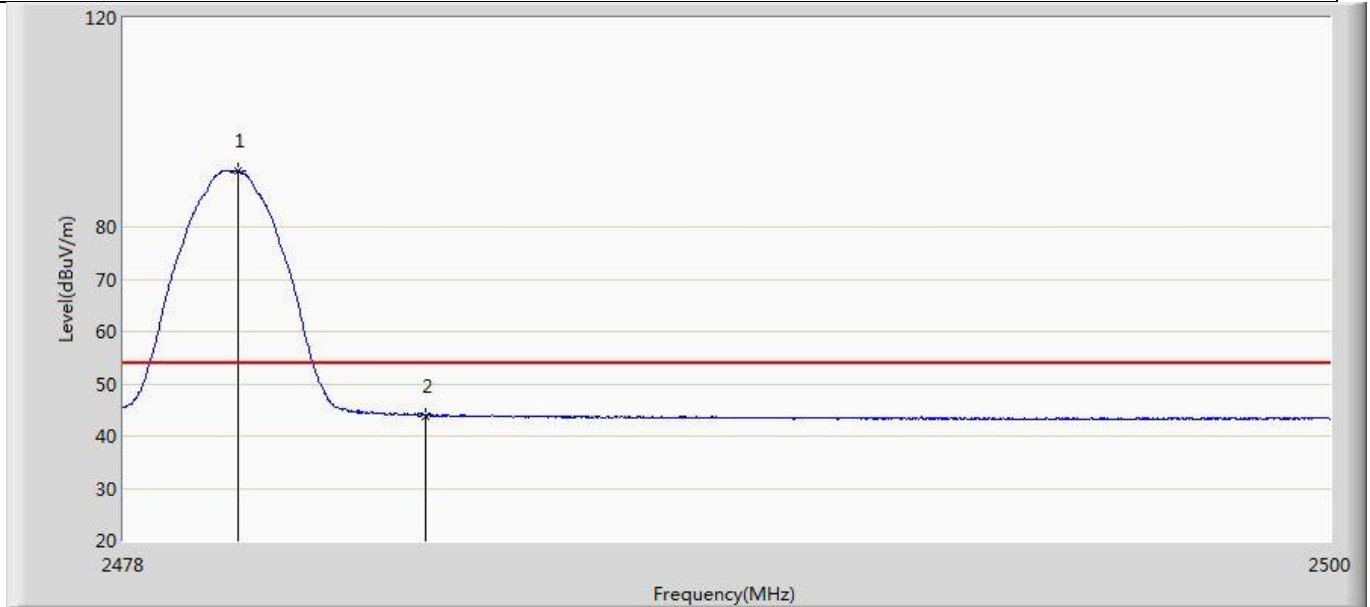

No	Mark	Frequency (MHz)	Measure Level (dBuV/m)	Reading Level (dBuV)	Over Limit (dB)	Limit (dBuV/m)	Factor (dB)	Type
1	*	2480.079	90.712	53.885	36.712	54.000	36.827	AV
2		2483.500	43.862	7.163	-10.138	54.000	36.699	AV

Profile: 20C0553R	Page No.: 25
Engineer: YULIU	
Site: AC5	Time: 2020/04/28 - 21:36
Limit: FCC_Part15.209_RE(3m)	Margin: 0
Probe: Horn_3117_00167055(1-18GHz)	Polarity: Vertical
EUT: LED Lamp	Power: AC 120V/60Hz
Note: Mode 4:Transmit at 2402MHz	

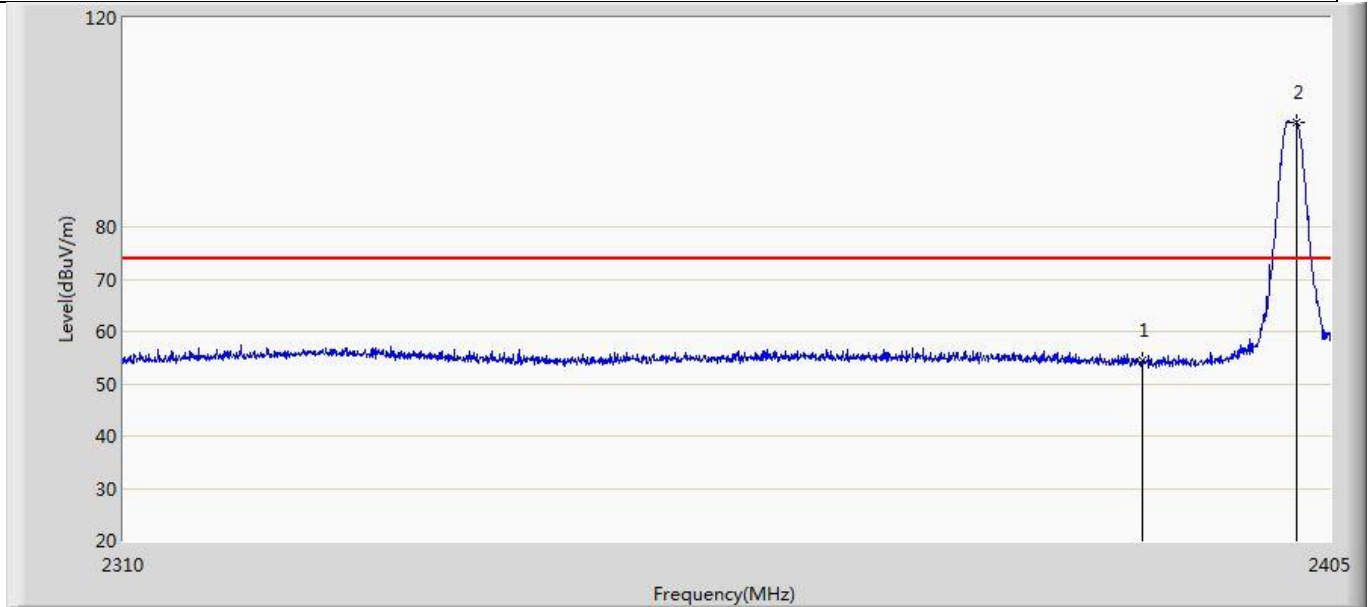

No	Mark	Frequency (MHz)	Measure Level (dBuV/m)	Reading Level (dBuV)	Over Limit (dB)	Limit (dBuV/m)	Factor (dB)	Type
1		2390.000	54.412	18.668	-19.588	74.000	35.745	PK
2	*	2402.387	100.042	63.946	26.042	74.000	36.096	PK

Profile: 20C0553R	Page No.: 26
Engineer: YULIU	
Site: AC5	Time: 2020/04/28 - 21:39
Limit: FCC_Part15.209_RE(3m)	Margin: 0
Probe: Horn_3117_00167055(1-18GHz)	Polarity: Vertical
EUT: LED Lamp	Power: AC 120V/60Hz
Note: Mode 4:Transmit at 2402MHz	

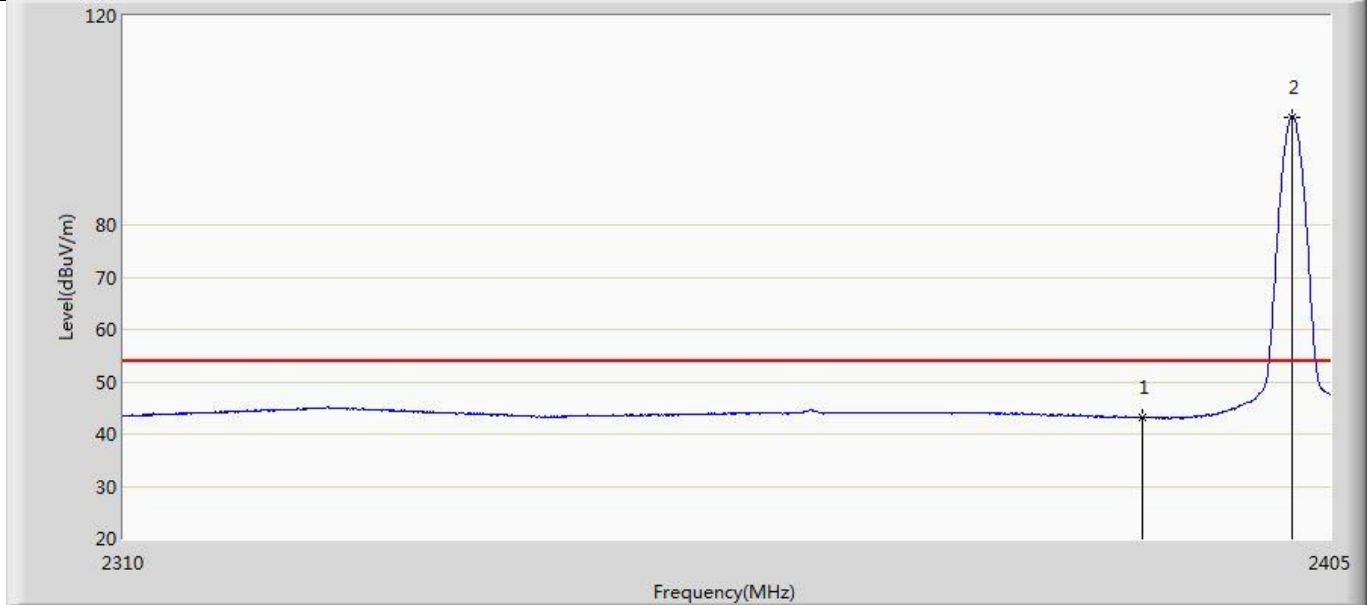

No	Mark	Frequency (MHz)	Measure Level (dBuV/m)	Reading Level (dBuV)	Over Limit (dB)	Limit (dBuV/m)	Factor (dB)	Type
1		2390.000	43.261	7.517	-10.739	54.000	35.745	AV
2	*	2401.913	100.660	64.599	46.660	54.000	36.061	AV

Profile: 20C0553R	Page No.: 27
Engineer: YULIU	
Site: AC5	Time: 2020/04/28 - 21:42
Limit: FCC_Part15.209_RE(3m)	Margin: 0
Probe: Horn_3117_00167055(1-18GHz)	Polarity: Horizontal
EUT: LED Lamp	Power: AC 120V/60Hz
Note: Mode 4:Transmit at 2402MHz	

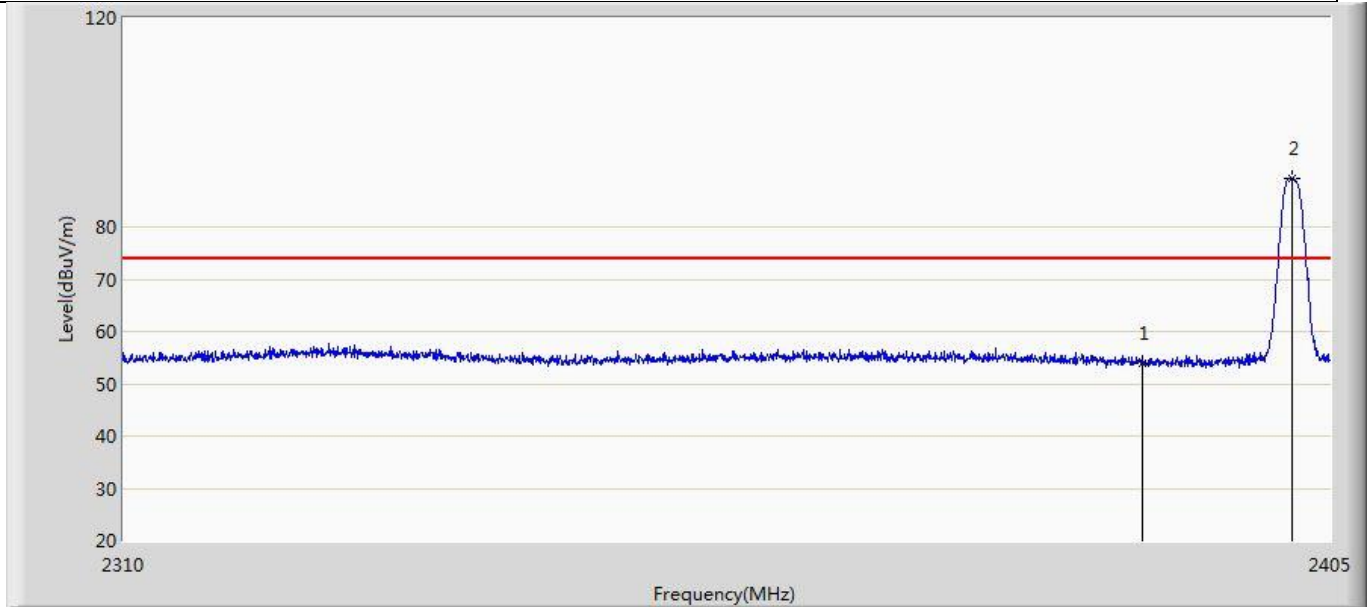

No	Mark	Frequency (MHz)	Measure Level (dBuV/m)	Reading Level (dBuV)	Over Limit (dB)	Limit (dBuV/m)	Factor (dB)	Type
1		2390.000	54.044	18.300	-19.956	74.000	35.745	PK
2	*	2401.960	89.345	53.280	15.345	74.000	36.064	PK

Profile: 20C0553R	Page No.: 28
Engineer: YULIU	
Site: AC5	Time: 2020/04/28 - 21:44
Limit: FCC_Part15.209_RE(3m)	Margin: 0
Probe: Horn_3117_00167055(1-18GHz)	Polarity: Horizontal
EUT: LED Lamp	Power: AC 120V/60Hz
Note: Mode 4:Transmit at 2402MHz	

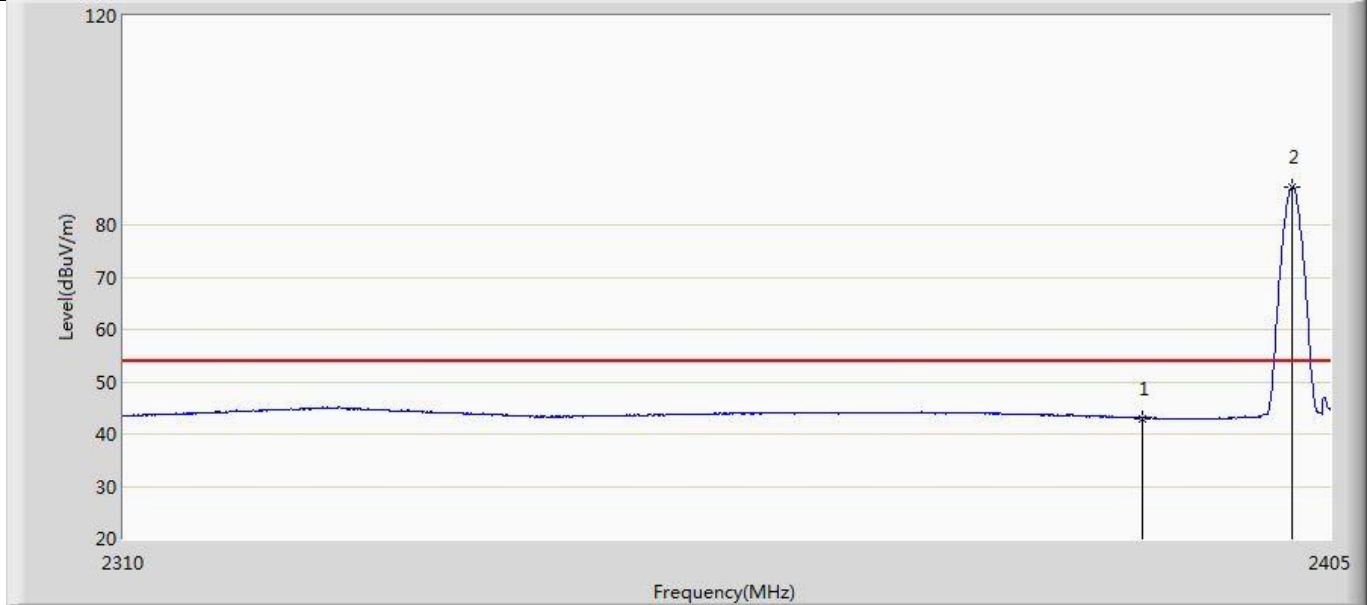

No	Mark	Frequency (MHz)	Measure Level (dBuV/m)	Reading Level (dBuV)	Over Limit (dB)	Limit (dBuV/m)	Factor (dB)	Type
1		2390.000	43.043	7.299	-10.957	54.000	35.745	AV
2	*	2401.960	87.258	51.193	33.258	54.000	36.064	AV

Profile: 20C0553R	Page No.: 29
Engineer: YULIU	
Site: AC5	Time: 2020/04/28 - 21:46
Limit: FCC_Part15.209_RE(3m)	Margin: 0
Probe: Horn_3117_00167055(1-18GHz)	Polarity: Vertical
EUT: LED Lamp	Power: AC 120V/60Hz
Note: Mode 4:Transmit at 2480MHz	

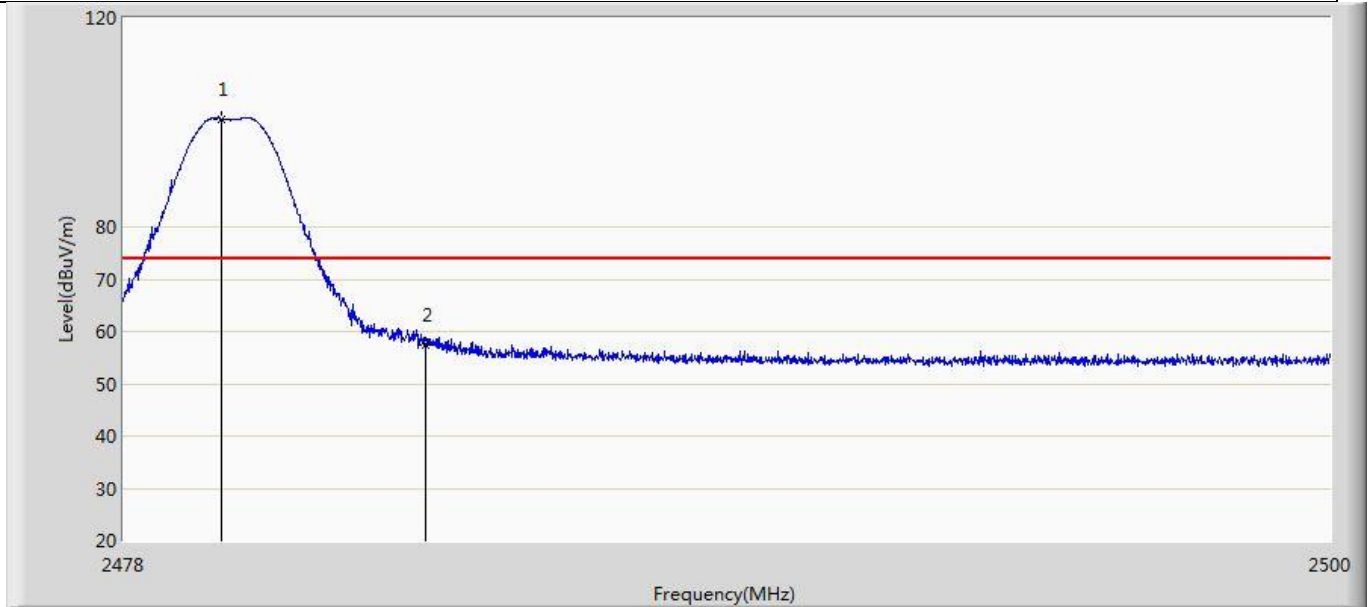

No	Mark	Frequency (MHz)	Measure Level (dBuV/m)	Reading Level (dBuV)	Over Limit (dB)	Limit (dBuV/m)	Factor (dB)	Type
1	*	2479.771	100.646	63.808	26.646	74.000	36.839	PK
2		2483.500	57.433	20.734	-16.567	74.000	36.699	PK

Profile: 20C0553R	Page No.: 30
Engineer: YULIU	
Site: AC5	Time: 2020/04/28 - 21:51
Limit: FCC_Part15.209_RE(3m)	Margin: 0
Probe: Horn_3117_00167055(1-18GHz)	Polarity: Vertical
EUT: LED Lamp	Power: AC 120V/60Hz
Note: Mode 4:Transmit at 2480MHz	

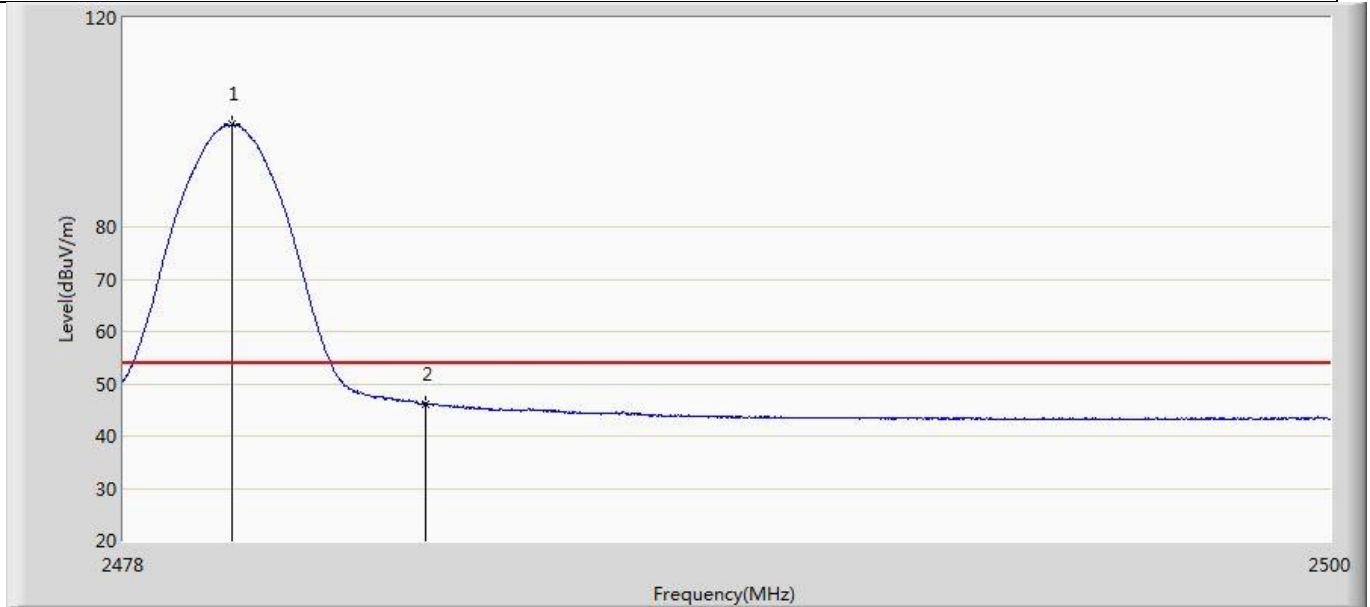

No	Mark	Frequency (MHz)	Measure Level (dBuV/m)	Reading Level (dBuV)	Over Limit (dB)	Limit (dBuV/m)	Factor (dB)	Type
1	*	2479.980	99.588	62.757	45.588	54.000	36.831	AV
2		2483.500	46.178	9.479	-7.822	54.000	36.699	AV

Profile: 20C0553R	Page No.: 31
Engineer: YULIU	
Site: AC5	Time: 2020/04/28 - 21:54
Limit: FCC_Part15.209_RE(3m)	Margin: 0
Probe: Horn_3117_00167055(1-18GHz)	Polarity: Horizontal
EUT: LED Lamp	Power: AC 120V/60Hz
Note: Mode 4:Transmit at 2480MHz	

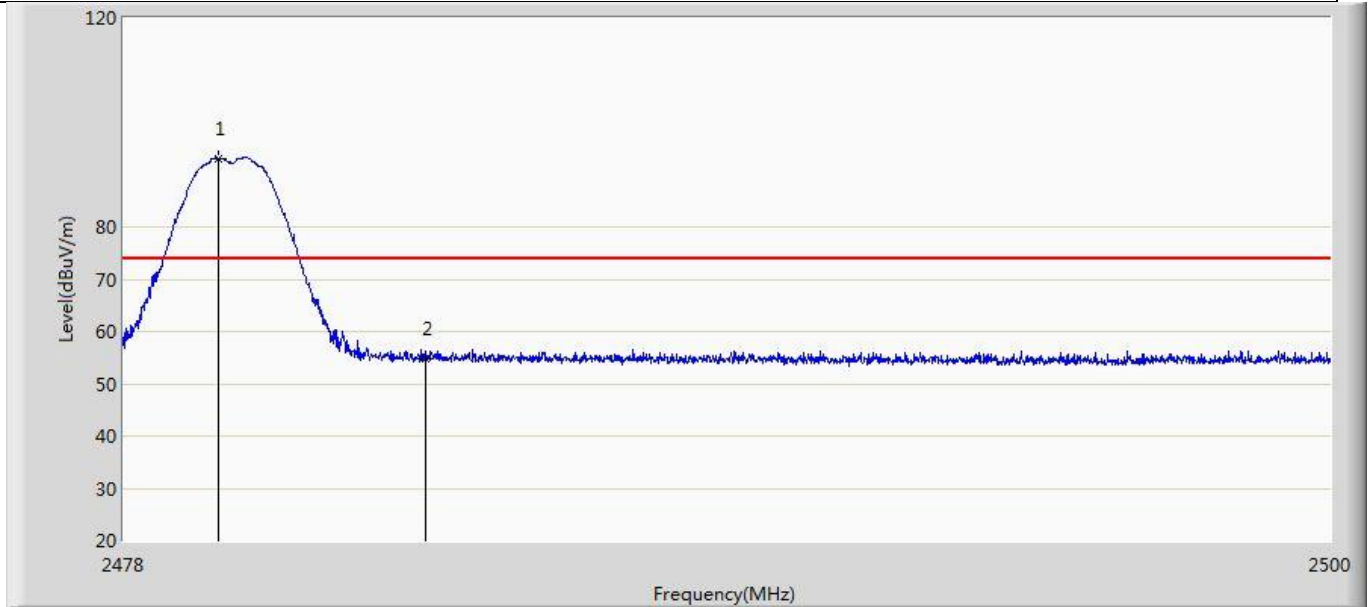

No	Mark	Frequency (MHz)	Measure Level (dBuV/m)	Reading Level (dBuV)	Over Limit (dB)	Limit (dBuV/m)	Factor (dB)	Type
1	*	2479.738	93.156	56.316	19.156	74.000	36.840	PK
2		2483.500	54.856	18.157	-19.144	74.000	36.699	PK

Profile: 20C0553R	Page No.: 32
Engineer: YULIU	
Site: AC5	Time: 2020/04/28 - 21:56
Limit: FCC_Part15.209_RE(3m)	Margin: 0
Probe: Horn_3117_00167055(1-18GHz)	Polarity: Horizontal
EUT: LED Lamp	Power: AC 120V/60Hz
Note: Mode 4:Transmit at 2480MHz	

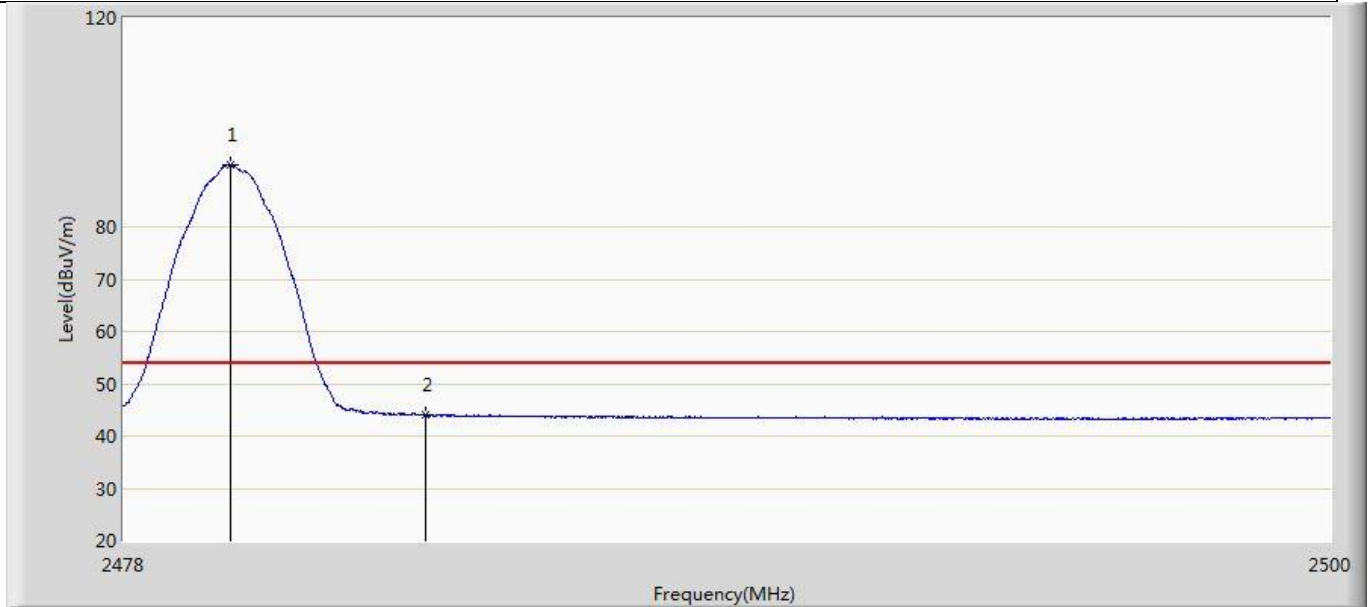

No	Mark	Frequency (MHz)	Measure Level (dBuV/m)	Reading Level (dBuV)	Over Limit (dB)	Limit (dBuV/m)	Factor (dB)	Type
1	*	2479.947	91.908	55.076	37.908	54.000	36.832	AV
2		2483.500	44.058	7.359	-9.942	54.000	36.699	AV

4.6 DTS Bandwidth

VERDICT: PASS

4.6.1 Limit

Standard FCC Part 15 Subpart C Paragraph 15.247 (a)(2)

Systems using digital modulation techniques operate in the 2400-2483.5 MHz. The minimum 6 dB bandwidth shall be at least 500 kHz

4.6.2 Test Setup

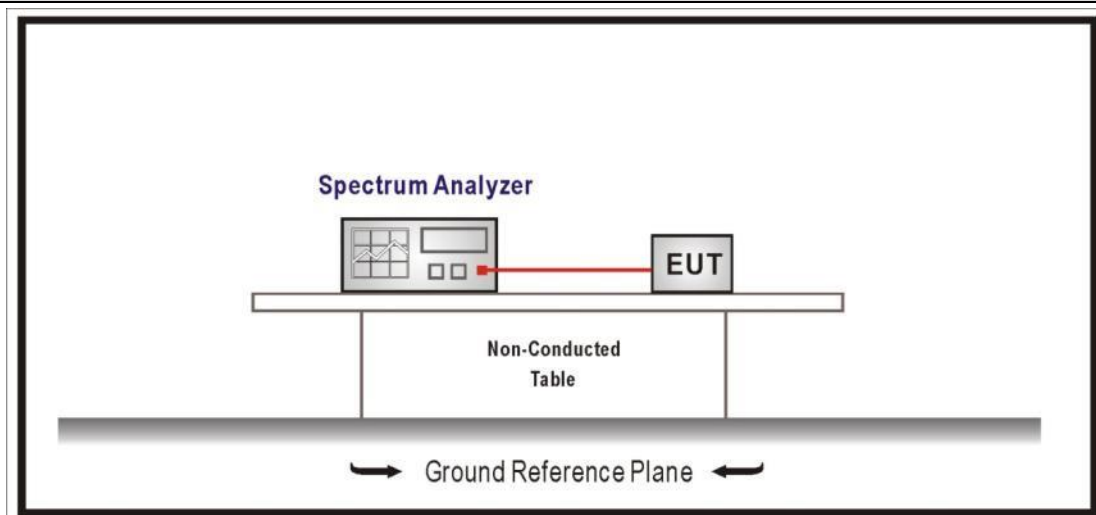

4.6.3 Test Procedure

	Reference Rule	Chapter	Description
<input checked="" type="checkbox"/>	ANSI C63.10	11.8	DTS bandwidth
<input type="checkbox"/>	ANSI C63.10	11.8.1	Option 1
<input checked="" type="checkbox"/>	ANSI C63.10	11.8.2	Option 2

4.6.4 Test Data

Mode	CH.	Test Freq. (MHz)	99% Occupied Bandwidth (kHz)	6dB Occupied Bandwidth (kHz)	Limit (kHz)	Result
1	00	2402	1074.9	694.7	>500	Pass
	19	2440	1071.6	693.0	>500	Pass
	39	2480	1066.5	688.9	>500	Pass
2	00	2402	2171.4	1384.0	>500	Pass
	19	2440	2175.4	1382.0	>500	Pass
	39	2480	2179.8	1376.0	>500	Pass
3	00	2402	1139.3	789.6	>500	Pass
	19	2440	1131.4	784.0	>500	Pass
	39	2480	1128.5	782.0	>500	Pass
4	00	2402	1149.9	736.4	>500	Pass
	19	2440	1143.1	734.4	>500	Pass
	39	2480	1140.7	733.7	>500	Pass

Note : The worst case of Occupied Bandwidth as below:

99% Occupied Bandwidth
Mode 1 CH39 (2480MHz)

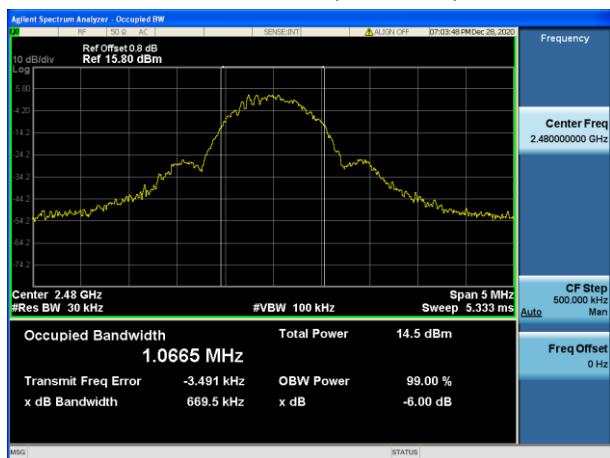

6dB Occupied Bandwidth
Mode 1 CH39 (2480MHz)

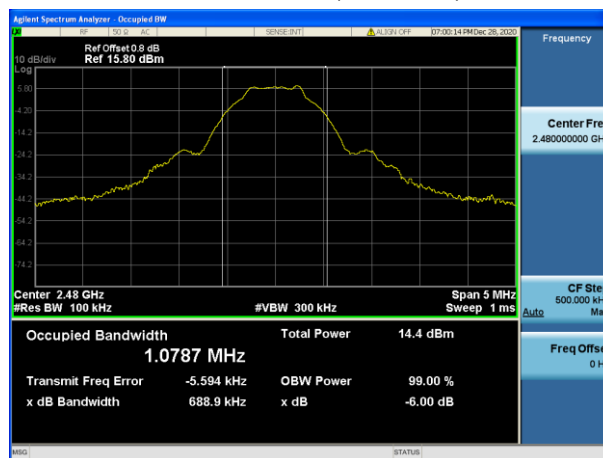

4.7 Fundamental emission output power	VERDICT: PASS
--	----------------------

4.7.1 Limit		
Standard	FCC Part 15 Subpart C Paragraph 15.247 (b)(3)	
<input checked="" type="checkbox"/>	GTX < 6dBi	Pout ≤ 30dBm
<input type="checkbox"/>	GTX > 6dBi	
<input type="checkbox"/>	Non-Fix point-point	Pout ≤ 30 - (GTX - 6)
<input type="checkbox"/>	Fix point-point	Pout ≤ 30 - [(GTX - 6)]/3
<input type="checkbox"/>	Point-to-multipoint	Pout ≤ 30 - (GTX - 6)
<input type="checkbox"/>	Overlap Beams	Pout ≤ 30 - [(GTX - 6)]/3
<input type="checkbox"/>	Aggregate power transmitted simultaneously on all beams	Pout ≤ 30 - [(GTX - 6)]/3
<input type="checkbox"/>	single directional beam	Pout ≤ 30 - [(GTX - 6)]/3 + 8dB

Note 1 : GTX directional gain of transmitting antennas.
 Note 2 : Pout is maximum peak conducted output power .

4.7.2 Test Setup

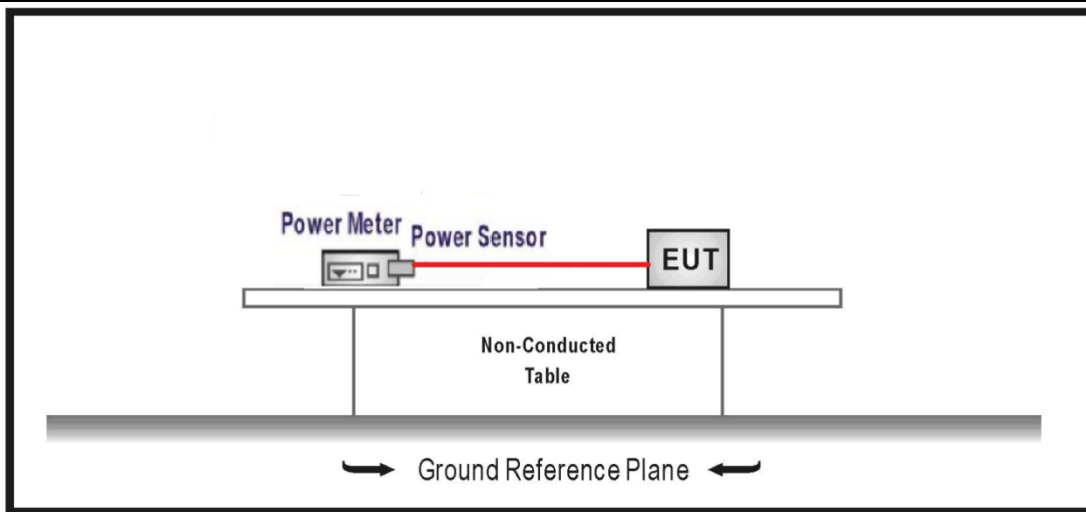

4.7.3 Test Procedure					
	References Rule		Chapter	Description	
<input checked="" type="checkbox"/>	ANSI C63.10		11.9	Fundamental emission output power	
	<input checked="" type="checkbox"/>	ANSI C63.10	11.9.1	Maximum peak conducted output power	
	<input type="checkbox"/>	ANSI C63.10	11.9.1.1	RBW \geq DTS bandwidth	
	<input type="checkbox"/>	ANSI C63.10	11.9.1.2	Integrated band power method	
	<input type="checkbox"/>	ANSI C63.10	11.9.1.3	PKPM1 Peak power meter method	
	<input type="checkbox"/>	ANSI C63.10	11.9.2	Maximum conducted (average) output power	
	<input type="checkbox"/>	ANSI C63.10	11.9.2.2	Measurement using a spectrum analyzer (SA)	
		<input type="checkbox"/>	ANSI C63.10	11.9.2.2.2	Method AVGSA-1(Duty cycle \geq 98%)
		<input type="checkbox"/>	ANSI C63.10	11.9.2.2.3	Method AVGSA-1A(Duty cycle \geq 98%)
		<input type="checkbox"/>	ANSI C63.10	11.9.2.2.4	Method AVGSA-2(Duty cycle \leq 98%)
		<input type="checkbox"/>	ANSI C63.10	11.9.2.2.5	Method AVGSA-2A(Duty cycle \leq 98%)
		<input type="checkbox"/>	ANSI C63.10	11.9.2.2.4	Method AVGSA-3
		<input type="checkbox"/>	ANSI C63.10	11.9.2.2.5	Method AVGSA-3A
	<input checked="" type="checkbox"/>	ANSI C63.10	11.9.2.3	Measurement using a power meter (PM)	
		<input checked="" type="checkbox"/>	ANSI C63.10	11.9.2.3.1	Method AVGPM
		<input type="checkbox"/>	ANSI C63.10	11.9.2.3.2	Method AVGPM-G

4.7.4 Test Data

Mode	Channel	Test Frequency (MHz)	Power Output (dBm)	Limit (dBm)	Result
Mode 1	00	2402	8.95	≤ 30	Pass
	19	2440	8.56	≤ 30	Pass
	39	2480	8.32	≤ 30	Pass
Mode 2	00	2402	9.06	≤ 30	Pass
	19	2440	8.71	≤ 30	Pass
	39	2480	8.41	≤ 30	Pass
Mode 3	00	2402	8.94	≤ 30	Pass
	19	2440	8.60	≤ 30	Pass
	39	2480	8.32	≤ 30	Pass
Mode 4	00	2402	8.95	≤ 30	Pass
	19	2440	8.58	≤ 30	Pass
	39	2480	8.29	≤ 30	Pass

4.8 Power Density

VERDICT: PASS

4.8.1 Limit:

Standard FCC Part 15 Subpart C Paragraph 15.247 (b)(3)

Power Spectral Density $\leq 8\text{dBm}/3\text{kHz}$

4.8.2 Test Setup

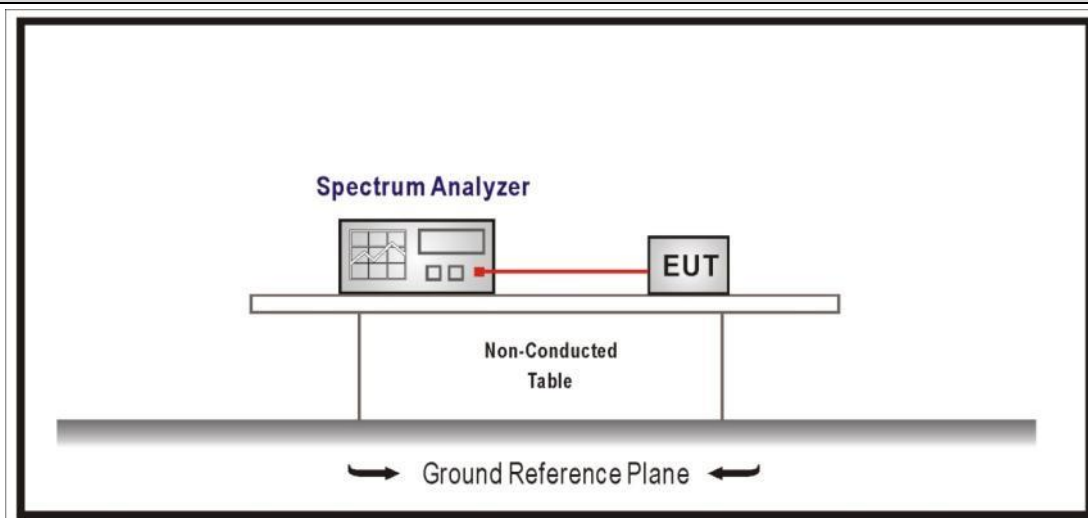

4.8.3 Test Procedure

	References Rule	Chapter	Description
<input checked="" type="checkbox"/>	ANSI C63.10	11.10	Maximum power spectral density level in the fundamental emission
<input checked="" type="checkbox"/>	ANSI C63.10	11.10.2	Method PKPSD (peak PSD)
<input type="checkbox"/>	ANSI C63.10	11.10.3	Method AVGPSD-1(Duty cycle $\geq 98\%$)
<input type="checkbox"/>	ANSI C63.10	11.10.4	Method AVGPSD-1A(Duty cycle $\geq 98\%$)
<input type="checkbox"/>	ANSI C63.10	11.10.5	Method AVGPSD-2(Duty cycle $< 98\%$)
<input type="checkbox"/>	ANSI C63.10	11.10.6	Method AVGPSD-2A(Duty cycle $< 98\%$)
<input type="checkbox"/>	ANSI C63.10	11.10.7	Method AVGPSD-3
<input type="checkbox"/>	ANSI C63.10	11.10.8	Method AVGPSD-3A

4.8.4 Test Data

Mode	Channel	Test Frequency (MHz)	Measurement PSD (dBm/3kHz)	Limit (dBm/3kHz)	Result
Mode 1	00	2402	-6.255	≤8	Pass
	19	2440	-6.606	≤8	Pass
	39	2480	-7.124	≤8	Pass
Mode 2	00	2402	-9.117	≤8	Pass
	19	2440	-9.464	≤8	Pass
	39	2480	-9.865	≤8	Pass
Mode 3	00	2402	-8.698	≤8	Pass
	19	2440	-9.097	≤8	Pass
	39	2480	-9.475	≤8	Pass
Mode 4	00	2402	3.411	≤8	Pass
	19	2440	2.978	≤8	Pass
	39	2480	2.509	≤8	Pass

Note : The worst case of PSD as below:

Mode 4 CH00(2402MHz)

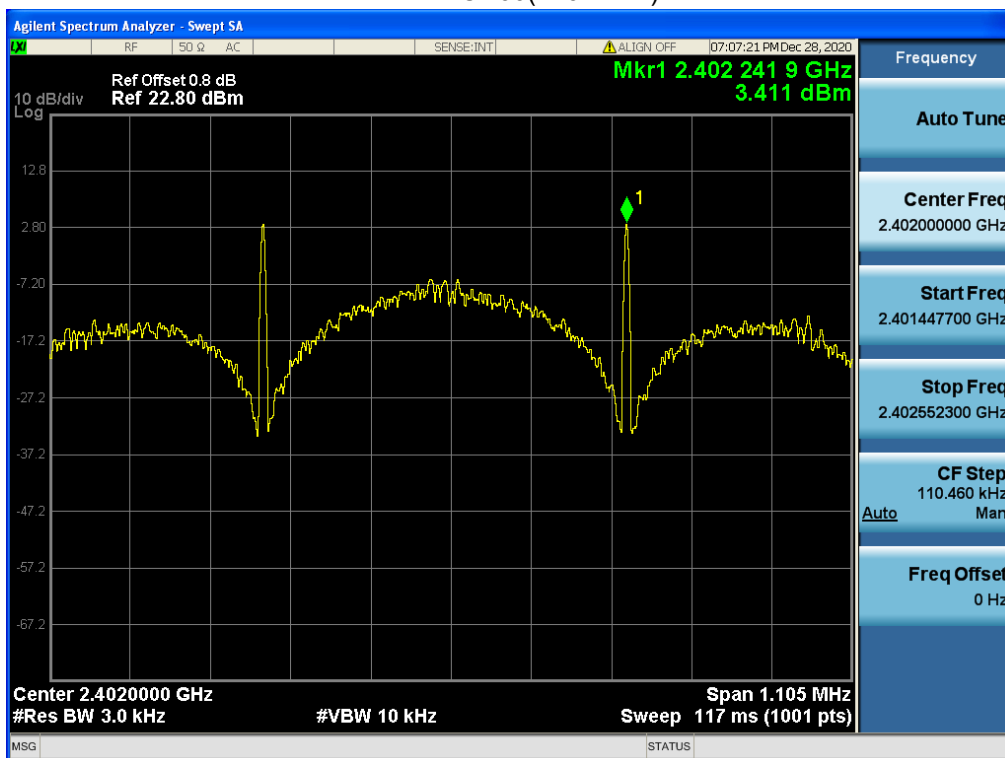

4.9 Antenna Requirement

VERDICT: PASS

4.9.1 Limit:

Standard	FCC Part 15 Subpart C Paragraph 15.203
-----------------	--

An intentional radiator shall be designed to ensure that no antenna other than that furnished by the responsible party shall be used with the device. The use of a permanently attached antenna or of an antenna that uses a unique coupling to the intentional radiator shall be considered sufficient to comply with the provisions of this section. The manufacturer may design the unit so that a broken antenna can be replaced by the user, but the use of a standard antenna jack or electrical connector is prohibited. This requirement does not apply to carrier current devices or to devices operated under the provisions of §15.211, §15.213, §15.217, §15.219, or §15.221. Further, this requirement does not apply to intentional radiators that must be professionally installed, such as perimeter protection systems and some field disturbance sensors, or to other intentional radiators which, in accordance with §15.31(d), must be measured at the installation site. However, the installer shall be responsible for ensuring that the proper antenna is employed so that the limits in this part are not exceeded.

4.9.2 Antenna Connector Construction:

- | | |
|-------------------------------------|--|
| <input checked="" type="checkbox"/> | The use of a permanently attached antenna |
| <input type="checkbox"/> | The antenna use of a unique coupling to the intentional radiator |
| <input type="checkbox"/> | The use of a nonstandard antenna jack or electrical connector |
- Please refer to the attached document "Internal Photograph" to show the antenna connector.

5 TEST SETUP PHOTO AND EUT PHOTO

Remark: The test setup photo and EUT Photo please see appendix.

_____ The End _____