



Test report No:
2140092R-RF-US-P06V02

FCC & ISED TEST REPORT

Product Name	LED Lamp
Trademark	PHILIPS
Model and /or type reference	9290024720
FCC ID	2AGBW9290024720X
IC	20812-24720X
Applicant's name / address	Signify (China) Investment Co., Ltd Building no.9, Lane 888, Tianlin Road, Minhang District, Shanghai, China
Test method requested, standard	FCC CFR Title 47 Part 15 Subpart C Section 15.247 ANSI C63.10: 2013 KD558074 D01 15.247 Meas Guidance v05r02 RSS-Gen Issue 5 RSS-247 Issue 2
Verdict Summary	IN COMPLIANCE
Tested by (name / position & signature)	Scott Shen/Project Engineer 
Approved by (name / position & signature)	Jack Zhang/Supervisor 
Date of issue	2021-06-28
Report Version	V1.0
Report template No	Template_FCC 15.247-RF-V1.0

INDEX

	page
General conditions	4
Environmental conditions	4
Possible test case verdicts	5
Abbreviations.....	5
Document History.....	6
Remarks and Comments	6
Used Equipment.....	7
Uncertainty	9
1 General Information	10
1.1 General Description of the Item(s).....	10
1.2 Antenna Information	11
1.3 Channel List.....	12
2 Description of Test Setup.....	13
2.1 Operating mode(s) used for tests	13
2.2 Auxiliary equipment / Test software for the EUT	13
2.3 Test Configuration / Block diagram used for tests.....	14
2.4 Testing process	15
3 Verdict summary section.....	16
3.1 Standards	16
3.2 Deviation(s) from the Standard(s) / Test Specification(s).....	16
3.3 Overview of results	17
3.4 Test Facility.....	18
4 Test Results	19
4.1 AC Power Line Conducted Emission.....	19
4.1.1 Limit	19
4.1.2 Test Setup	19
4.1.3 Test Procedure	19
4.1.4 Test Data	20
4.2 Emissions in restricted frequency bands	22
4.2.1 Limit	22
4.2.2 Test Setup	24
4.2.3 Test Procedure	24
4.2.4 Test Data	25
4.3 Emissions in non-restricted frequency band	51

4.3.1	Limit	51
4.3.2	Test Setup	51
4.3.3	Test Procedure	51
4.3.4	Test Data	52
4.4	Duty cycle	54
4.4.1	Limit	54
4.4.2	Test Setup	54
4.4.3	Test Procedure	54
4.4.4	Test Data	55
4.5	Radiated Emission Band Edge	56
4.5.1	Limit	56
4.5.2	Test Setup	56
4.5.3	Test Procedure	56
4.5.4	Test Data	57
4.6	DTS Bandwidth	89
4.6.1	Limit	89
4.6.2	Test Setup	89
4.6.3	Test Procedure	89
4.6.4	Test Data	90
4.7	Fundamental emission output power	91
4.7.1	Limit	91
4.7.2	Test Setup	91
4.7.3	Test Procedure	92
4.7.4	Test Data	93
4.8	Power Density	94
4.8.1	Limit:	94
4.8.2	Test Setup	94
4.8.3	Test Procedure	94
4.8.4	Test Data	95
4.9	Antenna Requirement	96
4.9.1	Limit:	96
4.9.2	Antenna Connector Construction:	96
5	Test setup photo and EUT Photo	97

COMPETENCES AND GUARANTEES

DEKRA is a testing laboratory competent to carry out the tests described in this report.

In order to assure the traceability to other national and international laboratories, DEKRA has a calibration and maintenance program for its measurement equipment.

DEKRA guarantees the reliability of the data presented in this report, which is the result of the measurements and the tests performed to the item under test on the date and under the conditions stated in the report and it is based on the knowledge and technical facilities available at DEKRA at the time of performance of the test.

DEKRA is liable to the client for the maintenance of the confidentiality of all information related to the item under test and the results of the test.

The results presented in this Test Report apply only to the particular item under test established in this document.

IMPORTANT: No parts of this report may be reproduced or quoted out of context, in any form or by any means, except in full, without the previous written permission of DEKRA.

GENERAL CONDITIONS

Test Location	No. 99, Hongye Road, Suzhou Industrial Park Suzhou, 215006, P.R. China
Date(receive sample)	Apr. 06, 2021
Date (start test)	Apr. 07, 2021
Date (finish test)	Apr. 27, 2021

1. This report is only referred to the item that has undergone the test.
2. This report does not constitute or imply on its own an approval of the product by the Certification Bodies or Competent Authorities.
3. This document is only valid if complete; no partial reproduction can be made without previous written permission of DEKRA.
4. This test report cannot be used partially or in full for publicity and/or promotional purposes without previous written permission of DEKRA.

ENVIRONMENTAL CONDITIONS

The climatic conditions during the tests are within the limits specified by the manufacturer for the operation of the EUT and the test equipment. The climatic conditions during the tests were within the following limits:

Ambient temperature	15 °C – 35 °C
Relative Humidity air	30% - 60%

If explicitly required in the basic standard or applied product / product family standard the climatic values are recorded and documented separately in this test report.

POSSIBLE TEST CASE VERDICTS

Test case does not apply to test object	N/A
Test object does meet requirement	P (Pass) / PASS
Test object does not meet requirement	F (Fail) / FAIL
Not measured	N/M

ABBREVIATIONS

For the purposes of the present document, the following abbreviations apply:

EUT	: Equipment Under Test
QP	: Quasi-Peak
CAV	: CISPR Average
AV	: Average
CDN	: Coupling Decoupling Network
SAC	: Semi-Anechoic Chamber
OATS	: Open Area Test Site
BW	: Bandwidth
AM	: Amplitude Modulation
PM	: Pulse Modulation
HCP	: Horizontal Coupling Plane
VCP	: Vertical Coupling Plane
U_N	: Nominal voltage
T_x	: Transmitter
R_x	: Receiver
N/A	: Not Applicable
N/M	: Not Measured

DOCUMENT HISTORY

Report No.	Version	Description	Issued Date
2140092R-RF-US-P06V02	V1.0	Initial issue of report.	2021-06-28

REMARKS AND COMMENTS

1. The equipment under test (EUT) does meet the essential requirements of the stated standard(s)/test(s).
2. These test results on a sample of the device are for the purpose of demonstrating Compliance with Part 15 Subpart C Paragraph 15.247, RSS-Gen Issue 5, RSS-247 Issue 2.
3. The measurement result is considered in conformance with the requirement if it is within the prescribed limit, It is not necessary to account the uncertainty associated with the measurement result.
4. The test results presented in this report relate only to the object tested.
5. The test report shall not be reproduced without the written approval of DEKRA Testing and Certification (Suzhou) Co., Ltd.
6. This report will not be used for social proof function in China market.
7. DEKRA declines any responsibility with the following test data provided by customer that may affect the validity of result:
 - Chapter 1.1 General Description of the Item(s);
 - Chapter 1.2 Antenna Information;
 - Chapter 1.3 Channel List.

USED EQUIPMENT

AC Power Line Conducted Emission / TR1

Instrument	Manufacturer	Model No.	Serial No.	Cal. Date	Next Cal. Date
Two-Line V-Network	R&S	ENV216	101044	2021.03.20	2022.03.19
50ohm Termination	SHX	TF2	7081402	2020.09.23	2021.09.22
50ohm Termination	SHX	TF2	7081403	2020.09.23	2021.09.22
50ohm Coaxial Switch	Anritsu	MP59B	6200464462	N/A	N/A
Temperature/Humidity Meter	RTS	RTS-8S	TR1-TH	2020.08.23	2021.08.22
Dekra test software	Dekra	-	-	-	-

Emissions in non-restricted frequency bands/ Occupied Bandwidth/ Fundamental emission output power/ Power Spectral Density / TR8

Instrument	Manufacturer	Model No.	Serial No.	Cal. Date	Next Cal. Date
Spectrum Analyzer	Agilent	N9010A	MY48030494	2020.08.15	2021.08.14
EXA Spectrum Analyzer	Keysight	N9010A	MY55370495	2021.03.20	2022.03.19
MXA Signal Analyzer	Keysight	N9020A	MY56060147	2020.08.15	2021.08.14
4TX MIMO Power Sensor	Keysight	X8750A	MY59400102	2021.02.11	2022.02.10
Coaxial Cable	Woken	SFL402	F02-150410-044	2021.01.01	2021.12.31
Temperature/Humidity Meter	RTS	RTS-8S	RF08	2020.08.13	2021.08.12

Radiated Emission(30MHz-1GHz) / AC3

Instrument	Manufacturer	Model No.	Serial No.	Cal. Date	Next Cal. Date
EMI Test Receiver	R&S	ESCI	100176	2020.08.15	2021.08.14
Bilog Antenna	Teseq GmbH	CBL6112D	27613	2020.08.19	2021.08.18
Coaxial Cable	Huber+Suhner	RG 214	AC3-C	2021.03.31	2022.03.30
Temperature/Humidity Meter	RTS	RTS-8S	AC3-TH	2020.08.13	2021.08.12
Dekra test software	Dekra	-	-	-	-

Radiated Emission(1GHz-40GHz) / AC5

Instrument	Manufacturer	Model No.	Serial No.	Cal. Date	Next Cal. Date
EXA Spectrum Analyzer	Keysight	N9010A	MY55370495	2021.03.20	2022.03.19
Amplifier	Keleto	LNPA	SK20190225	2020.09.25	2021.09.24
Preamplifier	EMCI	EMC184045SE	980263	2020.05.24	2021.05.23
DRG Horn Antenna	ETS-Lindgren	3117	00167055	2020.08.06	2021.08.05
Broad-Band Horn Antenna	Schwarzbeck	BBHA9170	294	2021.04.14	2023.04.13
Coaxial Cable	Huber+Suhner	SUCOFLEX 106	AC5-C2	2021.03.31	2022.03.30
Coaxial Cable	ROSENBERGER	LA1-C011- 2000/3000	AC5-40G	2021.03.20	2022.03.19
Temperature/Humidity Meter	RTS	RTS-8S	AC5-TH	2020.08.13	2021.08.12
Dekra test software	Dekra	-	-	-	-

UNCERTAINTY

Uncertainties have been calculated according to the DEKRA internal document. The reported expanded uncertainties are based on a standard uncertainty multiplied by a coverage factor of $k=2$, providing a level of confidence of approximately 95%. The Uncertainties is comply with standard required as below.

Test item	Uncertainty
AC Power Line Conducted Emission	9kHz~150kHz: 2.80dB 150kHz~30MHz: 2.40dB
Peak Power Output	± 1.27 dB
Radiated Emission(30MHz~1GHz)	Horizontal: 30MHz~200MHz: 3.50 dB 300MHz~1GHz: 3.60 dB Vertical: 30MHz~200MHz: 3.60 dB 300MHz~1GHz: 3.50 dB
Radiated Emission(1GHz~26.5GHz)	Horizontal: 1GHz~18GHz: 5.00 dB Vertical: 1GHz~18GHz: 4.80 dB
RF antenna conducted test	± 1.27 dB
Radiated Emission Band Edge	± 3.9 dB
DTS Bandwidth	± 150 Hz
Occupied Bandwidth	± 1 kHz
Power Density	± 1.27 dB

1 GENERAL INFORMATION

1.1 General Description of the Item(s)

Product Name	LED Lamp
Model No.	9290024720
FCC ID	2AGBW9290024720X
IC	20812-24720X
Manufacturer	Signify (China) Investment Co., Ltd
Manufacturer Address	Building no.9, Lane 888, Tianlin Road, Minhang District, Shanghai, China

Wireless specification.....	Bluetooth 5.0					
Operating frequency range(s)	2400~2483.5MHz					
Type of Modulation.....	GFSK					
PHYs	<input checked="" type="checkbox"/>	LE 1M	<input checked="" type="checkbox"/>	LE 2M	<input checked="" type="checkbox"/>	LE Coded S=2/8
Data Rate	<input checked="" type="checkbox"/>	1Mbit/s	<input checked="" type="checkbox"/>	2Mbit/s	<input checked="" type="checkbox"/>	500/125 Kbit/s
Number of channel	40					

Rated power supply	Voltage and Frequency					
	<input type="checkbox"/>	AC: 220 – 240 V, 50/60 Hz				
	<input checked="" type="checkbox"/>	AC: 110 – 130 Vac, 50/60 Hz				
	<input type="checkbox"/>	DC: 24 Vdc				
	<input type="checkbox"/>	Battery:				
Mounting position	<input type="checkbox"/>	Table top equipment				
	<input checked="" type="checkbox"/>	Wall/Ceiling mounted equipment				
	<input type="checkbox"/>	Floor standing equipment				
	<input type="checkbox"/>	Head-mounted equipment				
	<input type="checkbox"/>	Other:				

1.2 Antenna Information

Antenna model / type number	N/A		
Antenna serial number	N/A		
Antenna Delivery	<input checked="" type="checkbox"/>	1TX + 1RX	
	<input type="checkbox"/>	2TX + 2RX	
Antenna technology	<input checked="" type="checkbox"/>	SISO	
	<input type="checkbox"/>	MIMO	<input type="checkbox"/> CDD <input type="checkbox"/> Beam-forming
Antenna Type	<input type="checkbox"/>	External	<input type="checkbox"/> Dipole
			<input type="checkbox"/> Sectorized
	<input checked="" type="checkbox"/>	Internal	<input type="checkbox"/> PIFA
			<input checked="" type="checkbox"/> PCB
			<input type="checkbox"/> Metal Monopole Antenna
		<input type="checkbox"/> Others.....	
Antenna Gain	-1 dBi		

1.3 Channel List

Bluetooth Working Frequency of Each Channel:							
Channel	Frequency	Channel	Frequency	Channel	Frequency	Channel	Frequency
00	2402 MHz	01	2404 MHz	02	2406 MHz	03	2408 MHz
04	2410 MHz	05	2412 MHz	06	2414 MHz	07	2416 MHz
08	2418 MHz	09	2420 MHz	10	2422 MHz	11	2424 MHz
12	2426 MHz	13	2428 MHz	14	2430 MHz	15	2432 MHz
16	2434 MHz	17	2436 MHz	18	2438 MHz	19	2440 MHz
20	2442 MHz	21	2444 MHz	22	2446 MHz	23	2448 MHz
24	2450 MHz	25	2452 MHz	26	2454 MHz	27	2456 MHz
28	2458 MHz	29	2460 MHz	30	2462 MHz	31	2464 MHz
32	2466 MHz	33	2468 MHz	34	2470 MHz	35	2472 MHz
36	2474 MHz	37	2476 MHz	38	2478 MHz	39	2480 MHz

Note: The general description of the Item(s), antenna information and channel list in clause 1 are provided and confirmed by the client.

2 DESCRIPTION OF TEST SETUP

2.1 Operating mode(s) used for tests

During the tests the following operating mode(s) has(have) been used.

Test Mode For Bluetooth	Mode1: Transmit by LE_1Mbps
	Mode2: Transmit by LE_2Mbps
	Mode3: Transmit by LE_Coded S=2
	Mode4: Transmit by LE_Coded S=8

2.2 Auxiliary equipment / Test software for the EUT

Auxiliary equipment	Type / Version	Manufacturer	Supplied by
Notebook	Think pad x220	Lenovo	Adapter
Software	Type / Version	Manufacturer	Supplied by
ApprobationTool	N/A	N/A	N/A

2.3 Test Configuration / Block diagram used for tests

Test setup Diagram- AC Line Conducted Emission Test

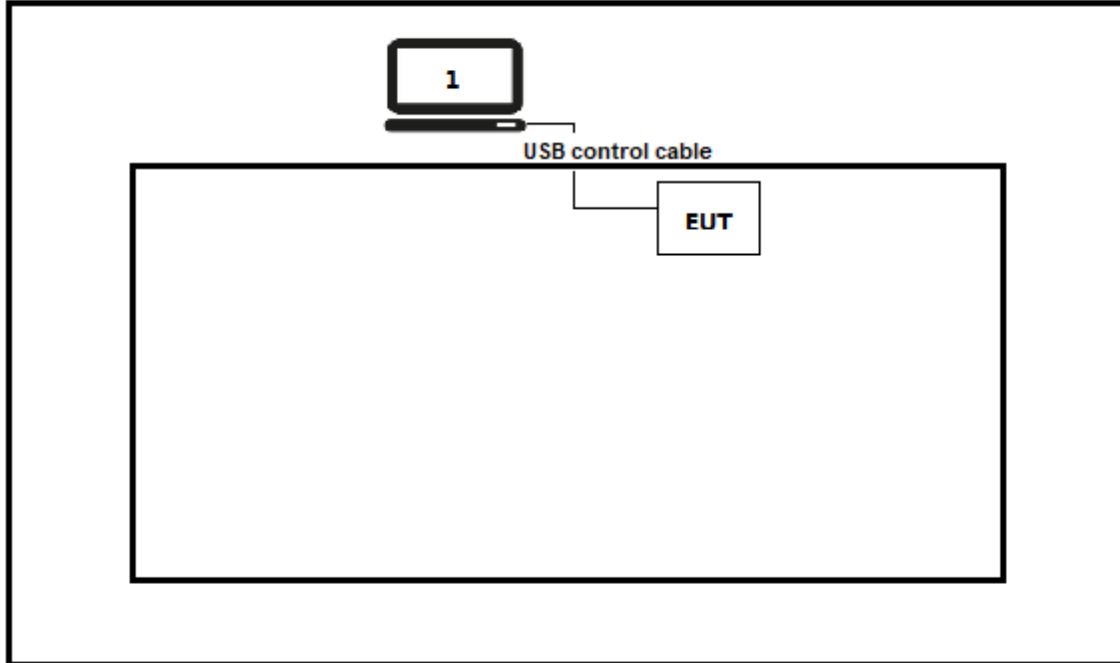

Test setup Diagram- Radiated Emission

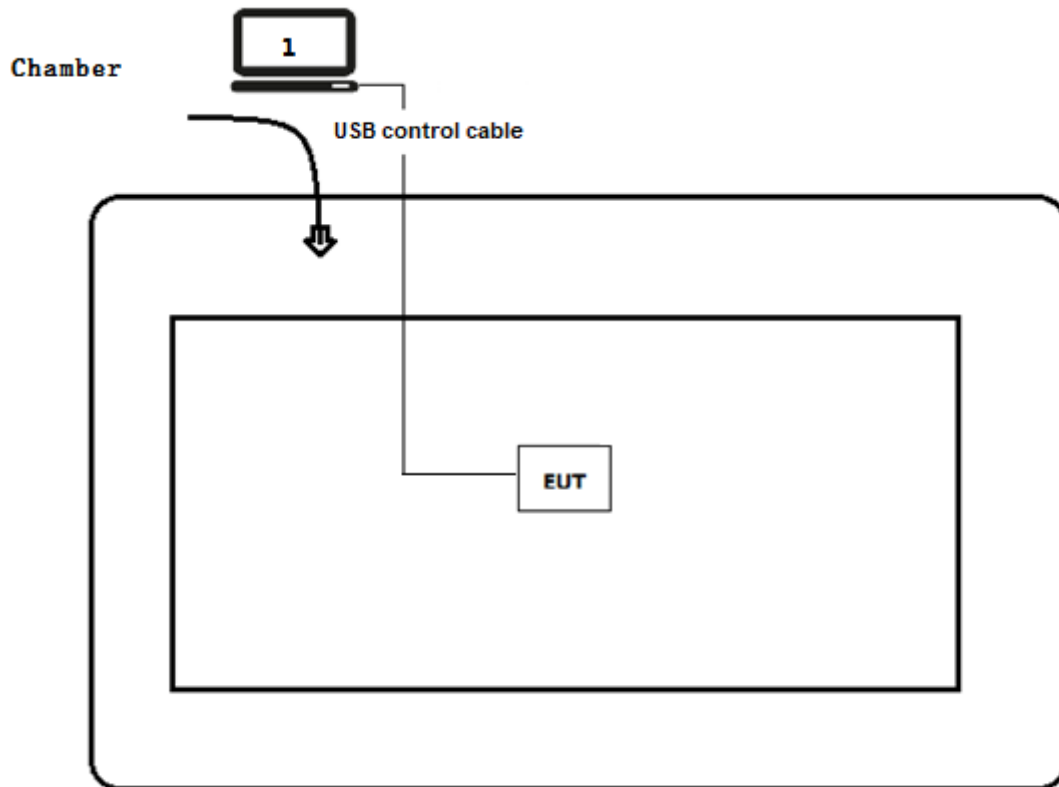

2.4 Testing process

1	Setup the EUT as shown in Section 2.3.
2	Execute test software“ApprobationTool”on the notebook.
3	Configure the test mode, the test channel, and the data rate.
4	Verify that the EUT works properly.

3 VERDICT SUMMARY SECTION

This chapter presents an overview of standards and results. Refer to the next chapters for details of measured test results and applied test levels.

3.1 Standards

Standard	Year	Description
FCC CFR Title 47 Part 15 Subpart C Section 15.247	2021	Operation within the bands 902–928 MHz, 2400–2483.5 MHz, and 5725–5850 MHz.
ANSI C63.10	2013	American National Standard of Procedures for Compliance Testing of Unlicensed Wireless Devices
KDB558074 D01 v05r02	2019	Guidance for performing compliance measurements on Digital Transmission System (DTS) operating under section 15.247
RSS-Gen Issue 5 Amendment 2	2021	General Requirements for Compliance of Radio Apparatus
RSS-247 Issue 2	2017	Digital Transmission Systems (DTSs), Frequency Hopping Systems (FHSs) and Licence-Exempt Local Area Network (LE-LAN) Devices

3.2 Deviation(s) from the Standard(s) / Test Specification(s)

The following deviation(s) was / were made from the published requirements of the listed standards: N/A.

(Please define the deviations from the standard(s) if applicable)

3.3 Overview of results

For FCC

Requirement – Test case	Basic standard(s)	Verdict	Remark
AC Power Line Conducted Emission	FCC 15.207	PASS	---
Emissions in restricted frequency bands	FCC 15.247(b)(3)	PASS	---
Duty cycle	ANSI C63.10:2013	PASS	---
Emissions in non-restricted frequency bands	FCC 15.247(d), FCC 15.209	PASS	---
Radiated Emission Band Edge	FCC 15.247(d)	PASS	---
Fundamental emission output power	FCC 15.247(d), FCC 15.209	PASS	---
DTS Bandwidth	FCC 15.247(a)(2)	PASS	---
Power Spectral Density	FCC 15.247(e)	PASS	---
Antenna Requirement	FCC 15.203	PASS	---

For ISED

Requirement – Test case	Basic standard(s)	Verdict	Remark
AC Power Line Conducted Emission	RSS-Gen Issue 5 Section 8.8	PASS	---
Emissions in restricted frequency bands	RSS-Gen Issue 5 Section 8.9	PASS	---
Duty cycle	ANSI C63.10:2013	PASS	---
Emissions in non-restricted frequency bands	RSS-247 Issue 2 Section 5.5	PASS	---
Radiated Emission Band Edge	RSS-Gen Issue 5 Section 8.10	PASS	---
Fundamental emission output power	RSS-247 Issue 2 Section 5.4(d)	PASS	---
DTS Bandwidth	RSS-Gen Issue 5 Section 6.7	PASS	---
Power Spectral Density	RSS-247 Issue 2 Section 5.2(b)	PASS	---
Antenna Requirement	RSS-Gen Issue 5 Section 6.8	PASS	---

3.4 Test Facility

USA	:	FCC Designation Number: CN1199
CA	:	ISED CAB identifier: CN0040

4 TEST RESULTS

4.1 AC Power Line Conducted Emission

VERDICT: PASS

4.1.1 Limit

Standard		
FCC Part 15 Subpart C Paragraph 15.207		
Frequency range [MHz]	Limit: QP [dB(μV) ¹⁾	Limit: AV [dB(μV) ¹⁾
0,15 - 0,50	66 - 56 ²⁾	56 - 46 ²⁾
0,50 - 5,0	56	46
5,0 - 30	60	50

¹⁾ At the transition frequency, the lower limit applies.

²⁾ The limit decreases linearly with the logarithm of the frequency.

NOTE 1: The exclusion band for transmitters shall be considered for transmitters operating at frequencies below 30 MHz.

NOTE 2: Where the AC output port is directly connected (or via a circuit breaker) to the AC power input port of the EUT the AC power output port need not to be tested.

4.1.2 Test Setup

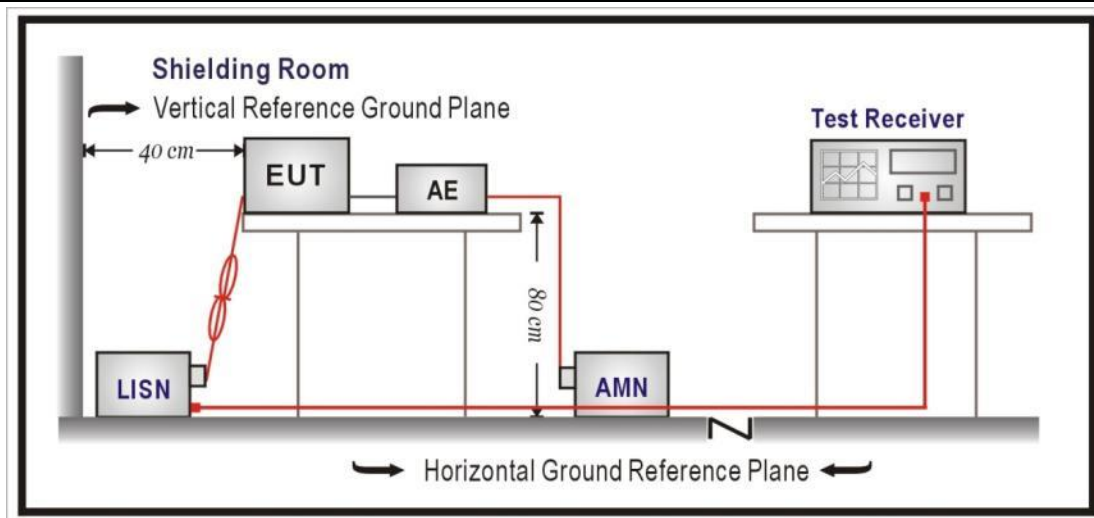

4.1.3 Test Procedure

	References Rule	Chapter	Item
<input checked="" type="checkbox"/>	ANSI C63.10-2013	6.2	Standard test method for ac power-line conducted emissions from unlicensed wireless devices

4.1.4 Test Data

Profile:2140092R	Page No.: 7
Engineer: Jun Xu	
Site: TR1	Time: 2021/04/19 - 19:00
Limit: FCC_Part15.207_CE_AC Power	Margin: 0
Probe: ENV216_101190(0.009-30MHz)	Polarity: Line
EUT: LED Lamp	Power: AC 120V/60Hz
Note: Mode 1	

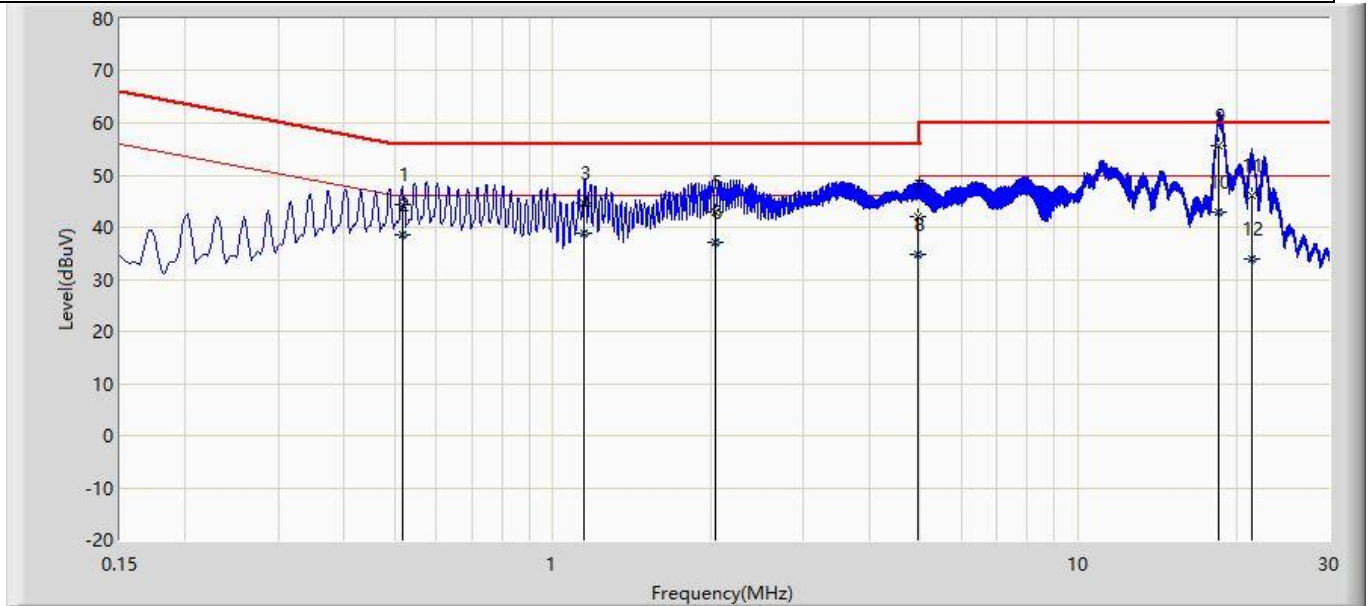

No	Mark	Frequency (MHz)	Measure Level (dBuV)	Reading Level (dBuV)	Over Limit (dB)	Limit (dBuV)	Factor (dB)	Type
1		0.517	44.323	34.485	-11.677	56.000	9.838	QP
2		0.517	38.584	28.746	-7.416	46.000	9.838	AV
3		1.149	44.745	34.766	-11.255	56.000	9.979	QP
4		1.149	38.725	28.746	-7.275	46.000	9.979	AV
5		2.038	43.038	33.001	-12.962	56.000	10.038	QP
6		2.038	37.224	27.187	-8.776	46.000	10.038	AV
7		4.936	41.972	31.831	-14.028	56.000	10.141	QP
8		4.936	34.849	24.708	-11.151	46.000	10.141	AV
9	*	18.483	55.652	45.095	-4.348	60.000	10.557	QP
10		18.483	42.787	32.230	-7.213	50.000	10.557	AV
11		21.347	46.189	35.576	-13.811	60.000	10.613	QP
12		21.347	34.034	23.422	-15.966	50.000	10.613	AV

Profile:2140092R	Page No.: 8
Engineer: Jun Xu	
Site: TR1	Time: 2021/04/19 - 19:02
Limit: FCC_Part15.207_CE_AC Power	Margin: 0
Probe: ENV216_101190(0.009-30MHz)	Polarity: Neutral
EUT: LED Lamp	Power: AC 120V/60Hz
Note: Mode 1	

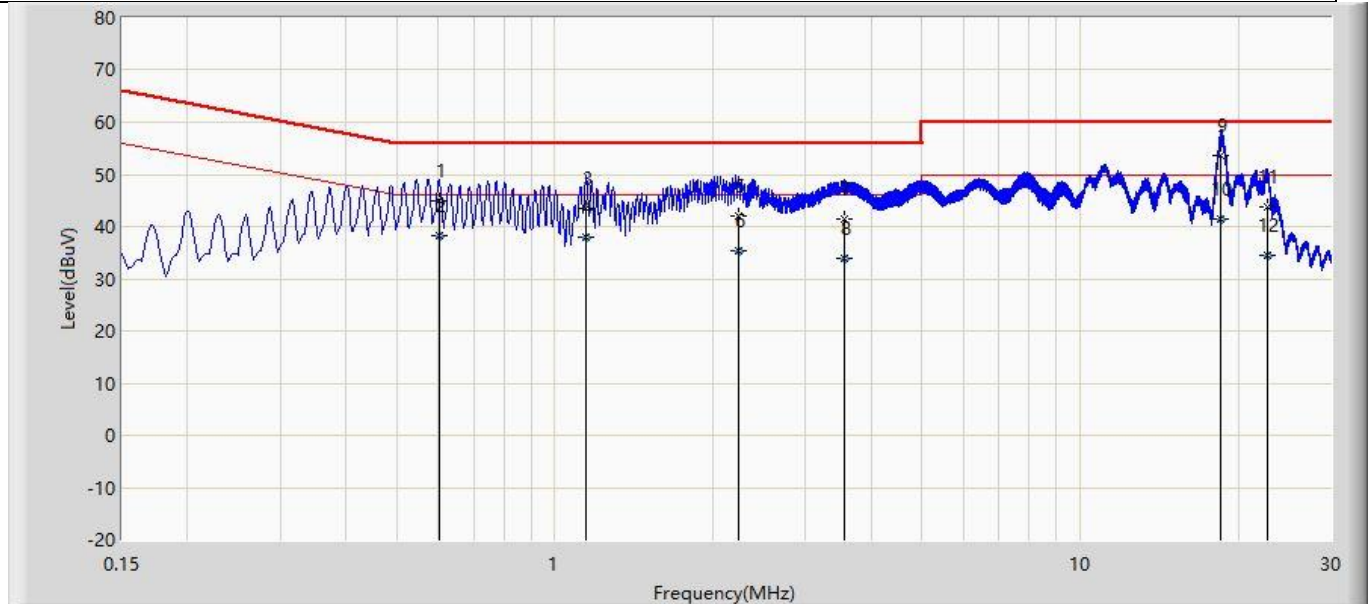

No	Mark	Frequency (MHz)	Measure Level (dBuV)	Reading Level (dBuV)	Over Limit (dB)	Limit (dBuV)	Factor (dB)	Type
1		0.602	44.966	35.111	-11.034	56.000	9.855	QP
2		0.602	38.264	28.409	-7.736	46.000	9.855	AV
3		1.147	43.358	33.409	-12.642	56.000	9.949	QP
4		1.147	38.087	28.138	-7.913	46.000	9.949	AV
5		2.238	41.991	32.035	-14.009	56.000	9.956	QP
6		2.238	35.347	25.391	-10.653	46.000	9.956	AV
7		3.557	41.576	31.571	-14.424	56.000	10.005	QP
8		3.557	34.003	23.998	-11.997	46.000	10.005	AV
9	*	18.548	53.674	43.124	-6.326	60.000	10.551	QP
10		18.548	41.470	30.920	-8.530	50.000	10.551	AV
11		22.733	43.818	33.169	-16.182	60.000	10.650	QP
12		22.733	34.458	23.808	-15.542	50.000	10.650	AV

4.2 Emissions in restricted frequency bands	VERDICT: PASS
--	----------------------

4.2.1 Limit			
Standard		FCC Part 15 Subpart C Paragraph 15.209	
Restricted Bands of operation for FCC			
Frequency (MHz)	Frequency (MHz)	Frequency (MHz)	Frequency (GHz)
0.090 – 0.110	16.42 – 16.423	399.9 – 410	4.5 – 5.15
0.495 – 0.505	16.69475 – 16.69525	608 – 614	5.35 – 5.46
2.1735 – 2.1905	16.80425 – 16.80475	960 – 1240	7.25 – 7.75
4.125 – 4.128	25.5 – 25.67	1300 – 1427	8.025 – 8.5
4.17725 – 4.17775	37.5 – 38.25	1435 – 1626.5	9.0 – 9.2
4.20725 – 4.20775	73 – 74.6	1645.5 – 1646.5	9.3 – 9.5
6.215 – 6.218	74.8 – 75.2	1660 – 1710	10.6 – 12.7
6.26775 – 6.26825	108 – 121.94	1718.8 – 1722.2	13.25 – 13.4
6.31175 – 6.31225	123 – 138	2200 – 2300	14.47 – 14.5
8.291 – 8.294	149.9 – 150.05	2310 – 2390	15.35 – 16.2
8.362 – 8.366	156.52475 – 156.52525	2483.5 – 2500	17.7 – 21.4
8.37625 – 8.38675	156.7 – 156.9	2690 – 2900	22.01 – 23.12
8.81425 – 8.81475	162.0125 – 167.17	3260 – 3267	23.6 – 24.0
12.29 – 12.293	167.72 – 173.2	3332 – 3339	31.2 – 31.8
12.51975 – 12.52025	240 – 285	3345.8 – 3358	36.43 – 36.5
12.57675 – 12.57725	322 – 335.4	3600 – 4400	
13.36 – 13.41			
Restricted Bands of operation for IC			
0.090 - 0.110	13.36 - 13.41	960 - 1427	9.0 - 9.2
0.495 - 0.505	16.42 - 16.423	1435 - 1626.5	9.3 - 9.5
2.1735 - 2.1905	16.69475 - 16.69525	1645.5 - 1646.5	10.6 - 12.7
3.020 - 3.026	16.80425 - 16.80475	1660 - 1710	13.25 - 13.4
4.125 - 4.128	25.5 - 25.67	1718.8 - 1722.2	14.47 - 14.5
4.17725 - 4.17775	37.5 - 38.25	2200 - 2300	15.35 - 16.2
4.20725 - 4.20775	73 - 74.6	2310 - 2390	17.7 - 21.4
5.677 - 5.683	74.8 - 75.2	2483.5 - 2500	22.01 - 23.12
6.215 - 6.218	108 - 138	2655 - 2900	23.6 - 24.0
6.26775 - 6.26825	149.9 - 150.05	3260 - 3267	31.2 - 31.8
6.31175 - 6.31225	156.52475 - 156.52525	3332 - 3339	36.43 - 36.5
8.291 - 8.294	156.7 - 156.9	3345.8 - 3358	Above 38.6
8.362 - 8.366	162.0125 - 167.17	3500 - 4400	
8.37625 - 8.38675	167.72 - 173.2	4500 - 5150	
8.81425 - 8.81475	240 - 285	5350 - 5460	
12.29 - 12.293	322 - 335.4	7250 - 7750	
12.51975 - 12.52025	399.9 - 410	8025 - 8500	
12.57675 - 12.57725	608 - 614	--	

Restricted Band Emissions Limit			
Frequency (MHz)	Field strength ($\mu\text{V/m}$)	Field strength ($\text{dB}\mu\text{V/m}$)	Measurement distance (m)
0.009 - 0.49	2400/F(kHz)	48.5 – 13.8	300 _(Note 1)
0.49 - 1.705	24000/F(kHz)	33.8 - 23	30 _(Note 1)
1.705 - 30	30	29.5	30 _(Note 1)
30 -88	100	40	3 _(Note 2)
88-216	150	43.5	3 _(Note 2)
216 - 960	200	46	3 _(Note 2)
Above 960	500	54	3 _(Note 2)

Note 1: At frequencies below 30 MHz, measurements may be performed at a distance closer than that specified in the regulations; however, an attempt should be made to avoid making measurements in the near field. Pending the development of an appropriate measurement procedure for measurements performed below 30 MHz, when performing measurements at a closer distance than specified, the results shall be extrapolated to the specified distance by either making measurements at a minimum of two distances on at least one radial to determine the proper extrapolation factor or by using the square of an inverse linear distance extrapolation factor (40 dB/decade).

Note 2: At frequencies at or above 30 MHz, measurements may be performed at a distance other than what is specified provided: measurements are not made in the near field except where it can be shown that near field measurements are appropriate due to the characteristics of the device; and it can be demonstrated that the signal levels needed to be measured at the distance employed can be detected by the measurement equipment.

Measurements shall not be performed at a distance greater than 30 meters unless it can be further demonstrated that measurements at a distance of 30 meters or less are impractical. When performing measurements at a distance other than that specified, the results shall be extrapolated to the specified distance using an extrapolation factor of 20 dB/decade (inverse linear-distance for field strength measurements; inverse-linear-distance-squared for power density measurements).

4.2.2 Test Setup

30MHz-1GHz Test Setup:

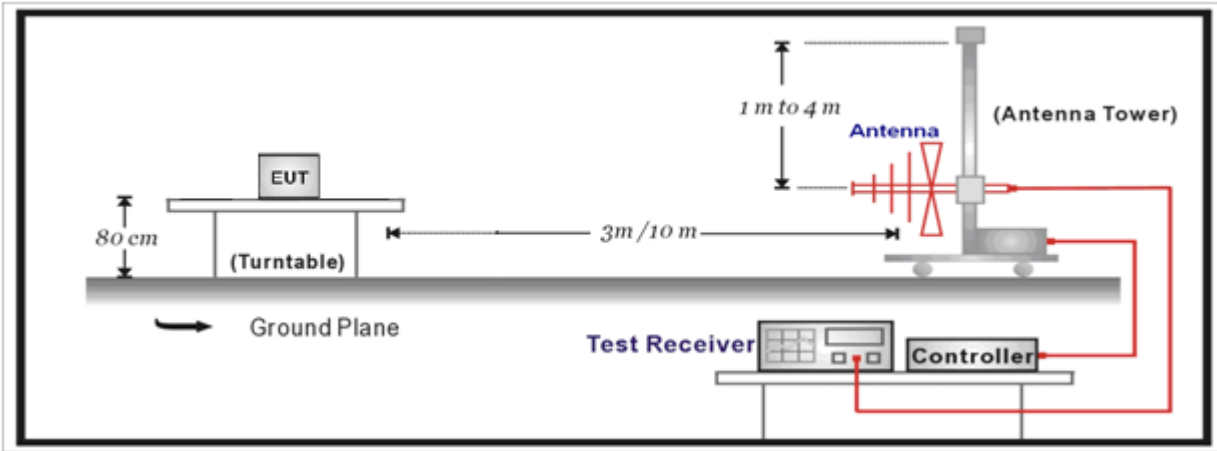

Above 1GHz Test Setup:

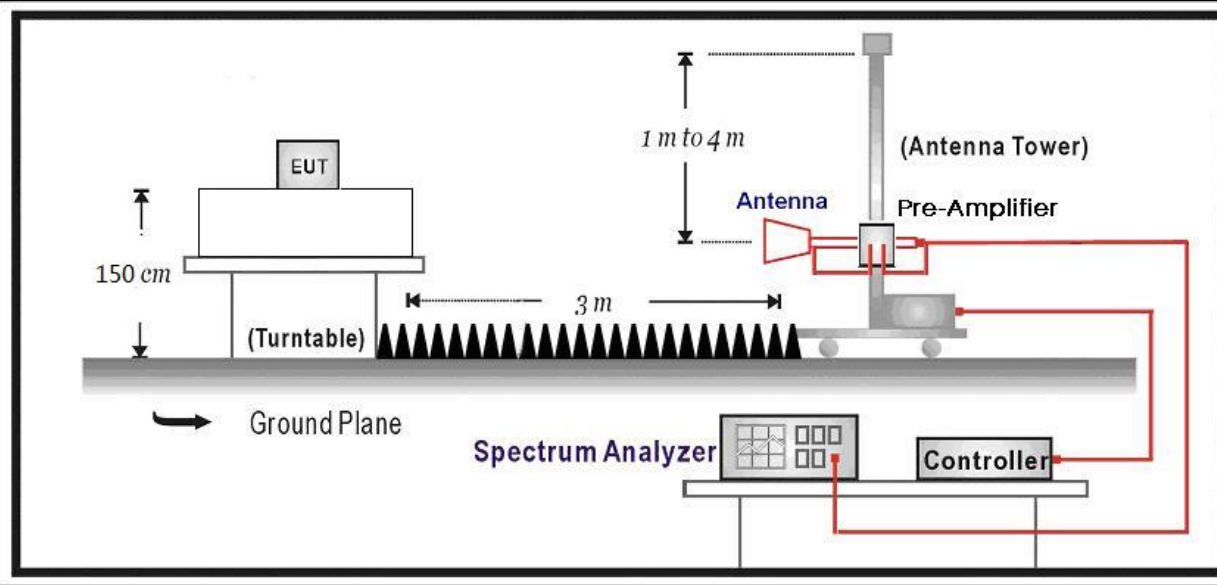

4.2.3 Test Procedure

References Rule	Chapter	Description
<input checked="" type="checkbox"/> ANSI C63.10	11.12	Emissions in restricted frequency bands
<input checked="" type="checkbox"/> ANSI C63.10	11.12.1	Radiated emission measurements
<input checked="" type="checkbox"/> ANSI C63.10	11.12.2.7	Radiated spurious emission test
<input checked="" type="checkbox"/> ANSI C63.10	6.4	Radiated emissions from unlicensed wireless devices below 30 MHz
<input checked="" type="checkbox"/> ANSI C63.10	6.5	Radiated emissions from unlicensed wireless devices in the frequency range of 30 MHz to 1000 MHz
<input checked="" type="checkbox"/> ANSI C63.10	6.6	Radiated emissions from unlicensed wireless devices above 1 GHz

4.2.4 Test Data

Profile: 2140092R	Page No.: 37
Engineer: Jun Xu	
Site: AC5	Time: 2021/04/20 - 02:04
Limit: FCC_Part15.209_RE(3m)	Margin: 0
Probe: Horn_3117_00123988_(1-18GHz)	Polarity: Vertical
EUT: LED Lamp	Power: AC 120V/60Hz
Note: Mode 1:Transmit at 2402MHz	

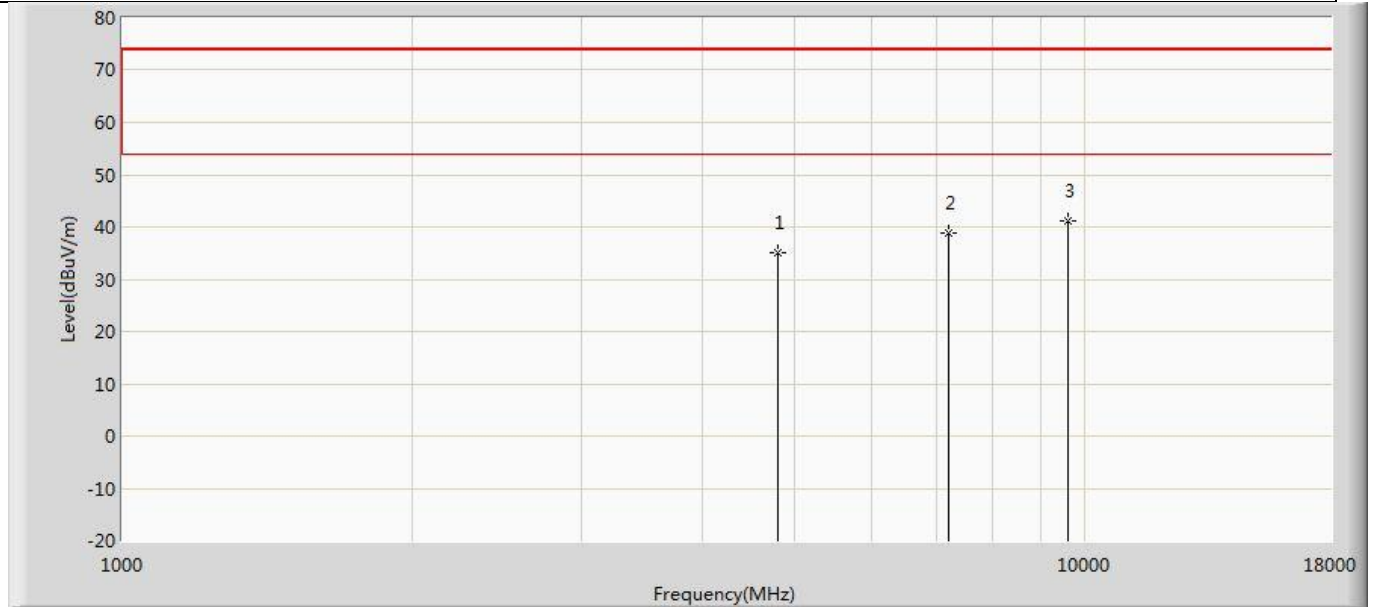

No	Mark	Frequency (MHz)	Measure Level (dBuV/m)	Reading Level (dBuV)	Over Limit (dB)	Limit (dBuV/m)	Factor (dB)	Type
1		4804.000	35.002	40.045	-38.998	74.000	-5.044	PK
2		7206.000	38.913	39.959	-35.087	74.000	-1.046	PK
3	*	9608.000	41.020	38.190	-32.980	74.000	2.830	PK

Profile: 2140092R	Page No.: 38
Engineer: Jun Xu	
Site: AC5	Time: 2021/04/20 - 02:04
Limit: FCC_Part15.209_RE(3m)	Margin: 0
Probe: Horn_3117_00123988_(1-18GHz)	Polarity: Horizontal
EUT: LED Lamp	Power: AC 120V/60Hz
Note: Mode 1:Transmit at 2402MHz	

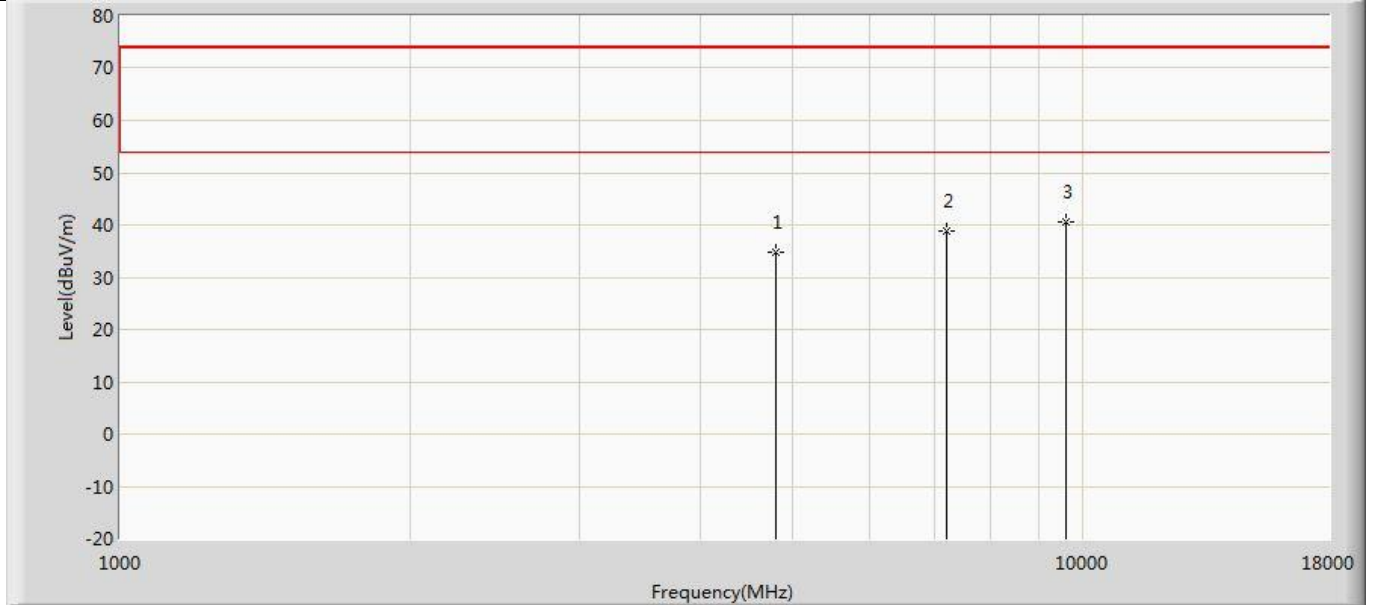

No	Mark	Frequency (MHz)	Measure Level (dBuV/m)	Reading Level (dBuV)	Over Limit (dB)	Limit (dBuV/m)	Factor (dB)	Type
1		4804.000	34.807	39.850	-39.193	74.000	-5.044	PK
2		7206.000	38.926	39.972	-35.074	74.000	-1.046	PK
3	*	9608.000	40.716	37.886	-33.284	74.000	2.830	PK

Profile: 2140092R	Page No.: 39
Engineer: Jun Xu	
Site: AC5	Time: 2021/04/20 - 02:04
Limit: FCC_Part15.209_RE(3m)	Margin: 0
Probe: Horn_3117_00123988_(1-18GHz)	Polarity: Vertical
EUT: LED Lamp	Power: AC 120V/60Hz
Note: Mode 1:Transmit at 2440MHz	

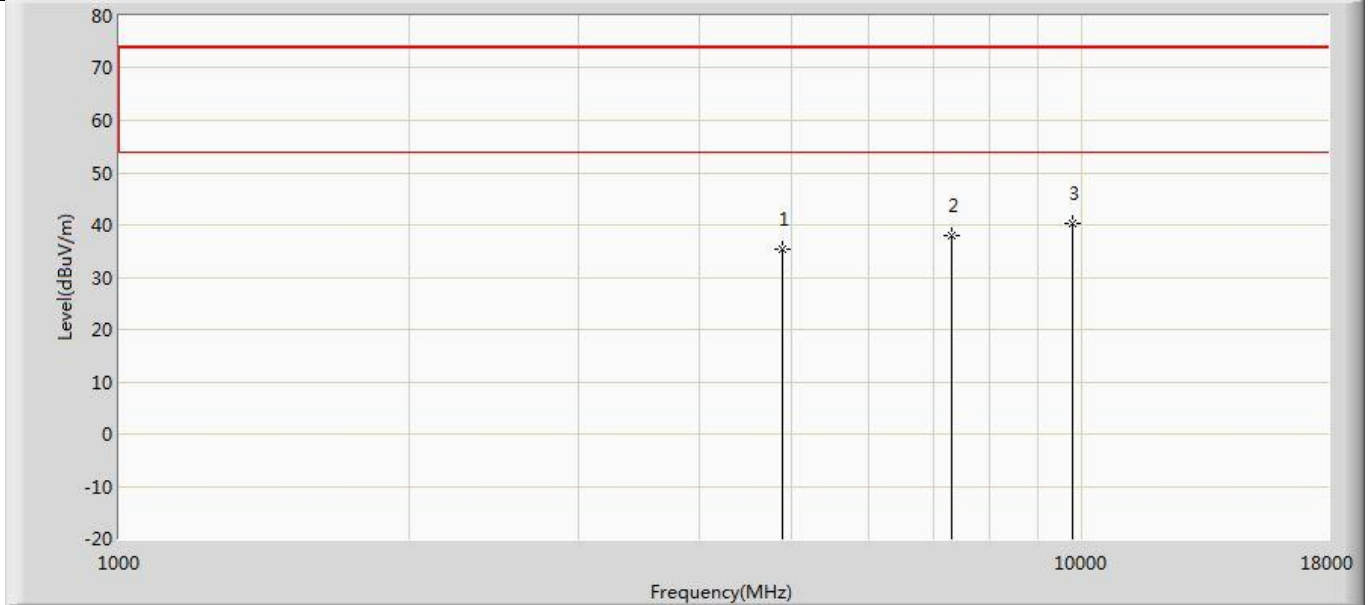

No	Mark	Frequency (MHz)	Measure Level (dBuV/m)	Reading Level (dBuV)	Over Limit (dB)	Limit (dBuV/m)	Factor (dB)	Type
1		4880.000	35.484	40.311	-38.516	74.000	-4.827	PK
2		7320.000	38.071	38.964	-35.929	74.000	-0.893	PK
3	*	9760.000	40.222	37.224	-33.778	74.000	2.998	PK

Profile: 2140092R	Page No.: 40
Engineer: Jun Xu	
Site: AC5	Time: 2021/04/20 - 02:04
Limit: FCC_Part15.209_RE(3m)	Margin: 0
Probe: Horn_3117_00123988_(1-18GHz)	Polarity: Horizontal
EUT: LED Lamp	Power: AC 120V/60Hz
Note: Mode 1:Transmit at 2440MHz	

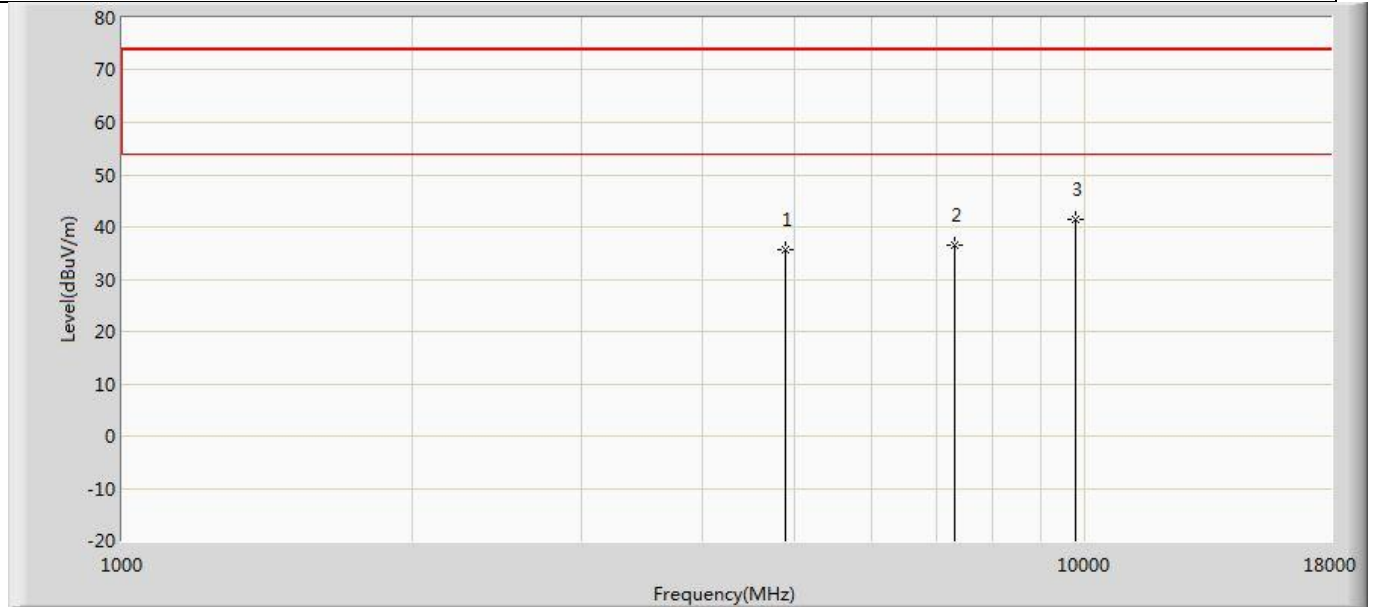

No	Mark	Frequency (MHz)	Measure Level (dBuV/m)	Reading Level (dBuV)	Over Limit (dB)	Limit (dBuV/m)	Factor (dB)	Type
1		4880.000	35.659	40.486	-38.341	74.000	-4.827	PK
2		7320.000	36.631	37.524	-37.369	74.000	-0.893	PK
3	*	9760.000	41.429	38.431	-32.571	74.000	2.998	PK

Profile: 2140092R	Page No.: 41
Engineer: Jun Xu	
Site: AC5	Time: 2021/04/20 - 02:04
Limit: FCC_Part15.209_RE(3m)	Margin: 0
Probe: Horn_3117_00123988_(1-18GHz)	Polarity: Vertical
EUT: LED Lamp	Power: AC 120V/60Hz
Note: Mode 1:Transmit at 2480MHz	

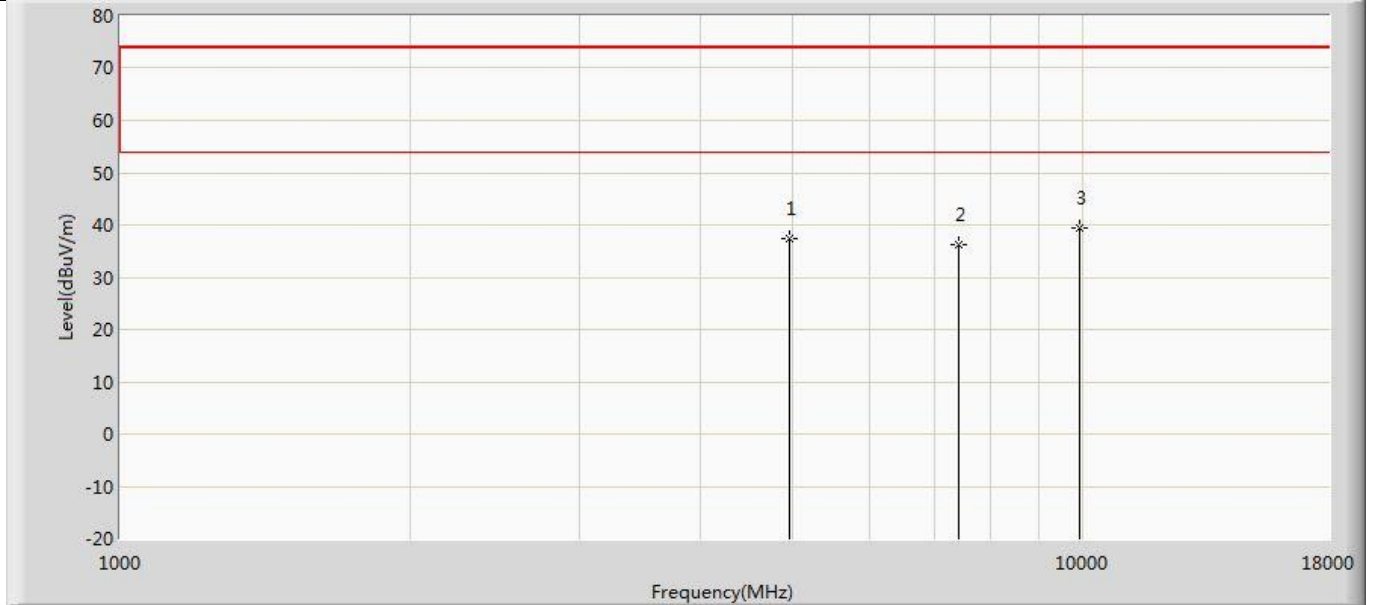

No	Mark	Frequency (MHz)	Measure Level (dBuV/m)	Reading Level (dBuV)	Over Limit (dB)	Limit (dBuV/m)	Factor (dB)	Type
1		4960.000	37.475	42.137	-36.525	74.000	-4.662	PK
2		7440.000	36.096	37.139	-37.904	74.000	-1.043	PK
3	*	9920.000	39.556	36.509	-34.444	74.000	3.047	PK

Profile: 2140092R	Page No.: 42
Engineer: Jun Xu	
Site: AC5	Time: 2021/04/20 - 02:04
Limit: FCC_Part15.209_RE(3m)	Margin: 0
Probe: Horn_3117_00123988_(1-18GHz)	Polarity: Horizontal
EUT: LED Lamp	Power: AC 120V/60Hz
Note: Mode 1:Transmit at 2480MHz	

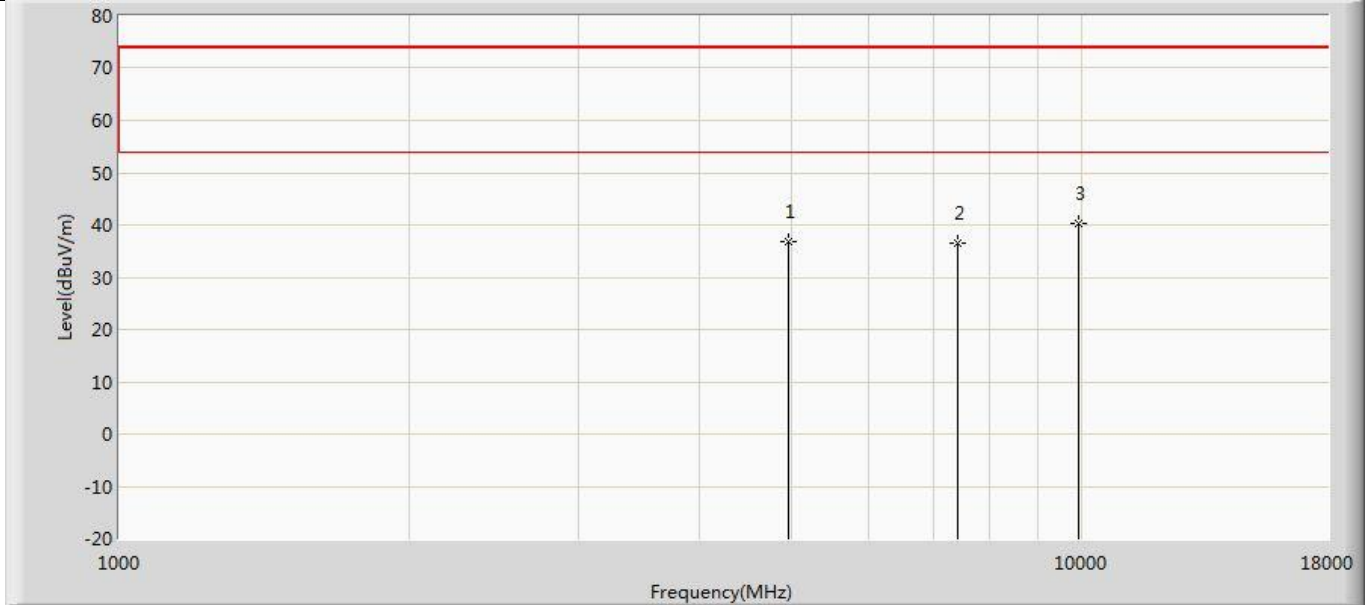

No	Mark	Frequency (MHz)	Measure Level (dBuV/m)	Reading Level (dBuV)	Over Limit (dB)	Limit (dBuV/m)	Factor (dB)	Type
1		4960.000	36.710	41.372	-37.290	74.000	-4.662	PK
2		7440.000	36.466	37.509	-37.534	74.000	-1.043	PK
3	*	9920.000	40.186	37.139	-33.814	74.000	3.047	PK

Profile: 2140092R	Page No.: 43
Engineer: Jun Xu	
Site: AC5	Time: 2021/04/20 - 02:04
Limit: FCC_Part15.209_RE(3m)	Margin: 0
Probe: Horn_3117_00123988_(1-18GHz)	Polarity: Vertical
EUT: LED Lamp	Power: AC 120V/60Hz
Note: Mode 2:Transmit at 2402MHz	

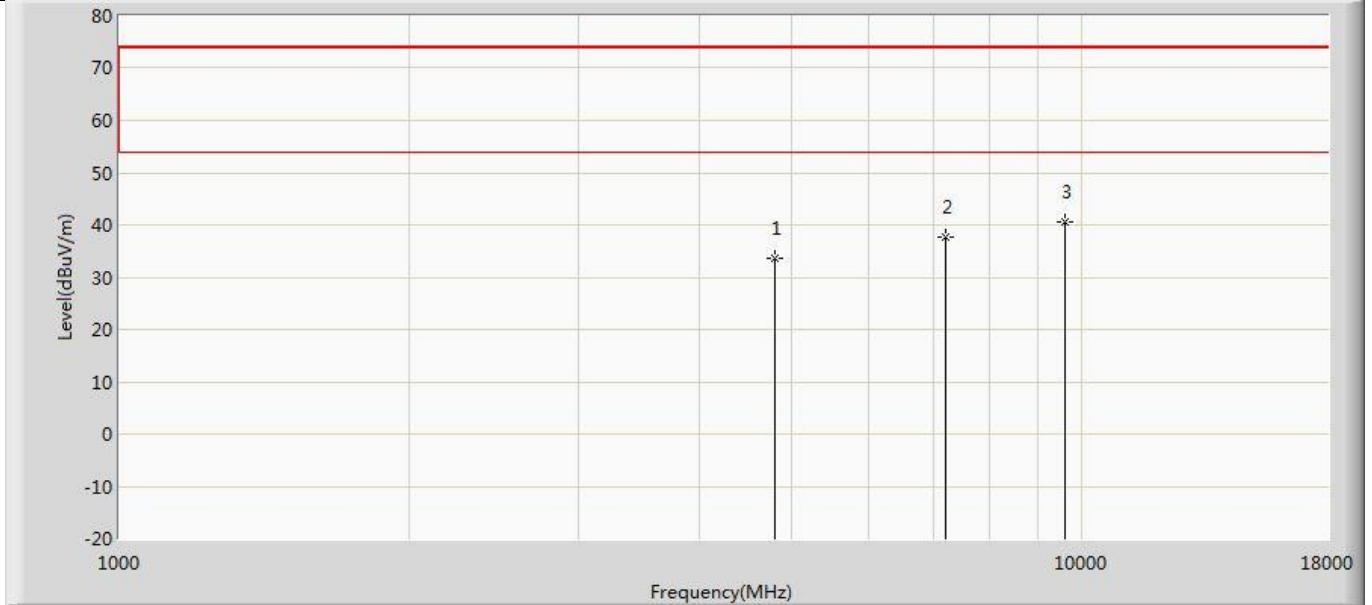

No	Mark	Frequency (MHz)	Measure Level (dBuV/m)	Reading Level (dBuV)	Over Limit (dB)	Limit (dBuV/m)	Factor (dB)	Type
1		4804.000	33.698	38.741	-40.302	74.000	-5.044	PK
2		7206.000	37.664	38.710	-36.336	74.000	-1.046	PK
3	*	9608.000	40.724	37.894	-33.276	74.000	2.830	PK

Profile: 2140092R	Page No.: 44
Engineer: Jun Xu	
Site: AC5	Time: 2021/04/20 - 02:04
Limit: FCC_Part15.209_RE(3m)	Margin: 0
Probe: Horn_3117_00123988_(1-18GHz)	Polarity: Horizontal
EUT: LED Lamp	Power: AC 120V/60Hz
Note: Mode 2:Transmit at 2402MHz	

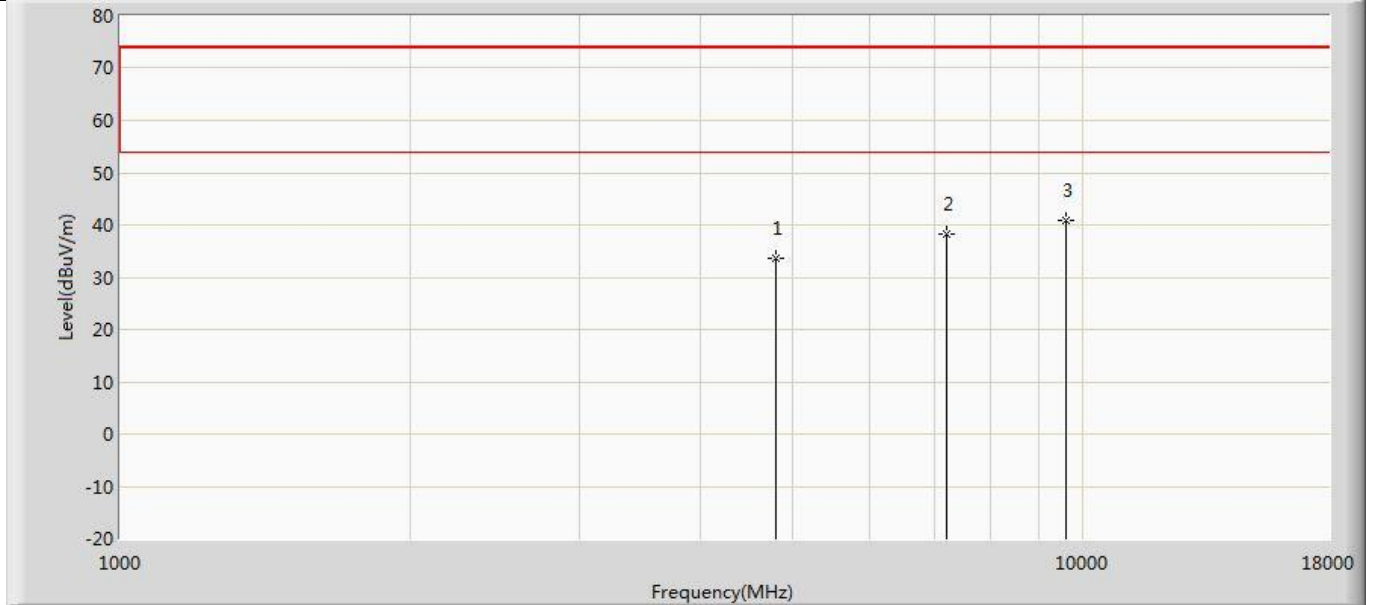

No	Mark	Frequency (MHz)	Measure Level (dBuV/m)	Reading Level (dBuV)	Over Limit (dB)	Limit (dBuV/m)	Factor (dB)	Type
1		4804.000	33.725	38.768	-40.275	74.000	-5.044	PK
2		7206.000	38.116	39.162	-35.884	74.000	-1.046	PK
3	*	9608.000	40.910	38.080	-33.090	74.000	2.830	PK

Profile: 2140092R	Page No.: 45
Engineer: Jun Xu	
Site: AC5	Time: 2021/04/20 - 02:04
Limit: FCC_Part15.209_RE(3m)	Margin: 0
Probe: Horn_3117_00123988_(1-18GHz)	Polarity: Vertical
EUT: LED Lamp	Power: AC 120V/60Hz
Note: Mode 2:Transmit at 2440MHz	

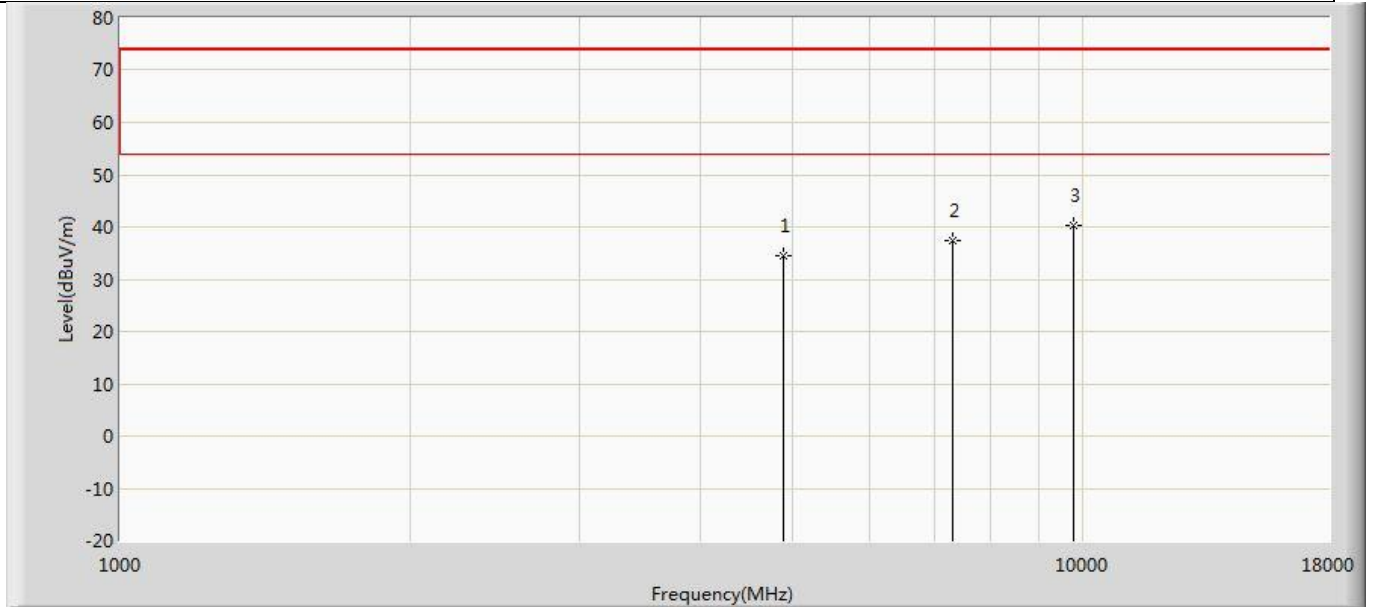

No	Mark	Frequency (MHz)	Measure Level (dBuV/m)	Reading Level (dBuV)	Over Limit (dB)	Limit (dBuV/m)	Factor (dB)	Type
1		4880.000	34.448	39.275	-39.552	74.000	-4.827	PK
2		7320.000	37.525	38.418	-36.475	74.000	-0.893	PK
3	*	9760.000	40.326	37.328	-33.674	74.000	2.998	PK

Profile: 2140092R	Page No.: 46
Engineer: Jun Xu	
Site: AC5	Time: 2021/04/20 - 02:04
Limit: FCC_Part15.209_RE(3m)	Margin: 0
Probe: Horn_3117_00123988_(1-18GHz)	Polarity: Horizontal
EUT: LED Lamp	Power: AC 120V/60Hz
Note: Mode 2:Transmit at 2440MHz	

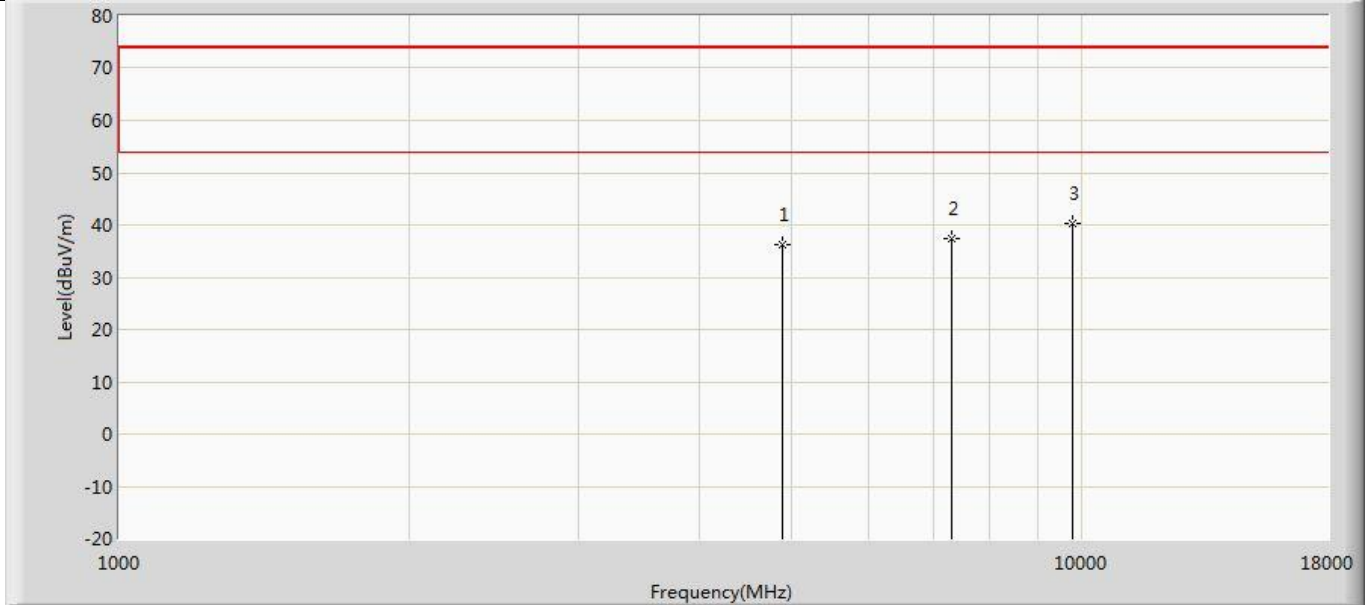

No	Mark	Frequency (MHz)	Measure Level (dBuV/m)	Reading Level (dBuV)	Over Limit (dB)	Limit (dBuV/m)	Factor (dB)	Type
1		4880.000	36.189	41.016	-37.811	74.000	-4.827	PK
2		7320.000	37.418	38.311	-36.582	74.000	-0.893	PK
3	*	9760.000	40.411	37.413	-33.589	74.000	2.998	PK

Profile: 2140092R	Page No.: 47
Engineer: Jun Xu	
Site: AC5	Time: 2021/04/20 - 02:05
Limit: FCC_Part15.209_RE(3m)	Margin: 0
Probe: Horn_3117_00123988_(1-18GHz)	Polarity: Vertical
EUT: LED Lamp	Power: AC 120V/60Hz
Note: Mode 2:Transmit at 2480MHz	

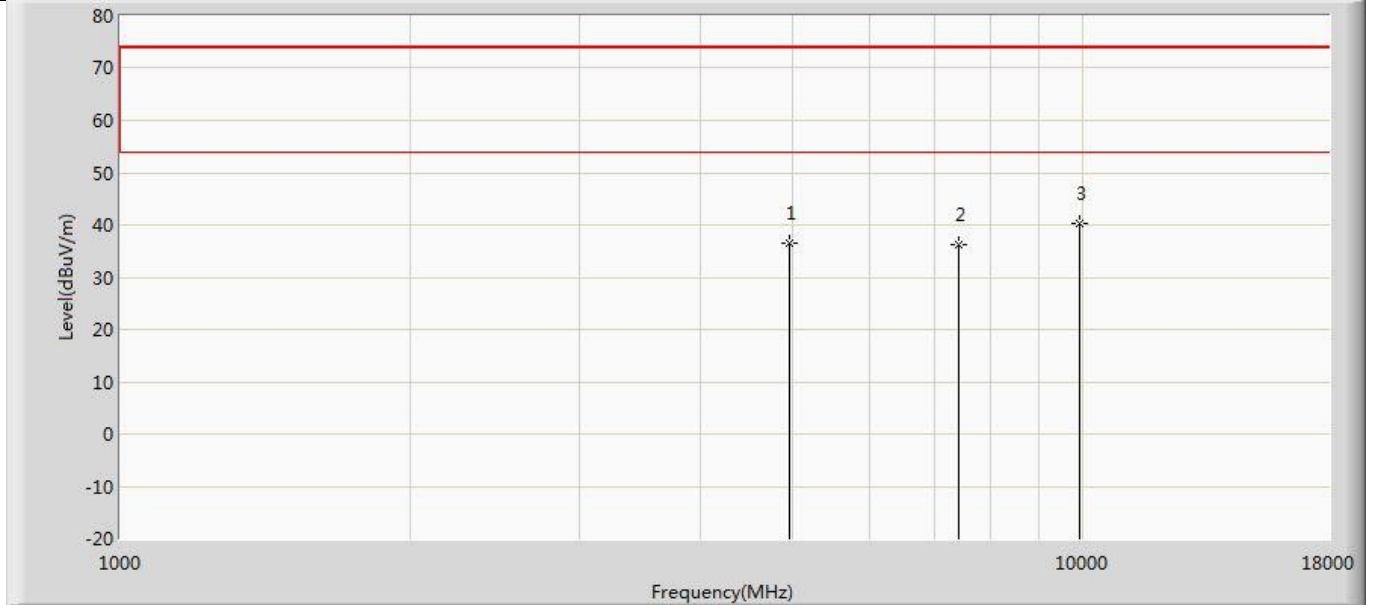

No	Mark	Frequency (MHz)	Measure Level (dBuV/m)	Reading Level (dBuV)	Over Limit (dB)	Limit (dBuV/m)	Factor (dB)	Type
1		4960.000	36.655	41.317	-37.345	74.000	-4.662	PK
2		7440.000	36.375	37.418	-37.625	74.000	-1.043	PK
3	*	9920.000	40.178	37.131	-33.822	74.000	3.047	PK

Profile: 2140092R	Page No.: 48
Engineer: Jun Xu	
Site: AC5	Time: 2021/04/20 - 02:05
Limit: FCC_Part15.209_RE(3m)	Margin: 0
Probe: Horn_3117_00123988_(1-18GHz)	Polarity: Horizontal
EUT: LED Lamp	Power: AC 120V/60Hz
Note: Mode 2:Transmit at 2480MHz	

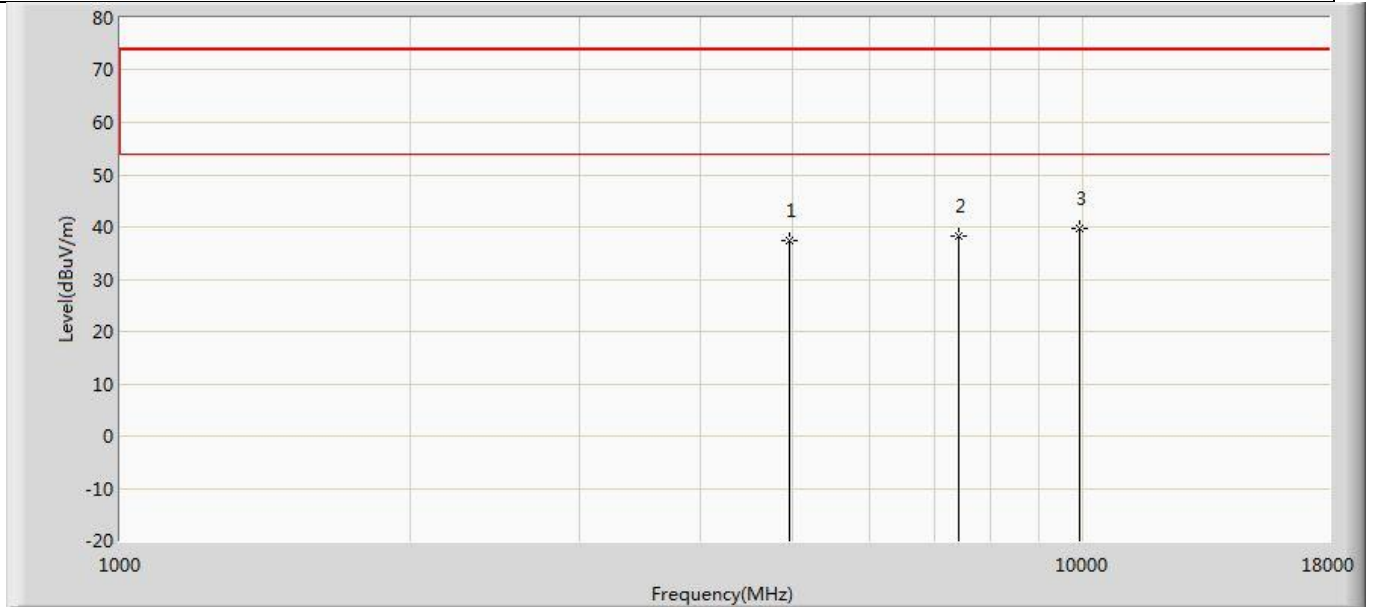

No	Mark	Frequency (MHz)	Measure Level (dBuV/m)	Reading Level (dBuV)	Over Limit (dB)	Limit (dBuV/m)	Factor (dB)	Type
1		4960.000	37.433	42.095	-36.567	74.000	-4.662	PK
2		7440.000	38.169	39.212	-35.831	74.000	-1.043	PK
3	*	9920.000	39.748	36.701	-34.252	74.000	3.047	PK

Profile: 2140092R	Page No.: 55
Engineer: Jun Xu	
Site: AC5	Time: 2021/04/20 - 02:05
Limit: FCC_Part15.209_RE(3m)	Margin: 0
Probe: Horn_3117_00123988_(1-18GHz)	Polarity: Vertical
EUT: LED Lamp	Power: AC 120V/60Hz
Note: Mode 3:Transmit at 2402MHz	

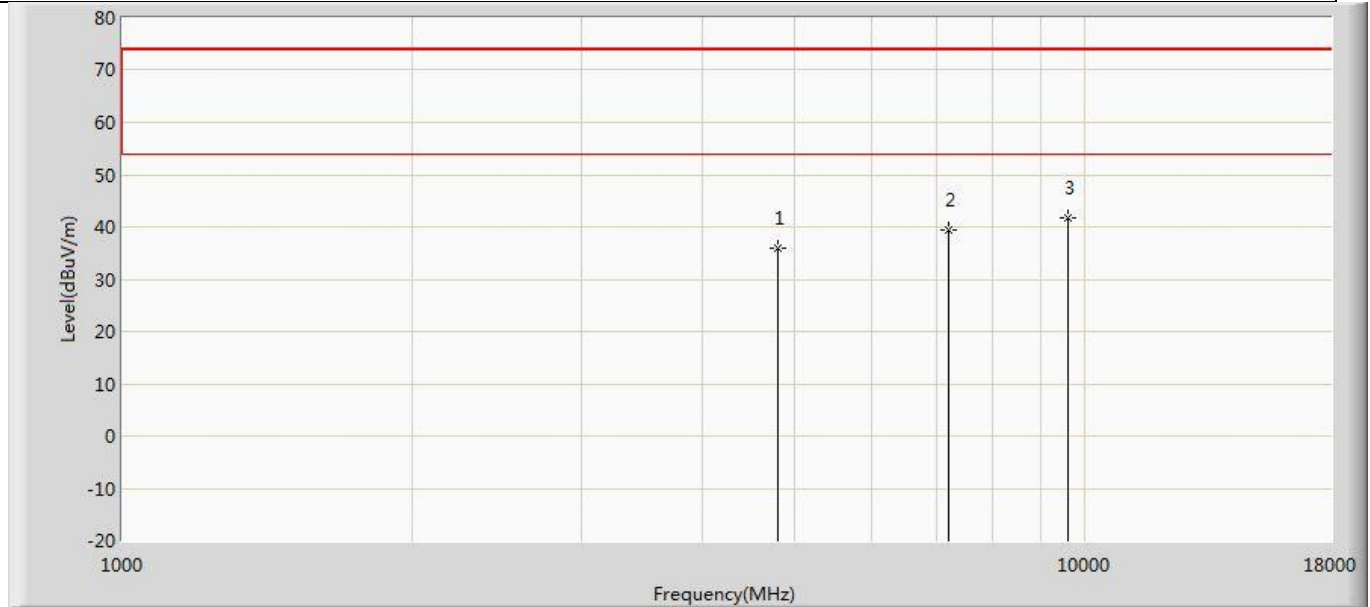

No	Mark	Frequency (MHz)	Measure Level (dBuV/m)	Reading Level (dBuV)	Over Limit (dB)	Limit (dBuV/m)	Factor (dB)	Type
1		4804.000	35.852	40.895	-38.148	74.000	-5.044	PK
2		7206.000	39.509	40.555	-34.491	74.000	-1.046	PK
3	*	9608.000	41.839	39.009	-32.161	74.000	2.830	PK

Profile: 2140092R	Page No.: 56
Engineer: Jun Xu	
Site: AC5	Time: 2021/04/20 - 02:05
Limit: FCC_Part15.209_RE(3m)	Margin: 0
Probe: Horn_3117_00123988_(1-18GHz)	Polarity: Horizontal
EUT: LED Lamp	Power: AC 120V/60Hz
Note: Mode 3:Transmit at 2402MHz	

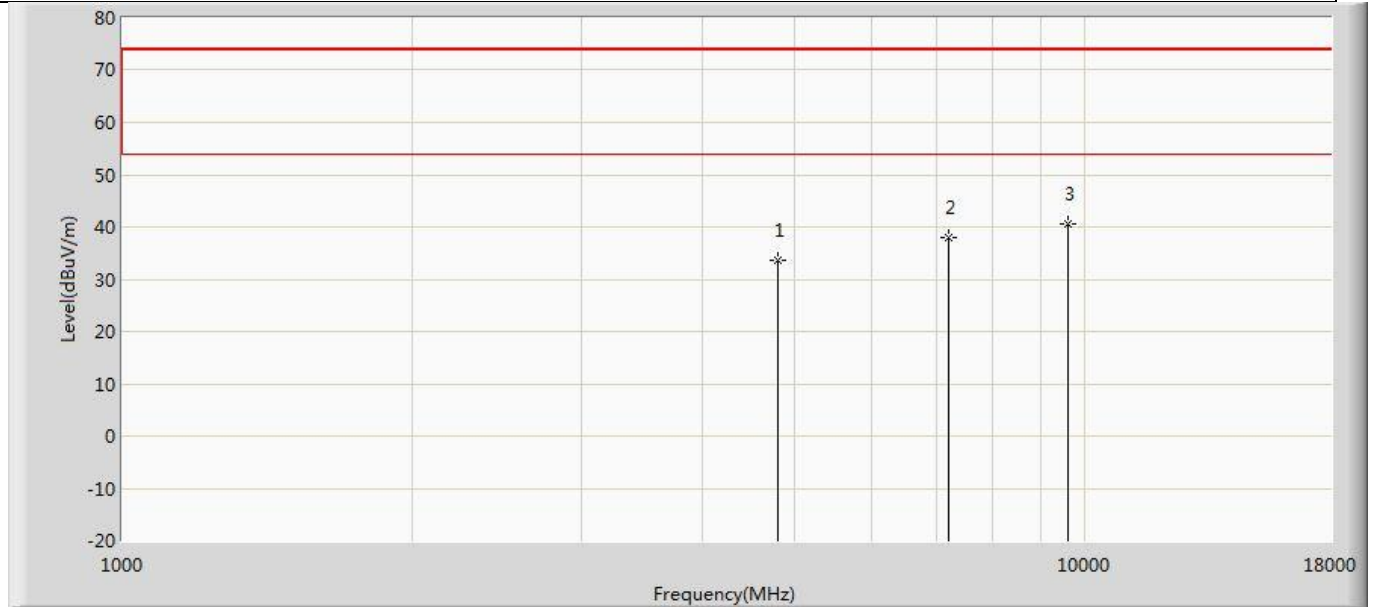

No	Mark	Frequency (MHz)	Measure Level (dBuV/m)	Reading Level (dBuV)	Over Limit (dB)	Limit (dBuV/m)	Factor (dB)	Type
1		4804.000	33.663	38.706	-40.337	74.000	-5.044	PK
2		7206.000	37.928	38.974	-36.072	74.000	-1.046	PK
3	*	9608.000	40.502	37.672	-33.498	74.000	2.830	PK

Profile: 2140092R	Page No.: 57
Engineer: Jun Xu	
Site: AC5	Time: 2021/04/20 - 02:05
Limit: FCC_Part15.209_RE(3m)	Margin: 0
Probe: Horn_3117_00123988_(1-18GHz)	Polarity: Vertical
EUT: LED Lamp	Power: AC 120V/60Hz
Note: Mode 3:Transmit at 2440MHz	

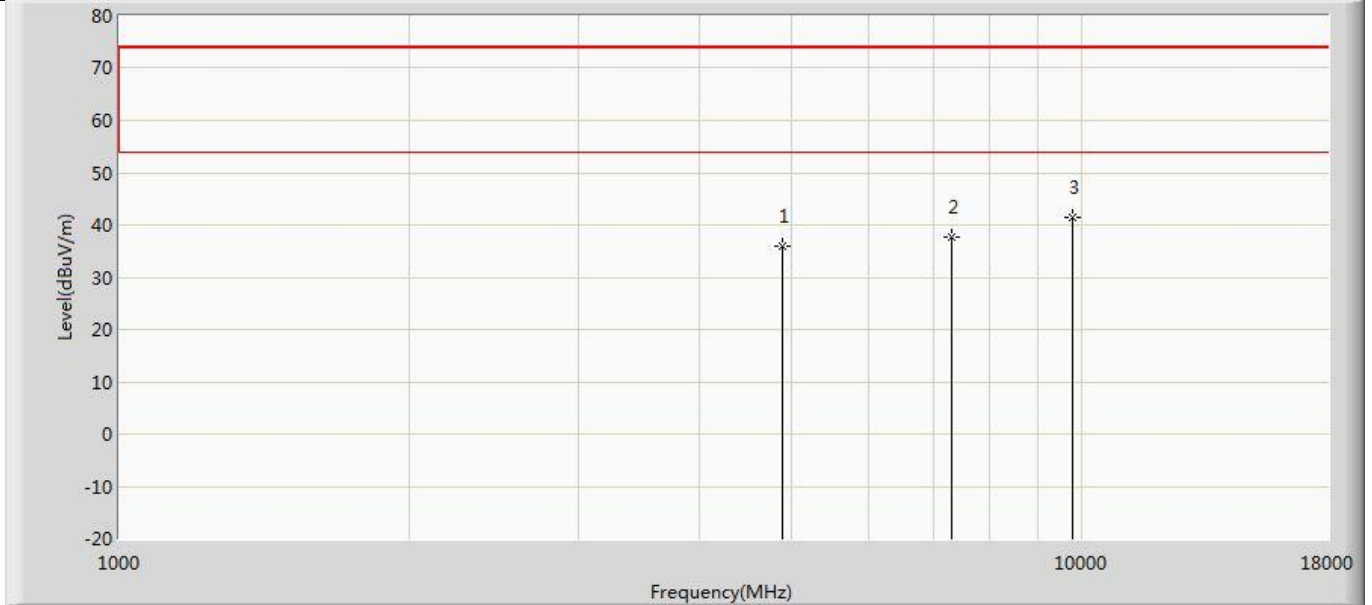

No	Mark	Frequency (MHz)	Measure Level (dBuV/m)	Reading Level (dBuV)	Over Limit (dB)	Limit (dBuV/m)	Factor (dB)	Type
1		4880.000	35.949	40.776	-38.051	74.000	-4.827	PK
2		7320.000	37.776	38.669	-36.224	74.000	-0.893	PK
3	*	9760.000	41.554	38.556	-32.446	74.000	2.998	PK

Profile: 2140092R	Page No.: 58
Engineer: Jun Xu	
Site: AC5	Time: 2021/04/20 - 02:05
Limit: FCC_Part15.209_RE(3m)	Margin: 0
Probe: Horn_3117_00123988_(1-18GHz)	Polarity: Horizontal
EUT: LED Lamp	Power: AC 120V/60Hz
Note: Mode 3:Transmit at 2440MHz	

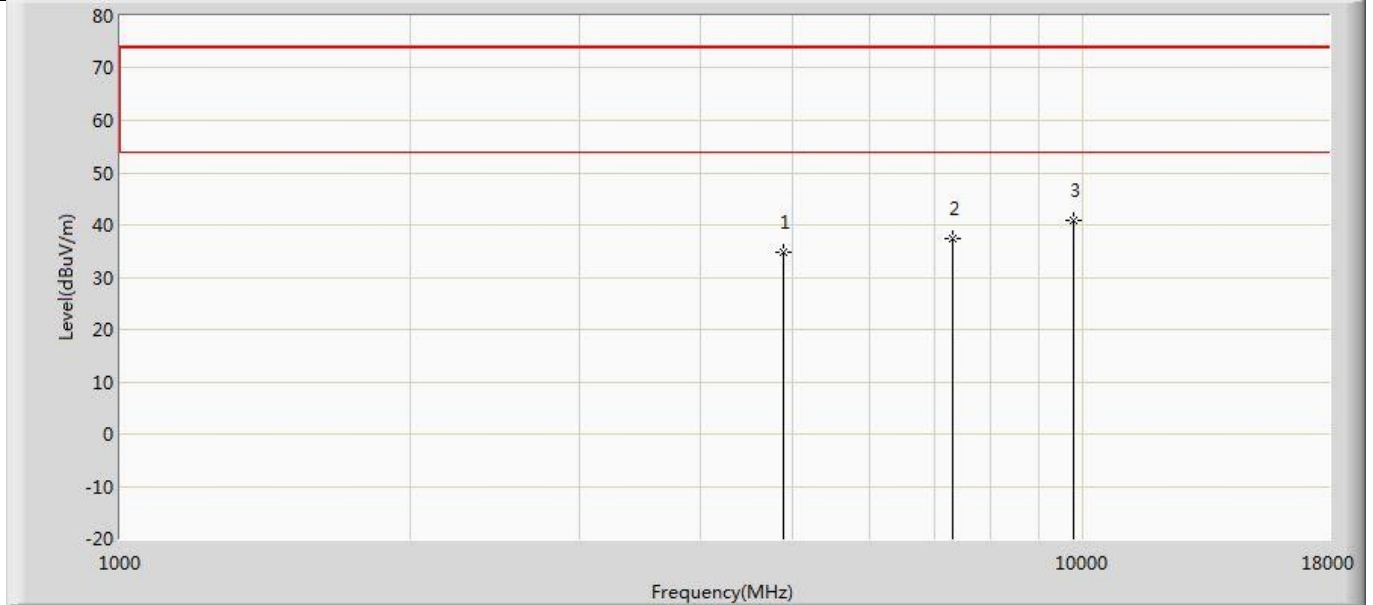

No	Mark	Frequency (MHz)	Measure Level (dBuV/m)	Reading Level (dBuV)	Over Limit (dB)	Limit (dBuV/m)	Factor (dB)	Type
1		4880.000	34.859	39.686	-39.141	74.000	-4.827	PK
2		7320.000	37.305	38.198	-36.695	74.000	-0.893	PK
3	*	9760.000	40.777	37.779	-33.223	74.000	2.998	PK

Profile: 2140092R	Page No.: 59
Engineer: Jun Xu	
Site: AC5	Time: 2021/04/20 - 02:06
Limit: FCC_Part15.209_RE(3m)	Margin: 0
Probe: Horn_3117_00123988_(1-18GHz)	Polarity: Vertical
EUT: LED Lamp	Power: AC 120V/60Hz
Note: Mode 3:Transmit at 2480MHz	

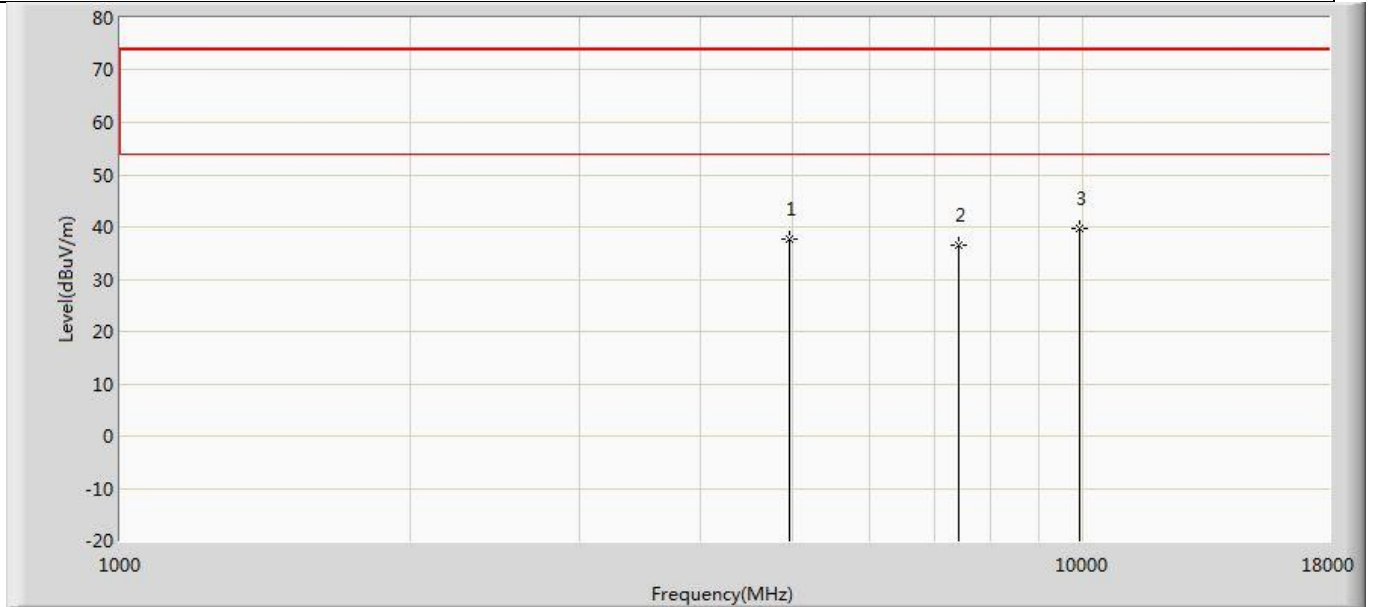

No	Mark	Frequency (MHz)	Measure Level (dBuV/m)	Reading Level (dBuV)	Over Limit (dB)	Limit (dBuV/m)	Factor (dB)	Type
1		4960.000	37.816	42.478	-36.184	74.000	-4.662	PK
2		7440.000	36.463	37.506	-37.537	74.000	-1.043	PK
3	*	9920.000	39.664	36.617	-34.336	74.000	3.047	PK

Profile: 2140092R	Page No.: 60
Engineer: Jun Xu	
Site: AC5	Time: 2021/04/20 - 02:06
Limit: FCC_Part15.209_RE(3m)	Margin: 0
Probe: Horn_3117_00123988_(1-18GHz)	Polarity: Horizontal
EUT: LED Lamp	Power: AC 120V/60Hz
Note: Mode 3:Transmit at 2480MHz	

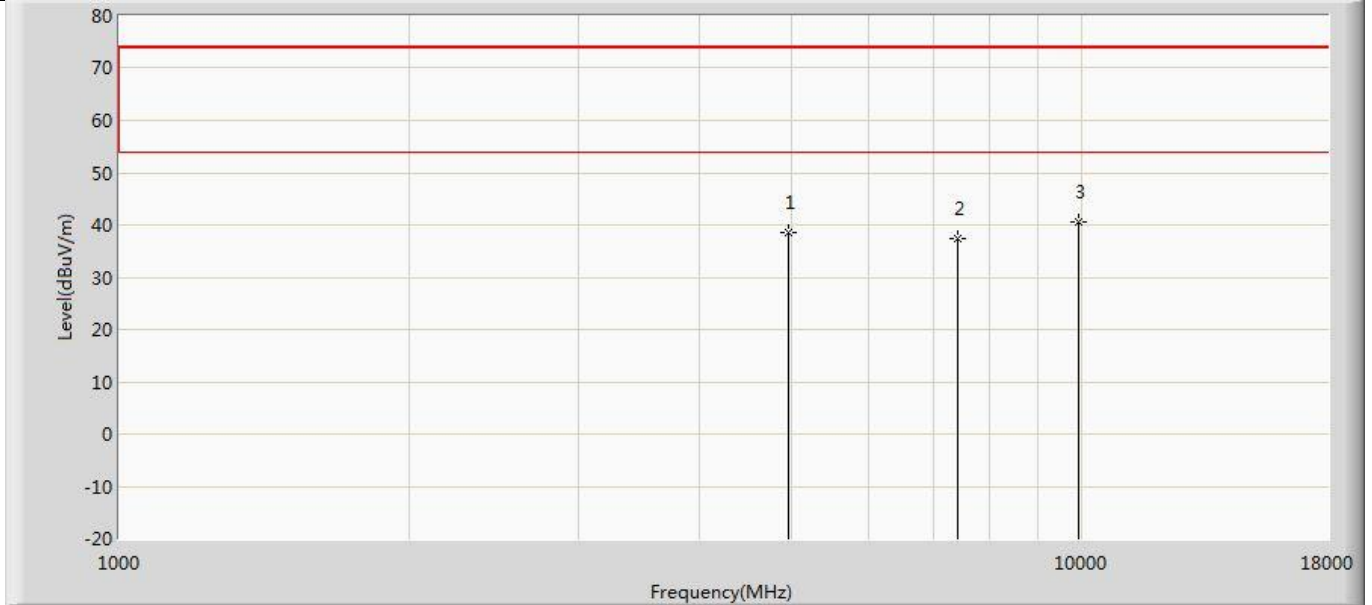

No	Mark	Frequency (MHz)	Measure Level (dBuV/m)	Reading Level (dBuV)	Over Limit (dB)	Limit (dBuV/m)	Factor (dB)	Type
1		4960.000	38.624	43.286	-35.376	74.000	-4.662	PK
2		7440.000	37.313	38.356	-36.687	74.000	-1.043	PK
3	*	9920.000	40.701	37.654	-33.299	74.000	3.047	PK

Profile: 2140092R	Page No.: 49
Engineer: Jun Xu	
Site: AC5	Time: 2021/04/20 - 02:05
Limit: FCC_Part15.209_RE(3m)	Margin: 0
Probe: Horn_3117_00123988_(1-18GHz)	Polarity: Vertical
EUT: LED Lamp	Power: AC 120V/60Hz
Note: Mode 4:Transmit at 2402MHz	

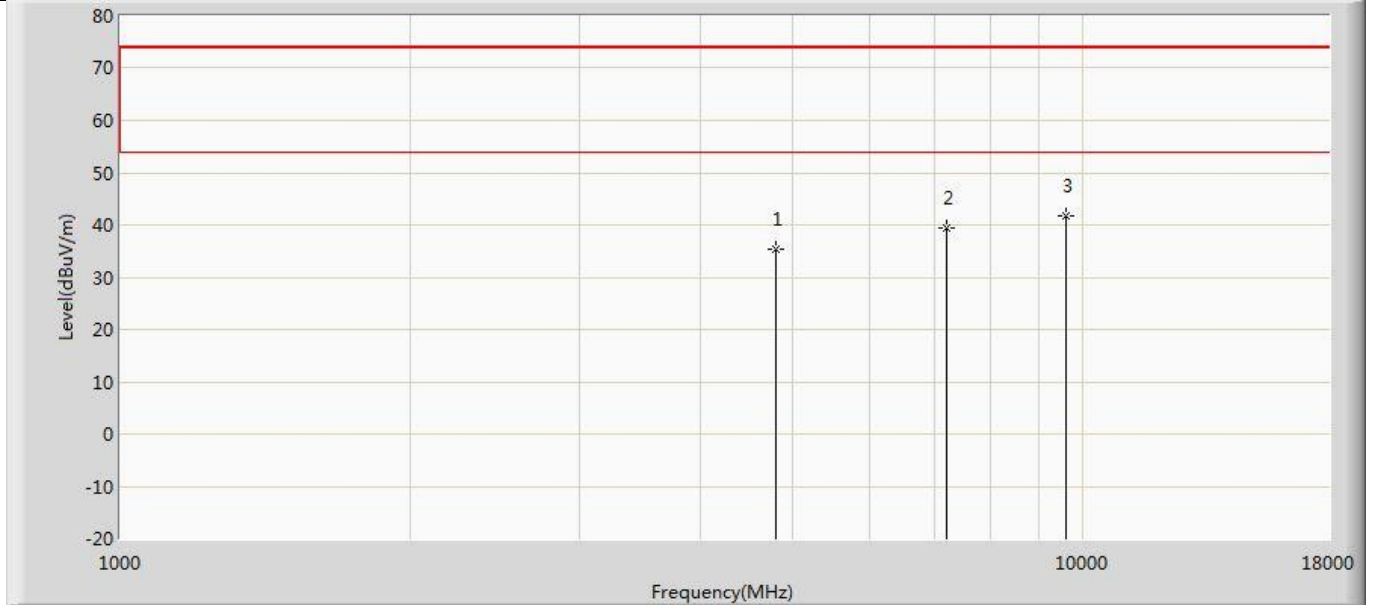

No	Mark	Frequency (MHz)	Measure Level (dBuV/m)	Reading Level (dBuV)	Over Limit (dB)	Limit (dBuV/m)	Factor (dB)	Type
1		4804.000	35.245	40.288	-38.755	74.000	-5.044	PK
2		7206.000	39.514	40.560	-34.486	74.000	-1.046	PK
3	*	9608.000	41.622	38.792	-32.378	74.000	2.830	PK

Profile: 2140092R	Page No.: 50
Engineer: Jun Xu	
Site: AC5	Time: 2021/04/20 - 02:05
Limit: FCC_Part15.209_RE(3m)	Margin: 0
Probe: Horn_3117_00123988_(1-18GHz)	Polarity: Horizontal
EUT: LED Lamp	Power: AC 120V/60Hz
Note: Mode 4:Transmit at 2402MHz	

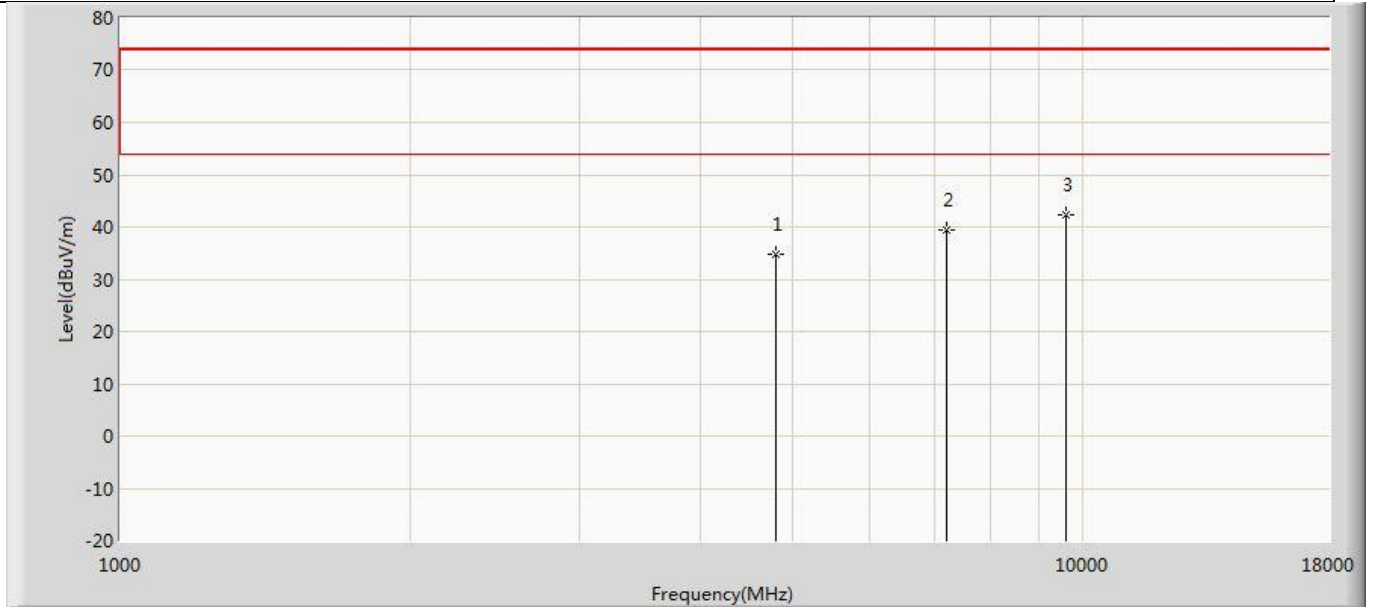

No	Mark	Frequency (MHz)	Measure Level (dBuV/m)	Reading Level (dBuV)	Over Limit (dB)	Limit (dBuV/m)	Factor (dB)	Type
1		4804.000	34.791	39.834	-39.209	74.000	-5.044	PK
2		7206.000	39.427	40.473	-34.573	74.000	-1.046	PK
3	*	9608.000	42.265	39.435	-31.735	74.000	2.830	PK

Profile: 2140092R	Page No.: 51
Engineer: Jun Xu	
Site: AC5	Time: 2021/04/20 - 02:05
Limit: FCC_Part15.209_RE(3m)	Margin: 0
Probe: Horn_3117_00123988_(1-18GHz)	Polarity: Vertical
EUT: LED Lamp	Power: AC 120V/60Hz
Note: Mode 4:Transmit at 2440MHz	

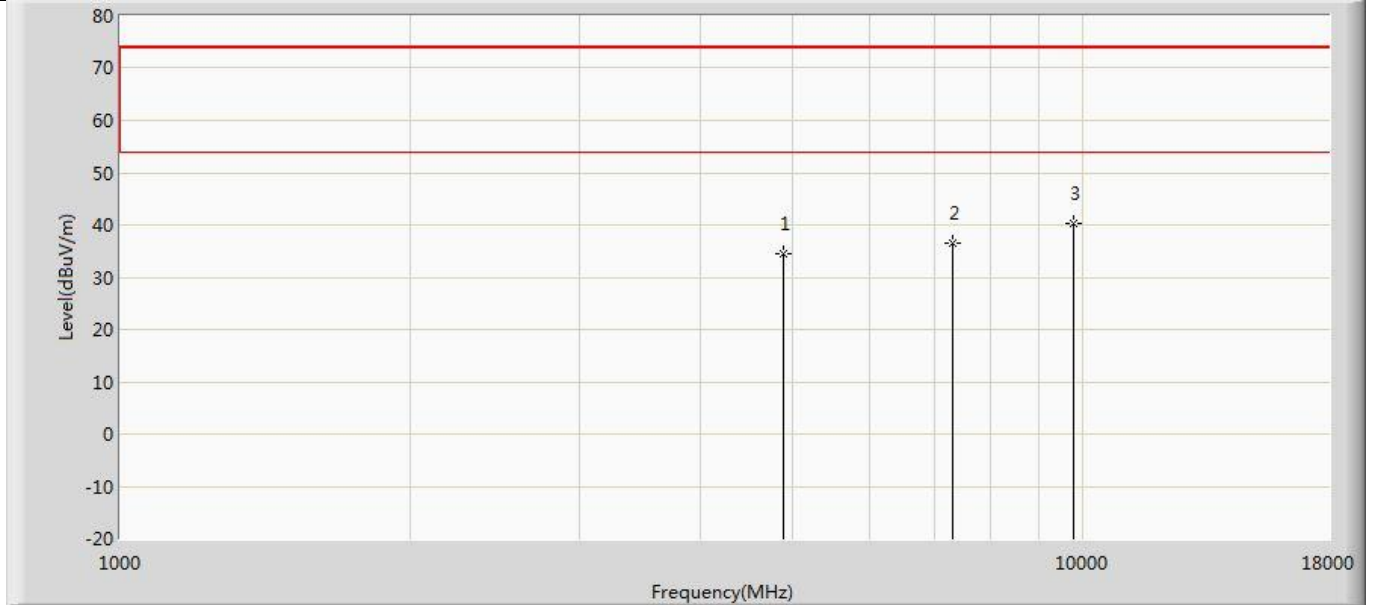

No	Mark	Frequency (MHz)	Measure Level (dBuV/m)	Reading Level (dBuV)	Over Limit (dB)	Limit (dBuV/m)	Factor (dB)	Type
1		4880.000	34.567	39.394	-39.433	74.000	-4.827	PK
2		7320.000	36.508	37.401	-37.492	74.000	-0.893	PK
3	*	9760.000	40.241	37.243	-33.759	74.000	2.998	PK

Profile: 2140092R	Page No.: 52
Engineer: Jun Xu	
Site: AC5	Time: 2021/04/20 - 02:05
Limit: FCC_Part15.209_RE(3m)	Margin: 0
Probe: Horn_3117_00123988_(1-18GHz)	Polarity: Horizontal
EUT: LED Lamp	Power: AC 120V/60Hz
Note: Mode 4:Transmit at 2440MHz	

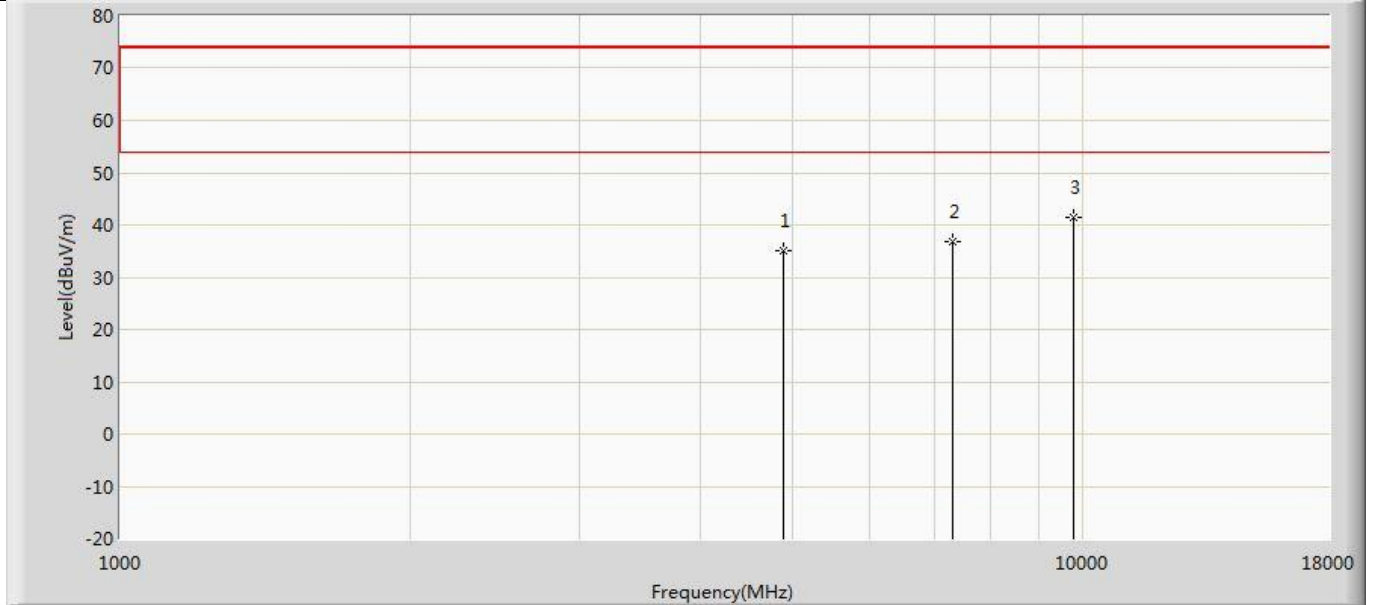

No	Mark	Frequency (MHz)	Measure Level (dBuV/m)	Reading Level (dBuV)	Over Limit (dB)	Limit (dBuV/m)	Factor (dB)	Type
1		4880.000	35.163	39.990	-38.837	74.000	-4.827	PK
2		7320.000	36.945	37.838	-37.055	74.000	-0.893	PK
3	*	9760.000	41.568	38.570	-32.432	74.000	2.998	PK

Profile: 2140092R	Page No.: 53
Engineer: Jun Xu	
Site: AC5	Time: 2021/04/20 - 02:05
Limit: FCC_Part15.209_RE(3m)	Margin: 0
Probe: Horn_3117_00123988_(1-18GHz)	Polarity: Vertical
EUT: LED Lamp	Power: AC 120V/60Hz
Note: Mode 4:Transmit at 2480MHz	

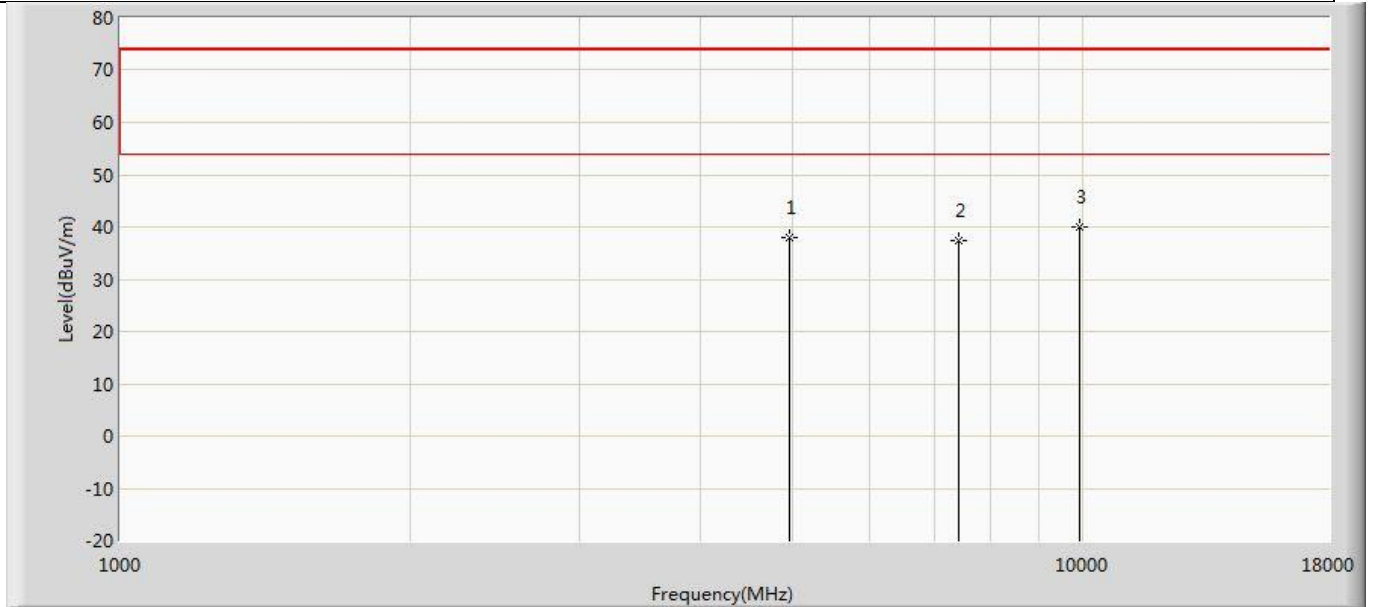

No	Mark	Frequency (MHz)	Measure Level (dBuV/m)	Reading Level (dBuV)	Over Limit (dB)	Limit (dBuV/m)	Factor (dB)	Type
1		4960.000	38.061	42.723	-35.939	74.000	-4.662	PK
2		7440.000	37.294	38.337	-36.706	74.000	-1.043	PK
3	*	9920.000	39.873	36.826	-34.127	74.000	3.047	PK

Profile: 2140092R	Page No.: 54
Engineer: Jun Xu	
Site: AC5	Time: 2021/04/20 - 02:05
Limit: FCC_Part15.209_RE(3m)	Margin: 0
Probe: Horn_3117_00123988_(1-18GHz)	Polarity: Horizontal
EUT: LED Lamp	Power: AC 120V/60Hz
Note: Mode 4:Transmit at 2480MHz	

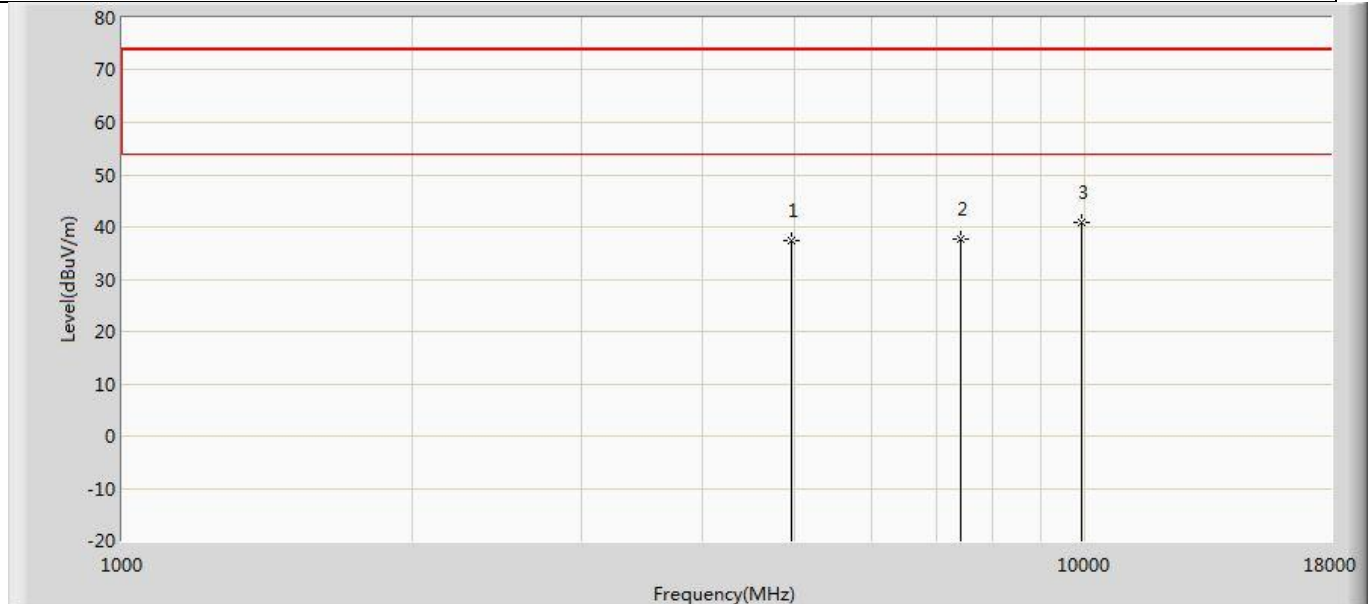

No	Mark	Frequency (MHz)	Measure Level (dBuV/m)	Reading Level (dBuV)	Over Limit (dB)	Limit (dBuV/m)	Factor (dB)	Type
1		4960.000	37.289	41.951	-36.711	74.000	-4.662	PK
2		7440.000	37.662	38.705	-36.338	74.000	-1.043	PK
3	*	9920.000	40.824	37.777	-33.176	74.000	3.047	PK

Note:

1. Measured Level = Reading Level + Factor.
2. The test frequency range, 9kHz~30MHz, 18GHz~26GHz, both of the worst case are at least 20dB below the limits, therefore no data appear in the report.
3. This limit applies for using average detector, if the test result on peak is lower than average limit, then average measurement needn't be performed.
4. As the radiated emission was performed, so conducted emission was not tested.

The worst case of Radiated Emission below 1GHz:

Profile: 2140092R	Page No.: 3
Engineer: Jun Xu	
Site: AC3	Time: 2021/04/19 - 19:27
Limit: FCC_Part15.209_RE(3m)	Margin: 0
Probe: AC3_3m (30-1000MHz)	Polarity: Vertical
EUT: LED Lamp	Power: 120V/60Hz
Note: Mode 1	

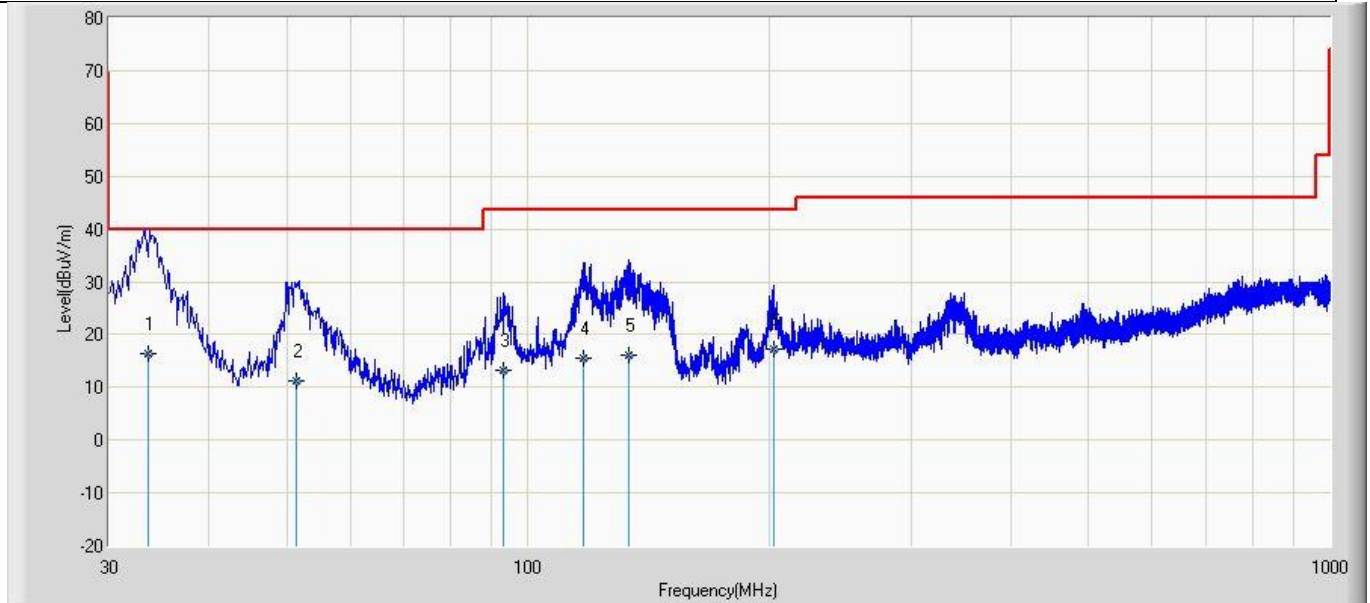

No	Mark	Frequency (MHz)	Measure Level (dBuV/m)	Reading Level (dBuV)	Over Limit (dB)	Limit (dBuV/m)	Factor (dB)	Ant Pos (cm)	Table Pos (deg)	Type
1	*	33.520	16.324	-6.520	-23.676	40.000	22.845	100	42	QP
2		51.332	11.228	-6.552	-28.772	40.000	17.780	100	142	QP
3		93.311	13.378	-5.520	-30.122	43.500	18.898	100	321	QP
4		117.400	15.497	-5.520	-28.003	43.500	21.017	100	352	QP
5		133.666	16.144	-4.520	-27.356	43.500	20.664	100	42	QP
6		202.313	17.124	-5.500	-26.376	43.500	22.624	100	14	QP

Profile: 2140092R	Page No.: 4
Engineer: Jun Xu	
Site: AC3	Time: 2021/04/19 - 19:29
Limit: FCC_Part15.209_RE(3m)	Margin: 0
Probe: AC3_3m (30-1000MHz)	Polarity: Horizontal
EUT: LED Lamp	Power: 120V/60Hz
Note: Mode 1	

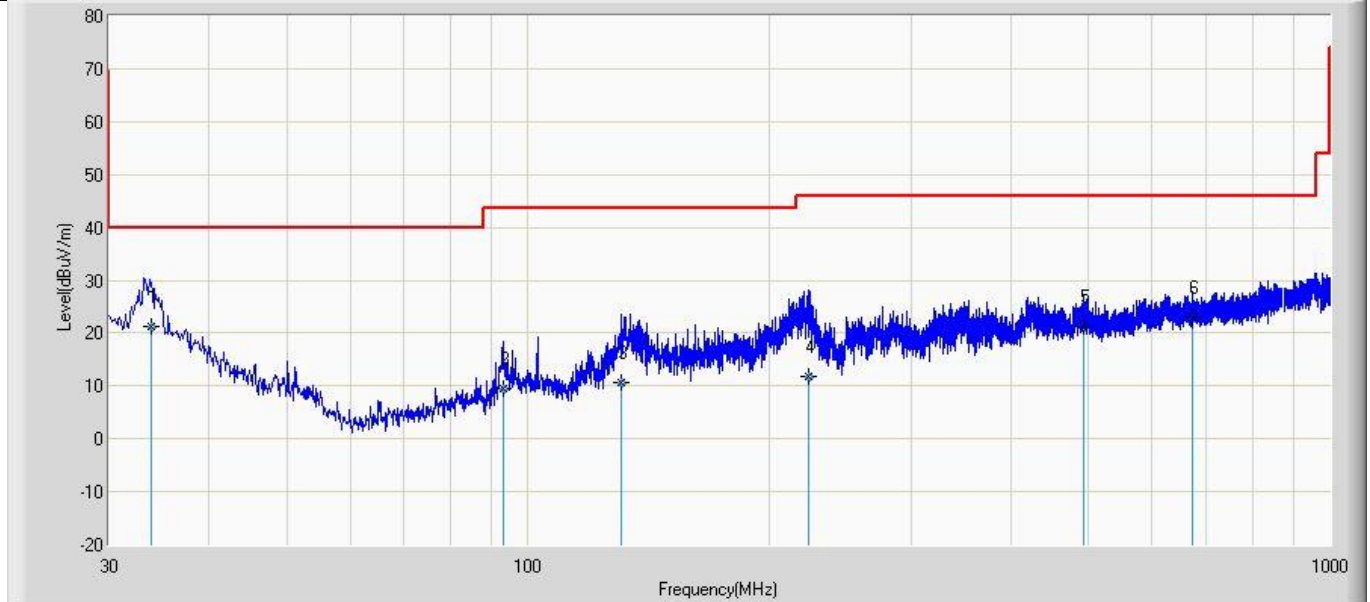

No	Mark	Frequency (MHz)	Measure Level (dBuV/m)	Reading Level (dBuV)	Over Limit (dB)	Limit (dBuV/m)	Factor (dB)	Ant Pos (cm)	Table Pos (deg)	Type
1	*	33.812	21.346	-4.520	-18.654	40.000	25.866	100	155	QP
2		92.999	9.638	-4.520	-33.862	43.500	14.158	100	72	QP
3		130.881	10.701	-6.520	-32.799	43.500	17.221	100	42	QP
4		223.881	11.912	-6.520	-34.088	46.000	18.432	100	73	QP
5		493.115	21.163	-5.520	-24.837	46.000	26.683	100	33	QP
6		673.111	22.958	-5.630	-23.042	46.000	28.588	100	4	QP

4.3 Emissions in non-restricted frequency band	VERDICT: PASS
---	----------------------

4.3.1 Limit	
Standard	FCC Part 15 Subpart C Paragraph 15.247(d)
RF Output power (Detection methods)	Limit(dB)
RF Output power(Average detector)	30dBc(Note1)
RF Output power(PK detector)	20dBc(Note2)
<p>Note 1: If maximum conducted (average) output power was used to demonstrate compliance as described in 9.2, then the peak power in any 100 kHz bandwidth outside of the authorized frequency band shall be attenuated by at least 30 dB relative to the maximum in-band peak PSD level in 100 kHz (i.e., 30 dBc).</p> <p>Note 2: If the maximum peak conducted output power procedure was used, then the peak output power measured in any 100 kHz bandwidth outside of the authorized frequency band shall be attenuated by at least 20 dB relative to the maximum in-band peak PSD level in 100 kHz (i.e., 20 dBc).</p>	

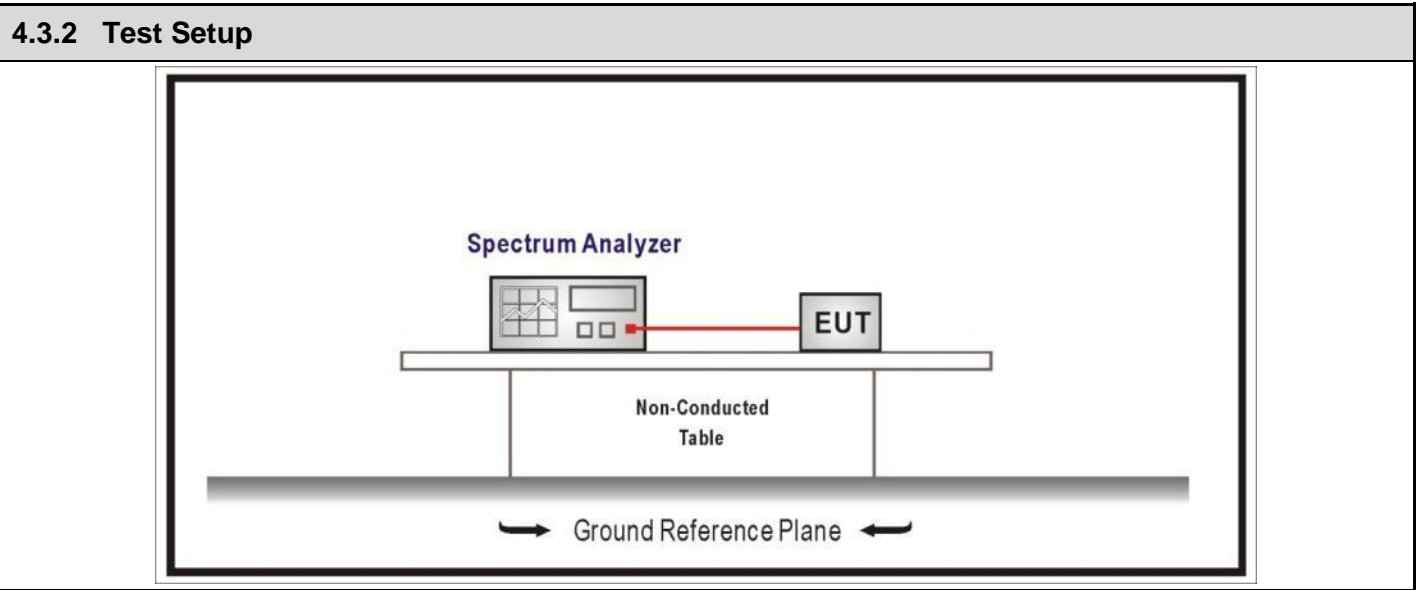

4.3.3 Test Procedure			
References Rule	Chapter	Description	
<input checked="" type="checkbox"/>	ANSI C63.10	11.11	Emissions in non-restricted frequency bands
<input checked="" type="checkbox"/>	ANSI C63.10	11.11.1	General
<input checked="" type="checkbox"/>	ANSI C63.10	11.11.2	Reference level measurement
<input checked="" type="checkbox"/>	ANSI C63.10	11.11.3	Emission level measurement

4.3.4 Test Data

Mode 1 CH00 (2402MHz)

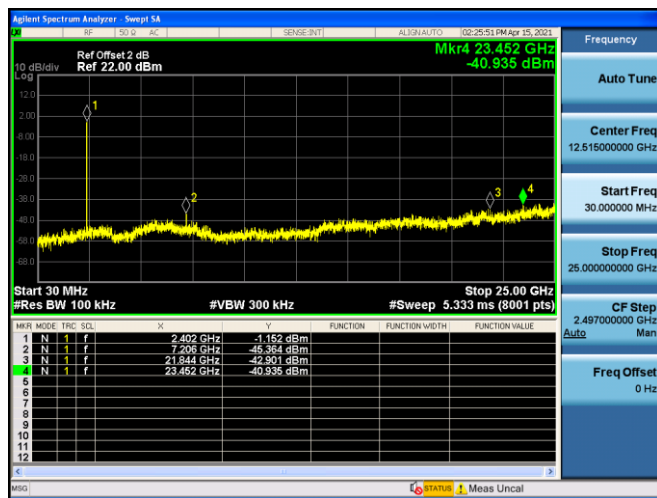

Mode 1 CH39 (2480MHz)

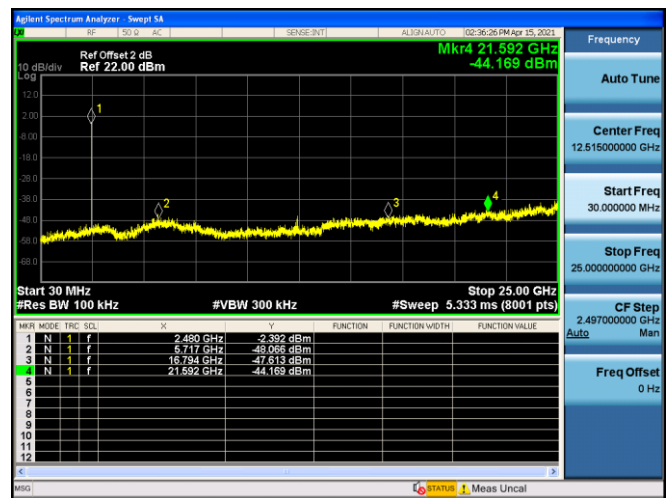

Mode 2 CH00 (2402MHz)

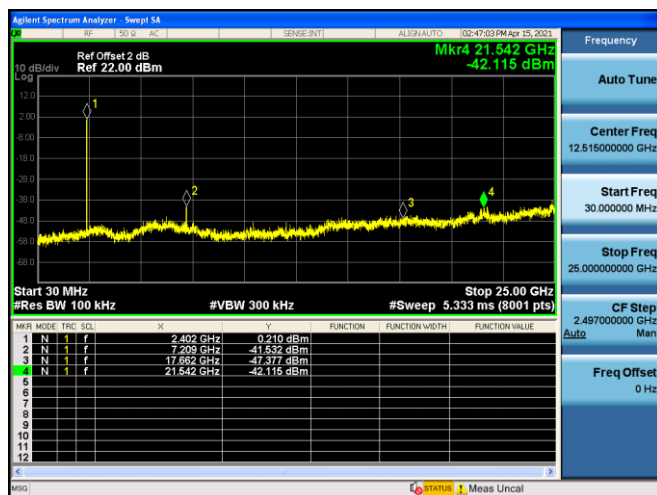

Mode 2 CH39 (2480MHz)



Mode 3 CH00 (2402MHz)

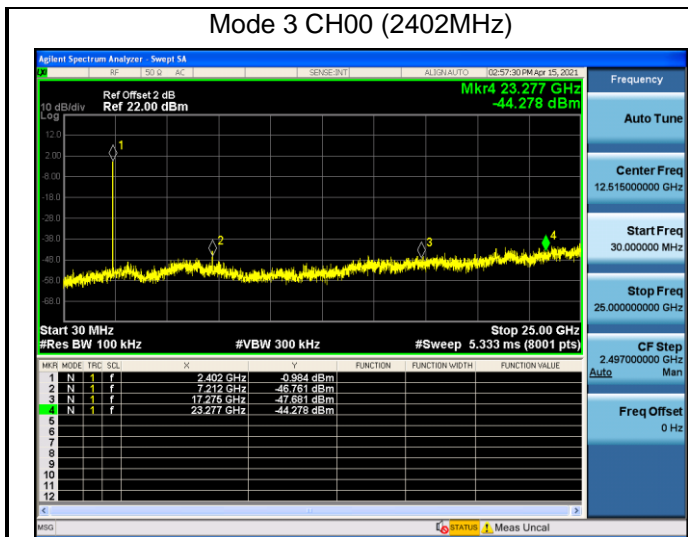

Mode 3 CH39 (2480MHz)

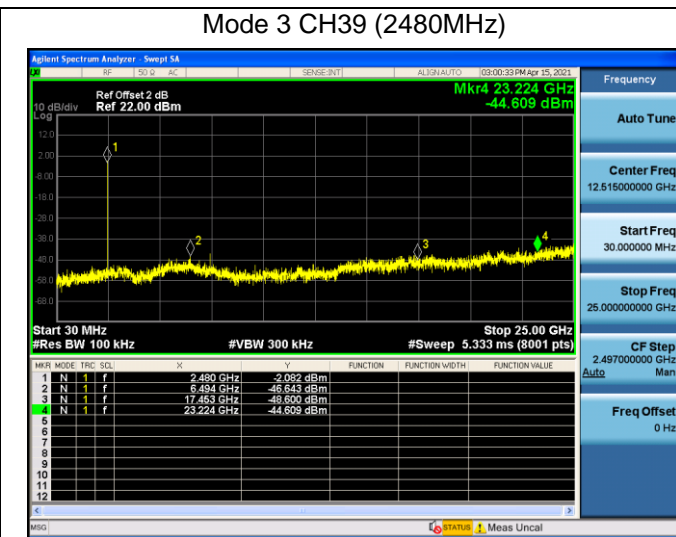

Mode 4 CH00 (2402MHz)

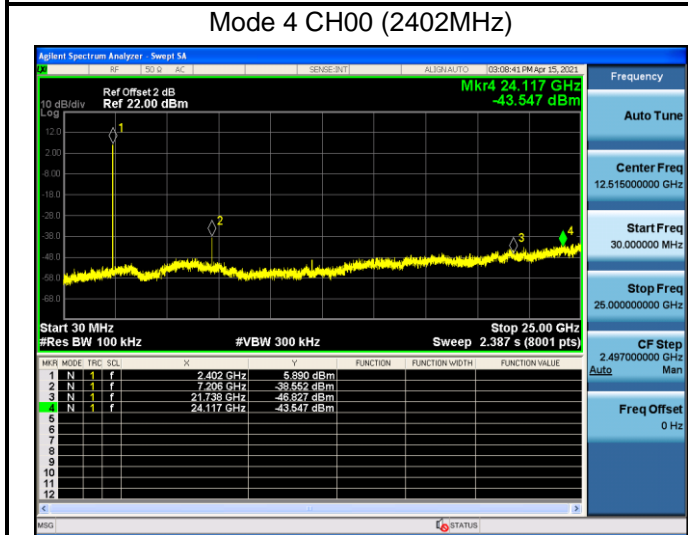

Mode 4 CH39 (2480MHz)

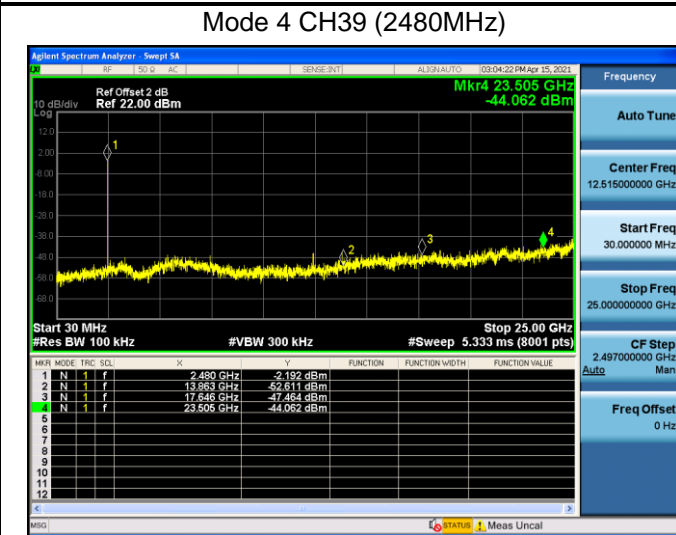

4.4 Duty cycle	VERDICT: PASS
-----------------------	----------------------

4.4.1 Limit
N/A

4.4.2 Test Setup

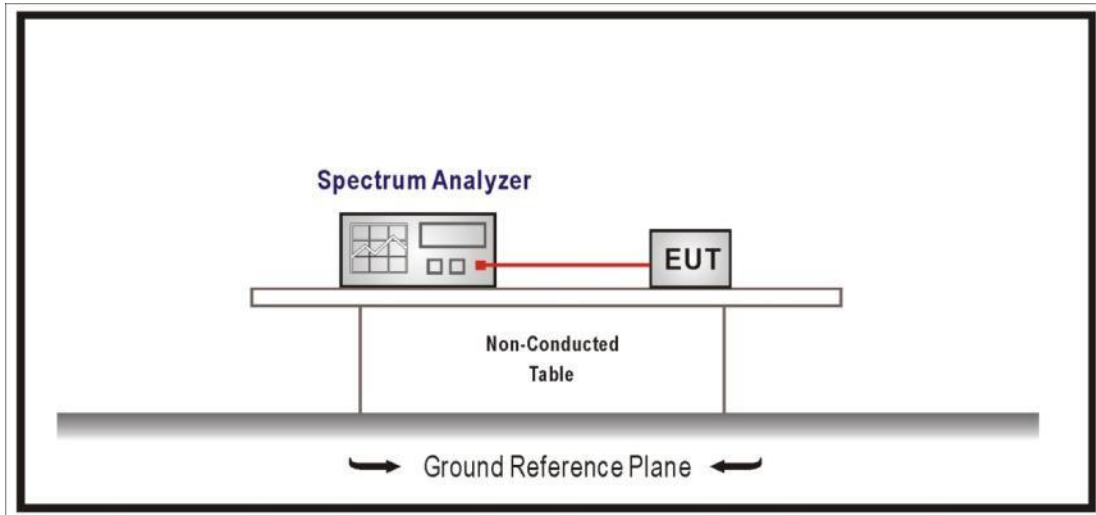

4.4.3 Test Procedure

References Rule	Chapter	Description
<input checked="" type="checkbox"/> ANSI C63.10	11.6	Duty cycle (D), transmission duration (T), and maximum power control level

4.4.4 Test Data

Test Mode	Tx On (us)	Tx Off (us)	VBW (kHz)	Tx On + Tx Off (us)	Duty Cycle (%)
Mode 1	--	--	--	--	100
Mode 2	--	--	--	--	100
Mode 3	--	--	--	--	100
Mode 4	--	--	--	--	100

Note 1: T means the minimum transmission duration over which the transmitter is on and is transmitting at its maximum power control level for the tested mode of operation.

Note 2: According to KDB 558074, when test for Radiated Emission Band Edge and Radiated Emission, for average detector set: $VBW \geq 1/T$ will be used.

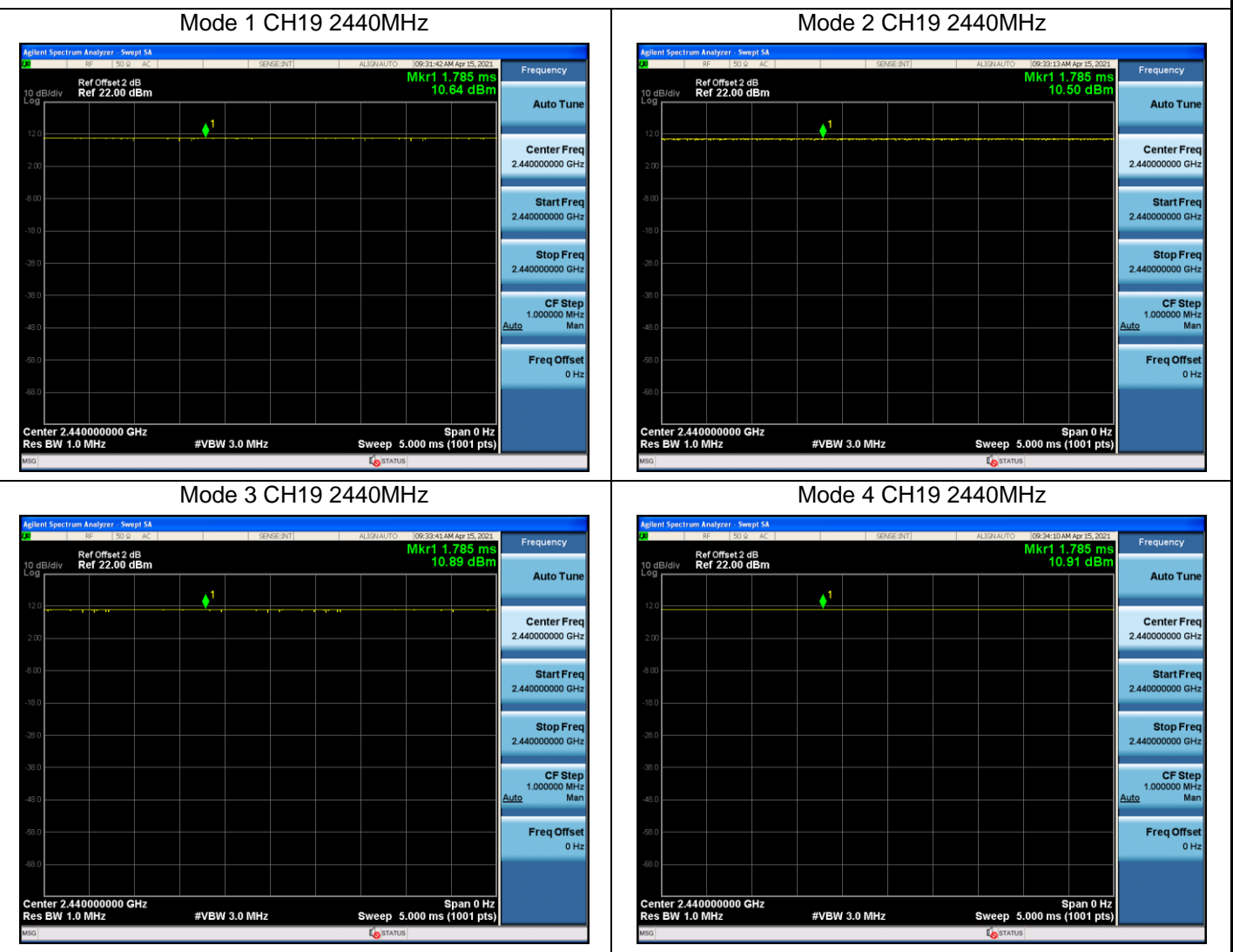

4.5 Radiated Emission Band Edge	VERDICT:	PASS
--	-----------------	-------------

4.5.1 Limit

Standard		FCC Part 15 Subpart C Paragraph 15.247(d) ,15.209		
Frequency bands (MHz)	Detector	Limit (dBµV/m)	RBW (MHz)	Distance (m)
2310-2390	PK	74	1	3
2483.5-2500	AV	54	1	3

Note: The field strength of emissions appearing within these frequency bands shall not exceed the limits.

4.5.2 Test Setup

Above 1GHz Test Setup:

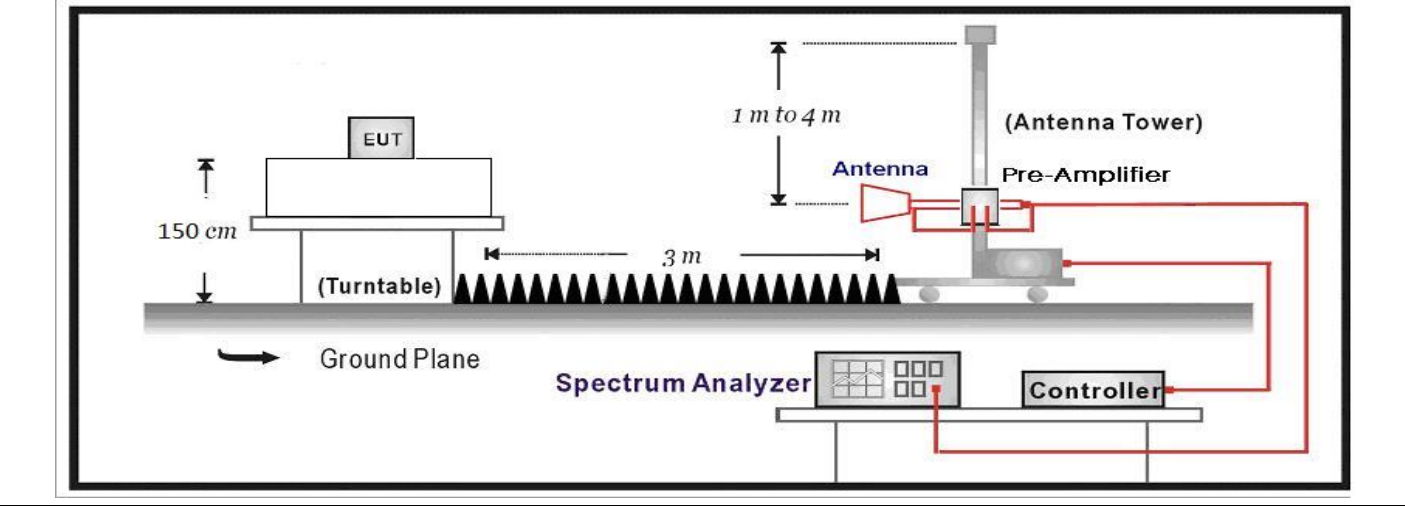

4.5.3 Test Procedure

	References Rule	Chapter	Description
<input checked="" type="checkbox"/>	ANSI C63.10	6.10	Band-edge testing
	<input checked="" type="checkbox"/> ANSI C63.10	6.10.5	Restricted-band band-edge measurements
	<input type="checkbox"/> ANSI C63.10	6.10.6	Marker-delta method
<input checked="" type="checkbox"/>	ANSI C63.10	11.12	Emissions in restricted frequency bands
	<input checked="" type="checkbox"/> ANSI C63.10	11.12.1	Radiated emission measurements
	<input checked="" type="checkbox"/> ANSI C63.10	11.12.2.7	Radiated spurious emission test
<input type="checkbox"/>	ANSI C63.10	6.4	Radiated emissions from unlicensed wireless devices below 30 MHz
<input type="checkbox"/>	ANSI C63.10	6.5	Radiated emissions from unlicensed wireless devices in the frequency range of 30 MHz to 1000 MHz
<input checked="" type="checkbox"/>	ANSI C63.10	6.6	Radiated emissions from unlicensed wireless devices above 1 GHz

4.5.4 Test Data

Profile: 2140092R	Page No.: 1
Engineer: Jun Xu	
Site: AC5	Time: 2021/04/20 - 20:00
Limit: FCC_Part15.209_RE(3m)	Margin: 0
Probe: Horn_3117_00167055(1-18GHz)	Polarity: Vertical
EUT: LED Lamp	Power: AC 120V/60Hz
Note: Mode 1:Transmit at 2402MHz	

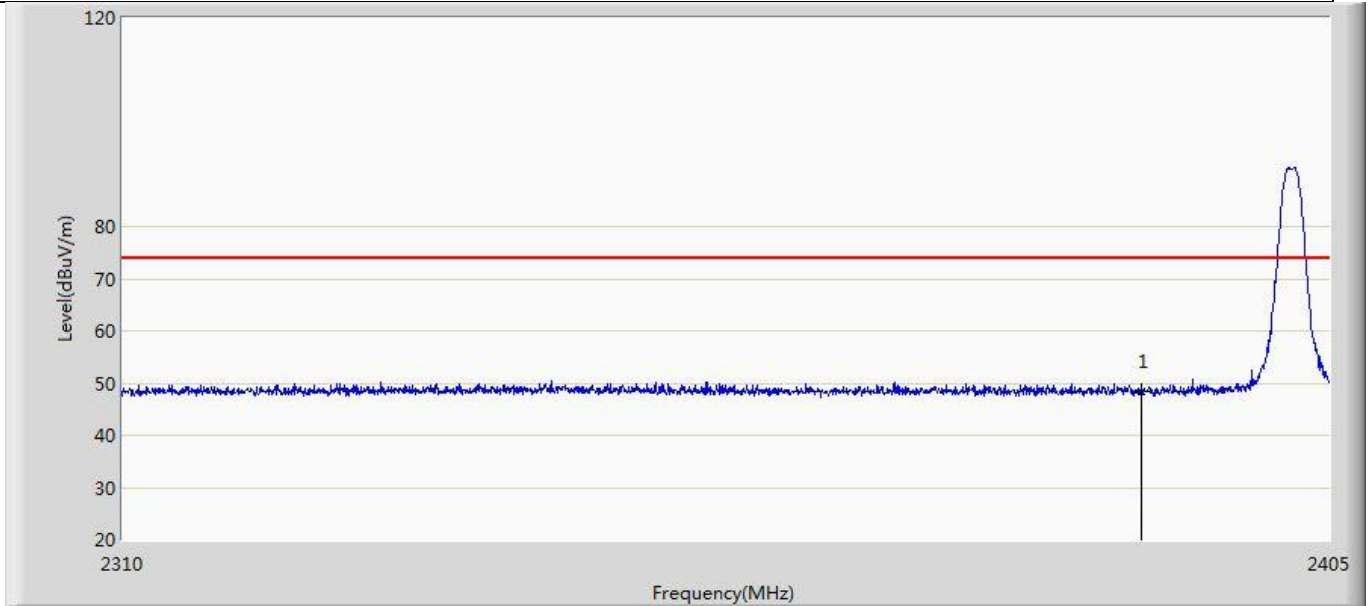

No	Mark	Frequency (MHz)	Measure Level (dBuV/m)	Reading Level (dBuV)	Over Limit (dB)	Limit (dBuV/m)	Factor (dB)	Type
1	*	2390.000	48.437	12.081	-25.563	74.000	36.357	PK

Profile: 2140092R	Page No.: 3
Engineer: Jun Xu	
Site: AC5	Time: 2021/04/20 - 20:06
Limit: FCC_Part15.209_RE(3m)	Margin: 0
Probe: Horn_3117_00167055(1-18GHz)	Polarity: Vertical
EUT: LED Lamp	Power: AC 120V/60Hz
Note: Mode 1:Transmit at 2402MHz	

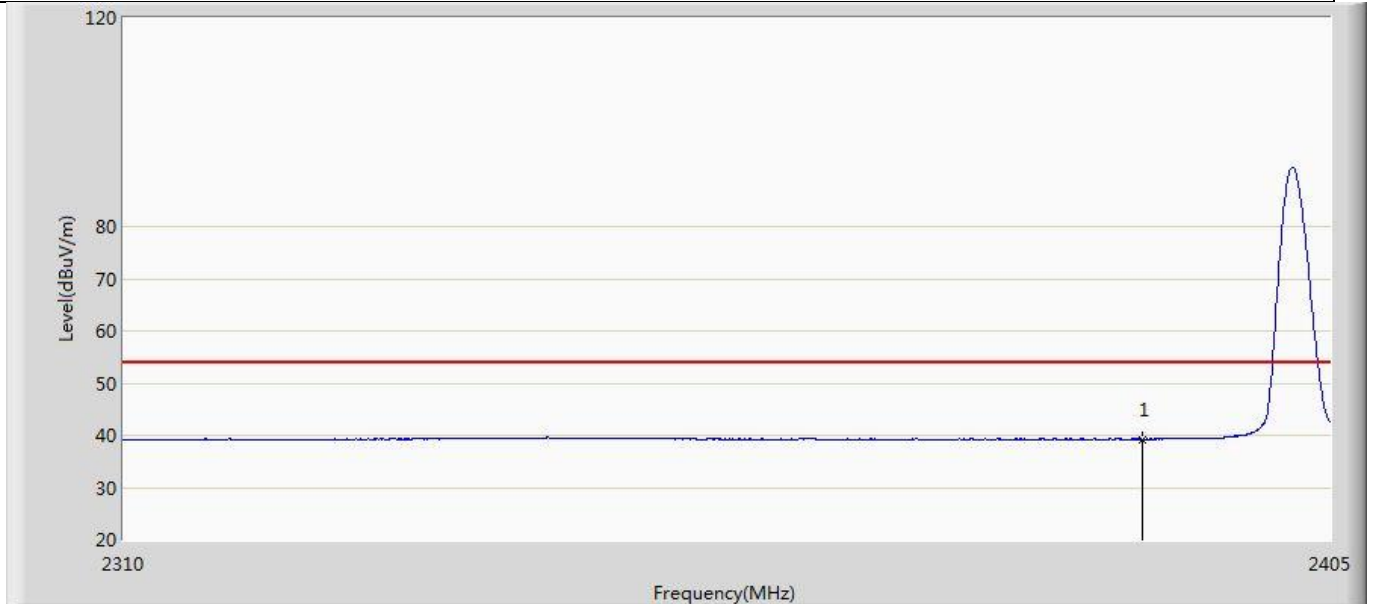

No	Mark	Frequency (MHz)	Measure Level (dBuV/m)	Reading Level (dBuV)	Over Limit (dB)	Limit (dBuV/m)	Factor (dB)	Type
1	*	2390.000	39.248	2.892	-14.752	54.000	36.357	AV

Profile: 2140092R	Page No.: 5
Engineer: Jun Xu	
Site: AC5	Time: 2021/04/20 - 20:12
Limit: FCC_Part15.209_RE(3m)	Margin: 0
Probe: Horn_3117_00167055(1-18GHz)	Polarity: Horizontal
EUT: LED Lamp	Power: AC 120V/60Hz
Note: Mode 1:Transmit at 2402MHz	

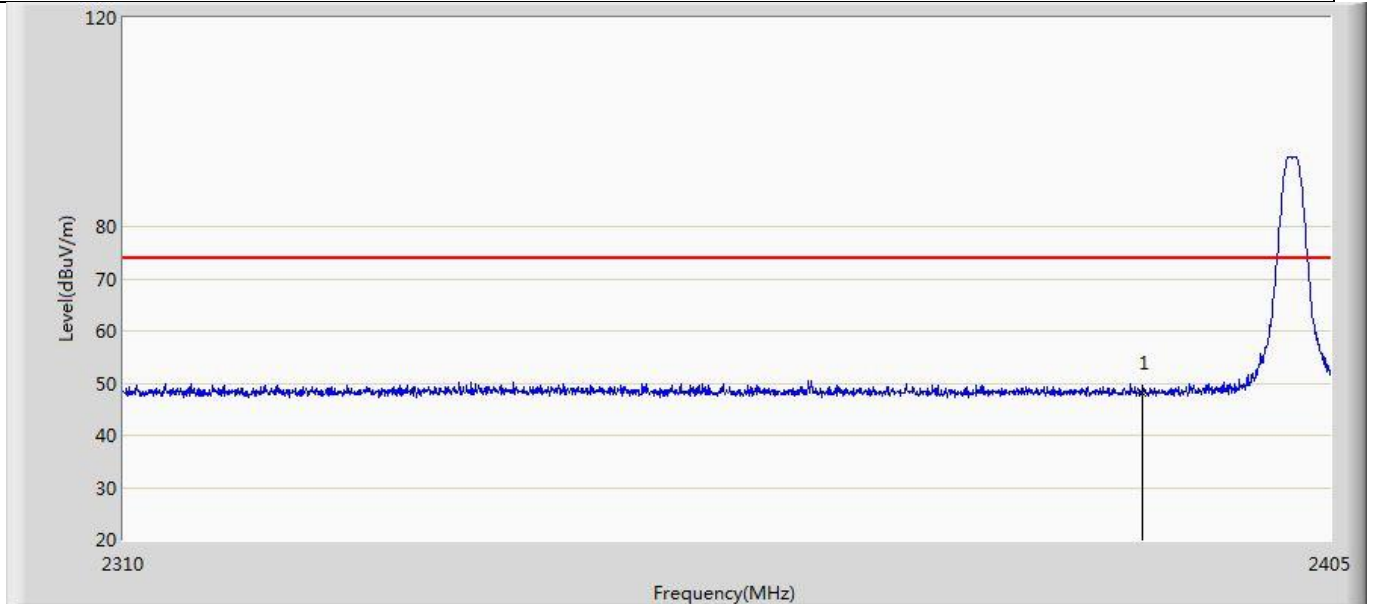

No	Mark	Frequency (MHz)	Measure Level (dBuV/m)	Reading Level (dBuV)	Over Limit (dB)	Limit (dBuV/m)	Factor (dB)	Type
1	*	2390.000	48.014	11.658	-25.986	74.000	36.357	PK

Profile: 2140092R	Page No.: 7
Engineer: Jun Xu	
Site: AC5	Time: 2021/04/20 - 20:14
Limit: FCC_Part15.209_RE(3m)	Margin: 0
Probe: Horn_3117_00167055(1-18GHz)	Polarity: Horizontal
EUT: LED Lamp	Power: AC 120V/60Hz
Note: Mode 1:Transmit at 2402MHz	

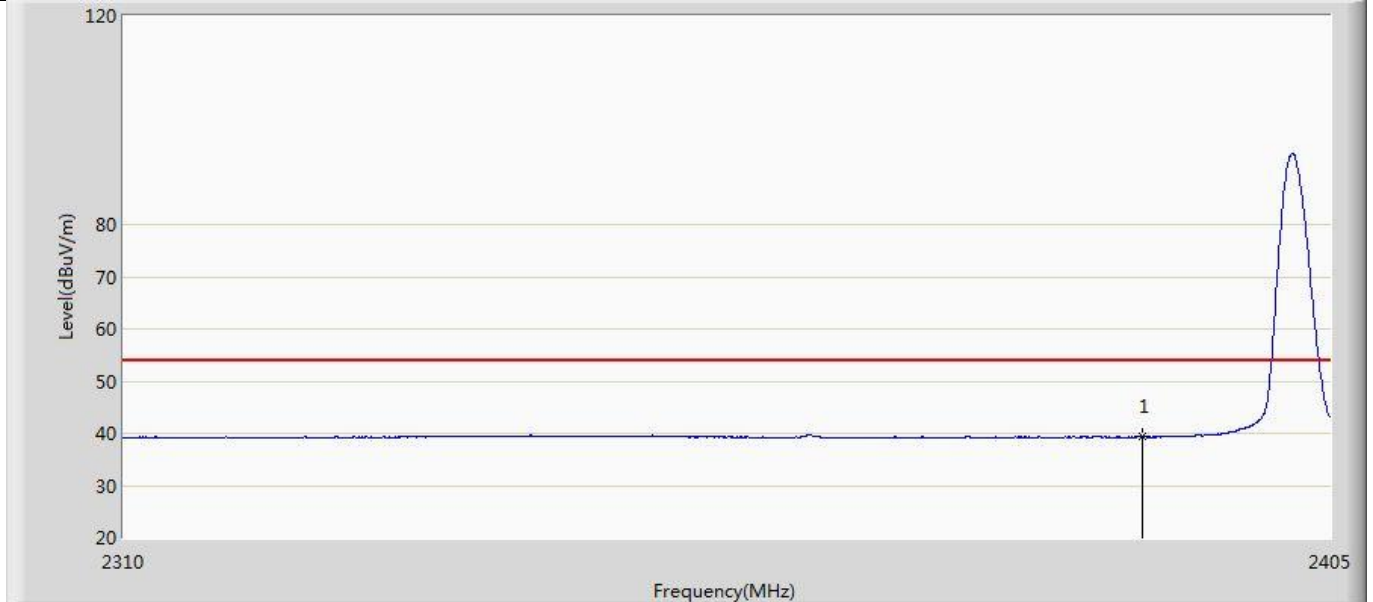

No	Mark	Frequency (MHz)	Measure Level (dBuV/m)	Reading Level (dBuV)	Over Limit (dB)	Limit (dBuV/m)	Factor (dB)	Type
1	*	2390.000	39.433	3.077	-14.567	54.000	36.357	AV

Profile: 2140092R	Page No.: 33
Engineer: Jun Xu	
Site: AC5	Time: 2021/04/20 - 21:31
Limit: FCC_Part15.209_RE(3m)	Margin: 0
Probe: Horn_3117_00167055(1-18GHz)	Polarity: Vertical
EUT: LED Lamp	Power: AC 120V/60Hz
Note: Mode 1:Transmit at 2480MHz	

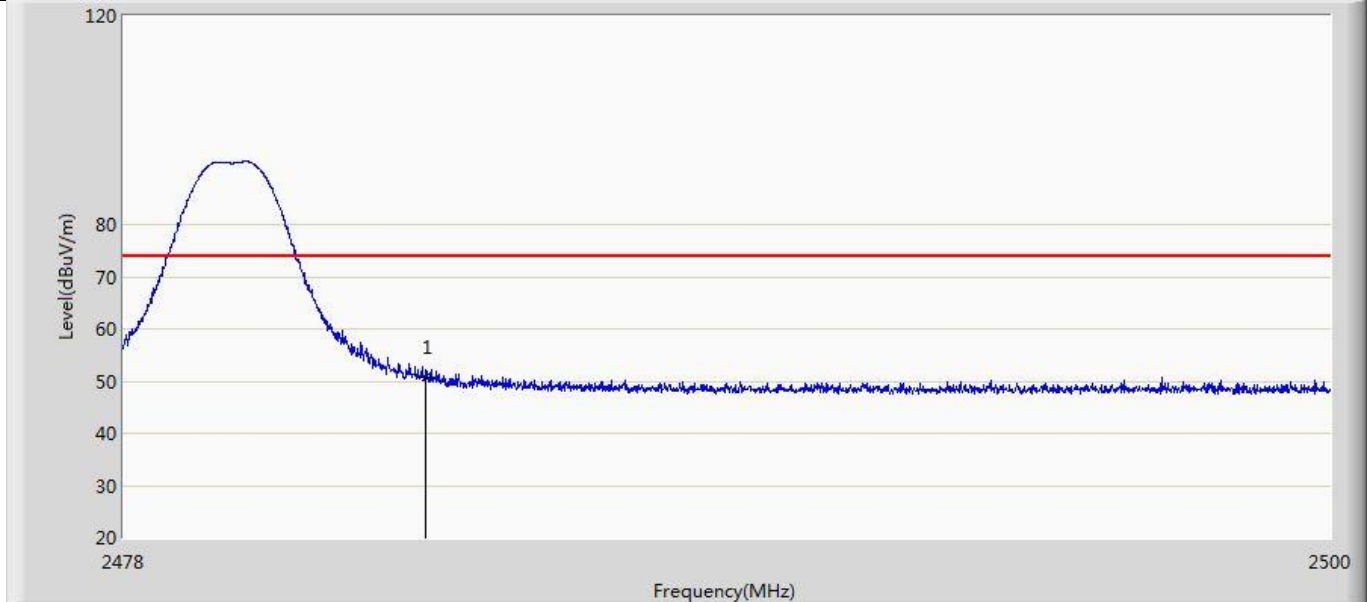

No	Mark	Frequency (MHz)	Measure Level (dBuV/m)	Reading Level (dBuV)	Over Limit (dB)	Limit (dBuV/m)	Factor (dB)	Type
1	*	2483.500	50.600	14.196	-23.400	74.000	36.404	PK

Profile: 2140092R	Page No.: 35
Engineer: Jun Xu	
Site: AC5	Time: 2021/04/20 - 21:37
Limit: FCC_Part15.209_RE(3m)	Margin: 0
Probe: Horn_3117_00167055(1-18GHz)	Polarity: Vertical
EUT: LED Lamp	Power: AC 120V/60Hz
Note: Mode 1:Transmit at 2480MHz	

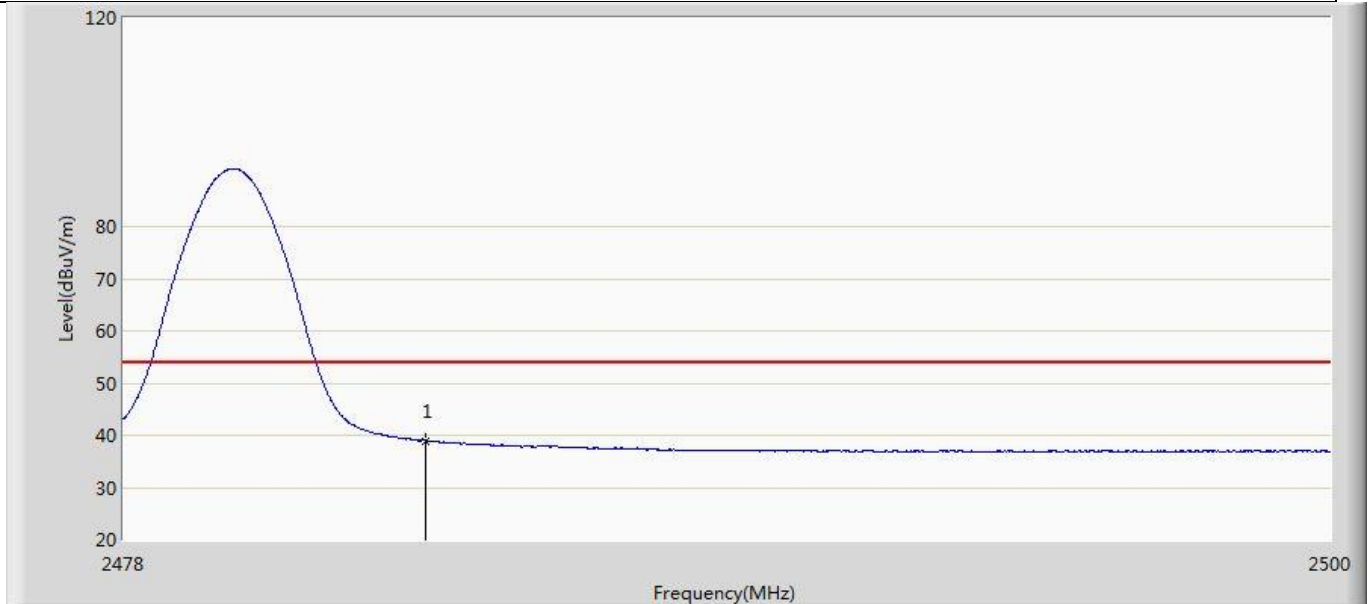

No	Mark	Frequency (MHz)	Measure Level (dBuV/m)	Reading Level (dBuV)	Over Limit (dB)	Limit (dBuV/m)	Factor (dB)	Type
1	*	2483.500	38.984	2.580	-15.016	54.000	36.404	AV

Profile: 2140092R	Page No.: 37
Engineer: Jun Xu	
Site: AC5	Time: 2021/04/20 - 21:40
Limit: FCC_Part15.209_RE(3m)	Margin: 0
Probe: Horn_3117_00167055(1-18GHz)	Polarity: Horizontal
EUT: LED Lamp	Power: AC 120V/60Hz
Note: Mode 1:Transmit at 2480MHz	

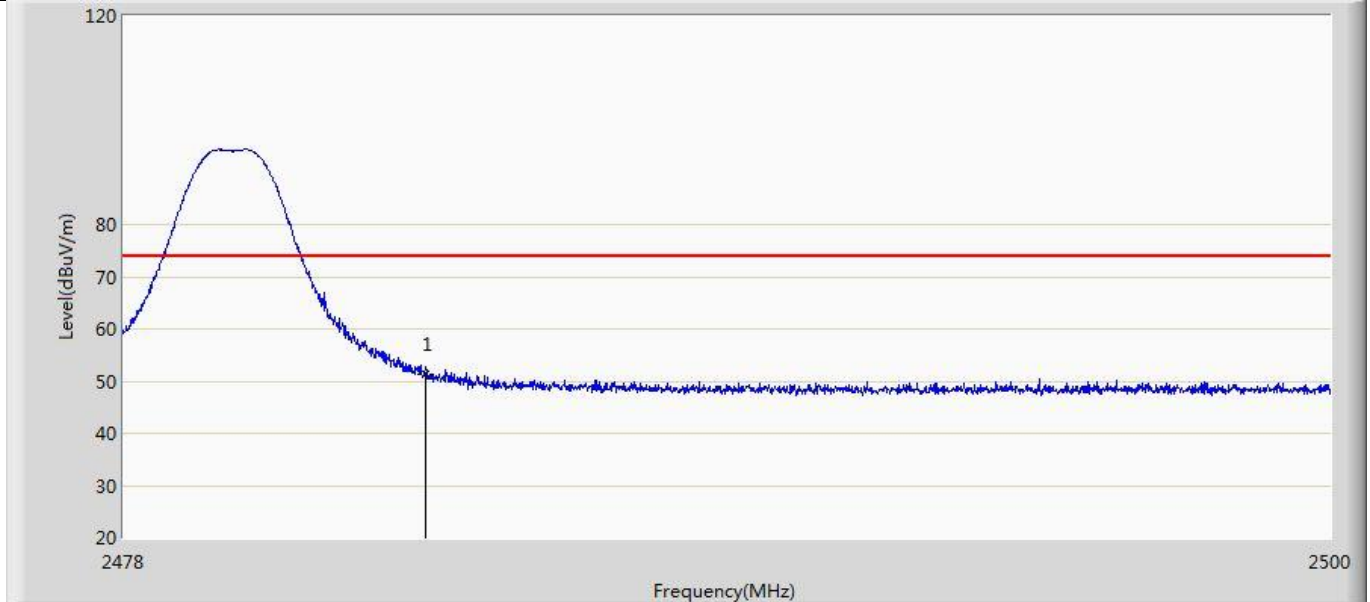

No	Mark	Frequency (MHz)	Measure Level (dBuV/m)	Reading Level (dBuV)	Over Limit (dB)	Limit (dBuV/m)	Factor (dB)	Type
1	*	2483.500	51.347	14.943	-22.653	74.000	36.404	PK

Profile: 2140092R	Page No.: 39
Engineer: Jun Xu	
Site: AC5	Time: 2021/04/20 - 21:42
Limit: FCC_Part15.209_RE(3m)	Margin: 0
Probe: Horn_3117_00167055(1-18GHz)	Polarity: Horizontal
EUT: LED Lamp	Power: AC 120V/60Hz
Note: Mode 1:Transmit at 2480MHz	

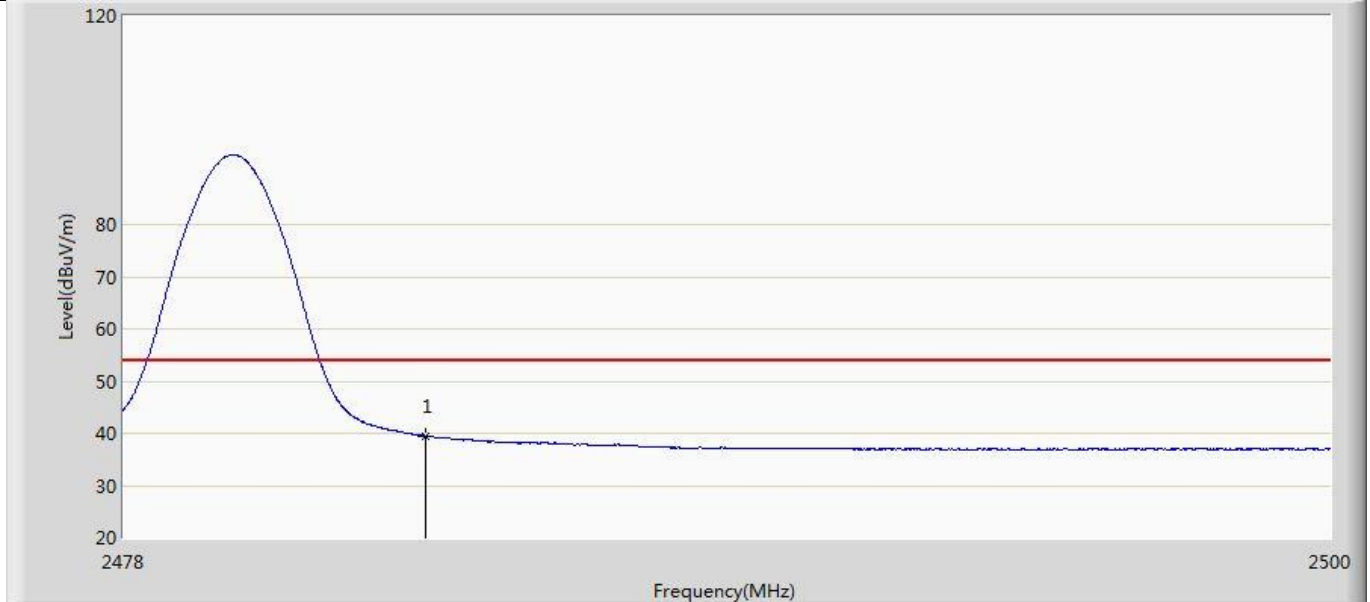

No	Mark	Frequency (MHz)	Measure Level (dBuV/m)	Reading Level (dBuV)	Over Limit (dB)	Limit (dBuV/m)	Factor (dB)	Type
1	*	2483.500	39.477	3.073	-14.523	54.000	36.404	AV

Profile: 2140092R	Page No.: 9
Engineer: Jun Xu	
Site: AC5	Time: 2021/04/20 - 20:17
Limit: FCC_Part15.209_RE(3m)	Margin: 0
Probe: Horn_3117_00167055(1-18GHz)	Polarity: Vertical

EUT: LED Lamp	Power: AC 120V/60Hz
Note: Mode 2:Transmit at 2402MHz	

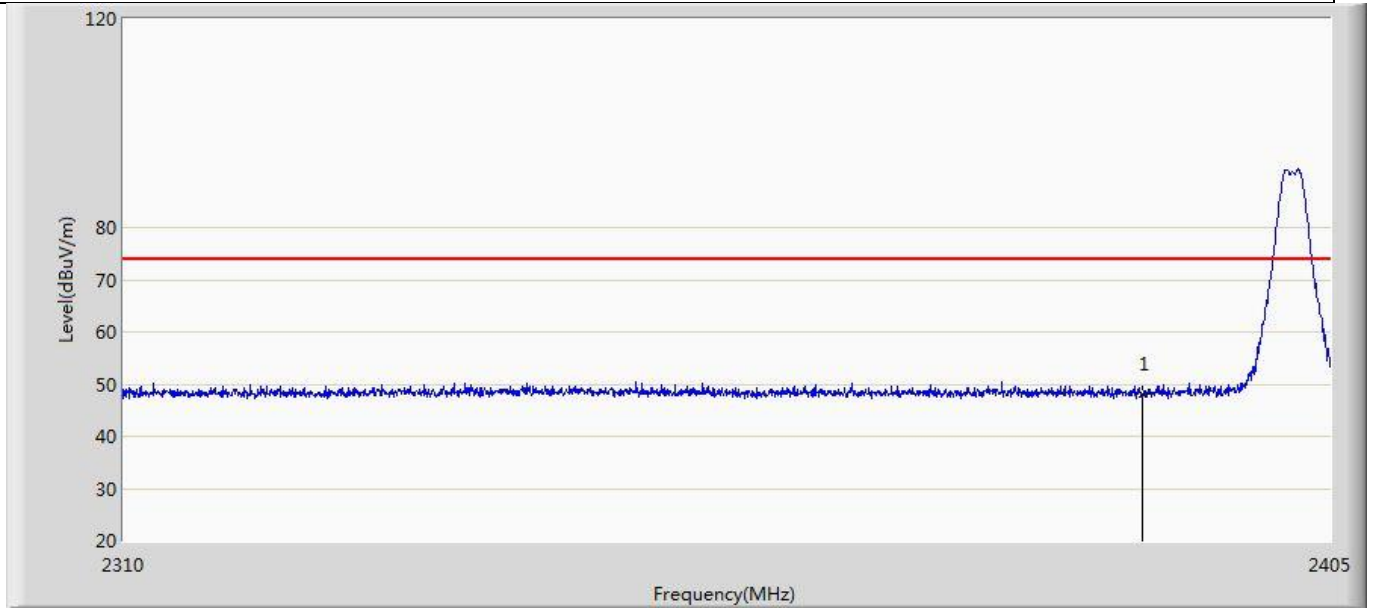

No	Mark	Frequency (MHz)	Measure Level (dBuV/m)	Reading Level (dBuV)	Over Limit (dB)	Limit (dBuV/m)	Factor (dB)	Type
1	*	2390.000	48.031	11.675	-25.969	74.000	36.357	PK

Profile: 2140092R	Page No.: 11
Engineer: Jun Xu	
Site: AC5	Time: 2021/04/20 - 20:19
Limit: FCC_Part15.209_RE(3m)	Margin: 0
Probe: Horn_3117_00167055(1-18GHz)	Polarity: Vertical
EUT: LED Lamp	Power: AC 120V/60Hz
Note: Mode 2:Transmit at 2402MHz	

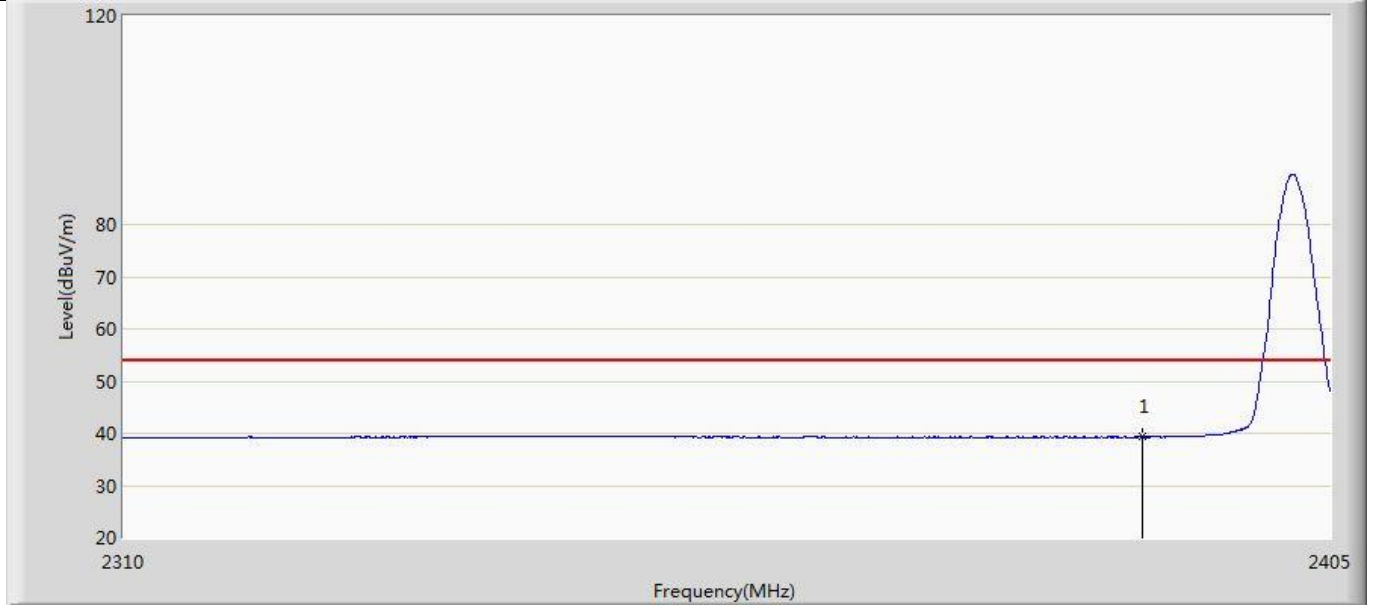

No	Mark	Frequency (MHz)	Measure Level (dBuV/m)	Reading Level (dBuV)	Over Limit (dB)	Limit (dBuV/m)	Factor (dB)	Type
1	*	2390.000	39.330	2.974	-14.670	54.000	36.357	AV

Profile: 2140092R	Page No.: 13
Engineer: Jun Xu	
Site: AC5	Time: 2021/04/20 - 20:22
Limit: FCC_Part15.209_RE(3m)	Margin: 0
Probe: Horn_3117_00167055(1-18GHz)	Polarity: Horizontal
EUT: LED Lamp	Power: AC 120V/60Hz
Note: Mode 2:Transmit at 2402MHz	

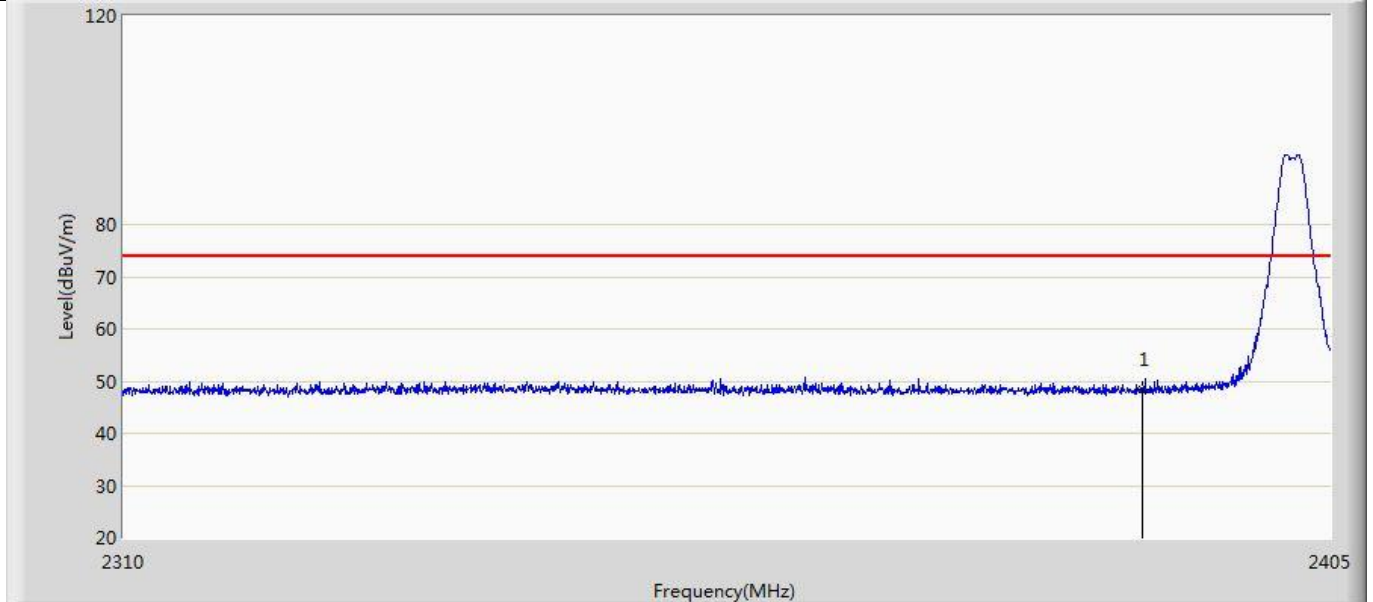

No	Mark	Frequency (MHz)	Measure Level (dBuV/m)	Reading Level (dBuV)	Over Limit (dB)	Limit (dBuV/m)	Factor (dB)	Type
1	*	2390.000	48.472	12.116	-25.528	74.000	36.357	PK

Profile: 2140092R	Page No.: 15
Engineer: Jun Xu	
Site: AC5	Time: 2021/04/20 - 20:24
Limit: FCC_Part15.209_RE(3m)	Margin: 0
Probe: Horn_3117_00167055(1-18GHz)	Polarity: Horizontal
EUT: LED Lamp	Power: AC 120V/60Hz
Note: Mode 2:Transmit at 2402MHz	

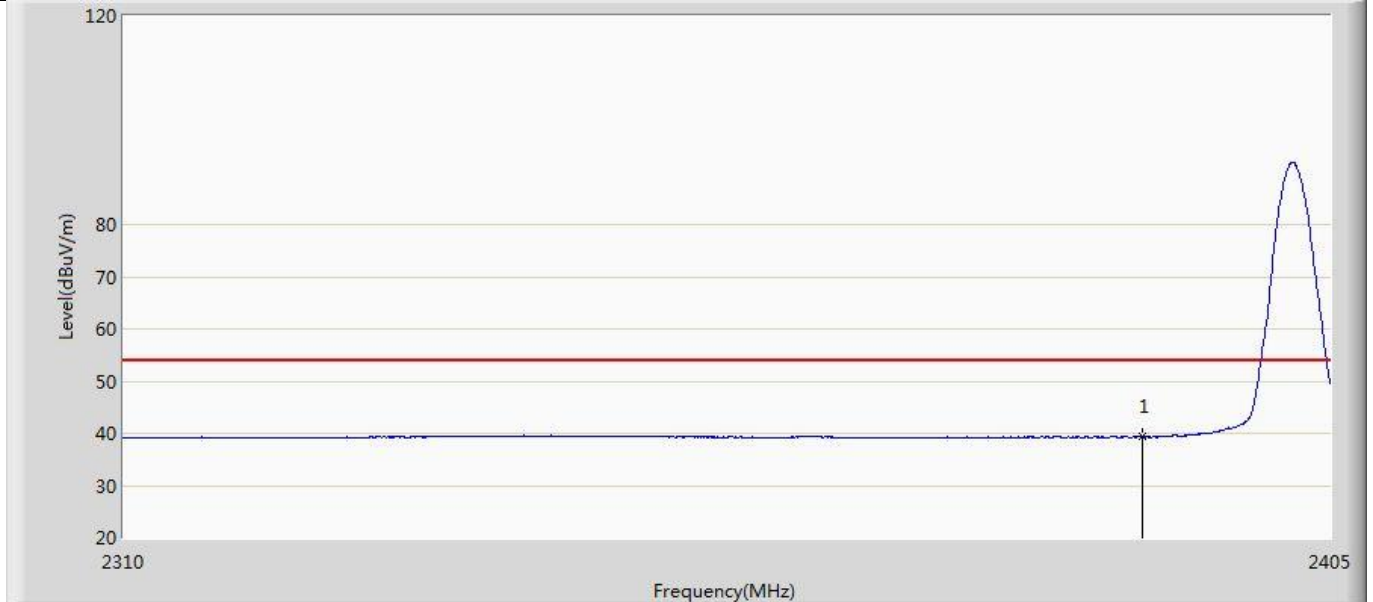

No	Mark	Frequency (MHz)	Measure Level (dBuV/m)	Reading Level (dBuV)	Over Limit (dB)	Limit (dBuV/m)	Factor (dB)	Type
1	*	2390.000	39.356	3.000	-14.644	54.000	36.357	AV

Profile: 2140092R	Page No.: 41
Engineer: Jun Xu	
Site: AC5	Time: 2021/04/20 - 22:57
Limit: FCC_Part15.209_RE(3m)	Margin: 0
Probe: Horn_3117_00167055(1-18GHz)	Polarity: Vertical
EUT: LED Lamp	Power: AC 120V/60Hz
Note: Mode 2:Transmit at 2480MHz	

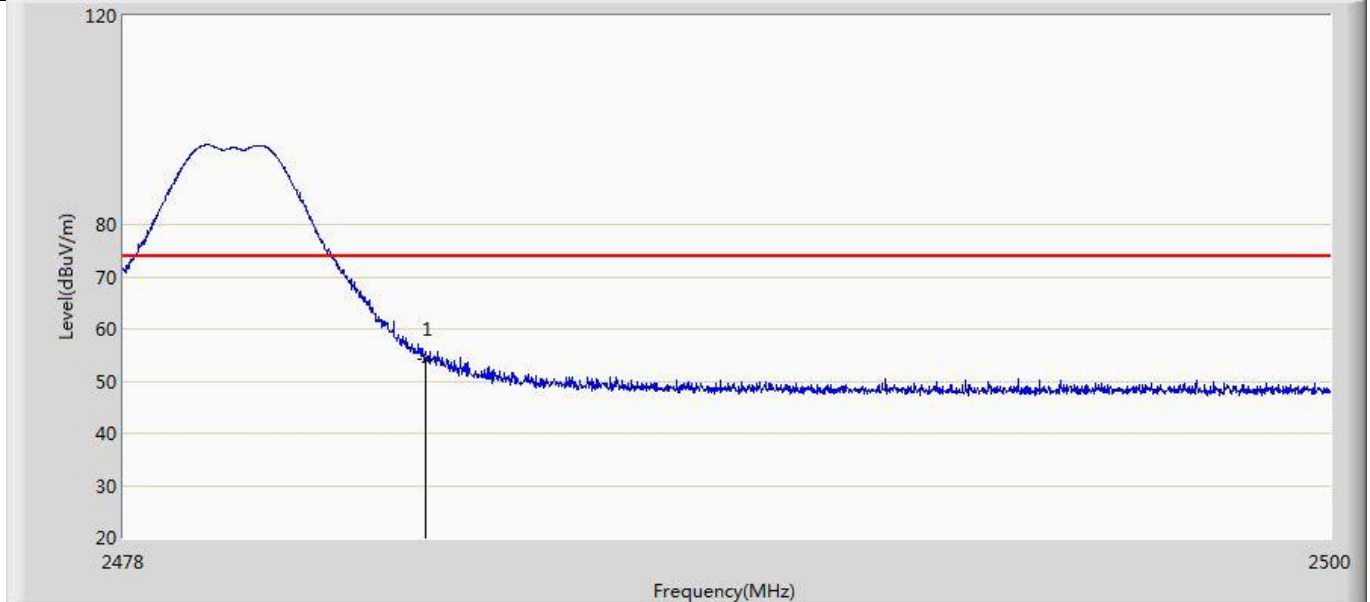

No	Mark	Frequency (MHz)	Measure Level (dBuV/m)	Reading Level (dBuV)	Over Limit (dB)	Limit (dBuV/m)	Factor (dB)	Type
1	*	2483.500	54.081	17.677	-19.919	74.000	36.404	PK

Profile: 2140092R	Page No.: 43
Engineer: Jun Xu	
Site: AC5	Time: 2021/04/20 - 22:58
Limit: FCC_Part15.209_RE(3m)	Margin: 0
Probe: Horn_3117_00167055(1-18GHz)	Polarity: Vertical
EUT: LED Lamp	Power: AC 120V/60Hz
Note: Mode 2:Transmit at 2480MHz	

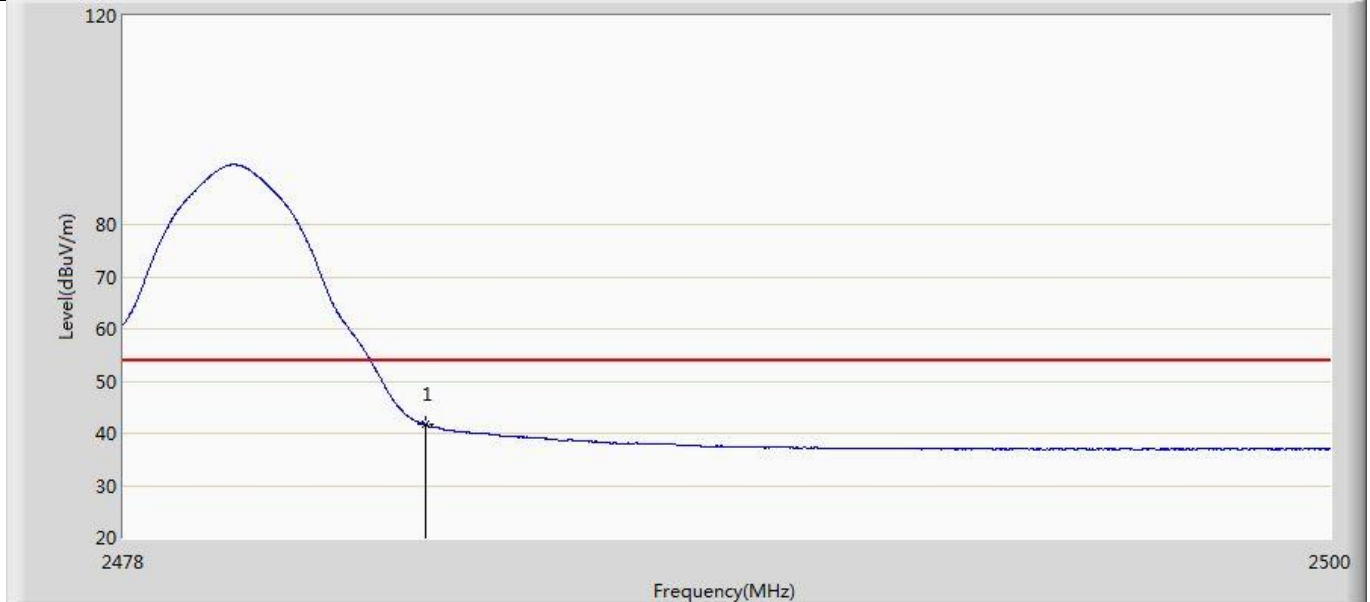

No	Mark	Frequency (MHz)	Measure Level (dBuV/m)	Reading Level (dBuV)	Over Limit (dB)	Limit (dBuV/m)	Factor (dB)	Type
1	*	2483.500	41.659	5.255	-12.341	54.000	36.404	AV

Profile: 2140092R	Page No.: 45
Engineer: Jun Xu	
Site: AC5	Time: 2021/04/20 - 23:00
Limit: FCC_Part15.209_RE(3m)	Margin: 0
Probe: Horn_3117_00167055(1-18GHz)	Polarity: Horizontal
EUT: LED Lamp	Power: AC 120V/60Hz
Note: Mode 2:Transmit at 2480MHz	

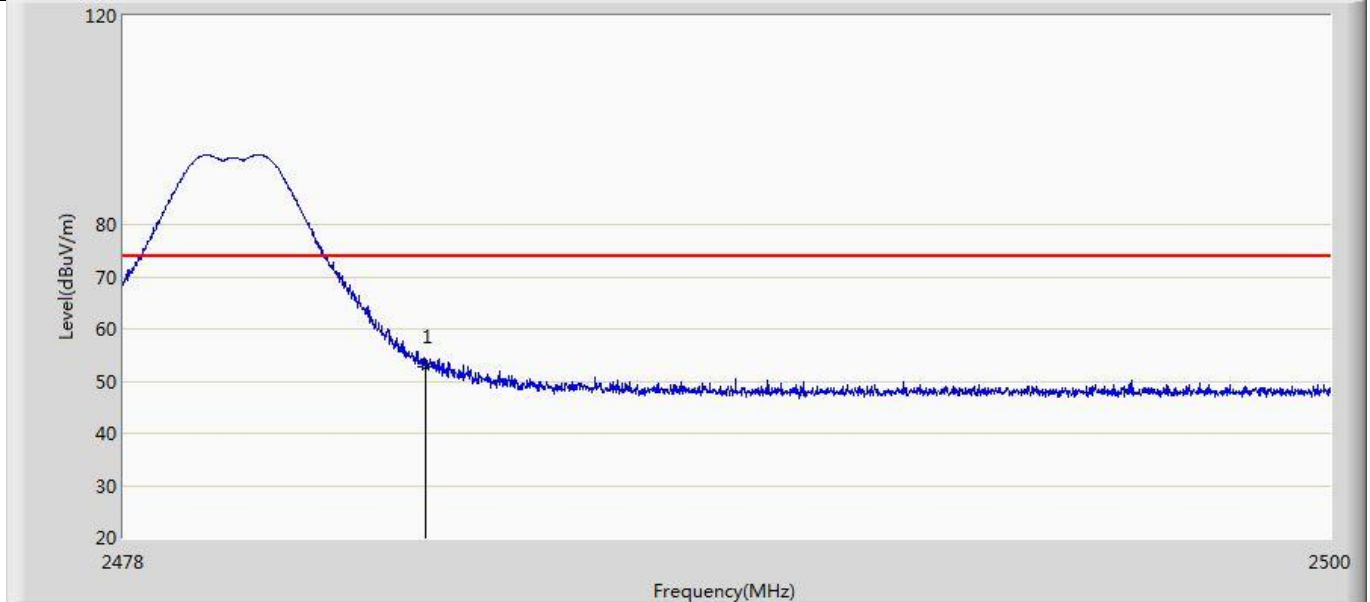

No	Mark	Frequency (MHz)	Measure Level (dBuV/m)	Reading Level (dBuV)	Over Limit (dB)	Limit (dBuV/m)	Factor (dB)	Type
1	*	2483.500	52.613	16.209	-21.387	74.000	36.404	PK

Profile: 2140092R	Page No.: 47
Engineer: Jun Xu	
Site: AC5	Time: 2021/04/20 - 23:01
Limit: FCC_Part15.209_RE(3m)	Margin: 0
Probe: Horn_3117_00167055(1-18GHz)	Polarity: Horizontal
EUT: LED Lamp	Power: AC 120V/60Hz
Note: Mode 2:Transmit at 2480MHz	

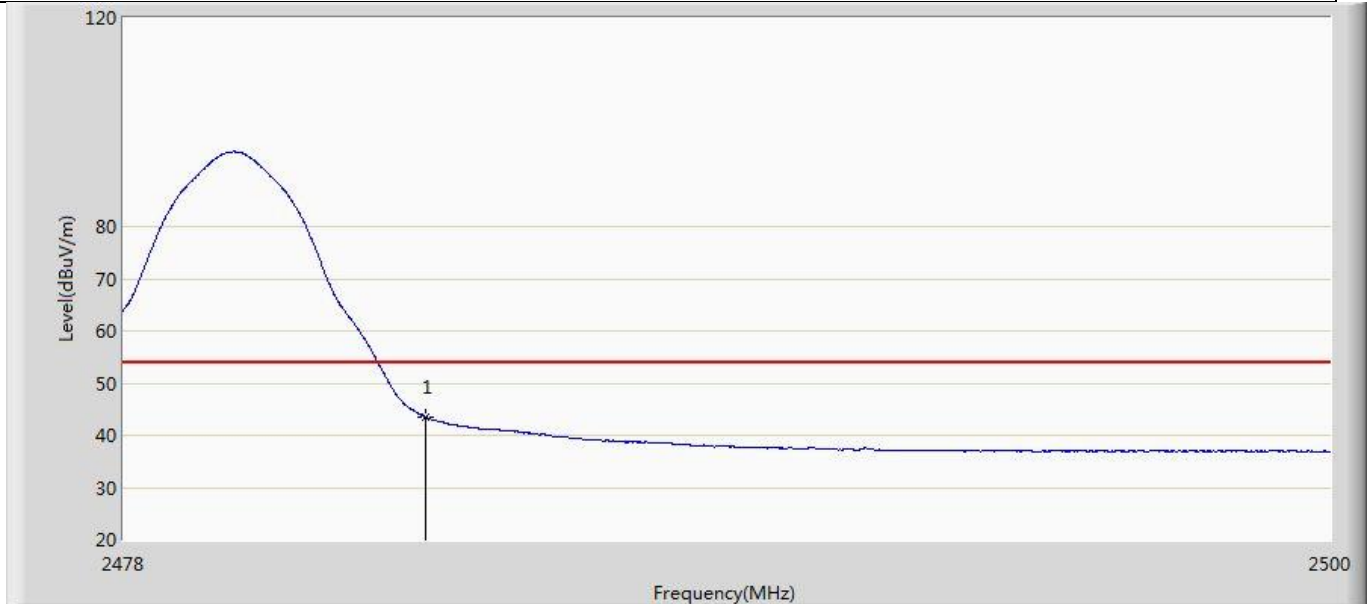

No	Mark	Frequency (MHz)	Measure Level (dBuV/m)	Reading Level (dBuV)	Over Limit (dB)	Limit (dBuV/m)	Factor (dB)	Type
1	*	2483.500	43.346	6.942	-10.654	54.000	36.404	AV

Profile: 2140092R	Page No.: 25
Engineer: Jun Xu	
Site: AC5	Time: 2021/04/20 - 21:18
Limit: FCC_Part15.209_RE(3m)	Margin: 0
Probe: Horn_3117_00167055(1-18GHz)	Polarity: Vertical
EUT: LED Lamp	Power: AC 120V/60Hz
Note: Mode 3:Transmit at 2402MHz	

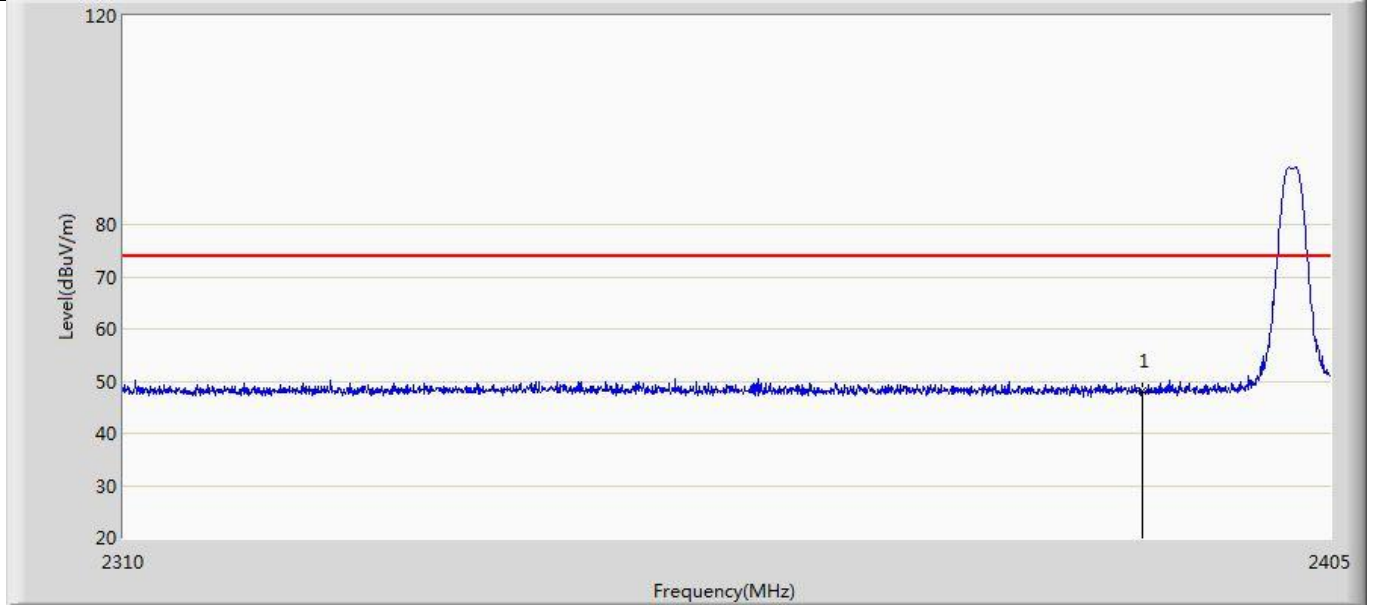

No	Mark	Frequency (MHz)	Measure Level (dBuV/m)	Reading Level (dBuV)	Over Limit (dB)	Limit (dBuV/m)	Factor (dB)	Type
1	*	2390.000	48.160	11.804	-25.840	74.000	36.357	PK

Profile: 2140092R	Page No.: 27
Engineer: Jun Xu	
Site: AC5	Time: 2021/04/20 - 21:20
Limit: FCC_Part15.209_RE(3m)	Margin: 0
Probe: Horn_3117_00167055(1-18GHz)	Polarity: Vertical
EUT: LED Lamp	Power: AC 120V/60Hz
Note: Mode 3:Transmit at 2402MHz	

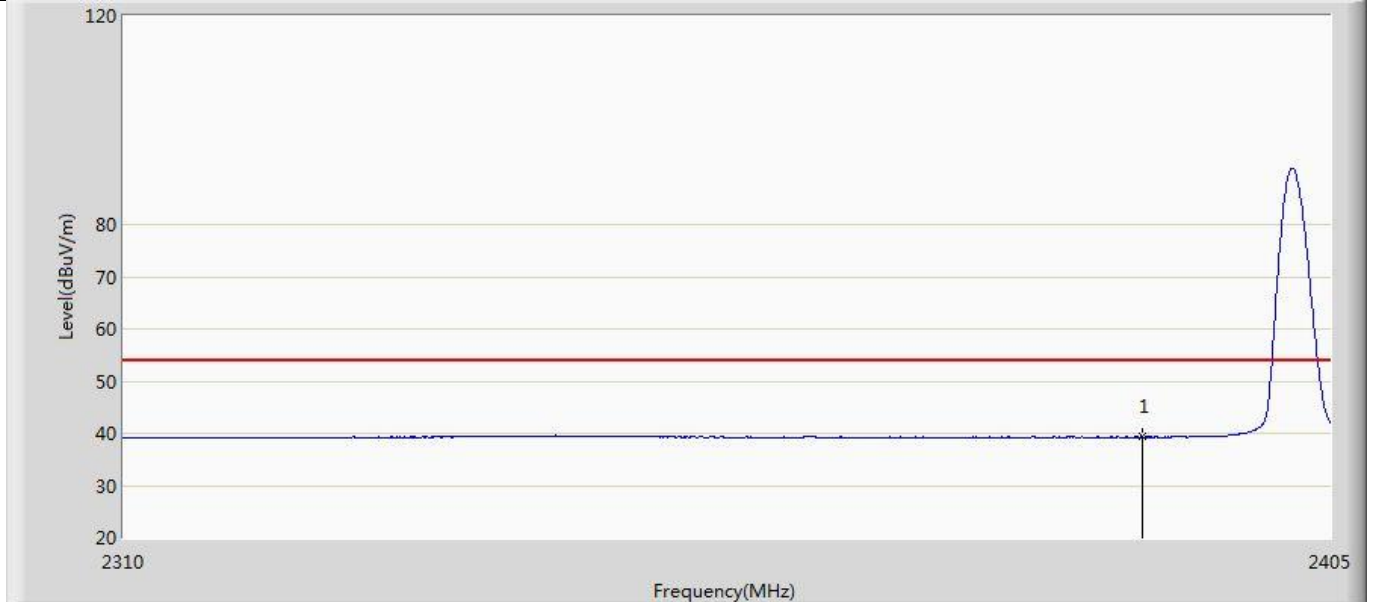

No	Mark	Frequency (MHz)	Measure Level (dBuV/m)	Reading Level (dBuV)	Over Limit (dB)	Limit (dBuV/m)	Factor (dB)	Type
1	*	2390.000	39.364	3.008	-14.636	54.000	36.357	AV

Profile: 2140092R	Page No.: 29
Engineer: Jun Xu	
Site: AC5	Time: 2021/04/20 - 21:22
Limit: FCC_Part15.209_RE(3m)	Margin: 0
Probe: Horn_3117_00167055(1-18GHz)	Polarity: Horizontal
EUT: LED Lamp	Power: AC 120V/60Hz
Note: Mode 3:Transmit at 2402MHz	

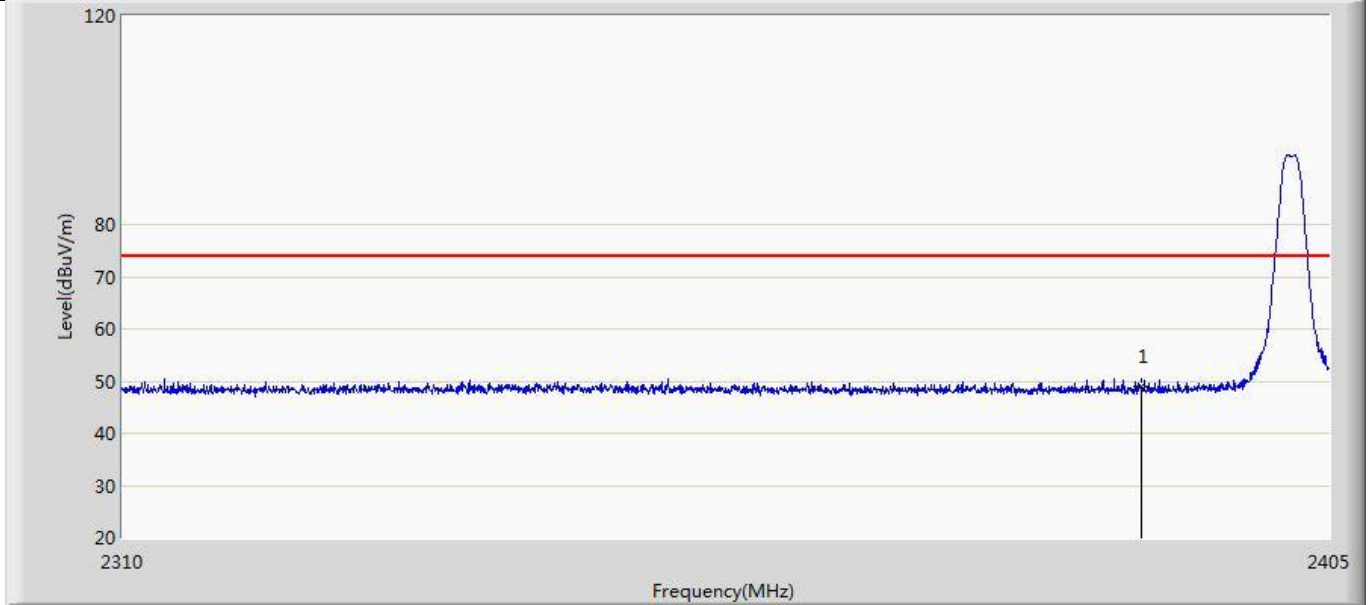

No	Mark	Frequency (MHz)	Measure Level (dBuV/m)	Reading Level (dBuV)	Over Limit (dB)	Limit (dBuV/m)	Factor (dB)	Type
1	*	2390.000	48.991	12.635	-25.009	74.000	36.357	PK

Profile: 2140092R	Page No.: 31
Engineer: Jun Xu	
Site: AC5	Time: 2021/04/20 - 21:24
Limit: FCC_Part15.209_RE(3m)	Margin: 0
Probe: Horn_3117_00167055(1-18GHz)	Polarity: Horizontal
EUT: LED Lamp	Power: AC 120V/60Hz
Note: Mode 3:Transmit at 2402MHz	

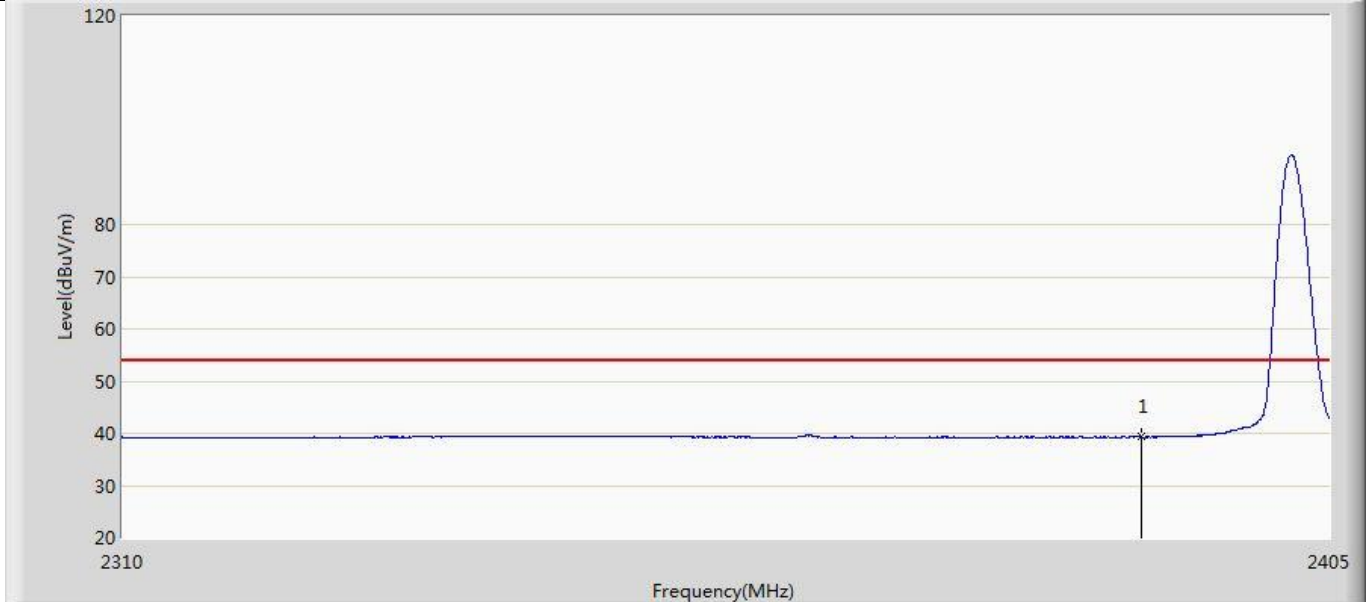

No	Mark	Frequency (MHz)	Measure Level (dBuV/m)	Reading Level (dBuV)	Over Limit (dB)	Limit (dBuV/m)	Factor (dB)	Type
1	*	2390.000	39.277	2.921	-14.723	54.000	36.357	AV

Profile: 2140092R	Page No.: 57
Engineer: Jun Xu	
Site: AC5	Time: 2021/04/20 - 21:58
Limit: FCC_Part15.209_RE(3m)	Margin: 0
Probe: Horn_3117_00167055(1-18GHz)	Polarity: Vertical
EUT: LED Lamp	Power: AC 120V/60Hz
Note: Mode 3:Transmit at 2480MHz	

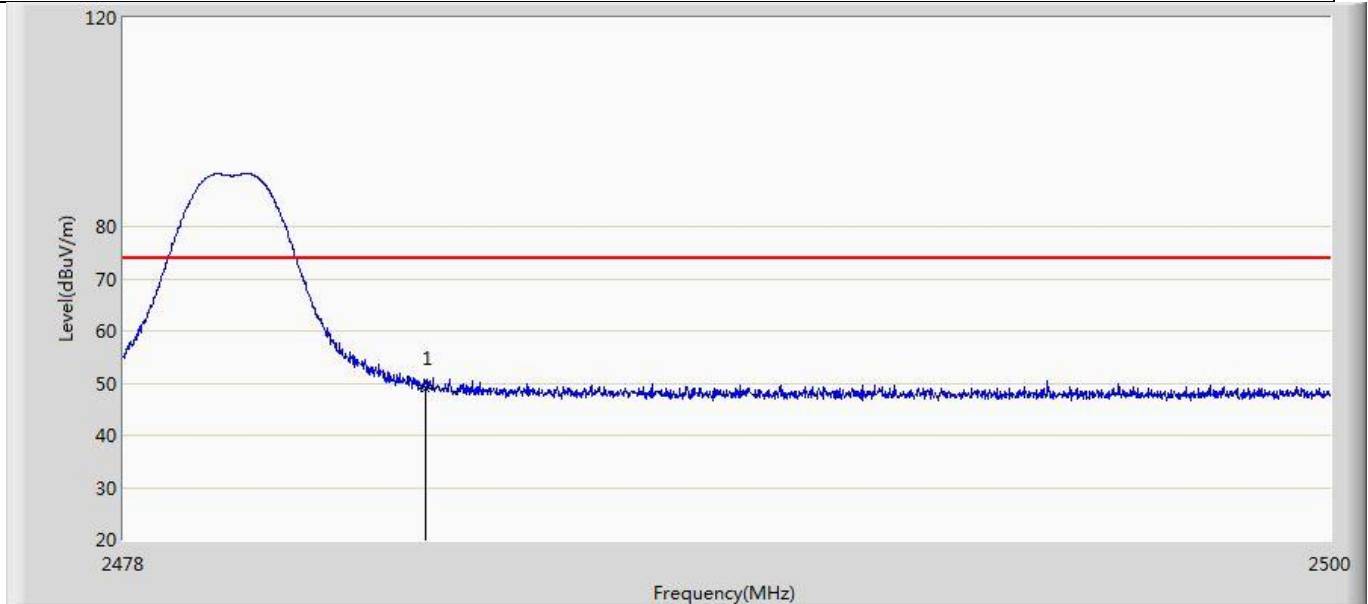

No	Mark	Frequency (MHz)	Measure Level (dBuV/m)	Reading Level (dBuV)	Over Limit (dB)	Limit (dBuV/m)	Factor (dB)	Type
1	*	2483.500	48.874	12.470	-25.126	74.000	36.404	PK

Profile: 2140092R	Page No.: 59
Engineer: Jun Xu	
Site: AC5	Time: 2021/04/20 - 22:01
Limit: FCC_Part15.209_RE(3m)	Margin: 0
Probe: Horn_3117_00167055(1-18GHz)	Polarity: Vertical
EUT: LED Lamp	Power: AC 120V/60Hz
Note: Mode 3:Transmit at 2480MHz	

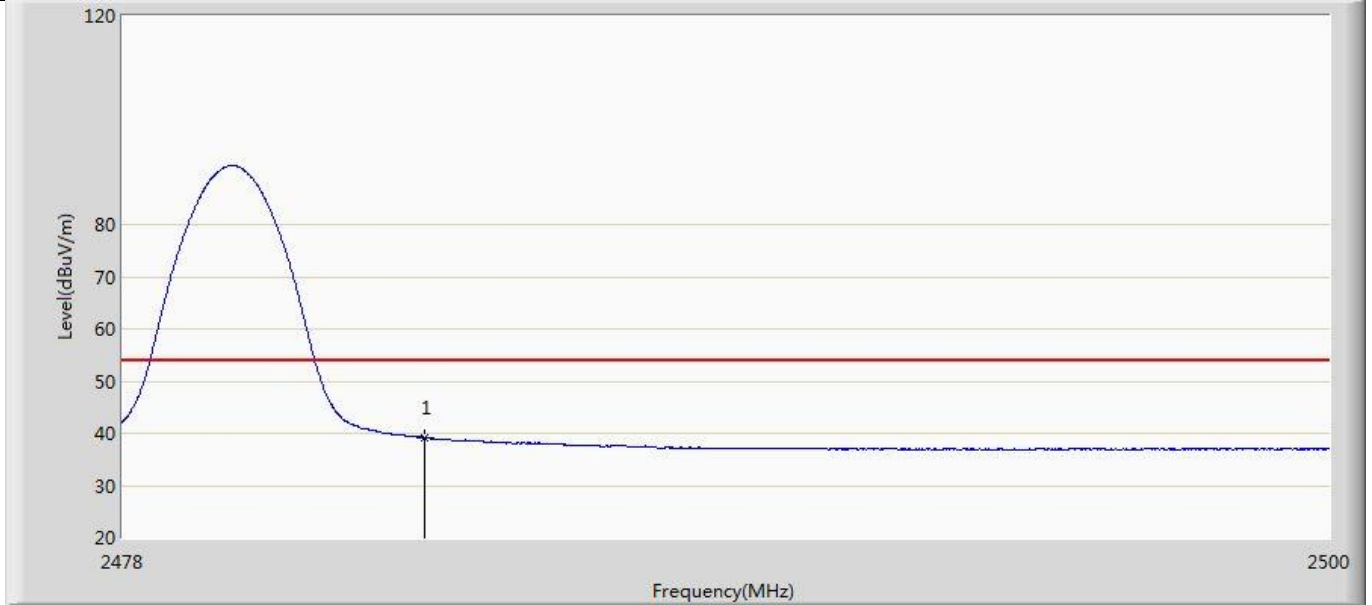

No	Mark	Frequency (MHz)	Measure Level (dBuV/m)	Reading Level (dBuV)	Over Limit (dB)	Limit (dBuV/m)	Factor (dB)	Type
1	*	2483.500	39.202	2.798	-14.798	54.000	36.404	AV

Profile: 2140092R	Page No.: 61
Engineer: Jun Xu	
Site: AC5	Time: 2021/04/20 - 22:03
Limit: FCC_Part15.209_RE(3m)	Margin: 0
Probe: Horn_3117_00167055(1-18GHz)	Polarity: Horizontal
EUT: LED Lamp	Power: AC 120V/60Hz
Note: Mode 3:Transmit at 2480MHz	

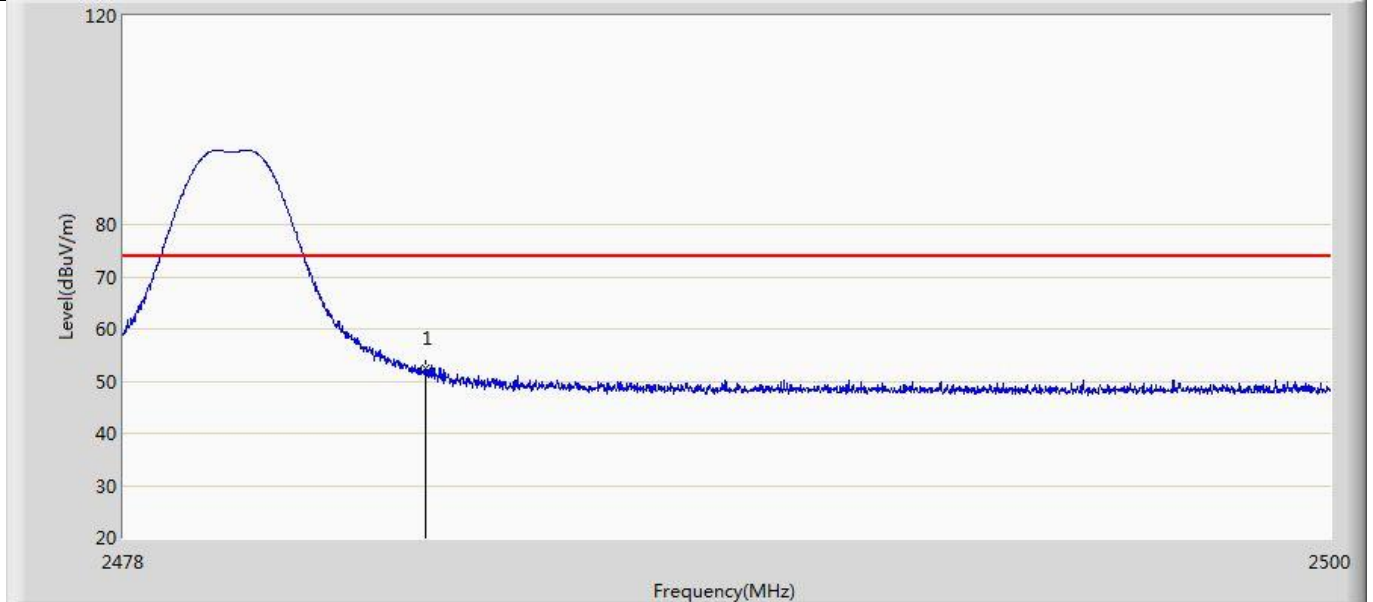

No	Mark	Frequency (MHz)	Measure Level (dBuV/m)	Reading Level (dBuV)	Over Limit (dB)	Limit (dBuV/m)	Factor (dB)	Type
1	*	2483.500	52.481	16.077	-21.519	74.000	36.404	PK

Profile: 2140092R	Page No.: 63
Engineer: Jun Xu	
Site: AC5	Time: 2021/04/20 - 22:05
Limit: FCC_Part15.209_RE(3m)	Margin: 0
Probe: Horn_3117_00167055(1-18GHz)	Polarity: Horizontal
EUT: LED Lamp	Power: AC 120V/60Hz
Note: Mode 3:Transmit at 2480MHz	

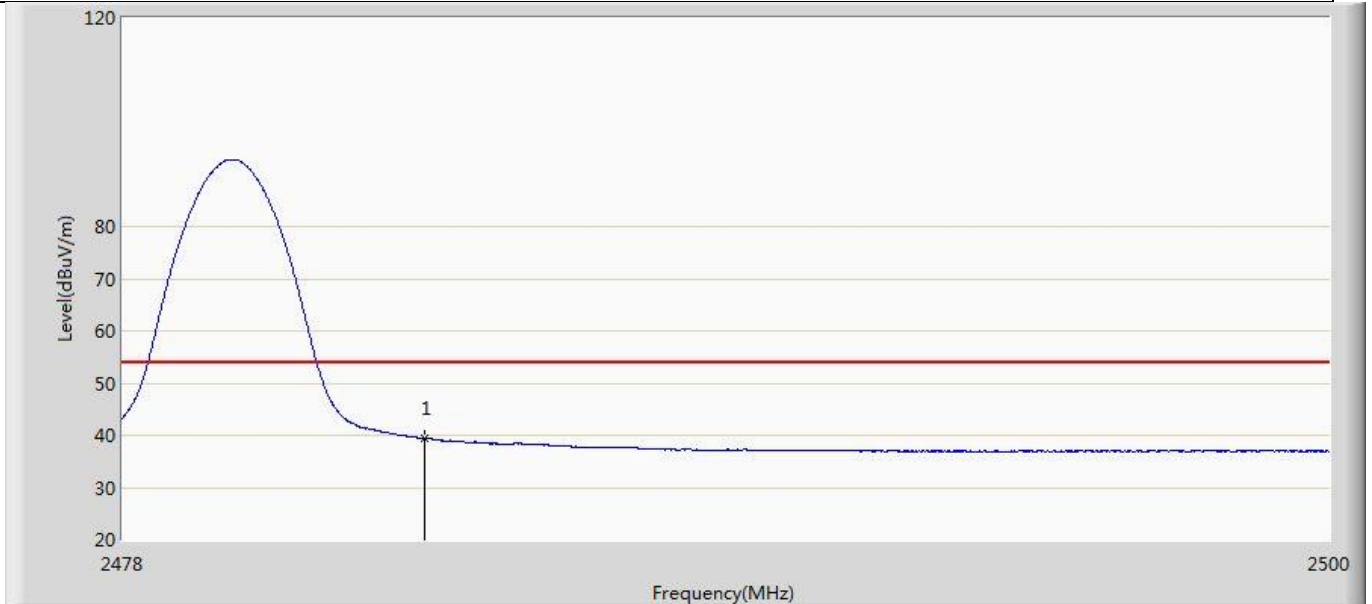

No	Mark	Frequency (MHz)	Measure Level (dBuV/m)	Reading Level (dBuV)	Over Limit (dB)	Limit (dBuV/m)	Factor (dB)	Type
1	*	2483.500	39.359	2.955	-14.641	54.000	36.404	AV

Profile: 2140092R	Page No.: 17
Engineer: Jun Xu	
Site: AC5	Time: 2021/04/20 - 20:29
Limit: FCC_Part15.209_RE(3m)	Margin: 0
Probe: Horn_3117_00167055(1-18GHz)	Polarity: Vertical
EUT: LED Lamp	Power: AC 120V/60Hz
Note: Mode 4:Transmit at 2402MHz	

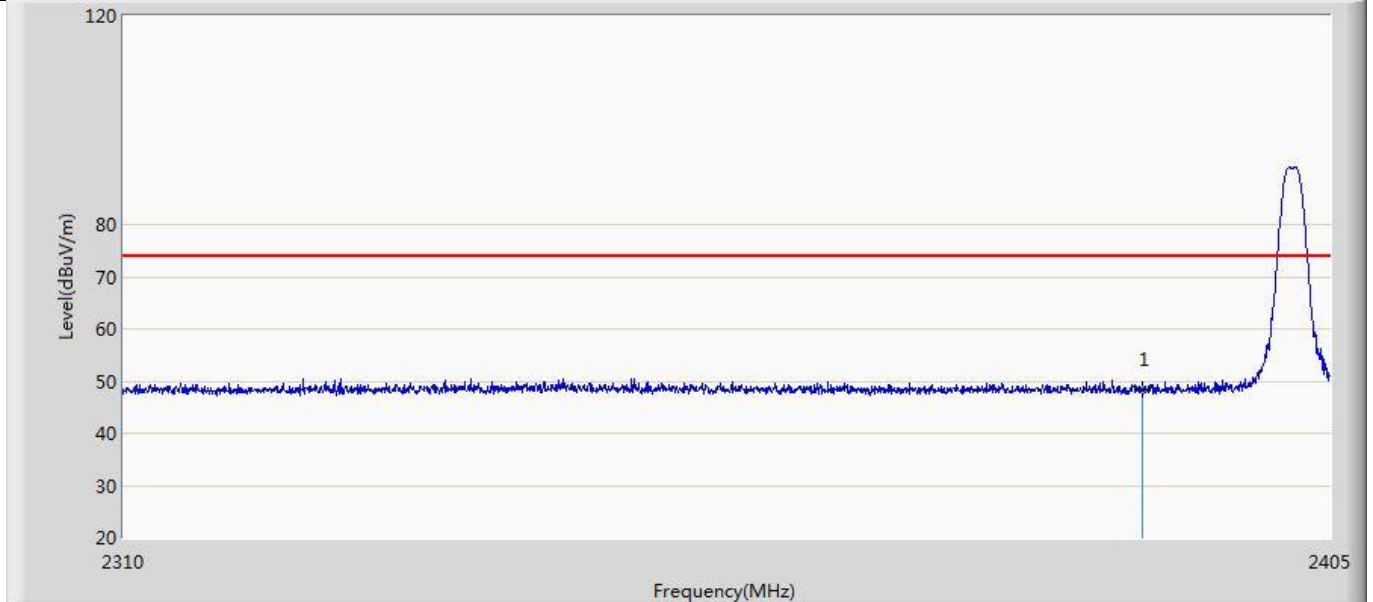

No	Mark	Frequency (MHz)	Measure Level (dBuV/m)	Reading Level (dBuV)	Over Limit (dB)	Limit (dBuV/m)	Factor (dB)	Type
1	*	2390.000	48.363	12.007	-5.637	54.000	36.357	AV

Profile: 2140092R	Page No.: 19
Engineer: Jun Xu	
Site: AC5	Time: 2021/04/20 - 21:09
Limit: FCC_Part15.209_RE(3m)	Margin: 0
Probe: Horn_3117_00167055(1-18GHz)	Polarity: Vertical
EUT: LED Lamp	Power: AC 120V/60Hz
Note: Mode 4:Transmit at 2402MHz	

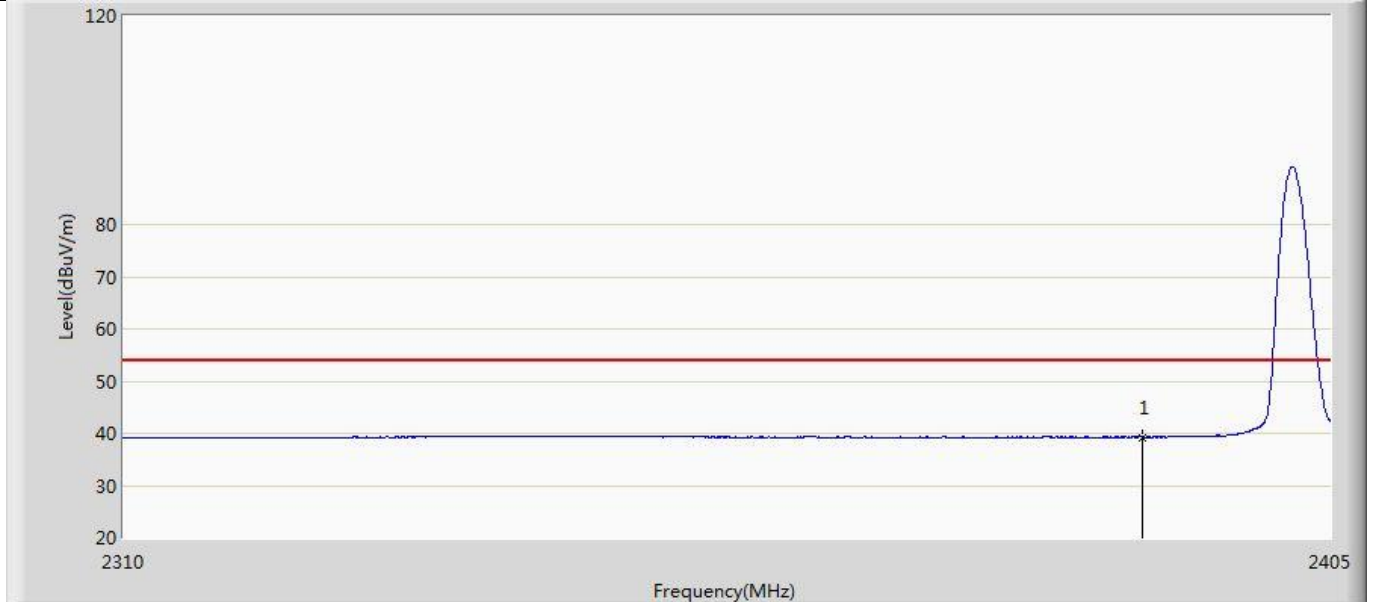

No	Mark	Frequency (MHz)	Measure Level (dBuV/m)	Reading Level (dBuV)	Over Limit (dB)	Limit (dBuV/m)	Factor (dB)	Type
1	*	2390.000	39.225	2.869	-14.775	54.000	36.357	AV

Profile: 2140092R	Page No.: 21
Engineer: Jun Xu	
Site: AC5	Time: 2021/04/20 - 21:12
Limit: FCC_Part15.209_RE(3m)	Margin: 0
Probe: Horn_3117_00167055(1-18GHz)	Polarity: Horizontal
EUT: LED Lamp	Power: AC 120V/60Hz
Note: Mode 4:Transmit at 2402MHz	

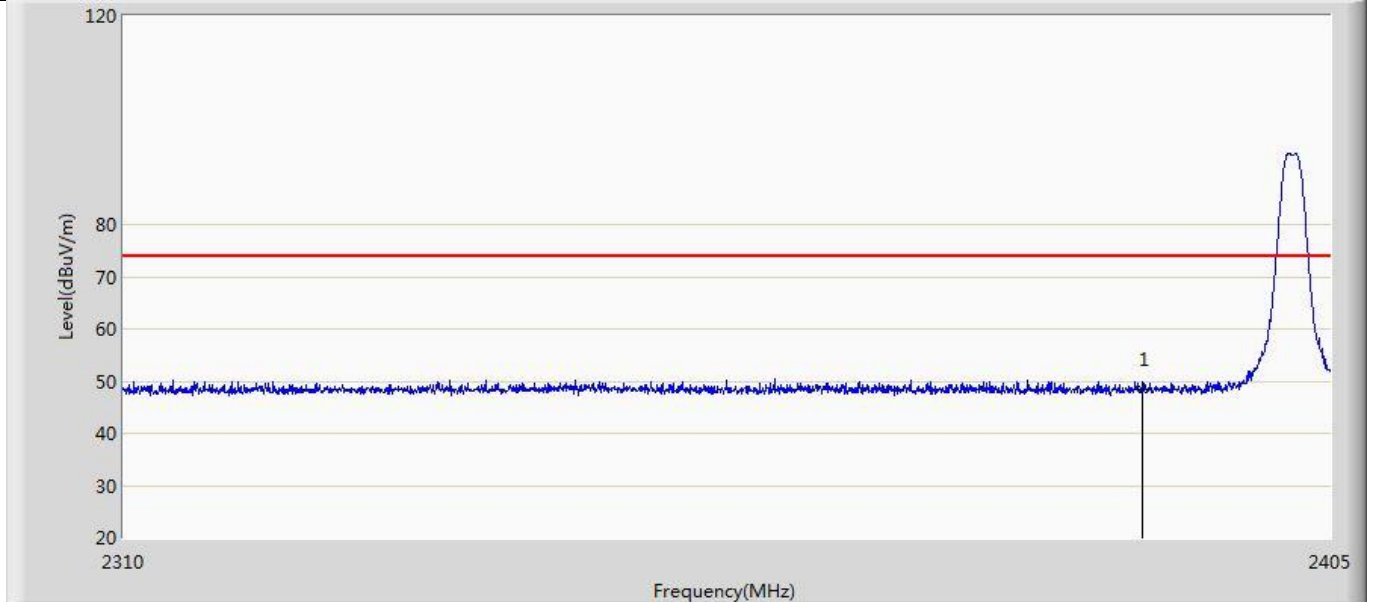

No	Mark	Frequency (MHz)	Measure Level (dBuV/m)	Reading Level (dBuV)	Over Limit (dB)	Limit (dBuV/m)	Factor (dB)	Type
1	*	2390.000	48.353	11.997	-25.647	74.000	36.357	PK

Profile: 2140092R	Page No.: 23
Engineer: Jun Xu	
Site: AC5	Time: 2021/04/20 - 21:15
Limit: FCC_Part15.209_RE(3m)	Margin: 0
Probe: Horn_3117_00167055(1-18GHz)	Polarity: Horizontal
EUT: LED Lamp	Power: AC 120V/60Hz
Note: Mode 4:Transmit at 2402MHz	

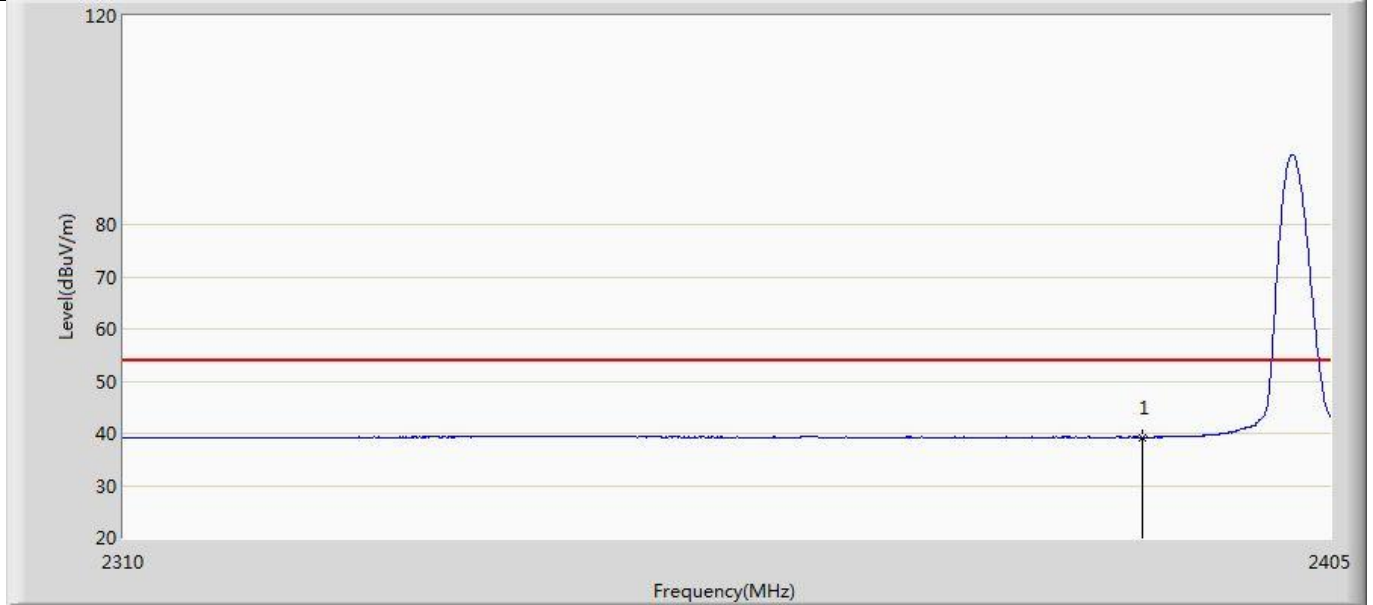

No	Mark	Frequency (MHz)	Measure Level (dBuV/m)	Reading Level (dBuV)	Over Limit (dB)	Limit (dBuV/m)	Factor (dB)	Type
1	*	2390.000	39.207	2.851	-14.793	54.000	36.357	AV

Profile: 2140092R	Page No.: 49
Engineer: Jun Xu	
Site: AC5	Time: 2021/04/20 - 21:48
Limit: FCC_Part15.209_RE(3m)	Margin: 0
Probe: Horn_3117_00167055(1-18GHz)	Polarity: Vertical
EUT: LED Lamp	Power: AC 120V/60Hz
Note: Mode 4:Transmit at 2480MHz	

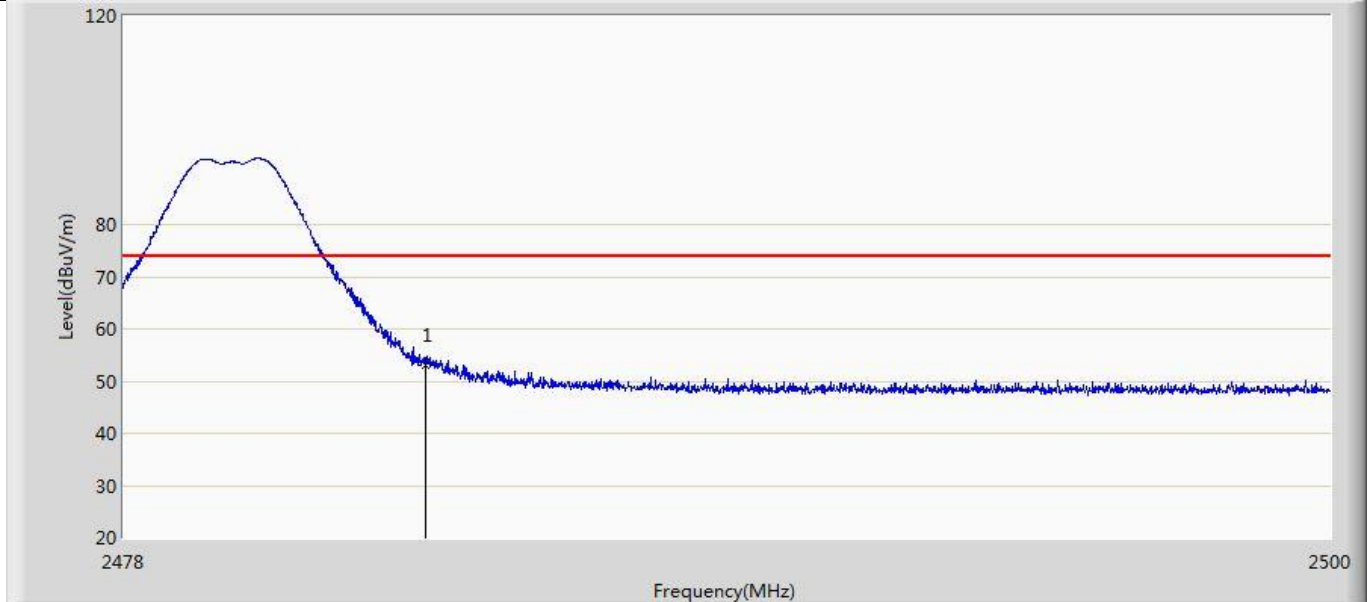

No	Mark	Frequency (MHz)	Measure Level (dBuV/m)	Reading Level (dBuV)	Over Limit (dB)	Limit (dBuV/m)	Factor (dB)	Type
1	*	2483.500	53.112	16.708	-20.888	74.000	36.404	PK

Profile: 2140092R	Page No.: 51
Engineer: Jun Xu	
Site: AC5	Time: 2021/04/20 - 21:51
Limit: FCC_Part15.209_RE(3m)	Margin: 0
Probe: Horn_3117_00167055(1-18GHz)	Polarity: Vertical
EUT: LED Lamp	Power: AC 120V/60Hz
Note: Mode 4:Transmit at 2480MHz	

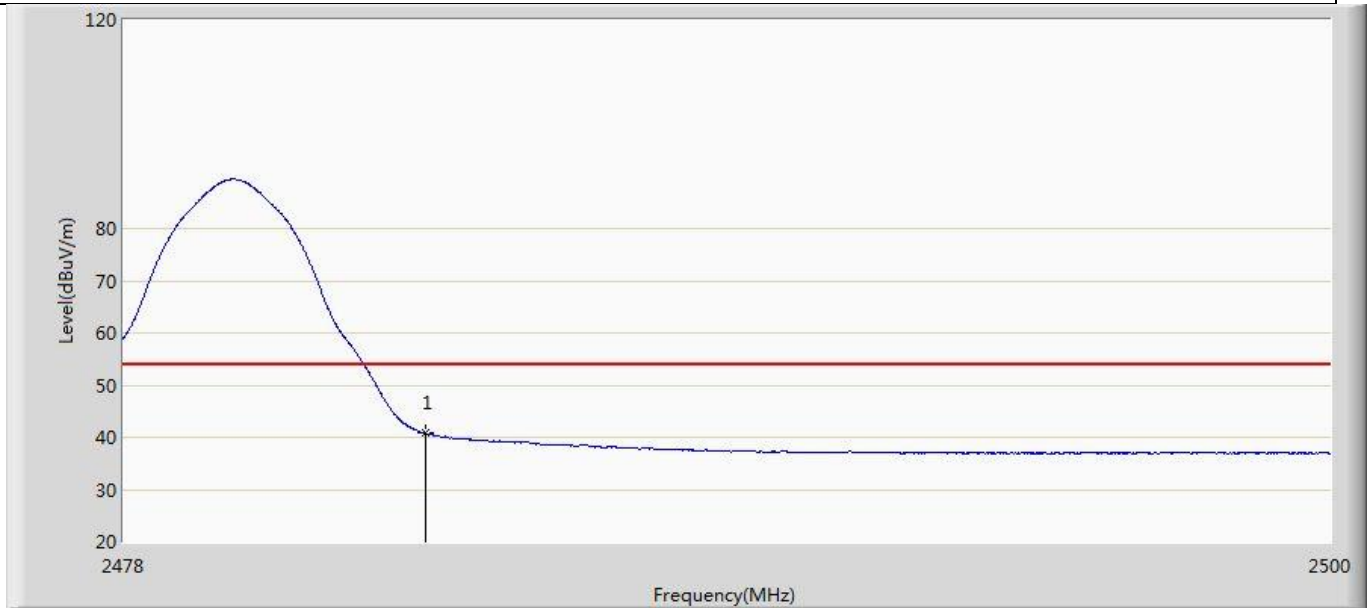

No	Mark	Frequency (MHz)	Measure Level (dBuV/m)	Reading Level (dBuV)	Over Limit (dB)	Limit (dBuV/m)	Factor (dB)	Type
1	*	2483.500	40.751	4.347	-13.249	54.000	36.404	AV

Profile: 2140092R	Page No.: 53
Engineer: Jun Xu	
Site: AC5	Time: 2021/04/20 - 21:54
Limit: FCC_Part15.209_RE(3m)	Margin: 0
Probe: Horn_3117_00167055(1-18GHz)	Polarity: Horizontal
EUT: LED Lamp	Power: AC 120V/60Hz
Note: Mode 4:Transmit at 2480MHz	

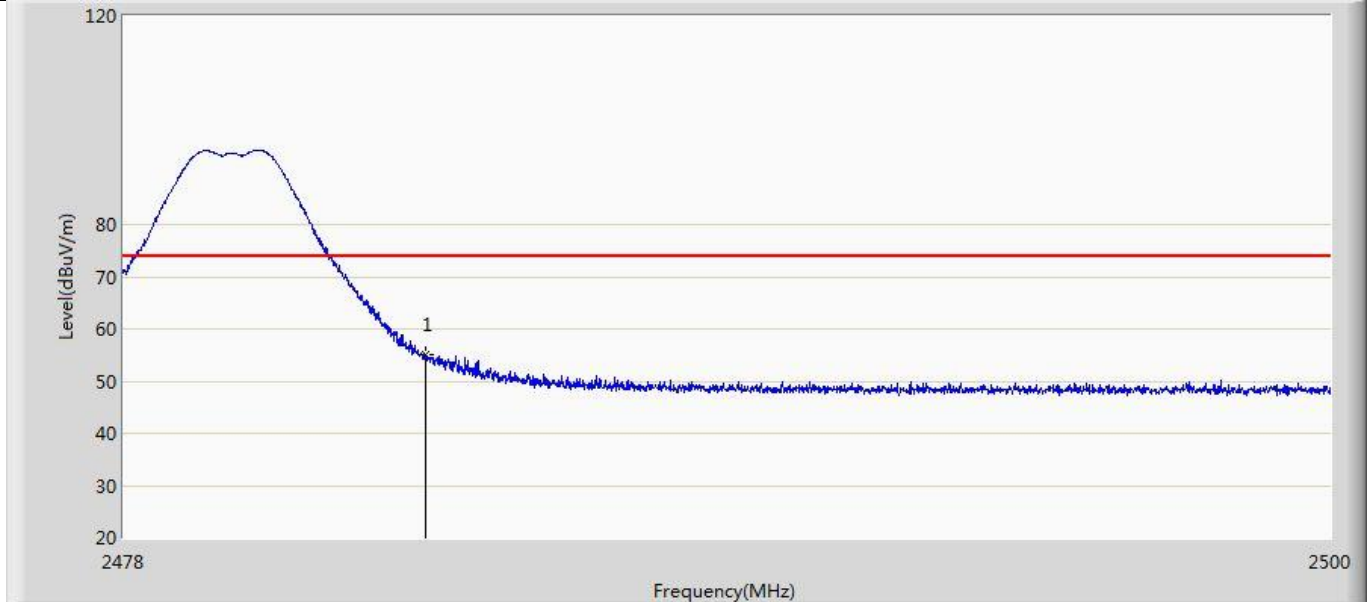

No	Mark	Frequency (MHz)	Measure Level (dBuV/m)	Reading Level (dBuV)	Over Limit (dB)	Limit (dBuV/m)	Factor (dB)	Type
1	*	2483.500	54.937	18.533	-19.063	74.000	36.404	PK

Profile: 2140092R	Page No.: 55
Engineer: Jun Xu	
Site: AC5	Time: 2021/04/20 - 21:56
Limit: FCC_Part15.209_RE(3m)	Margin: 0
Probe: Horn_3117_00167055(1-18GHz)	Polarity: Horizontal
EUT: LED Lamp	Power: AC 120V/60Hz
Note: Mode 4:Transmit at 2480MHz	

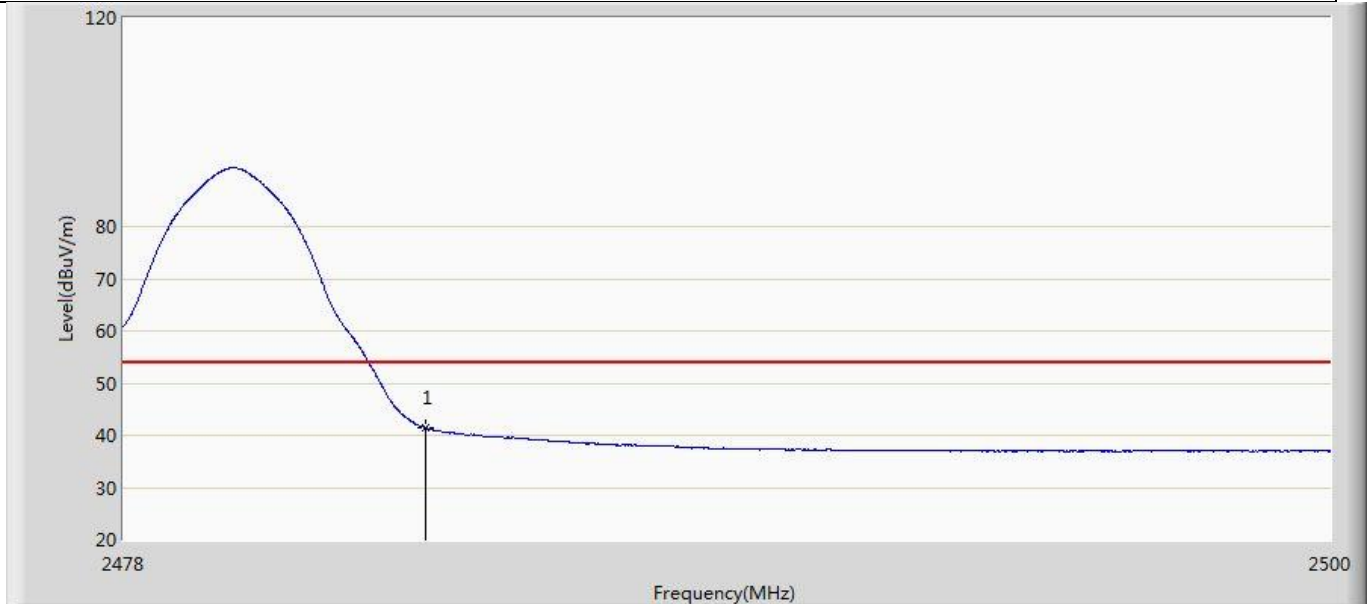

No	Mark	Frequency (MHz)	Measure Level (dBuV/m)	Reading Level (dBuV)	Over Limit (dB)	Limit (dBuV/m)	Factor (dB)	Type
1	*	2483.500	41.429	5.025	-12.571	54.000	36.404	AV

4.6 DTS Bandwidth	VERDICT: PASS
--------------------------	----------------------

4.6.1 Limit

Standard	FCC Part 15 Subpart C Paragraph 15.247 (a)(2)
Systems using digital modulation techniques operate in the 2400-2483.5 MHz. The minimum 6 dB bandwidth shall be at least 500 kHz	

4.6.2 Test Setup

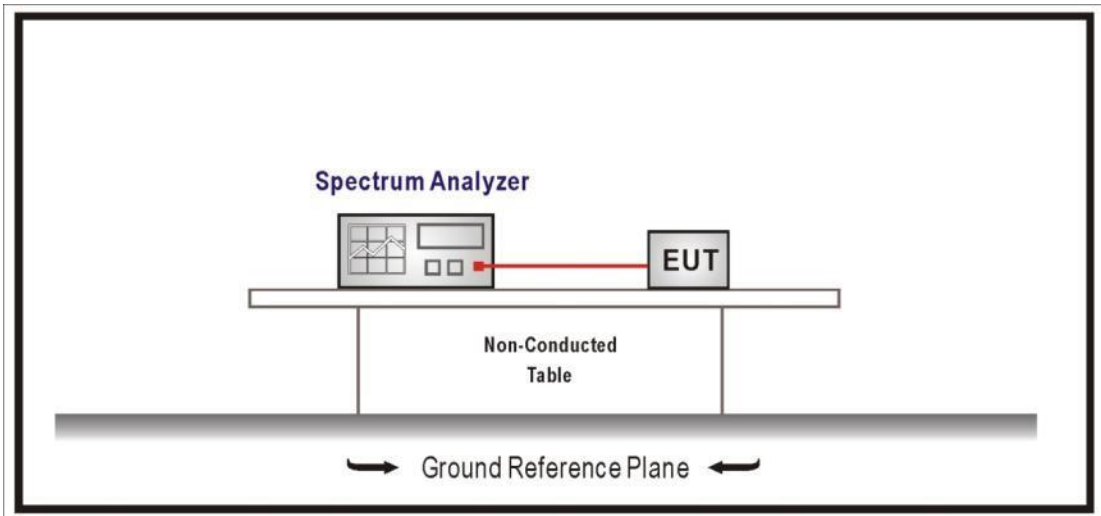

4.6.3 Test Procedure

	Reference Rule	Chapter	Description
<input checked="" type="checkbox"/>	ANSI C63.10	11.8	DTS bandwidth
<input type="checkbox"/>	ANSI C63.10	11.8.1	Option 1
<input checked="" type="checkbox"/>	ANSI C63.10	11.8.2	Option 2

4.6.4 Test Data

Mode	CH.	Test Freq. (MHz)	99% Occupied Bandwidth (kHz)	6dB Occupied Bandwidth (kHz)	Limit (kHz)	Result
1	00	2402	1045.9	705.5	>500	Pass
	19	2440	1043.8	692.5	>500	Pass
	39	2480	1041.2	682	>500	Pass
2	00	2402	2133.8	1350	>500	Pass
	19	2440	2133.8	1347	>500	Pass
	39	2480	2138.8	1353	>500	Pass
3	00	2402	1092.6	785.1	>500	Pass
	19	2440	1092.5	773.9	>500	Pass
	39	2480	1093.4	781.5	>500	Pass
4	00	2402	1125.5	752	>500	Pass
	19	2440	1123.4	746.6	>500	Pass
	39	2480	1124.2	751.3	>500	Pass

Note : The worst case of Occupied Bandwidth as below:

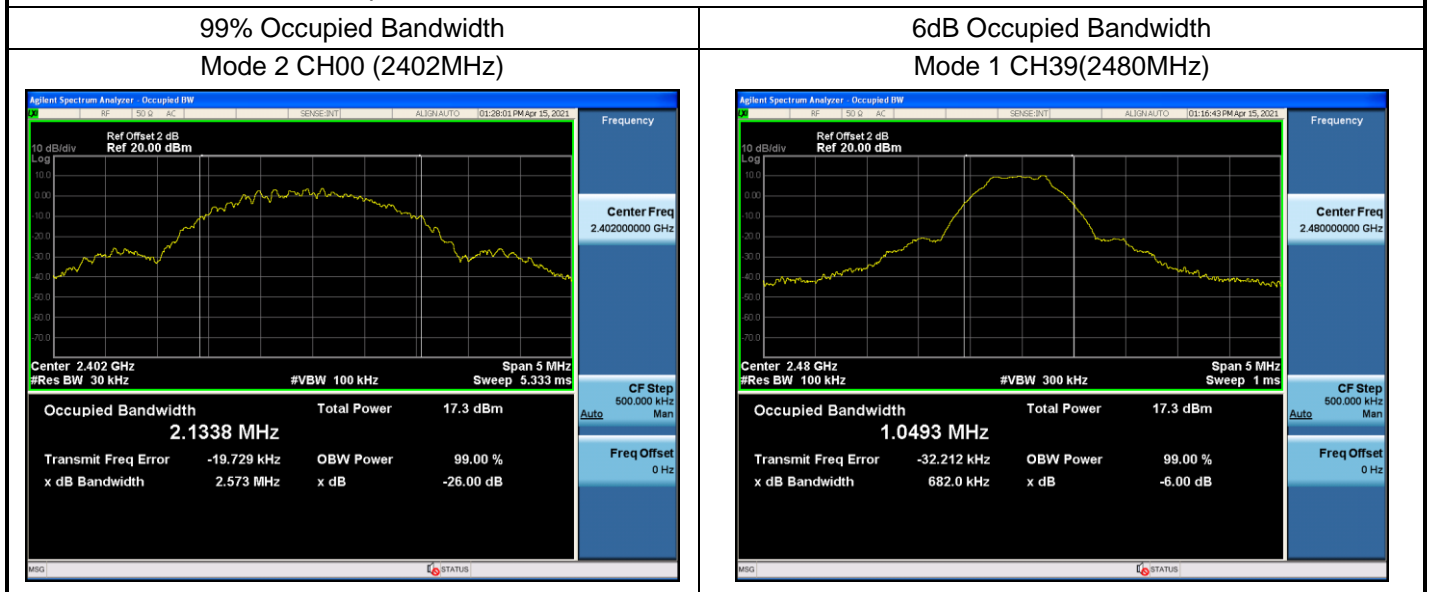

4.7 Fundamental emission output power	VERDICT: PASS
--	----------------------

4.7.1 Limit			
Standard	FCC Part 15 Subpart C Paragraph 15.247 (b)(3)		
<input checked="" type="checkbox"/>	GTX < 6dBi	Pout ≤ 30dBm	
<input type="checkbox"/>	GTX > 6dBi		
<input type="checkbox"/>	Non-Fix point-point	Pout ≤ 30-(GTX -6)	
<input type="checkbox"/>	Fix point-point	Pout ≤ 30-[(GTX-6)]/3	
<input type="checkbox"/>	Point-to-multipoint	Pout ≤ 30-(GTX-6)	
<input type="checkbox"/>	Overlap Beams	Pout ≤ 30-[(GTX-6)]/3	
<input type="checkbox"/>	Aggregate power transmitted simultaneously on all beams	Pout ≤ 30-[(GTX-6)]/3	
<input type="checkbox"/>	single directional beam	Pout ≤ 30-[(GTX-6)]/3+8dB	
Note 1 : GTX directional gain of transmitting antennas. Note 2 : Pout is maximum peak conducted output power .			

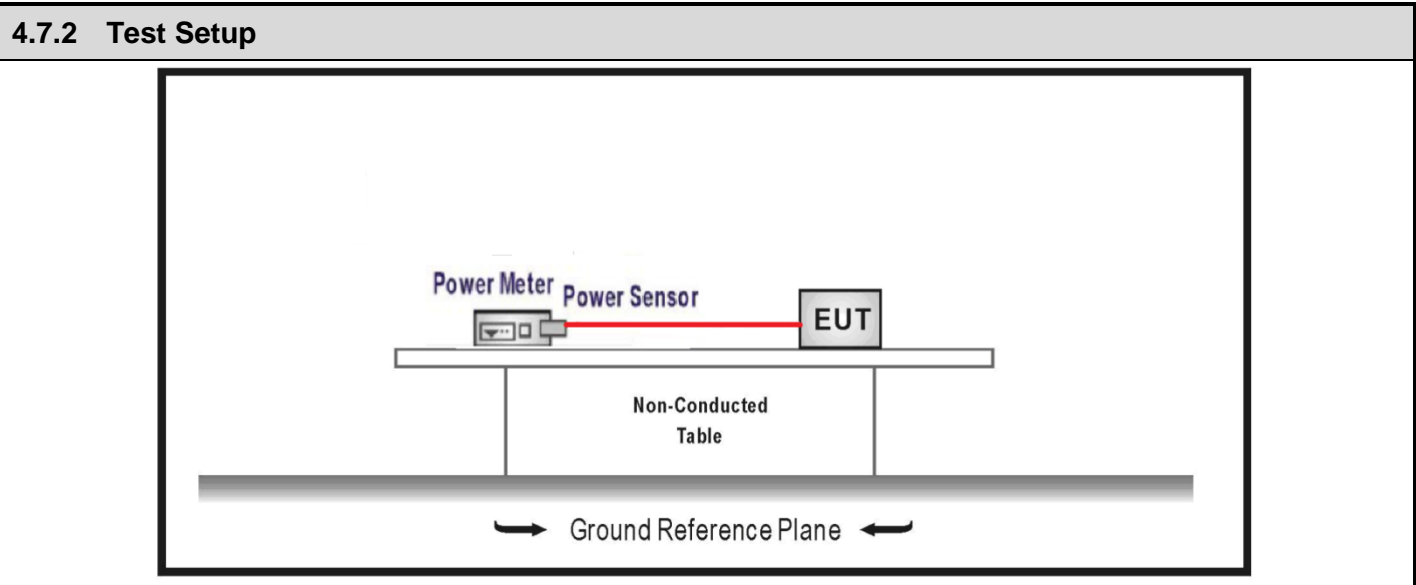

4.7.3 Test Procedure						
	References Rule		Chapter	Description		
<input checked="" type="checkbox"/>	ANSI C63.10		11.9	Fundamental emission output power		
<input type="checkbox"/>	<input checked="" type="checkbox"/>	ANSI C63.10		11.9.1	Maximum peak conducted output power	
	<input type="checkbox"/>	<input type="checkbox"/>	ANSI C63.10	11.9.1.1	RBW \geq DTS bandwidth	
		<input type="checkbox"/>	ANSI C63.10	11.9.1.2	Integrated band power method	
		<input checked="" type="checkbox"/>	ANSI C63.10	11.9.1.3	PKPM1 Peak power meter method	
	<input type="checkbox"/>	ANSI C63.10		11.9.2	Maximum conducted (average) output power	
	<input type="checkbox"/>	<input type="checkbox"/>	ANSI C63.10		11.9.2.2	Measurement using a spectrum analyzer (SA)
		<input type="checkbox"/>	<input type="checkbox"/>	ANSI C63.10	11.9.2.2.2	Method AVGSA-1(Duty cycle \geq 98%)
			<input type="checkbox"/>	ANSI C63.10	11.9.2.2.3	Method AVGSA-1A(Duty cycle \geq 98%)
			<input type="checkbox"/>	ANSI C63.10	11.9.2.2.4	Method AVGSA-2(Duty cycle \leq 98%)
			<input type="checkbox"/>	ANSI C63.10	11.9.2.2.5	Method AVGSA-2A(Duty cycle \leq 98%)
			<input type="checkbox"/>	ANSI C63.10	11.9.2.2.4	Method AVGSA-3
			<input type="checkbox"/>	ANSI C63.10	11.9.2.2.5	Method AVGSA-3A
		<input type="checkbox"/>	ANSI C63.10		11.9.2.3	Measurement using a power meter (PM)
	<input type="checkbox"/>	<input type="checkbox"/>	ANSI C63.10	11.9.2.3.1	Method AVGPM	
<input type="checkbox"/>		ANSI C63.10	11.9.2.3.2	Method AVGPM-G		

4.7.4 Test Data

Mode	Channel	Test Frequency (MHz)	Conducted Power (dBm)	EIRP (dBm)	Conducted Power Limit (dBm)	EIRP Limit (dBm)	Result
Mode 1	00	2402	11.34	10.34	≤30	≤36	Pass
	19	2440	11.01	10.01	≤30	≤36	Pass
	39	2480	11.09	10.09	≤30	≤36	Pass
Mode 2	00	2402	11.41	10.41	≤30	≤36	Pass
	19	2440	11.24	10.24	≤30	≤36	Pass
	39	2480	11.34	10.34	≤30	≤36	Pass
Mode 3	00	2402	11.18	10.18	≤30	≤36	Pass
	19	2440	11.29	10.29	≤30	≤36	Pass
	39	2480	11.36	10.36	≤30	≤36	Pass
Mode 4	00	2402	11.19	10.19	≤30	≤36	Pass
	19	2440	11.28	10.28	≤30	≤36	Pass
	39	2480	11.37	10.37	≤30	≤36	Pass

4.8 Power Density	VERDICT: PASS
--------------------------	----------------------

4.8.1 Limit:	
Standard	FCC Part 15 Subpart C Paragraph 15.247 (b)(3)
Power Spectral Density $\leq 8\text{dBm}/3\text{kHz}$	

4.8.2 Test Setup

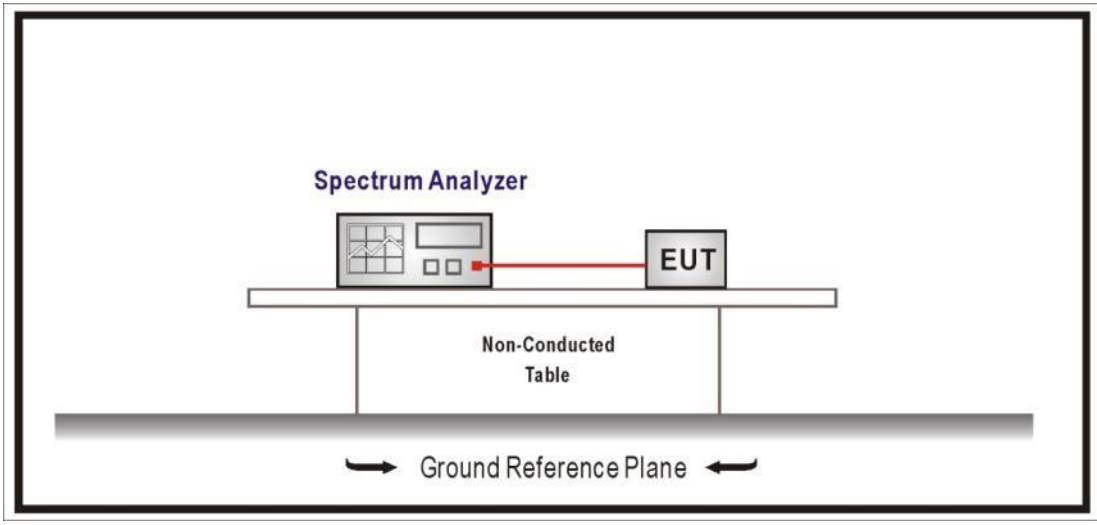

4.8.3 Test Procedure

	References Rule	Chapter	Description
<input checked="" type="checkbox"/>	ANSI C63.10	11.10	Maximum power spectral density level in the fundamental emission
<input checked="" type="checkbox"/>	ANSI C63.10	11.10.2	Method PKPSD (peak PSD)
<input type="checkbox"/>	ANSI C63.10	11.10.3	Method AVGPSD-1(Duty cycle $\geq 98\%$)
<input type="checkbox"/>	ANSI C63.10	11.10.4	Method AVGPSD-1A(Duty cycle $\geq 98\%$)
<input type="checkbox"/>	ANSI C63.10	11.10.5	Method AVGPSD-2(Duty cycle $< 98\%$)
<input type="checkbox"/>	ANSI C63.10	11.10.6	Method AVGPSD-2A(Duty cycle $< 98\%$)
<input type="checkbox"/>	ANSI C63.10	11.10.7	Method AVGPSD-3
<input type="checkbox"/>	ANSI C63.10	11.10.8	Method AVGPSD-3A

4.8.4 Test Data

Mode	Channel	Test Frequency (MHz)	Measurement PSD (dBm/3kHz)	Limit (dBm/3kHz)	Result
Mode 1	00	2402	-1.518	≤8	Pass
	19	2440	-2.064	≤8	Pass
	39	2480	-1.749	≤8	Pass
Mode 2	00	2402	-4.059	≤8	Pass
	19	2440	-4.238	≤8	Pass
	39	2480	-4.045	≤8	Pass
Mode 3	00	2402	-1.850	≤8	Pass
	19	2440	-1.777	≤8	Pass
	39	2480	-1.584	≤8	Pass
Mode 4	00	2402	-1.856	≤8	Pass
	19	2440	-2.214	≤8	Pass
	39	2480	-1.842	≤8	Pass

Note : The worst case of PSD as below:

Mode 1 CH00(2402MHz)

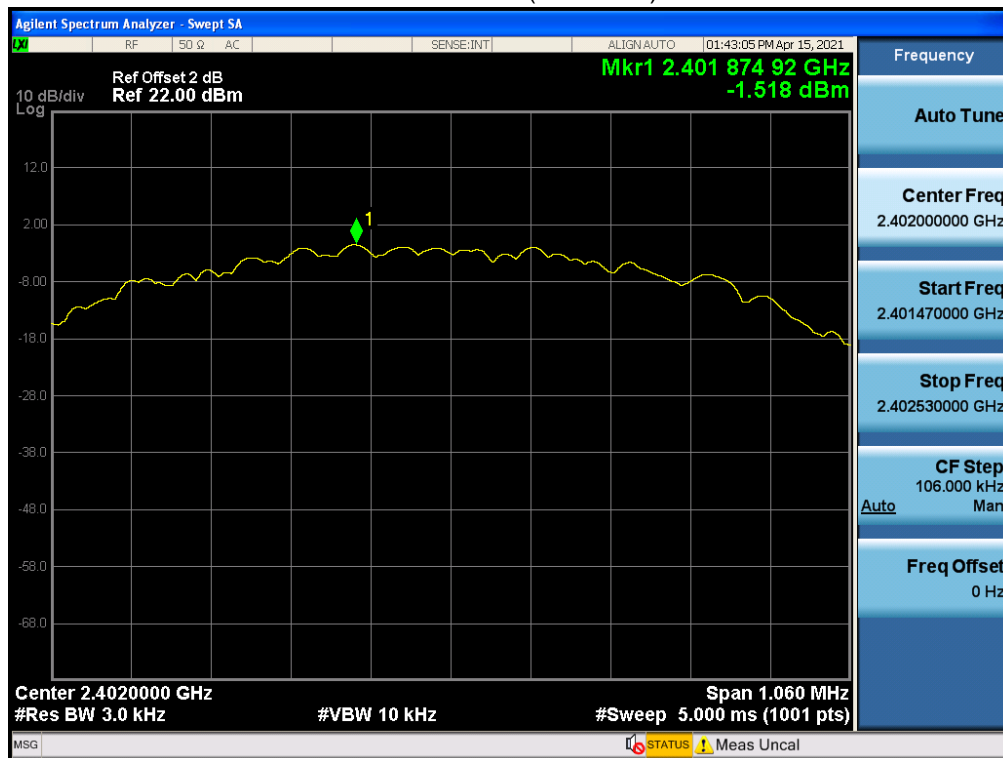

4.9 Antenna Requirement	VERDICT: PASS
--------------------------------	----------------------

4.9.1 Limit:	
Standard	FCC Part 15 Subpart C Paragraph 15.203
<p>An intentional radiator shall be designed to ensure that no antenna other than that furnished by the responsible party shall be used with the device. The use of a permanently attached antenna or of an antenna that uses a unique coupling to the intentional radiator shall be considered sufficient to comply with the provisions of this section. The manufacturer may design the unit so that a broken antenna can be replaced by the user, but the use of a standard antenna jack or electrical connector is prohibited. This requirement does not apply to carrier current devices or to devices operated under the provisions of §15.211, §15.213, §15.217, §15.219, or §15.221. Further, this requirement does not apply to intentional radiators that must be professionally installed, such as perimeter protection systems and some field disturbance sensors, or to other intentional radiators which, in accordance with §15.31(d), must be measured at the installation site. However, the installer shall be responsible for ensuring that the proper antenna is employed so that the limits in this part are not exceeded.</p>	

4.9.2 Antenna Connector Construction:	
<input checked="" type="checkbox"/>	The use of a permanently attached antenna
<input type="checkbox"/>	The antenna use of a unique coupling to the intentional radiator
<input type="checkbox"/>	The use of a nonstandard antenna jack or electrical connector
Please refer to the attached document "Internal Photograph" to show the antenna connector.	

5 TEST SETUP PHOTO AND EUT PHOTO

Remark: The test setup photo and EUT Photo please see appendix.

_____ The End _____