



Test report No:  
20B0023R-RF-US-P06V02

## FCC & ISED TEST REPORT

Product Name	Digital Device
Trademark	PHILIPS
Model and /or type reference	9290024695
FCC ID	2AGBW9290024695X
IC	20812-24695X
Applicant's name / address	Signify (China) Investment Co., Ltd Building 9, Lane 888, Tian Lin Road, Min Hang District, Shanghai, P. R. C
Test method requested, standard	FCC CFR Title 47 Part 15 Subpart C Section 15.247 ANSI C63.10: 2013 KD558074 D01 15.247 Meas Guidance v05r02 RSS-Gen Issue 5 RSS-247 Issue 2
Verdict Summary	IN COMPLIANCE
Documented by (name / position & signature)	Kitty Li/Project Assistant <i>Kitty Li</i>
Reviewed by (name / position & signature)	Frank He/ Technical Supervisor <i>Frank He</i>
Approved by (name / position & signature)	Jack Zhang/ Supervisor <i>Jack Zhang</i>
Date of issue	2021-02-05
Report template No	Template_FCC 15.247-RF-V1.0

## INDEX

	page
General conditions .....	4
Environmental conditions .....	4
Possible test case verdicts .....	5
Abbreviations.....	5
Document History.....	6
Remarks and Comments .....	6
Used Equipment.....	7
Uncertainty .....	9
1 General Information .....	10
1.1 General Description of the Item(s).....	10
1.2 Antenna Information .....	11
1.3 Channel List.....	12
2 Description of Test Setup.....	13
2.1 Operating mode(s) used for tests .....	13
2.2 Auxiliary equipment / Test software for the EUT .....	13
2.3 Test Configuration / Block diagram used for tests.....	14
2.4 Testing process .....	15
3 Verdict summary section.....	16
3.1 Standards .....	16
3.2 Deviation(s) from the Standard(s) / Test Specification(s).....	16
3.3 Overview of results .....	17
3.4 Test Facility.....	18
4 Test Results .....	19
4.1 AC Power Line Conducted Emission.....	19
4.1.1 Limit .....	19
4.1.2 Test Setup .....	19
4.1.3 Test Procedure .....	19
4.1.4 Test Data .....	20
4.2 Emissions in restricted frequency bands .....	22
4.2.1 Limit .....	22
4.2.2 Test Setup .....	24
4.2.3 Test Procedure .....	24
4.2.4 Test Data .....	25
4.3 Emissions in non-restricted frequency band .....	51

---

4.3.1	Limit .....	51
4.3.2	Test Setup .....	51
4.3.3	Test Procedure .....	51
4.3.4	Test Data .....	52
4.4	Duty cycle .....	56
4.4.1	Limit .....	56
4.4.2	Test Setup .....	56
4.4.3	Test Procedure .....	56
4.4.4	Test Data .....	57
4.5	Radiated Emission Band Edge .....	58
4.5.1	Limit .....	58
4.5.2	Test Setup .....	58
4.5.3	Test Procedure .....	58
4.5.4	Test Data .....	59
4.6	DTS Bandwidth .....	91
4.6.1	Limit .....	91
4.6.2	Test Setup .....	91
4.6.3	Test Procedure .....	91
4.6.4	Test Data .....	92
4.7	Fundamental emission output power .....	93
4.7.1	Limit .....	93
4.7.2	Test Setup .....	93
4.7.3	Test Procedure .....	94
4.7.4	Test Data .....	95
4.8	Power Density .....	96
4.8.1	Limit .....	96
4.8.2	Test Setup .....	96
4.8.3	Test Procedure .....	96
4.8.4	Test Data .....	97
4.9	Antenna Requirement .....	98
4.9.1	Limit: .....	98
4.9.2	Antenna Connector Construction: .....	98
5	Test setup photo and EUT Photo .....	99

## COMPETENCES AND GUARANTEES

DEKRA is a testing laboratory competent to carry out the tests described in this report.

In order to assure the traceability to other national and international laboratories, DEKRA has a calibration and maintenance program for its measurement equipment.

DEKRA guarantees the reliability of the data presented in this report, which is the result of the measurements and the tests performed to the item under test on the date and under the conditions stated in the report and it is based on the knowledge and technical facilities available at DEKRA at the time of performance of the test.

DEKRA is liable to the client for the maintenance of the confidentiality of all information related to the item under test and the results of the test.

The results presented in this Test Report apply only to the particular item under test established in this document.

**IMPORTANT:** No parts of this report may be reproduced or quoted out of context, in any form or by any means, except in full, without the previous written permission of DEKRA.

## GENERAL CONDITIONS

Test Location	No. 99, Hongye Road, Suzhou Industrial Park Suzhou, 215006, P.R. China
Date(receive sample)	Nov. 02, 2020
Date (start test)	Nov. 03, 2020
Date (finish test)	Feb. 03, 2021

1. This report is only referred to the item that has undergone the test.
2. This report does not constitute or imply on its own an approval of the product by the Certification Bodies or Competent Authorities.
3. This document is only valid if complete; no partial reproduction can be made without previous written permission of DEKRA.
4. This test report cannot be used partially or in full for publicity and/or promotional purposes without previous written permission of DEKRA.

## ENVIRONMENTAL CONDITIONS

The climatic conditions during the tests are within the limits specified by the manufacturer for the operation of the EUT and the test equipment. The climatic conditions during the tests were within the following limits:

Ambient temperature	15 °C – 35 °C
Relative Humidity air	30% - 60%

If explicitly required in the basic standard or applied product / product family standard the climatic values are recorded and documented separately in this test report.

## POSSIBLE TEST CASE VERDICTS

Test case does not apply to test object	N/A
Test object does meet requirement	P (Pass) / PASS
Test object does not meet requirement	F (Fail) / FAIL
Not measured	N/M

## ABBREVIATIONS

For the purposes of the present document, the following abbreviations apply:

EUT	: Equipment Under Test
QP	: Quasi-Peak
CAV	: CISPR Average
AV	: Average
CDN	: Coupling Decoupling Network
SAC	: Semi-Anechoic Chamber
OATS	: Open Area Test Site
BW	: Bandwidth
AM	: Amplitude Modulation
PM	: Pulse Modulation
HCP	: Horizontal Coupling Plane
VCP	: Vertical Coupling Plane
$U_N$	: Nominal voltage
$T_x$	: Transmitter
$R_x$	: Receiver
N/A	: Not Applicable
N/M	: Not Measured

## DOCUMENT HISTORY

Report No.	Version	Description	Issued Date
20B0023R-RF-US-P06V02	V1.0	Initial issue of report.	2020-12-03
20B0023R-RF-US-P06V02	V1.1	P20-21, added the test data of AC Power Line Conducted Emission. P52-P55, modified the test data of Emissions in non-restricted frequency band.	2021-02-03
20B0023R-RF-US-P06V02	V1.2	P13, modified the information of Auxiliary equipment / Test software for the EUT.	2021-02-05

## REMARKS AND COMMENTS

- The equipment under test (EUT) does meet the essential requirements of the stated standard(s)/test(s).
- These test results on a sample of the device are for the purpose of demonstrating Compliance with Part 15 Subpart C Paragraph 15.247, RSS-Gen Issue 5, RSS-247 Issue 2.
- The measurement result is considered in conformance with the requirement if it is within the prescribed limit, It is not necessary to account the uncertainty associated with the measurement result.
- The test results presented in this report relate only to the object tested.
- The test report shall not be reproduced without the written approval of DEKRA Testing and Certification (Suzhou) Co., Ltd.
- This report will not be used for social proof function in China market.
- DEKRA declines any responsibility with the following test data provided by customer that may affect the validity of result:
  - Chapter 1.1 General Description of the Item(s);
  - Chapter 1.2 Antenna Information;
  - Chapter 1.3 Channel List.

## USED EQUIPMENT

### AC Power Line Conducted Emission / TR1

Instrument	Manufacturer	Model No.	Serial No.	Cal. Date	Next Cal. Date
EMI Test Receiver	R&S	ESCI	100906	2020.04.18	2021.04.17
Two-Line V-Network	R&S	ENV216	101190	2021.01.27	2022.01.26
Two-Line V-Network	R&S	ENV216	101044	2020.04.18	2021.04.17
50ohm Termination	SHX	TF2	7081402	2020.09.23	2021.09.22
50ohm Termination	SHX	TF2	7081403	2020.09.23	2021.09.22
50ohm Coaxial Switch	Anritsu	MP59B	6200464462	N/A	N/A
Temperature/Humidity Meter	RTS	RTS-8S	TR1-TH	2020.08.23	2021.08.22
Dekra test software	Dekra	-	-	-	-

### Emissions in non-restricted frequency bands/ Occupied Bandwidth/ Fundamental emission output power/ Power Spectral Density / TR8

Instrument	Manufacturer	Model No.	Serial No.	Cal. Date	Next Cal. Date
Spectrum Analyzer	Agilent	N9010A	MY48030494	2020.08.15	2021.08.14
EXA Spectrum Analyzer	Keysight	N9010A	MY55370495	2020.04.17	2021.04.16
MXA Signal Analyzer	Keysight	N9020A	MY56060147	2020.08.15	2021.08.14
4TX MIMO Power Sensor	Keysight	X8750A	MY59400102	2020.02.11	2021.02.10
Coaxial Cable	Woken	SFL402	F02-150410-044	2021.01.01	2021.12.31
Temperature/Humidity Meter	RTS	RTS-8S	RF08	2020.08.13	2021.08.12

### Radiated Emission(30MHz-1GHz) / AC2

Instrument	Manufacturer	Model No.	Serial No.	Cal. Date	Next Cal. Date
EMI Test Receiver	R&S	ESCI	100573	2020.12.06	2021.12.05
Bilog Antenna	Teseq GmbH	CBL6112D	27611	2020.09.22	2021.09.21
Coaxial Cable	Huber+Suhner	RG 214	AC2-C	2020.04.05	2021.04.04
Temperature/Humidity Meter	RTS	RTS-8S	AC2-TH	2020.08.13	2021.08.12
Dekra test software	Dekra	-	-	-	-

## Radiated Emission(1GHz-40GHz) / AC5

Instrument	Manufacturer	Model No.	Serial No.	Cal. Date	Next Cal. Date
EXA Spectrum Analyzer	Keysight	N9010A	MY55370495	2020.04.17	2021.04.16
Amplifier	Keleto	LNPA	SK20190225	2020.09.25	2021.09.24
Preamplifier	EMCI	EMC184045SE	980263	2020.05.24	2021.05.23
DRG Horn Antenna	ETS-Lindgren	3117	00167055	2020.08.06	2021.08.05
Broad-Band Horn Antenna	Schwarzbeck	BBHA9170	294	2019.03.23	2021.03.22
Coaxial Cable	Huber+Suhner	SUCOFLEX 106	AC5-C2	2020.04.05	2021.04.04
Coaxial Cable	ROSENBERGER	LA1-C011- 2000/3000	AC5-40G	2020.04.18	2021.04.17
Temperature/Humidity Meter	RTS	RTS-8S	AC5-TH	2020.08.13	2021.08.12
Dekra test software	Dekra	-	-	-	-



## UNCERTAINTY

Uncertainties have been calculated according to the DEKRA internal document. The reported expanded uncertainties are based on a standard uncertainty multiplied by a coverage factor of  $k=2$ , providing a level of confidence of approximately 95%. The Uncertainties comply with standard required as below.

Test item	Uncertainty
AC Power Line Conducted Emission	9kHz~150kHz: 2.80 dB 150kHz~30MHz: 2.40 dB
Peak Power Output	$\pm 1.27$ dB
Radiated Emission(30MHz~1GHz)	Horizontal: 30MHz~200MHz: 3.50 dB 300MHz~1GHz: 3.60 dB Vertical: 30MHz~200MHz: 3.60 dB 300MHz~1GHz: 3.50 dB
Radiated Emission(1GHz~26.5GHz)	Horizontal: 1GHz~18GHz: 5.00 dB Vertical: 1GHz~18GHz: 4.80 dB
RF antenna conducted test	$\pm 1.27$ dB
Radiated Emission Band Edge	$\pm 3.9$ dB
DTS Bandwidth	$\pm 150$ Hz
Occupied Bandwidth	$\pm 1$ kHz
Power Density	$\pm 1.27$ dB

# 1 GENERAL INFORMATION

## 1.1 General Description of the Item(s)

Product Name .....	Digital Device
Model No. ....	9290024695
FCC ID .....	2AGBW9290024695X
IC .....	20812-24695X
Manufacturer .....	Signify (China) Investment Co., Ltd
Manufacturer Address .....	Building 9, Lane 888, Tian Lin Road, Min Hang District, Shanghai, P. R. C

Wireless specification.....	Bluetooth 5.0					
Operating frequency range(s) .....	2400~2483.5MHz					
Type of Modulation.....	GFSK					
PHYs .....	<input checked="" type="checkbox"/>	LE 1M	<input checked="" type="checkbox"/>	LE 2M	<input checked="" type="checkbox"/>	LE Coded S=2/8
Data Rate .....	<input checked="" type="checkbox"/>	1Mbit/s	<input checked="" type="checkbox"/>	2Mbit/s	<input checked="" type="checkbox"/>	500/125 Kbit/s
Number of channel .....	40					

Rated power supply .....	Voltage and Frequency					
	<input type="checkbox"/>	AC: 220 – 240 V, 50/60 Hz				
	<input type="checkbox"/>	AC: 100 – 240 V, 50/60 Hz				
	<input checked="" type="checkbox"/>	DC: 3.3 Vdc				
	<input type="checkbox"/>	Battery: .....				
Mounting position .....	<input type="checkbox"/>	Table top equipment				
	<input type="checkbox"/>	Wall/Ceiling mounted equipment				
	<input type="checkbox"/>	Floor standing equipment				
	<input type="checkbox"/>	Head-mounted equipment				
	<input checked="" type="checkbox"/>	Other:				

## 1.2 Antenna Information

Antenna model / type number .....	N/A		
Antenna serial number .....	N/A		
Antenna Delivery .....	<input checked="" type="checkbox"/>	1TX + 1RX	
	<input type="checkbox"/>	2TX + 2RX	
Antenna technology .....	<input checked="" type="checkbox"/>	SISO	
	<input type="checkbox"/>	MIMO	<input type="checkbox"/> CDD <input type="checkbox"/> Beam-forming
Antenna Type .....	<input type="checkbox"/>	External	<input type="checkbox"/> Dipole
			<input type="checkbox"/> Sectorized
	<input checked="" type="checkbox"/>	Internal	<input type="checkbox"/> PIFA
			<input checked="" type="checkbox"/> PCB
			<input type="checkbox"/> Metal Monopole Antenna
		<input type="checkbox"/> Others.....	
Antenna Gain .....	2.08 dBi		

### 1.3 Channel List

Bluetooth Working Frequency of Each Channel:							
Channel	Frequency	Channel	Frequency	Channel	Frequency	Channel	Frequency
00	2402 MHz	01	2404 MHz	02	2406 MHz	03	2408 MHz
04	2410 MHz	05	2412 MHz	06	2414 MHz	07	2416 MHz
08	2418 MHz	09	2420 MHz	10	2422 MHz	11	2424 MHz
12	2426 MHz	13	2428 MHz	14	2430 MHz	15	2432 MHz
16	2434 MHz	17	2436 MHz	18	2438 MHz	19	2440 MHz
20	2442 MHz	21	2444 MHz	22	2446 MHz	23	2448 MHz
24	2450 MHz	25	2452 MHz	26	2454 MHz	27	2456 MHz
28	2458 MHz	29	2460 MHz	30	2462 MHz	31	2464 MHz
32	2466 MHz	33	2468 MHz	34	2470 MHz	35	2472 MHz
36	2474 MHz	37	2476 MHz	38	2478 MHz	39	2480 MHz

Note: The general description of the Item(s), antenna information and channel list in clause 1 are provided and confirmed by the client.

## 2 DESCRIPTION OF TEST SETUP

### 2.1 Operating mode(s) used for tests

During the tests the following operating mode(s) has(have) been used.

Test Mode For Bluetooth	Mode1: Transmit by LE_1Mbps
	Mode2: Transmit by LE_2Mbps
	Mode3: Transmit by LE_Coded S=2
	Mode4: Transmit by LE_Coded S=8

### 2.2 Auxiliary equipment / Test software for the EUT

Auxiliary equipment	Type / Version	Manufacturer	Supplied by
Notebook	Think pad x220	Lenovo	Adapter
Debug board	N/A	N/A	N/A
Software	Type / Version	Manufacturer	Supplied by
ApprobationTool	N/A	N/A	N/A

### 2.3 Test Configuration / Block diagram used for tests

Test setup Diagram- AC Line Conducted Emission Test

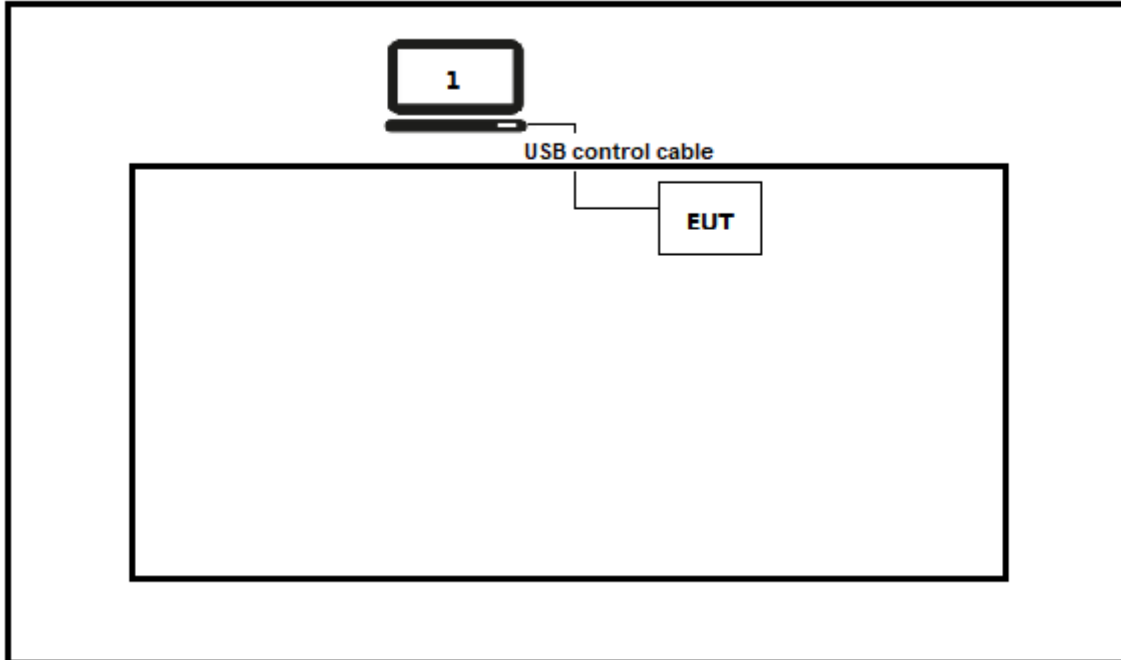

Test setup Diagram- Radiated Emission

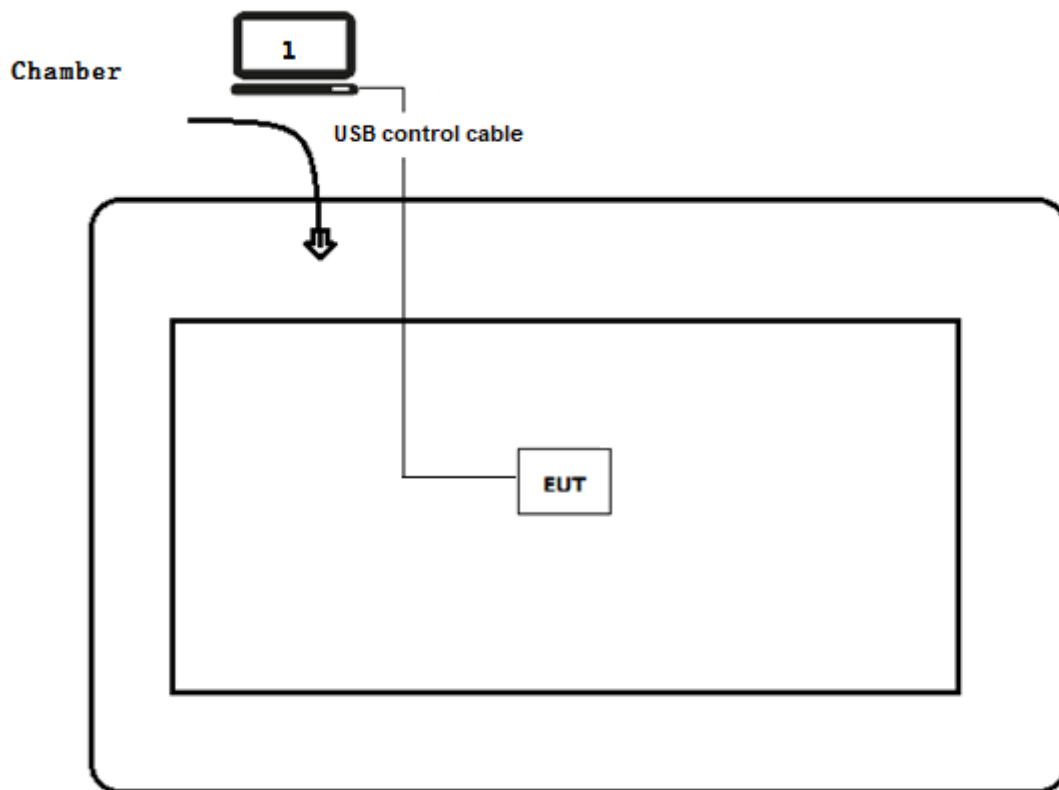

## 2.4 Testing process

1	Setup the EUT as shown in Section 2.3.
2	Execute test software "ApprobationTool" on the notebook.
3	Configure the test mode, the test channel, and the data rate.
4	Verify that the EUT works properly.

### 3 VERDICT SUMMARY SECTION

This chapter presents an overview of standards and results. Refer to the next chapters for details of measured test results and applied test levels.

#### 3.1 Standards

Standard	Year	Description
FCC CFR Title 47 Part 15 Subpart C Section 15.247	2021	Operation within the bands 902–928 MHz, 2400–2483.5 MHz, and 5725–5850 MHz.
ANSI C63.10	2013	American National Standard of Procedures for Compliance Testing of Unlicensed Wireless Devices
KDB 558074 D01 v05r02	2019	Guidance for performing compliance measurements on Digital Transmission System (DTS) operating under section 15.247
RSS-Gen Issue 5 Amendment 1	2019	General Requirements for Compliance of Radio Apparatus
RSS-247 Issue 2	2017	Digital Transmission Systems (DTSs), Frequency Hopping Systems (FHSs) and Licence-Exempt Local Area Network (LE-LAN) Devices

#### 3.2 Deviation(s) from the Standard(s) / Test Specification(s)

The following deviation(s) was / were made from the published requirements of the listed standards: N/A.

*(Please define the deviations from the standard(s) if applicable)*



### 3.3 Overview of results

#### For FCC

Requirement – Test case	Basic standard(s)	Verdict	Remark
AC Power Line Conducted Emission	FCC 15.207	PASS	---
Emissions in restricted frequency bands	FCC 15.247(b)(3)	PASS	---
Duty cycle	ANSI C63.10:2013	PASS	---
Emissions in non-restricted frequency bands	FCC 15.247(d), FCC 15.209	PASS	---
Radiated Emission Band Edge	FCC 15.247(d)	PASS	---
Fundamental emission output power	FCC 15.247(d), FCC 15.209	PASS	---
DTS Bandwidth	FCC 15.247(a)(2)	PASS	---
Power Spectral Density	FCC 15.247(e)	PASS	---
Antenna Requirement	FCC 15.203	PASS	---

#### For ISED

Requirement – Test case	Basic standard(s)	Verdict	Remark
AC Power Line Conducted Emission	RSS-Gen Issue 5 Section 8.8	PASS	---
Emissions in restricted frequency bands	RSS-Gen Issue 5 Section 8.9	PASS	---
Duty cycle	ANSI C63.10:2013	PASS	---
Emissions in non-restricted frequency bands	RSS-247 Issue 2 Section 5.5	PASS	---
Radiated Emission Band Edge	RSS-Gen Issue 5 Section 8.10	PASS	---
Fundamental emission output power	RSS-247 Issue 2 Section 5.4(d)	PASS	---
DTS Bandwidth	RSS-Gen Issue 5 Section 6.7	PASS	---
Power Spectral Density	RSS-247 Issue 2 Section 5.2(b)	PASS	---
Antenna Requirement	RSS-Gen Issue 5 Section 6.8	PASS	---

---

### 3.4 Test Facility

**USA : FCC Designation Number: CN1199**

**CA : ISED CAB identifier: CN0040**

## 4 TEST RESULTS

### 4.1 AC Power Line Conducted Emission

VERDICT: PASS

#### 4.1.1 Limit

Standard		
FCC Part 15 Subpart C Paragraph 15.207		
Frequency range [MHz]	Limit: QP [dB(μV) <sup>1)</sup>	Limit: AV [dB(μV) <sup>1)</sup>
0,15 - 0,50	66 - 56 <sup>2)</sup>	56 - 46 <sup>2)</sup>
0,50 - 5,0	56	46
5,0 - 30	60	50

<sup>1)</sup> At the transition frequency, the lower limit applies.

<sup>2)</sup> The limit decreases linearly with the logarithm of the frequency.

**NOTE 1:** The exclusion band for transmitters shall be considered for transmitters operating at frequencies below 30 MHz.

**NOTE 2:** Where the AC output port is directly connected (or via a circuit breaker) to the AC power input port of the EUT the AC power output port need not to be tested.

#### 4.1.2 Test Setup

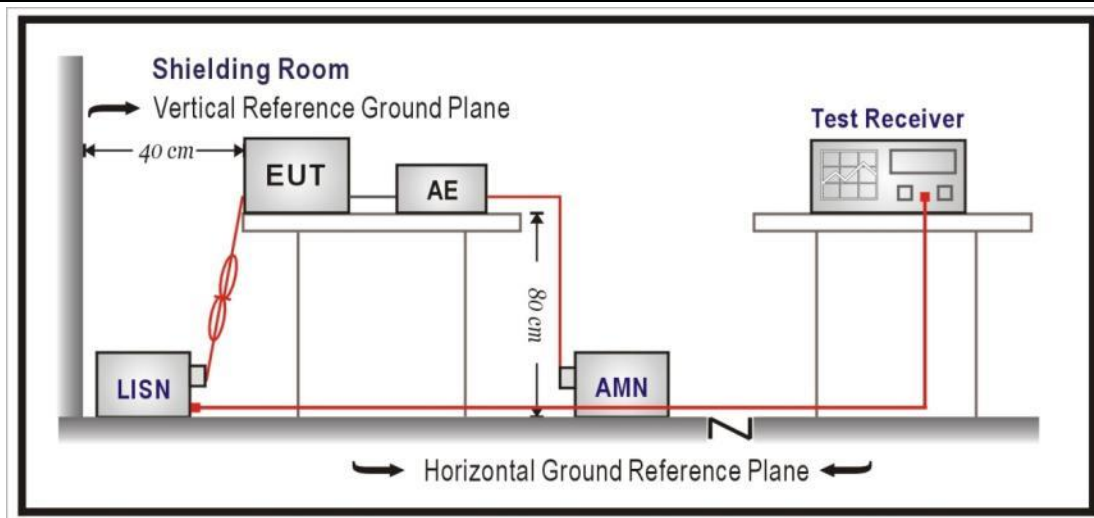

#### 4.1.3 Test Procedure

	References Rule	Chapter	Item
<input checked="" type="checkbox"/>	ANSI C63.10-2013	6.2	Standard test method for ac power-line conducted emissions from unlicensed wireless devices

**4.1.4 Test Data**

Profile: 20B0023R	Page No.: 1
Engineer: YULIU	
Site: TR1	Time: 2021/02/03 - 15:30
Limit: FCC_Part15.207_CE_AC Power	Margin: 0
Probe: ENV216_101044_(0.009-30MHz)	Polarity: Line
EUT: Digital Device	Power: AC 120V/60Hz
Note: Mode 1	

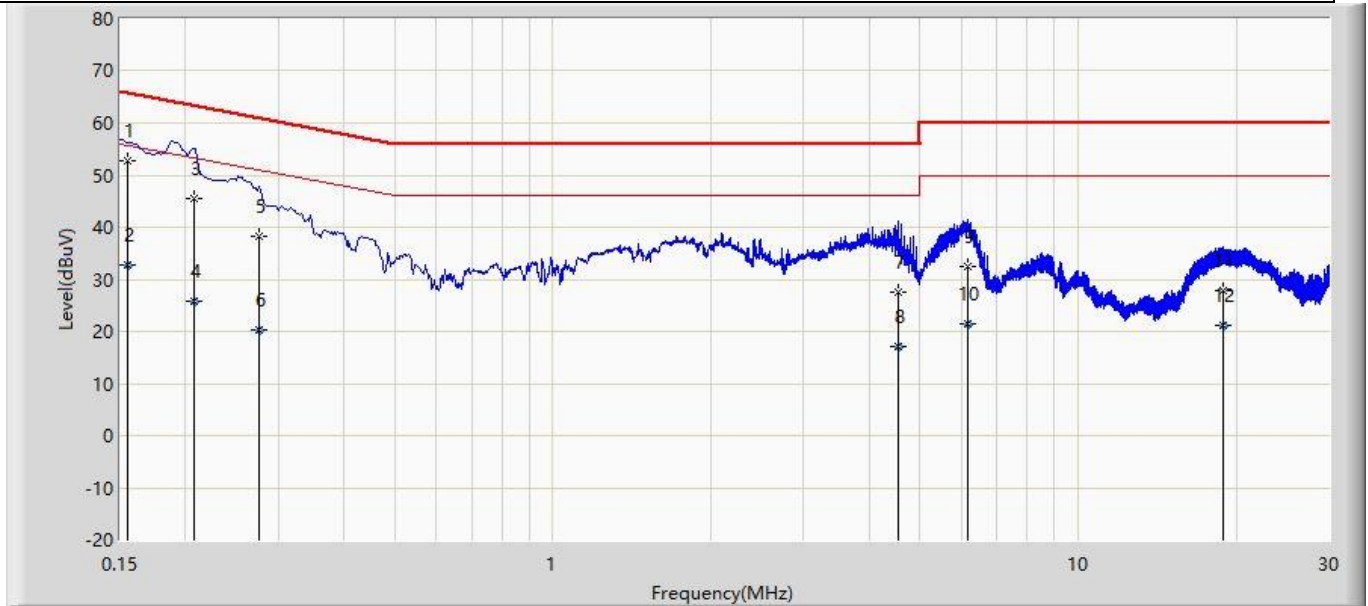

No	Mark	Frequency (MHz)	Measure Level (dBuV)	Reading Level (dBuV)	Over Limit (dB)	Limit (dBuV)	Factor (dB)	Type
1	*	0.155	52.786	43.121	-12.939	65.725	9.665	QP
2		0.155	32.676	23.011	-23.049	55.725	9.665	AV
3		0.208	45.470	35.789	-17.795	63.265	9.680	QP
4		0.208	25.914	16.234	-27.351	53.265	9.680	AV
5		0.276	38.215	28.521	-22.721	60.935	9.694	QP
6		0.276	20.267	10.574	-30.668	50.935	9.694	AV
7		4.537	27.527	17.614	-28.473	56.000	9.912	QP
8		4.537	17.203	7.290	-28.797	46.000	9.912	AV
9		6.144	32.404	22.417	-27.596	60.000	9.987	QP
10		6.144	21.522	11.535	-28.478	50.000	9.987	AV
11		18.809	27.707	17.320	-32.293	60.000	10.387	QP
12		18.809	21.050	10.663	-28.950	50.000	10.387	AV

Profile: 20B0023R	Page No.: 2
Engineer: YULIU	
Site: TR1	Time: 2021/02/03 - 15:35
Limit: FCC_Part15.207_CE_AC Power	Margin: 0
Probe: ENV216_101044_(0.009-30MHz)	Polarity: Neutral
EUT: Digital Device	Power: AC 120V/60Hz
Note: Mode 1	

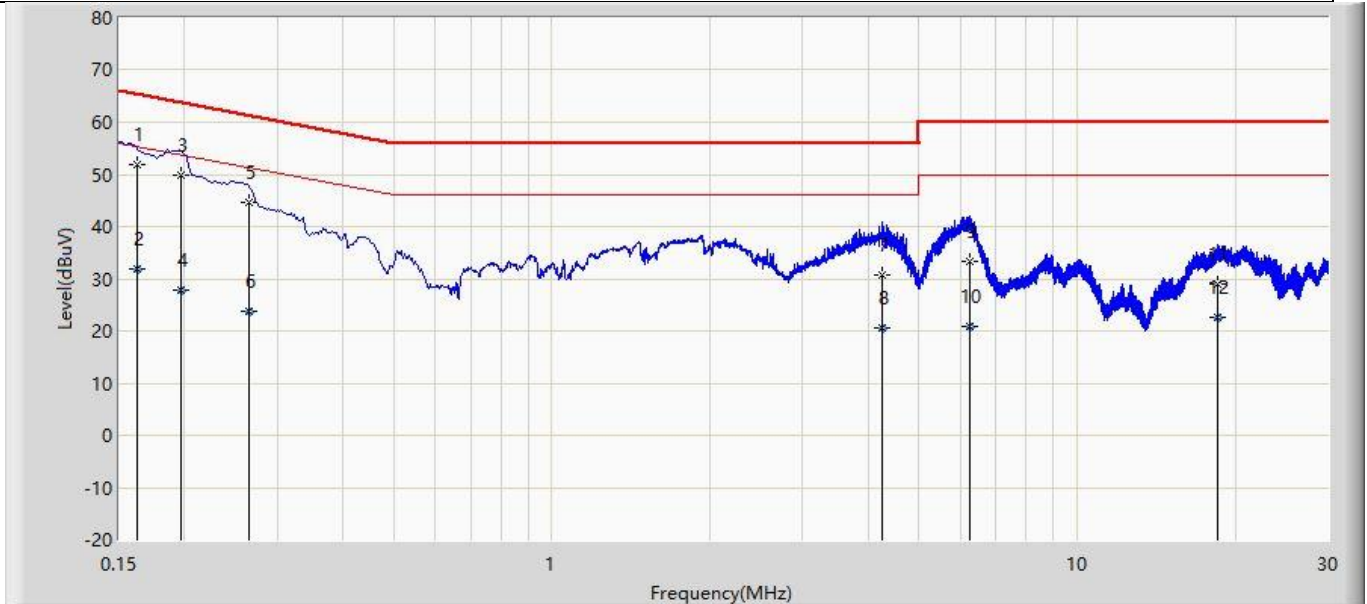

No	Mark	Frequency (MHz)	Measure Level (dBuV)	Reading Level (dBuV)	Over Limit (dB)	Limit (dBuV)	Factor (dB)	Type
1	*	0.162	51.791	42.124	-13.589	65.380	9.667	QP
2		0.162	31.855	22.188	-23.525	55.380	9.667	AV
3		0.197	49.804	40.104	-13.922	63.726	9.700	QP
4		0.197	27.749	18.049	-25.976	53.726	9.700	AV
5		0.265	44.523	34.810	-16.758	61.281	9.714	QP
6		0.265	23.896	14.183	-27.385	51.281	9.714	AV
7		4.265	30.867	20.961	-25.133	56.000	9.907	QP
8		4.265	20.687	10.780	-25.313	46.000	9.907	AV
9		6.247	33.387	23.384	-26.613	60.000	10.003	QP
10		6.247	20.766	10.763	-29.234	50.000	10.003	AV
11		18.548	28.970	18.581	-31.030	60.000	10.389	QP
12		18.548	22.648	12.260	-27.352	50.000	10.389	AV

<b>4.2 Emissions in restricted frequency bands</b>	<b>VERDICT: PASS</b>
--	----------------------

4.2.1 Limit			
Standard		FCC Part 15 Subpart C Paragraph 15.209	
Restricted Bands of operation			
Frequency (MHz)	Frequency (MHz)	Frequency (MHz)	Frequency (GHz)
0.090 – 0.110	16.42 – 16.423	399.9 – 410	4.5 – 5.15
0.495 – 0.505	16.69475 – 16.69525	608 – 614	5.35 – 5.46
2.1735 – 2.1905	16.80425 – 16.80475	960 – 1240	7.25 – 7.75
4.125 – 4.128	25.5 – 25.67	1300 – 1427	8.025 – 8.5
4.17725 – 4.17775	37.5 – 38.25	1435 – 1626.5	9.0 – 9.2
4.20725 – 4.20775	73 – 74.6	1645.5 – 1646.5	9.3 – 9.5
6.215 – 6.218	74.8 – 75.2	1660 – 1710	10.6 – 12.7
6.26775 – 6.26825	108 – 121.94	1718.8 – 1722.2	13.25 – 13.4
6.31175 – 6.31225	123 – 138	2200 – 2300	14.47 – 14.5
8.291 – 8.294	149.9 – 150.05	2310 – 2390	15.35 – 16.2
8.362 – 8.366	156.52475 – 156.52525	2483.5 – 2500	17.7 – 21.4
8.37625 – 8.38675	156.7 – 156.9	2690 – 2900	22.01 – 23.12
8.81425 – 8.81475	162.0125 – 167.17	3260 – 3267	23.6 – 24.0
12.29 – 12.293	167.72 – 173.2	3332 – 3339	31.2 – 31.8
12.51975 – 12.52025	240 – 285	3345.8 – 3358	36.43 – 36.5
12.57675 – 12.57725	322 – 335.4	3600 – 4400	
13.36 – 13.41			
Restricted Bands of operation for IC			
0.090 - 0.110	13.36 - 13.41	960 - 1427	9.0 - 9.2
0.495 - 0.505	16.42 - 16.423	1435 - 1626.5	9.3 - 9.5
2.1735 - 2.1905	16.69475 - 16.69525	1645.5 - 1646.5	10.6 - 12.7
3.020 - 3.026	16.80425 - 16.80475	1660 - 1710	13.25 - 13.4
4.125 - 4.128	25.5 - 25.67	1718.8 - 1722.2	14.47 - 14.5
4.17725 - 4.17775	37.5 - 38.25	2200 - 2300	15.35 - 16.2
4.20725 - 4.20775	73 - 74.6	2310 - 2390	17.7 - 21.4
5.677 - 5.683	74.8 - 75.2	2483.5 - 2500	22.01 - 23.12
6.215 - 6.218	108 - 138	2655 - 2900	23.6 - 24.0
6.26775 - 6.26825	149.9 - 150.05	3260 - 3267	31.2 - 31.8
6.31175 - 6.31225	156.52475 - 156.52525	3332 - 3339	36.43 - 36.5
8.291 - 8.294	156.7 - 156.9	3345.8 - 3358	Above 38.6
8.362 - 8.366	162.0125 - 167.17	3500 - 4400	
8.37625 - 8.38675	167.72 - 173.2	4500 - 5150	
8.81425 - 8.81475	240 - 285	5350 - 5460	
12.29 - 12.293	322 - 335.4	7250 - 7750	
12.51975 - 12.52025	399.9 - 410	8025 - 8500	
12.57675 - 12.57725	608 - 614	--	

Restricted Band Emissions Limit			
Frequency (MHz)	Field strength ( $\mu\text{V/m}$ )	Field strength ( $\text{dB}\mu\text{V/m}$ )	Measurement distance (m)
0.009 - 0.49	2400/F(kHz)	48.5 – 13.8	300 <sub>(Note 1)</sub>
0.49 - 1.705	24000/F(kHz)	33.8 - 23	30 <sub>(Note 1)</sub>
1.705 - 30	30	29.5	30 <sub>(Note 1)</sub>
30 - 88	100	40	3 <sub>(Note 2)</sub>
88 - 216	150	43.5	3 <sub>(Note 2)</sub>
216 - 960	200	46	3 <sub>(Note 2)</sub>
Above 960	500	54	3 <sub>(Note 2)</sub>

Note 1: At frequencies below 30 MHz, measurements may be performed at a distance closer than that specified in the regulations; however, an attempt should be made to avoid making measurements in the near field. Pending the development of an appropriate measurement procedure for measurements performed below 30 MHz, when performing measurements at a closer distance than specified, the results shall be extrapolated to the specified distance by either making measurements at a minimum of two distances on at least one radial to determine the proper extrapolation factor or by using the square of an inverse linear distance extrapolation factor (40 dB/decade).

Note 2: At frequencies at or above 30 MHz, measurements may be performed at a distance other than what is specified provided: measurements are not made in the near field except where it can be shown that near field measurements are appropriate due to the characteristics of the device; and it can be demonstrated that the signal levels needed to be measured at the distance employed can be detected by the measurement equipment.

Measurements shall not be performed at a distance greater than 30 meters unless it can be further demonstrated that measurements at a distance of 30 meters or less are impractical. When performing measurements at a distance other than that specified, the results shall be extrapolated to the specified distance using an extrapolation factor of 20 dB/decade (inverse linear-distance for field strength measurements; inverse-linear-distance-squared for power density measurements).

### 4.2.2 Test Setup

30MHz-1GHz Test Setup:

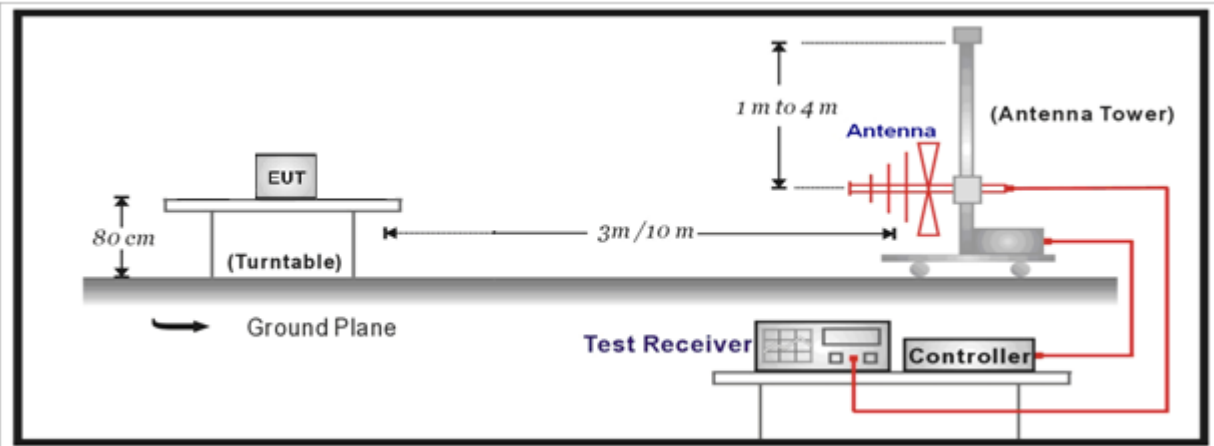

Above 1GHz Test Setup:

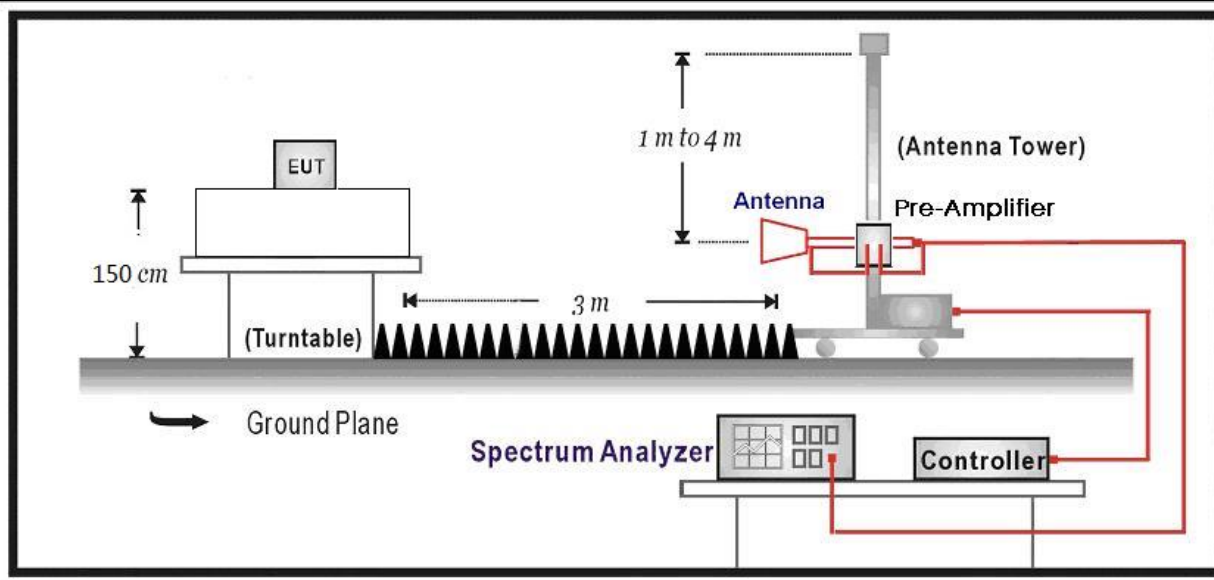

### 4.2.3 Test Procedure

References Rule	Chapter	Description
<input checked="" type="checkbox"/> ANSI C63.10	11.12	Emissions in restricted frequency bands
<input checked="" type="checkbox"/> ANSI C63.10	11.12.1	Radiated emission measurements
<input checked="" type="checkbox"/> ANSI C63.10	11.12.2.7	Radiated spurious emission test
<input checked="" type="checkbox"/> ANSI C63.10	6.4	Radiated emissions from unlicensed wireless devices below 30 MHz
<input checked="" type="checkbox"/> ANSI C63.10	6.5	Radiated emissions from unlicensed wireless devices in the frequency range of 30 MHz to 1000 MHz
<input checked="" type="checkbox"/> ANSI C63.10	6.6	Radiated emissions from unlicensed wireless devices above 1 GHz



**4.2.4 Test Data**

Profile: 20B0023R	Page No.: 67
Engineer: Pawn	
Site: AC5	Time: 2020/11/17 - 21:12
Limit: FCC_Part15.209_RE(3m)	Margin: 0
Probe: Horn_3117_00167055(1-18GHz)	Polarity: Horizontal
EUT: Digital Device	Power: 24 Vdc
Note: Mode1:Transmit at 2402MHz	

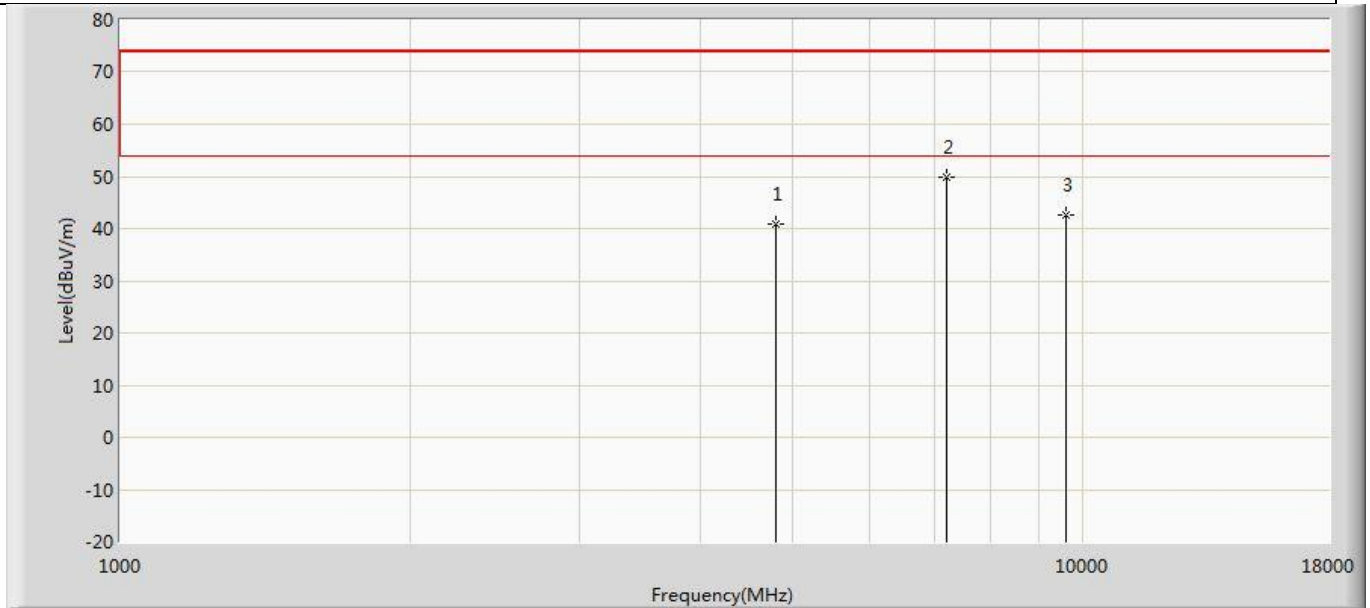

No	Mark	Frequency (MHz)	Measure Level (dBuV/m)	Reading Level (dBuV)	Over Limit (dB)	Limit (dBuV/m)	Factor (dB)	Type
1		4804.000	40.954	45.614	-33.046	74.000	-4.660	PK
2	*	7205.000	49.897	52.059	-24.103	74.000	-2.162	PK
3		9608.000	42.617	43.741	-31.383	74.000	-1.124	PK

Profile: 20B0023R	Page No.: 68
Engineer: Pawn	
Site: AC5	Time: 2020/11/17 - 21:12
Limit: FCC_Part15.209_RE(3m)	Margin: 0
Probe: Horn_3117_00167055(1-18GHz)	Polarity: Vertical
EUT: Digital Device	Power: 24 Vdc
Note: Mode1:Transmit at 2402MHz	

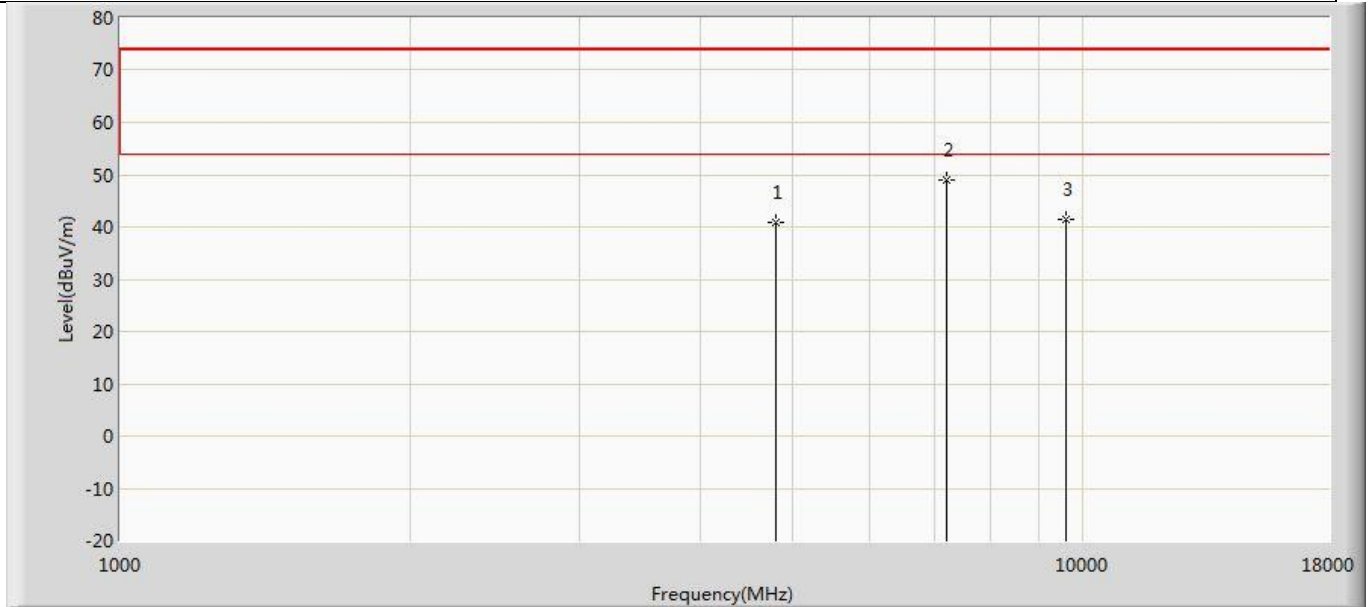

No	Mark	Frequency (MHz)	Measure Level (dBuV/m)	Reading Level (dBuV)	Over Limit (dB)	Limit (dBuV/m)	Factor (dB)	Type
1		4804.000	40.926	45.586	-33.074	74.000	-4.660	PK
2	*	7205.000	49.044	51.206	-24.956	74.000	-2.162	PK
3		9608.000	41.423	42.547	-32.577	74.000	-1.124	PK

Profile: 20B0023R	Page No.: 75
Engineer: Pawn	
Site: AC5	Time: 2020/11/17 - 21:13
Limit: FCC_Part15.209_RE(3m)	Margin: 0
Probe: Horn_3117_00167055(1-18GHz)	Polarity: Horizontal
EUT: Digital Device	Power: 24 Vdc
Note: Mode1:Transmit at 2440MHz	

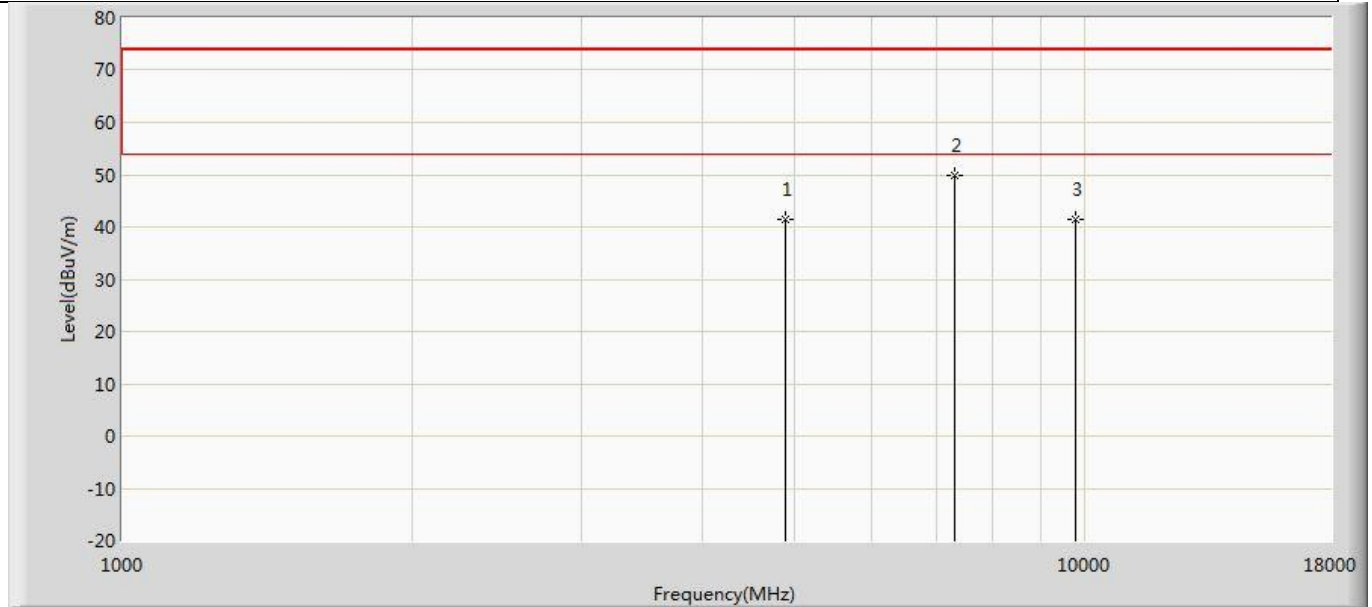

No	Mark	Frequency (MHz)	Measure Level (dBuV/m)	Reading Level (dBuV)	Over Limit (dB)	Limit (dBuV/m)	Factor (dB)	Type
1		4880.000	41.540	46.498	-32.460	74.000	-4.959	PK
2	*	7324.000	49.837	51.829	-24.163	74.000	-1.992	PK
3		9760.000	41.421	41.996	-32.579	74.000	-0.575	PK

Profile: 20B0023R	Page No.: 76
Engineer: Pawn	
Site: AC5	Time: 2020/11/17 - 21:13
Limit: FCC_Part15.209_RE(3m)	Margin: 0
Probe: Horn_3117_00167055(1-18GHz)	Polarity: Vertical
EUT: Digital Device	Power: 24 Vdc
Note: Mode1:Transmit at 2440MHz	

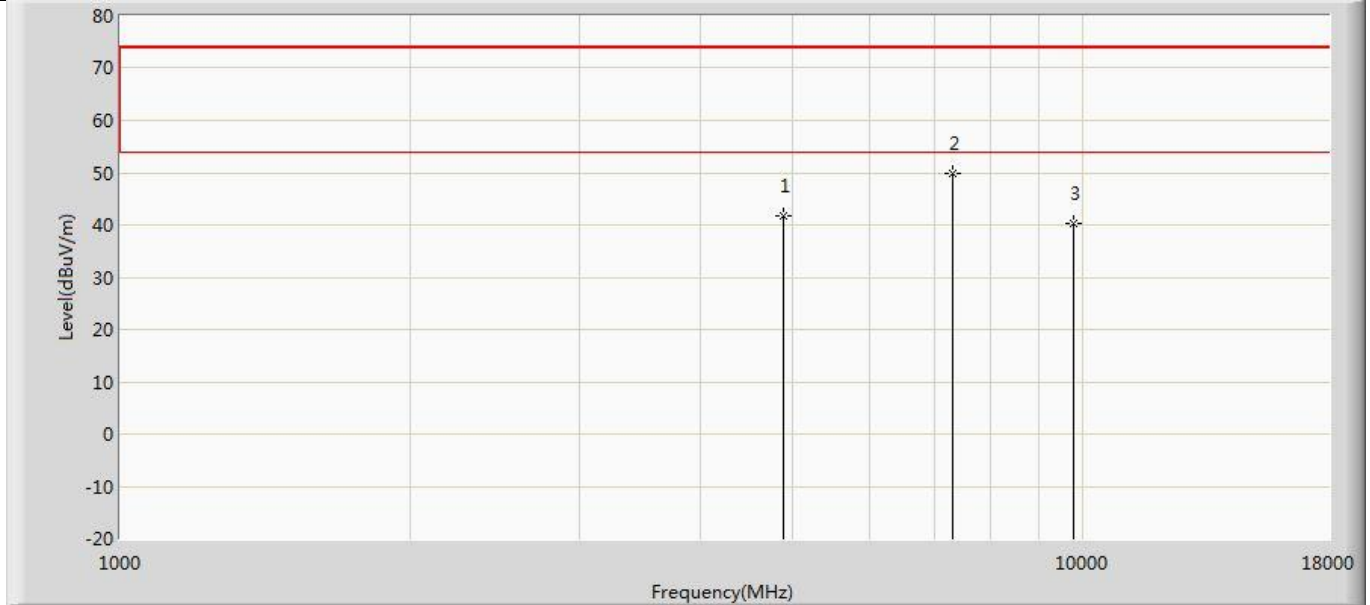

No	Mark	Frequency (MHz)	Measure Level (dBuV/m)	Reading Level (dBuV)	Over Limit (dB)	Limit (dBuV/m)	Factor (dB)	Type
1		4880.000	41.649	46.607	-32.351	74.000	-4.959	PK
2	*	7324.000	49.837	51.829	-24.163	74.000	-1.992	PK
3		9760.000	40.282	40.857	-33.718	74.000	-0.575	PK

Profile: 20B0023R	Page No.: 83
Engineer: Pawn	
Site: AC5	Time: 2020/11/17 - 21:14
Limit: FCC_Part15.209_RE(3m)	Margin: 0
Probe: Horn_3117_00167055(1-18GHz)	Polarity: Horizontal
EUT: Digital Device	Power: 24 Vdc
Note: Mode1:Transmit at 2480MHz	

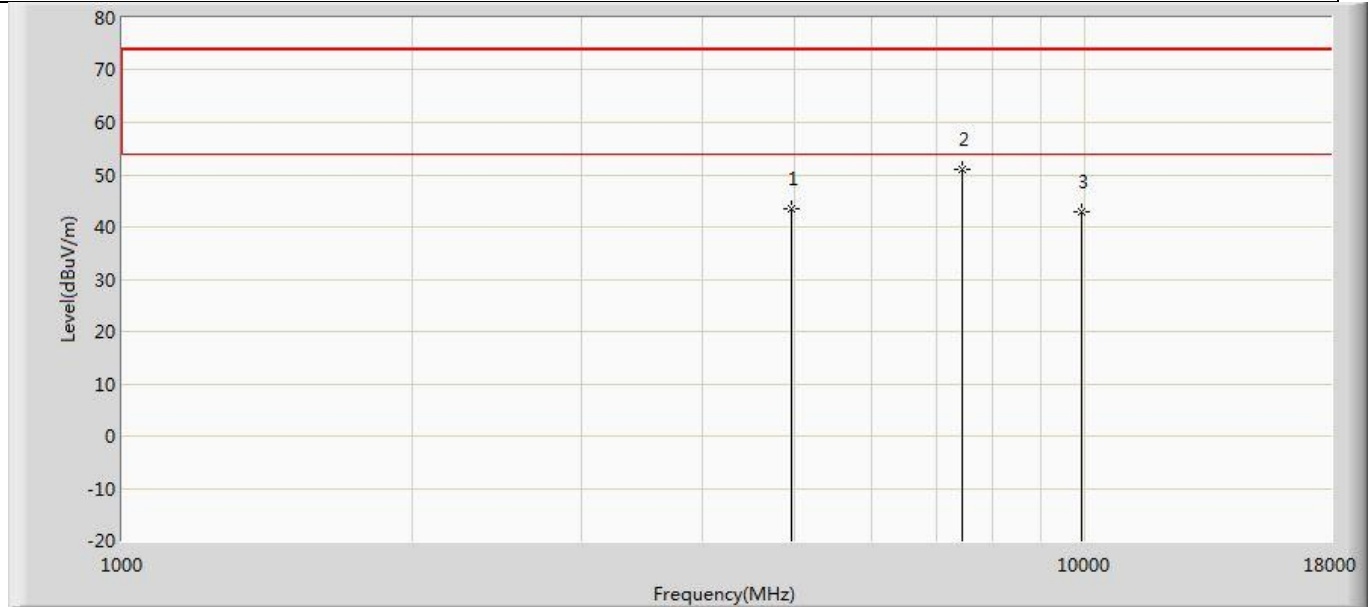

No	Mark	Frequency (MHz)	Measure Level (dBuV/m)	Reading Level (dBuV)	Over Limit (dB)	Limit (dBuV/m)	Factor (dB)	Type
1		4960.000	43.422	48.393	-30.578	74.000	-4.972	PK
2	*	7443.000	50.935	52.897	-23.065	74.000	-1.962	PK
3		9920.000	42.865	42.698	-31.135	74.000	0.167	PK

Profile: 20B0023R	Page No.: 84
Engineer: Pawn	
Site: AC5	Time: 2020/11/17 - 21:14
Limit: FCC_Part15.209_RE(3m)	Margin: 0
Probe: Horn_3117_00167055(1-18GHz)	Polarity: Vertical
EUT: Digital Device	Power: 24 Vdc
Note: Mode1:Transmit at 2480MHz	

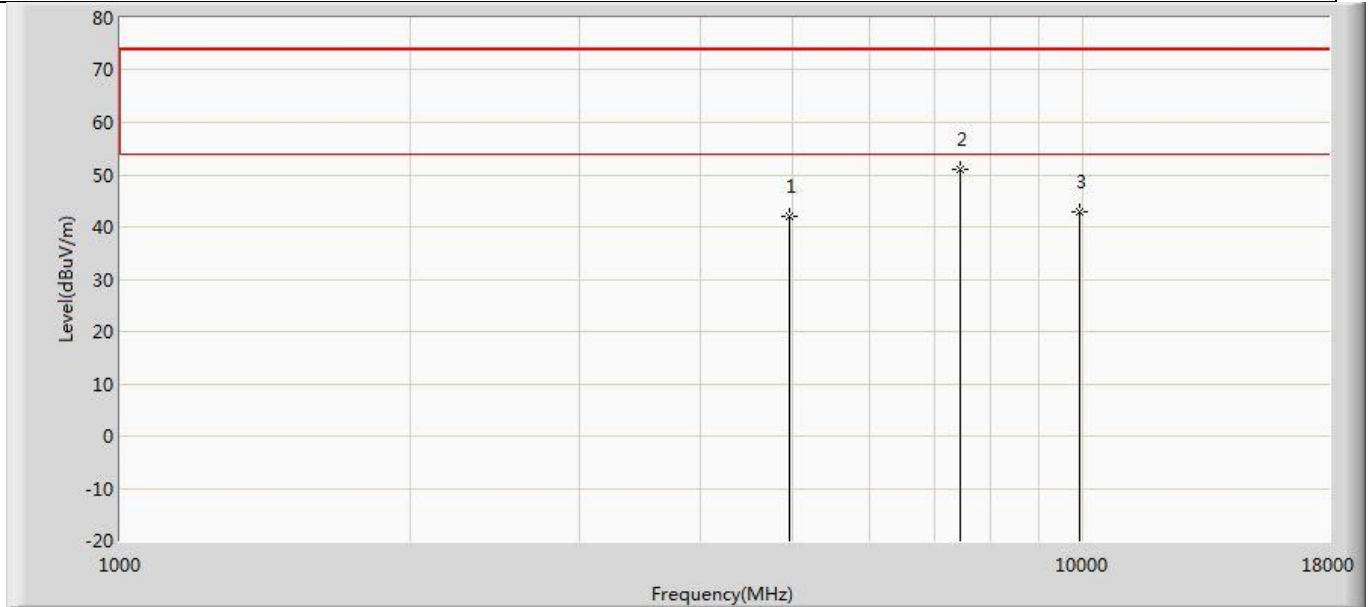

No	Mark	Frequency (MHz)	Measure Level (dBuV/m)	Reading Level (dBuV)	Over Limit (dB)	Limit (dBuV/m)	Factor (dB)	Type
1		4960.000	41.961	46.932	-32.039	74.000	-4.972	PK
2	*	7443.000	50.935	52.897	-23.065	74.000	-1.962	PK
3		9920.000	42.886	42.719	-31.114	74.000	0.167	PK

Profile: 20B0023R	Page No.: 69
Engineer: Pawn	
Site: AC5	Time: 2020/11/17 - 21:12
Limit: FCC_Part15.209_RE(3m)	Margin: 0
Probe: Horn_3117_00167055(1-18GHz)	Polarity: Horizontal
EUT: Digital Device	Power: 24 Vdc
Note: Mode2:Transmit at 2402MHz	

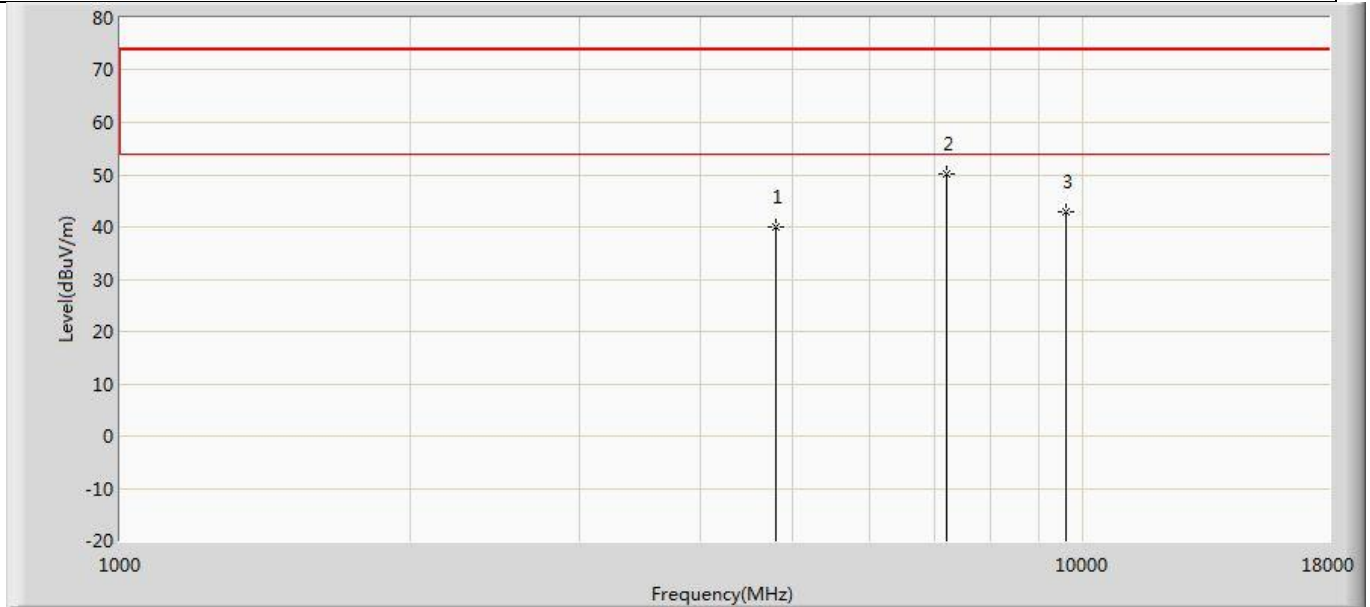

No	Mark	Frequency (MHz)	Measure Level (dBuV/m)	Reading Level (dBuV)	Over Limit (dB)	Limit (dBuV/m)	Factor (dB)	Type
1		4804.000	40.032	44.692	-33.968	74.000	-4.660	PK
2	*	7205.000	50.073	52.235	-23.927	74.000	-2.162	PK
3		9608.000	42.930	44.054	-31.070	74.000	-1.124	PK

Profile: 20B0023R	Page No.: 70
Engineer: Pawn	
Site: AC5	Time: 2020/11/17 - 21:12
Limit: FCC_Part15.209_RE(3m)	Margin: 0
Probe: Horn_3117_00167055(1-18GHz)	Polarity: Vertical
EUT: Digital Device	Power: 24 Vdc
Note: Mode2:Transmit at 2402MHz	

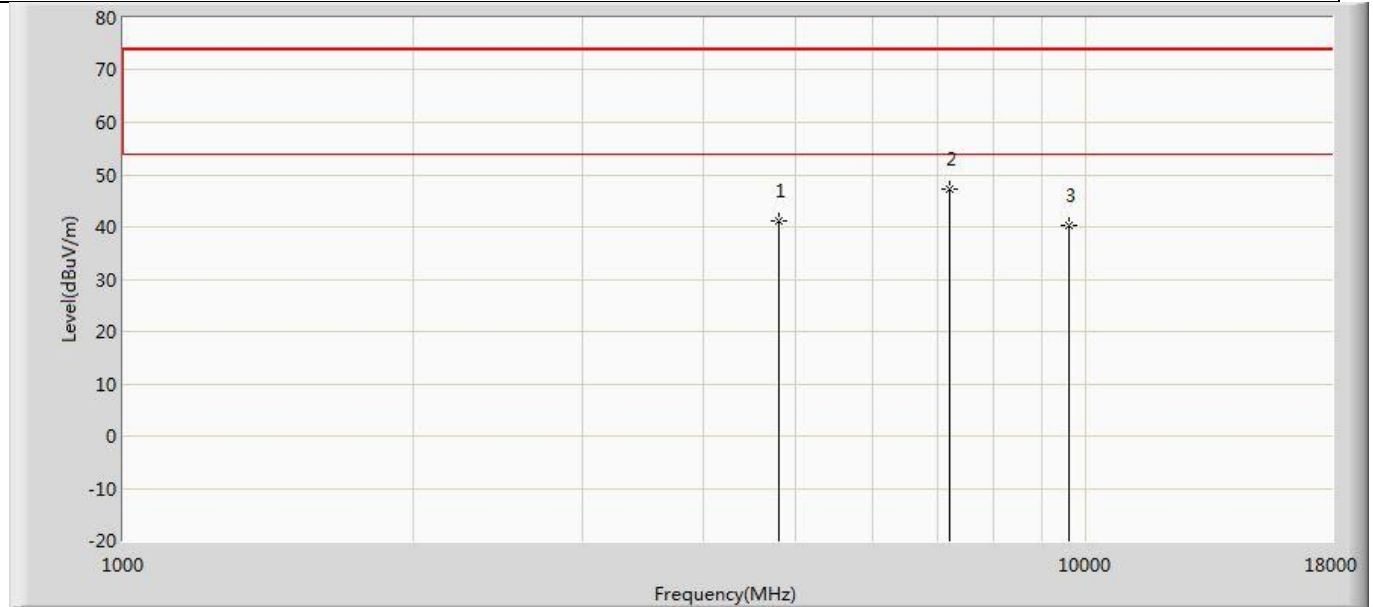

No	Mark	Frequency (MHz)	Measure Level (dBuV/m)	Reading Level (dBuV)	Over Limit (dB)	Limit (dBuV/m)	Factor (dB)	Type
1		4804.000	41.052	45.712	-32.948	74.000	-4.660	PK
2	*	7205.000	47.190	49.352	-26.810	74.000	-2.162	PK
3		9608.000	40.384	41.508	-33.616	74.000	-1.124	PK



Profile: 20B0023R	Page No.: 77
Engineer: Pawn	
Site: AC5	Time: 2020/11/17 - 21:13
Limit: FCC_Part15.209_RE(3m)	Margin: 0
Probe: Horn_3117_00167055(1-18GHz)	Polarity: Horizontal
EUT: Digital Device	Power: 24 Vdc
Note: Mode2:Transmit at 2440MHz	

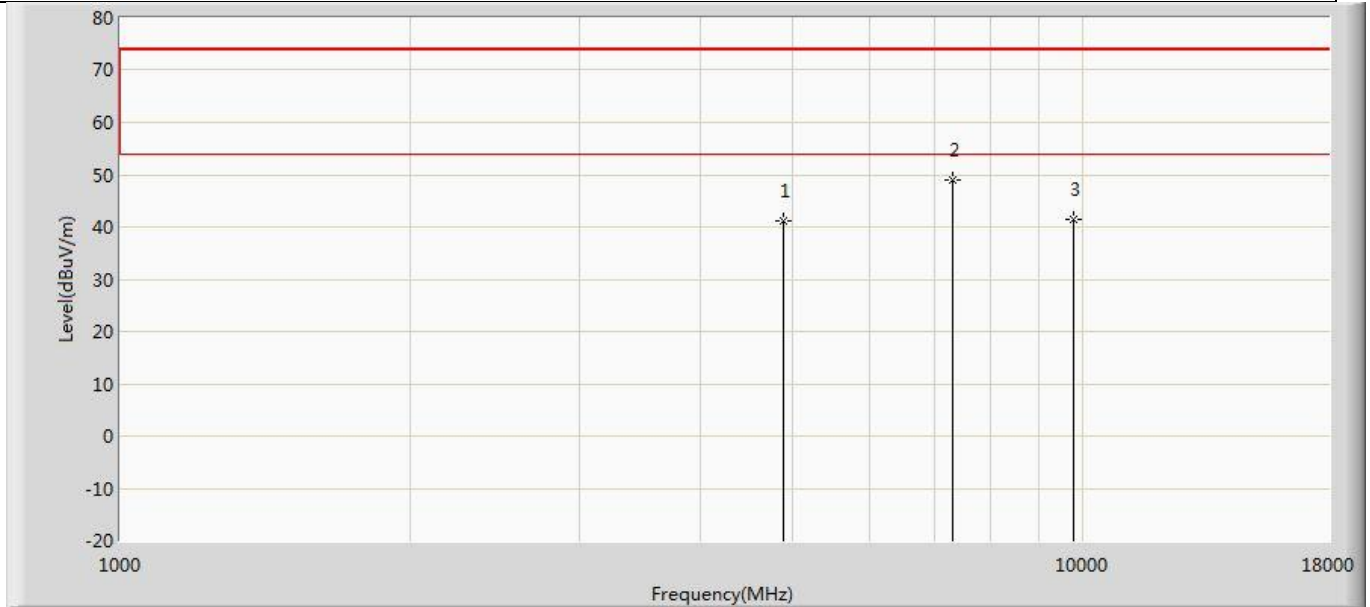

No	Mark	Frequency (MHz)	Measure Level (dBuV/m)	Reading Level (dBuV)	Over Limit (dB)	Limit (dBuV/m)	Factor (dB)	Type
1		4880.000	41.281	46.239	-32.719	74.000	-4.959	PK
2	*	7324.000	49.112	51.104	-24.888	74.000	-1.992	PK
3		9760.000	41.387	41.962	-32.613	74.000	-0.575	PK

Profile: 20B0023R	Page No.: 78
Engineer: Pawn	
Site: AC5	Time: 2020/11/17 - 21:13
Limit: FCC_Part15.209_RE(3m)	Margin: 0
Probe: Horn_3117_00167055(1-18GHz)	Polarity: Vertical
EUT: Digital Device	Power: 24 Vdc
Note: Mode2:Transmit at 2440MHz	

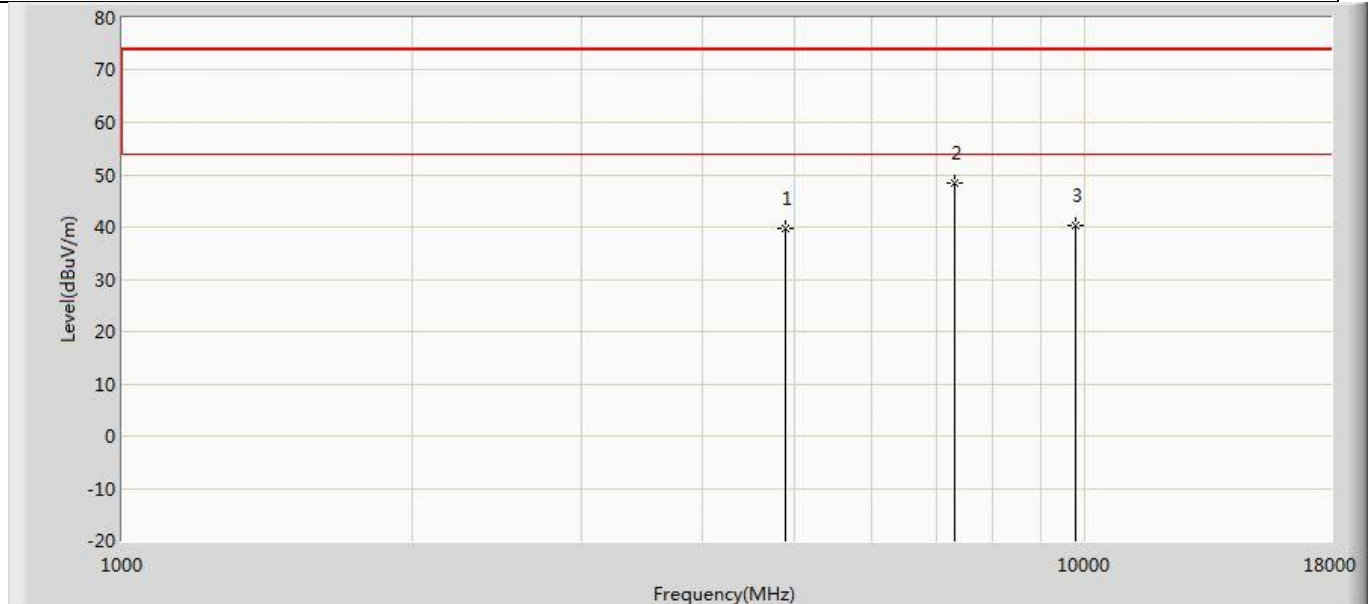

No	Mark	Frequency (MHz)	Measure Level (dBuV/m)	Reading Level (dBuV)	Over Limit (dB)	Limit (dBuV/m)	Factor (dB)	Type
1		4880.000	39.701	44.659	-34.299	74.000	-4.959	PK
2	*	7324.000	48.385	50.377	-25.615	74.000	-1.992	PK
3		9760.000	40.260	40.835	-33.740	74.000	-0.575	PK

Profile: 20B0023R	Page No.: 85
Engineer: Pawn	
Site: AC5	Time: 2020/11/17 - 21:14
Limit: FCC_Part15.209_RE(3m)	Margin: 0
Probe: Horn_3117_00167055(1-18GHz)	Polarity: Horizontal
EUT: Digital Device	Power: 24 Vdc
Note: Mode2:Transmit at 2480MHz	

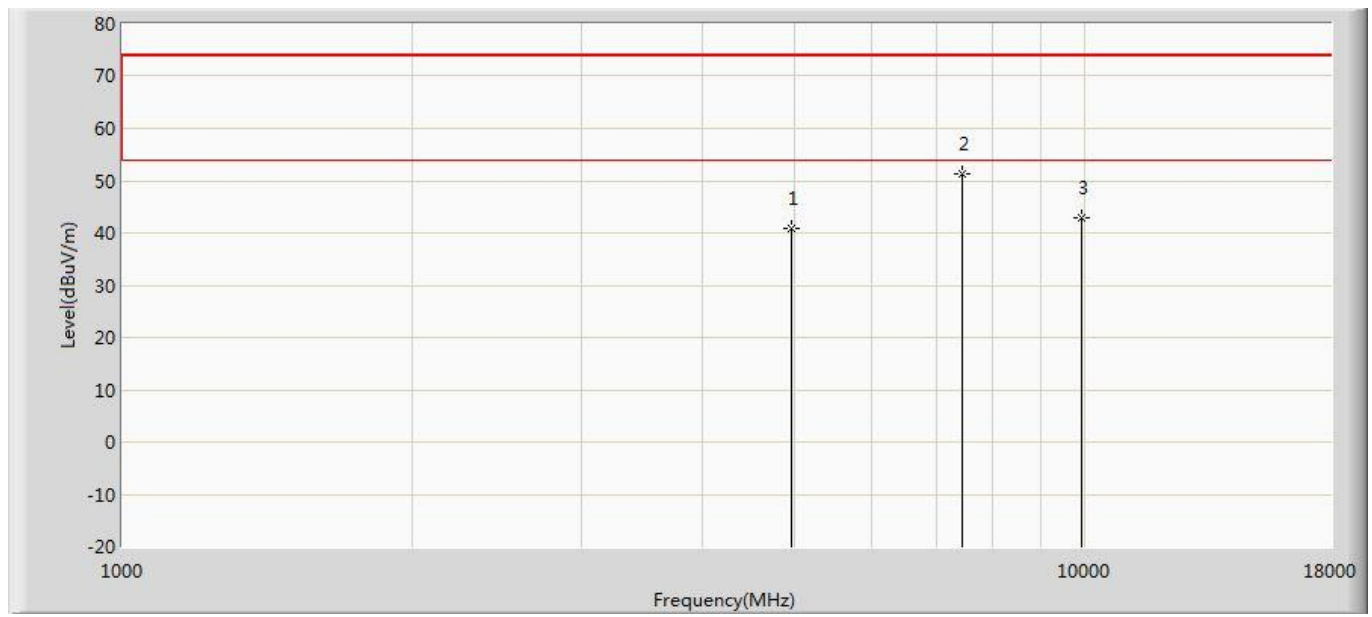

No	Mark	Frequency (MHz)	Measure Level (dBuV/m)	Reading Level (dBuV)	Over Limit (dB)	Limit (dBuV/m)	Factor (dB)	Type
1		4960.000	40.867	45.838	-33.133	74.000	-4.972	PK
2	*	7443.000	51.234	53.196	-22.766	74.000	-1.962	PK
3		9920.000	42.982	42.815	-31.018	74.000	0.167	PK

Profile: 20B0023R	Page No.: 86
Engineer: Pawn	
Site: AC5	Time: 2020/11/17 - 21:14
Limit: FCC_Part15.209_RE(3m)	Margin: 0
Probe: Horn_3117_00167055(1-18GHz)	Polarity: Vertical
EUT: Digital Device	Power: 24 Vdc
Note: Mode2:Transmit at 2480MHz	

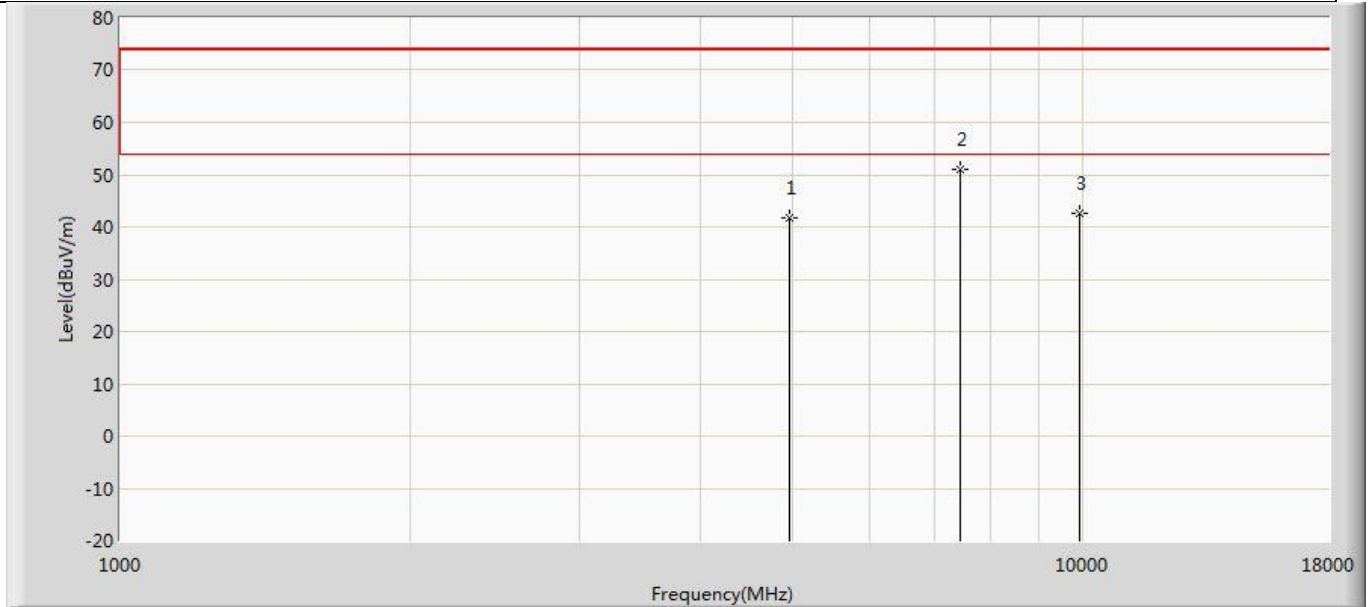

No	Mark	Frequency (MHz)	Measure Level (dBuV/m)	Reading Level (dBuV)	Over Limit (dB)	Limit (dBuV/m)	Factor (dB)	Type
1		4960.000	41.783	46.754	-32.217	74.000	-4.972	PK
2	*	7443.000	51.033	52.995	-22.967	74.000	-1.962	PK
3		9920.000	42.519	42.352	-31.481	74.000	0.167	PK

Profile: 20B0023R	Page No.: 73
Engineer: Pawn	
Site: AC5	Time: 2020/11/17 - 21:13
Limit: FCC_Part15.209_RE(3m)	Margin: 0
Probe: Horn_3117_00167055(1-18GHz)	Polarity: Horizontal
EUT: Digital Device	Power: 24 Vdc
Note: Mode3:Transmit at 2402MHz	

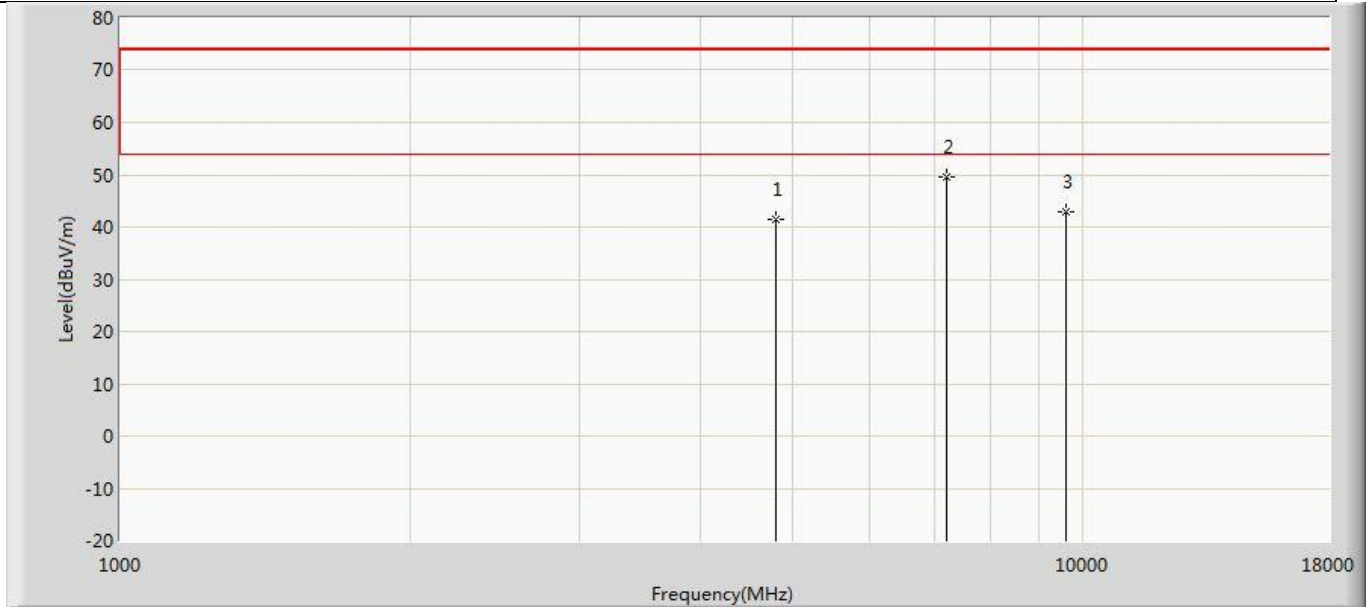

No	Mark	Frequency (MHz)	Measure Level (dBuV/m)	Reading Level (dBuV)	Over Limit (dB)	Limit (dBuV/m)	Factor (dB)	Type
1		4804.000	41.337	45.997	-32.663	74.000	-4.660	PK
2	*	7205.000	49.702	51.864	-24.298	74.000	-2.162	PK
3		9608.000	42.964	44.088	-31.036	74.000	-1.124	PK

Profile: 20B0023R	Page No.: 74
Engineer: Pawn	
Site: AC5	Time: 2020/11/17 - 21:13
Limit: FCC_Part15.209_RE(3m)	Margin: 0
Probe: Horn_3117_00167055(1-18GHz)	Polarity: Vertical
EUT: Digital Device	Power: 24 Vdc
Note: Mode3:Transmit at 2402MHz	

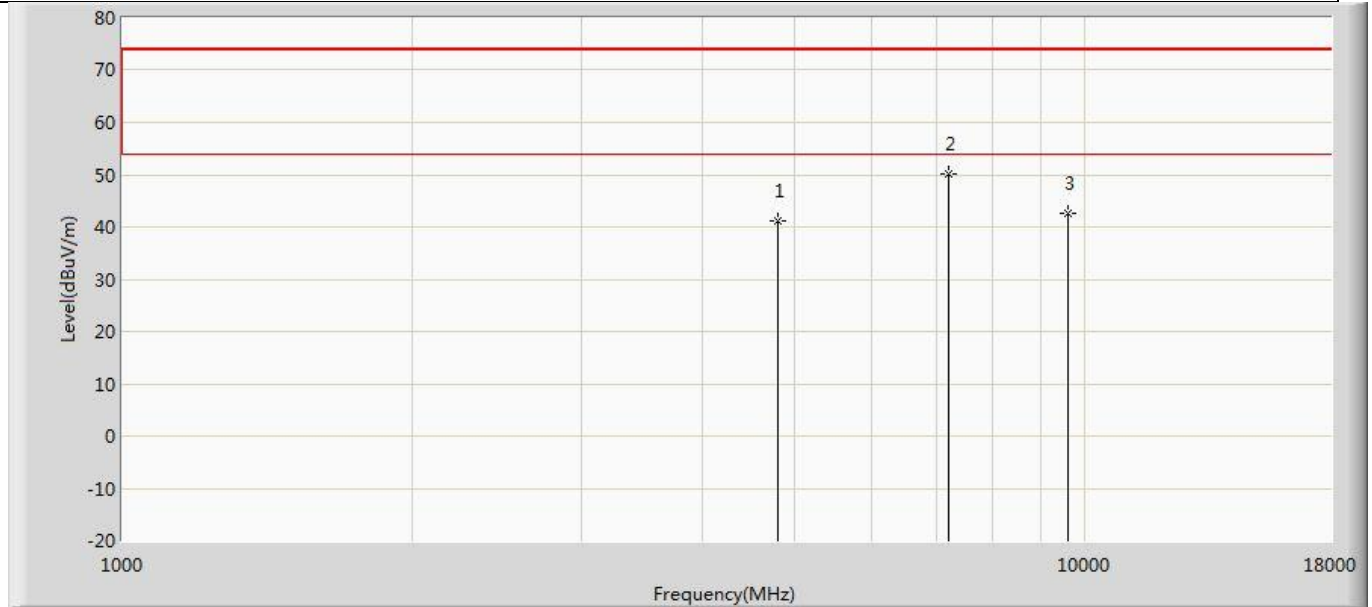

No	Mark	Frequency (MHz)	Measure Level (dBuV/m)	Reading Level (dBuV)	Over Limit (dB)	Limit (dBuV/m)	Factor (dB)	Type
1		4804.000	41.272	45.932	-32.728	74.000	-4.660	PK
2	*	7205.000	50.019	52.181	-23.981	74.000	-2.162	PK
3		9608.000	42.646	43.770	-31.354	74.000	-1.124	PK

Profile: 20B0023R	Page No.: 81
Engineer: Pawn	
Site: AC5	Time: 2020/11/17 - 21:13
Limit: FCC_Part15.209_RE(3m)	Margin: 0
Probe: Horn_3117_00167055(1-18GHz)	Polarity: Horizontal
EUT: Digital Device	Power: 24 Vdc
Note: Mode3:Transmit at 2440MHz	

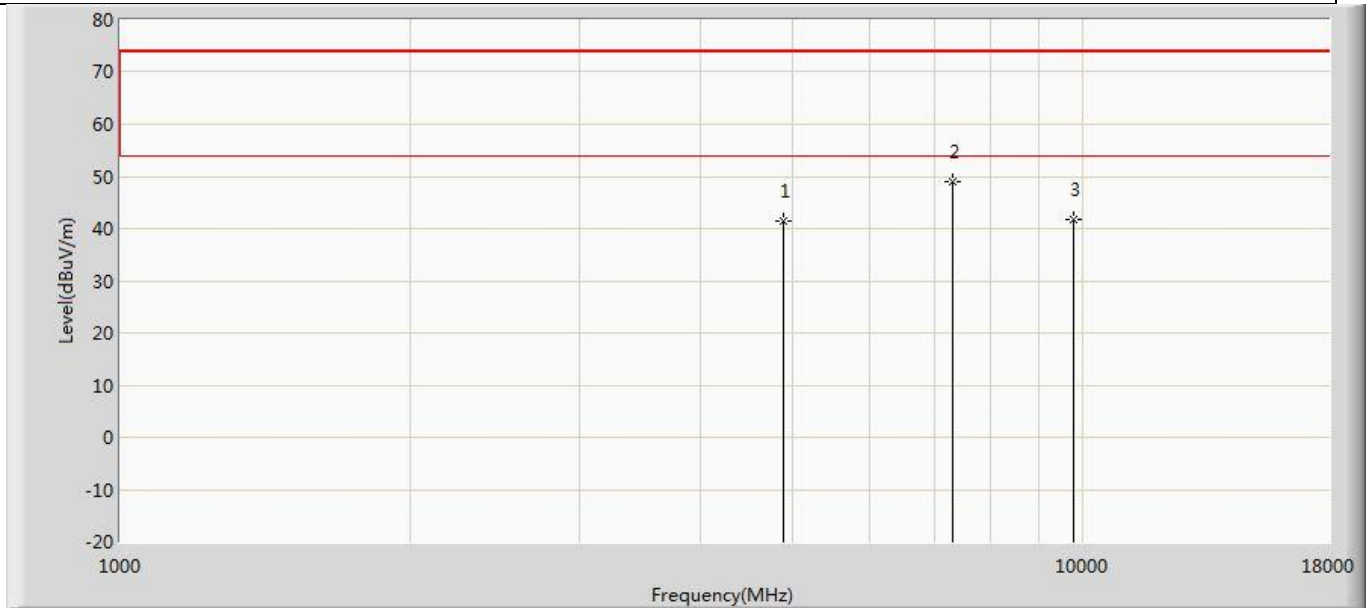

No	Mark	Frequency (MHz)	Measure Level (dBuV/m)	Reading Level (dBuV)	Over Limit (dB)	Limit (dBuV/m)	Factor (dB)	Type
1		4880.000	41.381	46.339	-32.619	74.000	-4.959	PK
2	*	7324.000	49.046	51.038	-24.954	74.000	-1.992	PK
3		9760.000	41.677	42.252	-32.323	74.000	-0.575	PK

Profile: 20B0023R	Page No.: 82
Engineer: Pawn	
Site: AC5	Time: 2020/11/17 - 21:14
Limit: FCC_Part15.209_RE(3m)	Margin: 0
Probe: Horn_3117_00167055(1-18GHz)	Polarity: Vertical
EUT: Digital Device	Power: 24 Vdc
Note: Mode3:Transmit at 2440MHz	

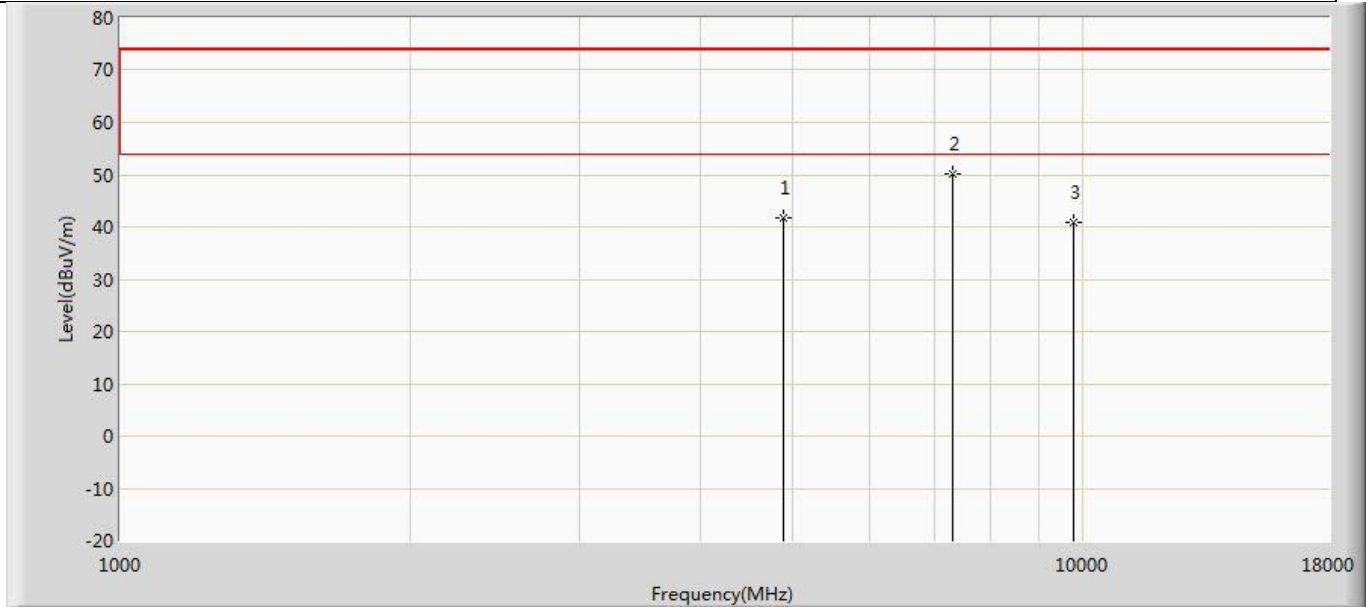

No	Mark	Frequency (MHz)	Measure Level (dBuV/m)	Reading Level (dBuV)	Over Limit (dB)	Limit (dBuV/m)	Factor (dB)	Type
1		4880.000	41.616	46.574	-32.384	74.000	-4.959	PK
2	*	7324.000	50.183	52.175	-23.817	74.000	-1.992	PK
3		9760.000	41.010	41.585	-32.990	74.000	-0.575	PK



Profile: 20B0023R	Page No.: 89
Engineer: Pawn	
Site: AC5	Time: 2020/11/17 - 21:14
Limit: FCC_Part15.209_RE(3m)	Margin: 0
Probe: Horn_3117_00167055(1-18GHz)	Polarity: Horizontal
EUT: Digital Device	Power: 24 Vdc
Note: Mode3:Transmit at 2480MHz	

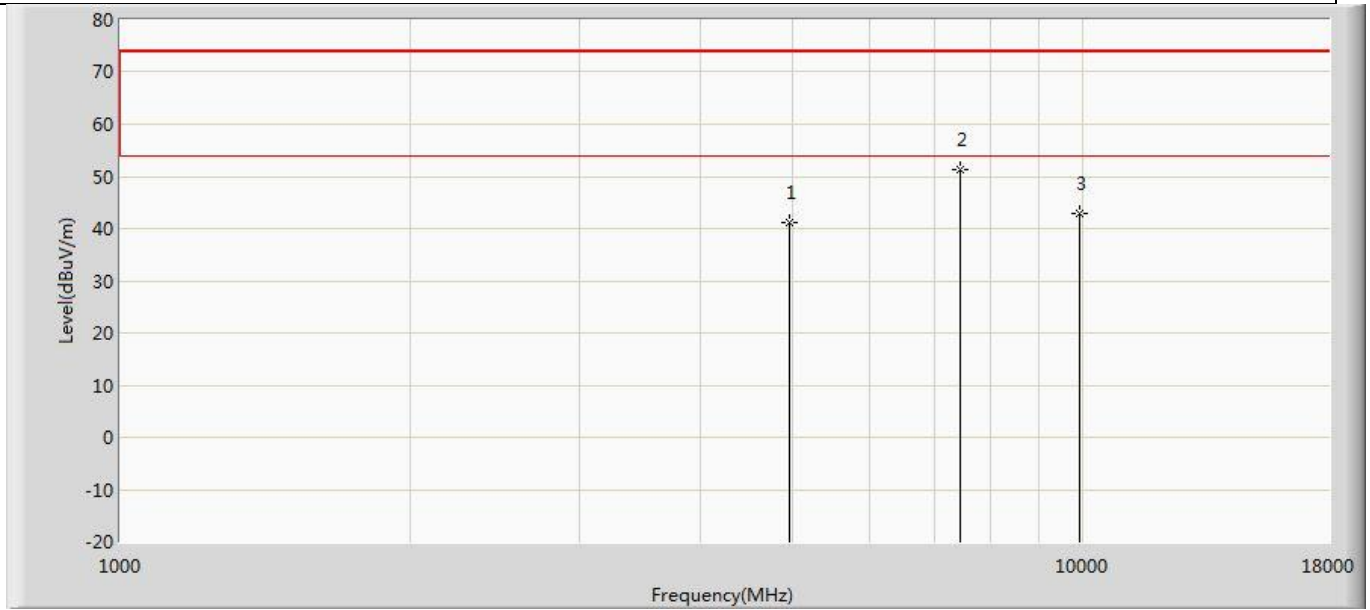

No	Mark	Frequency (MHz)	Measure Level (dBuV/m)	Reading Level (dBuV)	Over Limit (dB)	Limit (dBuV/m)	Factor (dB)	Type
1		4960.000	41.106	46.077	-32.894	74.000	-4.972	PK
2	*	7443.000	51.319	53.281	-22.681	74.000	-1.962	PK
3		9920.000	43.006	42.839	-30.994	74.000	0.167	PK

Profile: 20B0023R	Page No.: 90
Engineer: Pawn	
Site: AC5	Time: 2020/11/17 - 21:14
Limit: FCC_Part15.209_RE(3m)	Margin: 0
Probe: Horn_3117_00167055(1-18GHz)	Polarity: Vertical
EUT: Digital Device	Power: 24 Vdc
Note: Mode3:Transmit at 2480MHz	

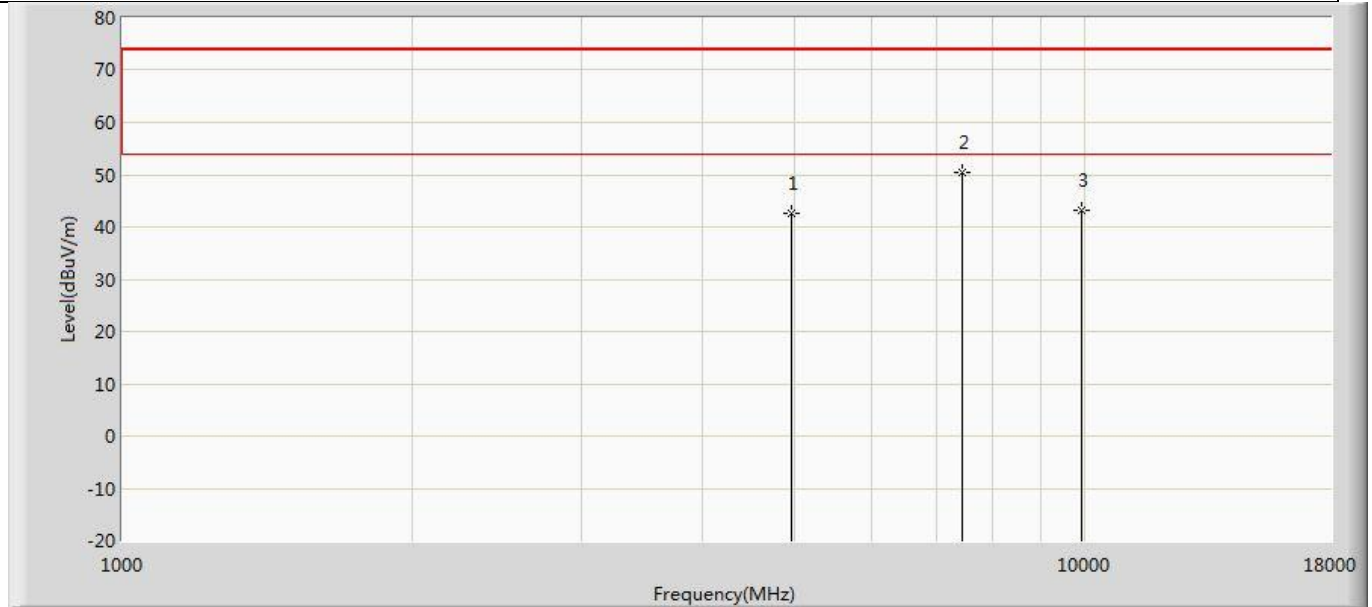

No	Mark	Frequency (MHz)	Measure Level (dBuV/m)	Reading Level (dBuV)	Over Limit (dB)	Limit (dBuV/m)	Factor (dB)	Type
1		4960.000	42.490	47.461	-31.510	74.000	-4.972	PK
2	*	7443.000	50.538	52.500	-23.462	74.000	-1.962	PK
3		9920.000	43.121	42.954	-30.879	74.000	0.167	PK

Profile: 20B0023R	Page No.: 71
Engineer: Pawn	
Site: AC5	Time: 2020/11/17 - 21:12
Limit: FCC_Part15.209_RE(3m)	Margin: 0
Probe: Horn_3117_00167055(1-18GHz)	Polarity: Horizontal
EUT: Digital Device	Power: 24 Vdc
Note: Mode4:Transmit at 2402MHz	

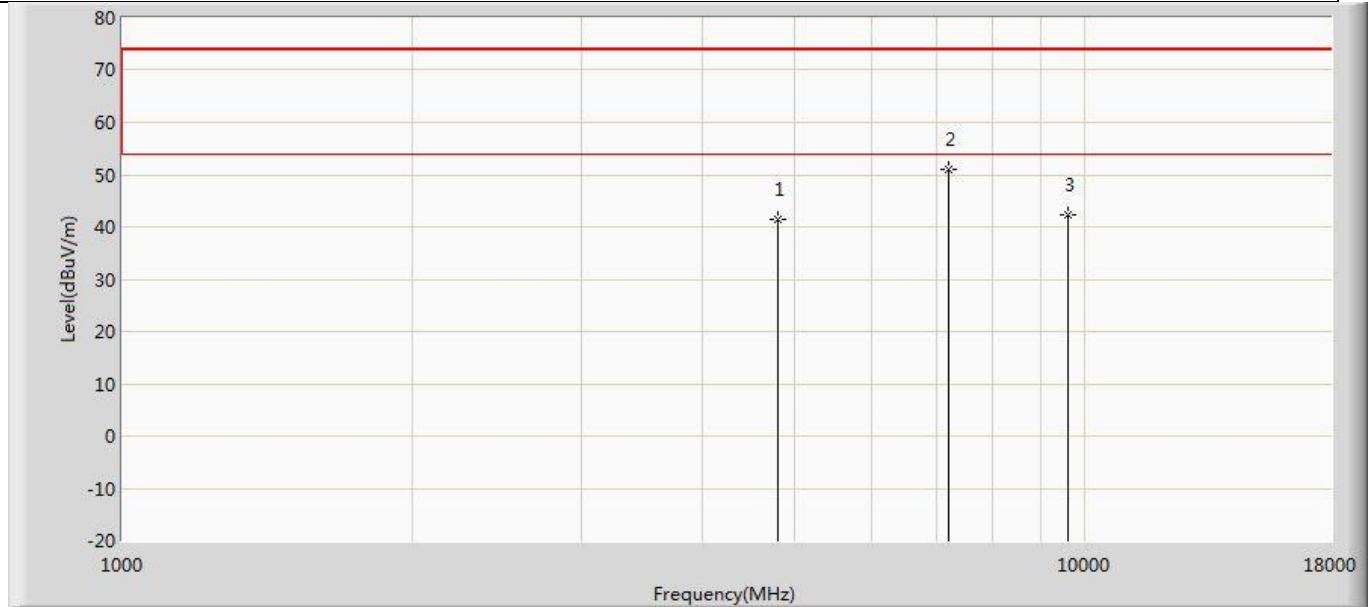

No	Mark	Frequency (MHz)	Measure Level (dBuV/m)	Reading Level (dBuV)	Over Limit (dB)	Limit (dBuV/m)	Factor (dB)	Type
1		4804.000	41.396	46.056	-32.604	74.000	-4.660	PK
2	*	7205.000	50.994	53.156	-23.006	74.000	-2.162	PK
3		9608.000	42.271	43.395	-31.729	74.000	-1.124	PK

Profile: 20B0023R	Page No.: 72
Engineer: Pawn	
Site: AC5	Time: 2020/11/17 - 21:13
Limit: FCC_Part15.209_RE(3m)	Margin: 0
Probe: Horn_3117_00167055(1-18GHz)	Polarity: Vertical
EUT: Digital Device	Power: 24 Vdc
Note: Mode4:Transmit at 2402MHz	

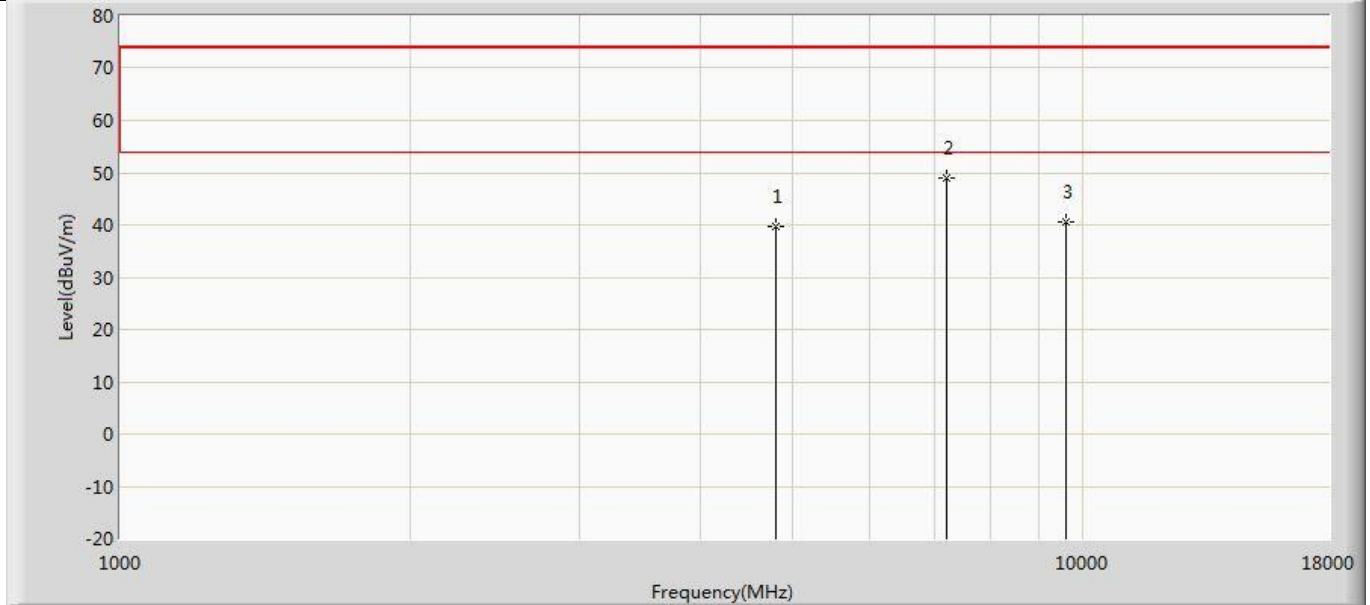

No	Mark	Frequency (MHz)	Measure Level (dBuV/m)	Reading Level (dBuV)	Over Limit (dB)	Limit (dBuV/m)	Factor (dB)	Type
1		4804.000	39.711	44.371	-34.289	74.000	-4.660	PK
2	*	7205.000	48.950	51.112	-25.050	74.000	-2.162	PK
3		9608.000	40.673	41.797	-33.327	74.000	-1.124	PK

Profile: 20B0023R	Page No.: 79
Engineer: Pawn	
Site: AC5	Time: 2020/11/17 - 21:13
Limit: FCC_Part15.209_RE(3m)	Margin: 0
Probe: Horn_3117_00167055(1-18GHz)	Polarity: Horizontal
EUT: Digital Device	Power: 24 Vdc
Note: Mode4:Transmit at 2440MHz	

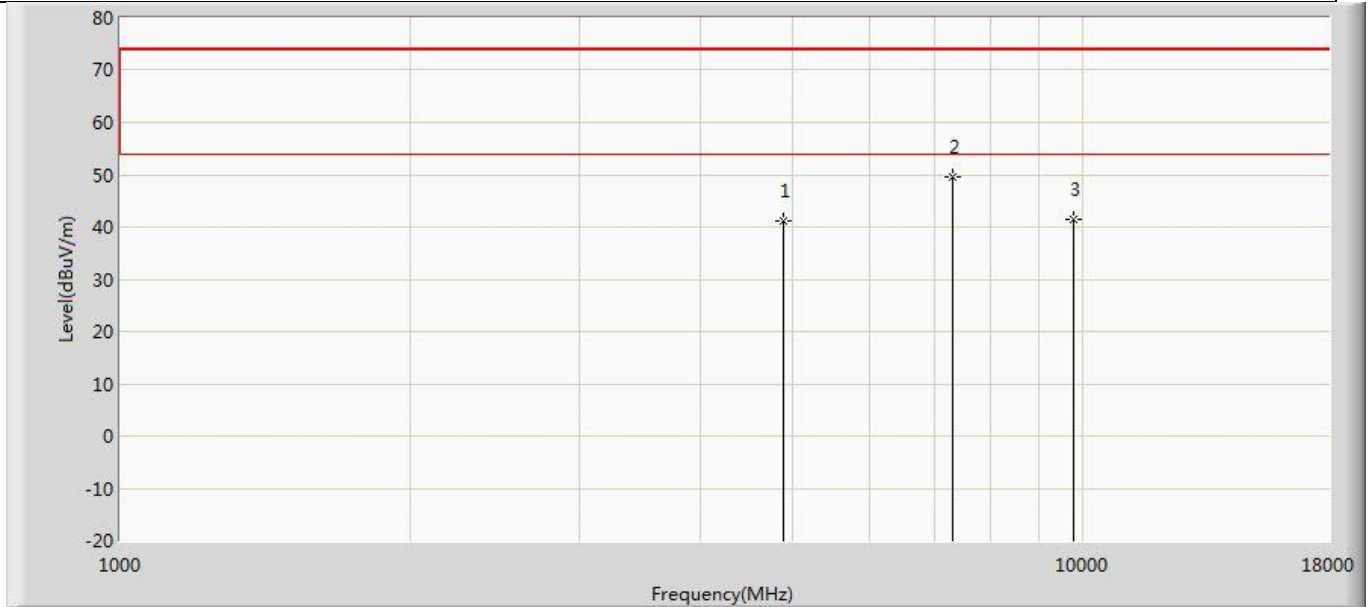

No	Mark	Frequency (MHz)	Measure Level (dBuV/m)	Reading Level (dBuV)	Over Limit (dB)	Limit (dBuV/m)	Factor (dB)	Type
1		4880.000	41.129	46.087	-32.871	74.000	-4.959	PK
2	*	7324.000	49.696	51.688	-24.304	74.000	-1.992	PK
3		9760.000	41.483	42.058	-32.517	74.000	-0.575	PK

Profile: 20B0023R	Page No.: 80
Engineer: Pawn	
Site: AC5	Time: 2020/11/17 - 21:13
Limit: FCC_Part15.209_RE(3m)	Margin: 0
Probe: Horn_3117_00167055(1-18GHz)	Polarity: Vertical
EUT: Digital Device	Power: 24 Vdc
Note: Mode4:Transmit at 2440MHz	

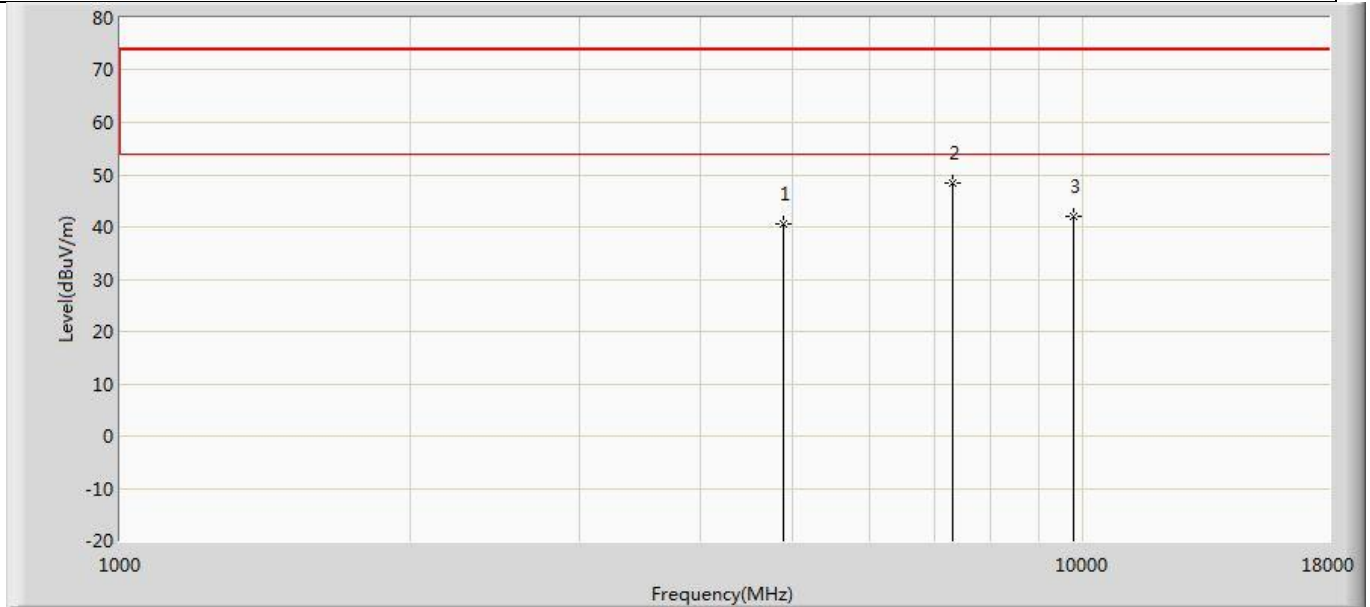

No	Mark	Frequency (MHz)	Measure Level (dBuV/m)	Reading Level (dBuV)	Over Limit (dB)	Limit (dBuV/m)	Factor (dB)	Type
1		4880.000	40.705	45.663	-33.295	74.000	-4.959	PK
2	*	7324.000	48.384	50.376	-25.616	74.000	-1.992	PK
3		9760.000	42.130	42.705	-31.870	74.000	-0.575	PK

Profile: 20B0023R	Page No.: 87
Engineer: Pawn	
Site: AC5	Time: 2020/11/17 - 21:14
Limit: FCC_Part15.209_RE(3m)	Margin: 0
Probe: Horn_3117_00167055(1-18GHz)	Polarity: Horizontal
EUT: Digital Device	Power: 24 Vdc
Note: Mode4:Transmit at 2480MHz	

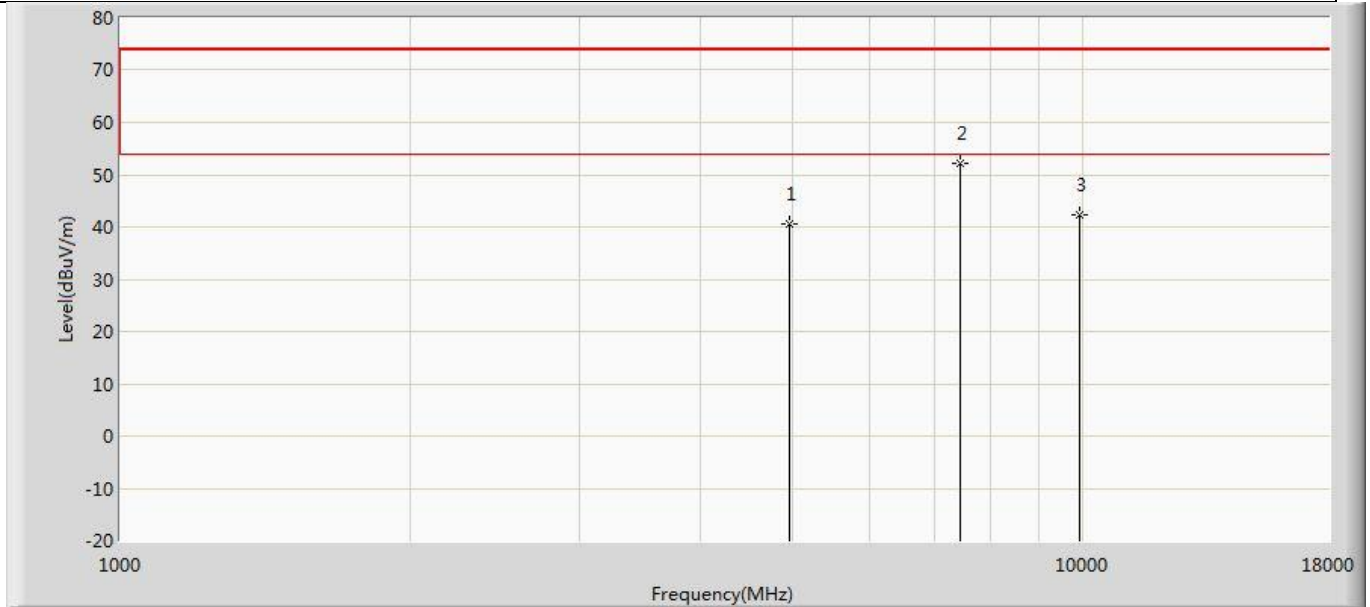

No	Mark	Frequency (MHz)	Measure Level (dBuV/m)	Reading Level (dBuV)	Over Limit (dB)	Limit (dBuV/m)	Factor (dB)	Type
1		4960.000	40.617	45.588	-33.383	74.000	-4.972	PK
2	*	7443.000	52.053	54.015	-21.947	74.000	-1.962	PK
3		9920.000	42.337	42.170	-31.663	74.000	0.167	PK

Profile: 20B0023R	Page No.: 88
Engineer: Pawn	
Site: AC5	Time: 2020/11/17 - 21:14
Limit: FCC_Part15.209_RE(3m)	Margin: 0
Probe: Horn_3117_00167055(1-18GHz)	Polarity: Vertical
EUT: Digital Device	Power: 24 Vdc
Note: Mode4:Transmit at 2480MHz	

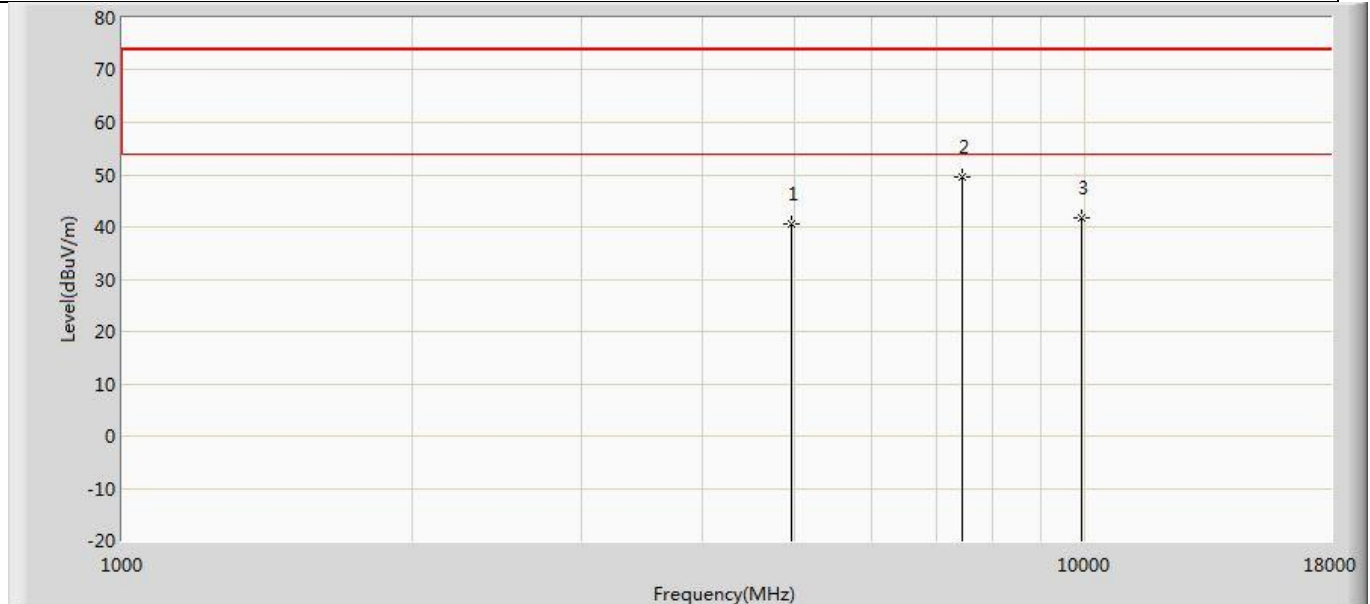

No	Mark	Frequency (MHz)	Measure Level (dBuV/m)	Reading Level (dBuV)	Over Limit (dB)	Limit (dBuV/m)	Factor (dB)	Type
1		4960.000	40.625	45.596	-33.375	74.000	-4.972	PK
2	*	7443.000	49.452	51.414	-24.548	74.000	-1.962	PK
3		9920.000	41.667	41.500	-32.333	74.000	0.167	PK

Note:

1. Measured Level = Reading Level + Factor.
2. The test frequency range, 9kHz~30MHz, 18GHz~26GHz, both of the worst case are at least 20dB below the limits, therefore no data appear in the report.
3. This limit applies for using average detector, if the test result on peak is lower than average limit, then average measurement needn't be performed.
4. As the radiated emission was performed, so conducted emission was not tested.



**The worst case of Radiated Emission below 1GHz:**

Profile: 20B0023R	Page No.: 5
Engineer: Pawn	
Site: AC2	Time: 2020/11/14 - 15:27
Limit: FCC_Part15.209_RE(3m)	Margin: 0
Probe: AC2_3M(30-1000M)	Polarity: Horizontal
EUT: Digital Device	Power: 24 Vdc
Note: Mode1	

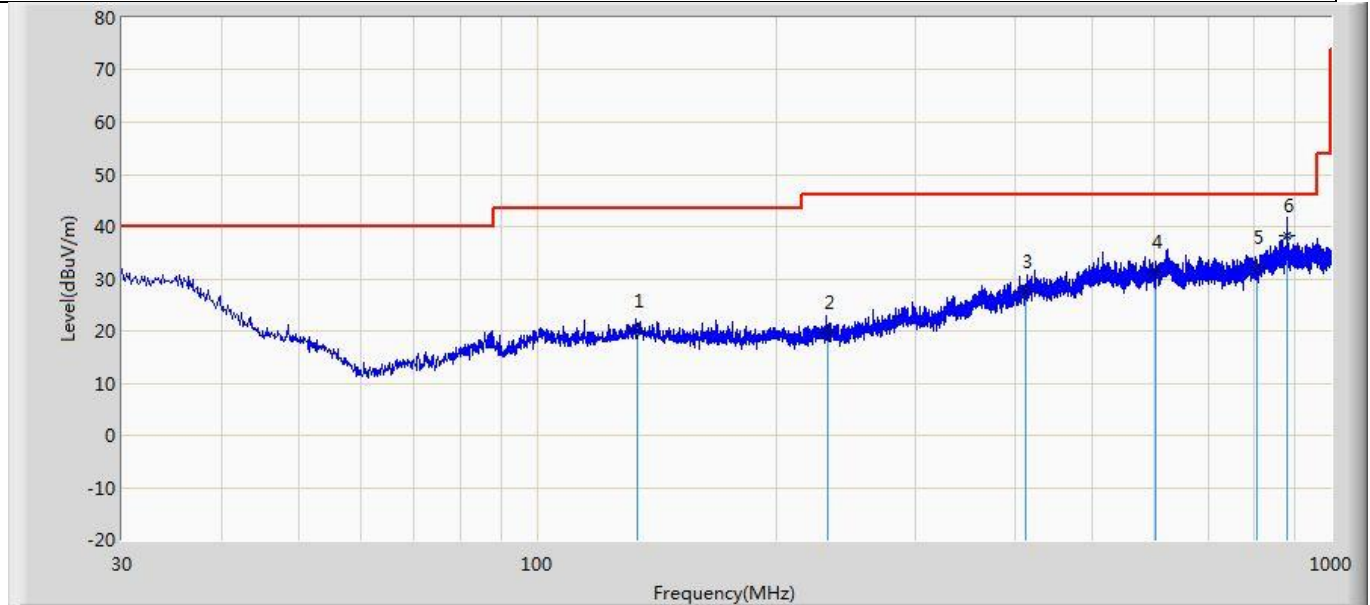

No	Mark	Frequency (MHz)	Measure Level (dBuV/m)	Reading Level (dBuV)	Over Limit (dB)	Limit (dBuV/m)	Factor (dB)	Type
1		133.548	19.978	2.286	-23.522	43.500	17.692	QP
2		231.881	19.667	1.729	-26.333	46.000	17.938	QP
3		412.422	27.677	1.747	-18.323	46.000	25.930	QP
4		602.664	31.405	2.331	-14.595	46.000	29.074	QP
5		805.151	32.077	2.258	-13.923	46.000	29.819	QP
6	*	879.841	38.370	5.980	-7.630	46.000	32.390	QP

Profile: 20B0023R	Page No.: 6
Engineer: Pawn	
Site: AC2	Time: 2020/11/14 - 15:35
Limit: FCC_Part15.209_RE(3m)	Margin: 0
Probe: AC2_3M(30-1000M)	Polarity: Vertical
EUT: Digital Device	Power: 24 Vdc
Note: Mode1	

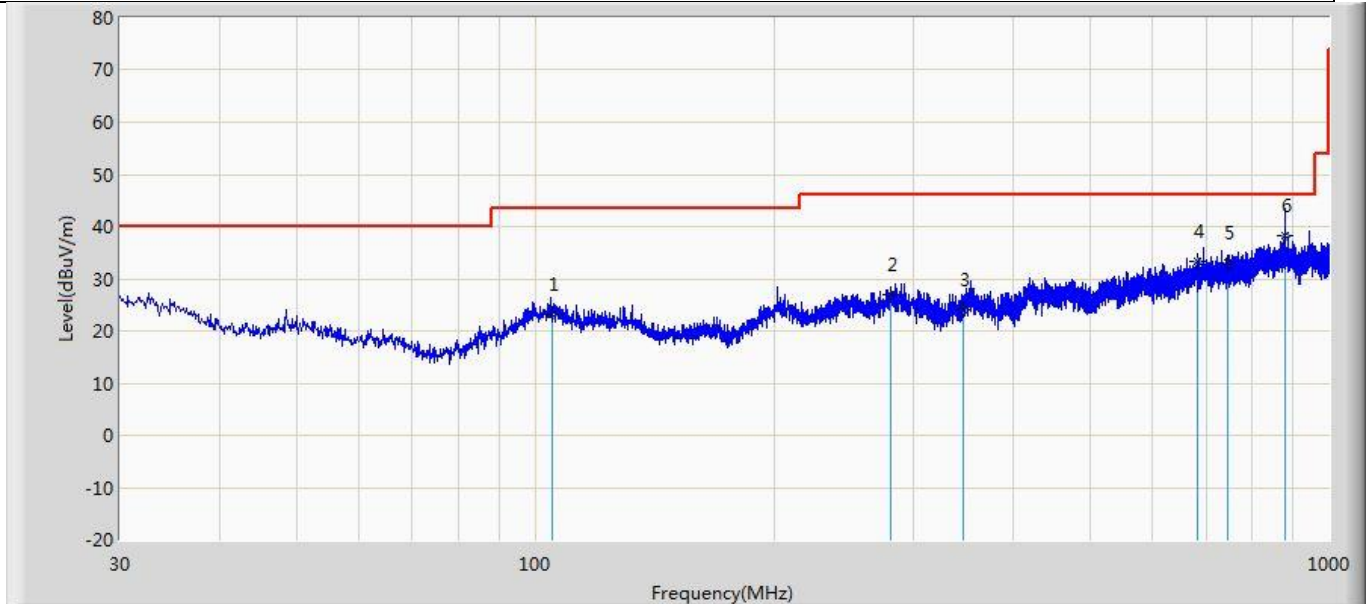

No	Mark	Frequency (MHz)	Measure Level (dBuV/m)	Reading Level (dBuV)	Over Limit (dB)	Limit (dBuV/m)	Factor (dB)	Type
1		104.933	23.236	1.017	-20.264	43.500	22.219	QP
2		280.745	27.019	2.081	-18.981	46.000	24.938	QP
3		345.856	23.919	-0.151	-22.081	46.000	24.069	QP
4		682.931	33.205	3.338	-12.795	46.000	29.866	QP
5		744.284	32.983	2.448	-13.017	46.000	30.536	QP
6	*	879.852	38.314	5.033	-7.686	46.000	33.281	QP

<b>4.3 Emissions in non-restricted frequency band</b>	<b>VERDICT: PASS</b>
---	----------------------

4.3.1 Limit	
Standard	FCC Part 15 Subpart C Paragraph 15.247(d)
RF Output power (Detection methods)	Limit(dB)
RF Output power(Average detector)	30dBc(Note1)
RF Output power(PK detector)	20dBc(Note2)
<p>Note 1: If maximum conducted (average) output power was used to demonstrate compliance as described in 9.2, then the peak power in any 100 kHz bandwidth outside of the authorized frequency band shall be attenuated by at least 30 dB relative to the maximum in-band peak PSD level in 100 kHz (i.e., 30 dBc).</p> <p>Note 2: If the maximum peak conducted output power procedure was used, then the peak output power measured in any 100 kHz bandwidth outside of the authorized frequency band shall be attenuated by at least 20 dB relative to the maximum in-band peak PSD level in 100 kHz (i.e., 20 dBc).</p>	

**4.3.2 Test Setup**

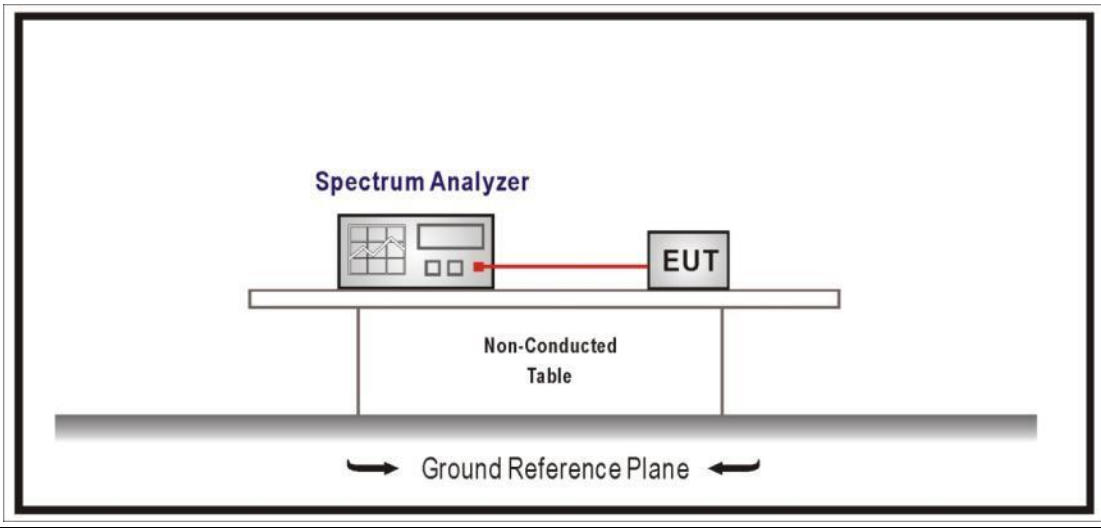

**4.3.3 Test Procedure**

References Rule	Chapter	Description
<input checked="" type="checkbox"/> ANSI C63.10	11.11	Emissions in non-restricted frequency bands
<input checked="" type="checkbox"/> ANSI C63.10	11.11.1	General
<input checked="" type="checkbox"/> ANSI C63.10	11.11.2	Reference level measurement
<input checked="" type="checkbox"/> ANSI C63.10	11.11.3	Emission level measurement

### 4.3.4 Test Data

Mode1/CH00/2402MHz



Mode1/CH39/2480MHz

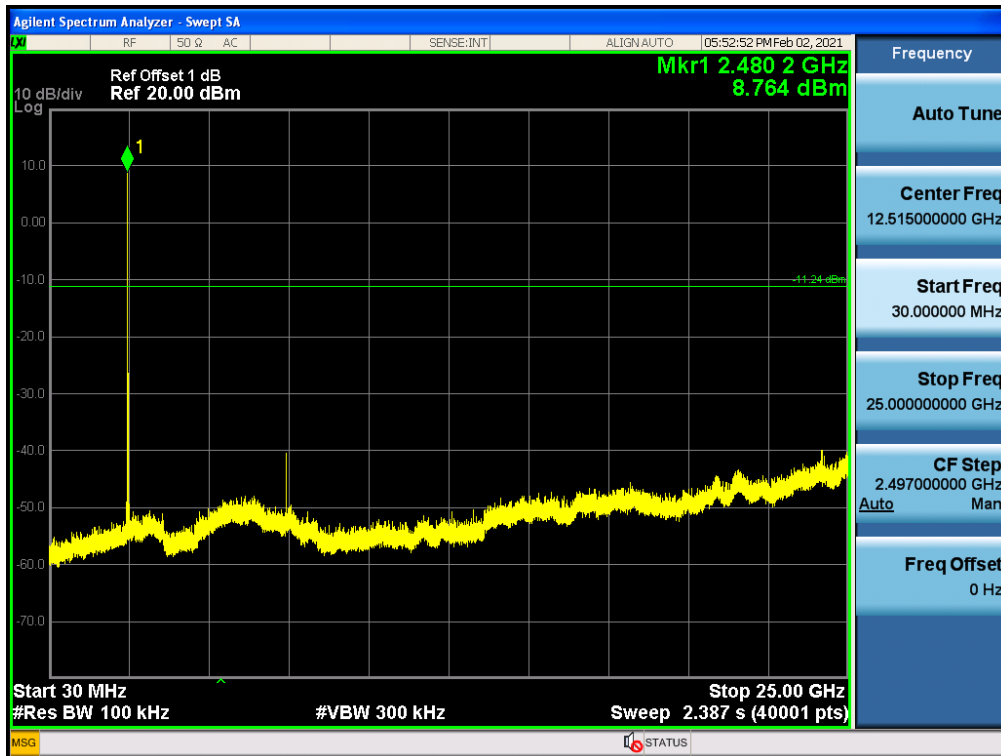

Mode2/CH00/2402MHz

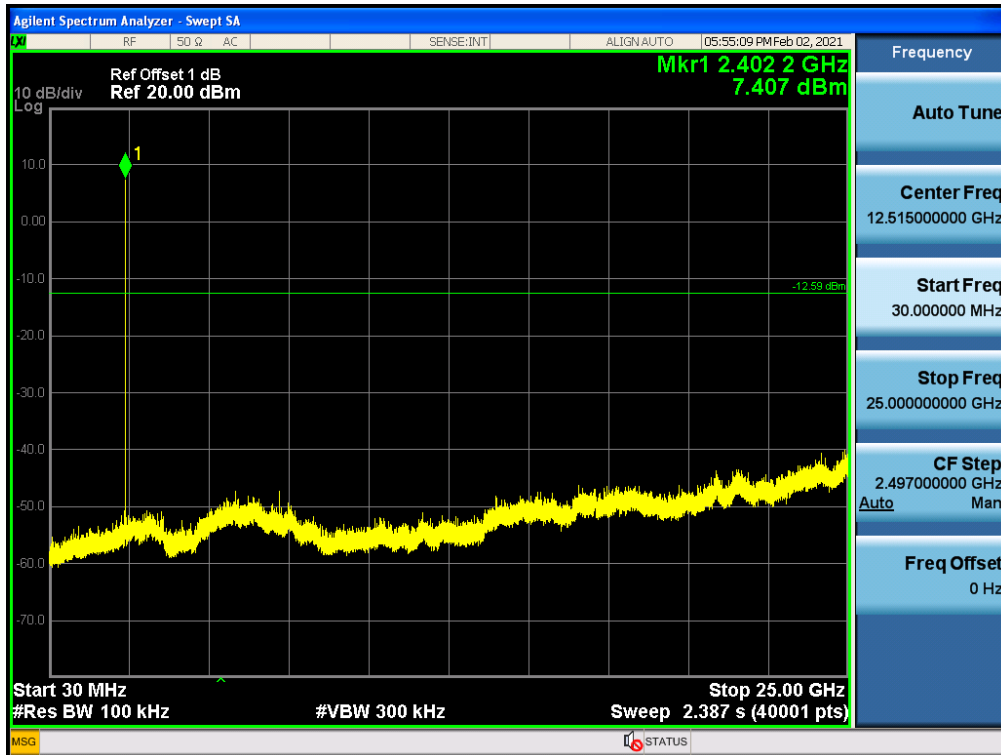

Mode2/CH39/2480MHz

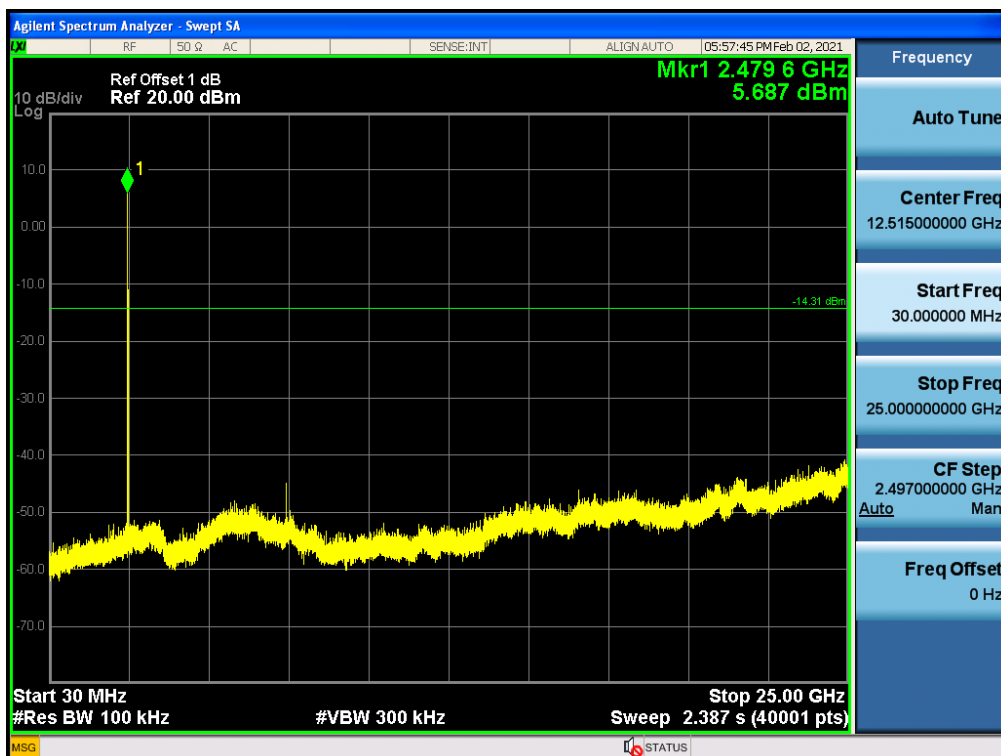

Mode3/CH00/2402MHz



Mode3/CH39/2480MHz

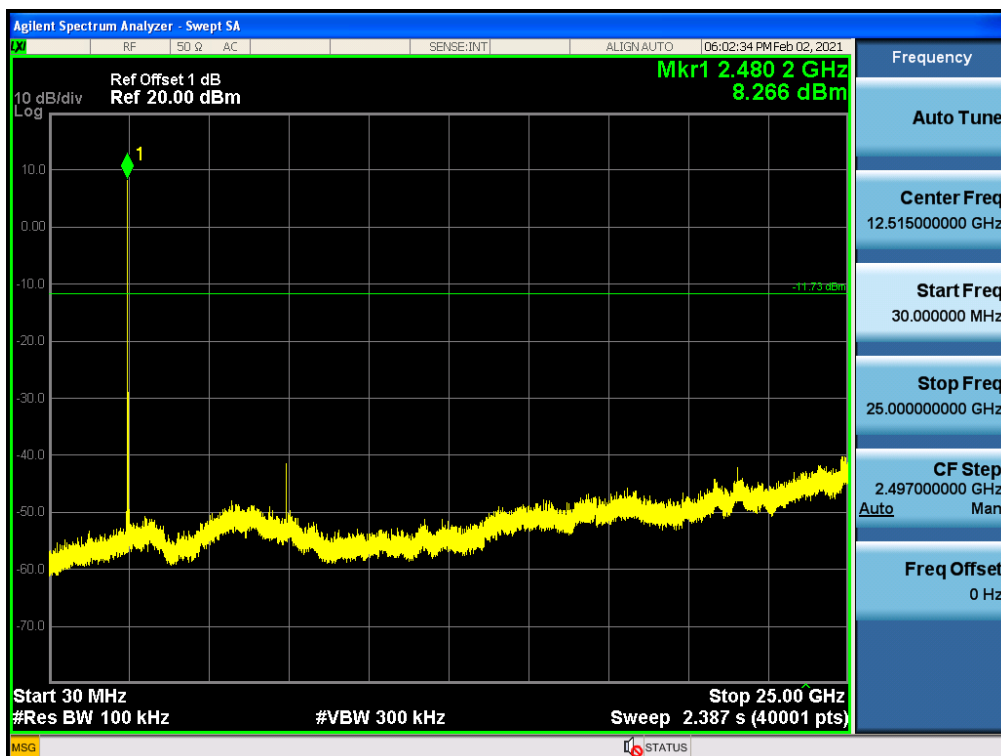

Mode4/CH00/2402MHz



Mode4/CH39/2480MHz

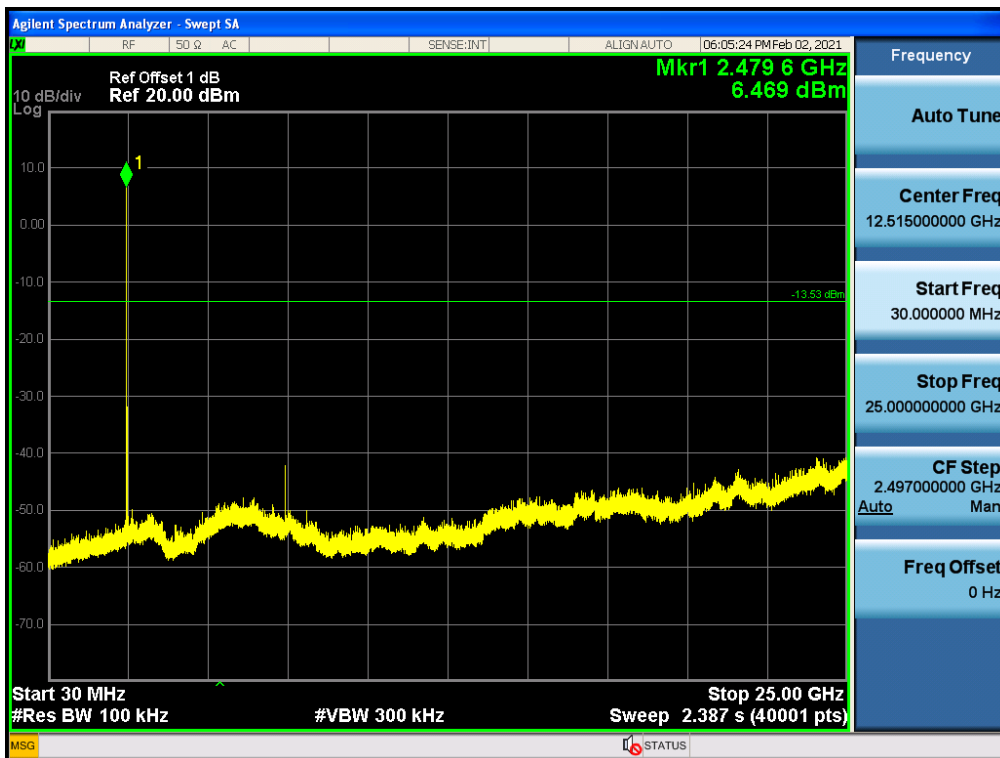

<b>4.4 Duty cycle</b>	<b>VERDICT: PASS</b>
-----------------------	----------------------

<b>4.4.1 Limit</b>
N/A

**4.4.2 Test Setup**

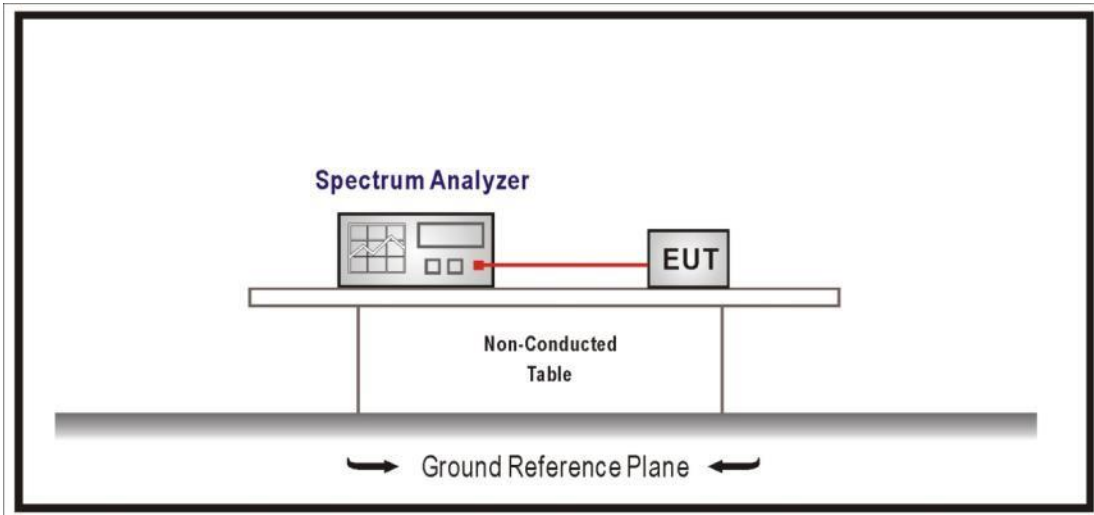

**4.4.3 Test Procedure**

References Rule	Chapter	Description
<input checked="" type="checkbox"/> ANSI C63.10	11.6	Duty cycle (D), transmission duration (T), and maximum power control level



#### 4.4.4 Test Data

Test Mode	Tx On (us)	Tx Off (us)	VBW (kHz)	Tx On + Tx Off (us)	Duty Cycle (%)
Mode 1	--	--	--	--	100
Mode 2	--	--	--	--	100
Mode 3	--	--	--	--	100
Mode 4	--	--	--	--	100

Note 1: T means the minimum transmission duration over which the transmitter is on and is transmitting at its maximum power control level for the tested mode of operation.

Note 2: According to KDB 558074, when test for Radiated Emission Band Edge and Radiated Emission, for average detector set:  $VBW \geq 1/T$  will be used.

Mode 1 CH19 2440MHz

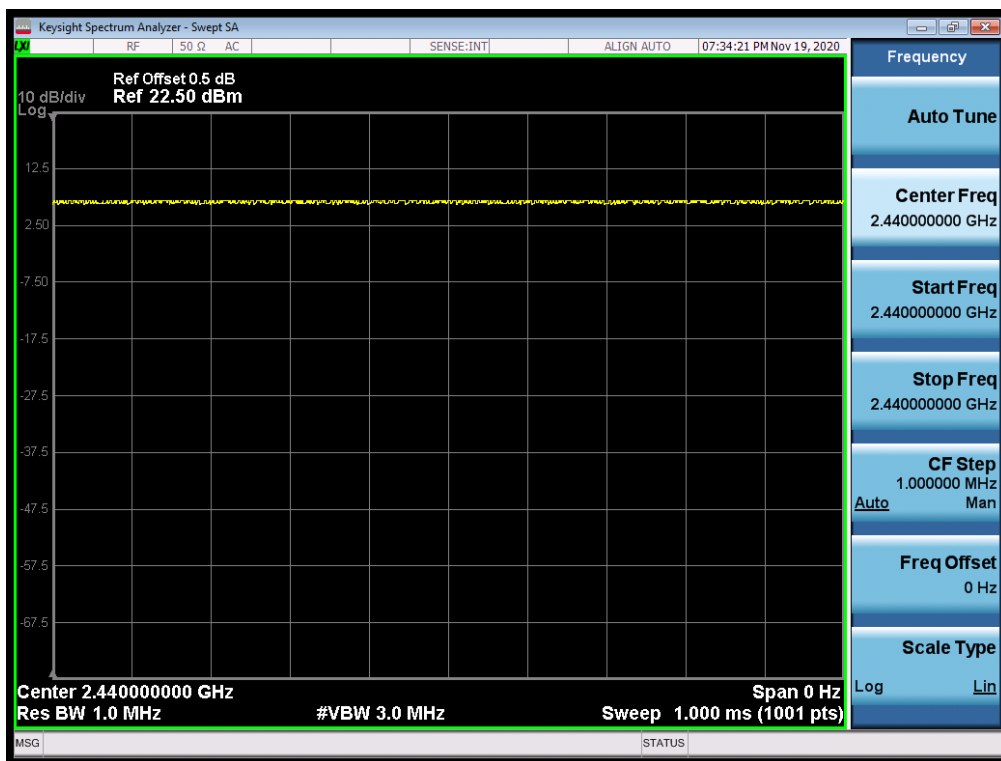

<b>4.5 Radiated Emission Band Edge</b>	<b>VERDICT: PASS</b>
--	----------------------

**4.5.1 Limit**

<b>Standard</b>		FCC Part 15 Subpart C Paragraph 15.247(d) , 15.209		
Frequency bands (MHz)	Detector	Limit (dBμV/m)	RBW (MHz)	Distance (m)
2310-2390	PK	74	1	3
2483.5-2500	AV	54	1	3

Note: The field strength of emissions appearing within these frequency bands shall not exceed the limits.

**4.5.2 Test Setup**

Above 1GHz Test Setup:

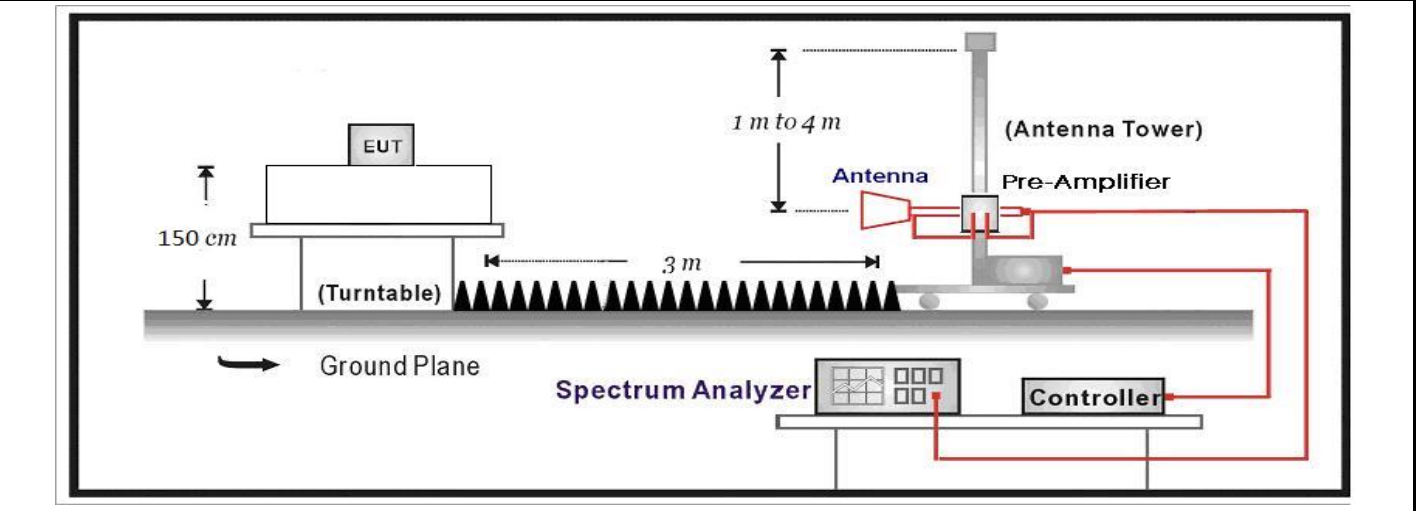

**4.5.3 Test Procedure**

	References Rule	Chapter	Description
<input checked="" type="checkbox"/>	ANSI C63.10	6.10	Band-edge testing
<input checked="" type="checkbox"/>	ANSI C63.10	6.10.5	Restricted-band band-edge measurements
<input type="checkbox"/>	ANSI C63.10	6.10.6	Marker-delta method
<input checked="" type="checkbox"/>	ANSI C63.10	11.12	Emissions in restricted frequency bands
<input checked="" type="checkbox"/>	ANSI C63.10	11.12.1	Radiated emission measurements
<input checked="" type="checkbox"/>	ANSI C63.10	11.12.2.7	Radiated spurious emission test
<input type="checkbox"/>	ANSI C63.10	6.4	Radiated emissions from unlicensed wireless devices below 30 MHz
<input type="checkbox"/>	ANSI C63.10	6.5	Radiated emissions from unlicensed wireless devices in the frequency range of 30 MHz to 1000 MHz
<input checked="" type="checkbox"/>	ANSI C63.10	6.6	Radiated emissions from unlicensed wireless devices above 1 GHz

**4.5.4 Test Data**

Profile: 20B0023R	Page No.: 1
Engineer: Pawn	
Site: AC5	Time: 2020/11/17 - 18:31
Limit: FCC_Part15.209_RE(3m)	Margin: 0
Probe: Horn_3117_00167055(1-18GHz)	Polarity: Vertical
EUT: Digital Device	Power: 24 Vdc
Note: Mode1:Transmit at 2402MHz	

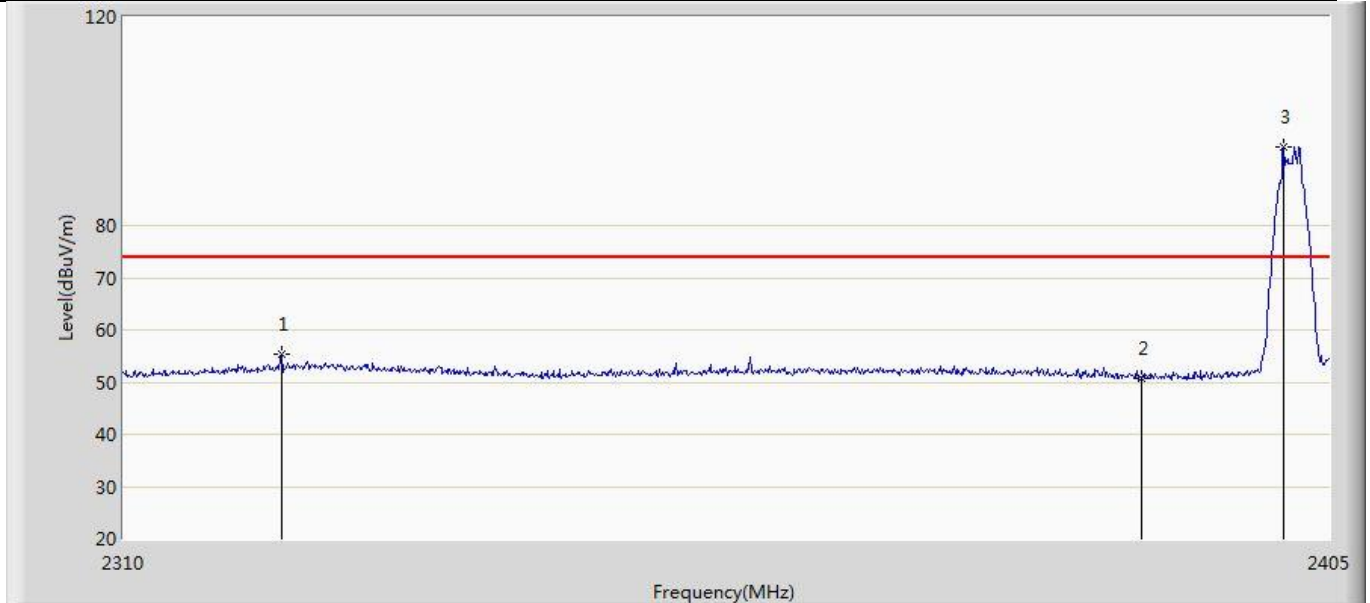

No	Mark	Frequency (MHz)	Measure Level (dBuV/m)	Reading Level (dBuV)	Over Limit (dB)	Limit (dBuV/m)	Factor (dB)	Type
1		2322.255	55.291	17.955	-18.709	74.000	37.335	PK
2		2390.000	50.823	15.079	-23.177	74.000	35.745	PK
3	*	2401.390	95.022	58.999	21.022	74.000	36.022	PK

Profile: 20B0023R	Page No.: 2
Engineer: Pawn	
Site: AC5	Time: 2020/11/17 - 18:38
Limit: FCC_Part15.209_RE(3m)	Margin: 0
Probe: Horn_3117_00167055(1-18GHz)	Polarity: Vertical
EUT: Digital Device	Power: 24 Vdc
Note: Mode1:Transmit at 2402MHz	

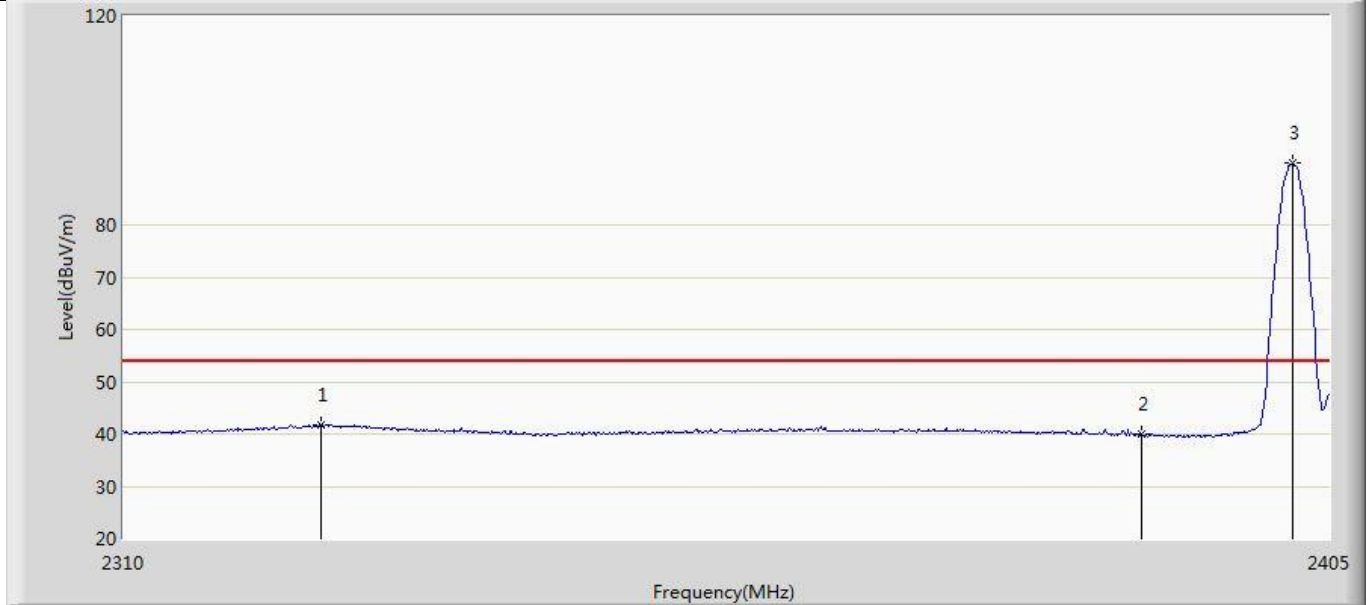

No	Mark	Frequency (MHz)	Measure Level (dBuV/m)	Reading Level (dBuV)	Over Limit (dB)	Limit (dBuV/m)	Factor (dB)	Type
1		2325.295	41.729	4.118	-12.271	54.000	37.611	AV
2		2390.000	39.981	4.237	-14.019	54.000	35.745	AV
3	*	2402.055	91.927	55.855	37.927	54.000	36.071	AV

Profile: 20B0023R	Page No.: 3
Engineer: Pawn	
Site: AC5	Time: 2020/11/17 - 18:42
Limit: FCC_Part15.209_RE(3m)	Margin: 0
Probe: Horn_3117_00167055(1-18GHz)	Polarity: Horizontal
EUT: Digital Device	Power: 24 Vdc
Note: Mode1:Transmit at 2402MHz	

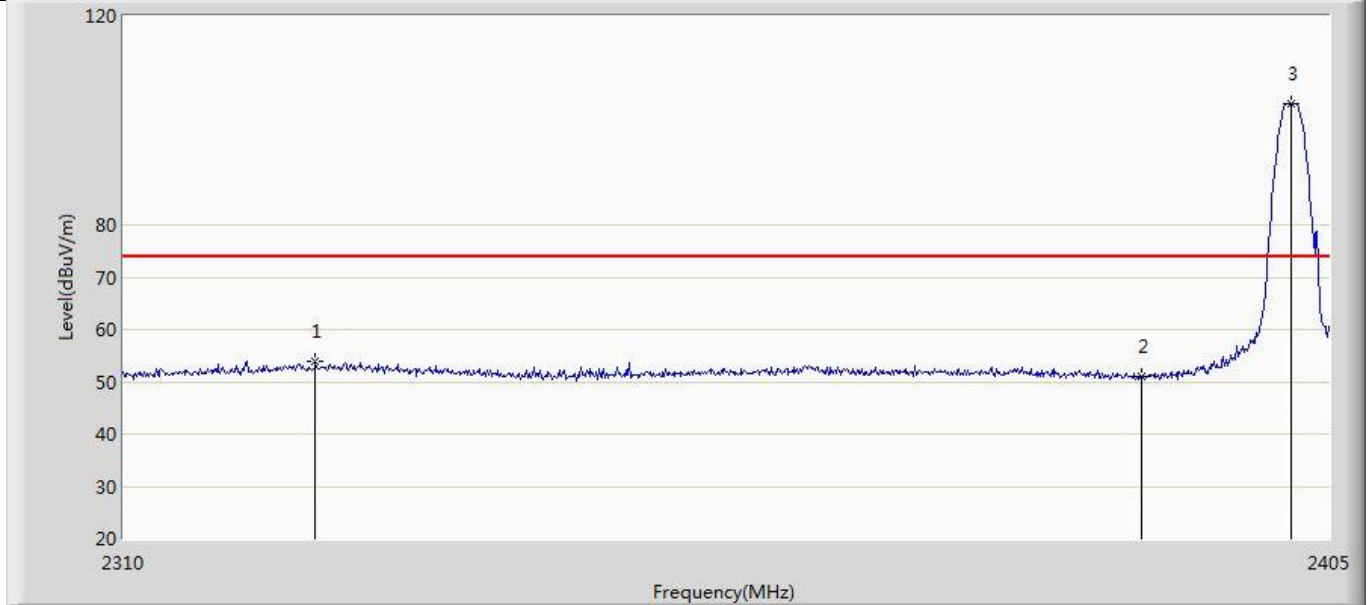

No	Mark	Frequency (MHz)	Measure Level (dBuV/m)	Reading Level (dBuV)	Over Limit (dB)	Limit (dBuV/m)	Factor (dB)	Type
1		2324.915	53.814	16.237	-20.186	74.000	37.576	PK
2		2390.000	51.081	15.337	-22.919	74.000	35.745	PK
3	*	2401.960	103.093	67.028	29.093	74.000	36.064	PK

Profile: 20B0023R	Page No.: 4
Engineer: Pawn	
Site: AC5	Time: 2020/11/17 - 18:45
Limit: FCC_Part15.209_RE(3m)	Margin: 0
Probe: Horn_3117_00167055(1-18GHz)	Polarity: Horizontal
EUT: Digital Device	Power: 24 Vdc
Note: Mode1:Transmit at 2402MHz	

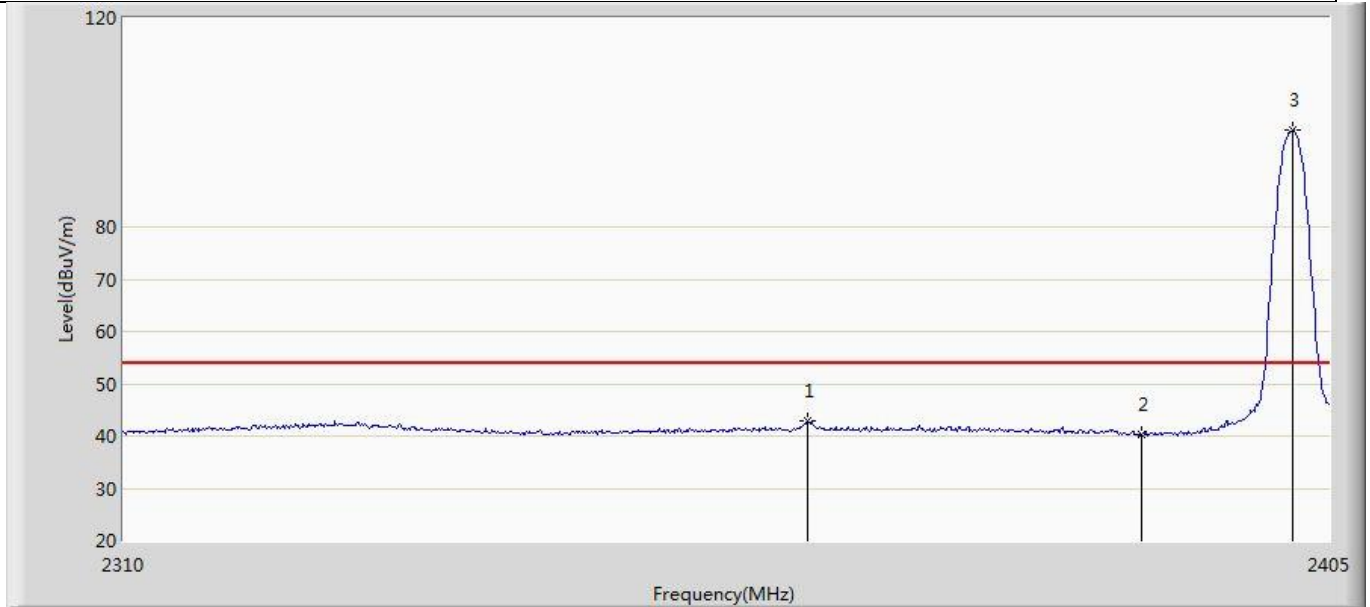

No	Mark	Frequency (MHz)	Measure Level (dBuV/m)	Reading Level (dBuV)	Over Limit (dB)	Limit (dBuV/m)	Factor (dB)	Type
1		2363.485	42.754	6.099	-11.246	54.000	36.656	AV
2		2390.000	40.316	4.572	-13.684	54.000	35.745	AV
3	*	2402.055	98.456	62.384	44.456	54.000	36.071	AV

Profile: 20B0023R	Page No.: 17
Engineer: Pawn	
Site: AC5	Time: 2020/11/17 - 19:15
Limit: FCC_Part15.209_RE(3m)	Margin: 0
Probe: Horn_3117_00167055(1-18GHz)	Polarity: Vertical
EUT: Digital Device	Power: 24 Vdc
Note: Mode1:Transmit at 2480MHz	

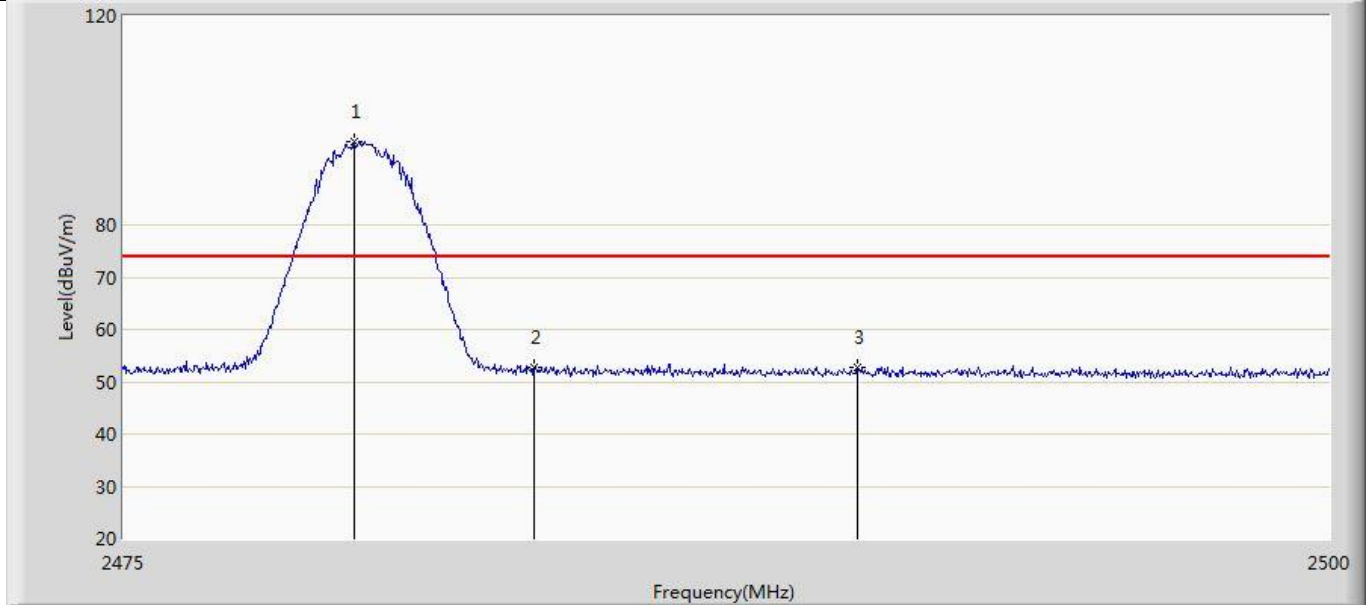

No	Mark	Frequency (MHz)	Measure Level (dBuV/m)	Reading Level (dBuV)	Over Limit (dB)	Limit (dBuV/m)	Factor (dB)	Type
1	*	2479.775	96.058	59.220	22.058	74.000	36.838	PK
2		2483.500	52.760	16.061	-21.240	74.000	36.699	PK
3		2490.200	52.784	16.334	-21.216	74.000	36.450	PK

Profile: 20B0023R	Page No.: 18
Engineer: Pawn	
Site: AC5	Time: 2020/11/17 - 19:17
Limit: FCC_Part15.209_RE(3m)	Margin: 0
Probe: Horn_3117_00167055(1-18GHz)	Polarity: Vertical
EUT: Digital Device	Power: 24 Vdc
Note: Mode1:Transmit at 2480MHz	

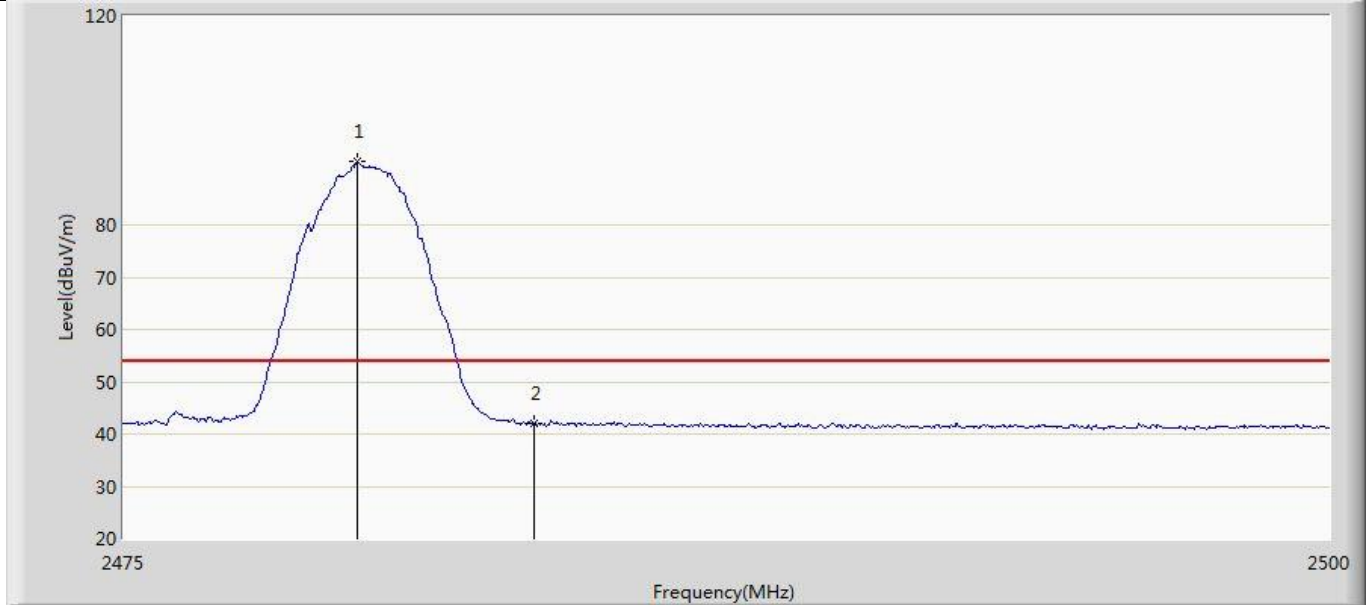

No	Mark	Frequency (MHz)	Measure Level (dBuV/m)	Reading Level (dBuV)	Over Limit (dB)	Limit (dBuV/m)	Factor (dB)	Type
1	*	2479.825	92.206	55.370	38.206	54.000	36.837	AV
2		2483.500	42.076	5.377	-11.924	54.000	36.699	AV



Profile: 20B0023R	Page No.: 19
Engineer: Pawn	
Site: AC5	Time: 2020/11/17 - 19:18
Limit: FCC_Part15.209_RE(3m)	Margin: 0
Probe: Horn_3117_00167055(1-18GHz)	Polarity: Horizontal
EUT: Digital Device	Power: 24 Vdc
Note: Mode1:Transmit at 2480MHz	

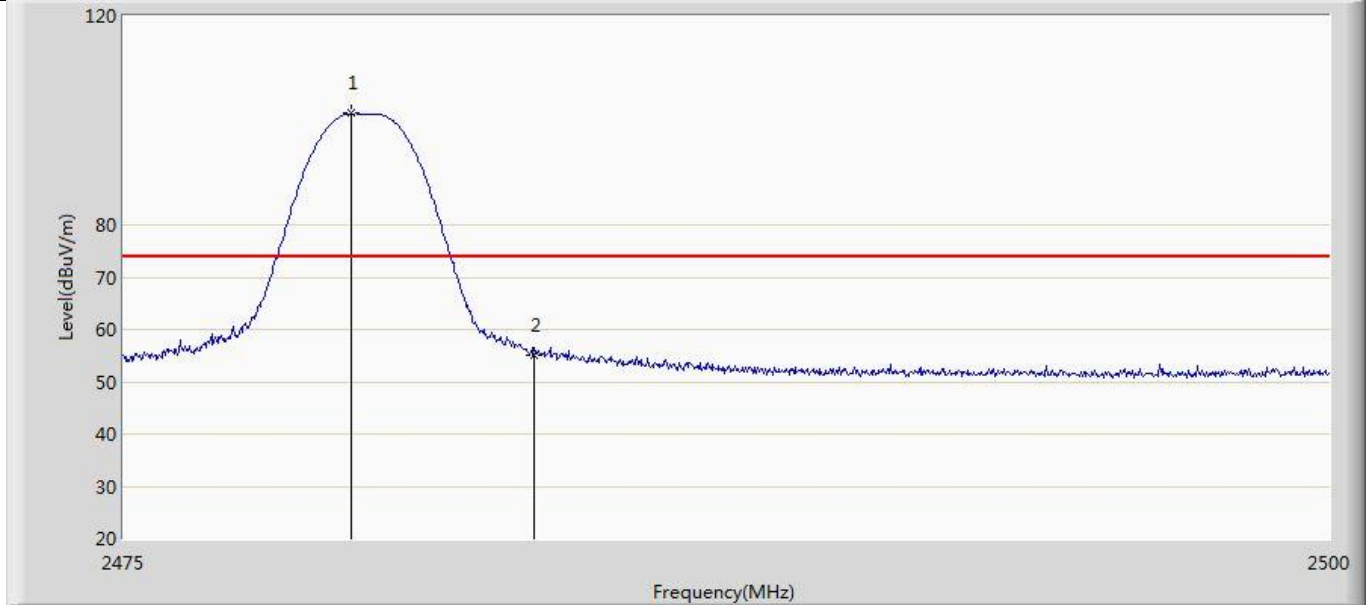

No	Mark	Frequency (MHz)	Measure Level (dBuV/m)	Reading Level (dBuV)	Over Limit (dB)	Limit (dBuV/m)	Factor (dB)	Type
1	*	2479.700	101.592	64.751	27.592	74.000	36.841	PK
2		2483.500	55.076	18.377	-18.924	74.000	36.699	PK

Profile: 20B0023R	Page No.: 20
Engineer: Pawn	
Site: AC5	Time: 2020/11/17 - 19:20
Limit: FCC_Part15.209_RE(3m)	Margin: 0
Probe: Horn_3117_00167055(1-18GHz)	Polarity: Horizontal
EUT: Digital Device	Power: 24 Vdc
Note: Mode1:Transmit at 2480MHz	

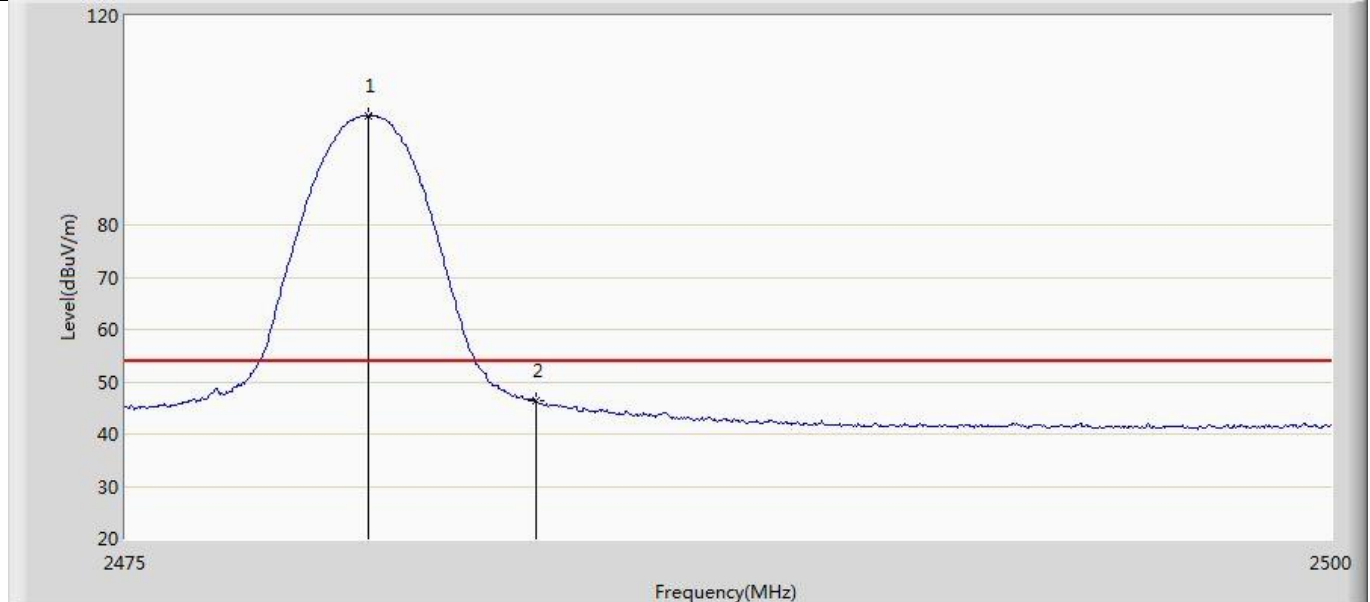

No	Mark	Frequency (MHz)	Measure Level (dBuV/m)	Reading Level (dBuV)	Over Limit (dB)	Limit (dBuV/m)	Factor (dB)	Type
1	*	2480.025	100.992	64.163	46.992	54.000	36.829	AV
2		2483.500	46.396	9.697	-7.604	54.000	36.699	AV

Profile: 20B0023R	Page No.: 5
Engineer: Pawn	
Site: AC5	Time: 2020/11/17 - 18:47
Limit: FCC_Part15.209_RE(3m)	Margin: 0
Probe: Horn_3117_00167055(1-18GHz)	Polarity: Vertical
EUT: Digital Device	Power: 24 Vdc

Note: Mode2:Transmit at 2402MHz

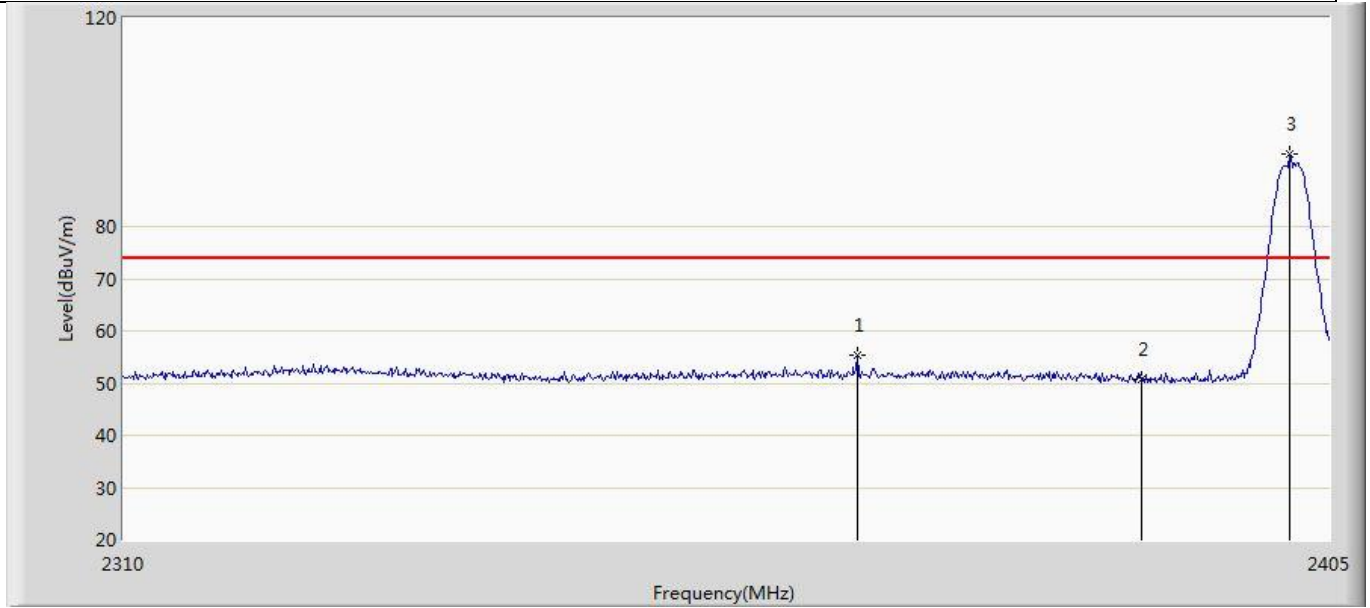

No	Mark	Frequency (MHz)	Measure Level (dBuV/m)	Reading Level (dBuV)	Over Limit (dB)	Limit (dBuV/m)	Factor (dB)	Type
1		2367.380	55.350	18.707	-18.650	74.000	36.643	PK
2		2390.000	50.769	15.025	-23.231	74.000	35.745	PK
3	*	2401.865	93.813	57.755	19.813	74.000	36.057	PK

Profile: 20B0023R	Page No.: 6
Engineer: Pawn	
Site: AC5	Time: 2020/11/17 - 18:49
Limit: FCC_Part15.209_RE(3m)	Margin: 0
Probe: Horn_3117_00167055(1-18GHz)	Polarity: Vertical
EUT: Digital Device	Power: 24 Vdc
Note: Mode2:Transmit at 2402MHz	

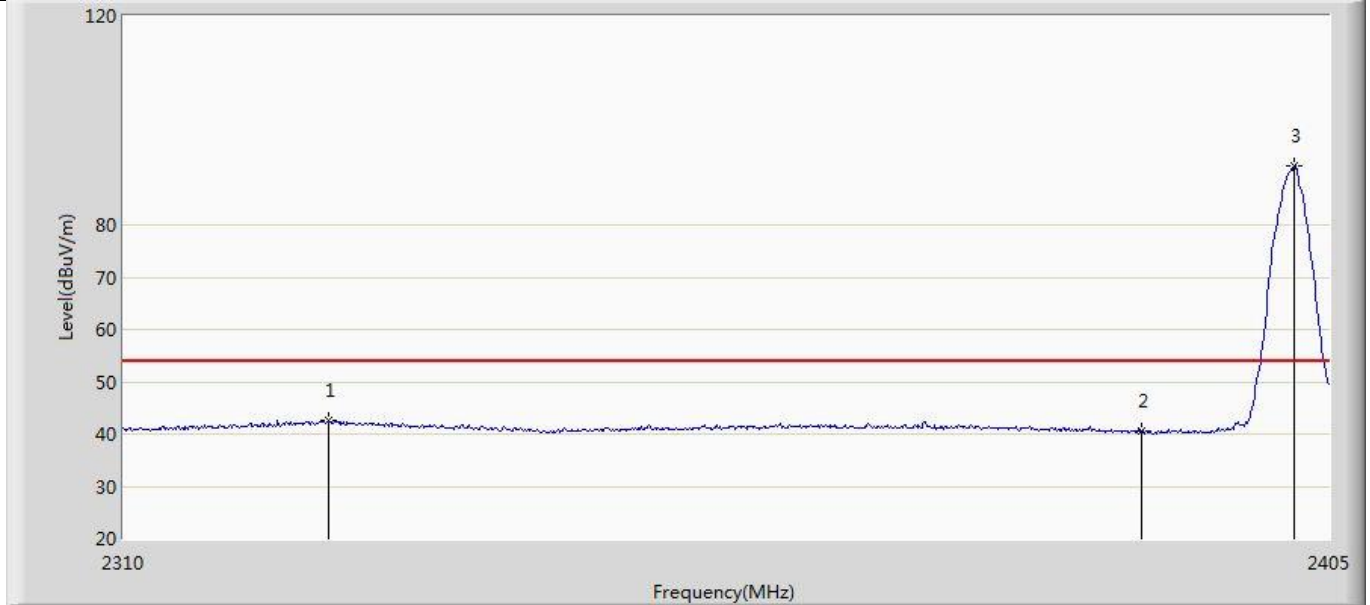

No	Mark	Frequency (MHz)	Measure Level (dBuV/m)	Reading Level (dBuV)	Over Limit (dB)	Limit (dBuV/m)	Factor (dB)	Type
1		2325.960	42.551	4.880	-11.449	54.000	37.671	AV
2		2390.000	40.436	4.692	-13.564	54.000	35.745	AV
3	*	2402.245	91.332	55.246	37.332	54.000	36.086	AV

Profile: 20B0023R	Page No.: 7
Engineer: Pawn	
Site: AC5	Time: 2020/11/17 - 18:51
Limit: FCC_Part15.209_RE(3m)	Margin: 0
Probe: Horn_3117_00167055(1-18GHz)	Polarity: Horizontal
EUT: Digital Device	Power: 24 Vdc
Note: Mode2:Transmit at 2402MHz	

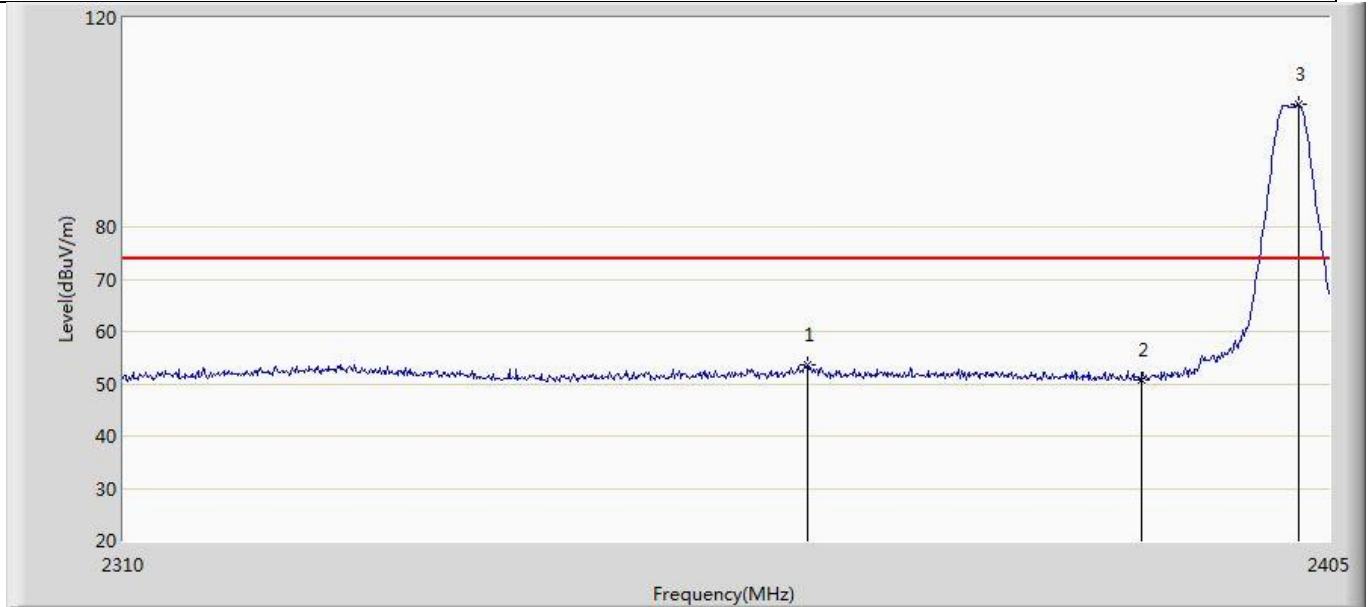

No	Mark	Frequency (MHz)	Measure Level (dBuV/m)	Reading Level (dBuV)	Over Limit (dB)	Limit (dBuV/m)	Factor (dB)	Type
1		2363.485	53.539	16.884	-20.461	74.000	36.656	PK
2		2390.000	50.819	15.075	-23.181	74.000	35.745	PK
3	*	2402.530	103.389	67.282	29.389	74.000	36.107	PK

Profile: 20B0023R	Page No.: 8
Engineer: Pawn	
Site: AC5	Time: 2020/11/17 - 18:53
Limit: FCC_Part15.209_RE(3m)	Margin: 0
Probe: Horn_3117_00167055(1-18GHz)	Polarity: Horizontal
EUT: Digital Device	Power: 24 Vdc
Note: Mode2:Transmit at 2402MHz	

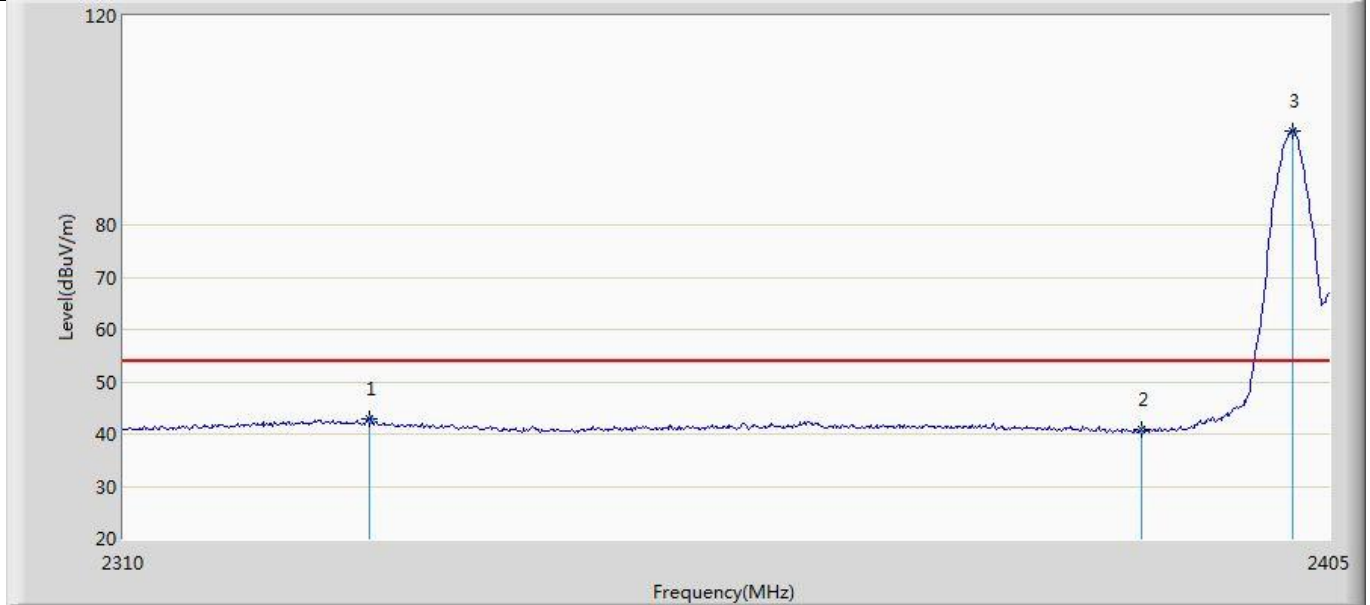

No	Mark	Frequency (MHz)	Measure Level (dBuV/m)	Reading Level (dBuV)	Over Limit (dB)	Limit (dBuV/m)	Factor (dB)	Type
1		2329.095	43.012	5.648	-30.988	74.000	37.364	PK
2		2390.000	40.730	4.986	-33.270	74.000	35.745	PK
3	*	2402.055	97.963	61.891	23.963	74.000	36.071	PK

Profile: 20B0023R	Page No.: 21
Engineer: Pawn	
Site: AC5	Time: 2020/11/17 - 19:22
Limit: FCC_Part15.209_RE(3m)	Margin: 0
Probe: Horn_3117_00167055(1-18GHz)	Polarity: Vertical
EUT: Digital Device	Power: 24 Vdc
Note: Mode2:Transmit at 2480MHz	

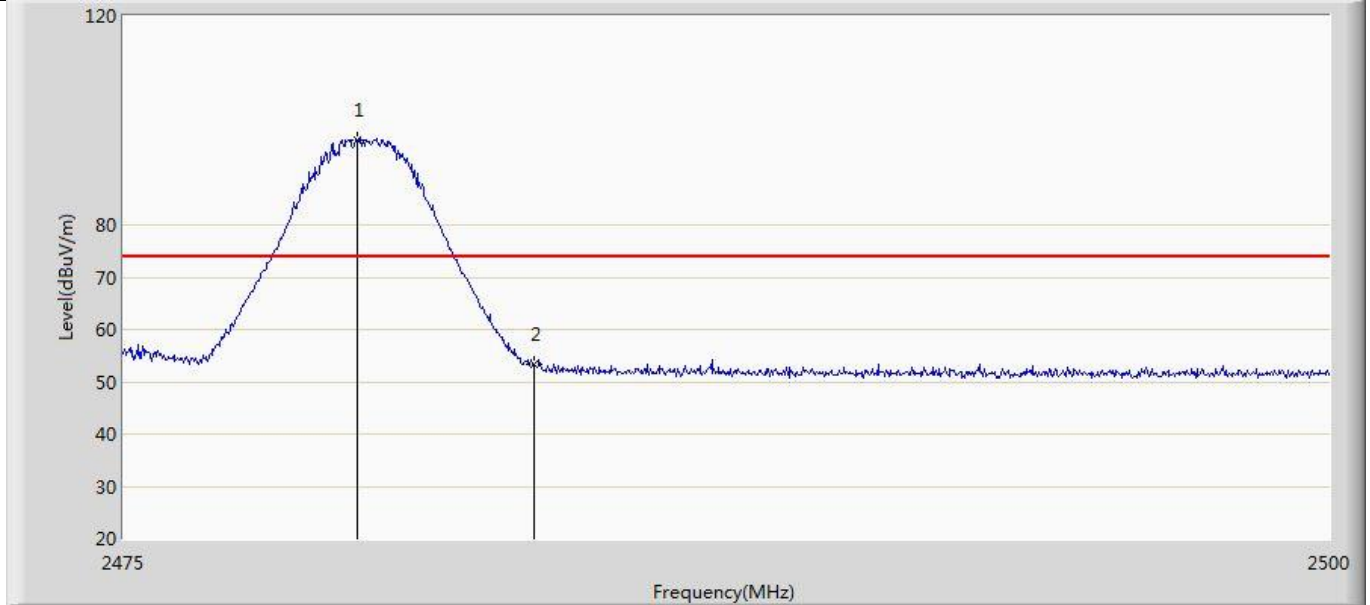

No	Mark	Frequency (MHz)	Measure Level (dBuV/m)	Reading Level (dBuV)	Over Limit (dB)	Limit (dBuV/m)	Factor (dB)	Type
1	*	2479.850	96.307	59.472	22.307	74.000	36.836	PK
2		2483.500	53.426	16.727	-20.574	74.000	36.699	PK

Profile: 20B0023R	Page No.: 22
Engineer: Pawn	
Site: AC5	Time: 2020/11/17 - 19:24
Limit: FCC_Part15.209_RE(3m)	Margin: 0
Probe: Horn_3117_00167055(1-18GHz)	Polarity: Vertical
EUT: Digital Device	Power: 24 Vdc
Note: Mode2:Transmit at 2480MHz	

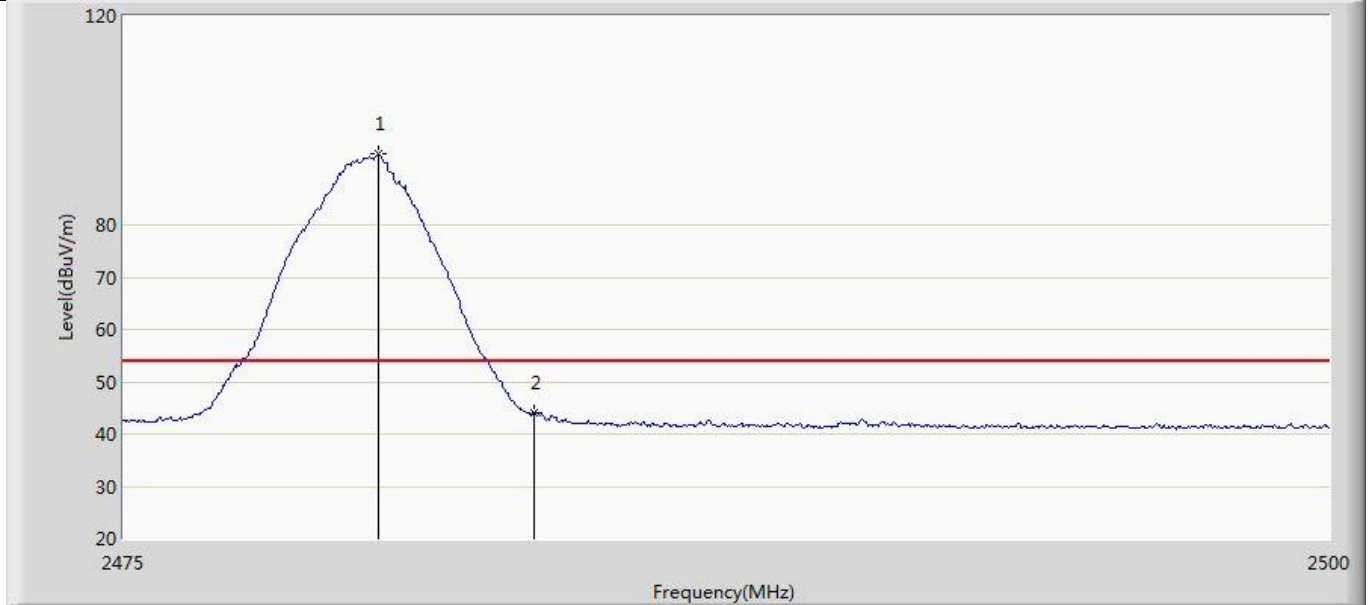

No	Mark	Frequency (MHz)	Measure Level (dBuV/m)	Reading Level (dBuV)	Over Limit (dB)	Limit (dBuV/m)	Factor (dB)	Type
1	*	2480.275	93.487	56.667	39.487	54.000	36.820	AV
2		2483.500	43.947	7.248	-10.053	54.000	36.699	AV



Profile: 20B0023R	Page No.: 23
Engineer: Pawn	
Site: AC5	Time: 2020/11/17 - 19:25
Limit: FCC_Part15.209_RE(3m)	Margin: 0
Probe: Horn_3117_00167055(1-18GHz)	Polarity: Horizontal
EUT: Digital Device	Power: 24 Vdc
Note: Mode2:Transmit at 2480MHz	

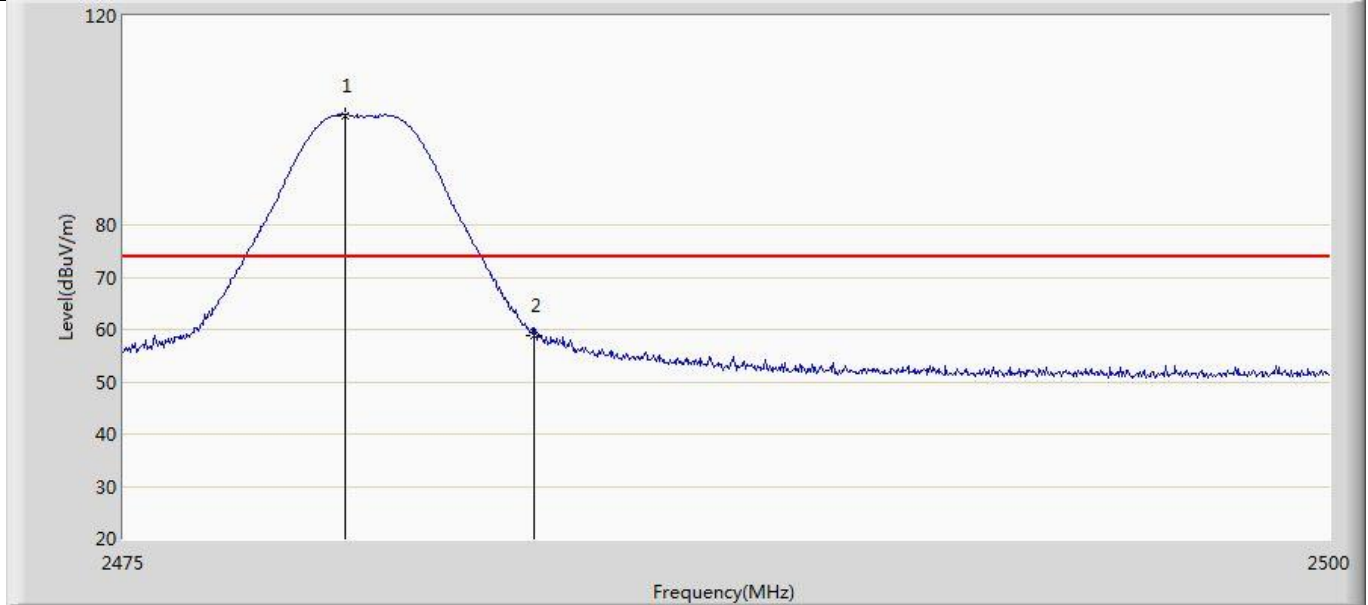

No	Mark	Frequency (MHz)	Measure Level (dBuV/m)	Reading Level (dBuV)	Over Limit (dB)	Limit (dBuV/m)	Factor (dB)	Type
1	*	2479.600	100.994	64.149	26.994	74.000	36.845	PK
2		2483.500	58.934	22.235	-15.066	74.000	36.699	PK

Profile: 20B0023R	Page No.: 24
Engineer: Pawn	
Site: AC5	Time: 2020/11/17 - 19:27
Limit: FCC_Part15.209_RE(3m)	Margin: 0
Probe: Horn_3117_00167055(1-18GHz)	Polarity: Horizontal
EUT: Digital Device	Power: 24 Vdc
Note: Mode2:Transmit at 2480MHz	

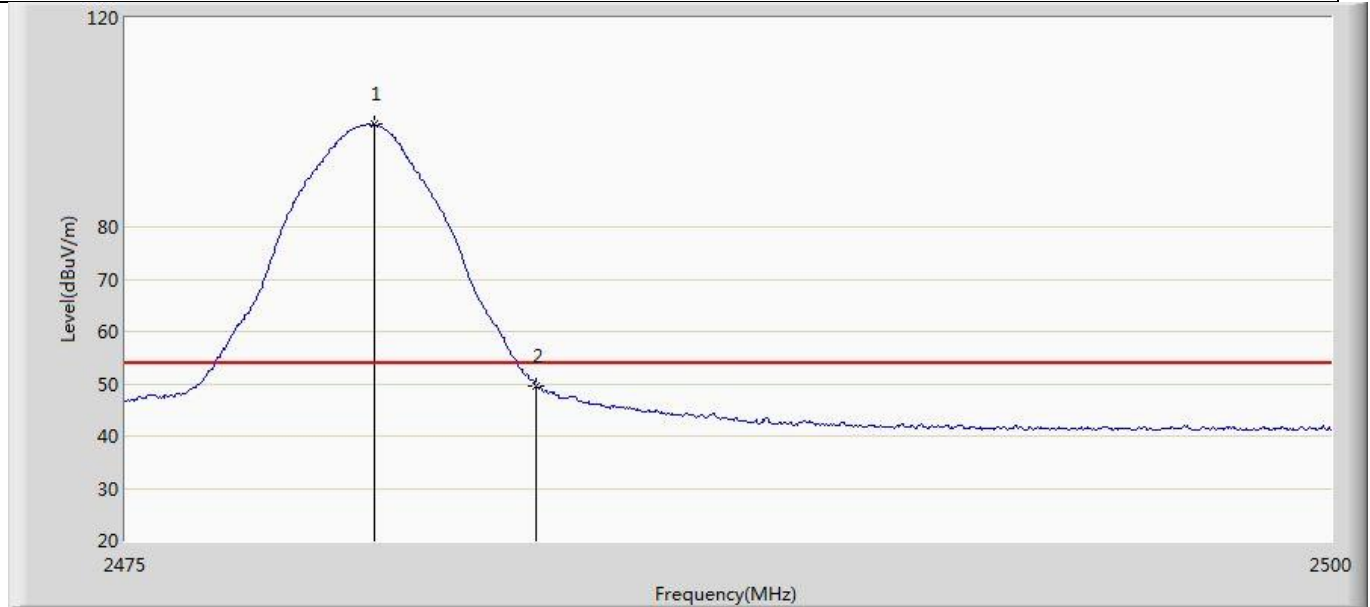

No	Mark	Frequency (MHz)	Measure Level (dBuV/m)	Reading Level (dBuV)	Over Limit (dB)	Limit (dBuV/m)	Factor (dB)	Type
1	*	2480.150	99.668	62.844	45.668	54.000	36.825	AV
2		2483.500	49.602	12.903	-4.398	54.000	36.699	AV

Profile: 20B0023R	Page No.: 13
Engineer: Pawn	
Site: AC5	Time: 2020/11/17 - 19:09
Limit: FCC_Part15.209_RE(3m)	Margin: 0
Probe: Horn_3117_00167055(1-18GHz)	Polarity: Vertical
EUT: Digital Device	Power: 24 Vdc
Note: Mode3:Transmit at 2402MHz	

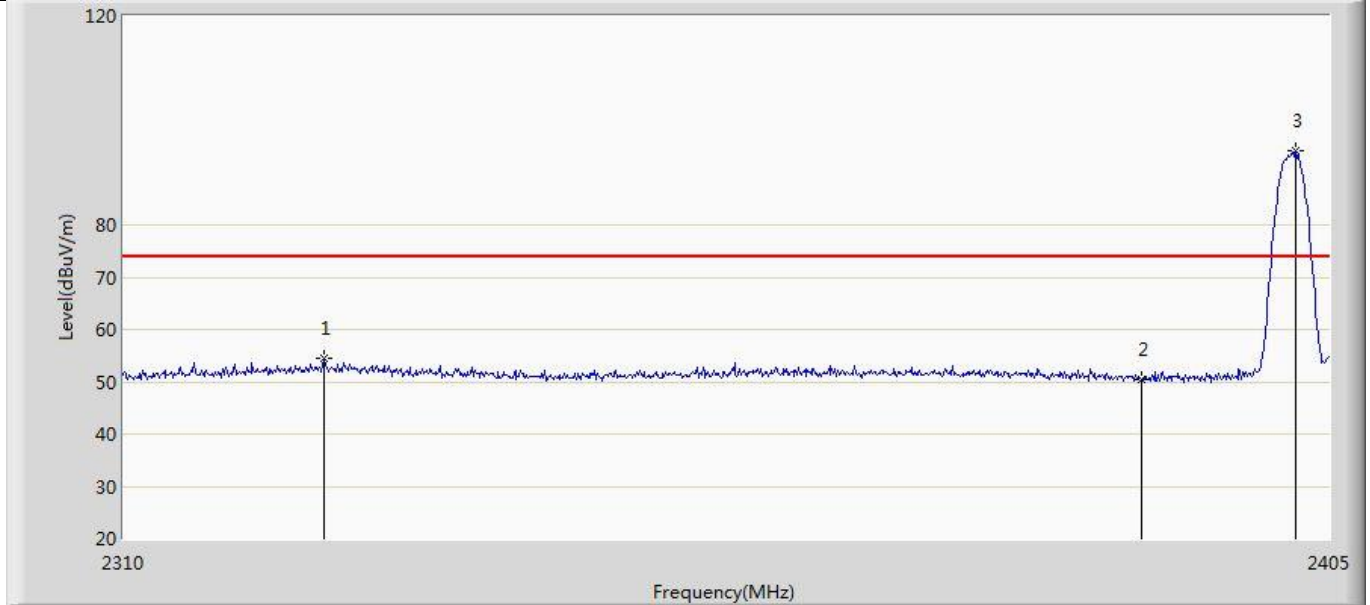

No	Mark	Frequency (MHz)	Measure Level (dBuV/m)	Reading Level (dBuV)	Over Limit (dB)	Limit (dBuV/m)	Factor (dB)	Type
1		2325.580	54.522	16.885	-19.478	74.000	37.637	PK
2		2390.000	50.400	14.656	-23.600	74.000	35.745	PK
3	*	2402.340	94.218	58.125	20.218	74.000	36.093	PK

Profile: 20B0023R	Page No.: 14
Engineer: Pawn	
Site: AC5	Time: 2020/11/17 - 19:10
Limit: FCC_Part15.209_RE(3m)	Margin: 0
Probe: Horn_3117_00167055(1-18GHz)	Polarity: Vertical
EUT: Digital Device	Power: 24 Vdc
Note: Mode3:Transmit at 2402MHz	

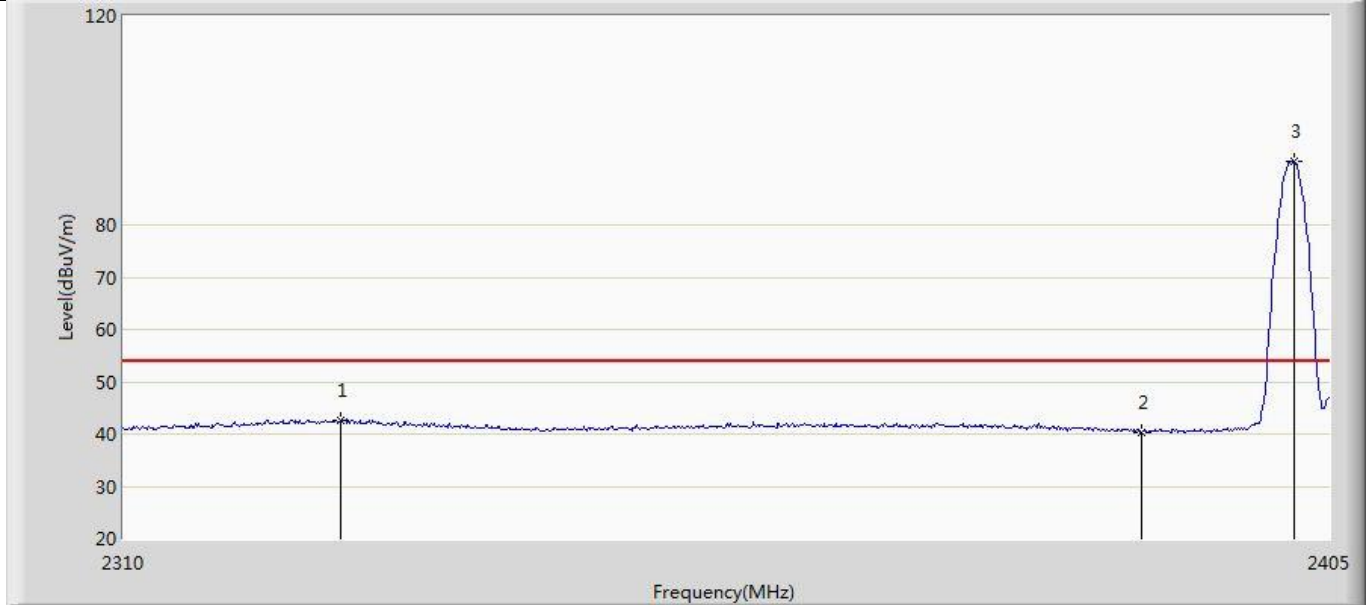

No	Mark	Frequency (MHz)	Measure Level (dBuV/m)	Reading Level (dBuV)	Over Limit (dB)	Limit (dBuV/m)	Factor (dB)	Type
1		2326.815	42.539	4.946	-11.461	54.000	37.593	AV
2		2390.000	40.413	4.669	-13.587	54.000	35.745	AV
3	*	2402.245	92.097	56.011	38.097	54.000	36.086	AV

Profile: 20B0023R	Page No.: 15
Engineer: Pawn	
Site: AC5	Time: 2020/11/17 - 19:12
Limit: FCC_Part15.209_RE(3m)	Margin: 0
Probe: Horn_3117_00167055(1-18GHz)	Polarity: Horizontal
EUT: Digital Device	Power: 24 Vdc
Note: Mode3:Transmit at 2402MHz	

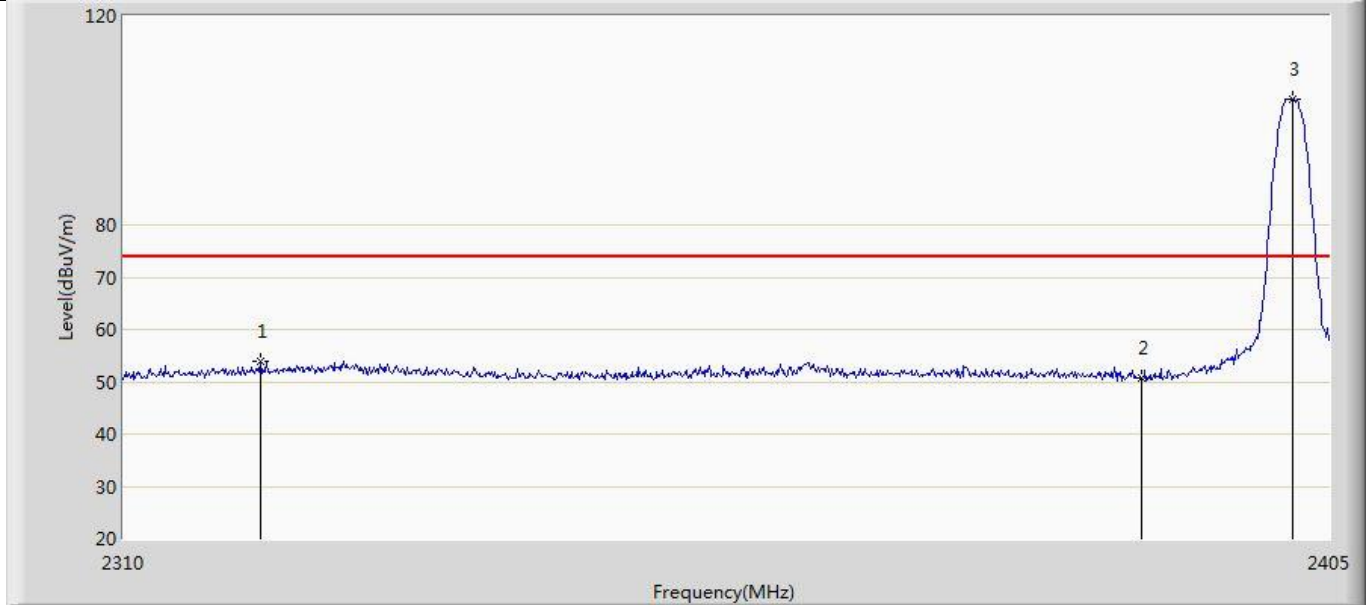

No	Mark	Frequency (MHz)	Measure Level (dBuV/m)	Reading Level (dBuV)	Over Limit (dB)	Limit (dBuV/m)	Factor (dB)	Type
1		2320.640	53.905	16.716	-20.095	74.000	37.190	PK
2		2390.000	50.843	15.099	-23.157	74.000	35.745	PK
3	*	2402.055	104.030	67.958	30.030	74.000	36.071	PK

Profile: 20B0023R	Page No.: 16
Engineer: Pawn	
Site: AC5	Time: 2020/11/17 - 19:14
Limit: FCC_Part15.209_RE(3m)	Margin: 0
Probe: Horn_3117_00167055(1-18GHz)	Polarity: Horizontal
EUT: Digital Device	Power: 24 Vdc
Note: Mode3:Transmit at 2402MHz	

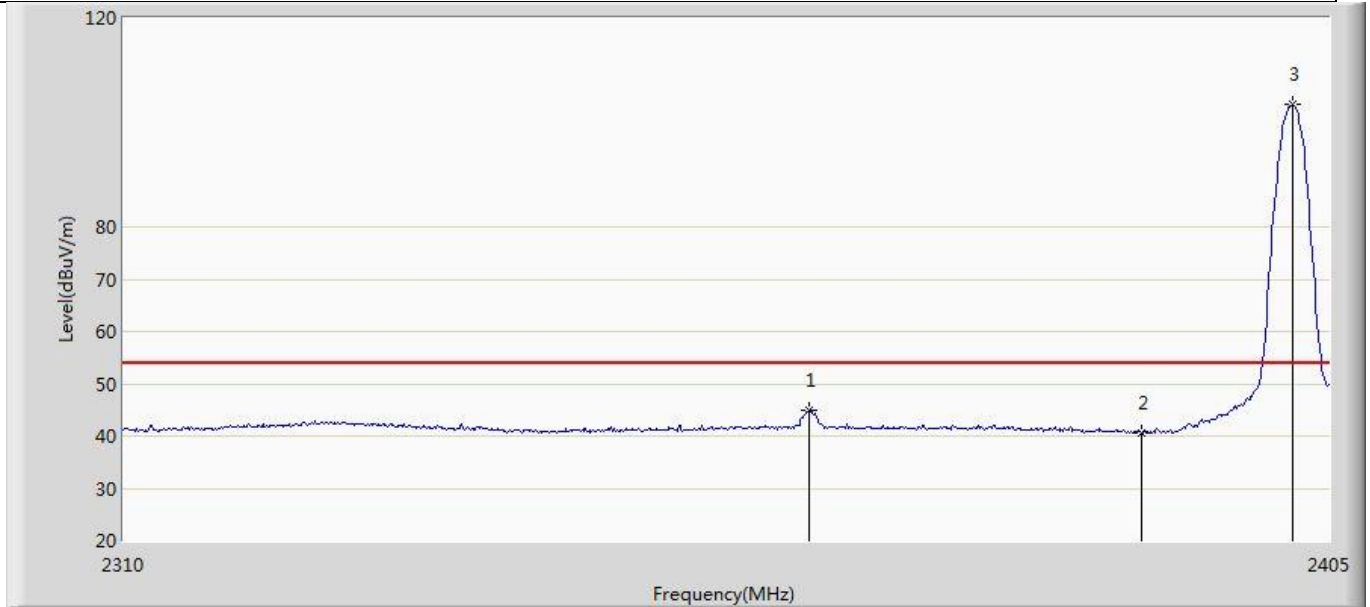

No	Mark	Frequency (MHz)	Measure Level (dBuV/m)	Reading Level (dBuV)	Over Limit (dB)	Limit (dBuV/m)	Factor (dB)	Type
1		2363.580	45.017	8.362	-8.983	54.000	36.655	AV
2		2390.000	40.544	4.800	-13.456	54.000	35.745	AV
3	*	2402.055	103.390	67.318	49.390	54.000	36.071	AV

Profile: 20B0023R	Page No.: 29
Engineer: Pawn	
Site: AC5	Time: 2020/11/17 - 19:34
Limit: FCC_Part15.209_RE(3m)	Margin: 0
Probe: Horn_3117_00167055(1-18GHz)	Polarity: Vertical
EUT: Digital Device	Power: 24 Vdc
Note: Mode3:Transmit at 2480MHz	

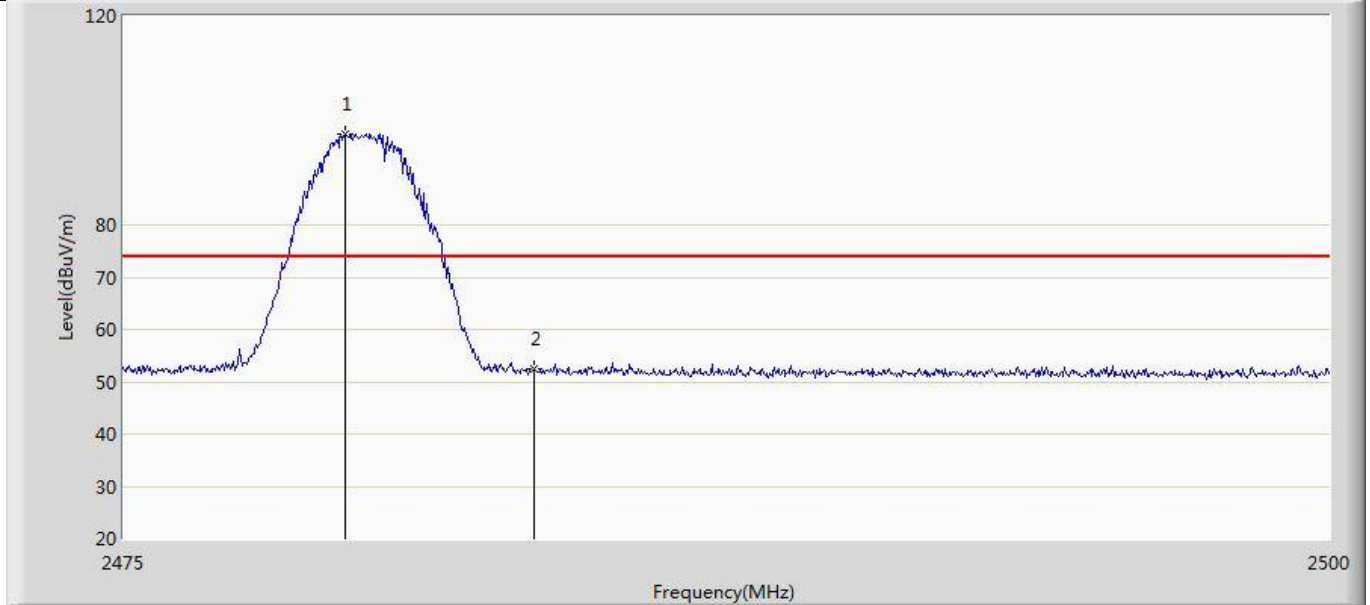

No	Mark	Frequency (MHz)	Measure Level (dBuV/m)	Reading Level (dBuV)	Over Limit (dB)	Limit (dBuV/m)	Factor (dB)	Type
1	*	2479.575	97.449	60.603	23.449	74.000	36.846	PK
2		2483.500	52.506	15.807	-21.494	74.000	36.699	PK

Profile: 20B0023R	Page No.: 30
Engineer: Pawn	
Site: AC5	Time: 2020/11/17 - 19:36
Limit: FCC_Part15.209_RE(3m)	Margin: 0
Probe: Horn_3117_00167055(1-18GHz)	Polarity: Vertical
EUT: Digital Device	Power: 24 Vdc
Note: Mode3:Transmit at 2480MHz	

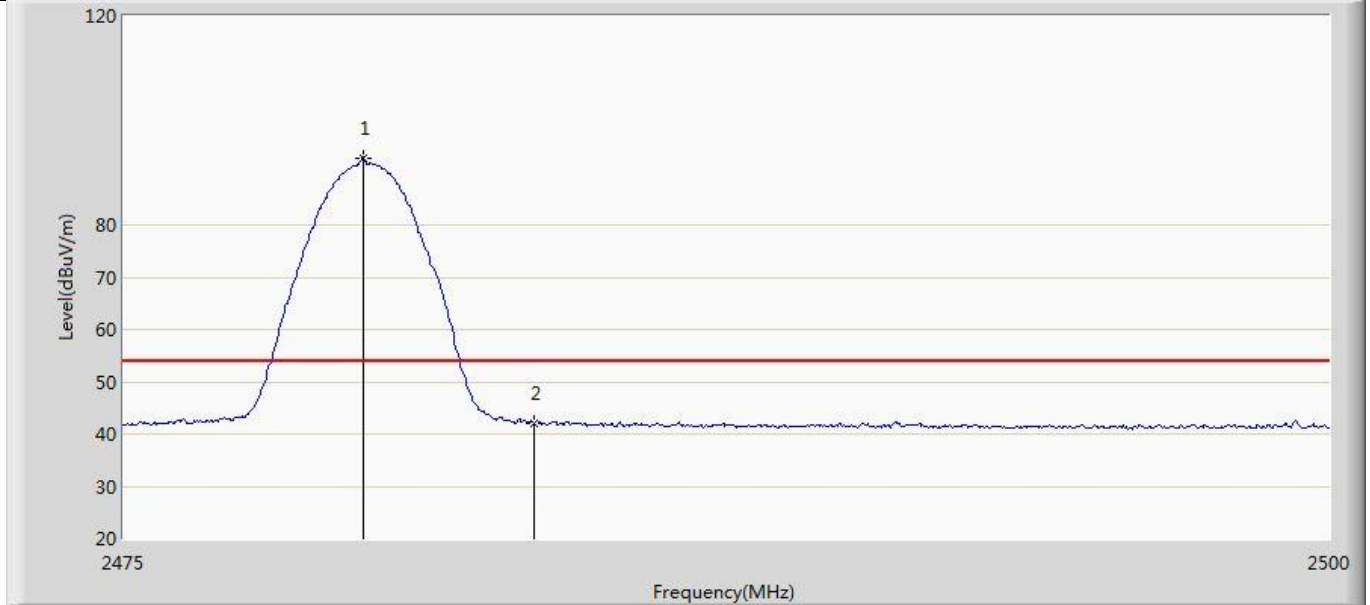

No	Mark	Frequency (MHz)	Measure Level (dBuV/m)	Reading Level (dBuV)	Over Limit (dB)	Limit (dBuV/m)	Factor (dB)	Type
1	*	2479.975	92.835	56.004	38.835	54.000	36.831	AV
2		2483.500	42.024	5.325	-11.976	54.000	36.699	AV



Profile: 20B0023R	Page No.: 31
Engineer: Pawn	
Site: AC5	Time: 2020/11/17 - 19:37
Limit: FCC_Part15.209_RE(3m)	Margin: 0
Probe: Horn_3117_00167055(1-18GHz)	Polarity: Horizontal
EUT: Digital Device	Power: 24 Vdc
Note: Mode3:Transmit at 2480MHz	

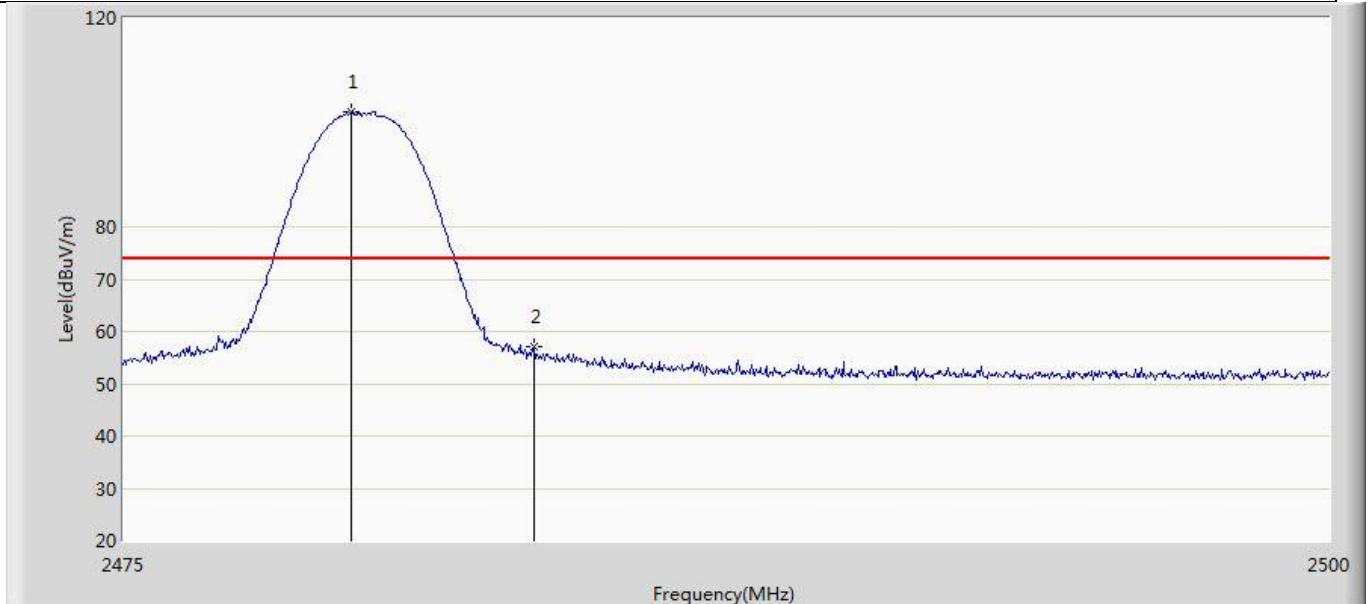

No	Mark	Frequency (MHz)	Measure Level (dBuV/m)	Reading Level (dBuV)	Over Limit (dB)	Limit (dBuV/m)	Factor (dB)	Type
1	*	2479.725	101.932	65.092	27.932	74.000	36.840	PK
2		2483.500	57.196	20.497	-16.804	74.000	36.699	PK

Profile: 20B0023R	Page No.: 32
Engineer: Pawn	
Site: AC5	Time: 2020/11/17 - 19:39
Limit: FCC_Part15.209_RE(3m)	Margin: 0
Probe: Horn_3117_00167055(1-18GHz)	Polarity: Horizontal
EUT: Digital Device	Power: 24 Vdc
Note: Mode3:Transmit at 2480MHz	

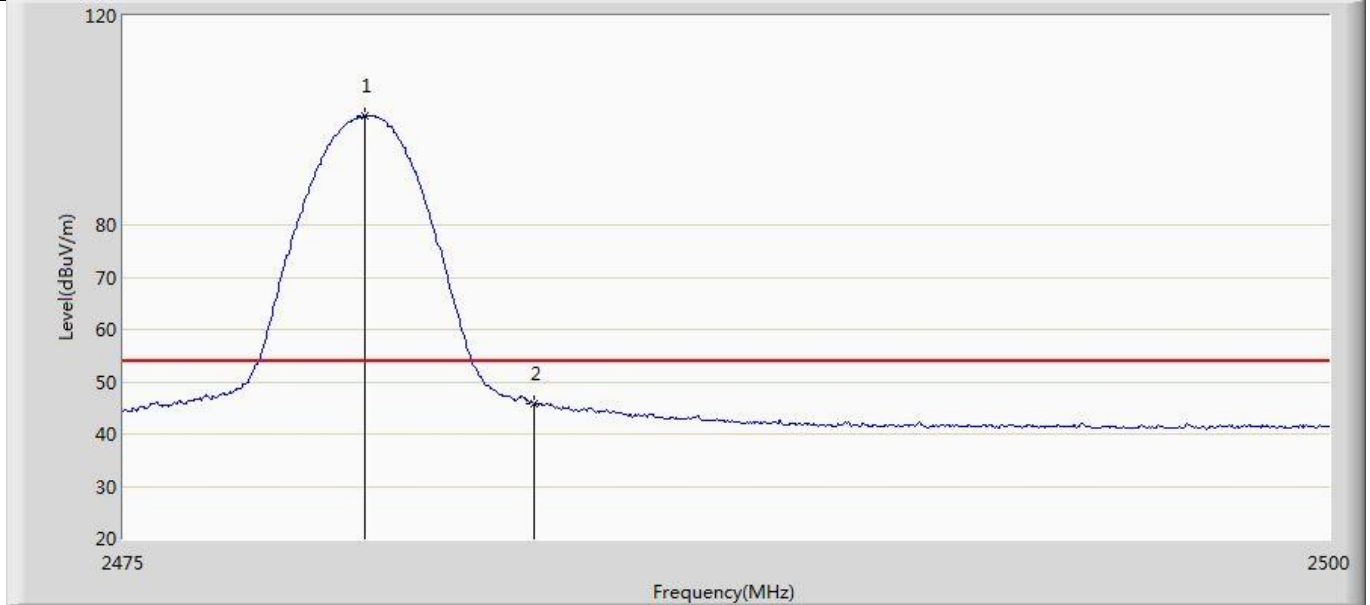

No	Mark	Frequency (MHz)	Measure Level (dBuV/m)	Reading Level (dBuV)	Over Limit (dB)	Limit (dBuV/m)	Factor (dB)	Type
1	*	2480.000	100.908	64.078	46.908	54.000	36.830	AV
2		2483.500	45.881	9.182	-8.119	54.000	36.699	AV

Profile: 20B0023R	Page No.: 9
Engineer: Pawn	
Site: AC5	Time: 2020/11/17 - 18:55
Limit: FCC_Part15.209_RE(3m)	Margin: 0
Probe: Horn_3117_00167055(1-18GHz)	Polarity: Vertical
EUT: Digital Device	Power: 24 Vdc
Note: Mode4:Transmit at 2402MHz	

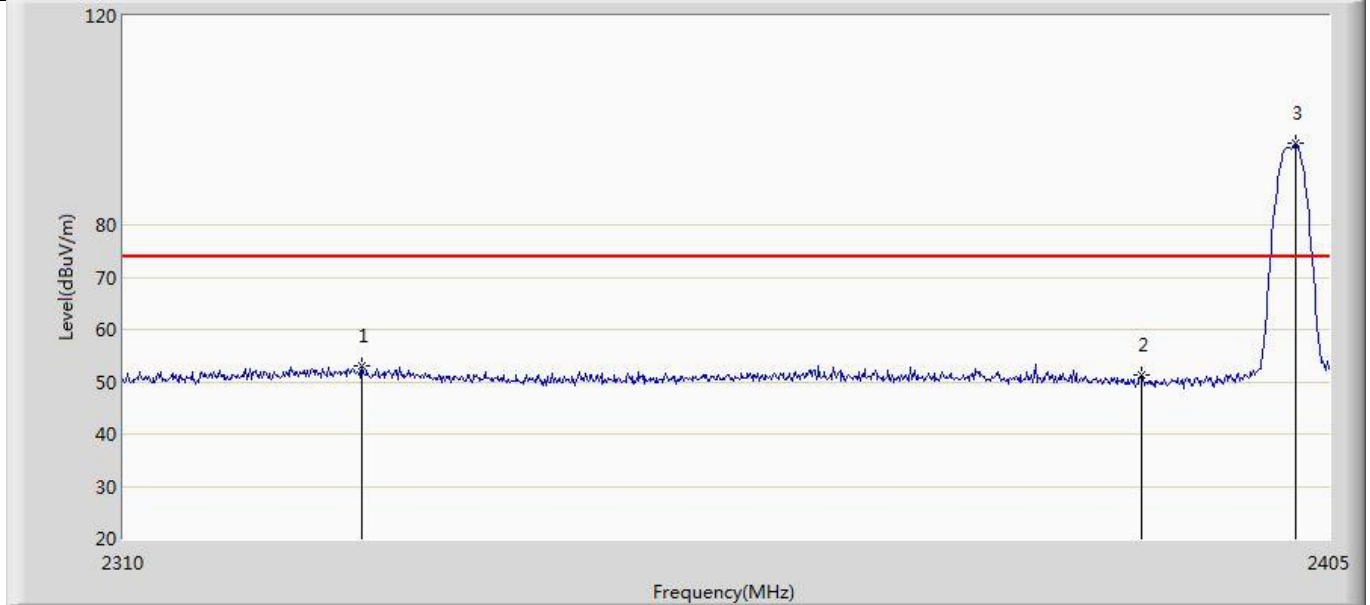

No	Mark	Frequency (MHz)	Measure Level (dBuV/m)	Reading Level (dBuV)	Over Limit (dB)	Limit (dBuV/m)	Factor (dB)	Type
1		2328.525	53.038	15.617	-20.962	74.000	37.421	PK
2		2390.000	51.236	15.492	-22.764	74.000	35.745	PK
3	*	2402.340	95.761	59.668	21.761	74.000	36.093	PK

Profile: 20B0023R	Page No.: 10
Engineer: Pawn	
Site: AC5	Time: 2020/11/17 - 18:57
Limit: FCC_Part15.209_RE(3m)	Margin: 0
Probe: Horn_3117_00167055(1-18GHz)	Polarity: Vertical
EUT: Digital Device	Power: 24 Vdc
Note: Mode4:Transmit at 2402MHz	

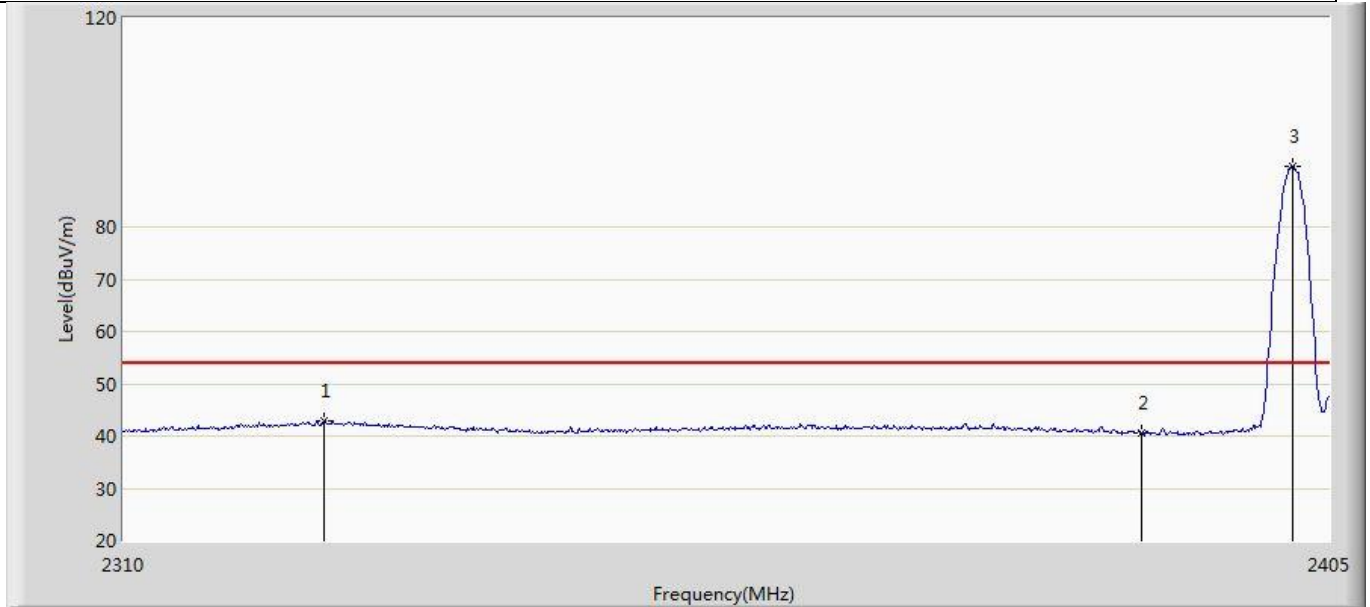

No	Mark	Frequency (MHz)	Measure Level (dBuV/m)	Reading Level (dBuV)	Over Limit (dB)	Limit (dBuV/m)	Factor (dB)	Type
1		2325.580	42.861	5.224	-11.139	54.000	37.637	AV
2		2390.000	40.567	4.823	-13.433	54.000	35.745	AV
3	*	2402.055	91.510	55.438	37.510	54.000	36.071	AV

Profile: 20B0023R	Page No.: 11
Engineer: Pawn	
Site: AC5	Time: 2020/11/17 - 18:59
Limit: FCC_Part15.209_RE(3m)	Margin: 0
Probe: Horn_3117_00167055(1-18GHz)	Polarity: Horizontal
EUT: Digital Device	Power: 24 Vdc
Note: Mode4:Transmit at 2402MHz	

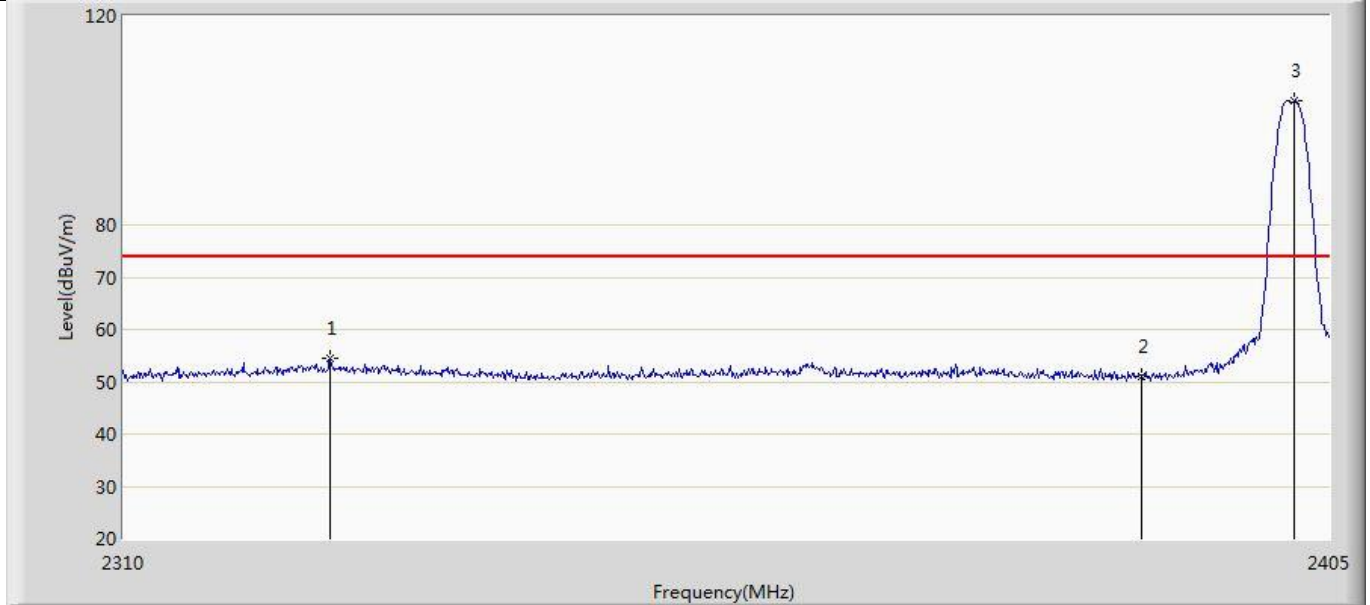

No	Mark	Frequency (MHz)	Measure Level (dBuV/m)	Reading Level (dBuV)	Over Limit (dB)	Limit (dBuV/m)	Factor (dB)	Type
1		2326.055	54.399	16.729	-19.601	74.000	37.670	PK
2		2390.000	51.111	15.367	-22.889	74.000	35.745	PK
3	*	2402.150	103.699	67.620	29.699	74.000	36.079	PK

Profile: 20B0023R	Page No.: 12
Engineer: Pawn	
Site: AC5	Time: 2020/11/17 - 19:07
Limit: FCC_Part15.209_RE(3m)	Margin: 0
Probe: Horn_3117_00167055(1-18GHz)	Polarity: Horizontal
EUT: Digital Device	Power: 24 Vdc
Note: Mode4:Transmit at 2402MHz	

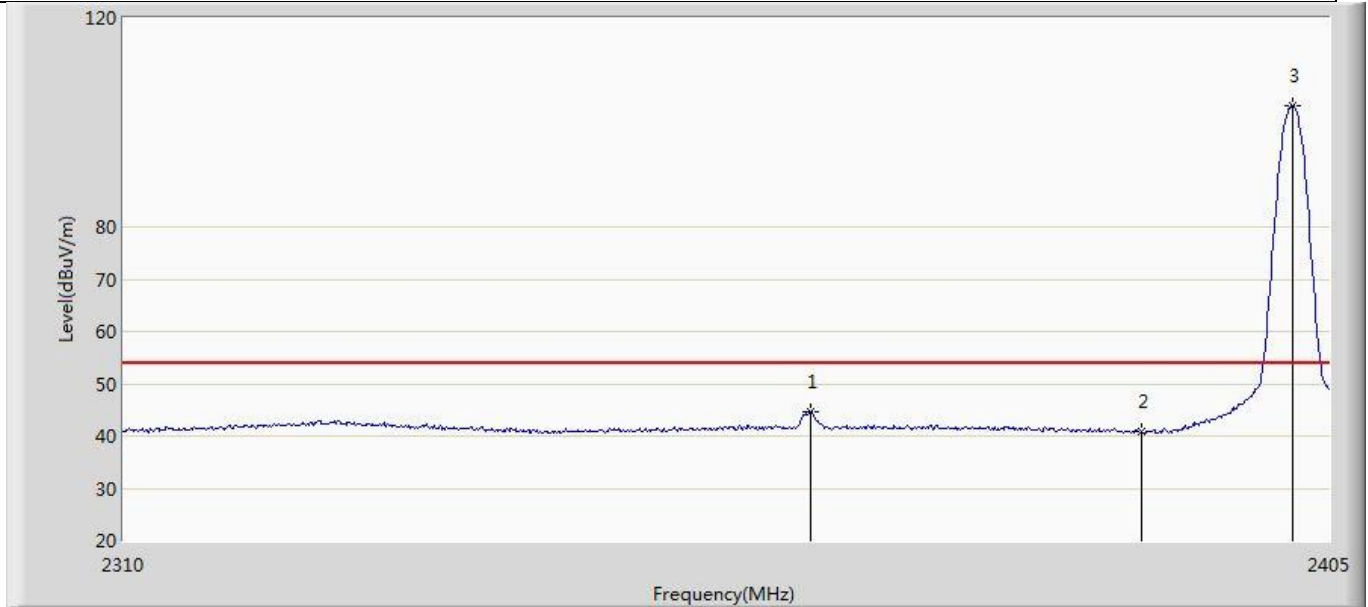

No	Mark	Frequency (MHz)	Measure Level (dBuV/m)	Reading Level (dBuV)	Over Limit (dB)	Limit (dBuV/m)	Factor (dB)	Type
1		2363.675	44.759	8.104	-9.241	54.000	36.654	AV
2		2390.000	40.800	5.056	-13.200	54.000	35.745	AV
3	*	2402.055	103.141	67.069	49.141	54.000	36.071	AV

Profile: 20B0023R	Page No.: 25
Engineer: Pawn	
Site: AC5	Time: 2020/11/17 - 19:28
Limit: FCC_Part15.209_RE(3m)	Margin: 0
Probe: Horn_3117_00167055(1-18GHz)	Polarity: Vertical
EUT: Digital Device	Power: 24 Vdc
Note: Mode4:Transmit at 2480MHz	

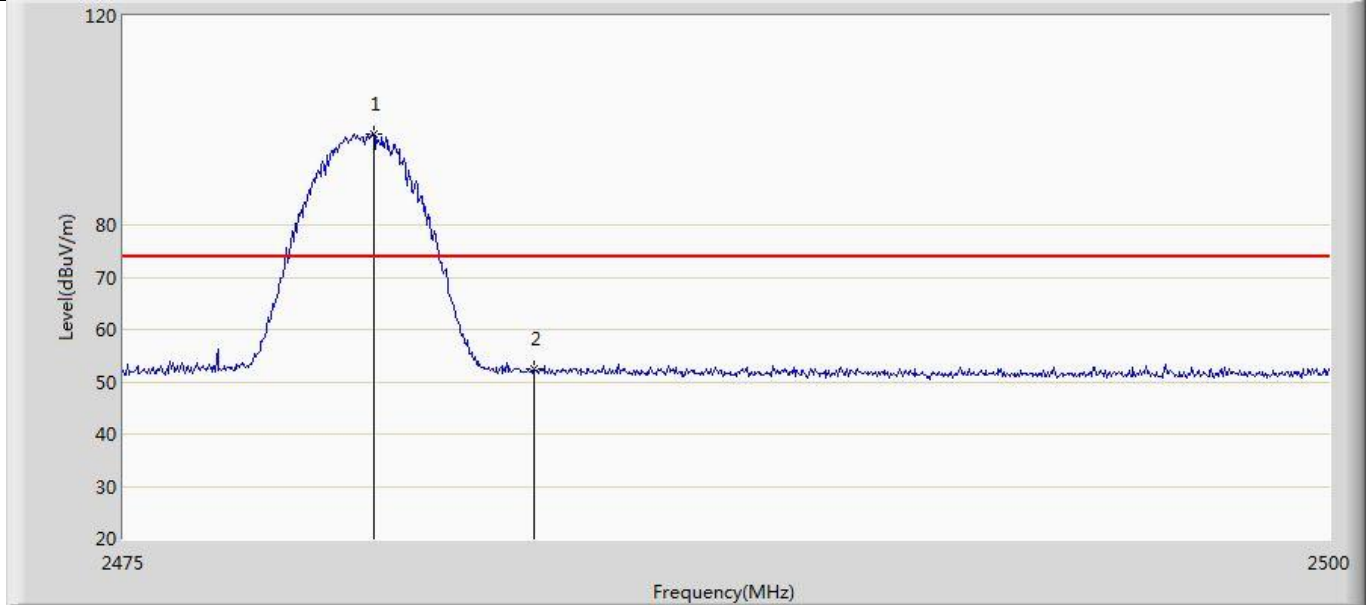

No	Mark	Frequency (MHz)	Measure Level (dBuV/m)	Reading Level (dBuV)	Over Limit (dB)	Limit (dBuV/m)	Factor (dB)	Type
1	*	2480.175	97.258	60.435	23.258	74.000	36.824	PK
2		2483.500	52.333	15.634	-21.667	74.000	36.699	PK

Profile: 20B0023R	Page No.: 26
Engineer: Pawn	
Site: AC5	Time: 2020/11/17 - 19:30
Limit: FCC_Part15.209_RE(3m)	Margin: 0
Probe: Horn_3117_00167055(1-18GHz)	Polarity: Vertical
EUT: Digital Device	Power: 24 Vdc
Note: Mode4:Transmit at 2480MHz	

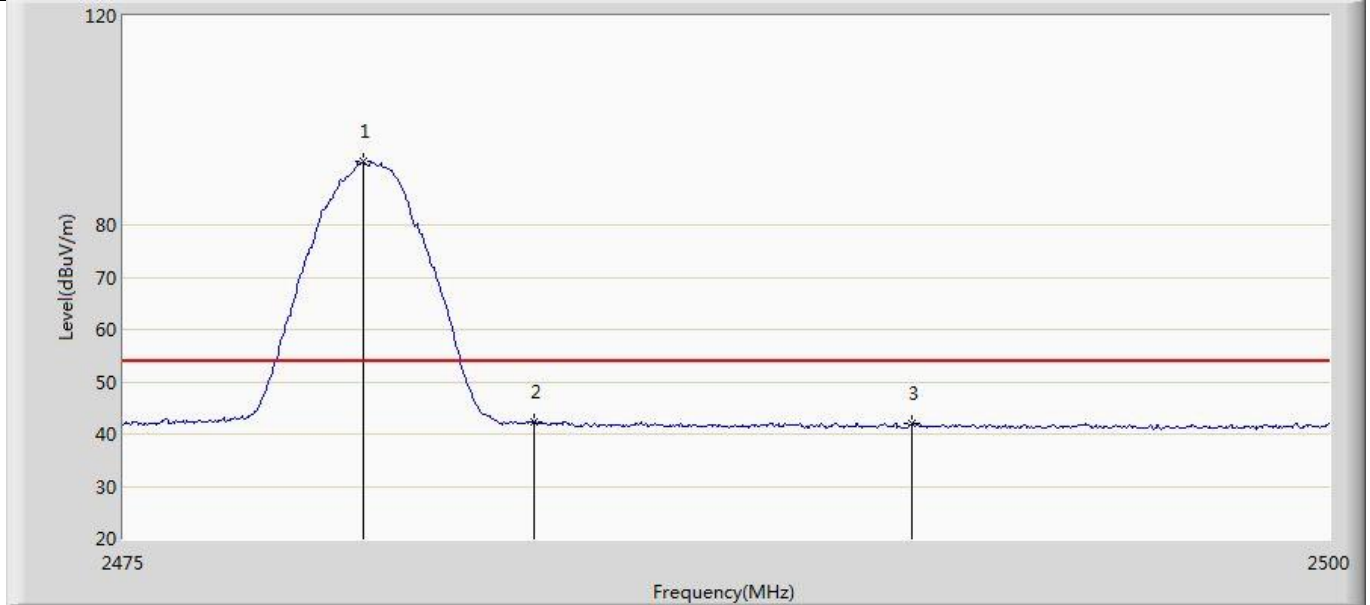

No	Mark	Frequency (MHz)	Measure Level (dBuV/m)	Reading Level (dBuV)	Over Limit (dB)	Limit (dBuV/m)	Factor (dB)	Type
1	*	2479.975	92.209	55.378	38.209	54.000	36.831	AV
2		2483.500	42.309	5.610	-11.691	54.000	36.699	AV
3		2491.325	42.010	5.602	-11.990	54.000	36.408	AV



Profile: 20B0023R	Page No.: 27
Engineer: Pawn	
Site: AC5	Time: 2020/11/17 - 19:31
Limit: FCC_Part15.209_RE(3m)	Margin: 0
Probe: Horn_3117_00167055(1-18GHz)	Polarity: Horizontal
EUT: Digital Device	Power: 24 Vdc
Note: Mode4:Transmit at 2480MHz	

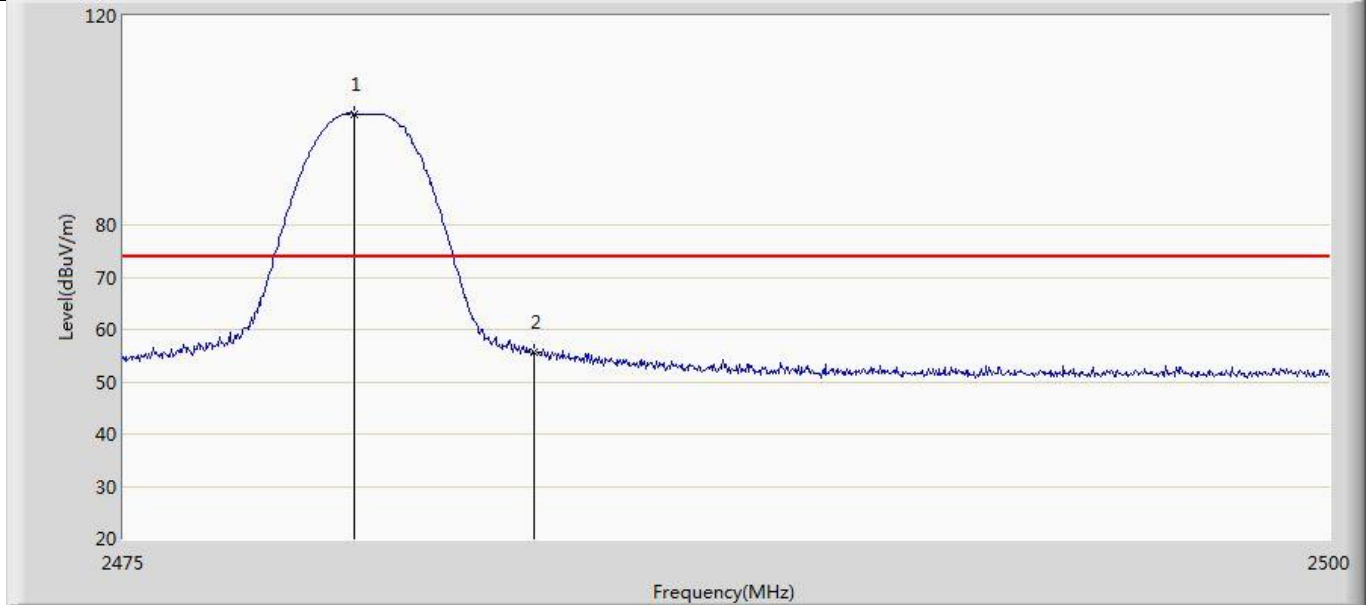

No	Mark	Frequency (MHz)	Measure Level (dBuV/m)	Reading Level (dBuV)	Over Limit (dB)	Limit (dBuV/m)	Factor (dB)	Type
1	*	2479.775	101.293	64.455	27.293	74.000	36.838	PK
2		2483.500	55.540	18.841	-18.460	74.000	36.699	PK

Profile: 20B0023R	Page No.: 28
Engineer: Pawn	
Site: AC5	Time: 2020/11/17 - 19:33
Limit: FCC_Part15.209_RE(3m)	Margin: 0
Probe: Horn_3117_00167055(1-18GHz)	Polarity: Horizontal
EUT: Digital Device	Power: 24 Vdc
Note: Mode4:Transmit at 2480MHz	

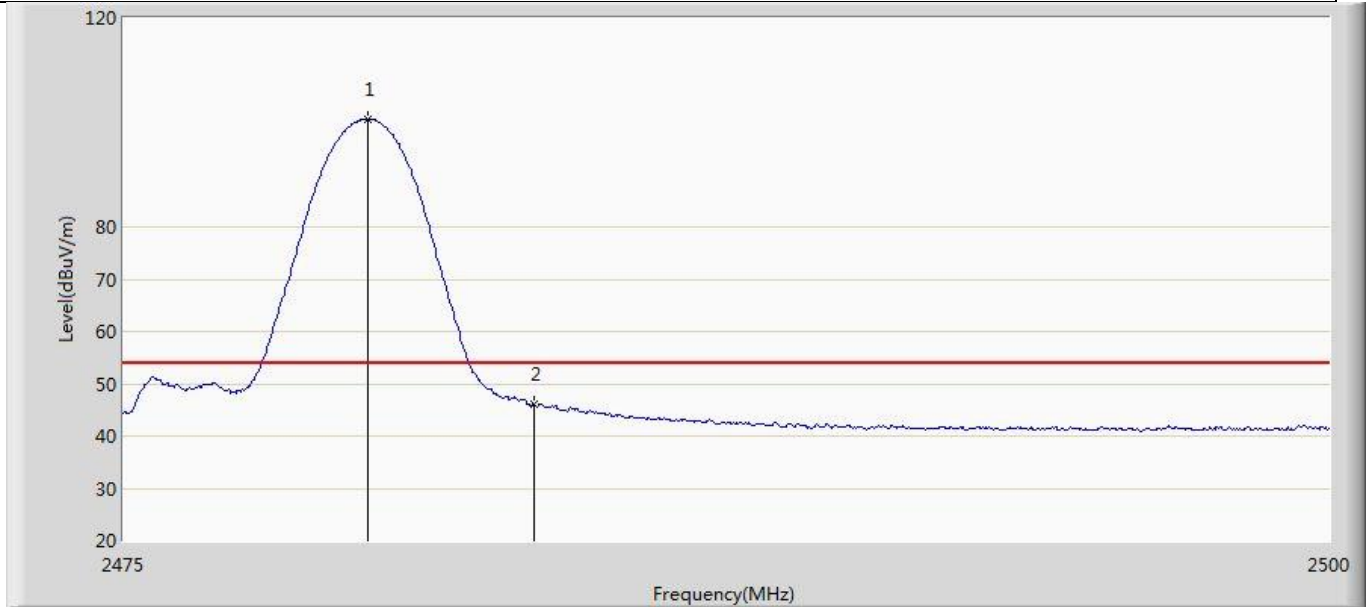

No	Mark	Frequency (MHz)	Measure Level (dBuV/m)	Reading Level (dBuV)	Over Limit (dB)	Limit (dBuV/m)	Factor (dB)	Type
1	*	2480.050	100.704	63.876	46.704	54.000	36.828	AV
2		2483.500	45.945	9.246	-8.055	54.000	36.699	AV

<b>4.6 DTS Bandwidth</b>	<b>VERDICT: PASS</b>
--------------------------	----------------------

**4.6.1 Limit**

<b>Standard</b>	FCC Part 15 Subpart C Paragraph 15.247 (a)(2)
Systems using digital modulation techniques operate in the 2400-2483.5 MHz. The minimum 6 dB bandwidth shall be at least 500 kHz	

**4.6.2 Test Setup**

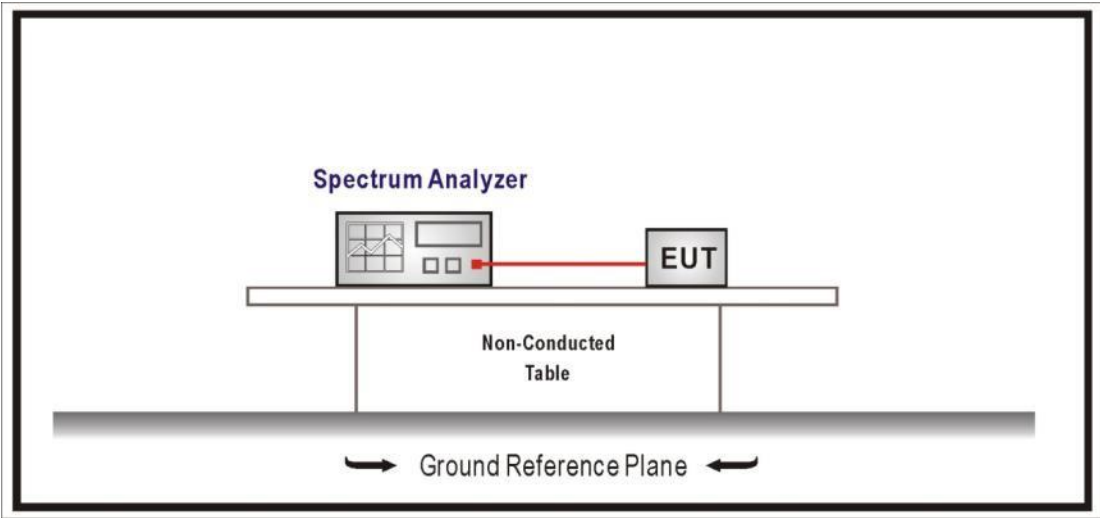

**4.6.3 Test Procedure**

	Reference Rule	Chapter	Description
<input checked="" type="checkbox"/>	ANSI C63.10	11.8	DTS bandwidth
<input type="checkbox"/>	ANSI C63.10	11.8.1	Option 1
<input checked="" type="checkbox"/>	ANSI C63.10	11.8.2	Option 2

**4.6.4 Test Data**

Mode	CH.	Test Freq. (MHz)	99% Occupied Bandwidth (kHz)	6dB Occupied Bandwidth (kHz)	Limit (kHz)	Result
1	00	2402	1073.8	694.3	>500	Pass
	19	2440	1070.0	680.8	>500	Pass
	39	2480	1070.0	689.8	>500	Pass
2	00	2402	2183.3	1.380	>500	Pass
	19	2440	2182.4	1.379	>500	Pass
	39	2480	2181.9	1.379	>500	Pass
3	00	2402	1090.7	760.4	>500	Pass
	19	2440	1089.1	759.0	>500	Pass
	39	2480	1086.0	755.3	>500	Pass
4	00	2402	1102.2	726.5	>500	Pass
	19	2440	1094.1	727.9	>500	Pass
	39	2480	1095.3	724.3	>500	Pass

Note : The worst case of Occupied Bandwidth as below:

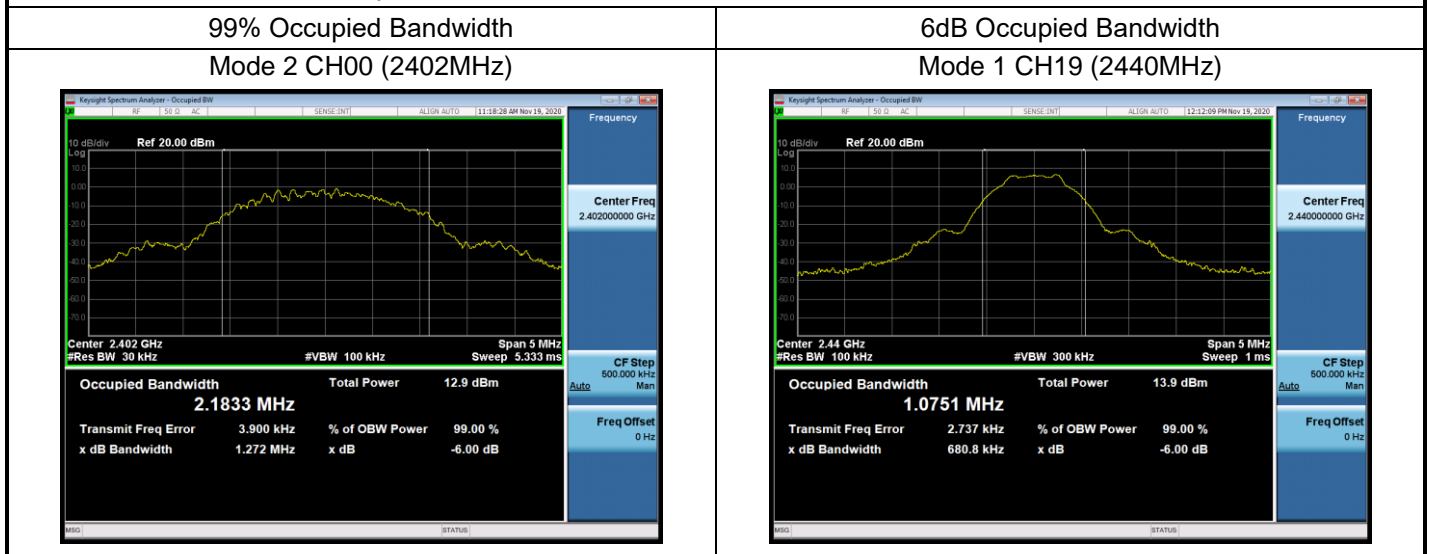

<b>4.7 Fundamental emission output power</b>	<b>VERDICT: PASS</b>
--	----------------------

4.7.1 Limit		
Standard	FCC Part 15 Subpart C Paragraph 15.247 (b)(3)	
<input checked="" type="checkbox"/>	GTX < 6dBi	Pout ≤ 30dBm
<input type="checkbox"/>	GTX > 6dBi	
<input type="checkbox"/>	Non-Fix point-point	Pout ≤ 30 - (GTX - 6)
<input type="checkbox"/>	Fix point-point	Pout ≤ 30 - [(GTX - 6)]/3
<input type="checkbox"/>	Point-to-multipoint	Pout ≤ 30 - (GTX - 6)
<input type="checkbox"/>	Overlap Beams	Pout ≤ 30 - [(GTX - 6)]/3
<input type="checkbox"/>	Aggregate power transmitted simultaneously on all beams	Pout ≤ 30 - [(GTX - 6)]/3
<input type="checkbox"/>	single directional beam	Pout ≤ 30 - [(GTX - 6)]/3 + 8dB

Note 1 : GTX directional gain of transmitting antennas.  
 Note 2 : Pout is maximum peak conducted output power .

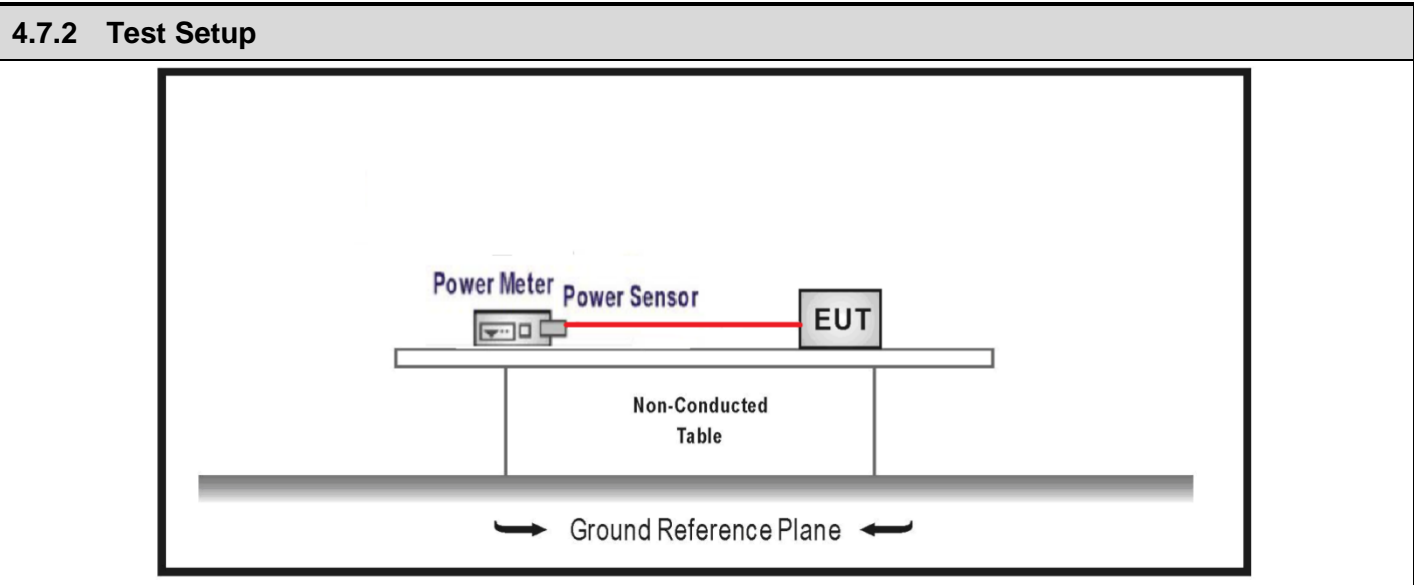

4.7.3 Test Procedure					
	References Rule		Chapter	Description	
<input checked="" type="checkbox"/>	ANSI C63.10		11.9	Fundamental emission output power	
<input checked="" type="checkbox"/>	ANSI C63.10		11.9.1	Maximum peak conducted output power	
	<input type="checkbox"/>	ANSI C63.10	11.9.1.1	RBW $\geq$ DTS bandwidth	
	<input type="checkbox"/>	ANSI C63.10	11.9.1.2	Integrated band power method	
	<input checked="" type="checkbox"/>	ANSI C63.10	11.9.1.3	PKPM1 Peak power meter method	
	<input type="checkbox"/>	ANSI C63.10		11.9.2	Maximum conducted (average) output power
	<input type="checkbox"/>	ANSI C63.10	11.9.2.2	Measurement using a spectrum analyzer (SA)	
		<input type="checkbox"/>	ANSI C63.10	11.9.2.2.2	Method AVGSA-1(Duty cycle $\geq$ 98%)
		<input type="checkbox"/>	ANSI C63.10	11.9.2.2.3	Method AVGSA-1A(Duty cycle $\geq$ 98%)
		<input type="checkbox"/>	ANSI C63.10	11.9.2.2.4	Method AVGSA-2(Duty cycle $\leq$ 98%)
		<input type="checkbox"/>	ANSI C63.10	11.9.2.2.5	Method AVGSA-2A(Duty cycle $\leq$ 98%)
		<input type="checkbox"/>	ANSI C63.10	11.9.2.2.4	Method AVGSA-3
		<input type="checkbox"/>	ANSI C63.10	11.9.2.2.5	Method AVGSA-3A
	<input type="checkbox"/>	ANSI C63.10		11.9.2.3	Measurement using a power meter (PM)
		<input type="checkbox"/>	ANSI C63.10	11.9.2.3.1	Method AVGPM
		<input type="checkbox"/>	ANSI C63.10	11.9.2.3.2	Method AVGPM-G

#### 4.7.4 Test Data

Mode	Channel	Test Frequency (MHz)	Conducted Power (dBm)	EIRP (dBm)	Conducted Power Limit (dBm)	EIRP Limit (dBm)	Result
Mode 1	00	2402	7.83	9.91	≤30	≤36	Pass
	19	2440	7.44	9.52	≤30	≤36	Pass
	39	2480	7.46	9.54	≤30	≤36	Pass
Mode 2	00	2402	7.45	9.53	≤30	≤36	Pass
	19	2440	7.25	9.33	≤30	≤36	Pass
	39	2480	7.39	9.47	≤30	≤36	Pass
Mode 3	00	2402	7.74	9.82	≤30	≤36	Pass
	19	2440	7.28	9.36	≤30	≤36	Pass
	39	2480	7.48	9.56	≤30	≤36	Pass
Mode 4	00	2402	7.78	9.86	≤30	≤36	Pass
	19	2440	7.40	9.48	≤30	≤36	Pass
	39	2480	7.30	9.38	≤30	≤36	Pass

<b>4.8 Power Density</b>	<b>VERDICT: PASS</b>
--------------------------	----------------------

<b>4.8.1 Limit</b>	
<b>Standard</b>	FCC Part 15 Subpart C Paragraph 15.247 (b)(3)
Power Spectral Density $\leq$ 8dBm/3kHz	

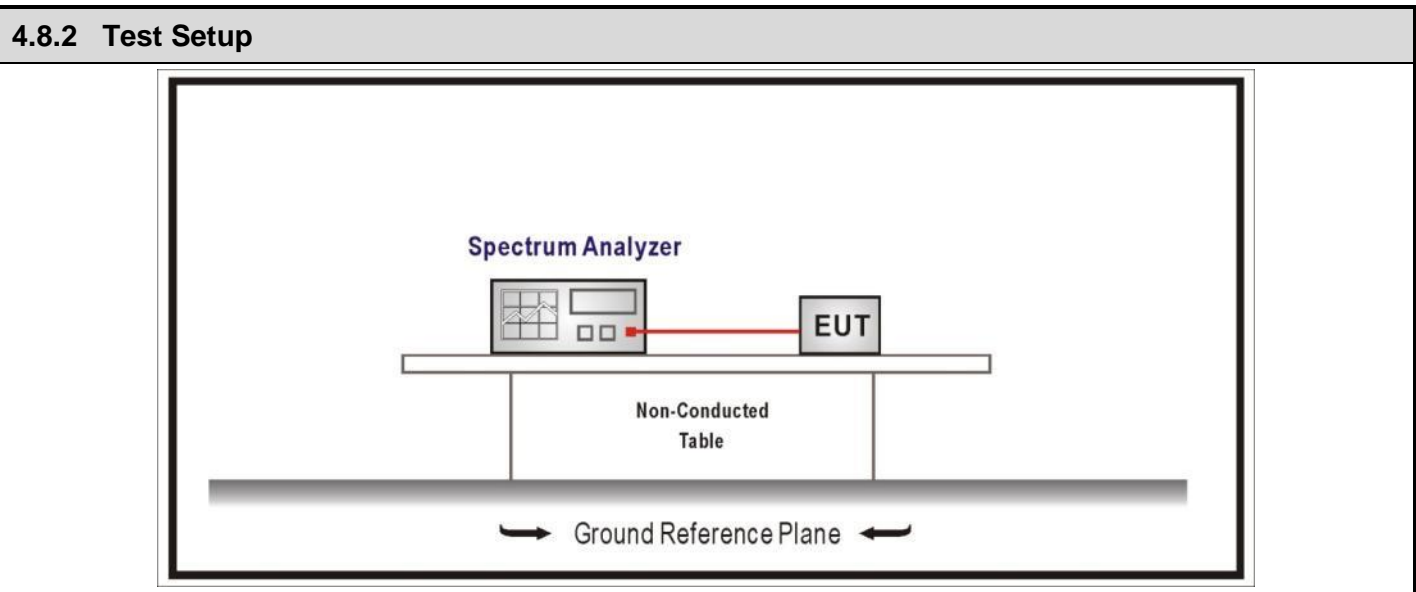

**4.8.3 Test Procedure**

	References Rule	Chapter	Description
<input checked="" type="checkbox"/>	ANSI C63.10	11.10	Maximum power spectral density level in the fundamental emission
<input checked="" type="checkbox"/>	ANSI C63.10	11.10.2	Method PKPSD (peak PSD)
<input type="checkbox"/>	ANSI C63.10	11.10.3	Method AVGPSD-1(Duty cycle $\geq$ 98%)
<input type="checkbox"/>	ANSI C63.10	11.10.4	Method AVGPSD-1A(Duty cycle $\geq$ 98%)
<input type="checkbox"/>	ANSI C63.10	11.10.5	Method AVGPSD-2(Duty cycle $<$ 98%)
<input type="checkbox"/>	ANSI C63.10	11.10.6	Method AVGPSD-2A(Duty cycle $<$ 98%)
<input type="checkbox"/>	ANSI C63.10	11.10.7	Method AVGPSD-3
<input type="checkbox"/>	ANSI C63.10	11.10.8	Method AVGPSD-3A



**4.8.4 Test Data**

Mode	Channel	Test Frequency (MHz)	Measurement PSD (dBm/3kHz)	Limit (dBm/3kHz)	Result
Mode 1	00	2402	-7.553	≤8	Pass
	19	2440	-7.912	≤8	Pass
	39	2480	-7.701	≤8	Pass
Mode 2	00	2402	-9.420	≤8	Pass
	19	2440	-9.690	≤8	Pass
	39	2480	-9.736	≤8	Pass
Mode 3	00	2402	-9.962	≤8	Pass
	19	2440	-10.098	≤8	Pass
	39	2480	-9.896	≤8	Pass
Mode 4	00	2402	1.355	≤8	Pass
	19	2440	1.187	≤8	Pass
	39	2480	1.387	≤8	Pass

Note : The worst case of PSD as below:

Mode 4 CH39(2480MHz)

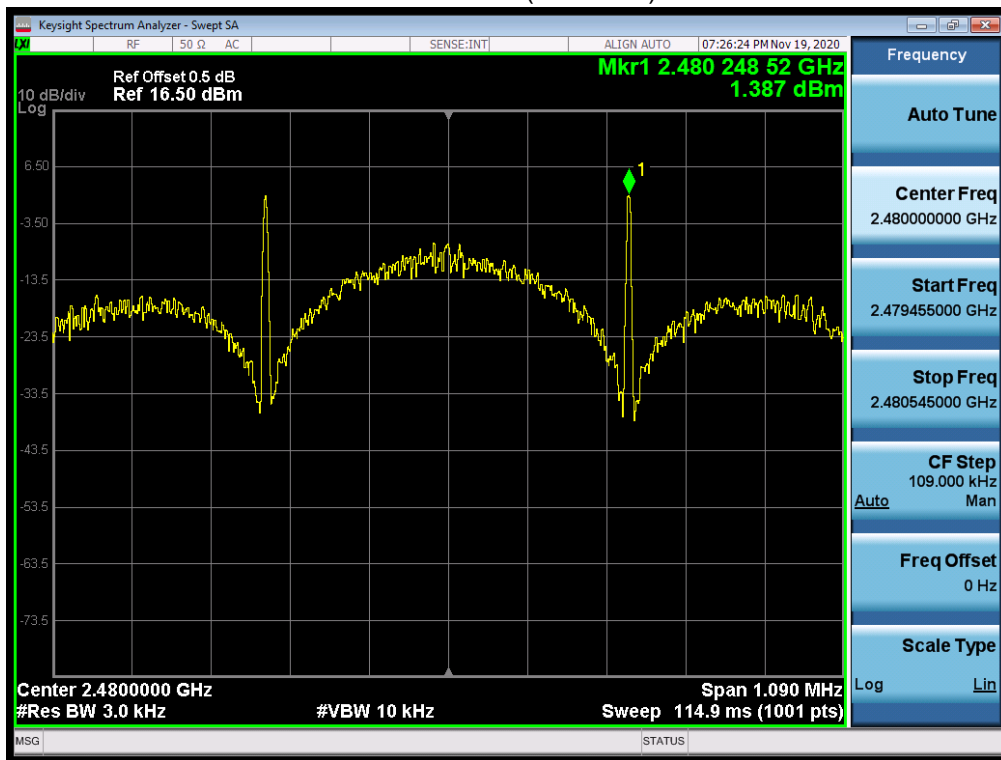

<b>4.9 Antenna Requirement</b>	<b>VERDICT: PASS</b>
--------------------------------	----------------------

<b>4.9.1 Limit:</b>	
<b>Standard</b>	FCC Part 15 Subpart C Paragraph 15.203
<p>An intentional radiator shall be designed to ensure that no antenna other than that furnished by the responsible party shall be used with the device. The use of a permanently attached antenna or of an antenna that uses a unique coupling to the intentional radiator shall be considered sufficient to comply with the provisions of this section. The manufacturer may design the unit so that a broken antenna can be replaced by the user, but the use of a standard antenna jack or electrical connector is prohibited. This requirement does not apply to carrier current devices or to devices operated under the provisions of §15.211, §15.213, §15.217, §15.219, or §15.221. Further, this requirement does not apply to intentional radiators that must be professionally installed, such as perimeter protection systems and some field disturbance sensors, or to other intentional radiators which, in accordance with §15.31(d), must be measured at the installation site. However, the installer shall be responsible for ensuring that the proper antenna is employed so that the limits in this part are not exceeded.</p>	

<b>4.9.2 Antenna Connector Construction:</b>	
<input checked="" type="checkbox"/>	The use of a permanently attached antenna
<input type="checkbox"/>	The antenna use of a unique coupling to the intentional radiator
<input type="checkbox"/>	The use of a nonstandard antenna jack or electrical connector
Please refer to the attached document "Internal Photograph" to show the antenna connector.	

---

## 5 TEST SETUP PHOTO AND EUT PHOTO

Remark: The test setup photo and EUT Photo please see appendix.

\_\_\_\_\_ The End \_\_\_\_\_