



Test report No:
2060819R-RF-US-P06V02

FCC & ISED TEST REPORT

Product Name	LED Device
Trademark	PHILIPS
Model and /or type reference	9290024227, 9290024228, 9290024229
FCC ID	2AGBW9290024227X(9290024227) 2AGBW9290024228X(9290024228) 2AGBW9290024229X(9290024229)
IC	20812-4227X(9290024227) 20812-4228X(9290024228) 20812-4229X(9290024229)
Applicant's name / address	Signify (China) Investment Co., Ltd Building no.9, Lane 888, Tianlin Road, Minhang District, Shanghai, 200233, China
Test method requested, standard	FCC CFR Title 47 Part 15 Subpart C Section 15.247 ANSI C63.10: 2013 KD558074 D01 15.247 Meas Guidance v05r02 RSS-Gen Issue 5 RSS-247 Issue 2
Verdict Summary	IN COMPLIANCE
Documented by (name / position & signature)	Kitty Li/Project Assistant 
Reviewed by (name / position & signature)	Frank He/ Technical Supervisor 
Approved by (name / position & signature)	Jack Zhang/ Supervisor 
Date of issue	2020-07-14
Report template No	Template_FCC 15.247-RF-V1.0

INDEX

	page
General conditions	4
Environmental conditions	4
Possible test case verdicts	5
Abbreviations	5
Document History	6
Remarks and Comments.....	6
Used Equipment	7
Uncertainty	9
1 General Information.....	10
1.1 General Description of the Item(s)	10
1.2 Antenna Information	11
1.3 Channel List	12
2 Description of Test Setup	13
2.1 Operating mode(s) used for tests.....	13
2.2 Test Configuration / Block diagram used for tests	14
2.3 Testing process	15
3 Verdict summary section	16
3.1 Standards.....	16
3.2 Deviation(s) from the Standard(s) / Test Specification(s).....	16
3.3 Overview of results.....	17
3.4 Test Facility.....	18
4 Test Results	19
4.1 AC Power Line Conducted Emission	19
4.1.1 Limit	19
4.1.2 Test Setup.....	19
4.1.3 Test Procedure.....	19
4.1.4 Test Data	20
4.2 Emissions in restricted frequency bands	22
4.2.1 Limit	22
4.2.2 Test Setup.....	24
4.2.3 Test Procedure.....	24
4.2.4 Test Data	25
4.3 Emissions in non-restricted frequency band.....	51
4.3.1 Limit	51

4.3.2	Test Setup.....	51
4.3.3	Test Procedure.....	51
4.3.4	Test Data	52
4.4	Duty cycle	53
4.4.1	Limit	53
4.4.2	Test Setup.....	53
4.4.3	Test Procedure.....	53
4.4.4	Test Data	54
4.5	Radiated Emission Band Edge	55
4.5.1	Limit	55
4.5.2	Test Setup.....	55
4.5.3	Test Procedure.....	55
4.5.4	Test Data	56
4.6	DTS Bandwidth	88
4.6.1	Limit	88
4.6.2	Test Setup.....	88
4.6.3	Test Procedure.....	88
4.6.4	Test Data	89
4.7	Fundamental emission output power	90
4.7.1	Limit	90
4.7.2	Test Setup.....	90
4.7.3	Test Procedure.....	91
4.7.4	Test Data	92
4.8	Power Density	93
4.8.1	Limit:	93
4.8.2	Test Setup.....	93
4.8.3	Test Procedure.....	93
4.8.4	Test Data	94
4.9	Antenna Requirement.....	95
4.9.1	Limit:	95
4.9.2	Antenna Connector Construction:	95
5	Test setup photo and EUT Photo.....	96

COMPETENCES AND GUARANTEES

DEKRA is a testing laboratory competent to carry out the tests described in this report.

In order to assure the traceability to other national and international laboratories, DEKRA has a calibration and maintenance program for its measurement equipment.

DEKRA guarantees the reliability of the data presented in this report, which is the result of the measurements and the tests performed to the item under test on the date and under the conditions stated in the report and it is based on the knowledge and technical facilities available at DEKRA at the time of performance of the test.

DEKRA is liable to the client for the maintenance of the confidentiality of all information related to the item under test and the results of the test.

The results presented in this Test Report apply only to the particular item under test established in this document.

IMPORTANT: No parts of this report may be reproduced or quoted out of context, in any form or by any means, except in full, without the previous written permission of DEKRA.

GENERAL CONDITIONS

Test Location	No. 99, Hongye Road, Suzhou Industrial Park Suzhou, 215006, P.R. China
Date(receive sample)	Jun. 22, 2020
Date (start test)	Jun. 22, 2020
Date (finish test)	Jul. 14, 2020

1. This report is only referred to the item that has undergone the test.
2. This report does not constitute or imply on its own an approval of the product by the Certification Bodies or Competent Authorities.
3. This document is only valid if complete; no partial reproduction can be made without previous written permission of DEKRA.
4. This test report cannot be used partially or in full for publicity and/or promotional purposes without previous written permission of DEKRA.

ENVIRONMENTAL CONDITIONS

The climatic conditions during the tests are within the limits specified by the manufacturer for the operation of the EUT and the test equipment. The climatic conditions during the tests were within the following limits:

Ambient temperature	15 °C – 35 °C
Relative Humidity air	30% - 60%

If explicitly required in the basic standard or applied product / product family standard the climatic values are recorded and documented separately in this test report.

POSSIBLE TEST CASE VERDICTS

Test case does not apply to test object	N/A
Test object does meet requirement	P (Pass) / PASS
Test object does not meet requirement	F (Fail) / FAIL
Not measured	N/M

ABBREVIATIONS

For the purposes of the present document, the following abbreviations apply:

EUT	: Equipment Under Test
QP	: Quasi-Peak
CAV	: CISPR Average
AV	: Average
CDN	: Coupling Decoupling Network
SAC	: Semi-Anechoic Chamber
OATS	: Open Area Test Site
BW	: Bandwidth
AM	: Amplitude Modulation
PM	: Pulse Modulation
HCP	: Horizontal Coupling Plane
VCP	: Vertical Coupling Plane
U_N	: Nominal voltage
T_x	: Transmitter
R_x	: Receiver
N/A	: Not Applicable
N/M	: Not Measured

DOCUMENT HISTORY

Report No.	Version	Description	Issued Date
2060819R-RF-US-P06V02	V1.0	Initial issue of report.	2020-07-14

REMARKS AND COMMENTS

1. The equipment under test (EUT) does meet the essential requirements of the stated standard(s)/test(s).
2. These test results on a sample of the device are for the purpose of demonstrating Compliance with Part 15 Subpart C Paragraph 15.247, RSS-Gen Issue 5, RSS-247 Issue 2.
3. The measurement result is considered in conformance with the requirement if it is within the prescribed limit, It is not necessary to account the uncertainty associated with the measurement result, unless the specification, standard or customer have special requirements.
4. The test results presented in this report relate only to the object tested.
5. The test results relate only to the samples tested.
6. The test report shall not be reproduced without the written approval of DEKRA Testing and Certification (Suzhou) Co., Ltd.
7. This report will not be used for social proof function in China market.

USED EQUIPMENT

AC Power Line Conducted Emission / TR1

Instrument	Manufacturer	Model No.	Serial No.	Cal. Date	Next Cal. Date
EMI Test Receiver	R&S	ESCI	100906	2020.04.20	2021.04.19
Two-Line V-Network	R&S	ENV216	101190	2019.12.28	2020.12.27
Two-Line V-Network	R&S	ENV216	101044	2019.12.28	2020.12.27
Current Probe	R&S	EZ-17	100678	2020.03.12	2021.04.11
50ohm Termination	SHX	TF2	07081402	2019.09.02	2020.09.01
50ohm Termination	SHX	TF2	07081403	2019.09.02	2020.09.01
50ohm Coaxial Switch	Anritsu	MP59B	6200464462	N/A	N/A
Temperature/Humidity Meter	RTS	RTS-8S	TR1-TH	2019.08.21	2020.08.20
Coaxial Cable	Suhner	RG 223	TR1-C1	2019.08.25	2020.08.24
Coaxial Cable	Suhner	RG 223	TR1-C2	2019.08.25	2020.08.24
Dekra test software	Dekra	-	-	-	-

Emissions in non-restricted frequency bands/ Occupied Bandwidth/ Fundamental emission output power Power Spectral Density / TR8

Instrument	Manufacturer	Model No.	Serial No.	Cal. Date	Next Cal. Date
Spectrum Analyzer	Agilent	N9010A	MY48030494	2019.09.28	2020.09.27
EXA Spectrum Analyzer	Keysight	N9010A	MY55370495	2020.04.17	2021.04.16
MXA Signal Analyzer	Keysight	N9020A	MY56060147	2019.08.30	2020.08.29
Wideband Peak Power Meter	Anritsu	ML2495A	0905006	2019.08.12	2020.08.11
Power Sensor	Anritsu	MA2411B	0846014	2019.08.12	2020.08.11
Coaxial Cable	Woken	SFL402	F02-150410-044	2020.01.01	2020.12.31
Dekra test software	Dekra	-	-	-	-

Radiated Emission(30MHz-1GHz) / AC3

Instrument	Manufacturer	Model No.	Serial No.	Cal. Date	Next Cal. Date
EMI Test Receiver	R&S	ESCI	100573	2020.03.03	2021.03.02
Bilog Antenna	Teseq GmbH	CBL6112D	27611	2019.09.23	2020.09.22
Temperature/Humidity Meter	RTS	RTS-8S	AC2-TH	2019.09.02	2020.09.01
Coaxial Cable	Huber+Suhner	RG 214	AC2-C	2020.04.13	2021.04.12
Dekra test software	Dekra	-	-	-	-

Radiated Emission / AC5(1GHz-40GHz)

Instrument	Manufacturer	Model No.	Serial No.	Cal. Date	Next Cal. Date
Spectrum Analyzer	Agilent	E4446A	MY45300103	2020.05.08	2021.05.07
Preamplifier	Miteq	NSP1800-25	1364185	2020.05.06	2021.05.05
Preamplifier	QuieTek	AP-040G	CHM-0906001	2020.05.06	2021.05.05
DRG Horn	ETS-Lindgren	3117	00123988	2020.01.22	2021.01.21
Temperature/Humidity Meter	Zhichen	ZC1-2	AC5-TH	2019.09.02	2020.09.01
Coaxial Cable	Huber+Suhner	SUCOFLEX 106	AC5-C1	2020.04.13	2021.04.12
Coaxial Cable	Huber+Suhner	SUCOFLEX 106	AC5-C2	2020.04.13	2021.04.12
Coaxial Cable	Huber+Suhner	SUCOFLEX 102	AC5-C3	2020.04.13	2021.04.12
Dekra test software	Dekra	-	-	-	-

UNCERTAINTY

Uncertainties have been calculated according to the DEKRA internal document. The reported expanded uncertainties are based on a standard uncertainty multiplied by a coverage factor of $k=2$, providing a level of confidence of approximately 95%. The Uncertainties is comply with standard required as below.

Test item	Uncertainty
AC Power Line Conducted Emission	9kHz~150kHz: 2.80 dB 150kHz~30MHz: 2.40 dB
Peak Power Output	± 1.27 dB
Radiated Emission(30MHz~1GHz)	Horizontal: 30MHz~200MHz: 3.50 dB 300MHz~1GHz: 3.60 dB Vertical: 30MHz~200MHz: 3.60 dB 300MHz~1GHz: 3.50 dB
Radiated Emission(1GHz~26.5GHz)	Horizontal: 1GHz~18GHz: 5.00 dB Vertical: 1GHz~18GHz: 4.80 dB
RF antenna conducted test	± 1.27 dB
Radiated Emission Band Edge	± 3.9 dB
DTS Bandwidth	± 150 Hz
Occupied Bandwidth	± 1 kHz
Power Density	± 1.27 dB

1 GENERAL INFORMATION

1.1 General Description of the Item(s)

Product Name..... :	LED Device
Model No. :	9290024227, 9290024228, 9290024229
FCC ID :	2AGBW9290024227X(9290024227) 2AGBW9290024228X(9290024228) 2AGBW9290024229X(9290024229)
IC..... :	20812-4227X(9290024227) 20812-4228X(9290024228) 20812-4229X(9290024229)
Manufacturer..... :	Signify (China) Investment Co., Ltd
Manufacturer Address..... :	Building no.9, Lane 888, Tianlin Road, Minhang District, Shanghai, 200233, China

Wireless specification..... :	Bluetooth 5.0					
Operating frequency range(s)	2400~2483.5MHz					
Type of Modulation..... :	GFSK					
PHYs	<input checked="" type="checkbox"/>	LE 1M	<input checked="" type="checkbox"/>	LE 2M	<input checked="" type="checkbox"/>	LE Coded S=2/8
Data Rate	<input checked="" type="checkbox"/>	1Mbit/s	<input checked="" type="checkbox"/>	2Mbit/s	<input checked="" type="checkbox"/>	500/125 Kbit/s
Number of channel..... :	40					

Rated power supply	Voltage and Frequency				
	<input type="checkbox"/>	AC: 220 – 240 V, 50/60 Hz			
	<input checked="" type="checkbox"/>	AC: 100 – 240 V, 50/60 Hz			
	<input type="checkbox"/>	DC: 3.2~4.2 Vdc			
	<input type="checkbox"/>	Battery:			
Mounting position..... :	<input type="checkbox"/>	Table top equipment			
	<input checked="" type="checkbox"/>	Wall/Ceiling mounted equipment			
	<input type="checkbox"/>	Floor standing equipment			
	<input type="checkbox"/>	Head-mounted equipment			
	<input type="checkbox"/>	Other: RF module			

Note: Models 9290024227, 9290024228, 9290024229 only differs on the length of the LED device, three models has been pretested and DEKRA has found that model 9290024227 is the worst case. Test results for Model 9290024227, included in this report, are valid and representative for the three models 9290024227, 9290024228, 9290024229.

1.2 Antenna Information

Antenna model / type number	N/A		
Antenna serial number	N/A		
Antenna Delivery	<input checked="" type="checkbox"/>	1TX + 1RX	
	<input type="checkbox"/>	2TX + 2RX	
Antenna technology	<input checked="" type="checkbox"/>	SISO	
	<input type="checkbox"/>	MIMO	<input type="checkbox"/> CDD <input type="checkbox"/> Beam-forming
Antenna Type	<input type="checkbox"/>	External	<input type="checkbox"/> Dipole
			<input type="checkbox"/> Sectorized
	<input checked="" type="checkbox"/>	Internal	<input checked="" type="checkbox"/> PIFA
			<input type="checkbox"/> PCB
			<input type="checkbox"/> Metal Monopole Antenna
		<input type="checkbox"/> Others.....	
Antenna Gain.....	2.08 dBi		

1.3 Channel List

Bluetooth Working Frequency of Each Channel:							
Channel	Frequency	Channel	Frequency	Channel	Frequency	Channel	Frequency
00	2402 MHz	01	2404 MHz	02	2406 MHz	03	2408 MHz
04	2410 MHz	05	2412 MHz	06	2414 MHz	07	2416 MHz
08	2418 MHz	09	2420 MHz	10	2422 MHz	11	2424 MHz
12	2426 MHz	13	2428 MHz	14	2430 MHz	15	2432 MHz
16	2434 MHz	17	2436 MHz	18	2438 MHz	19	2440 MHz
20	2442 MHz	21	2444 MHz	22	2446 MHz	23	2448 MHz
24	2450 MHz	25	2452 MHz	26	2454 MHz	27	2456 MHz
28	2458 MHz	29	2460 MHz	30	2462 MHz	31	2464 MHz
32	2466 MHz	33	2468 MHz	34	2470 MHz	35	2472 MHz
36	2474 MHz	37	2476 MHz	38	2478 MHz	39	2480 MHz

2 DESCRIPTION OF TEST SETUP

2.1 Operating mode(s) used for tests

During the tests the following operating mode(s) has(have) been used.

Test Mode For Bluetooth	Mode1: Transmit by LE_1Mbps
	Mode2: Transmit by LE_2Mbps
	Mode3: Transmit by LE_Coded S=2
	Mode4: Transmit by LE_Coded S=8

2.2 Test Configuration / Block diagram used for tests

Test setup Diagram- AC Line Conducted Emission Test

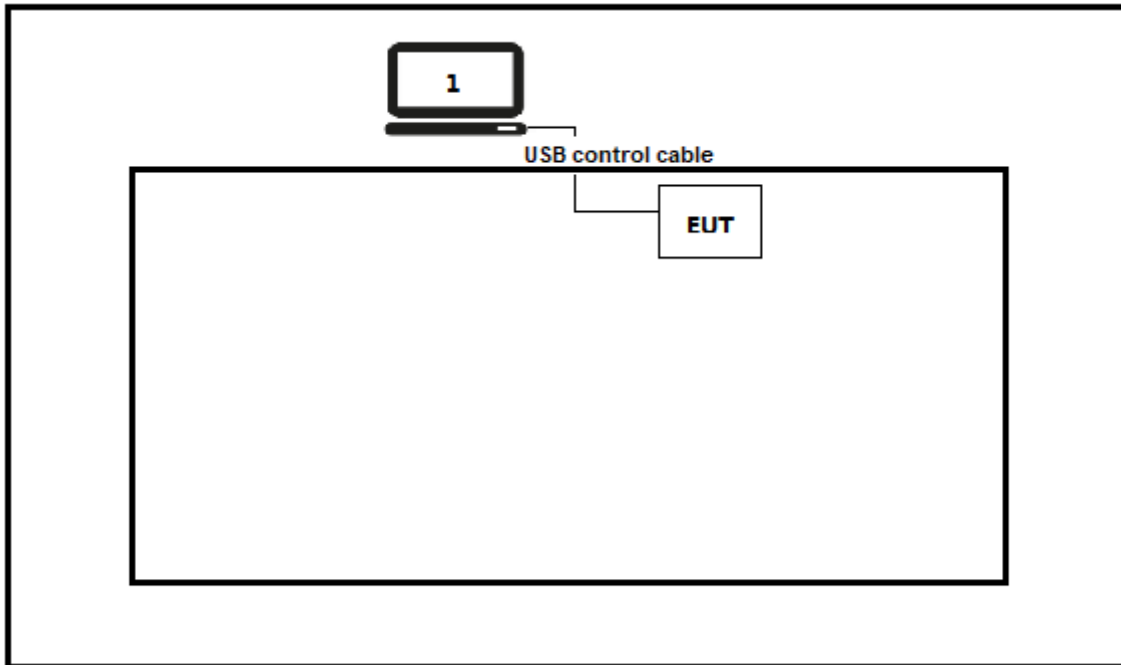

Test setup Diagram- Radiated Emission

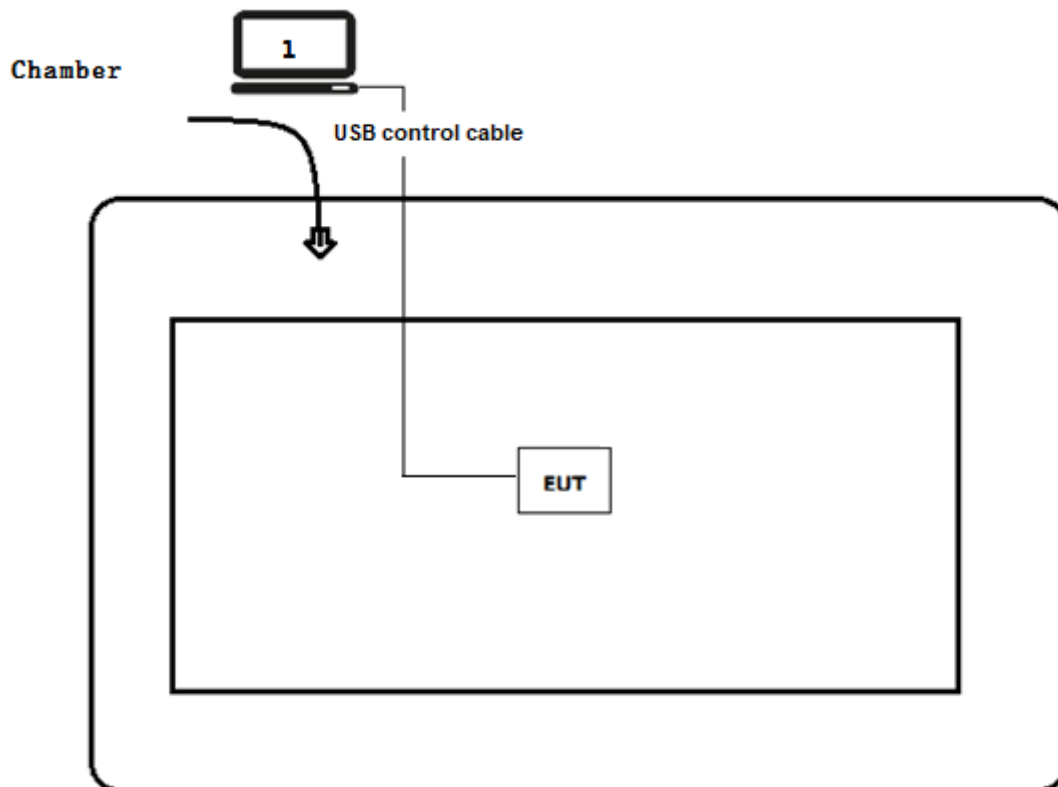

2.3 Testing process

1	Setup the EUT as shown in Section 2.2.
2	Execute Switch channel by repeating power on.
3	Configure the test mode, the test channel, and the data rate.
4	Verify that the EUT works properly.

3 VERDICT SUMMARY SECTION

This chapter presents an overview of standards and results. Refer to the next chapters for details of measured test results and applied test levels.

3.1 Standards

Standard	Year	Description
FCC CFR Title 47 Part 15 Subpart C Section 15.247	2019	Operation within the bands 902–928 MHz, 2400–2483.5 MHz, and 5725–5850 MHz.
ANSI C63.10	2013	American National Standard of Procedures for Compliance Testing of Unlicensed Wireless Devices
KDB 558074 D01 v05r02	2019	Guidance for performing compliance measurements on Digital Transmission System (DTS) operating under section 15.247
RSS-Gen Issue 5 Amendment 1	2019	General Requirements for Compliance of Radio Apparatus
RSS-247 Issue 2	2017	Digital Transmission Systems (DTSs), Frequency Hopping Systems (FHSs) and Licence-Exempt Local Area Network (LE-LAN) Devices

3.2 Deviation(s) from the Standard(s) / Test Specification(s)

The following deviation(s) was / were made from the published requirements of the listed standards: N/A.

(Please define the deviations from the standard(s) if applicable)

3.3 Overview of results

For FCC

Requirement – Test case	Basic standard(s)	Verdict	Remark
AC Power Line Conducted Emission	FCC 15.207	PASS	---
Emissions in restricted frequency bands	FCC 15.247(b)(3)	PASS	---
Duty cycle	ANSI C63.10:2013	PASS	---
Emissions in non-restricted frequency bands	FCC 15.247(d), FCC 15.209	PASS	---
Radiated Emission Band Edge	FCC 15.247(d)	PASS	---
Fundamental emission output power	FCC 15.247(d), FCC 15.209	PASS	---
DTS Bandwidth	FCC 15.247(a)(2)	PASS	---
Power Spectral Density	FCC 15.247(e)	PASS	---
Antenna Requirement	FCC 15.203	PASS	---

For ISED

Requirement – Test case	Basic standard(s)	Verdict	Remark
AC Power Line Conducted Emission	RSS-Gen Issue 5 Section 8.8	PASS	---
Emissions in restricted frequency bands	RSS-Gen Issue 5 Section 8.9	PASS	---
Duty cycle	ANSI C63.10:2013	PASS	---
Emissions in non-restricted frequency bands	RSS-247 Issue 2 Section 5.5	PASS	---
Radiated Emission Band Edge	RSS-Gen Issue 5 Section 8.10	PASS	---
Fundamental emission output power	RSS-247 Issue 2 Section 5.4(d)	PASS	---
DTS Bandwidth	RSS-Gen Issue 5 Section 6.7	PASS	---
Power Spectral Density	RSS-247 Issue 2 Section 5.2(b)	PASS	---
Antenna Requirement	RSS-Gen Issue 5 Section 6.8	PASS	---

3.4 Test Facility

USA	:	FCC Designation Number: CN1199
CA	:	ISED CAB identifier: CN0040

4 TEST RESULTS

4.1 AC Power Line Conducted Emission

VERDICT: PASS

4.1.1 Limit

Standard		
FCC Part 15 Subpart C Paragraph 15.207		
Frequency range [MHz]	Limit: QP [dB(μV) ¹⁾	Limit: AV [dB(μV) ¹⁾
0,15 - 0,50	66 - 56 ²⁾	56 - 46 ²⁾
0,50 - 5,0	56	46
5,0 - 30	60	50

¹⁾ At the transition frequency, the lower limit applies.

²⁾ The limit decreases linearly with the logarithm of the frequency.

NOTE 1: The exclusion band for transmitters shall be considered for transmitters operating at frequencies below 30 MHz.

NOTE 2: Where the AC output port is directly connected (or via a circuit breaker) to the AC power input port of the EUT the AC power output port need not to be tested.

4.1.2 Test Setup

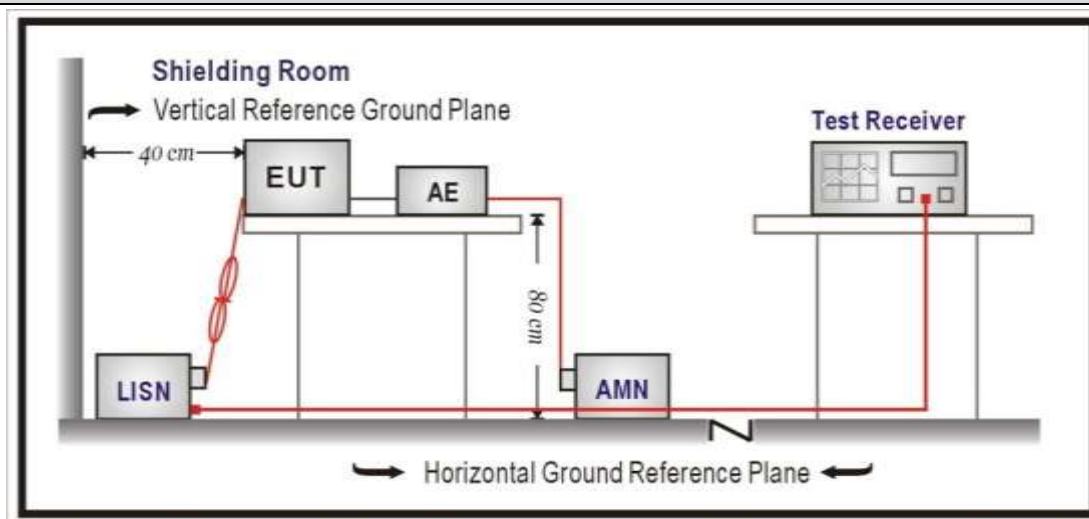

4.1.3 Test Procedure

References Rule	Chapter	Item
<input checked="" type="checkbox"/> ANSI C63.10-2013	6.2	Standard test method for ac power-line conducted emissions from unlicensed wireless devices

4.1.4 Test Data

Engineer: Canon	
Site: TR1	Time: 2020/05/11
Limit: FCC_Part15.207_CE_AC Power_ClassB	Margin: 0
Probe: ENV216_101190(0.009-30MHz)	Polarity: Line
EUT: LED Device	Power: AC 120V/60Hz
Note: Mode 1	

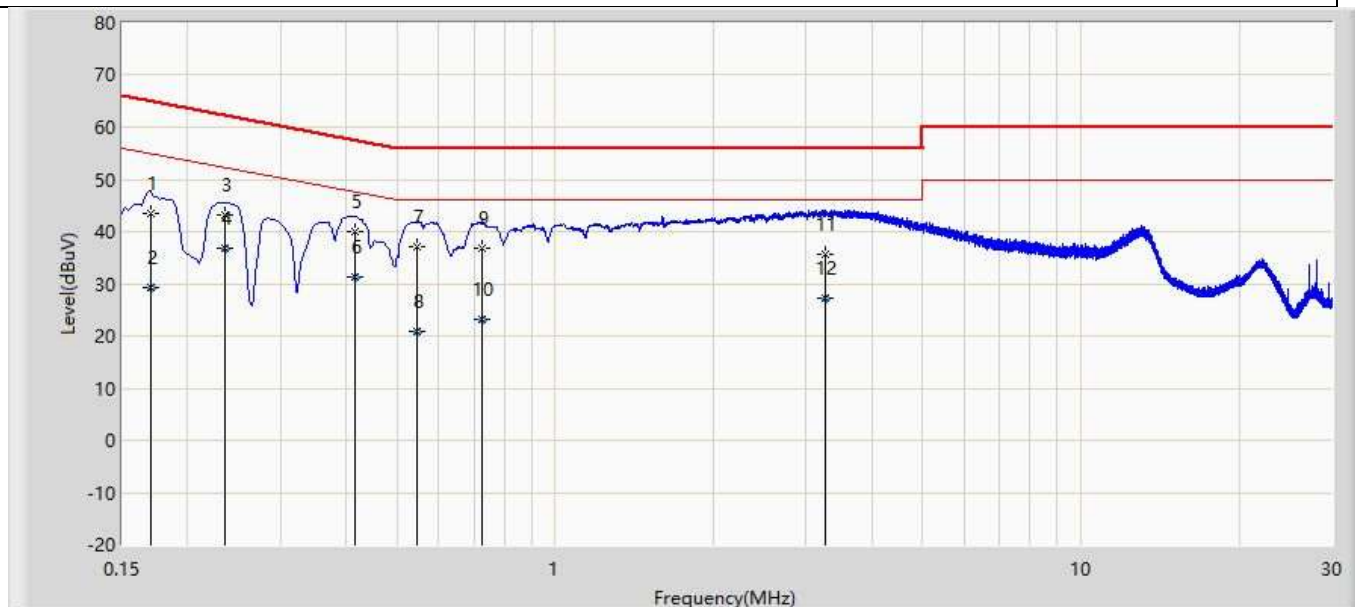

No	Mark	Frequency (MHz)	Measure Level (dBuV)	Reading Level (dBuV)	Over Limit (dB)	Limit (dBuV)	Probe (dB)	Cable (dB)	Amp (dB)	Type
1		0.170	43.593	33.986	-21.374	64.967	9.578	0.028	0.000	QP
2		0.170	29.196	19.589	-25.771	54.967	9.578	0.028	0.000	AV
3		0.235	43.229	33.608	-19.024	62.253	9.592	0.030	0.000	QP
4	*	0.235	36.820	27.198	-15.434	52.253	9.592	0.030	0.000	AV
5		0.415	39.916	30.273	-17.622	57.538	9.604	0.039	0.000	QP
6		0.415	31.352	21.709	-16.186	47.538	9.604	0.039	0.000	AV
7		0.546	37.205	27.548	-18.795	56.000	9.612	0.044	0.000	QP
8		0.546	20.760	11.104	-25.240	46.000	9.612	0.044	0.000	AV
9		0.724	36.735	27.064	-19.265	56.000	9.621	0.050	0.000	QP
10		0.724	23.133	13.462	-22.867	46.000	9.621	0.050	0.000	AV
11		3.273	35.599	25.815	-20.401	56.000	9.670	0.114	0.000	QP
12		3.273	27.204	17.420	-18.796	46.000	9.670	0.114	0.000	AV

Note:

1. " * ", means this data is the worst emission level.
2. Measurement Level = Reading Level + Factor(Probe+Cable-Amp).

Engineer: Canon	
Site: TR1	Time: 2020/05/11
Limit: FCC_Part15.207_CE_AC Power_ClassB	Margin: 0
Probe: ENV216_101190(0.009-30MHz)	Polarity: Neutral
EUT: LED Device	Power: AC 120V/60Hz
Note: Mode 1	

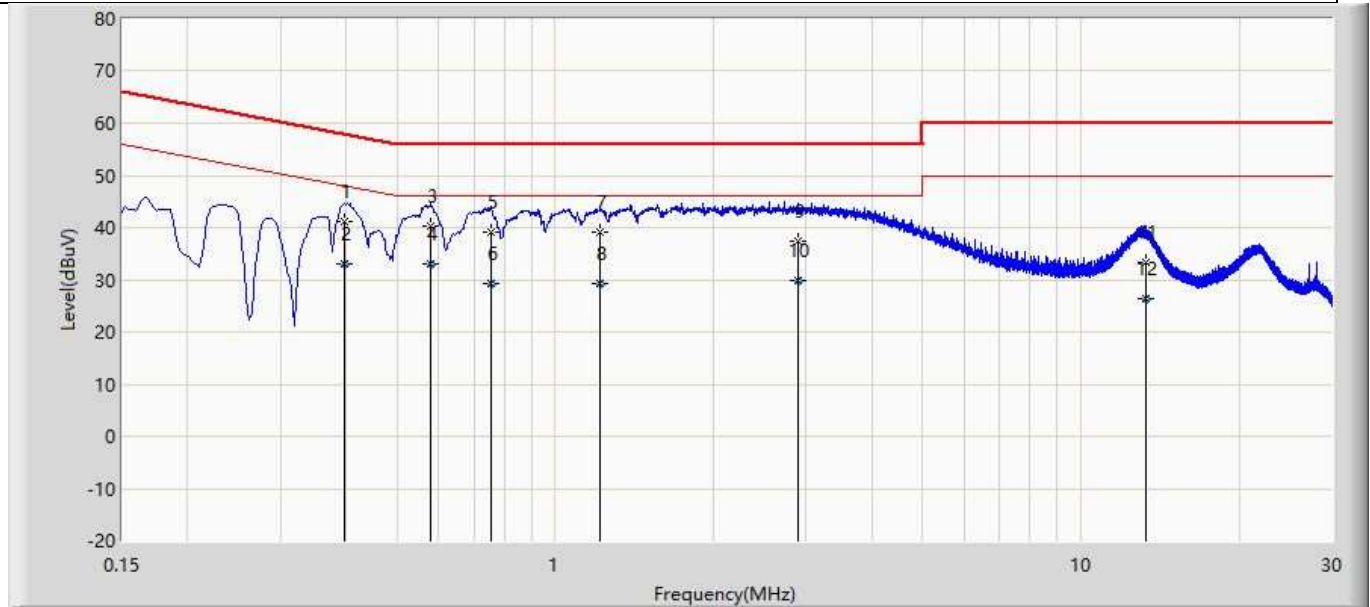

No	Mark	Frequency (MHz)	Measure Level (dBuV)	Reading Level (dBuV)	Over Limit (dB)	Limit (dBuV)	Probe (dB)	Cable (dB)	Amp (dB)	Type
1		0.398	41.029	31.388	-16.877	57.905	9.603	0.038	0.000	QP
2		0.398	33.048	23.407	-14.858	47.905	9.603	0.038	0.000	AV
3		0.580	40.296	30.636	-15.704	56.000	9.614	0.045	0.000	QP
4	*	0.580	32.922	23.262	-13.078	46.000	9.614	0.045	0.000	AV
5		0.753	39.009	29.336	-16.991	56.000	9.622	0.051	0.000	QP
6		0.753	29.363	19.690	-16.637	46.000	9.622	0.051	0.000	AV
7		1.216	39.137	29.441	-16.863	56.000	9.630	0.066	0.000	QP
8		1.216	29.224	19.528	-16.776	46.000	9.630	0.066	0.000	AV
9		2.897	37.476	27.716	-18.524	56.000	9.654	0.106	0.000	QP
10		2.897	29.949	20.189	-16.051	46.000	9.654	0.106	0.000	AV
11		13.326	33.252	23.101	-26.748	60.000	9.917	0.234	0.000	QP
12		13.326	26.281	16.130	-23.719	50.000	9.917	0.234	0.000	AV

Note:

1. " * ", means this data is the worst emission level.
2. Measurement Level = Reading Level + Factor(Probe+Cable-Amp).

4.2 Emissions in restricted frequency bands**VERDICT: PASS****4.2.1 Limit****Standard**

FCC Part 15 Subpart C Paragraph 15.209

Restricted Bands of operation

Frequency (MHz)	Frequency (MHz)	Frequency (MHz)	Frequency (GHz)
0.090 – 0.110	16.42 – 16.423	399.9 – 410	4.5 – 5.15
0.495 – 0.505	16.69475 – 16.69525	608 – 614	5.35 – 5.46
2.1735 – 2.1905	16.80425 – 16.80475	960 – 1240	7.25 – 7.75
4.125 – 4.128	25.5 – 25.67	1300 – 1427	8.025 – 8.5
4.17725 – 4.17775	37.5 – 38.25	1435 – 1626.5	9.0 – 9.2
4.20725 – 4.20775	73 – 74.6	1645.5 – 1646.5	9.3 – 9.5
6.215 – 6.218	74.8 – 75.2	1660 – 1710	10.6 – 12.7
6.26775 – 6.26825	108 – 121.94	1718.8 – 1722.2	13.25 – 13.4
6.31175 – 6.31225	123 – 138	2200 – 2300	14.47 – 14.5
8.291 – 8.294	149.9 – 150.05	2310 – 2390	15.35 – 16.2
8.362 – 8.366	156.52475 – 156.52525	2483.5 – 2500	17.7 – 21.4
8.37625 – 8.38675	156.7 – 156.9	2690 – 2900	22.01 – 23.12
8.81425 – 8.81475	162.0125 – 167.17	3260 – 3267	23.6 – 24.0
12.29 – 12.293	167.72 – 173.2	3332 – 3339	31.2 – 31.8
12.51975 – 12.52025	240 – 285	3345.8 – 3358	36.43 – 36.5
12.57675 – 12.57725	322 – 335.4	3600 – 4400	
13.36 – 13.41			

Restricted Bands of operation for IC

0.090 - 0.110	13.36 - 13.41	960 - 1427	9.0 - 9.2
0.495 - 0.505	16.42 - 16.423	1435 - 1626.5	9.3 - 9.5
2.1735 - 2.1905	16.69475 - 16.69525	1645.5 - 1646.5	10.6 - 12.7
3.020 - 3.026	16.80425 - 16.80475	1660 - 1710	13.25 - 13.4
4.125 - 4.128	25.5 - 25.67	1718.8 - 1722.2	14.47 - 14.5
4.17725 - 4.17775	37.5 - 38.25	2200 - 2300	15.35 - 16.2
4.20725 - 4.20775	73 - 74.6	2310 - 2390	17.7 - 21.4
5.677 - 5.683	74.8 - 75.2	2483.5 - 2500	22.01 - 23.12
6.215 - 6.218	108 - 138	2655 - 2900	23.6 - 24.0
6.26775 - 6.26825	149.9 - 150.05	3260 - 3267	31.2 - 31.8
6.31175 - 6.31225	156.52475 - 156.52525	3332 - 3339	36.43 - 36.5
8.291 - 8.294	156.7 - 156.9	3345.8 - 3358	Above 38.6
8.362 - 8.366	162.0125 - 167.17	3500 - 4400	
8.37625 - 8.38675	167.72 - 173.2	4500 - 5150	
8.81425 - 8.81475	240 - 285	5350 - 5460	
12.29 - 12.293	322 - 335.4	7250 - 7750	
12.51975 - 12.52025	399.9 - 410	8025 - 8500	
12.57675 - 12.57725	608 - 614	--	

Restricted Band Emissions Limit			
Frequency (MHz)	Field strength ($\mu\text{V/m}$)	Field strength ($\text{dB}\mu\text{V/m}$)	Measurement distance (m)
0.009 - 0.49	2400/F(kHz)	48.5 – 13.8	300 _(Note 1)
0.49 - 1.705	24000/F(kHz)	33.8 - 23	30 _(Note 1)
1.705 - 30	30	29.5	30 _(Note 1)
30 - 88	100	40	3 _(Note 2)
88 - 216	150	43.5	3 _(Note 2)
216 - 960	200	46	3 _(Note 2)
Above 960	500	54	3 _(Note 2)

Note 1: At frequencies below 30 MHz, measurements may be performed at a distance closer than that specified in the regulations; however, an attempt should be made to avoid making measurements in the near field. Pending the development of an appropriate measurement procedure for measurements performed below 30 MHz, when performing measurements at a closer distance than specified, the results shall be extrapolated to the specified distance by either making measurements at a minimum of two distances on at least one radial to determine the proper extrapolation factor or by using the square of an inverse linear distance extrapolation factor (40 dB/decade).

Note 2: At frequencies at or above 30 MHz, measurements may be performed at a distance other than what is specified provided: measurements are not made in the near field except where it can be shown that near field measurements are appropriate due to the characteristics of the device; and it can be demonstrated that the signal levels needed to be measured at the distance employed can be detected by the measurement equipment.

Measurements shall not be performed at a distance greater than 30 meters unless it can be further demonstrated that measurements at a distance of 30 meters or less are impractical. When performing measurements at a distance other than that specified, the results shall be extrapolated to the specified distance using an extrapolation factor of 20 dB/decade (inverse linear-distance for field strength measurements; inverse-linear-distance-squared for power density measurements).

4.2.2 Test Setup

30MHz-1GHz Test Setup:

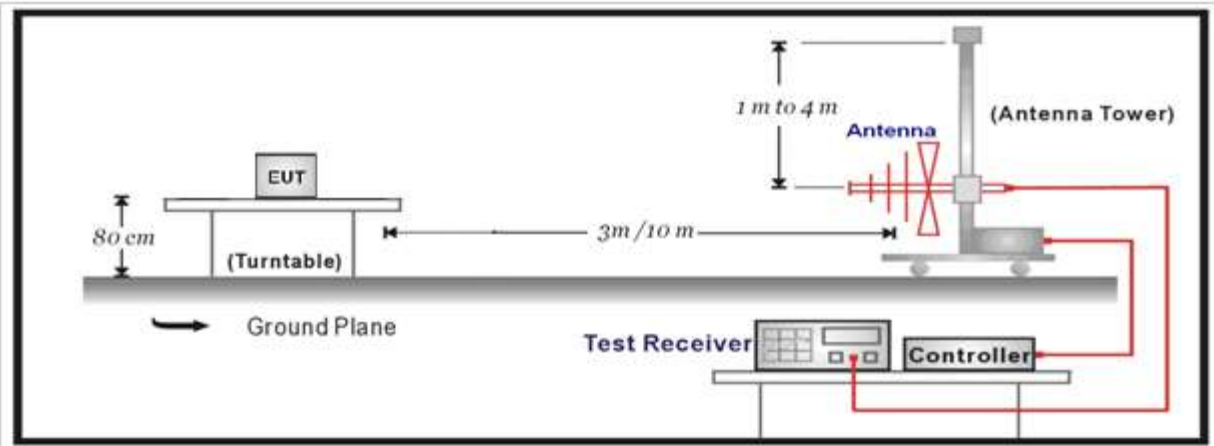

Above 1GHz Test Setup:

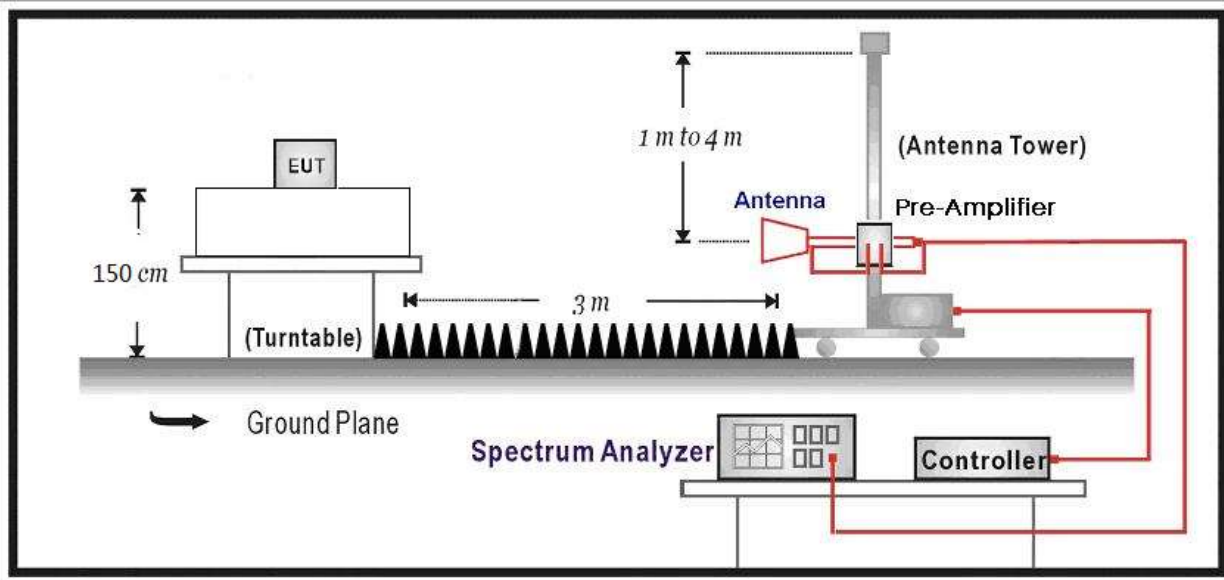

4.2.3 Test Procedure

References Rule	Chapter	Description
<input checked="" type="checkbox"/> ANSI C63.10	11.12	Emissions in restricted frequency bands
<input checked="" type="checkbox"/> ANSI C63.10	11.12.1	Radiated emission measurements
<input checked="" type="checkbox"/> ANSI C63.10	11.12.2.7	Radiated spurious emission test
<input checked="" type="checkbox"/> ANSI C63.10	6.4	Radiated emissions from unlicensed wireless devices below 30 MHz
<input checked="" type="checkbox"/> ANSI C63.10	6.5	Radiated emissions from unlicensed wireless devices in the frequency range of 30 MHz to 1000 MHz
<input checked="" type="checkbox"/> ANSI C63.10	6.6	Radiated emissions from unlicensed wireless devices above 1 GHz

4.2.4 Test Data

Profile:2060819R	Page No.: 219
Engineer: Yingfeiwang	
Site: AC5	Time: 2020/06/24 - 02:07
Limit: FCC_Part15.209_RE(3m)	Margin: 0
Probe: Horn_3117_00167055(1-18GHz)	Polarity: Horizontal
EUT: LED Device	Power: AC 120V/60Hz
Note: Mode 1:Transmit at 2402MHz by BLE_1M	

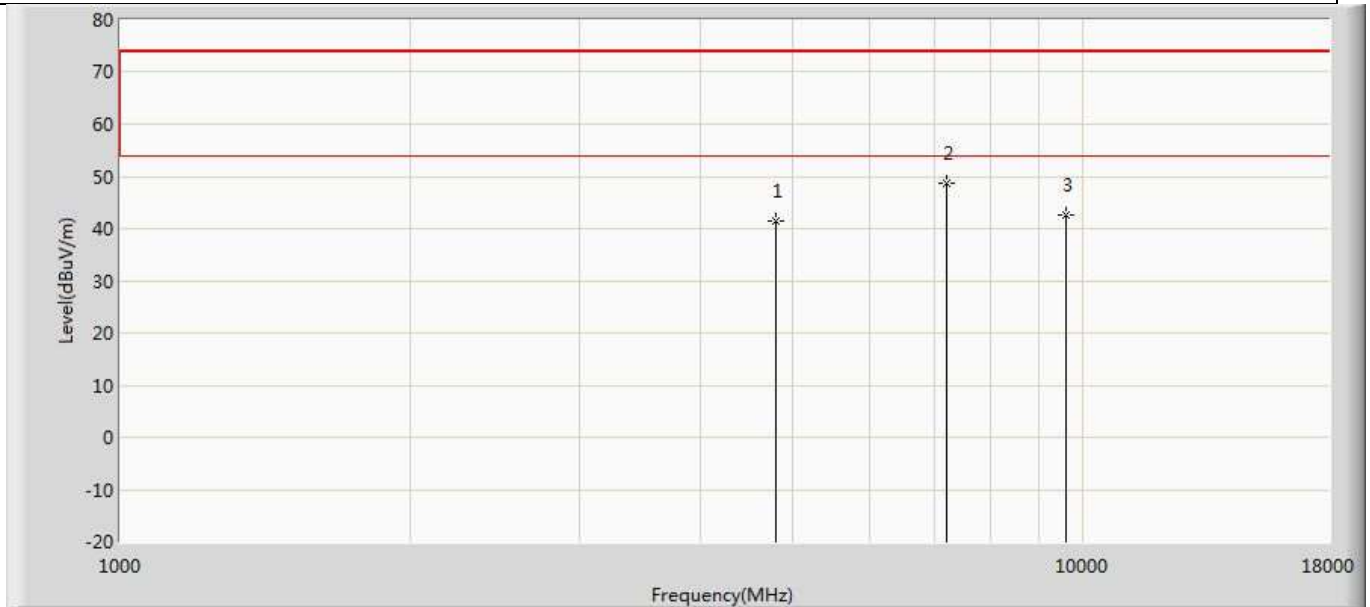

No	Mark	Frequency (MHz)	Measure Level (dBuV/m)	Reading Level (dBuV)	Over Limit (dB)	Limit (dBuV/m)	Factor (dB)	Type
1		4804.000	41.580	37.919	-32.420	74.000	3.662	PK
2	*	7206.000	48.812	42.149	-25.188	74.000	6.663	PK
3		9608.000	42.576	34.440	-31.424	74.000	8.137	PK

Profile:2060819R	Page No.: 220
Engineer:Yingfeiwang	
Site: AC5	Time: 2020/06/24 - 02:06
Limit: FCC_Part15.209_RE(3m)	Margin: 0
Probe: Horn_3117_00167055(1-18GHz)	Polarity: Vertical
EUT: LED Device	Power: AC 120V/60Hz
Note: Mode 1:Transmit at 2402MHz by BLE_1M	

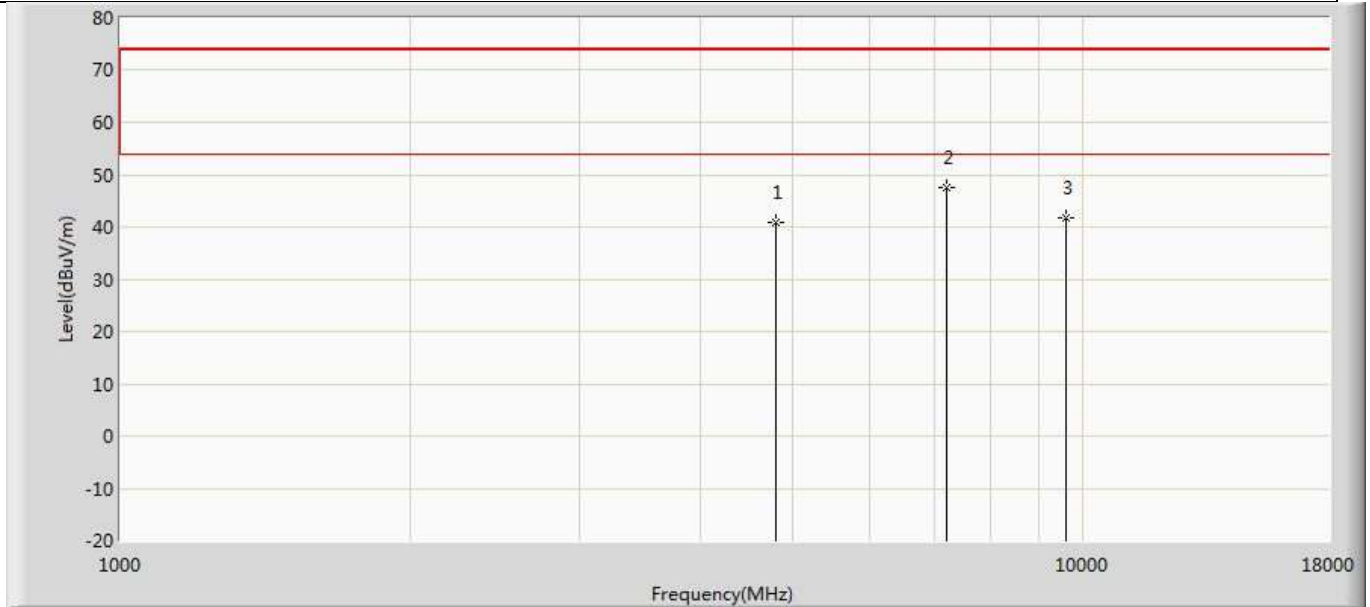

No	Mark	Frequency (MHz)	Measure Level (dBuV/m)	Reading Level (dBuV)	Over Limit (dB)	Limit (dBuV/m)	Factor (dB)	Type
1		4804.000	40.917	37.256	-33.083	74.000	3.662	PK
2	*	7206.000	47.417	40.754	-26.583	74.000	6.663	PK
3		9608.000	41.657	33.521	-32.343	74.000	8.137	PK

Profile:2060819R	Page No.: 221
Engineer:Yingfeiwang	
Site: AC5	Time: 2020/06/24 - 02:06
Limit: FCC_Part15.209_RE(3m)	Margin: 0
Probe: Horn_3117_00167055(1-18GHz)	Polarity: Horizontal
EUT: LED Device	Power: AC 120V/60Hz
Note: Mode 1:Transmit at 2440MHz by BLE_1M	

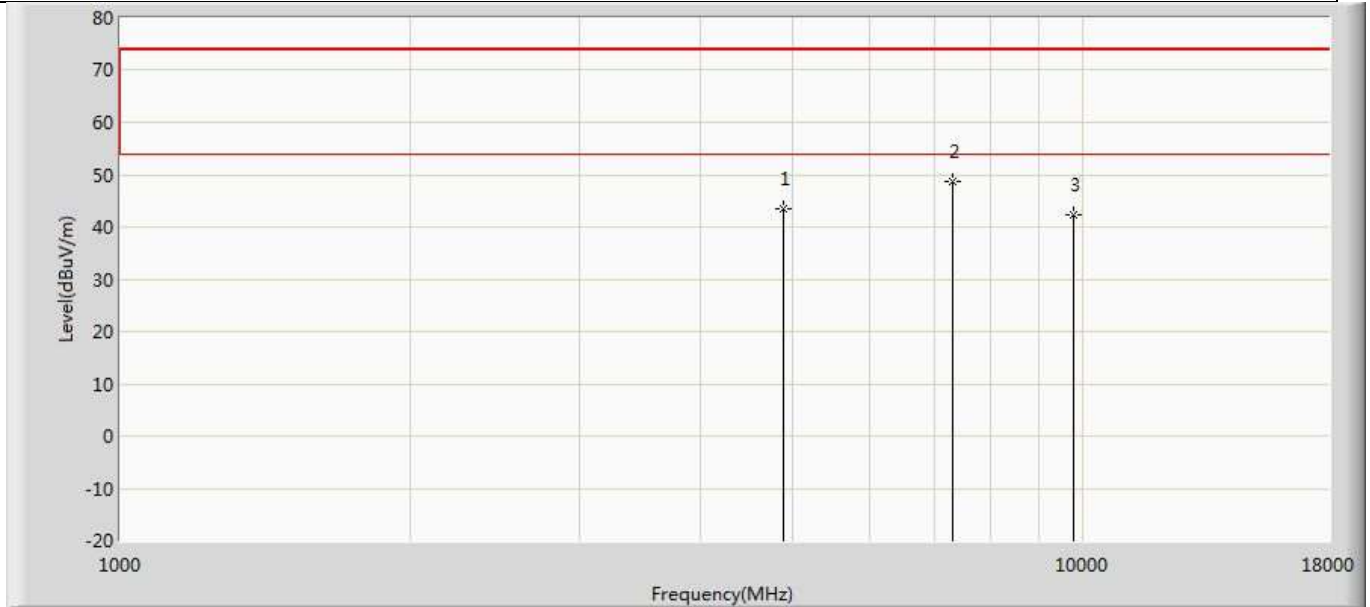

No	Mark	Frequency (MHz)	Measure Level (dBuV/m)	Reading Level (dBuV)	Over Limit (dB)	Limit (dBuV/m)	Factor (dB)	Type
1		4880.000	43.400	39.759	-30.600	74.000	3.640	PK
2	*	7320.000	48.577	41.892	-25.423	74.000	6.685	PK
3		9760.000	42.244	33.540	-31.756	74.000	8.704	PK

Profile:2060819R	Page No.: 222
Engineer:Yingfeiwang	
Site: AC5	Time: 2020/06/24 - 02:07
Limit: FCC_Part15.209_RE(3m)	Margin: 0
Probe: Horn_3117_00167055(1-18GHz)	Polarity: Vertical
EUT: LED Device	Power: AC 120V/60Hz
Note: Mode 1:Transmit at 2440MHz by BLE_1M	

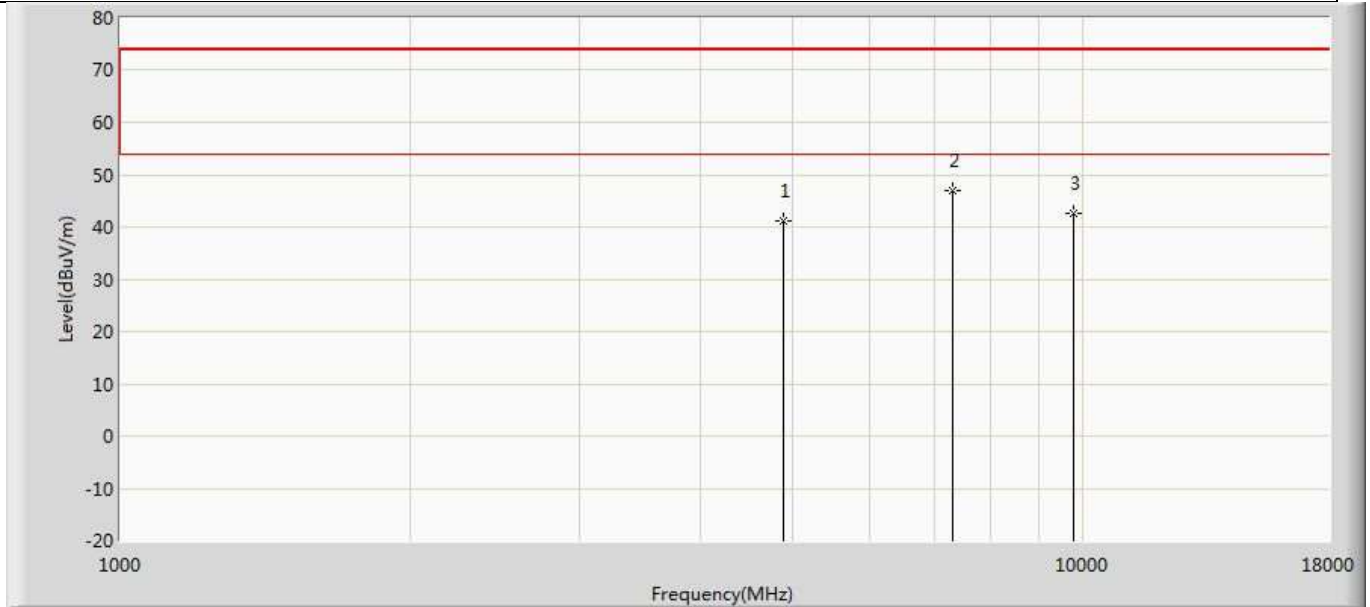

No	Mark	Frequency (MHz)	Measure Level (dBuV/m)	Reading Level (dBuV)	Over Limit (dB)	Limit (dBuV/m)	Factor (dB)	Type
1		4880.000	41.084	37.443	-32.916	74.000	3.640	PK
2	*	7320.000	47.063	40.378	-26.937	74.000	6.685	PK
3		9760.000	42.705	34.001	-31.295	74.000	8.704	PK

Profile:2060819R	Page No.: 223
Engineer:Yingfeiwang	
Site: AC5	Time: 2020/06/24 - 02:07
Limit: FCC_Part15.209_RE(3m)	Margin: 0
Probe: Horn_3117_00167055(1-18GHz)	Polarity: Horizontal
EUT: LED Device	Power: AC 120V/60Hz
Note: Mode 1:Transmit at 2480MHz by BLE_1M	

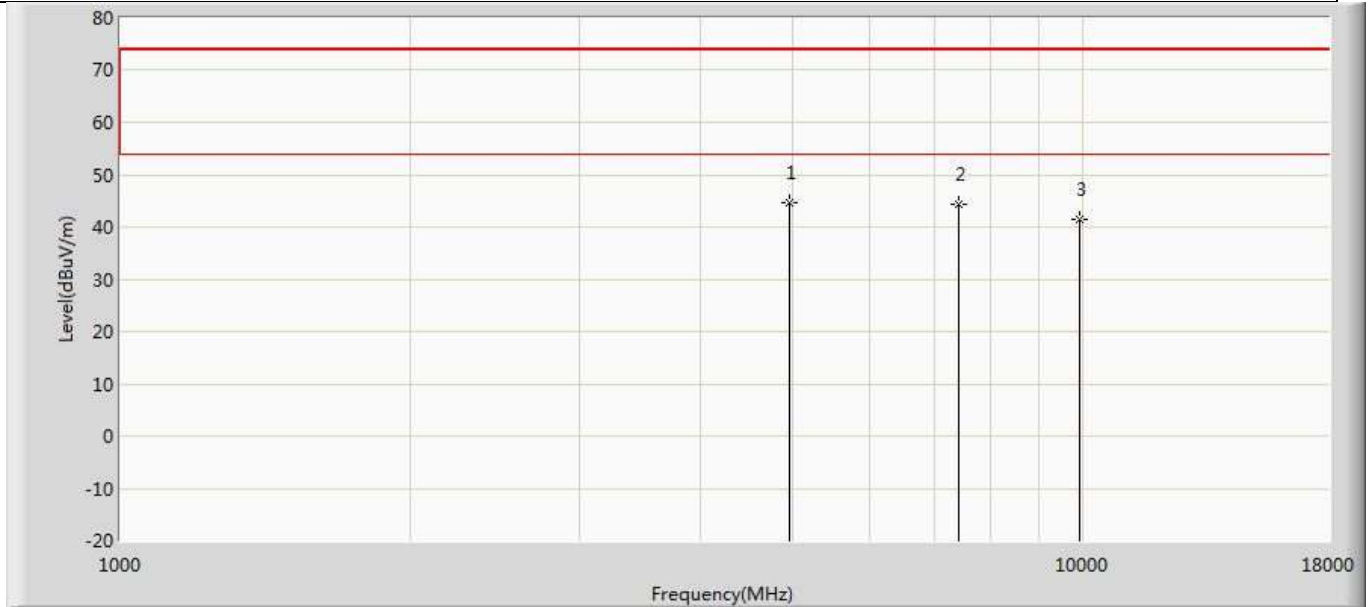

No	Mark	Frequency (MHz)	Measure Level (dBuV/m)	Reading Level (dBuV)	Over Limit (dB)	Limit (dBuV/m)	Factor (dB)	Type
1	*	4960.000	44.497	40.886	-29.503	74.000	3.611	PK
2		7440.000	44.298	37.713	-29.702	74.000	6.585	PK
3		9920.000	41.490	32.765	-32.510	74.000	8.725	PK

Profile:2060819R	Page No.: 224
Engineer:Yingfeiwang	
Site: AC5	Time: 2020/06/24 - 02:07
Limit: FCC_Part15.209_RE(3m)	Margin: 0
Probe: Horn_3117_00167055(1-18GHz)	Polarity: Vertical
EUT: LED Device	Power: AC 120V/60Hz
Note: Mode 1:Transmit at 2480MHz by BLE_1M	

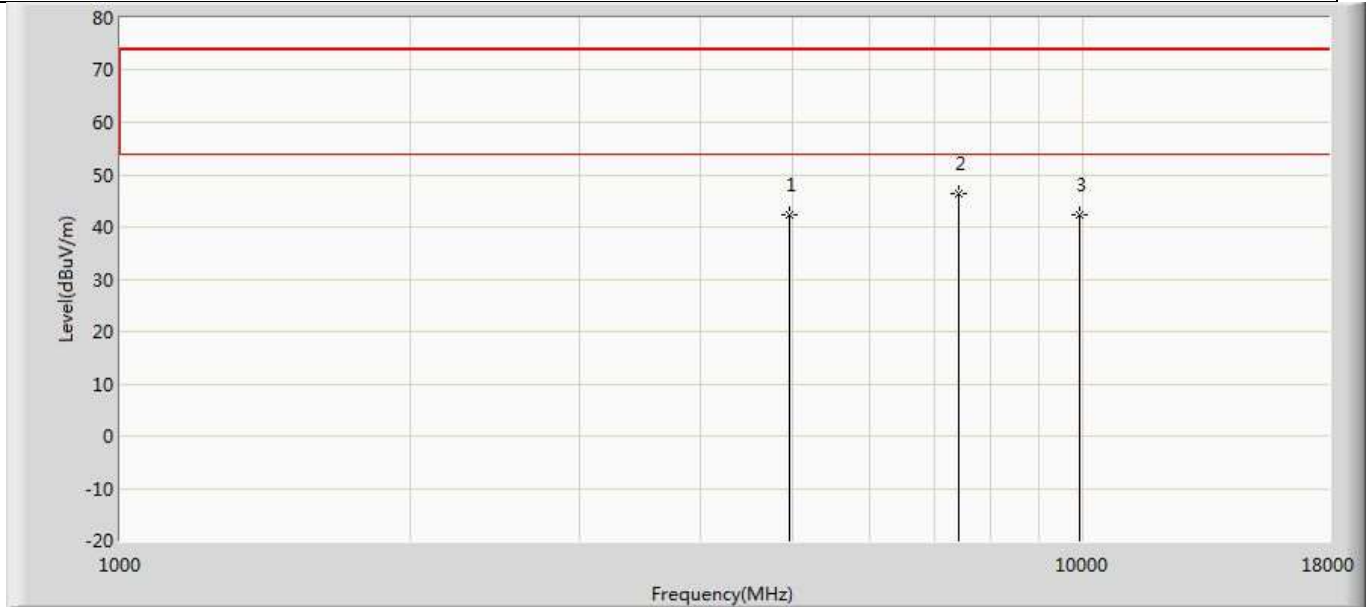

No	Mark	Frequency (MHz)	Measure Level (dBuV/m)	Reading Level (dBuV)	Over Limit (dB)	Limit (dBuV/m)	Factor (dB)	Type
1		4960.000	42.337	38.726	-31.663	74.000	3.611	PK
2	*	7440.000	46.466	39.881	-27.534	74.000	6.585	PK
3		9920.000	42.302	33.577	-31.698	74.000	8.725	PK

Profile:2060819R	Page No.: 225
Engineer:Yingfeiwang	
Site: AC5	Time: 2020/06/24 - 02:07
Limit: FCC_Part15.209_RE(3m)	Margin: 0
Probe: Horn_3117_00167055(1-18GHz)	Polarity: Horizontal
EUT: LED Device	Power: AC 120V/60Hz
Note: Mode 2:Transmit at 2402MHz by BLE_2M	

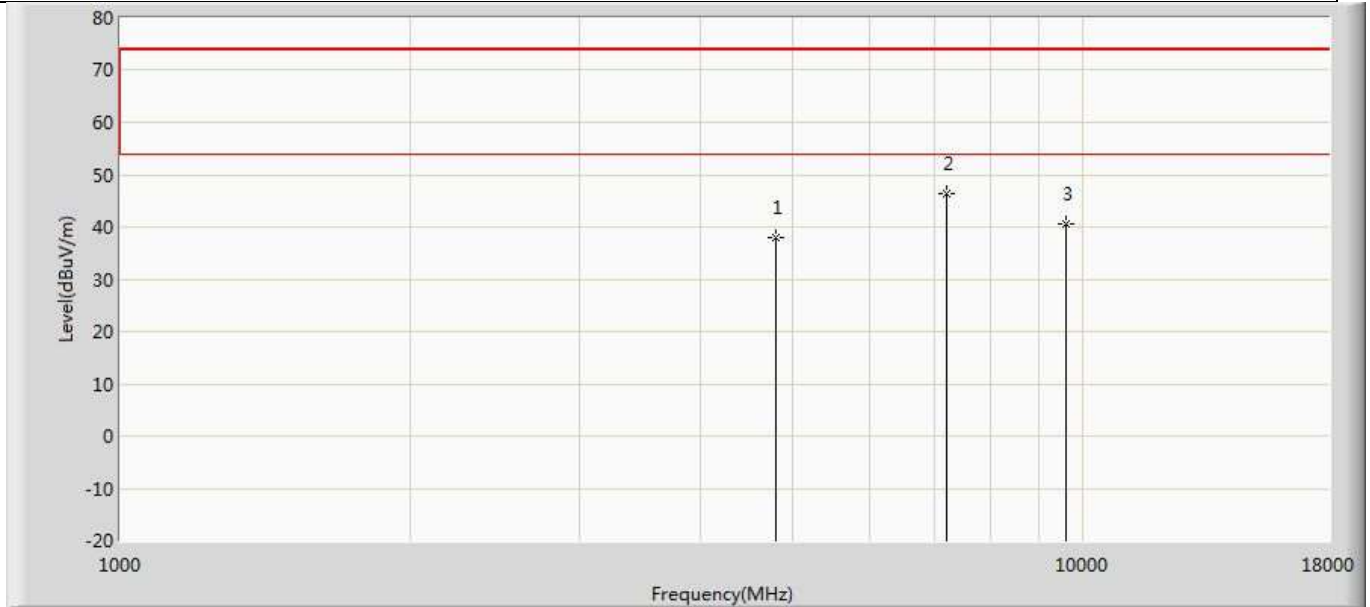

No	Mark	Frequency (MHz)	Measure Level (dBuV/m)	Reading Level (dBuV)	Over Limit (dB)	Limit (dBuV/m)	Factor (dB)	Type
1		4804.000	37.985	34.324	-36.015	74.000	3.662	PK
2	*	7206.000	46.395	39.732	-27.605	74.000	6.663	PK
3		9608.000	40.578	32.442	-33.422	74.000	8.137	PK

Profile:2060819R	Page No.: 226
Engineer:Yingfeiwang	
Site: AC5	Time: 2020/06/24 - 02:07
Limit: FCC_Part15.209_RE(3m)	Margin: 0
Probe: Horn_3117_00167055(1-18GHz)	Polarity: Vertical
EUT: LED Device	Power: AC 120V/60Hz
Note: Mode 2:Transmit at 2402MHz by BLE_2M	

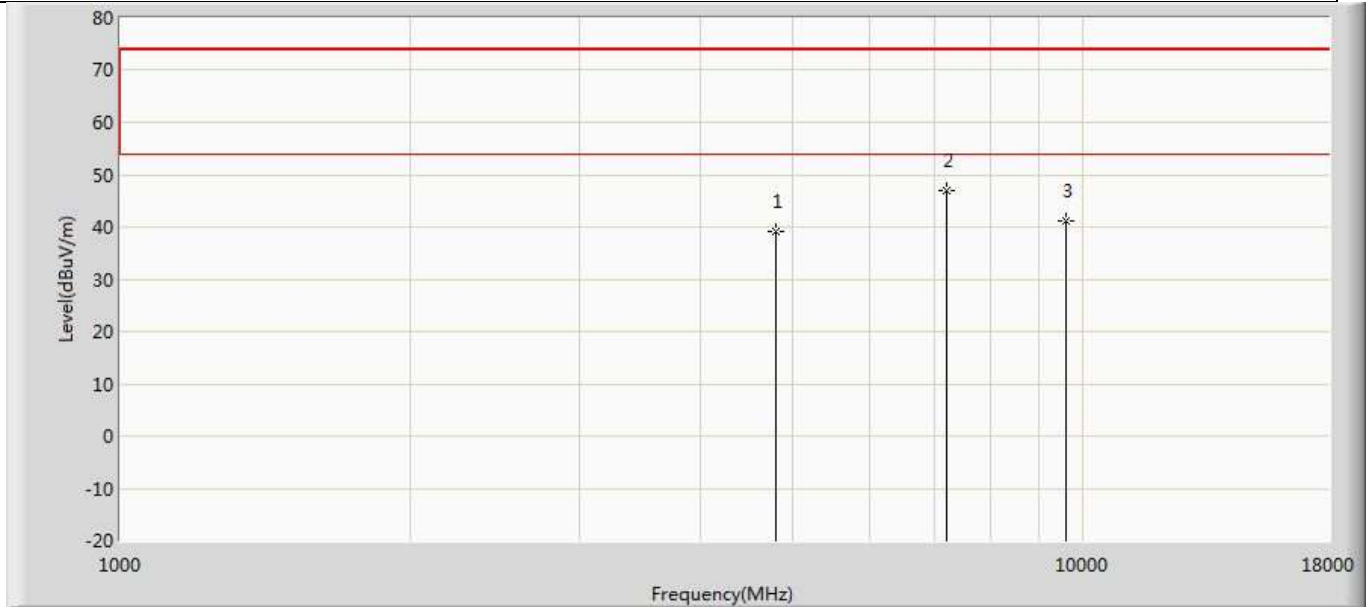

No	Mark	Frequency (MHz)	Measure Level (dBuV/m)	Reading Level (dBuV)	Over Limit (dB)	Limit (dBuV/m)	Factor (dB)	Type
1		4804.000	39.192	35.531	-34.808	74.000	3.662	PK
2	*	7206.000	46.932	40.269	-27.068	74.000	6.663	PK
3		9608.000	41.171	33.035	-32.829	74.000	8.137	PK

Profile:2060819R	Page No.: 227
Engineer:Yingfeiwang	
Site: AC5	Time: 2020/06/24 - 02:07
Limit: FCC_Part15.209_RE(3m)	Margin: 0
Probe: Horn_3117_00167055(1-18GHz)	Polarity: Horizontal
EUT: LED Device	Power: AC 120V/60Hz
Note: Mode 2:Transmit at 2440MHz by BLE_2M	

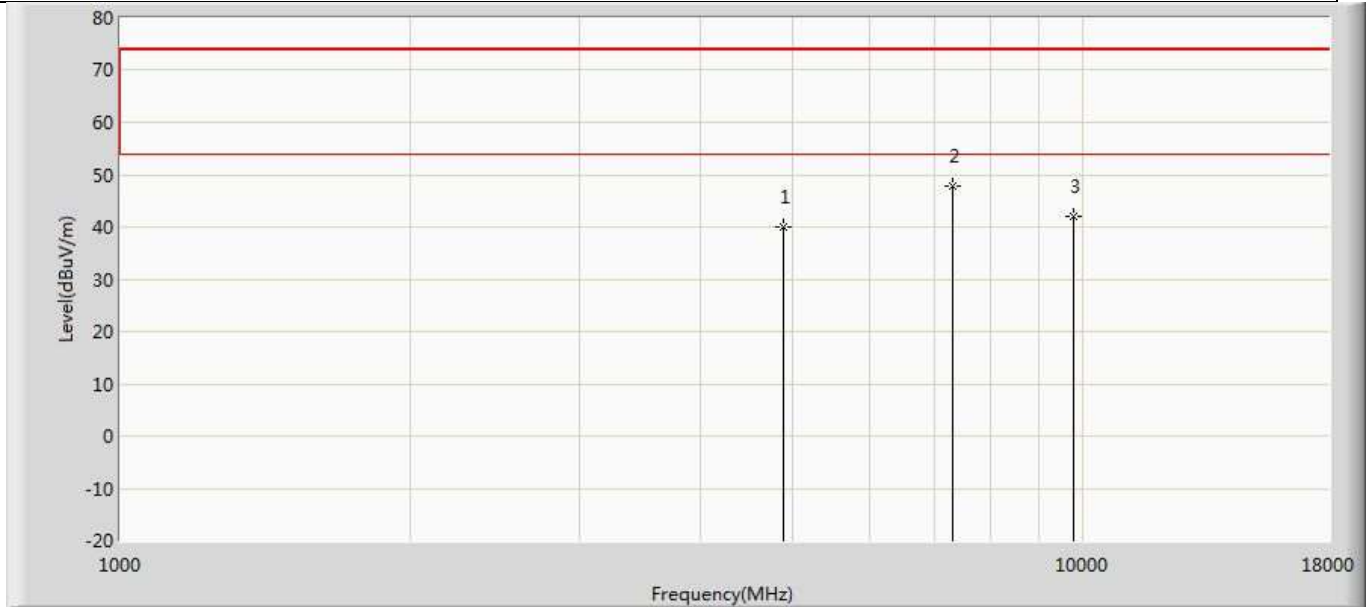

No	Mark	Frequency (MHz)	Measure Level (dBuV/m)	Reading Level (dBuV)	Over Limit (dB)	Limit (dBuV/m)	Factor (dB)	Type
1		4880.000	39.900	36.259	-34.100	74.000	3.640	PK
2	*	7320.000	47.950	41.265	-26.050	74.000	6.685	PK
3		9760.000	42.162	33.458	-31.838	74.000	8.704	PK

Profile:2060819R	Page No.: 228
Engineer:Yingfeiwang	
Site: AC5	Time: 2020/06/24 - 02:07
Limit: FCC_Part15.209_RE(3m)	Margin: 0
Probe: Horn_3117_00167055(1-18GHz)	Polarity: Vertical
EUT: LED Device	Power: AC 120V/60Hz
Note: Mode 2:Transmit at 2440MHz by BLE_2M	

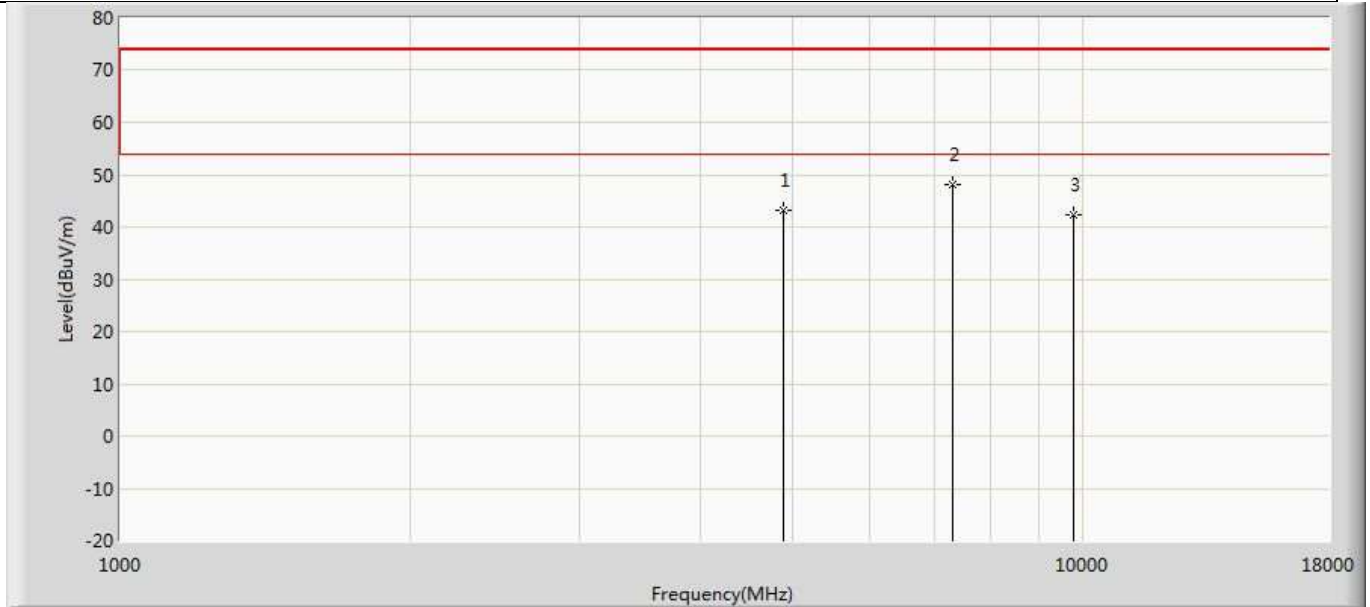

No	Mark	Frequency (MHz)	Measure Level (dBuV/m)	Reading Level (dBuV)	Over Limit (dB)	Limit (dBuV/m)	Factor (dB)	Type
1		4880.000	43.236	39.595	-30.764	74.000	3.640	PK
2	*	7320.000	48.143	41.458	-25.857	74.000	6.685	PK
3		9760.000	42.264	33.560	-31.736	74.000	8.704	PK

Profile:2060819R	Page No.: 229
Engineer:Yingfeiwang	
Site: AC5	Time: 2020/06/24 - 02:07
Limit: FCC_Part15.209_RE(3m)	Margin: 0
Probe: Horn_3117_00167055(1-18GHz)	Polarity: Horizontal
EUT: LED Device	Power: AC 120V/60Hz
Note: Mode 2:Transmit at 2480MHz by BLE_2M	

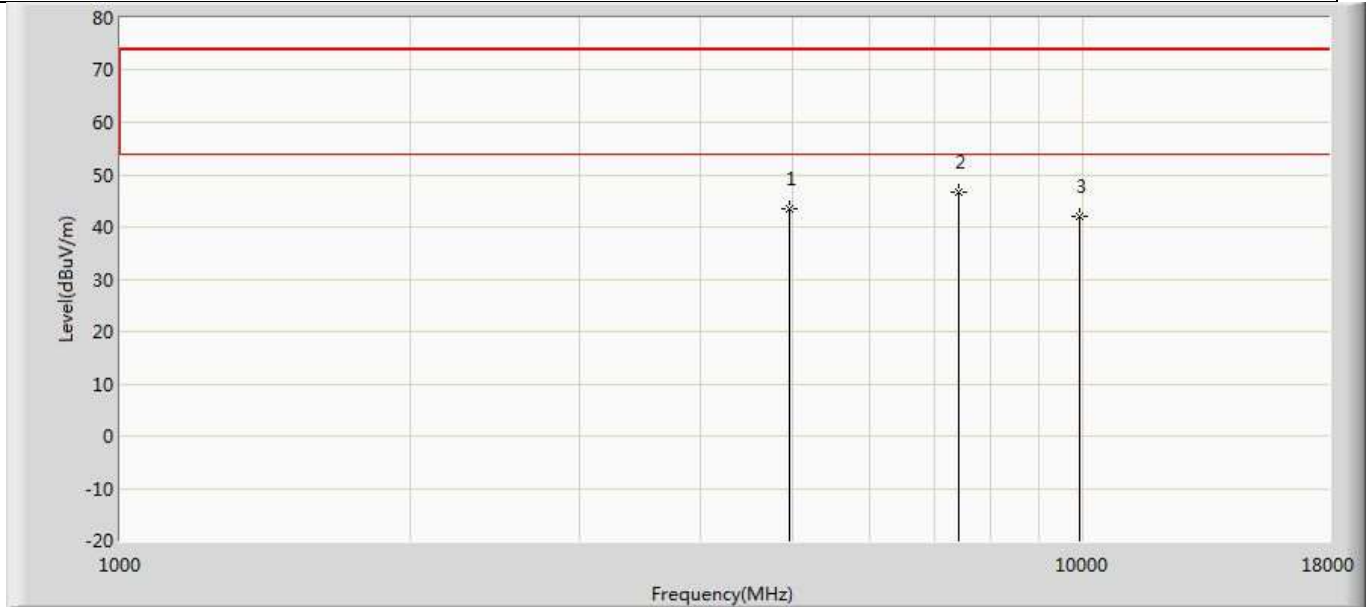

No	Mark	Frequency (MHz)	Measure Level (dBuV/m)	Reading Level (dBuV)	Over Limit (dB)	Limit (dBuV/m)	Factor (dB)	Type
1		4960.000	43.601	39.990	-30.399	74.000	3.611	PK
2	*	7440.000	46.572	39.987	-27.428	74.000	6.585	PK
3		9920.000	41.929	33.204	-32.071	74.000	8.725	PK

Profile:2060819R	Page No.: 230
Engineer:Yingfeiwang	
Site: AC5	Time: 2020/06/24 - 02:08
Limit: FCC_Part15.209_RE(3m)	Margin: 0
Probe: Horn_3117_00167055(1-18GHz)	Polarity: Vertical
EUT: LED Device	Power: AC 120V/60Hz
Note: Mode 2:Transmit at 2480MHz by BLE_2M	

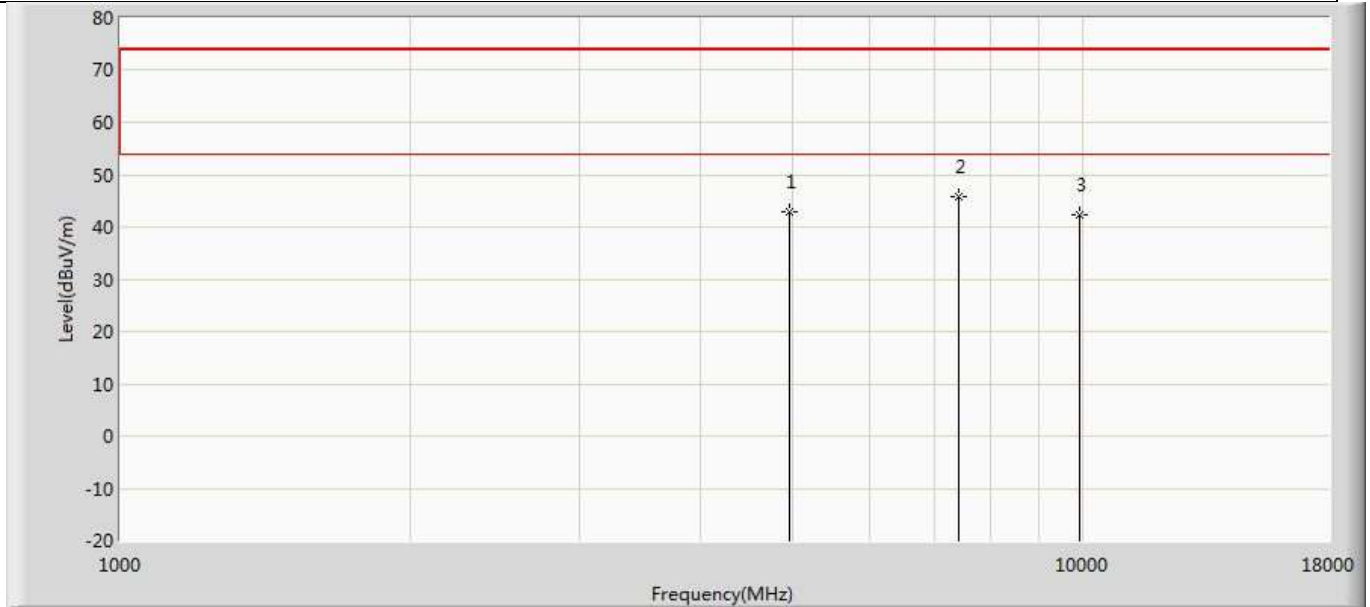

No	Mark	Frequency (MHz)	Measure Level (dBuV/m)	Reading Level (dBuV)	Over Limit (dB)	Limit (dBuV/m)	Factor (dB)	Type
1		4960.000	42.874	39.263	-31.126	74.000	3.611	PK
2	*	7440.000	45.822	39.237	-28.178	74.000	6.585	PK
3		9920.000	42.393	33.668	-31.607	74.000	8.725	PK

Profile:2060819R	Page No.: 231
Engineer:Yingfeiwang	
Site: AC5	Time: 2020/06/24 - 02:09
Limit: FCC_Part15.209_RE(3m)	Margin: 0
Probe: Horn_3117_00167055(1-18GHz)	Polarity: Horizontal
EUT: LED Device	Power: AC 120V/60Hz
Note: Mode 3:Transmit at 2402MHz by BLE_C8	

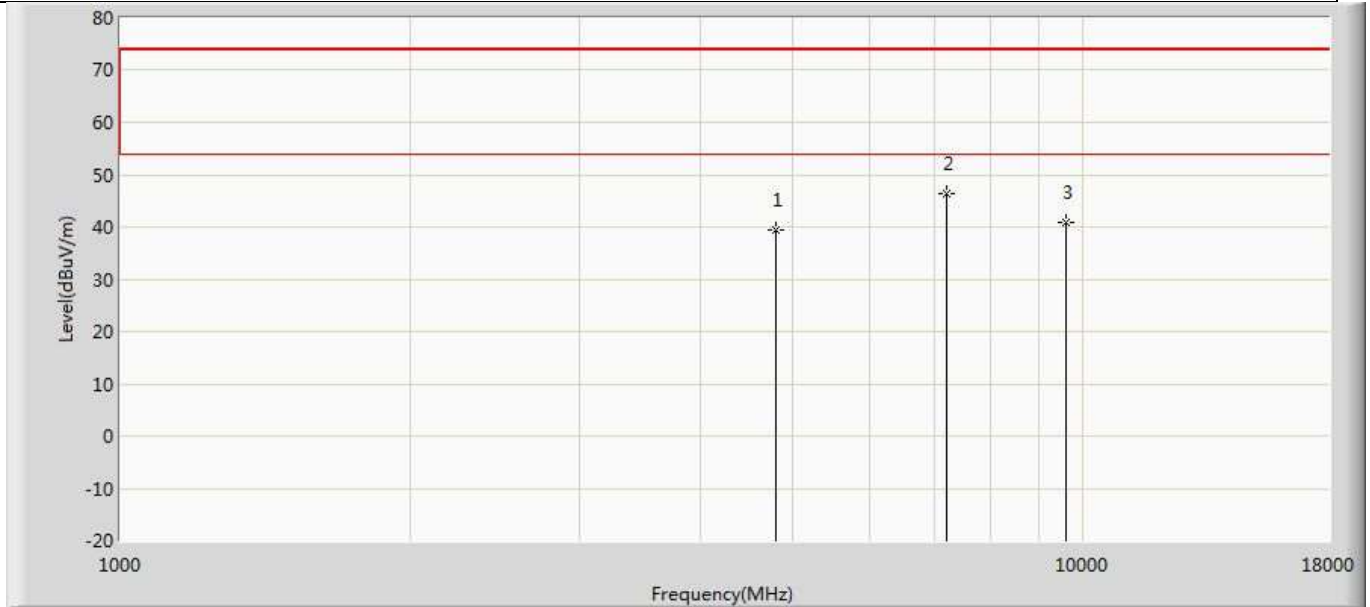

No	Mark	Frequency (MHz)	Measure Level (dBuV/m)	Reading Level (dBuV)	Over Limit (dB)	Limit (dBuV/m)	Factor (dB)	Type
1		4804.000	39.529	35.868	-34.471	74.000	3.662	PK
2	*	7206.000	46.306	39.643	-27.694	74.000	6.663	PK
3		9608.000	40.803	32.667	-33.197	74.000	8.137	PK

Profile:2060819R	Page No.: 232
Engineer:Yingfeiwang	
Site: AC5	Time: 2020/06/24 - 02:12
Limit: FCC_Part15.209_RE(3m)	Margin: 0
Probe: Horn_3117_00167055(1-18GHz)	Polarity: Vertical
EUT: LED Device	Power: AC 120V/60Hz
Note: Mode 3:Transmit at 2402MHz by BLE_C8	

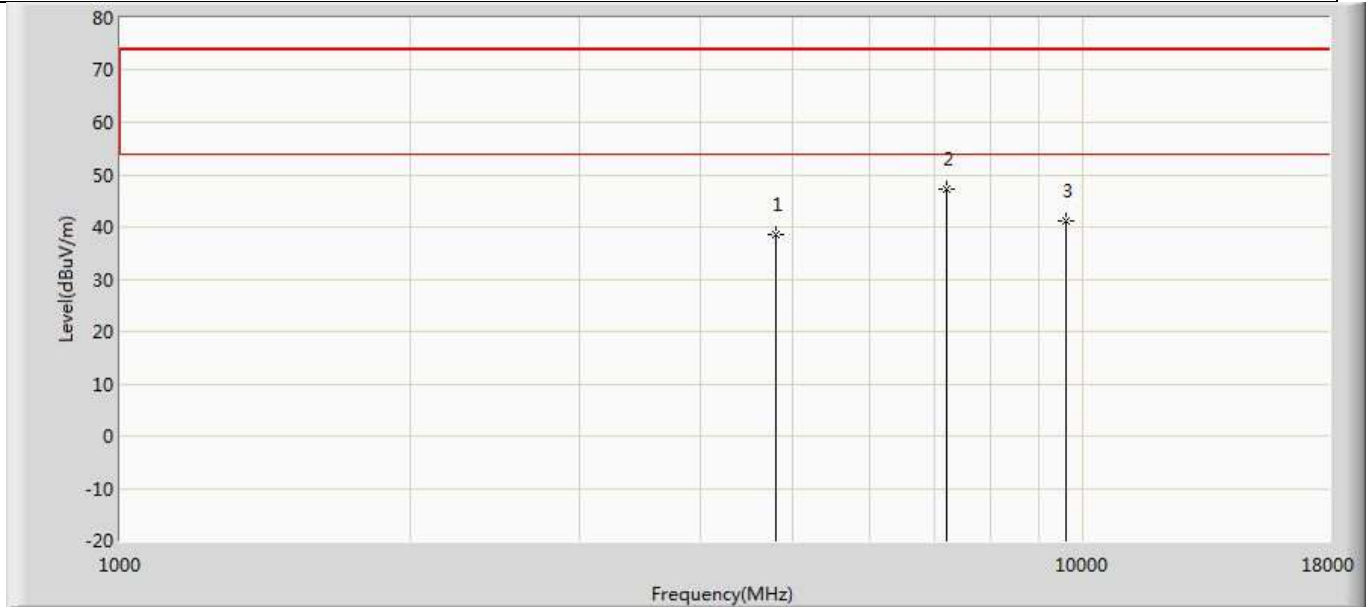

No	Mark	Frequency (MHz)	Measure Level (dBuV/m)	Reading Level (dBuV)	Over Limit (dB)	Limit (dBuV/m)	Factor (dB)	Type
1		4804.000	38.605	34.944	-35.395	74.000	3.662	PK
2	*	7206.000	47.145	40.482	-26.855	74.000	6.663	PK
3		9608.000	41.243	33.107	-32.757	74.000	8.137	PK

Profile:2060819R	Page No.: 233
Engineer:Yingfeiwang	
Site: AC5	Time: 2020/06/24 - 02:12
Limit: FCC_Part15.209_RE(3m)	Margin: 0
Probe: Horn_3117_00167055(1-18GHz)	Polarity: Horizontal
EUT: LED Device	Power: AC 120V/60Hz
Note: Mode 3:Transmit at 2440MHz by BLE_C8	

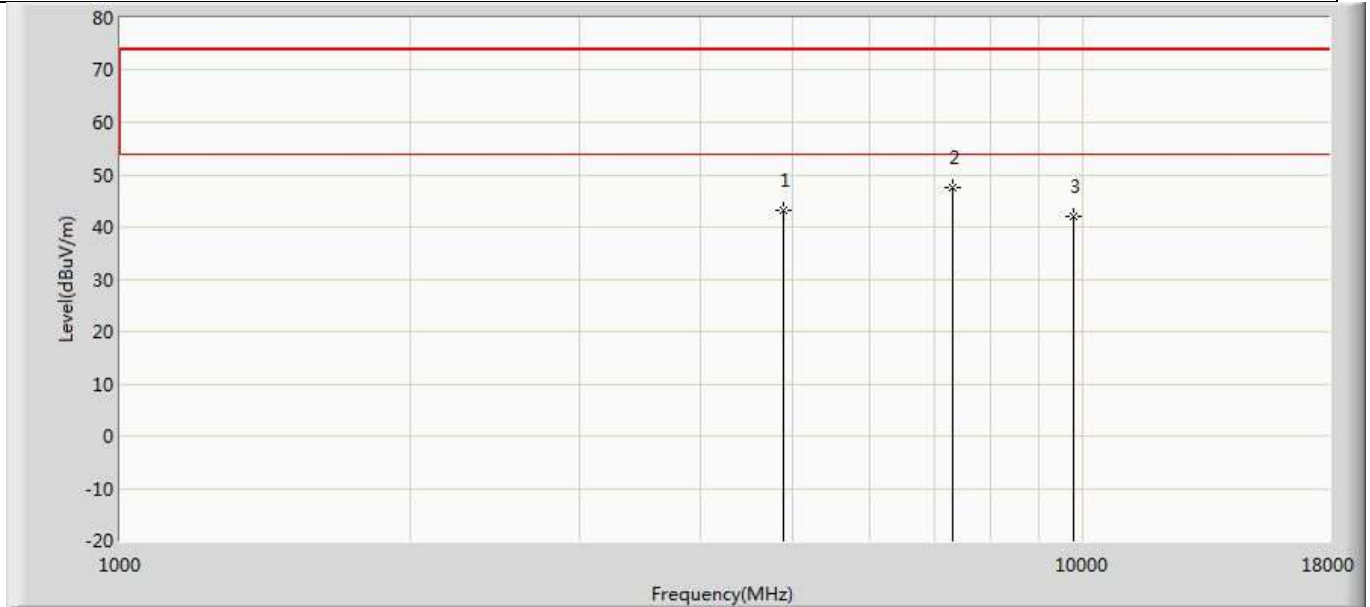

No	Mark	Frequency (MHz)	Measure Level (dBuV/m)	Reading Level (dBuV)	Over Limit (dB)	Limit (dBuV/m)	Factor (dB)	Type
1		4880.000	43.323	39.682	-30.677	74.000	3.640	PK
2	*	7320.000	47.595	40.910	-26.405	74.000	6.685	PK
3		9760.000	42.043	33.339	-31.957	74.000	8.704	PK

Profile:2060819R	Page No.: 234
Engineer:Yingfeiwang	
Site: AC5	Time: 2020/06/24 - 02:12
Limit: FCC_Part15.209_RE(3m)	Margin: 0
Probe: Horn_3117_00167055(1-18GHz)	Polarity: Vertical
EUT: LED Device	Power: AC 120V/60Hz
Note: Mode 3:Transmit at 2440MHz by BLE_C8	

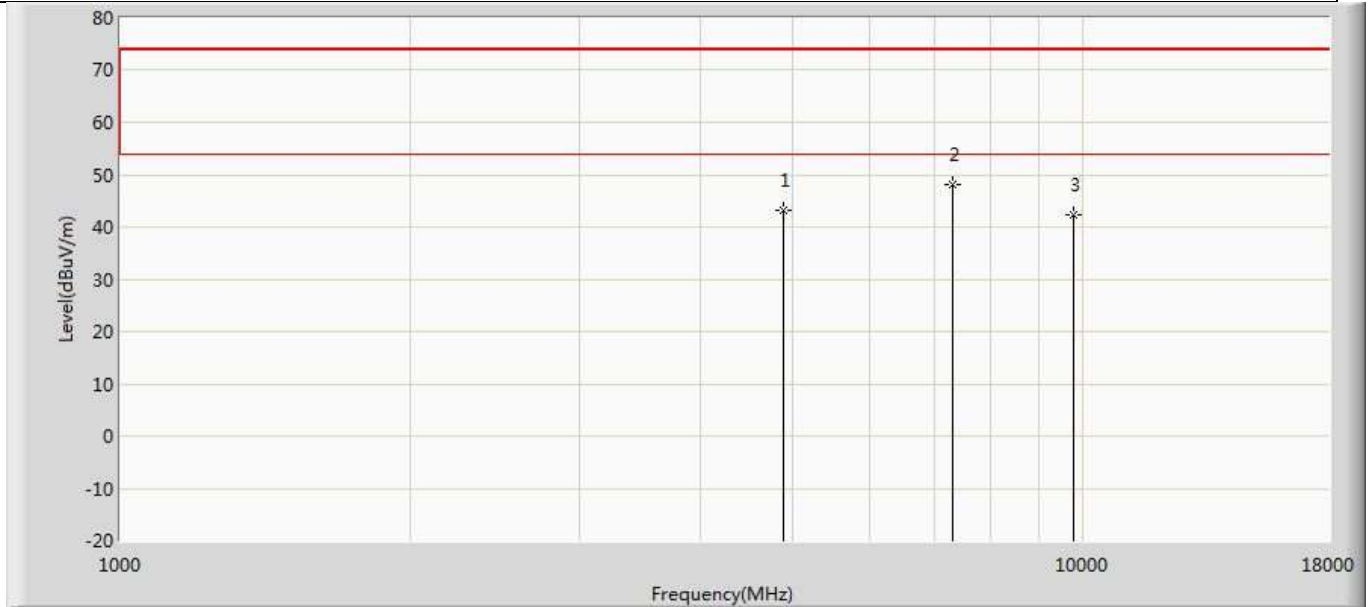

No	Mark	Frequency (MHz)	Measure Level (dBuV/m)	Reading Level (dBuV)	Over Limit (dB)	Limit (dBuV/m)	Factor (dB)	Type
1		4880.000	43.157	39.516	-30.843	74.000	3.640	PK
2	*	7320.000	48.146	41.461	-25.854	74.000	6.685	PK
3		9760.000	42.297	33.593	-31.703	74.000	8.704	PK

Profile:2060819R	Page No.: 235
Engineer:Yingfeiwang	
Site: AC5	Time: 2020/06/24 - 02:12
Limit: FCC_Part15.209_RE(3m)	Margin: 0
Probe: Horn_3117_00167055(1-18GHz)	Polarity: Horizontal
EUT: LED Device	Power: AC 120V/60Hz
Note: Mode 3:Transmit at 2480MHz by BLE_C8	

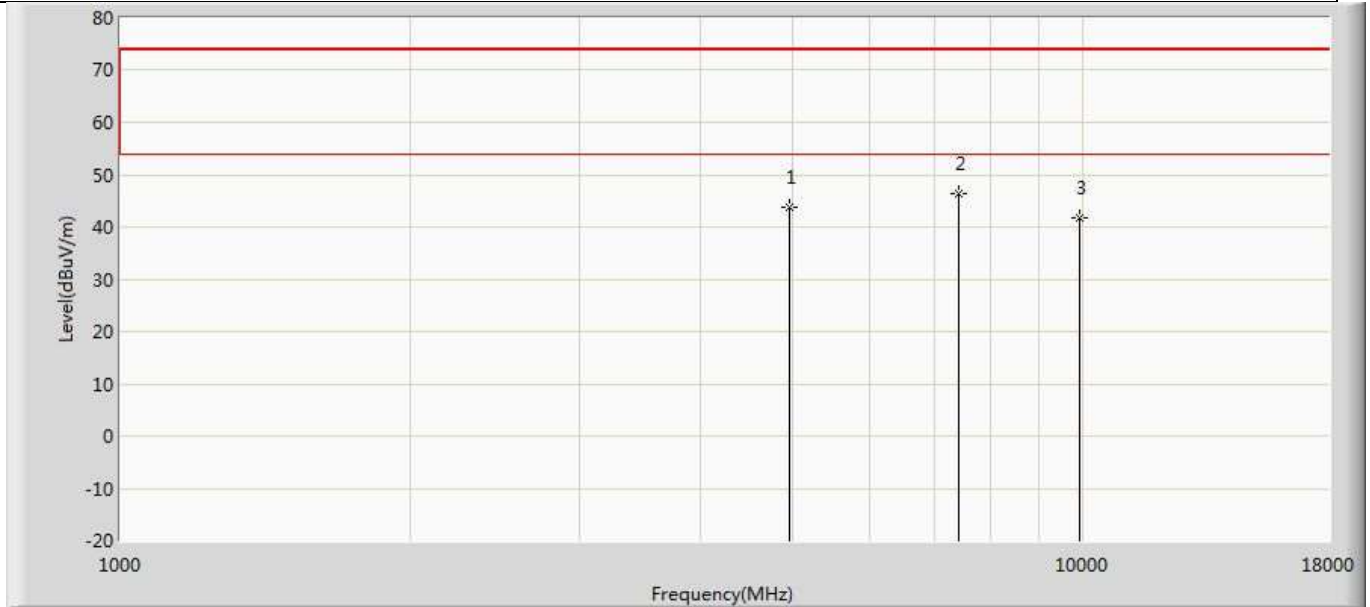

No	Mark	Frequency (MHz)	Measure Level (dBuV/m)	Reading Level (dBuV)	Over Limit (dB)	Limit (dBuV/m)	Factor (dB)	Type
1		4960.000	43.848	40.237	-30.152	74.000	3.611	PK
2	*	7440.000	46.293	39.708	-27.707	74.000	6.585	PK
3		9920.000	41.729	33.004	-32.271	74.000	8.725	PK

Profile:2060819R	Page No.: 236
Engineer:Yingfeiwang	
Site: AC5	Time: 2020/06/24 - 02:13
Limit: FCC_Part15.209_RE(3m)	Margin: 0
Probe: Horn_3117_00167055(1-18GHz)	Polarity: Vertical
EUT: LED Device	Power: AC 120V/60Hz
Note: Mode 3:Transmit at 2480MHz by BLE_C8	

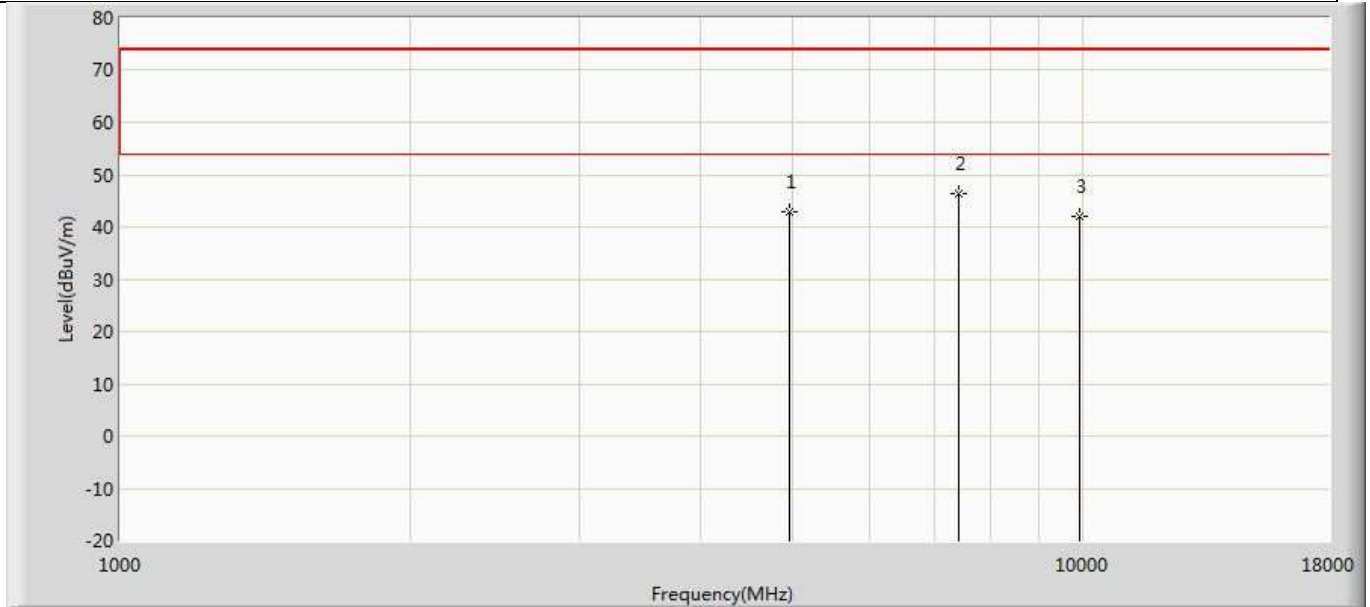

No	Mark	Frequency (MHz)	Measure Level (dBuV/m)	Reading Level (dBuV)	Over Limit (dB)	Limit (dBuV/m)	Factor (dB)	Type
1		4960.000	43.003	39.392	-30.997	74.000	3.611	PK
2	*	7440.000	46.320	39.735	-27.680	74.000	6.585	PK
3		9920.000	42.101	33.376	-31.899	74.000	8.725	PK

Profile: 2060819R	Page No.: 237
Engineer:Yingfeiwang	
Site: AC5	Time: 2020/06/24 - 02:29
Limit: FCC_Part15.209_RE(3m)	Margin: 0
Probe: Horn_3117_00167055(1-18GHz)	Polarity: Horizontal
EUT: LED Device	Power: AC 120V/60Hz
Note: Mode 4:Transmit at 2402MHz by BLE_C2	

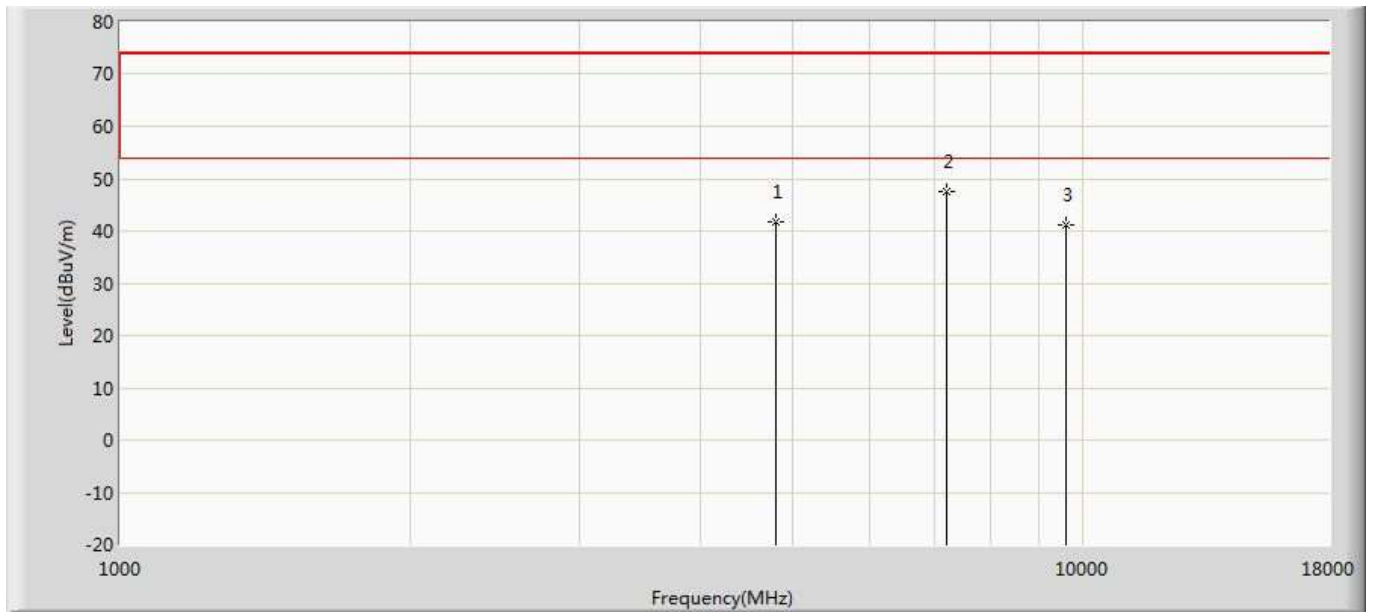

No	Mark	Frequency (MHz)	Measure Level (dBuV/m)	Reading Level (dBuV)	Over Limit (dB)	Limit (dBuV/m)	Factor (dB)	Type
1		4804.000	41.772	38.111	-32.228	74.000	3.662	PK
2	*	7206.000	47.421	40.758	-26.579	74.000	6.663	PK
3		9608.000	41.287	33.151	-32.713	74.000	8.137	PK

Profile: 2060819R	Page No.: 238
Engineer: Yingfeiwang	
Site: AC5	Time: 2020/06/24 - 02:30
Limit: FCC_Part15.209_RE(3m)	Margin: 0
Probe: Horn_3117_00167055(1-18GHz)	Polarity: Vertical
EUT: LED Device	Power: AC 120V/60Hz
Note: Mode 4: Transmit at 2402MHz by BLE_C2	

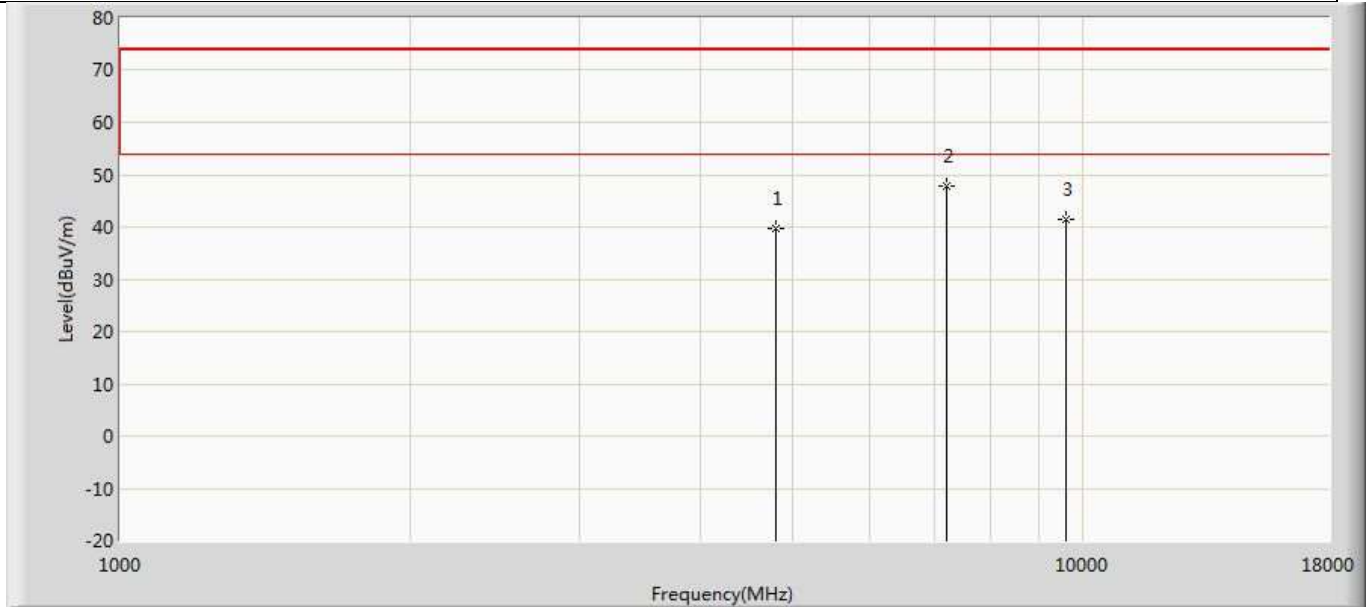

No	Mark	Frequency (MHz)	Measure Level (dBuV/m)	Reading Level (dBuV)	Over Limit (dB)	Limit (dBuV/m)	Factor (dB)	Type
1		4804.000	39.790	36.129	-34.210	74.000	3.662	PK
2	*	7206.000	47.761	41.098	-26.239	74.000	6.663	PK
3		9608.000	41.323	33.187	-32.677	74.000	8.137	PK

Profile: 2060819R	Page No.: 239
Engineer: Yingfeiwang	
Site: AC5	Time: 2020/06/24 - 02:30
Limit: FCC_Part15.209_RE(3m)	Margin: 0
Probe: Horn_3117_00167055(1-18GHz)	Polarity: Horizontal
EUT: LED Device	Power: AC 120V/60Hz
Note: Mode 4: Transmit at 2440MHz by BLE_C2	

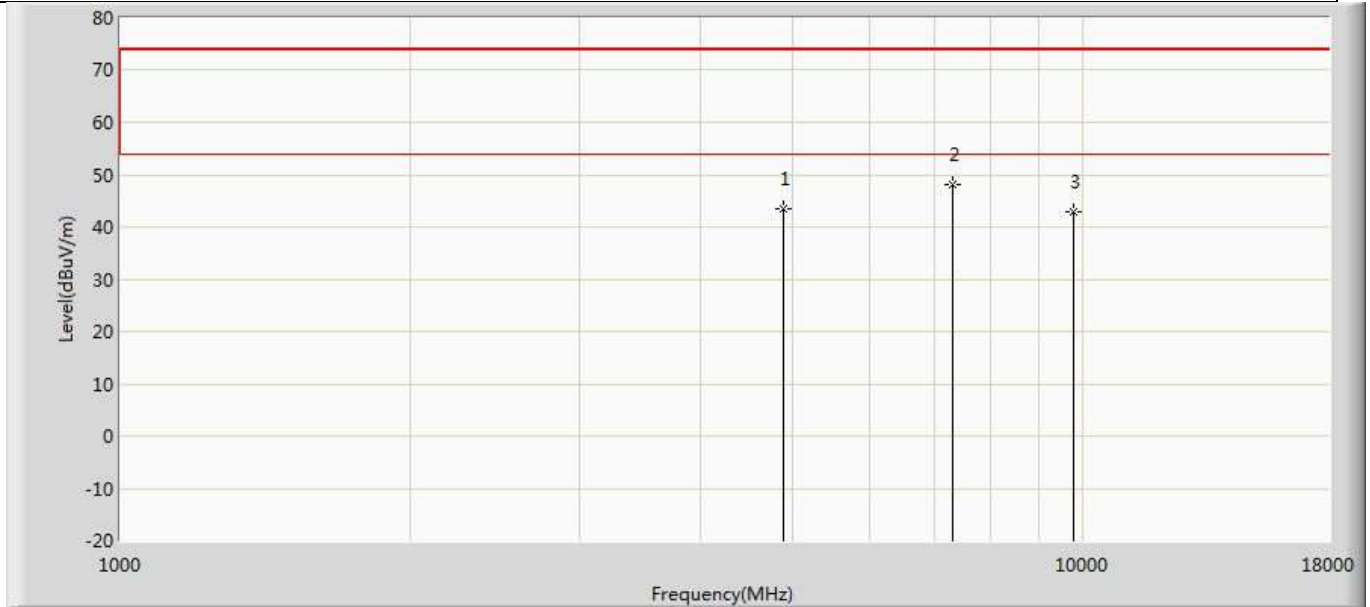

No	Mark	Frequency (MHz)	Measure Level (dBuV/m)	Reading Level (dBuV)	Over Limit (dB)	Limit (dBuV/m)	Factor (dB)	Type
1		4880.000	43.478	39.837	-30.522	74.000	3.640	PK
2	*	7320.000	48.072	41.387	-25.928	74.000	6.685	PK
3		9760.000	42.901	34.197	-31.099	74.000	8.704	PK

Profile: 2060819R	Page No.: 240
Engineer: Yingfeiwang	
Site: AC5	Time: 2020/06/24 - 02:30
Limit: FCC_Part15.209_RE(3m)	Margin: 0
Probe: Horn_3117_00167055(1-18GHz)	Polarity: Vertical
EUT: LED Device	Power: AC 120V/60Hz
Note: Mode 4: Transmit at 2440MHz by BLE_C2	

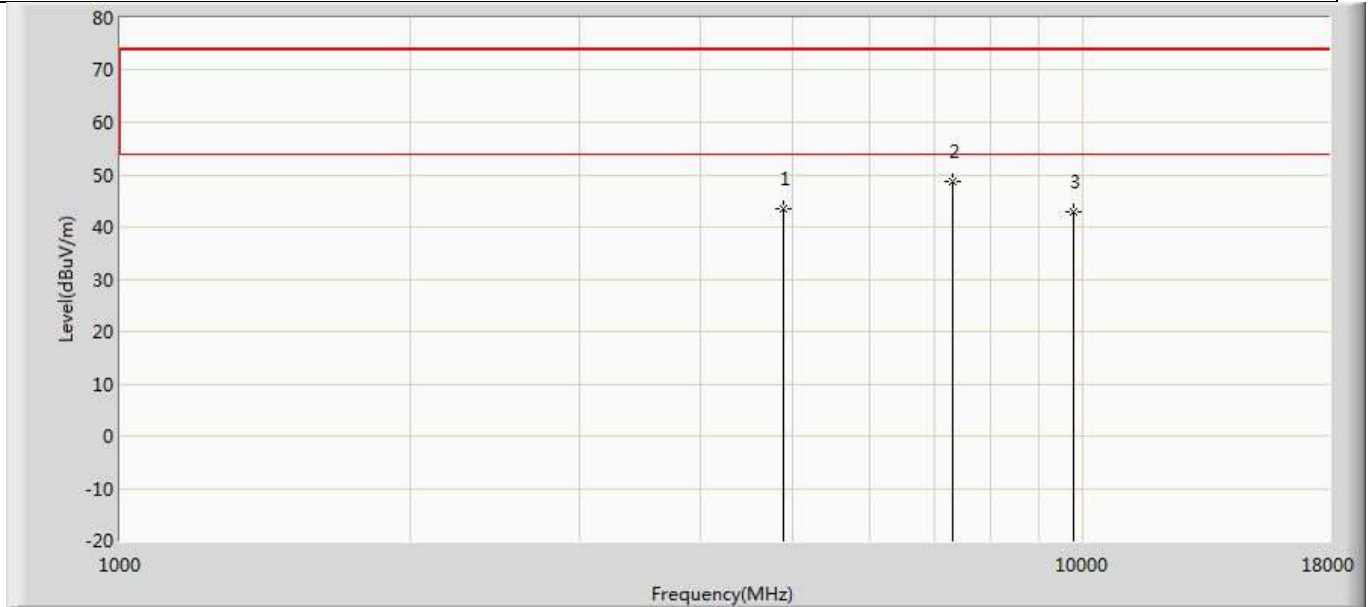

No	Mark	Frequency (MHz)	Measure Level (dBuV/m)	Reading Level (dBuV)	Over Limit (dB)	Limit (dBuV/m)	Factor (dB)	Type
1		4880.000	43.444	39.803	-30.556	74.000	3.640	PK
2	*	7320.000	48.579	41.894	-25.421	74.000	6.685	PK
3		9760.000	42.815	34.111	-31.185	74.000	8.704	PK

Profile: 2060819R	Page No.: 241
Engineer: Yingfeiwang	
Site: AC5	Time: 2020/06/24 - 02:30
Limit: FCC_Part15.209_RE(3m)	Margin: 0
Probe: Horn_3117_00167055(1-18GHz)	Polarity: Horizontal
EUT: LED Device	Power: AC 120V/60Hz
Note: Mode 4:Transmit at 2480MHz by BLE_C2	

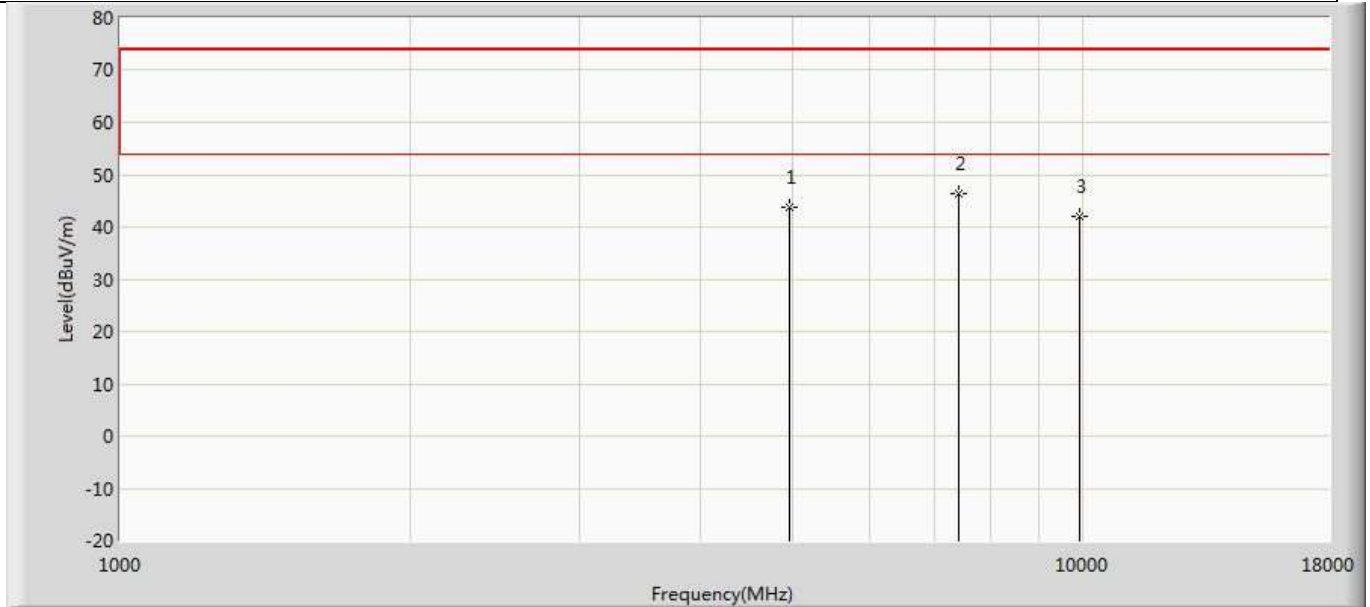

No	Mark	Frequency (MHz)	Measure Level (dBuV/m)	Reading Level (dBuV)	Over Limit (dB)	Limit (dBuV/m)	Factor (dB)	Type
1		4960.000	43.662	40.051	-30.338	74.000	3.611	PK
2	*	7440.000	46.454	39.869	-27.546	74.000	6.585	PK
3		9920.000	42.124	33.399	-31.876	74.000	8.725	PK

Profile: 2060819R	Page No.: 242
Engineer: Yingfeiwang	
Site: AC5	Time: 2020/06/24 - 02:30
Limit: FCC_Part15.209_RE(3m)	Margin: 0
Probe: Horn_3117_00167055(1-18GHz)	Polarity: Vertical
EUT: LED Device	Power: AC 120V/60Hz
Note: Mode 4: Transmit at 2480MHz by BLE_C2	

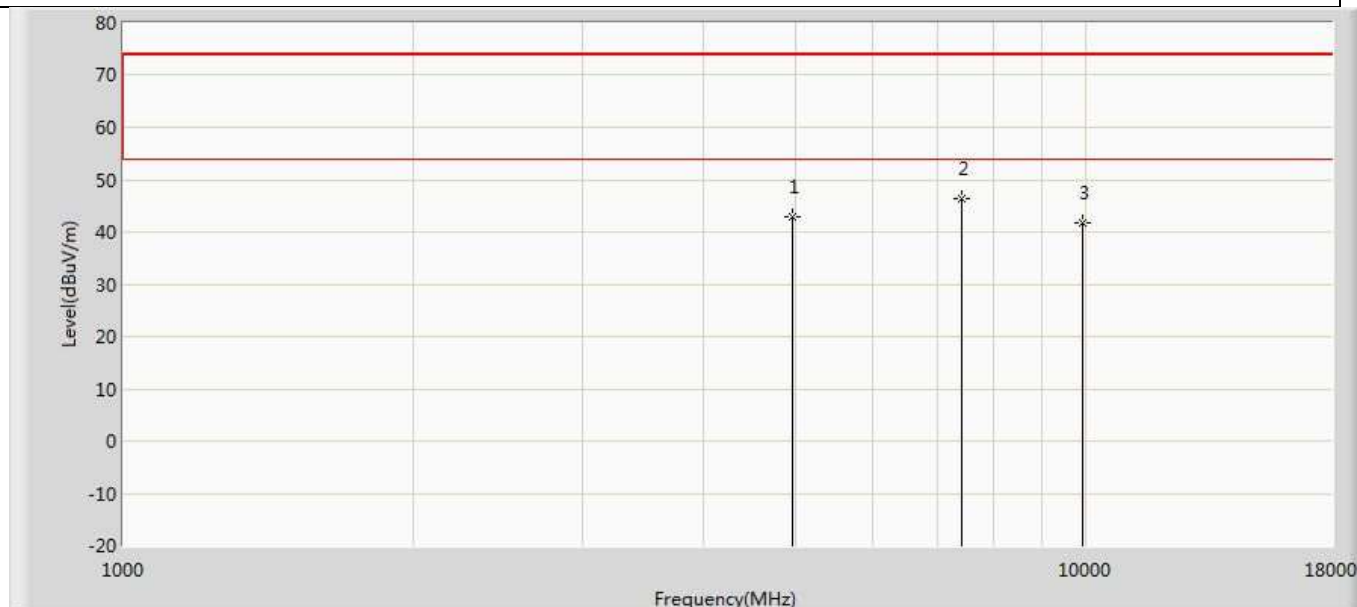

No	Mark	Frequency (MHz)	Measure Level (dBuV/m)	Reading Level (dBuV)	Over Limit (dB)	Limit (dBuV/m)	Factor (dB)	Type
1		4960.000	42.869	39.258	-31.131	74.000	3.611	PK
2	*	7440.000	46.316	39.731	-27.684	74.000	6.585	PK
3		9920.000	41.706	32.981	-32.294	74.000	8.725	PK

Note:

1. Measured Level = Reading Level + Factor.
2. The test frequency range, 9kHz~30MHz, 18GHz~26GHz, both of the worst case are at least 20dB below the limits, therefore no data appear in the report.
3. This limit applies for using average detector, if the test result on peak is lower than average limit, then average measurement needn't be performed.
4. As the radiated emission was performed, so conducted emission was not tested.

The worst case of Radiated Emission below 1GHz:

Profile: 2060819R	Page No.: 1
Engineer: Shuo	
Site: AC3	Time: 2020/05/12 - 14:24
Limit: FCC_Part15.209_RE(3m)_ClassB	Margin: 0
Probe: SuZ-2141	Polarity: Horizontal
EUT: LED Device	Power: AC 120V/60Hz
Note: Mode 1	

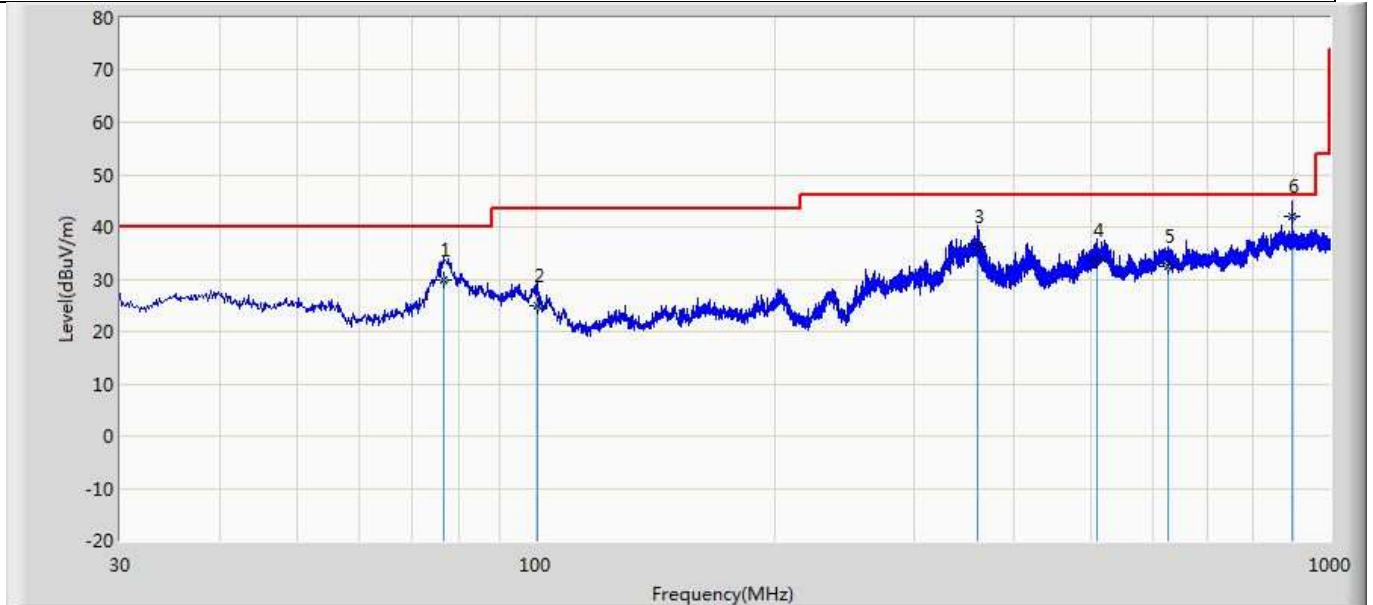

No	Mark	Frequency (MHz)	Measure Level (dBuV/m)	Reading Level (dBuV)	Over Limit (dB)	Limit (dBuV/m)	Probe (dB/m)	Cable (dB)	Amp (dB)	Ant Pos (cm)	Table Pos (deg)	Type
1		76.560	29.855	16.200	-10.145	40.000	7.010	6.645	0.000	100	188	QP
2		100.689	25.045	11.400	-18.455	43.500	6.865	6.780	0.000	100	239	QP
3		360.000	36.297	11.300	-9.703	46.000	17.244	7.753	0.000	0	0	QP
4		508.570	33.521	5.300	-12.479	46.000	20.025	8.196	0.000	0	0	QP
5		624.489	32.328	1.300	-13.672	46.000	22.526	8.503	0.000	0	0	QP
6	*	895.230	41.931	8.200	-4.069	46.000	24.572	9.159	0.000	0	0	QP

Note:

1. All Readings below 1GHz are Quasi-Peak, above are performed with peak and/or average measurements as necessary.
2. " * ", means this data is the worst emission level.
3. Measurement Level = Reading Level + Factor(Probe+Cable-Amp).

Profile: 2060819R	Page No.: 2
Engineer: Shuo	
Site: AC3	Time: 2020/05/12 - 14:27
Limit: FCC_Part15.109_RE(3m)_ClassB	Margin: 0
Probe: SuZ-2141	Polarity: Vertical
EUT: LED Device	Power: AC 120V/60Hz
Note: Mode 1	

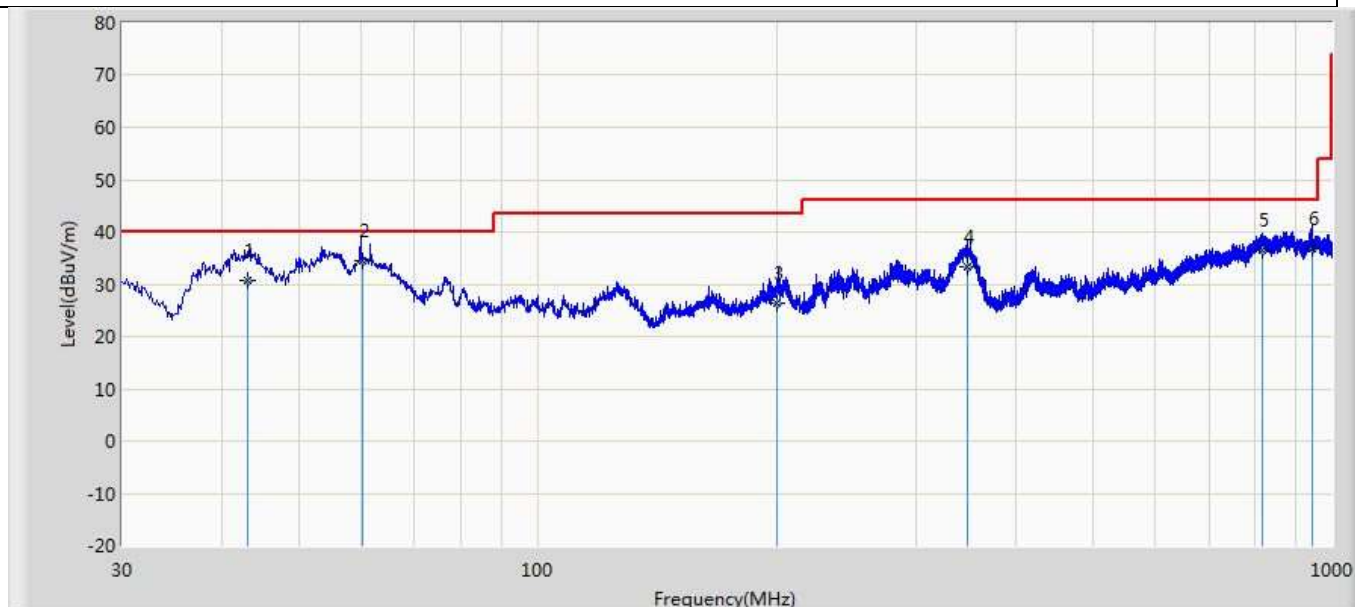

No	Mark	Frequency (MHz)	Measure Level (dBuV/m)	Reading Level (dBuV)	Over Limit (dB)	Limit (dBuV/m)	Probe (dB/m)	Cable (dB)	Amp (dB)	Ant Pos (cm)	Table Pos (deg)	Type
1		43.203	30.845	10.300	-9.155	40.000	14.101	6.443	0.000	100	63	QP
2	*	60.213	34.494	10.200	-5.506	40.000	17.738	6.556	0.000	100	52	QP
3		200.131	26.456	2.600	-17.044	43.500	16.654	7.202	0.000	100	51	QP
4		347.531	33.405	8.600	-12.595	46.000	17.092	7.713	0.000	100	52	QP
5		817.230	36.660	1.300	-9.340	46.000	26.374	8.986	0.000	100	52	QP
6		946.230	36.726	2.300	-9.274	46.000	25.145	9.280	0.000	100	210	QP

Note:

1. All Readings below 1GHz are Quasi-Peak, above are performed with peak and/or average measurements as necessary.
2. " * ", means this data is the worst emission level.
3. Measurement Level = Reading Level + Factor(Probe+Cable-Amp).

4.3 Emissions in non-restricted frequency band	VERDICT: PASS
---	----------------------

4.3.1 Limit	
Standard	FCC Part 15 Subpart C Paragraph 15.247(d)
RF Output power (Detection methods)	Limit(dB)
RF Output power(Average detector)	30dBc(Note1)
RF Output power(PK detector)	20dBc(Note2)
<p>Note 1: If maximum conducted (average) output power was used to demonstrate compliance as described in 9.2, then the peak power in any 100 kHz bandwidth outside of the authorized frequency band shall be attenuated by at least 30 dB relative to the maximum in-band peak PSD level in 100 kHz (i.e., 30 dBc).</p> <p>Note 2: If the maximum peak conducted output power procedure was used, then the peak output power measured in any 100 kHz bandwidth outside of the authorized frequency band shall be attenuated by at least 20 dB relative to the maximum in-band peak PSD level in 100 kHz (i.e., 20 dBc).</p>	

4.3.2 Test Setup

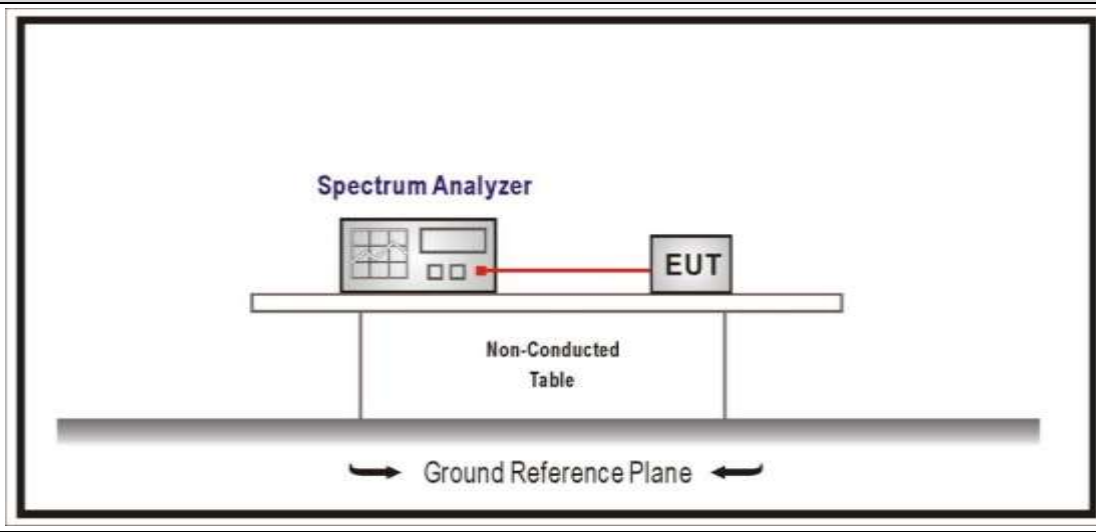

4.3.3 Test Procedure			
-----------------------------	--	--	--

References Rule	Chapter	Description
<input checked="" type="checkbox"/> ANSI C63.10	11.11	Emissions in non-restricted frequency bands
<input checked="" type="checkbox"/> ANSI C63.10	11.11.1	General
<input checked="" type="checkbox"/> ANSI C63.10	11.11.2	Reference level measurement
<input checked="" type="checkbox"/> ANSI C63.10	11.11.3	Emission level measurement

4.3.4 Test Data

Mode	Channel	Test Frequency (MHz)	Maximum In-Band PSD[a] (dBm/100kHz)	Frequency (MHz)	Out-Band PSD[b] (dBm/100kHz)	[a]-[b] (dB)	Limit (dB)	Result
1	00	2402	6.041	2400	-44.536	50.577	>20	Pass
	39	2480	6.210	2500	-53.638	59.848	>20	Pass
2	00	2402	4.720	2400	-27.450	32.170	>20	Pass
	39	2480	4.522	2500	-54.928	59.450	>20	Pass
3	00	2402	6.280	2400	-44.847	51.127	>20	Pass
	39	2480	6.147	2500	-55.038	61.185	>20	Pass
4	00	2402	3.711	2400	-45.387	49.098	>20	Pass
	39	2480	3.533	2500	-53.791	57.324	>20	Pass

Note 1: The worst data plot as below:

Mode2/CH00/2402MHz

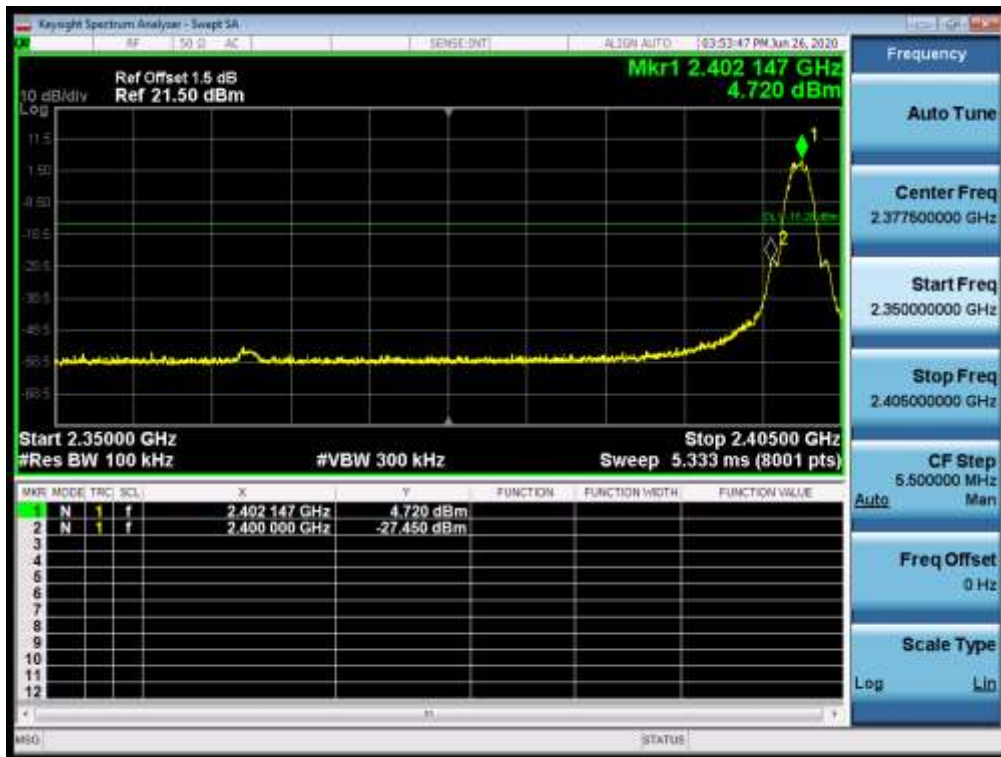

4.4 Duty cycle

VERDICT: PASS

4.4.1 Limit

N/A

4.4.2 Test Setup

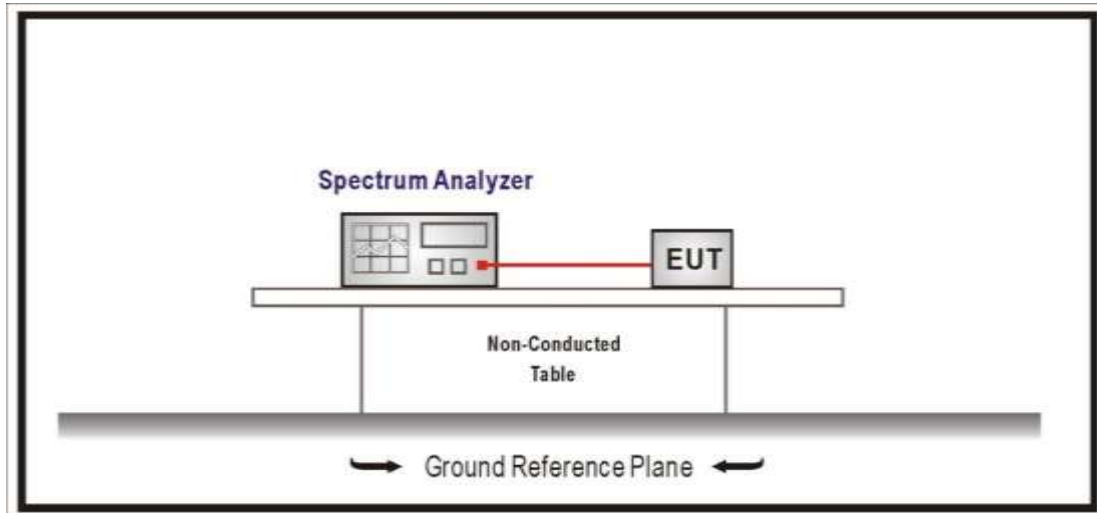

4.4.3 Test Procedure

References Rule	Chapter	Description
<input checked="" type="checkbox"/> ANSI C63.10	11.6	Duty cycle (D), transmission duration (T), and maximum power control level

4.4.4 Test Data

Test Mode	Tx On (us)	Tx Off (us)	VBW (kHz)	Tx On + Tx Off (us)	Duty Cycle (%)
Mode 1	--	--	--	--	100
Mode 2	--	--	--	--	100
Mode 3	--	--	--	--	100
Mode 4	--	--	--	--	100

Note 1: T means the minimum transmission duration over which the transmitter is on and is transmitting at its maximum power control level for the tested mode of operation.

Note 2: According to KDB 558074, when test for Radiated Emission Band Edge and Radiated Emission, for average detector set: $VBW \geq 1/T$ will be used.

Mode 1 CH19 2440MHz



4.5 Radiated Emission Band Edge	VERDICT: PASS
--	----------------------

4.5.1 Limit

Standard		FCC Part 15 Subpart C Paragraph 15.247(d) , 15.209		
Frequency bands (MHz)	Detector	Limit (dBµV/m)	RBW (MHz)	Distance (m)
2310-2390	PK	74	1	3
2483.5-2500	AV	54	1	3

Note: The field strength of emissions appearing within these frequency bands shall not exceed the limits.

4.5.2 Test Setup

Above 1GHz Test Setup:

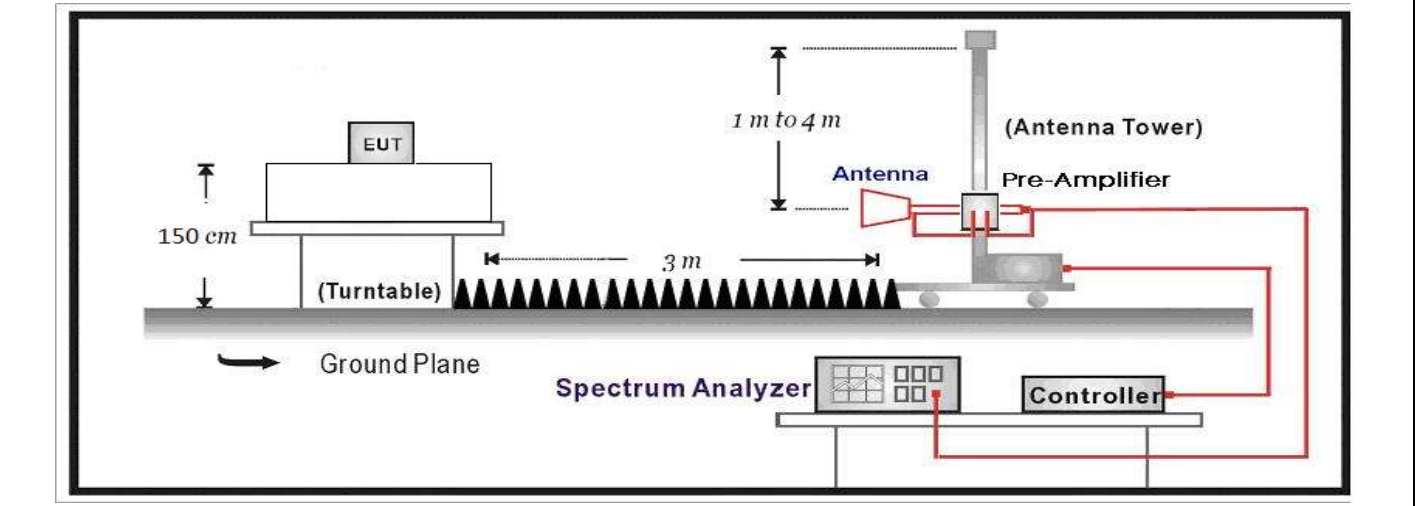

4.5.3 Test Procedure

	References Rule	Chapter	Description
<input checked="" type="checkbox"/>	ANSI C63.10	6.10	Band-edge testing
	<input checked="" type="checkbox"/> ANSI C63.10	6.10.5	Restricted-band band-edge measurements
	<input type="checkbox"/> ANSI C63.10	6.10.6	Marker-delta method
<input checked="" type="checkbox"/>	ANSI C63.10	11.12	Emissions in restricted frequency bands
	<input checked="" type="checkbox"/> ANSI C63.10	11.12.1	Radiated emission measurements
	<input checked="" type="checkbox"/> ANSI C63.10	11.12.2.7	Radiated spurious emission test
<input type="checkbox"/>	ANSI C63.10	6.4	Radiated emissions from unlicensed wireless devices below 30 MHz
<input type="checkbox"/>	ANSI C63.10	6.5	Radiated emissions from unlicensed wireless devices in the frequency range of 30 MHz to 1000 MHz
<input checked="" type="checkbox"/>	ANSI C63.10	6.6	Radiated emissions from unlicensed wireless devices above 1 GHz

4.5.4 Test Data

Profile: 2060819R	Page No.: 1
Engineer: YULIU	
Site: AC5	Time: 2020/06/25 - 00:29
Limit: FCC_Part15.209_RE(3m)	Margin: 0
Probe: Horn_3117_00167055(1-18GHz)	Polarity: Vertical
EUT: LED Device	Power: AC 120V/60Hz
Note: Mode 1:Transmit at 2402MHz by DH5	

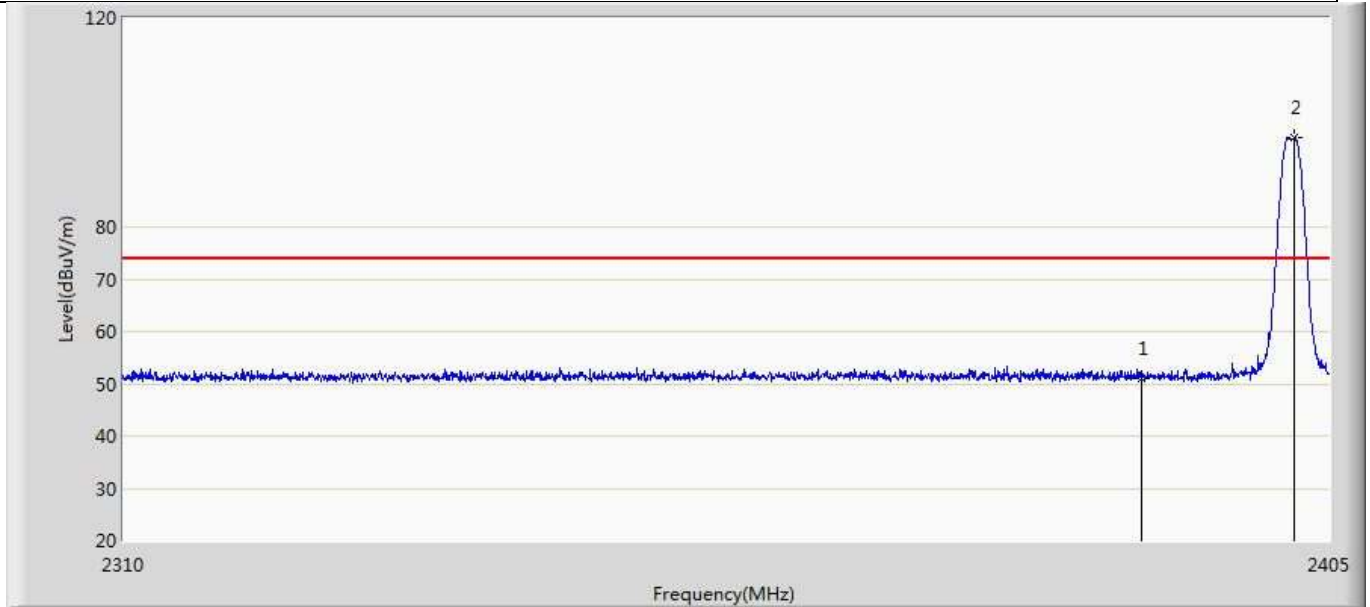

No	Mark	Frequency (MHz)	Measure Level (dBuV/m)	Reading Level (dBuV)	Over Limit (dB)	Limit (dBuV/m)	Factor (dB)	Type
1		2390.000	51.044	15.729	-22.956	74.000	35.315	PK
2	*	2402.198	96.999	61.687	22.999	74.000	35.312	PK

Profile: 2060819R	Page No.: 2
Engineer: YULIU	
Site: AC5	Time: 2020/06/25 - 20:21
Limit: FCC_Part15.209_RE(3m)	Margin: 0
Probe: Horn_3117_00167055(1-18GHz)	Polarity: Vertical
EUT: LED Device	Power: AC 120V/60Hz
Note: Mode 1:Transmit at 2402MHz by DH5	

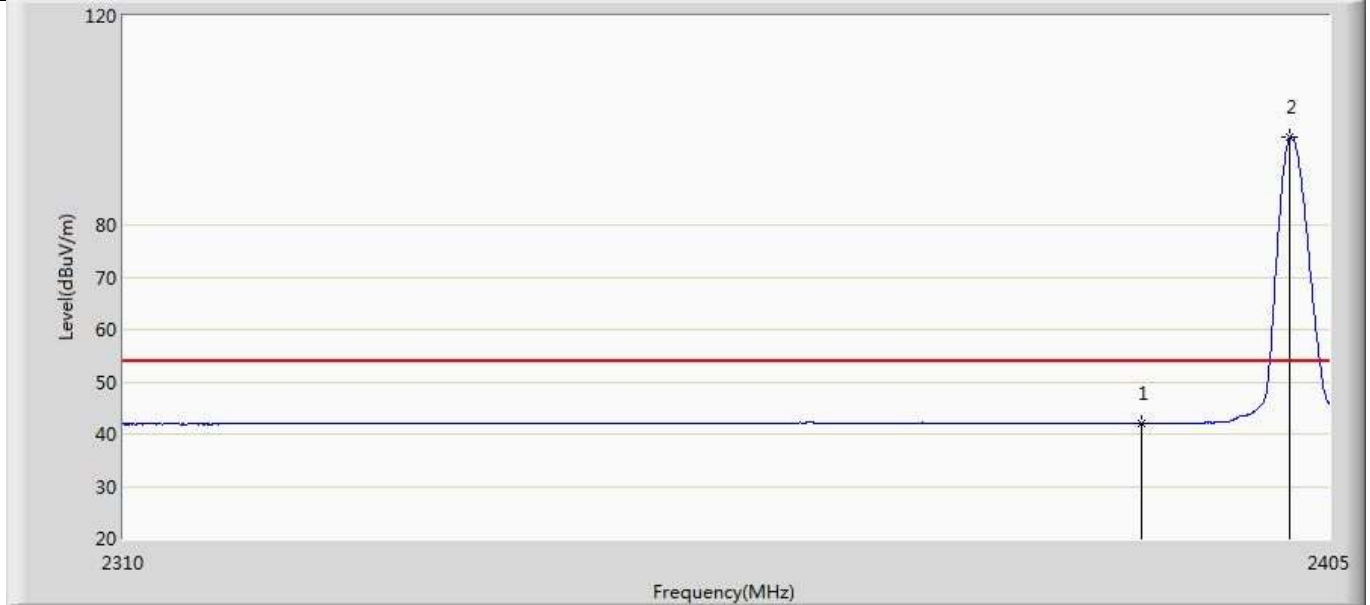

No	Mark	Frequency (MHz)	Measure Level (dBuV/m)	Reading Level (dBuV)	Over Limit (dB)	Limit (dBuV/m)	Factor (dB)	Type
1		2390.000	42.007	6.692	-11.993	54.000	35.315	AV
2	*	2401.865	96.685	61.372	42.685	54.000	35.312	AV

Profile: 2060819R	Page No.: 3
Engineer: YULIU	
Site: AC5	Time: 2020/06/25 - 20:24
Limit: FCC_Part15.209_RE(3m)	Margin: 0
Probe: Horn_3117_00167055(1-18GHz)	Polarity: Horizontal
EUT: LED Device	Power: AC 120V/60Hz
Note: Mode 1:Transmit at 2402MHz by DH5	

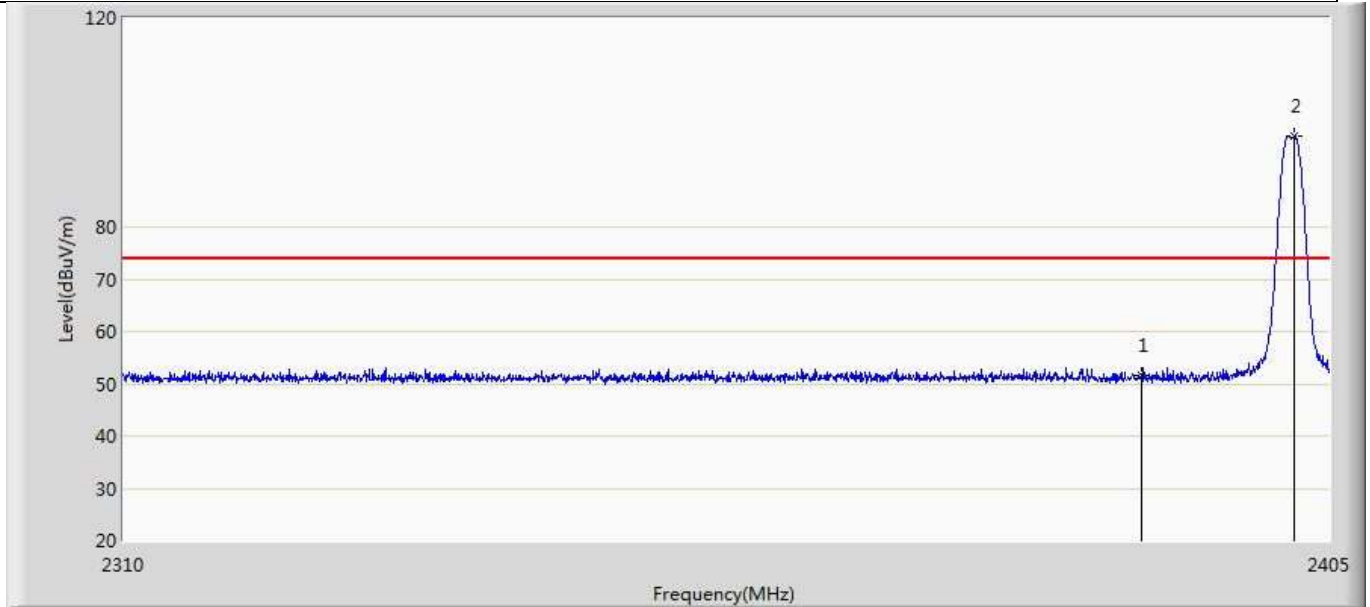

No	Mark	Frequency (MHz)	Measure Level (dBuV/m)	Reading Level (dBuV)	Over Limit (dB)	Limit (dBuV/m)	Factor (dB)	Type
1		2390.000	51.511	16.196	-22.489	74.000	35.315	PK
2	*	2402.198	97.288	61.976	23.288	74.000	35.312	PK

Profile: 2060819R	Page No.: 4
Engineer: YULIU	
Site: AC5	Time: 2020/06/25 - 20:26
Limit: FCC_Part15.209_RE(3m)	Margin: 0
Probe: Horn_3117_00167055(1-18GHz)	Polarity: Horizontal
EUT: LED Device	Power: AC 120V/60Hz
Note: Mode 1:Transmit at 2402MHz by DH5	

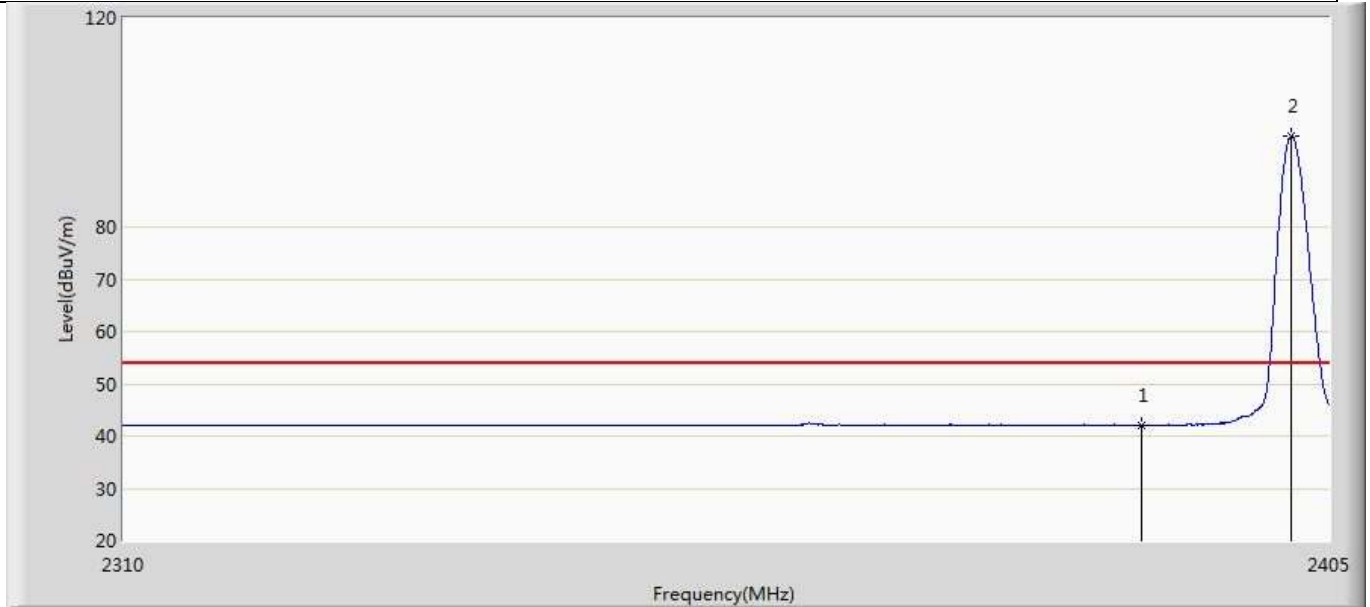

No	Mark	Frequency (MHz)	Measure Level (dBuV/m)	Reading Level (dBuV)	Over Limit (dB)	Limit (dBuV/m)	Factor (dB)	Type
1		2390.000	42.118	6.803	-11.882	54.000	35.315	AV
2	*	2401.913	97.309	61.996	43.309	54.000	35.312	AV

Profile: 2060819R	Page No.: 5
Engineer: YULIU	
Site: AC5	Time: 2020/06/25 - 20:28
Limit: FCC_Part15.209_RE(3m)	Margin: 0
Probe: Horn_3117_00167055(1-18GHz)	Polarity: Vertical
EUT: LED Device	Power: AC 120V/60Hz
Note: Mode 1:Transmit at 2480MHz by DH5	

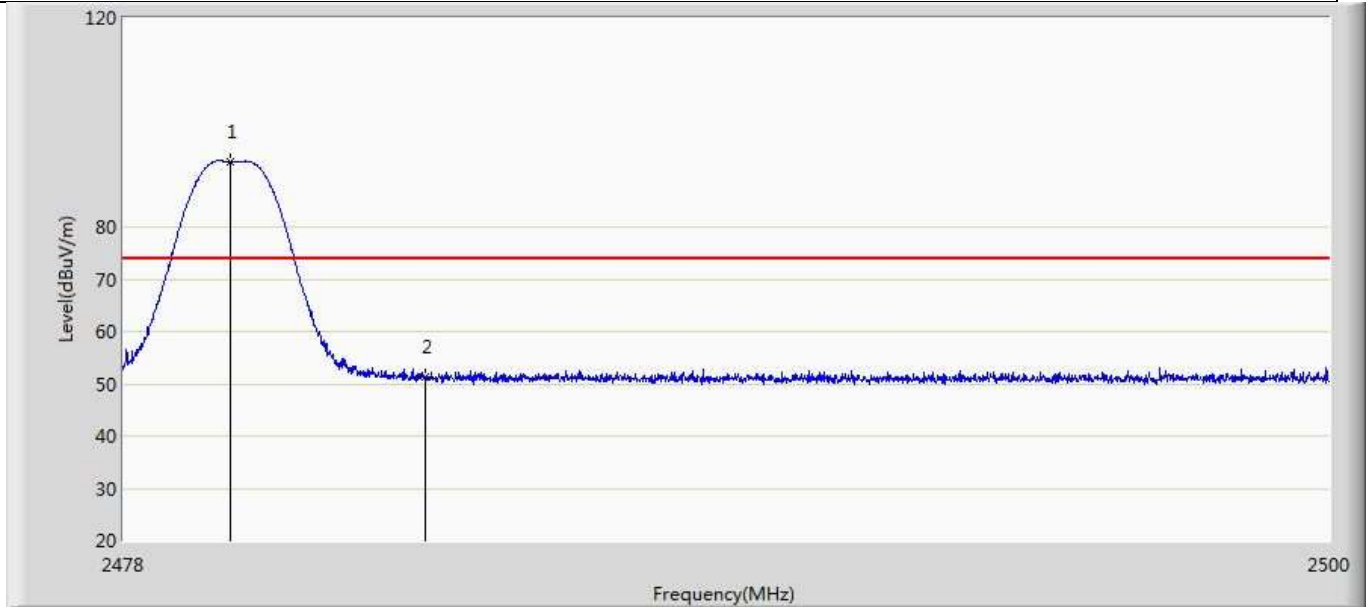

No	Mark	Frequency (MHz)	Measure Level (dBuV/m)	Reading Level (dBuV)	Over Limit (dB)	Limit (dBuV/m)	Factor (dB)	Type
1	*	2479.947	92.463	57.164	18.463	74.000	35.299	PK
2		2483.500	51.264	15.966	-22.736	74.000	35.297	PK

Profile: 2060819R	Page No.: 6
Engineer: YULIU	
Site: AC5	Time: 2020/06/25 - 20:31
Limit: FCC_Part15.209_RE(3m)	Margin: 0
Probe: Horn_3117_00167055(1-18GHz)	Polarity: Vertical
EUT: LED Device	Power: AC 120V/60Hz
Note: Mode 1:Transmit at 2480MHz by DH5	

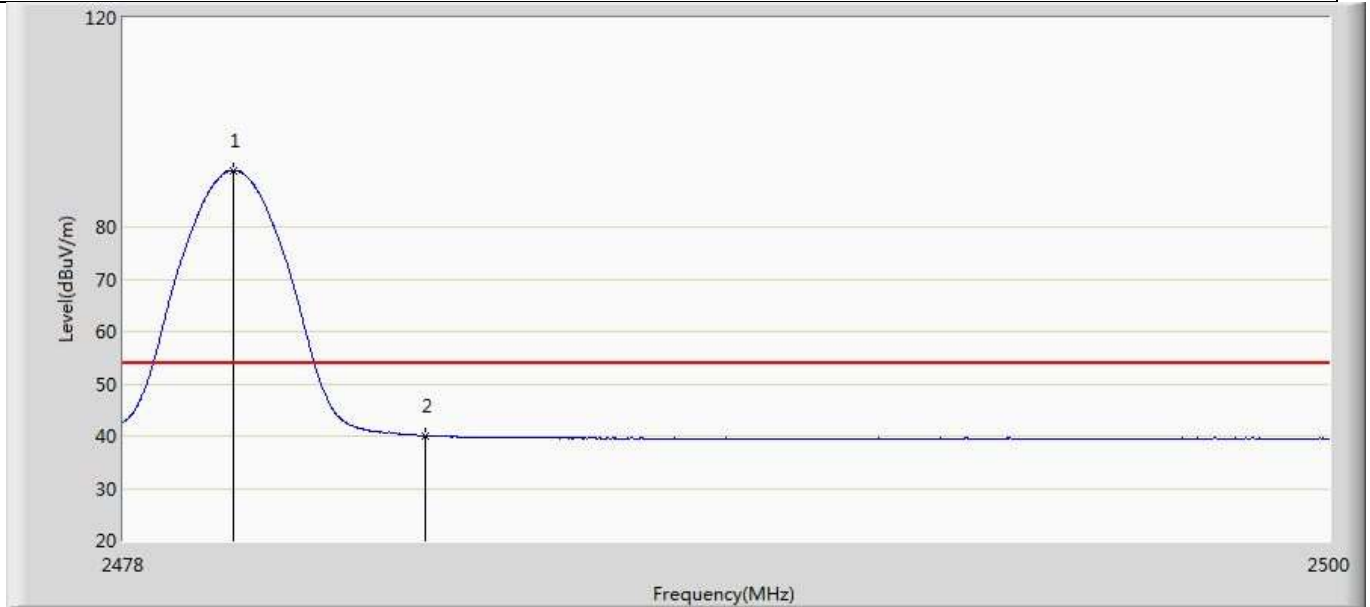

No	Mark	Frequency (MHz)	Measure Level (dBuV/m)	Reading Level (dBuV)	Over Limit (dB)	Limit (dBuV/m)	Factor (dB)	Type
1	*	2480.013	90.788	55.489	36.788	54.000	35.299	AV
2		2483.500	40.078	4.780	-13.922	54.000	35.297	AV

Profile: 2060819R	Page No.: 7
Engineer: YULIU	
Site: AC5	Time: 2020/06/25 - 20:33
Limit: FCC_Part15.209_RE(3m)	Margin: 0
Probe: Horn_3117_00167055(1-18GHz)	Polarity: Horizontal
EUT: LED Device	Power: AC 120V/60Hz
Note: Mode 1:Transmit at 2480MHz by DH5	

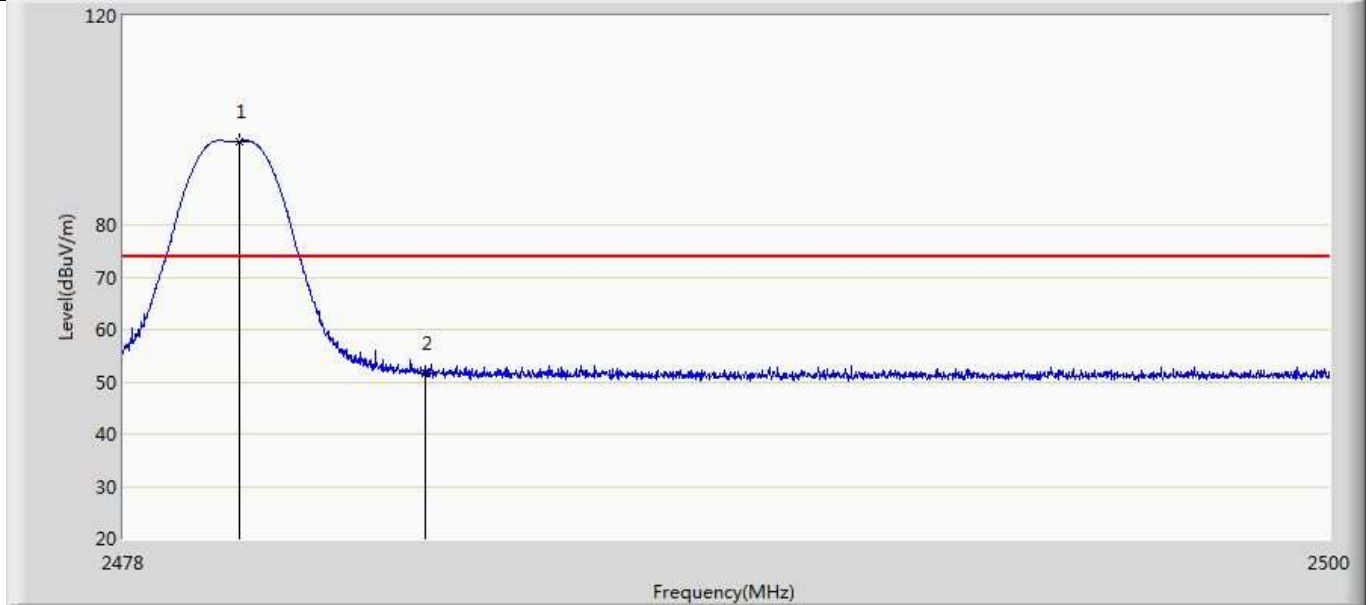

No	Mark	Frequency (MHz)	Measure Level (dBuV/m)	Reading Level (dBuV)	Over Limit (dB)	Limit (dBuV/m)	Factor (dB)	Type
1	*	2480.112	96.027	60.728	22.027	74.000	35.299	PK
2		2483.500	51.559	16.261	-22.441	74.000	35.297	PK

Profile: 2060819R	Page No.: 8
Engineer: YULIU	
Site: AC5	Time: 2020/06/25 - 20:36
Limit: FCC_Part15.209_RE(3m)	Margin: 0
Probe: Horn_3117_00167055(1-18GHz)	Polarity: Horizontal
EUT: LED Device	Power: AC 120V/60Hz
Note: Mode 1:Transmit at 2480MHz by DH5	

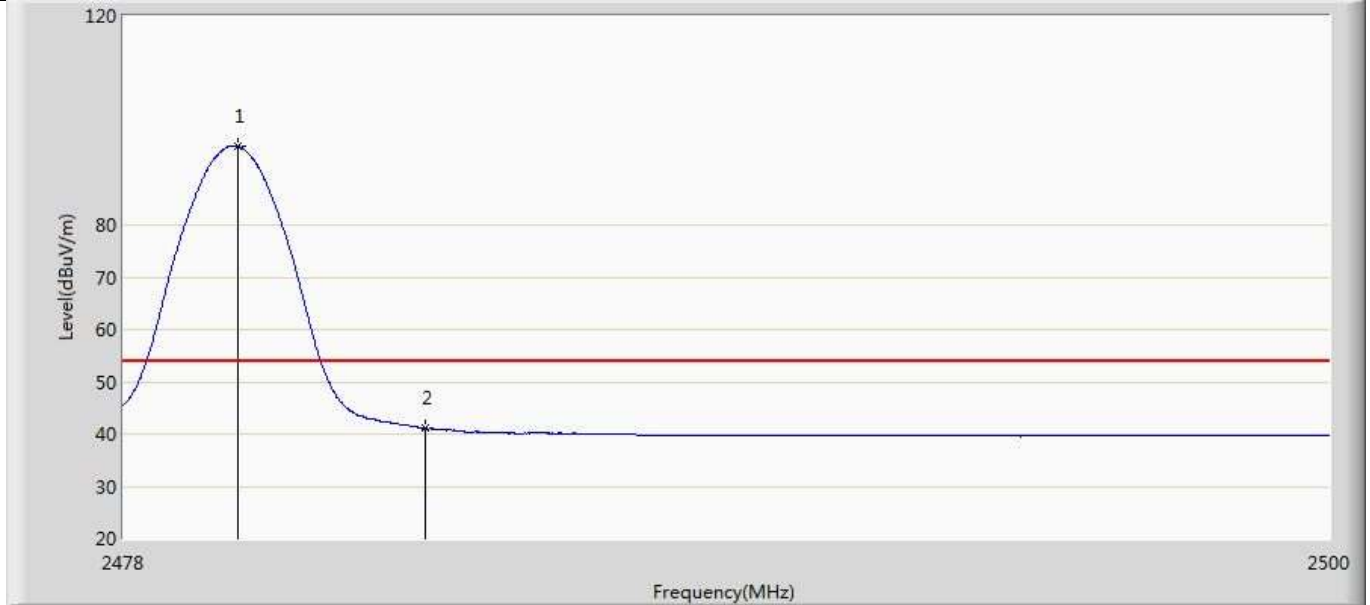

No	Mark	Frequency (MHz)	Measure Level (dBuV/m)	Reading Level (dBuV)	Over Limit (dB)	Limit (dBuV/m)	Factor (dB)	Type
1	*	2480.079	95.039	59.740	41.039	54.000	35.299	AV
2		2483.500	41.026	5.728	-12.974	54.000	35.297	AV

Profile: 2060819R	Page No.: 9
Engineer: YULIU	
Site: AC5	Time: 2020/06/25 - 20:39
Limit: FCC_Part15.209_RE(3m)	Margin: 0
Probe: Horn_3117_00167055(1-18GHz)	Polarity: Vertical
EUT: LED Device	Power: AC 120V/60Hz
Note: Mode 2:Transmit at 2402MHz by 2LE	

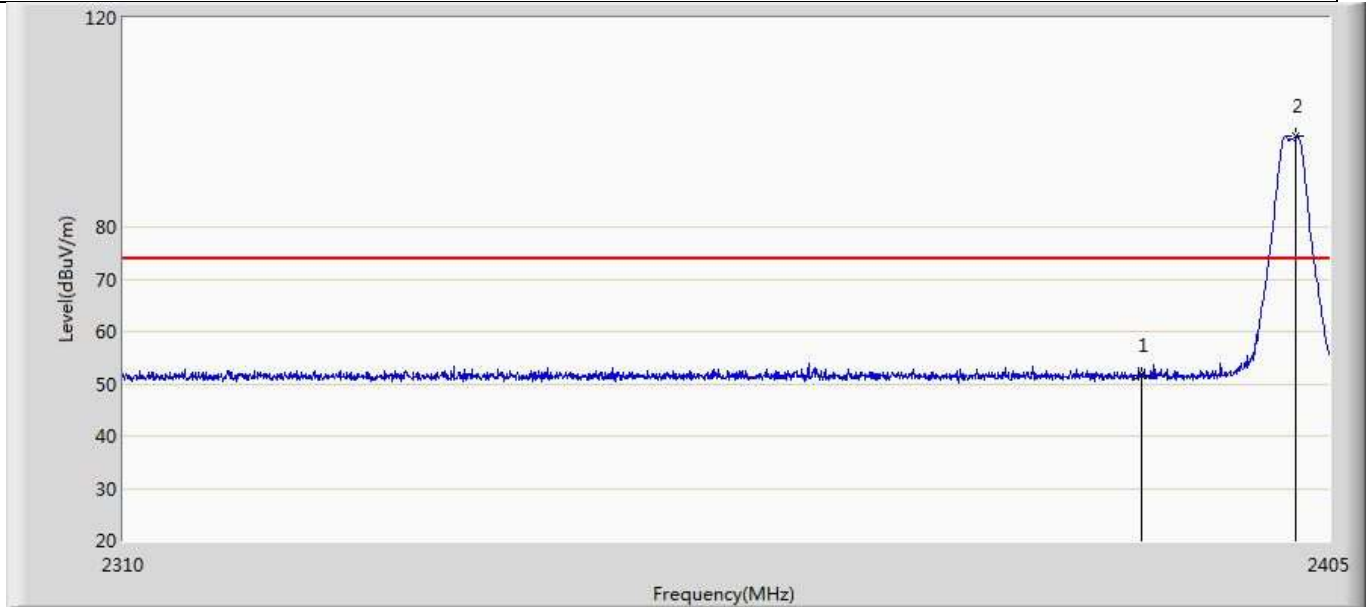

No	Mark	Frequency (MHz)	Measure Level (dBuV/m)	Reading Level (dBuV)	Over Limit (dB)	Limit (dBuV/m)	Factor (dB)	Type
1		2390.000	51.519	16.204	-22.481	74.000	35.315	PK
2	*	2402.387	97.251	61.939	23.251	74.000	35.312	PK

Profile: 2060819R	Page No.: 10
Engineer: YULIU	
Site: AC5	Time: 2020/06/25 - 20:48
Limit: FCC_Part15.209_RE(3m)	Margin: 0
Probe: Horn_3117_00167055(1-18GHz)	Polarity: Vertical
EUT: LED Device	Power: AC 120V/60Hz
Note: Mode 2:Transmit at 2402MHz by 2DH5	

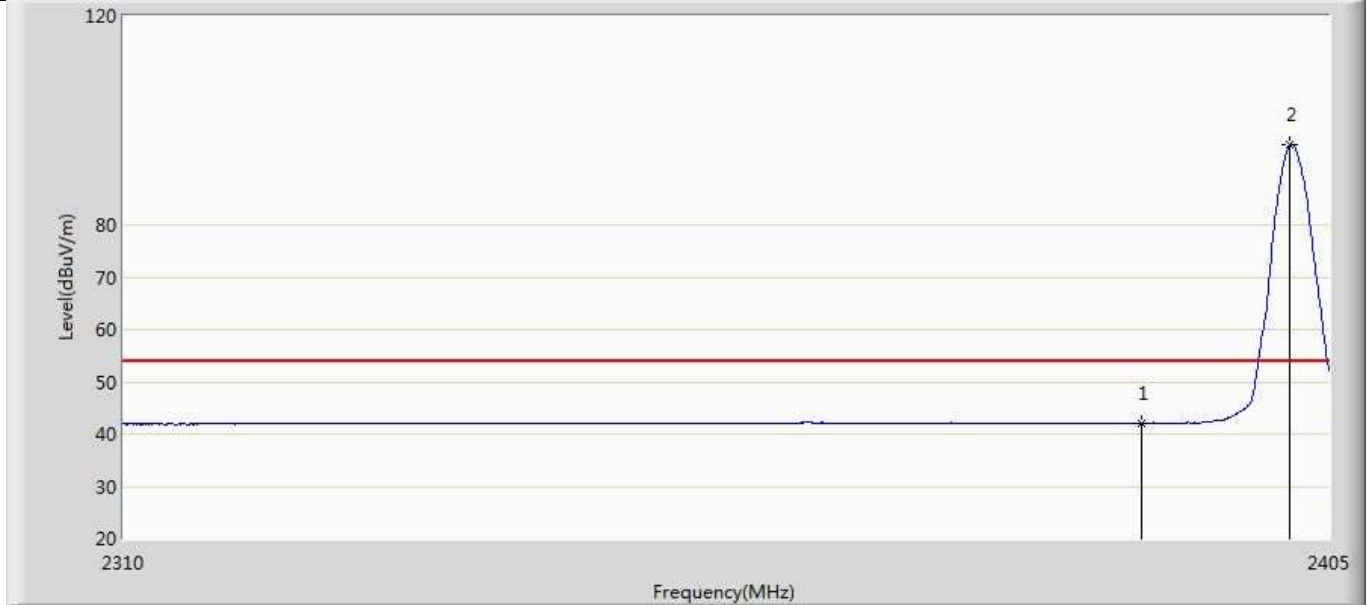

No	Mark	Frequency (MHz)	Measure Level (dBuV/m)	Reading Level (dBuV)	Over Limit (dB)	Limit (dBuV/m)	Factor (dB)	Type
1		2390.000	42.024	6.709	-11.976	54.000	35.315	AV
2	*	2401.865	95.312	59.999	41.312	54.000	35.312	AV

Profile: 2060819R	Page No.: 11
Engineer: YULIU	
Site: AC5	Time: 2020/06/25 - 20:51
Limit: FCC_Part15.209_RE(3m)	Margin: 0
Probe: Horn_3117_00167055(1-18GHz)	Polarity: Horizontal
EUT: LED Device	Power: AC 120V/60Hz
Note: Mode 2:Transmit at 2402MHz by 2DH5	

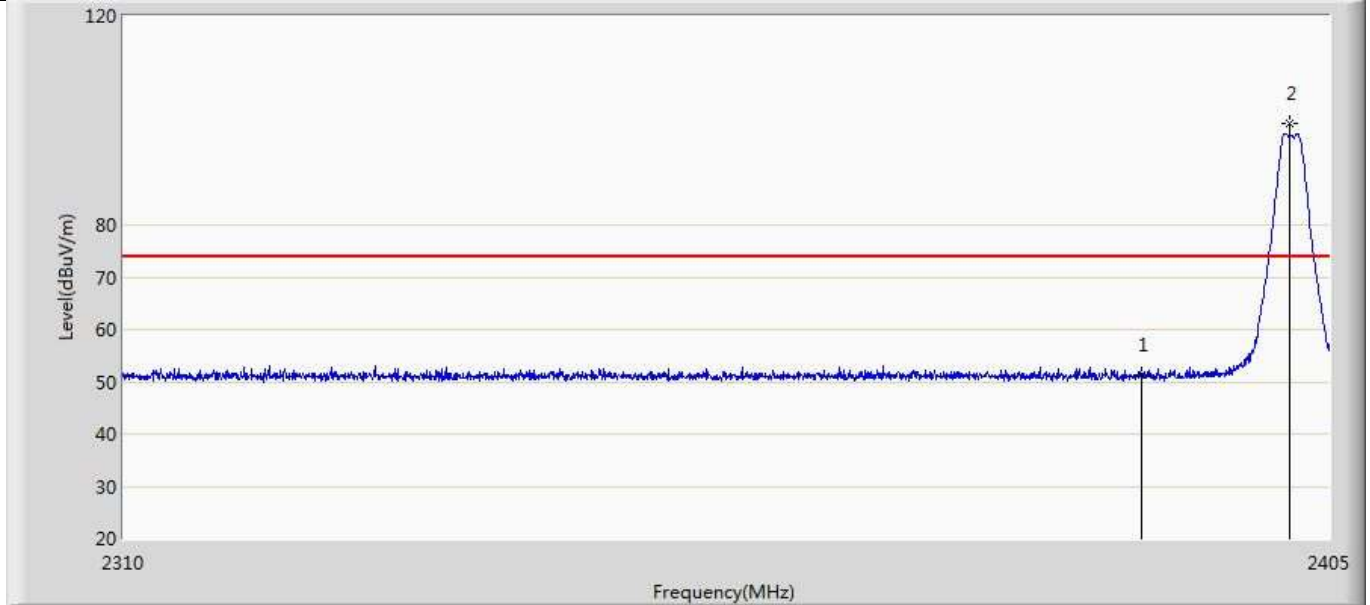

No	Mark	Frequency (MHz)	Measure Level (dBuV/m)	Reading Level (dBuV)	Over Limit (dB)	Limit (dBuV/m)	Factor (dB)	Type
1		2390.000	51.395	16.080	-22.605	74.000	35.315	PK
2	*	2401.865	99.420	64.107	25.420	74.000	35.312	PK

Profile: 2060819R	Page No.: 12
Engineer: YULIU	
Site: AC5	Time: 2020/06/25 - 20:53
Limit: FCC_Part15.209_RE(3m)	Margin: 0
Probe: Horn_3117_00167055(1-18GHz)	Polarity: Horizontal
EUT: LED Device	Power: AC 120V/60Hz
Note: Mode 2:Transmit at 2402MHz by 2DH5	

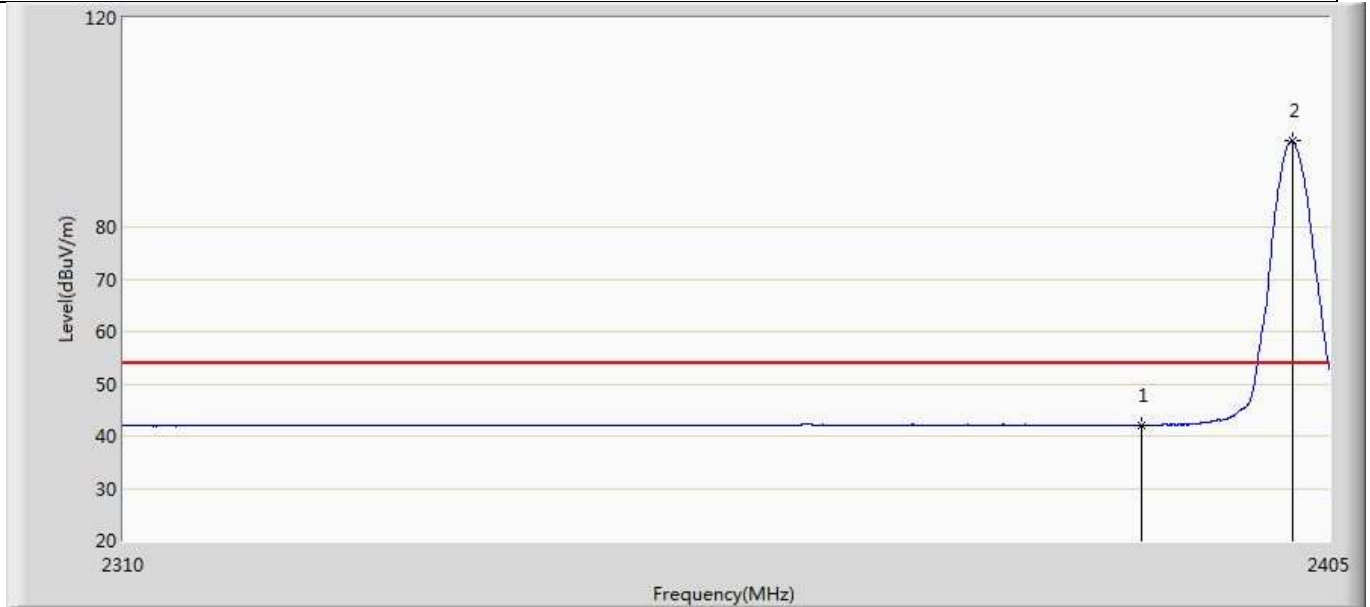

No	Mark	Frequency (MHz)	Measure Level (dBuV/m)	Reading Level (dBuV)	Over Limit (dB)	Limit (dBuV/m)	Factor (dB)	Type
1		2390.000	42.087	6.772	-11.913	54.000	35.315	AV
2	*	2402.055	96.487	61.175	42.487	54.000	35.312	AV

Profile: 2060819R	Page No.: 13
Engineer: YULIU	
Site: AC5	Time: 2020/06/25 - 20:55
Limit: FCC_Part15.209_RE(3m)	Margin: 0
Probe: Horn_3117_00167055(1-18GHz)	Polarity: Vertical
EUT: LED Device	Power: AC 120V/60Hz
Note: Mode 2:Transmit at 2480MHz by 2DH5	

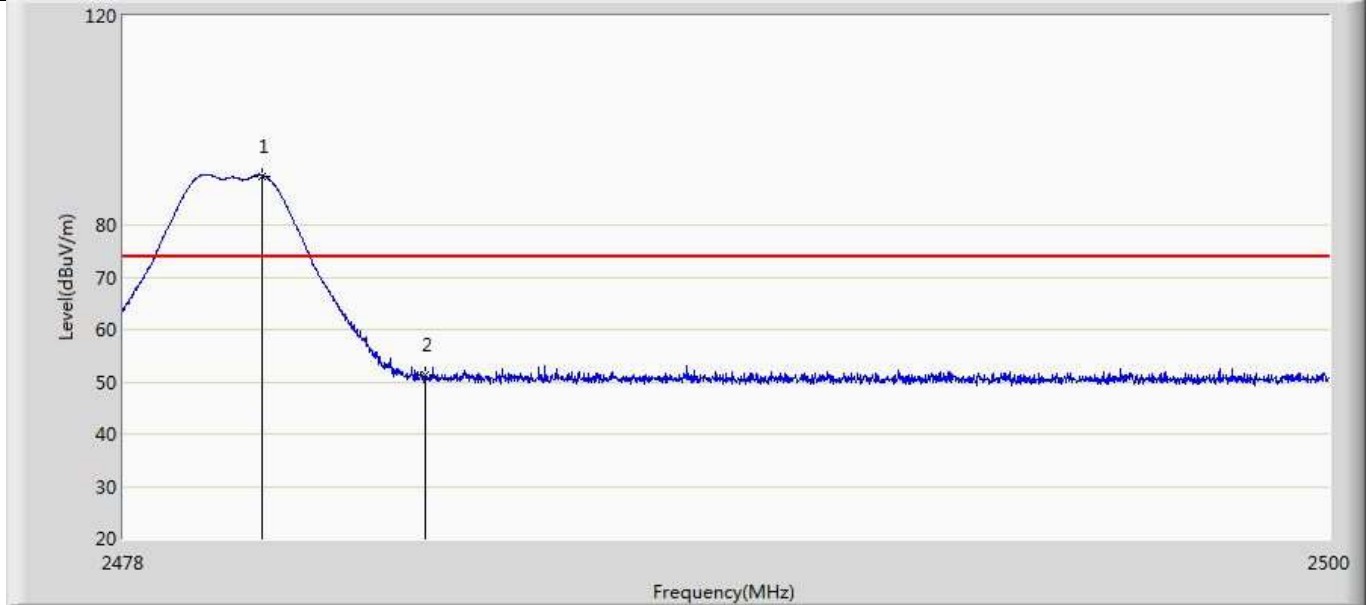

No	Mark	Frequency (MHz)	Measure Level (dBuV/m)	Reading Level (dBuV)	Over Limit (dB)	Limit (dBuV/m)	Factor (dB)	Type
1	*	2480.530	89.413	54.115	15.413	74.000	35.298	PK
2		2483.500	51.377	16.079	-22.623	74.000	35.297	PK

Profile: 2060819R	Page No.: 14
Engineer: YULIU	
Site: AC5	Time: 2020/06/25 - 21:06
Limit: FCC_Part15.209_RE(3m)	Margin: 0
Probe: Horn_3117_00167055(1-18GHz)	Polarity: Vertical
EUT: LED Device	Power: AC 120V/60Hz
Note: Mode 2:Transmit at 2480MHz by 2DH5	

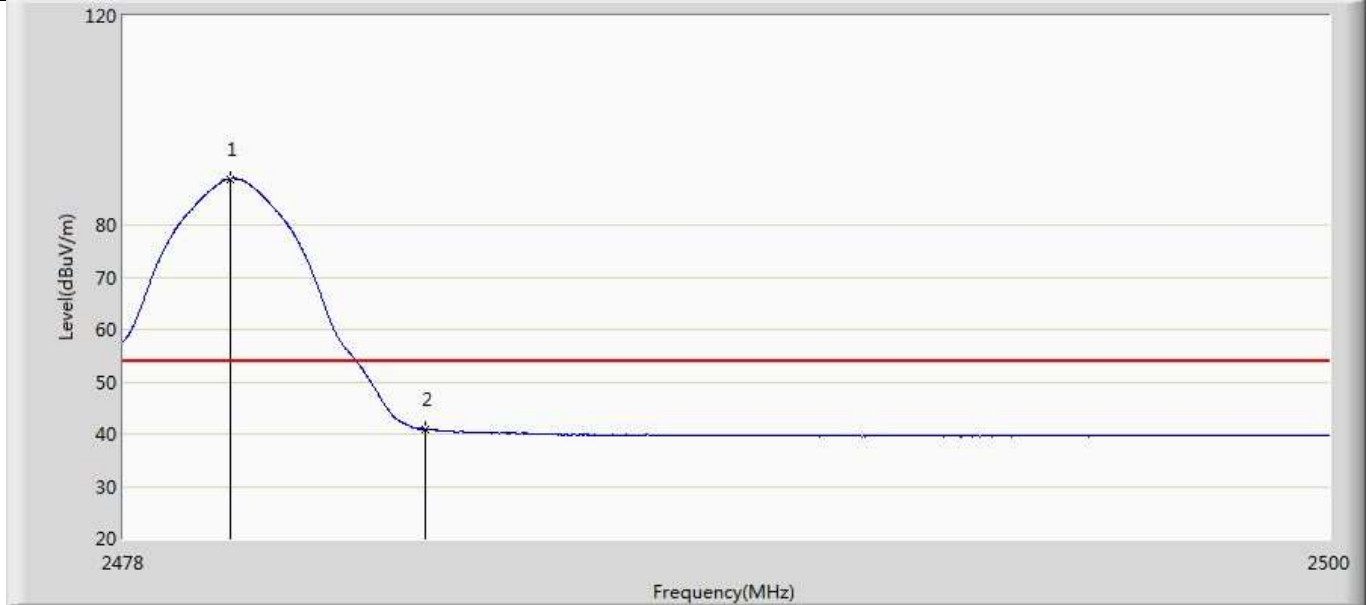

No	Mark	Frequency (MHz)	Measure Level (dBuV/m)	Reading Level (dBuV)	Over Limit (dB)	Limit (dBuV/m)	Factor (dB)	Type
1	*	2479.947	88.819	53.520	34.819	54.000	35.299	AV
2		2483.500	40.959	5.661	-13.041	54.000	35.297	AV

Profile: 2060819R	Page No.: 15
Engineer: YULIU	
Site: AC5	Time: 2020/06/25 - 21:09
Limit: FCC_Part15.209_RE(3m)	Margin: 0
Probe: Horn_3117_00167055(1-18GHz)	Polarity: Horizontal
EUT: LED Device	Power: AC 120V/60Hz
Note: Mode 2:Transmit at 2480MHz by 2DH5	

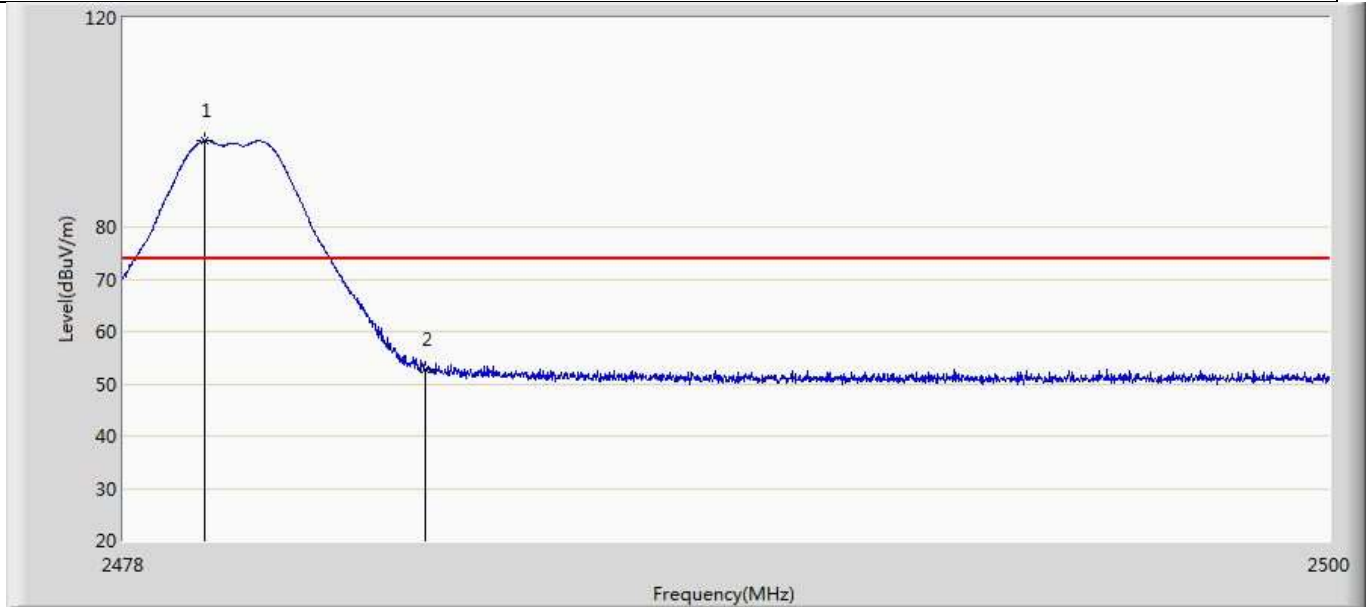

No	Mark	Frequency (MHz)	Measure Level (dBuV/m)	Reading Level (dBuV)	Over Limit (dB)	Limit (dBuV/m)	Factor (dB)	Type
1	*	2479.496	96.449	61.150	22.449	74.000	35.299	PK
2		2483.500	52.737	17.439	-21.263	74.000	35.297	PK

Profile: 2060819R	Page No.: 16
Engineer: YULIU	
Site: AC5	Time: 2020/06/25 - 21:13
Limit: FCC_Part15.209_RE(3m)	Margin: 0
Probe: Horn_3117_00167055(1-18GHz)	Polarity: Horizontal
EUT: LED Device	Power: AC 120V/60Hz
Note: Mode 2:Transmit at 2480MHz by 2DH5	

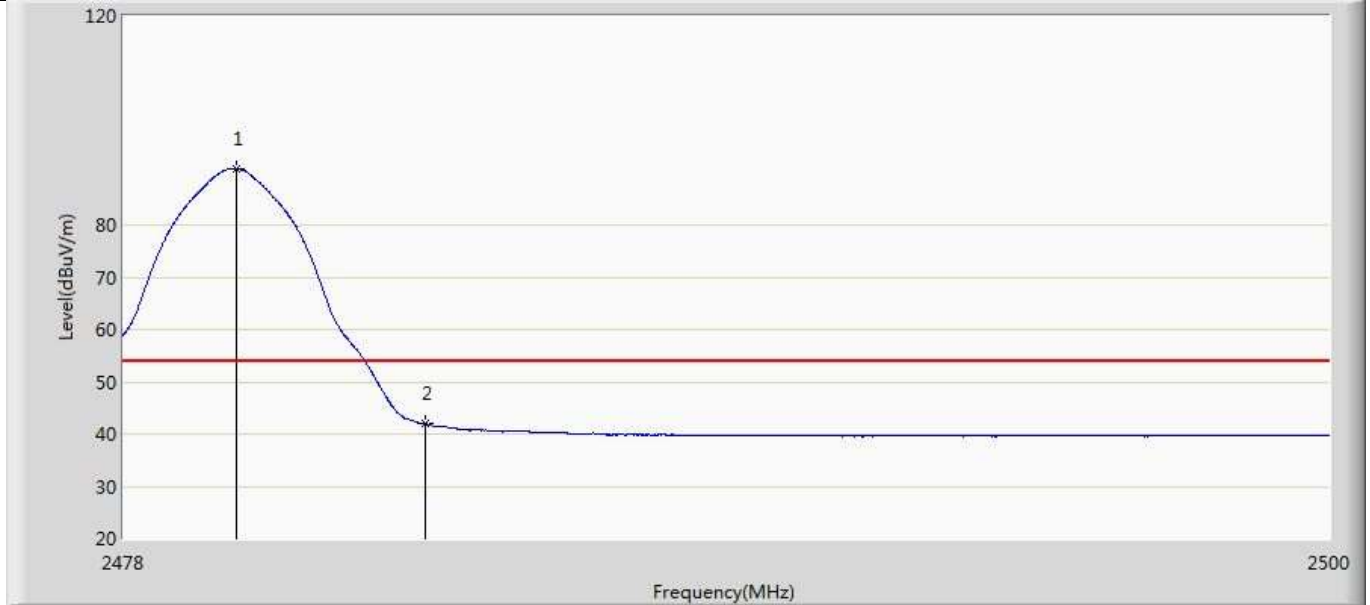

No	Mark	Frequency (MHz)	Measure Level (dBuV/m)	Reading Level (dBuV)	Over Limit (dB)	Limit (dBuV/m)	Factor (dB)	Type
1	*	2480.046	90.805	55.506	36.805	54.000	35.299	AV
2		2483.500	41.986	6.688	-12.014	54.000	35.297	AV

Profile: 2060819R	Page No.: 17
Engineer: YULIU	
Site: AC5	Time: 2020/06/25 - 21:16
Limit: FCC_Part15.209_RE(3m)	Margin: 0
Probe: Horn_3117_00167055(1-18GHz)	Polarity: Vertical
EUT: LED Device	Power: AC 120V/60Hz
Note: Mode 3:Transmit at 2402MHz by 3DH5	

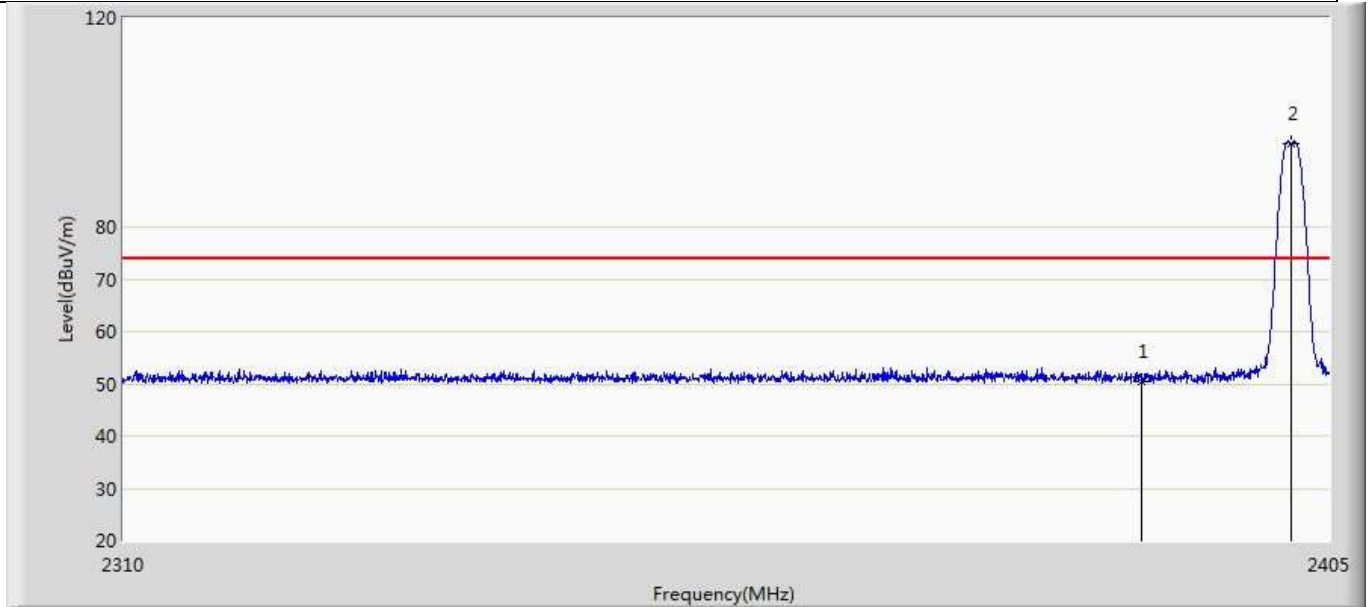

No	Mark	Frequency (MHz)	Measure Level (dBuV/m)	Reading Level (dBuV)	Over Limit (dB)	Limit (dBuV/m)	Factor (dB)	Type
1		2390.000	50.480	15.165	-23.520	74.000	35.315	PK
2	*	2401.913	95.948	60.635	21.948	74.000	35.312	PK

Profile: 2060819R	Page No.: 18
Engineer: YULIU	
Site: AC5	Time: 2020/06/25 - 21:20
Limit: FCC_Part15.209_RE(3m)	Margin: 0
Probe: Horn_3117_00167055(1-18GHz)	Polarity: Vertical
EUT: LED Device	Power: AC 120V/60Hz
Note: Mode 3:Transmit at 2402MHz by 3DH5	

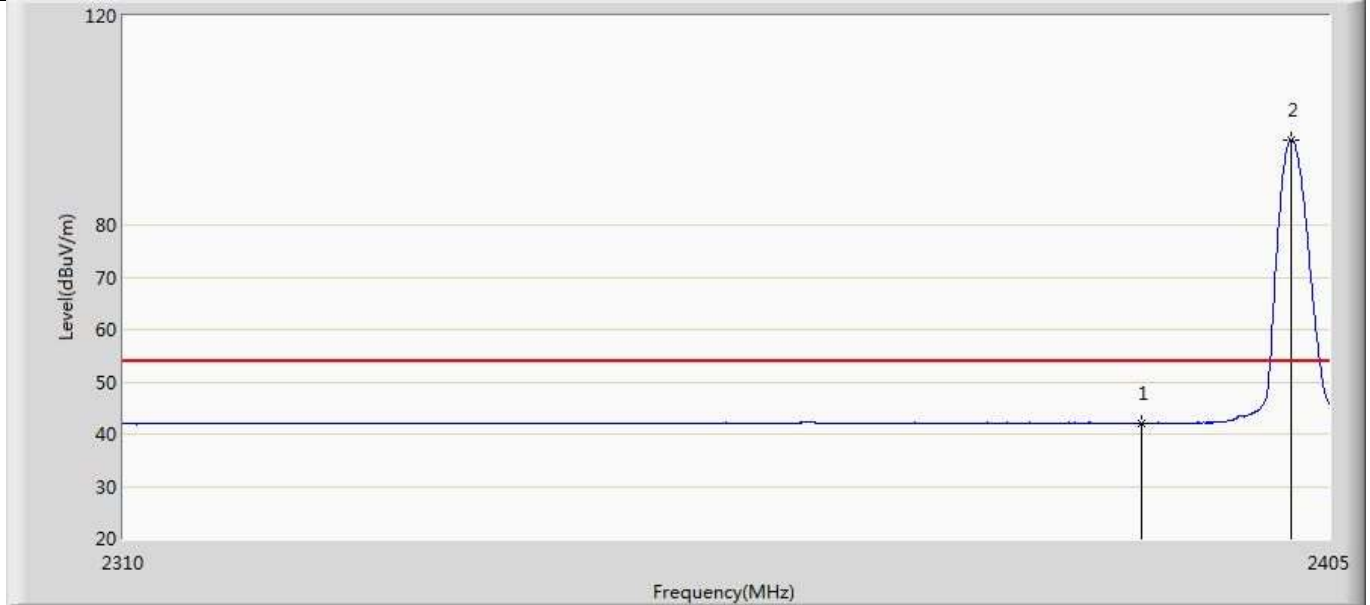

No	Mark	Frequency (MHz)	Measure Level (dBuV/m)	Reading Level (dBuV)	Over Limit (dB)	Limit (dBuV/m)	Factor (dB)	Type
1		2390.000	42.076	6.761	-11.924	54.000	35.315	AV
2	*	2401.913	96.263	60.950	42.263	54.000	35.312	AV

Profile: 2060819R	Page No.: 19
Engineer: YULIU	
Site: AC5	Time: 2020/06/25 - 21:22
Limit: FCC_Part15.209_RE(3m)	Margin: 0
Probe: Horn_3117_00167055(1-18GHz)	Polarity: Horizontal
EUT: LED Device	Power: AC 120V/60Hz
Note: Mode 3:Transmit at 2402MHz by 3DH5	

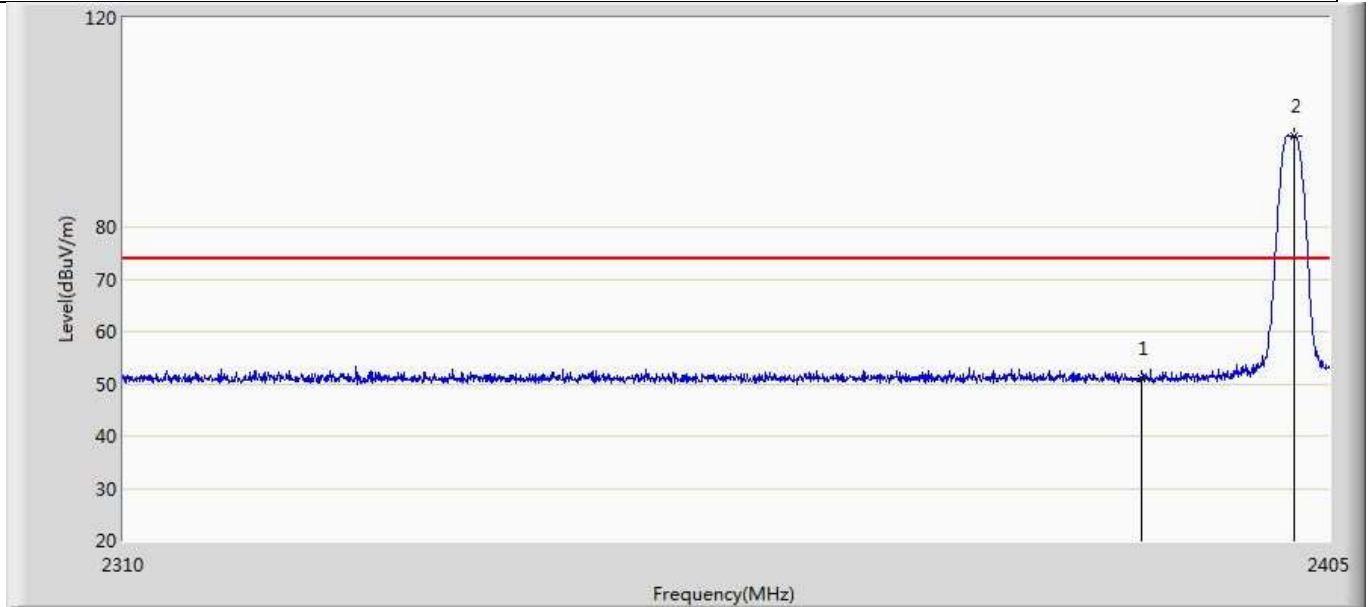

No	Mark	Frequency (MHz)	Measure Level (dBuV/m)	Reading Level (dBuV)	Over Limit (dB)	Limit (dBuV/m)	Factor (dB)	Type
1		2390.000	51.076	15.761	-22.924	74.000	35.315	PK
2	*	2402.198	97.496	62.184	23.496	74.000	35.312	PK

Profile: 2060819R	Page No.: 20
Engineer: YULIU	
Site: AC5	Time: 2020/06/25 - 21:24
Limit: FCC_Part15.209_RE(3m)	Margin: 0
Probe: Horn_3117_00167055(1-18GHz)	Polarity: Horizontal
EUT: LED Device	Power: AC 120V/60Hz
Note: Mode 3:Transmit at 2402MHz by 3DH5	

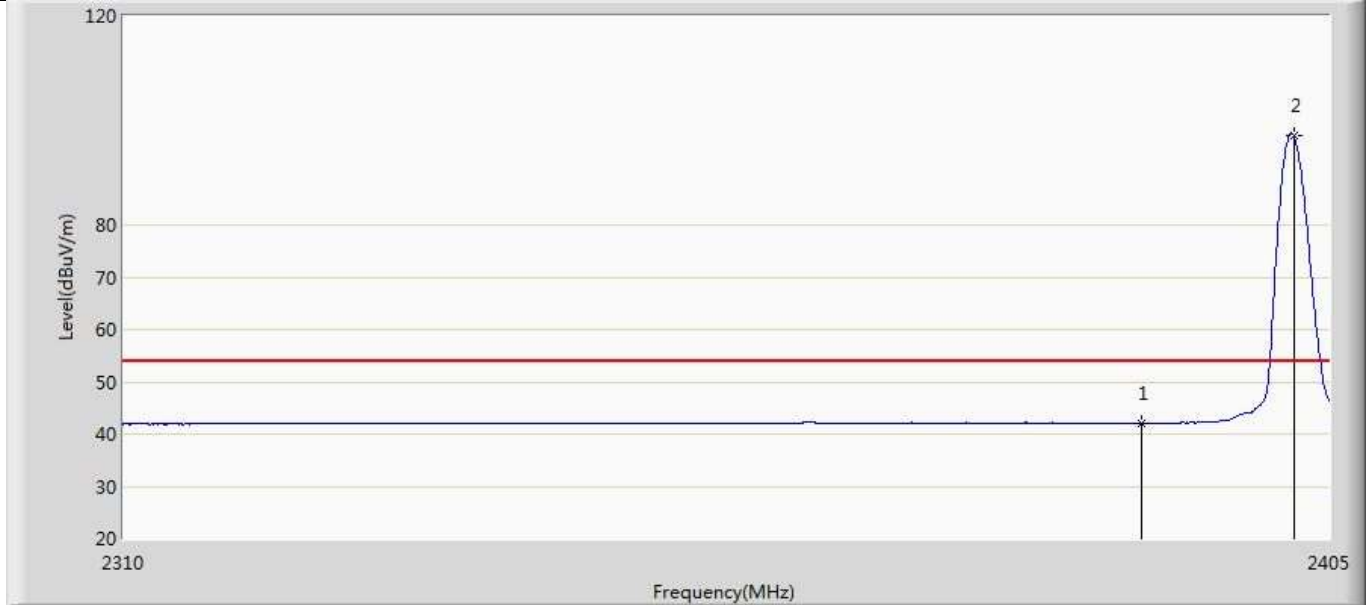

No	Mark	Frequency (MHz)	Measure Level (dBuV/m)	Reading Level (dBuV)	Over Limit (dB)	Limit (dBuV/m)	Factor (dB)	Type
1		2390.000	42.109	6.794	-11.891	54.000	35.315	AV
2	*	2402.198	96.979	61.667	42.979	54.000	35.312	AV

Profile: 2060819R	Page No.: 21
Engineer: YULIU	
Site: AC5	Time: 2020/06/25 - 21:26
Limit: FCC_Part15.209_RE(3m)	Margin: 0
Probe: Horn_3117_00167055(1-18GHz)	Polarity: Vertical
EUT: LED Device	Power: AC 120V/60Hz
Note: Mode 3:Transmit at 2480MHz by 3DH5	

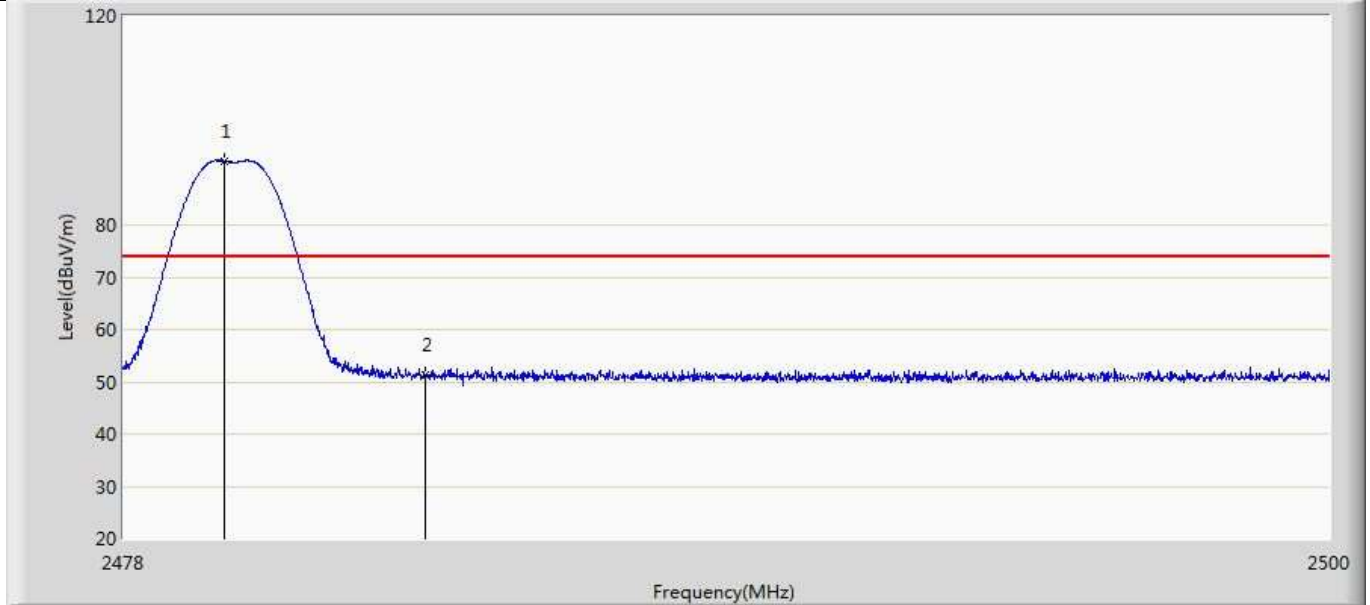

No	Mark	Frequency (MHz)	Measure Level (dBuV/m)	Reading Level (dBuV)	Over Limit (dB)	Limit (dBuV/m)	Factor (dB)	Type
1	*	2479.837	92.227	56.928	18.227	74.000	35.299	PK
2		2483.500	51.300	16.002	-22.700	74.000	35.297	PK

Profile: 2060819R	Page No.: 22
Engineer: YULIU	
Site: AC5	Time: 2020/06/25 - 21:29
Limit: FCC_Part15.209_RE(3m)	Margin: 0
Probe: Horn_3117_00167055(1-18GHz)	Polarity: Vertical
EUT: LED Device	Power: AC 120V/60Hz
Note: Mode 3:Transmit at 2480MHz by 3DH5	

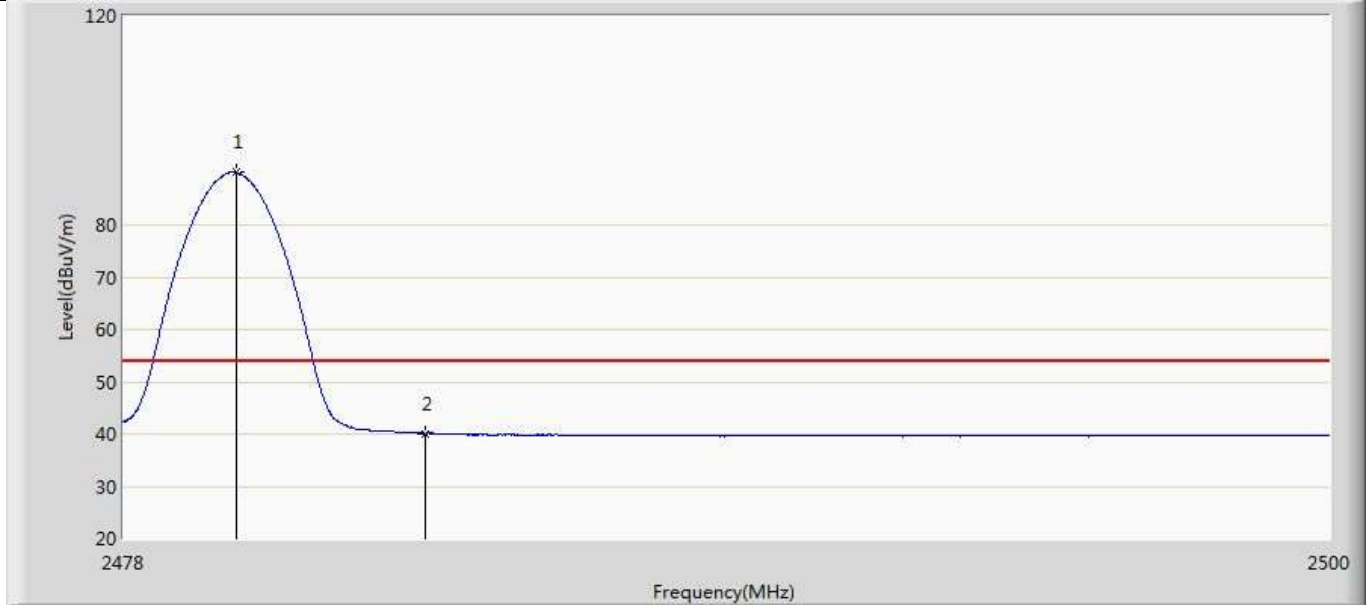

No	Mark	Frequency (MHz)	Measure Level (dBuV/m)	Reading Level (dBuV)	Over Limit (dB)	Limit (dBuV/m)	Factor (dB)	Type
1	*	2480.046	90.037	54.738	36.037	54.000	35.299	AV
2		2483.500	40.094	4.796	-13.906	54.000	35.297	AV

Profile: 2060819R	Page No.: 23
Engineer: YULIU	
Site: AC5	Time: 2020/06/25 - 21:31
Limit: FCC_Part15.209_RE(3m)	Margin: 0
Probe: Horn_3117_00167055(1-18GHz)	Polarity: Horizontal
EUT: LED Device	Power: AC 120V/60Hz
Note: Mode 3:Transmit at 2480MHz by 3DH5	

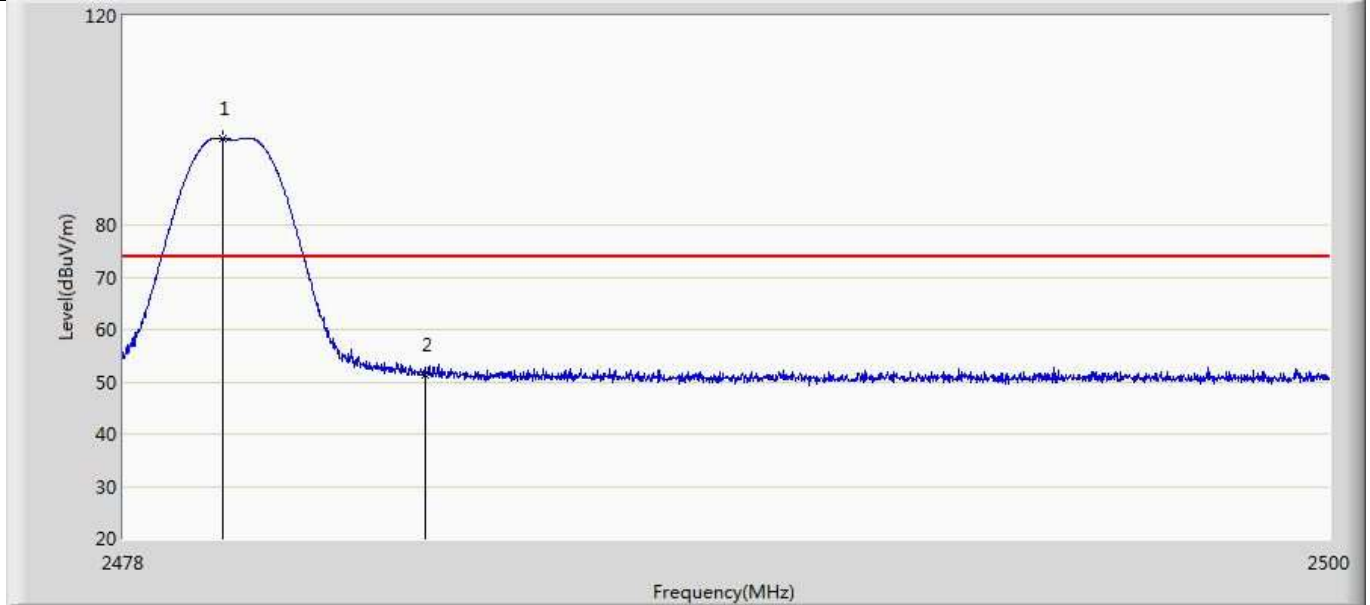

No	Mark	Frequency (MHz)	Measure Level (dBuV/m)	Reading Level (dBuV)	Over Limit (dB)	Limit (dBuV/m)	Factor (dB)	Type
1	*	2479.804	96.560	61.261	22.560	74.000	35.299	PK
2		2483.500	51.236	15.938	-22.764	74.000	35.297	PK

Profile: 2060819R	Page No.: 24
Engineer: YULIU	
Site: AC5	Time: 2020/06/25 - 21:34
Limit: FCC_Part15.209_RE(3m)	Margin: 0
Probe: Horn_3117_00167055(1-18GHz)	Polarity: Horizontal
EUT: LED Device	Power: AC 120V/60Hz
Note: Mode 3:Transmit at 2480MHz by 3DH5	

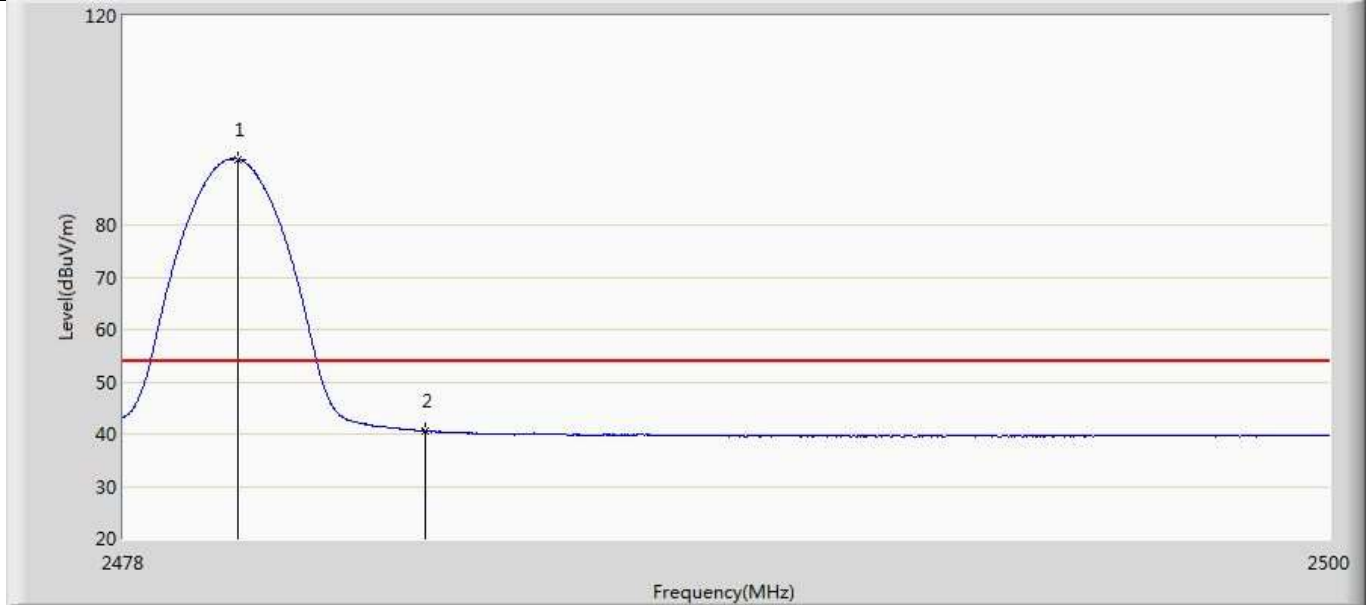

No	Mark	Frequency (MHz)	Measure Level (dBuV/m)	Reading Level (dBuV)	Over Limit (dB)	Limit (dBuV/m)	Factor (dB)	Type
1	*	2480.079	92.608	57.309	38.608	54.000	35.299	AV
2		2483.500	40.604	5.306	-13.396	54.000	35.297	AV

Profile: 2060819R	Page No.: 25
Engineer: YULIU	
Site: AC5	Time: 2020/06/25 - 21:36
Limit: FCC_Part15.209_RE(3m)	Margin: 0
Probe: Horn_3117_00167055(1-18GHz)	Polarity: Vertical
EUT: LED Device	Power: AC 120V/60Hz
Note: Mode 4:Transmit at 2402MHz by BLE	

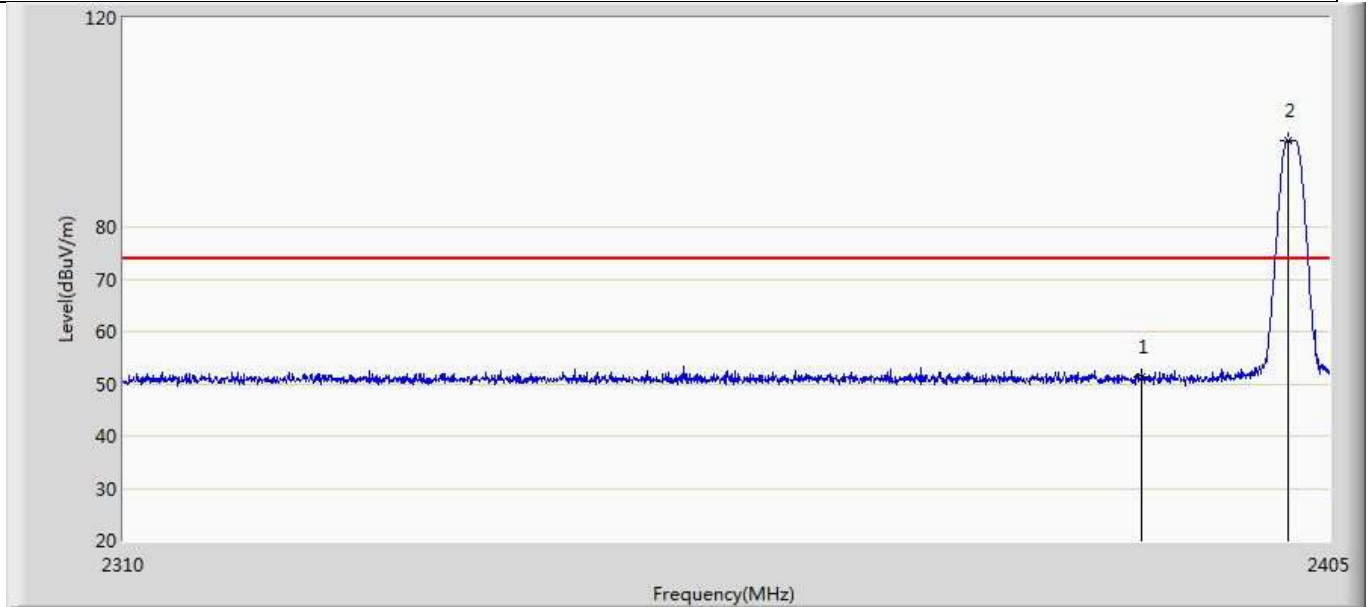

No	Mark	Frequency (MHz)	Measure Level (dBuV/m)	Reading Level (dBuV)	Over Limit (dB)	Limit (dBuV/m)	Factor (dB)	Type
1		2390.000	51.237	15.922	-22.763	74.000	35.315	PK
2	*	2401.770	96.608	61.295	22.608	74.000	35.312	PK

Profile: 2060819R	Page No.: 26
Engineer: YULIU	
Site: AC5	Time: 2020/06/25 - 21:39
Limit: FCC_Part15.209_RE(3m)	Margin: 0
Probe: Horn_3117_00167055(1-18GHz)	Polarity: Vertical
EUT: LED Device	Power: AC 120V/60Hz
Note: Mode 4:Transmit at 2402MHz by BLE	

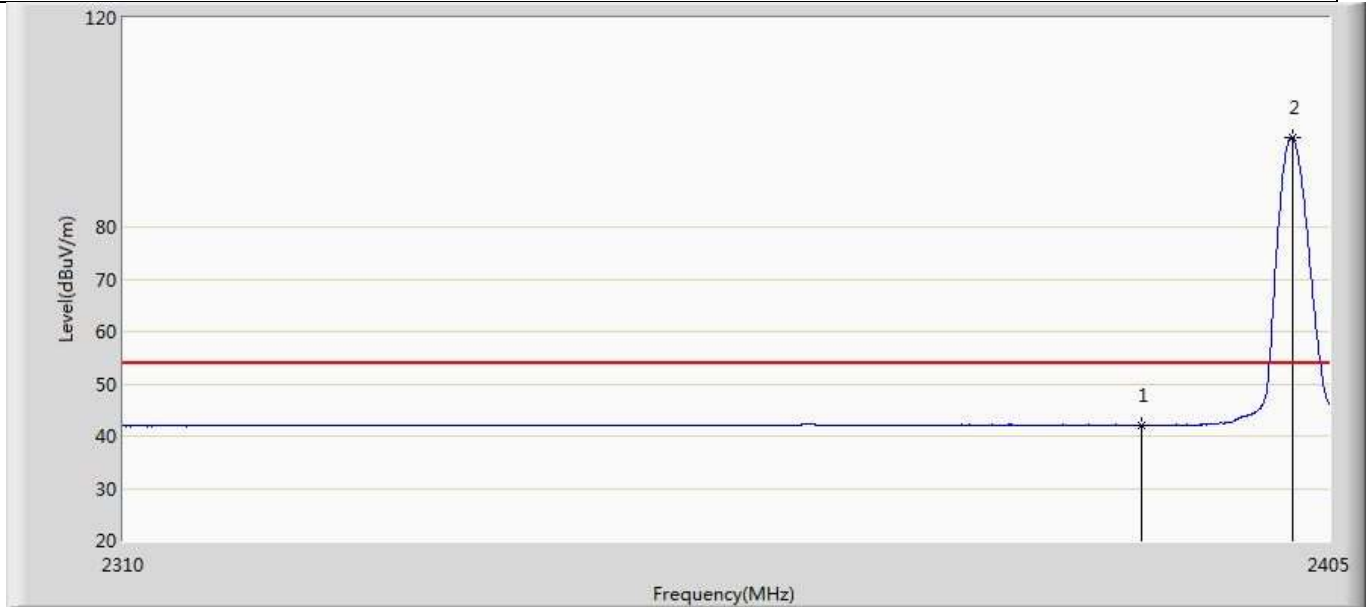

No	Mark	Frequency (MHz)	Measure Level (dBuV/m)	Reading Level (dBuV)	Over Limit (dB)	Limit (dBuV/m)	Factor (dB)	Type
1		2390.000	42.058	6.743	-11.942	54.000	35.315	AV
2	*	2402.055	97.228	61.916	43.228	54.000	35.312	AV

Profile: 2060819R	Page No.: 27
Engineer: YULIU	
Site: AC5	Time: 2020/06/25 - 21:42
Limit: FCC_Part15.209_RE(3m)	Margin: 0
Probe: Horn_3117_00167055(1-18GHz)	Polarity: Horizontal
EUT: LED Device	Power: AC 120V/60Hz
Note: Mode 4:Transmit at 2402MHz by BLE	

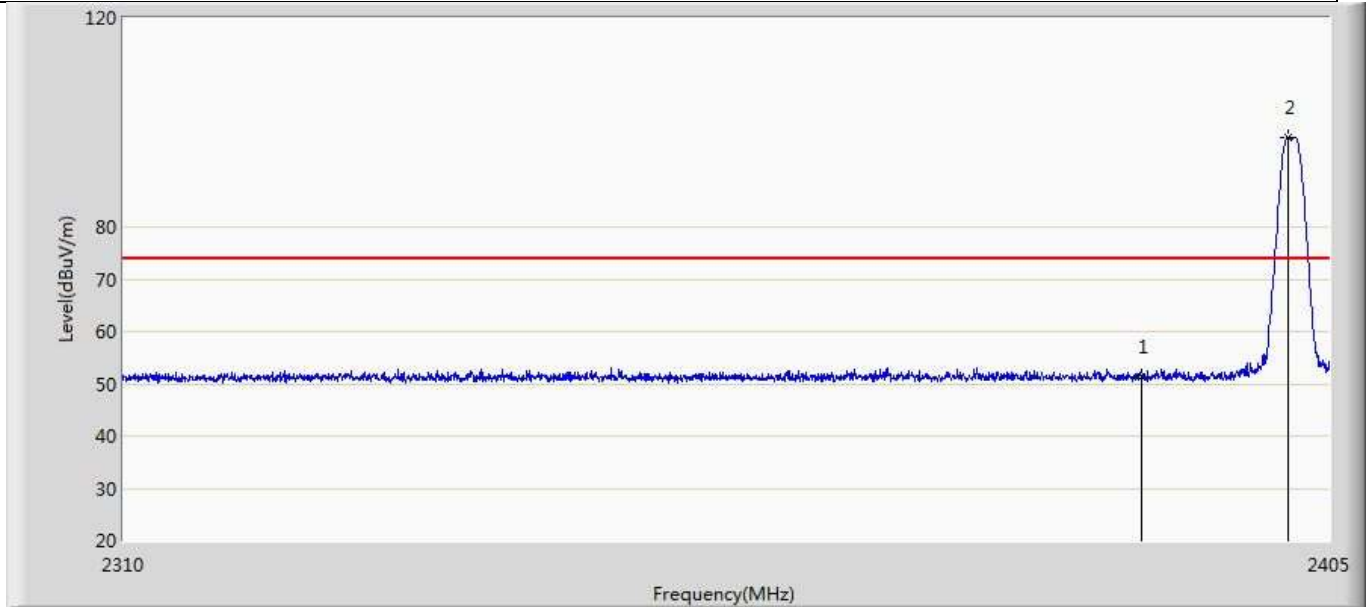

No	Mark	Frequency (MHz)	Measure Level (dBuV/m)	Reading Level (dBuV)	Over Limit (dB)	Limit (dBuV/m)	Factor (dB)	Type
1		2390.000	51.416	16.101	-22.584	74.000	35.315	PK
2	*	2401.770	97.178	61.865	23.178	74.000	35.312	PK

Profile: 2060819R	Page No.: 28
Engineer: YULIU	
Site: AC5	Time: 2020/06/25 - 21:44
Limit: FCC_Part15.209_RE(3m)	Margin: 0
Probe: Horn_3117_00167055(1-18GHz)	Polarity: Horizontal
EUT: LED Device	Power: AC 120V/60Hz
Note: Mode 4:Transmit at 2402MHz by BLE	

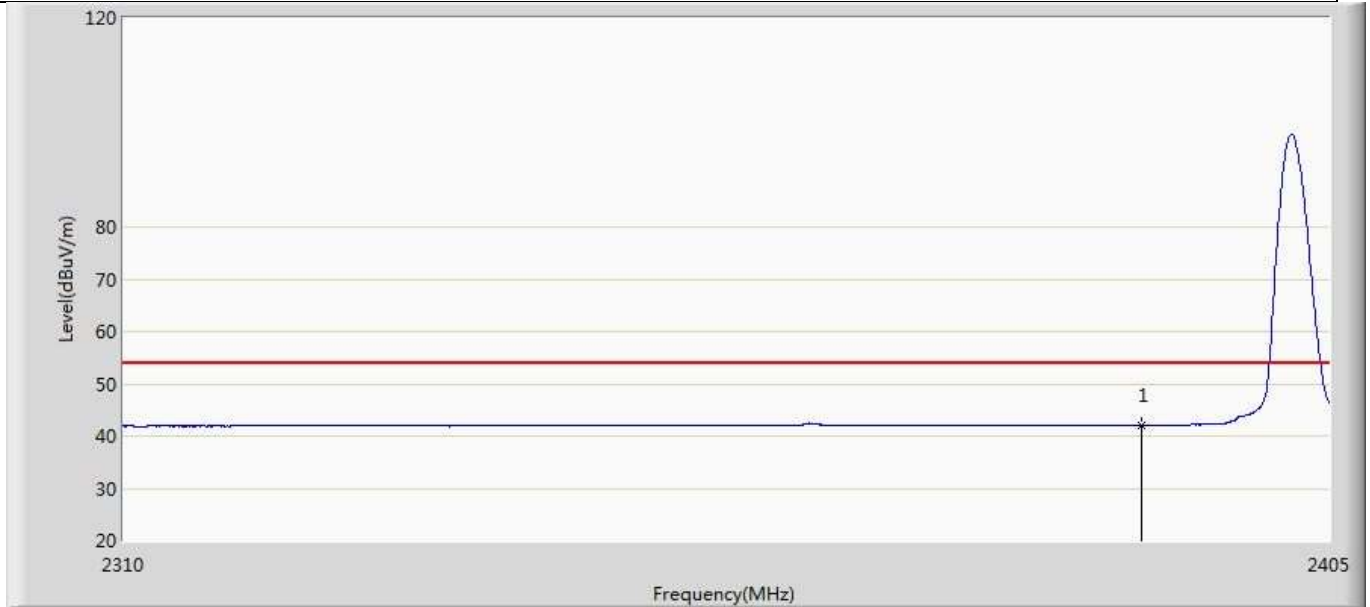

No	Mark	Frequency (MHz)	Measure Level (dBuV/m)	Reading Level (dBuV)	Over Limit (dB)	Limit (dBuV/m)	Factor (dB)	Type
1	*	2390.000	42.010	6.695	-11.990	54.000	35.315	AV

Profile: 2060819R	Page No.: 29
Engineer: YULIU	
Site: AC5	Time: 2020/06/25 - 21:46
Limit: FCC_Part15.209_RE(3m)	Margin: 0
Probe: Horn_3117_00167055(1-18GHz)	Polarity: Vertical
EUT: LED Device	Power: AC 120V/60Hz
Note: Mode 4:Transmit at 2480MHz by BLE	

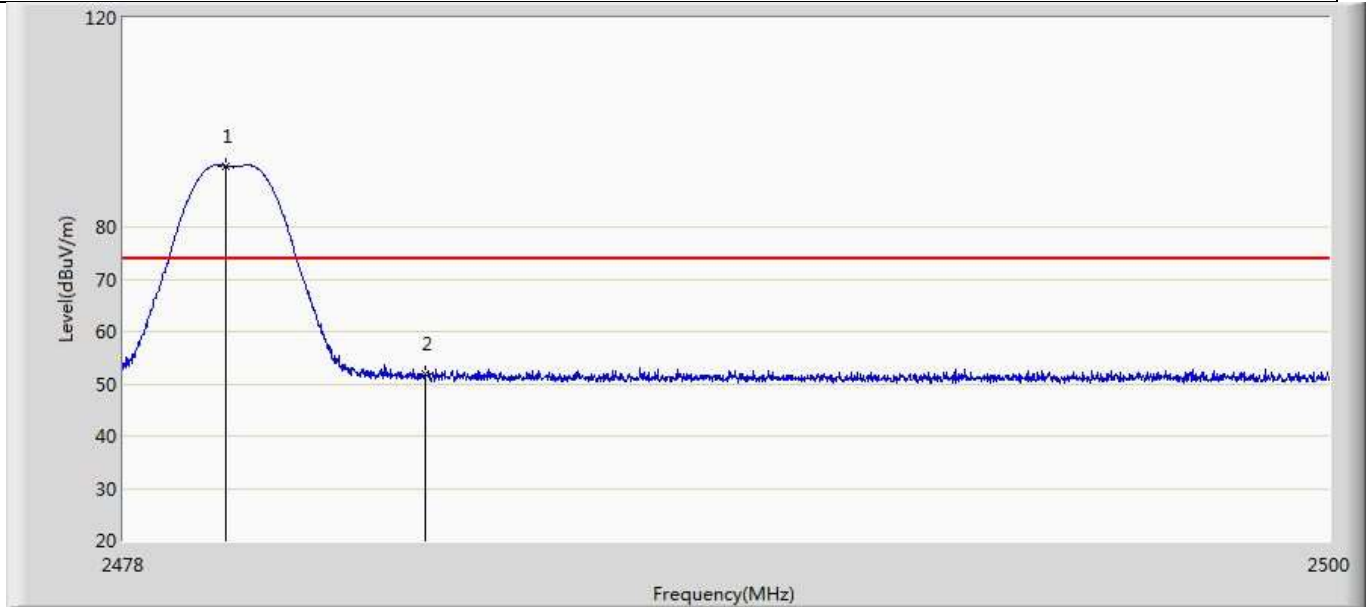

No	Mark	Frequency (MHz)	Measure Level (dBuV/m)	Reading Level (dBuV)	Over Limit (dB)	Limit (dBuV/m)	Factor (dB)	Type
1	*	2479.870	91.663	56.364	17.663	74.000	35.299	PK
2		2483.500	51.945	16.647	-22.055	74.000	35.297	PK

Profile: 2060819R	Page No.: 30
Engineer: YULIU	
Site: AC5	Time: 2020/06/25 - 21:51
Limit: FCC_Part15.209_RE(3m)	Margin: 0
Probe: Horn_3117_00167055(1-18GHz)	Polarity: Vertical
EUT: LED Device	Power: AC 120V/60Hz
Note: Mode 4:Transmit at 2480MHz by BLE	

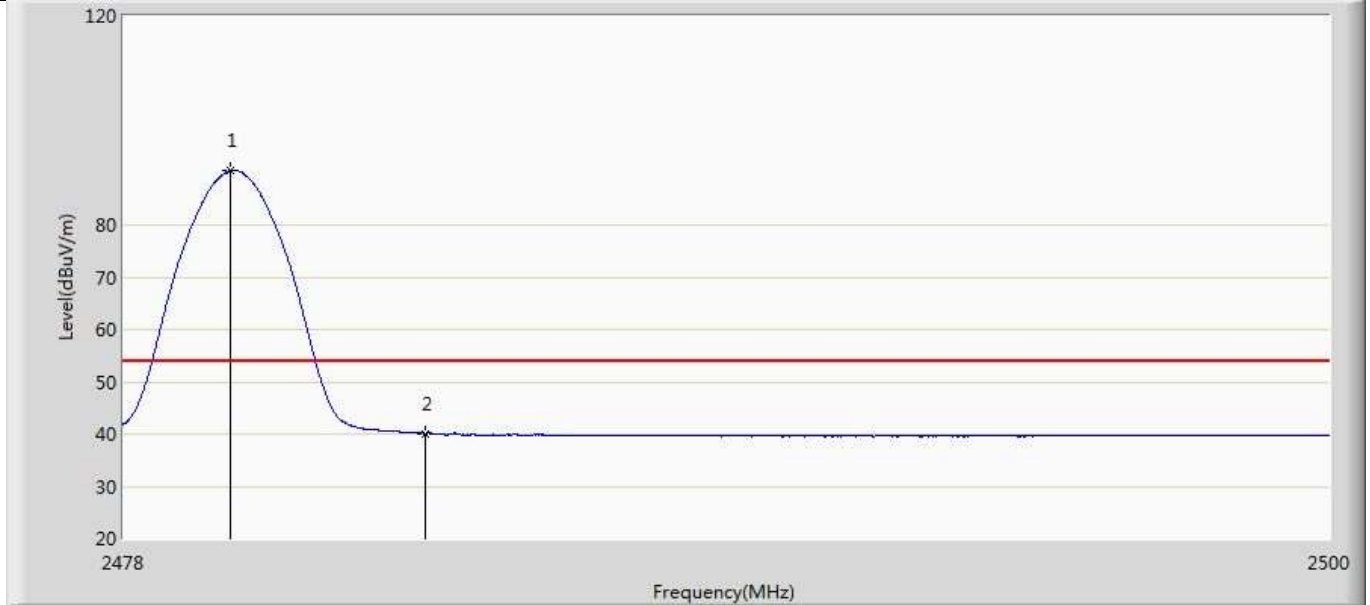

No	Mark	Frequency (MHz)	Measure Level (dBuV/m)	Reading Level (dBuV)	Over Limit (dB)	Limit (dBuV/m)	Factor (dB)	Type
1	*	2479.947	90.358	55.059	36.358	54.000	35.299	AV
2		2483.500	40.060	4.762	-13.940	54.000	35.297	AV

Profile: 2060819R	Page No.: 31
Engineer: YULIU	
Site: AC5	Time: 2020/06/25 - 21:54
Limit: FCC_Part15.209_RE(3m)	Margin: 0
Probe: Horn_3117_00167055(1-18GHz)	Polarity: Horizontal
EUT: LED Device	Power: AC 120V/60Hz
Note: Mode 4:Transmit at 2480MHz by BLE	

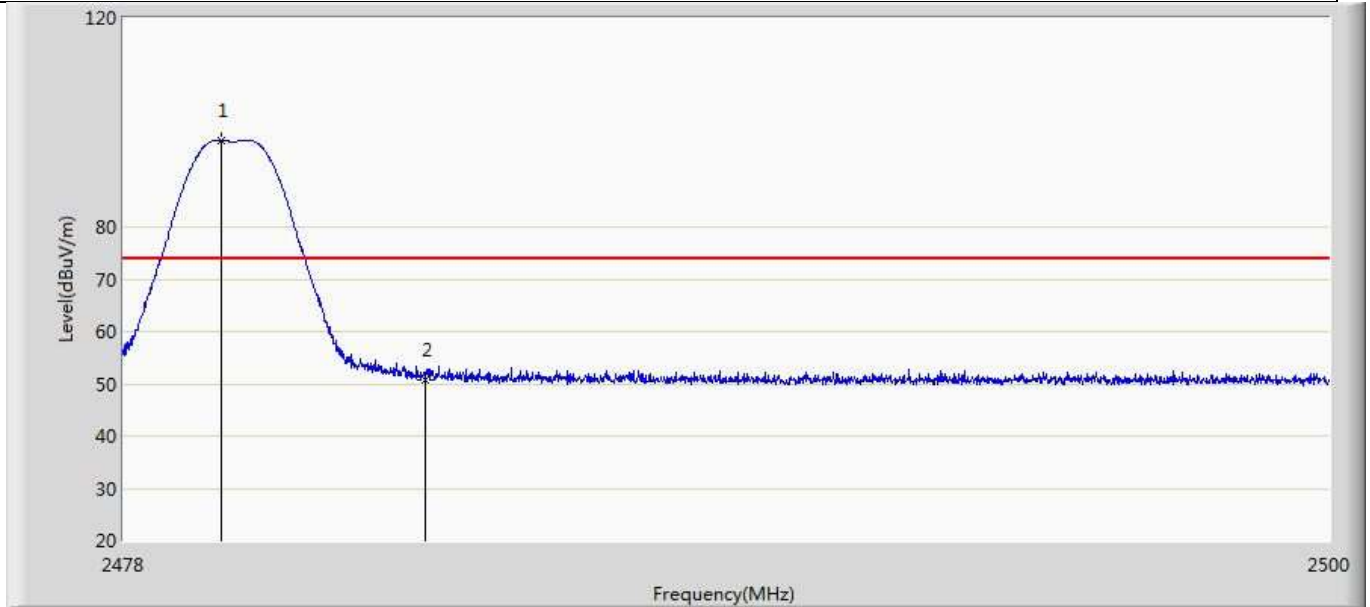

No	Mark	Frequency (MHz)	Measure Level (dBuV/m)	Reading Level (dBuV)	Over Limit (dB)	Limit (dBuV/m)	Factor (dB)	Type
1	*	2479.771	96.584	61.285	22.584	74.000	35.299	PK
2		2483.500	50.814	15.516	-23.186	74.000	35.297	PK

Profile: 2060819R	Page No.: 32
Engineer: YULIU	
Site: AC5	Time: 2020/06/25 - 21:56
Limit: FCC_Part15.209_RE(3m)	Margin: 0
Probe: Horn_3117_00167055(1-18GHz)	Polarity: Horizontal
EUT: LED Device	Power: AC 120V/60Hz
Note: Mode 4:Transmit at 2480MHz by BLE	

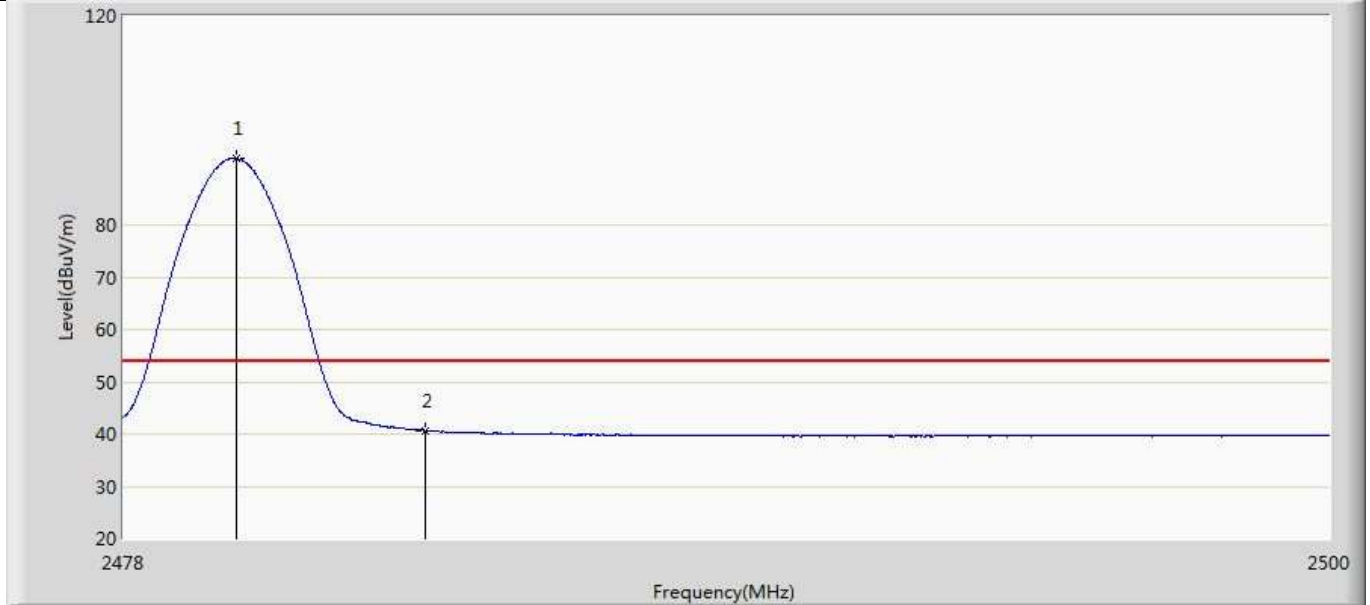

No	Mark	Frequency (MHz)	Measure Level (dBuV/m)	Reading Level (dBuV)	Over Limit (dB)	Limit (dBuV/m)	Factor (dB)	Type
1	*	2480.046	92.729	57.430	38.729	54.000	35.299	AV
2		2483.500	40.702	5.404	-13.298	54.000	35.297	AV

4.6 DTS Bandwidth

VERDICT: PASS

4.6.1 Limit

Standard FCC Part 15 Subpart C Paragraph 15.247 (a)(2)

Systems using digital modulation techniques operate in the 2400-2483.5 MHz. The minimum 6 dB bandwidth shall be at least 500 kHz

4.6.2 Test Setup

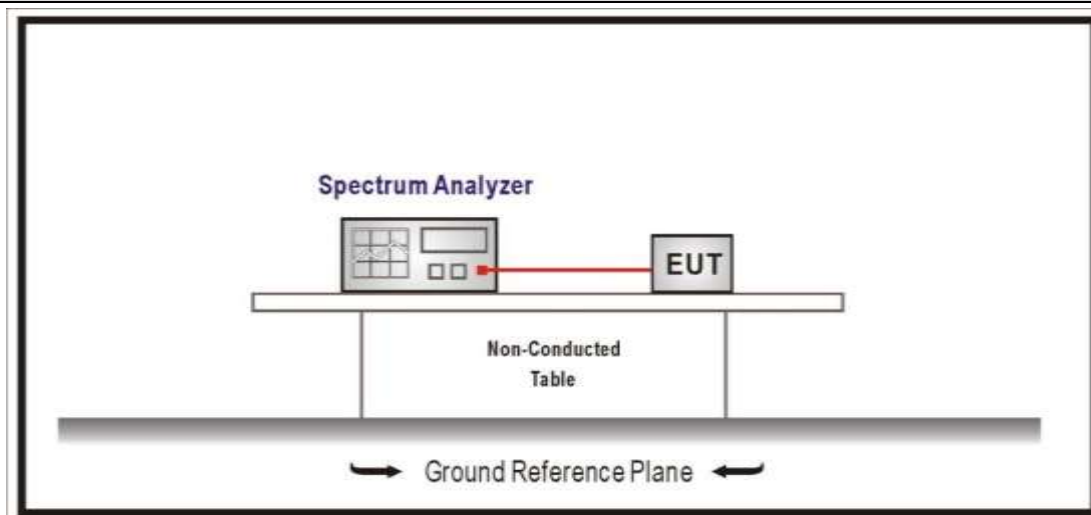

4.6.3 Test Procedure

	Reference Rule	Chapter	Description
<input checked="" type="checkbox"/>	ANSI C63.10	11.8	DTS bandwidth
<input type="checkbox"/>	ANSI C63.10	11.8.1	Option 1
<input checked="" type="checkbox"/>	ANSI C63.10	11.8.2	Option 2

4.6.4 Test Data

Mode	CH.	Test Freq. (MHz)	99% Occupied Bandwidth (kHz)	6dB Occupied Bandwidth (kHz)	Limit (kHz)	Result
1	00	2402	1052.3	705.5	>500	Pass
	19	2440	1053.1	705.8	>500	Pass
	39	2480	1046.9	701.3	>500	Pass
2	00	2402	2090.4	1367.0	>500	Pass
	19	2440	2100.5	1367.0	>500	Pass
	39	2480	2101.1	1366.0	>500	Pass
3	00	2402	1118.9	789.1	>500	Pass
	19	2440	1116.0	786.6	>500	Pass
	39	2480	1113.9	785.8	>500	Pass
4	00	2402	1144.1	754.3	>500	Pass
	19	2440	1140.6	753.3	>500	Pass
	39	2480	1137.8	750.1	>500	Pass

Note : The worst case of Occupied Bandwidth as below:

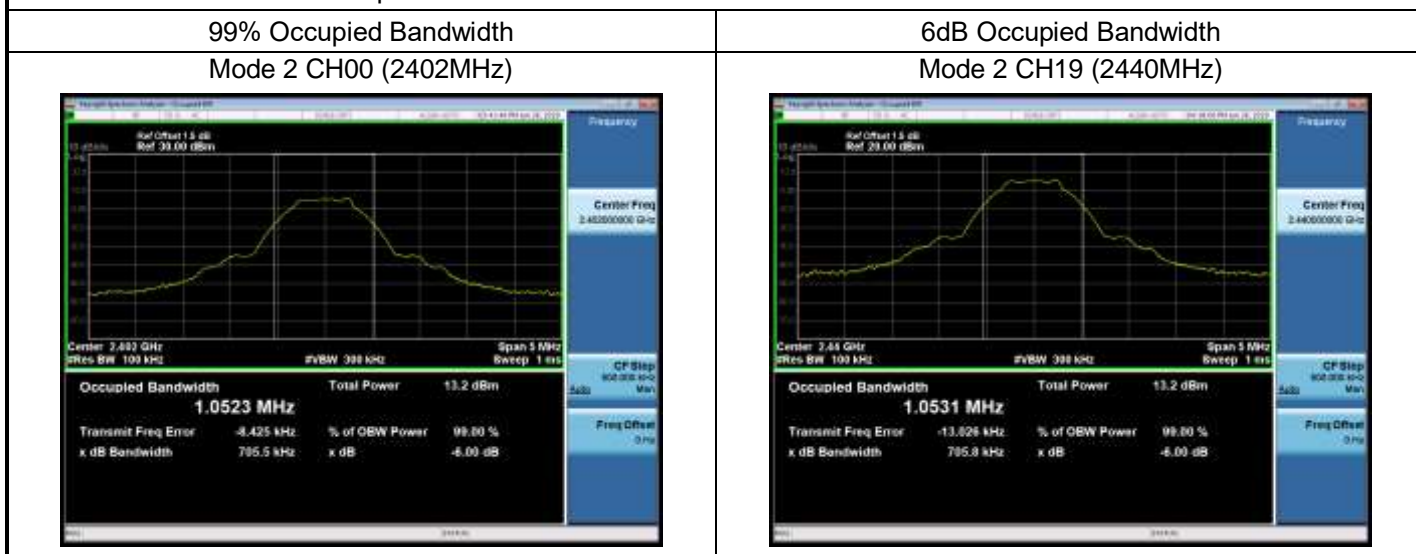

4.7 Fundamental emission output power	VERDICT: PASS
--	----------------------

4.7.1 Limit		
Standard	FCC Part 15 Subpart C Paragraph 15.247 (b)(3)	
<input checked="" type="checkbox"/>	GTX < 6dBi	Pout ≤ 30dBm
<input type="checkbox"/>	GTX > 6dBi	
<input type="checkbox"/>	Non-Fix point-point	Pout ≤ 30 - (GTX - 6)
<input type="checkbox"/>	Fix point-point	Pout ≤ 30 - [(GTX - 6)]/3
<input type="checkbox"/>	Point-to-multipoint	Pout ≤ 30 - (GTX - 6)
<input type="checkbox"/>	Overlap Beams	Pout ≤ 30 - [(GTX - 6)]/3
<input type="checkbox"/>	Aggregate power transmitted simultaneously on all beams	Pout ≤ 30 - [(GTX - 6)]/3
<input type="checkbox"/>	single directional beam	Pout ≤ 30 - [(GTX - 6)]/3 + 8dB

Note 1 : GTX directional gain of transmitting antennas.
 Note 2 : Pout is maximum peak conducted output power .

4.7.2 Test Setup

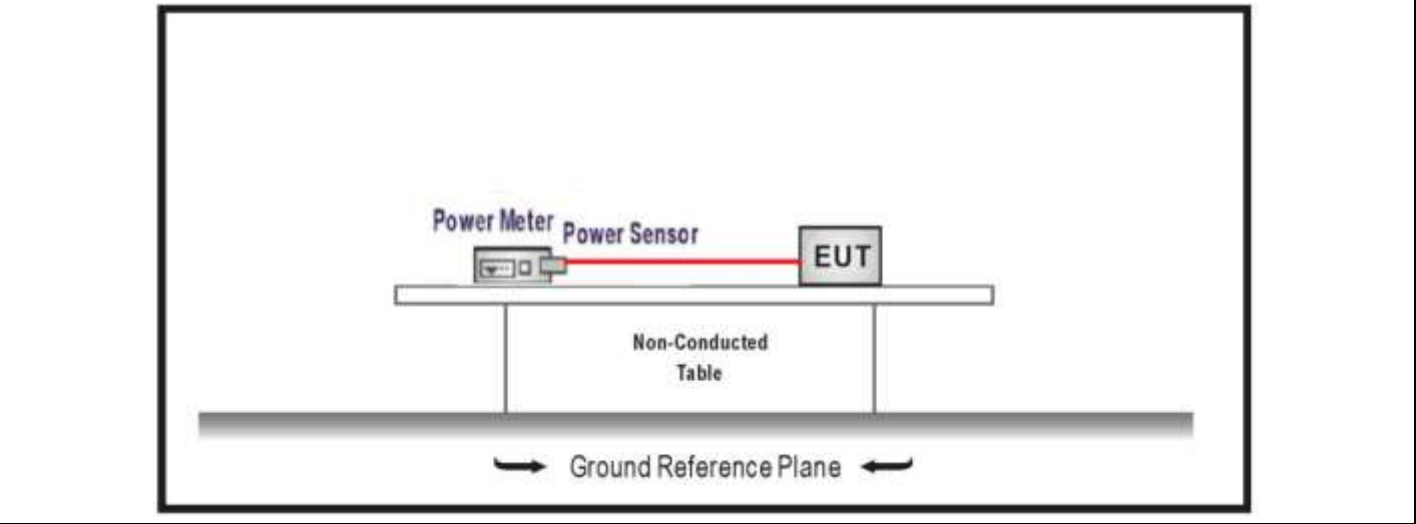

4.7.3 Test Procedure					
	References Rule		Chapter	Description	
<input checked="" type="checkbox"/>	ANSI C63.10		11.9	Fundamental emission output power	
	<input checked="" type="checkbox"/>	ANSI C63.10		11.9.1 Maximum peak conducted output power	
		<input type="checkbox"/>	ANSI C63.10	11.9.1.1 RBW \geq DTS bandwidth	
		<input type="checkbox"/>	ANSI C63.10	11.9.1.2 Integrated band power method	
		<input type="checkbox"/>	ANSI C63.10	11.9.1.3 PKPM1 Peak power meter method	
	<input type="checkbox"/>	ANSI C63.10		11.9.2 Maximum conducted (average) output power	
		<input type="checkbox"/>	ANSI C63.10		11.9.2.2 Measurement using a spectrum analyzer (SA)
			<input type="checkbox"/>	ANSI C63.10	11.9.2.2.2 Method AVGSA-1(Duty cycle \geq 98%)
			<input type="checkbox"/>	ANSI C63.10	11.9.2.2.3 Method AVGSA-1A(Duty cycle \geq 98%)
			<input type="checkbox"/>	ANSI C63.10	11.9.2.2.4 Method AVGSA-2(Duty cycle \leq 98%)
			<input type="checkbox"/>	ANSI C63.10	11.9.2.2.5 Method AVGSA-2A(Duty cycle \leq 98%)
			<input type="checkbox"/>	ANSI C63.10	11.9.2.2.4 Method AVGSA-3
			<input type="checkbox"/>	ANSI C63.10	11.9.2.2.5 Method AVGSA-3A
		<input checked="" type="checkbox"/>	ANSI C63.10		11.9.2.3 Measurement using a power meter (PM)
		<input checked="" type="checkbox"/>	ANSI C63.10	11.9.2.3.1 Method AVGPM	
<input type="checkbox"/>		ANSI C63.10	11.9.2.3.2 Method AVGPM-G		

4.7.4 Test Data

Mode	Channel	Test Frequency (MHz)	Power Output (dBm)	Limit (dBm)	Result
Mode 1	00	2402	8.72	≤ 30	Pass
	19	2440	8.39	≤ 30	Pass
	39	2480	8.55	≤ 30	Pass
Mode 2	00	2402	9.86	≤ 30	Pass
	19	2440	9.51	≤ 30	Pass
	39	2480	9.65	≤ 30	Pass
Mode 3	00	2402	8.92	≤ 30	Pass
	19	2440	8.66	≤ 30	Pass
	39	2480	8.79	≤ 30	Pass
Mode 4	00	2402	8.86	≤ 30	Pass
	19	2440	8.67	≤ 30	Pass
	39	2480	8.81	≤ 30	Pass

4.8 Power Density

VERDICT: PASS

4.8.1 Limit:

Standard FCC Part 15 Subpart C Paragraph 15.247 (b)(3)

Power Spectral Density $\leq 8\text{dBm}/3\text{kHz}$

4.8.2 Test Setup

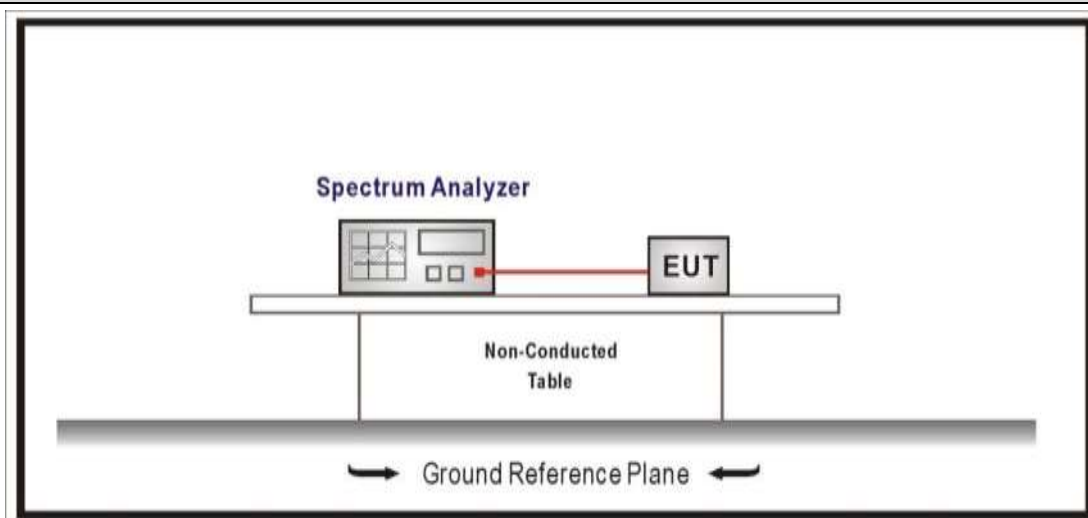

4.8.3 Test Procedure

	References Rule	Chapter	Description
<input checked="" type="checkbox"/>	ANSI C63.10	11.10	Maximum power spectral density level in the fundamental emission
<input checked="" type="checkbox"/>	ANSI C63.10	11.10.2	Method PKPSD (peak PSD)
<input type="checkbox"/>	ANSI C63.10	11.10.3	Method AVGPSD-1(Duty cycle $\geq 98\%$)
<input type="checkbox"/>	ANSI C63.10	11.10.4	Method AVGPSD-1A(Duty cycle $\geq 98\%$)
<input type="checkbox"/>	ANSI C63.10	11.10.5	Method AVGPSD-2(Duty cycle $< 98\%$)
<input type="checkbox"/>	ANSI C63.10	11.10.6	Method AVGPSD-2A(Duty cycle $< 98\%$)
<input type="checkbox"/>	ANSI C63.10	11.10.7	Method AVGPSD-3
<input type="checkbox"/>	ANSI C63.10	11.10.8	Method AVGPSD-3A

4.8.4 Test Data

Mode	Channel	Test Frequency (MHz)	Measurement PSD (dBm/3kHz)	Limit (dBm/3kHz)	Result
Mode 1	00	2402	-8.588	≤8	Pass
	19	2440	-8.582	≤8	Pass
	39	2480	-8.396	≤8	Pass
Mode 2	00	2402	-10.734	≤8	Pass
	19	2440	-11.057	≤8	Pass
	39	2480	-10.874	≤8	Pass
Mode 3	00	2402	-10.648	≤8	Pass
	19	2440	-10.912	≤8	Pass
	39	2480	-10.690	≤8	Pass
Mode 4	00	2402	1.465	≤8	Pass
	19	2440	1.171	≤8	Pass
	39	2480	1.205	≤8	Pass

Note : The worst case of PSD as below:

Mode 4 CH00(2402MHz)

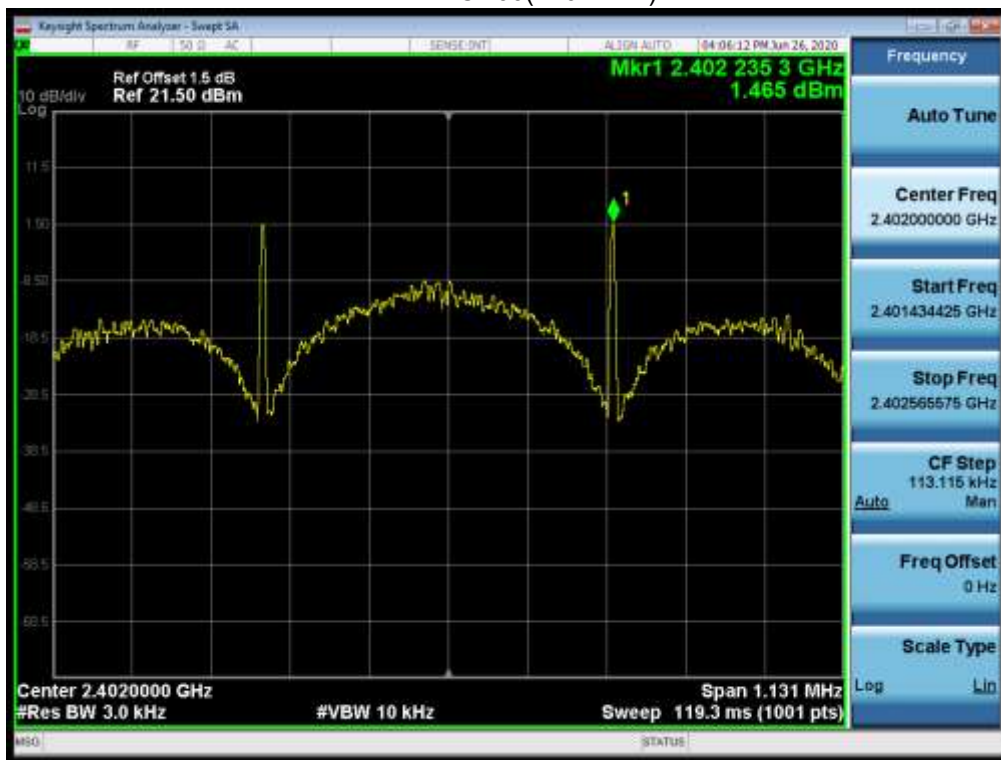

4.9 Antenna Requirement

VERDICT: PASS

4.9.1 Limit:

Standard	FCC Part 15 Subpart C Paragraph 15.203
-----------------	--

An intentional radiator shall be designed to ensure that no antenna other than that furnished by the responsible party shall be used with the device. The use of a permanently attached antenna or of an antenna that uses a unique coupling to the intentional radiator shall be considered sufficient to comply with the provisions of this section. The manufacturer may design the unit so that a broken antenna can be replaced by the user, but the use of a standard antenna jack or electrical connector is prohibited. This requirement does not apply to carrier current devices or to devices operated under the provisions of §15.211, §15.213, §15.217, §15.219, or §15.221. Further, this requirement does not apply to intentional radiators that must be professionally installed, such as perimeter protection systems and some field disturbance sensors, or to other intentional radiators which, in accordance with §15.31(d), must be measured at the installation site. However, the installer shall be responsible for ensuring that the proper antenna is employed so that the limits in this part are not exceeded.

4.9.2 Antenna Connector Construction:

- | | |
|-------------------------------------|--|
| <input checked="" type="checkbox"/> | The use of a permanently attached antenna |
| <input type="checkbox"/> | The antenna use of a unique coupling to the intentional radiator |
| <input type="checkbox"/> | The use of a nonstandard antenna jack or electrical connector |
- Please refer to the attached document "Internal Photograph" to show the antenna connector.

5 TEST SETUP PHOTO AND EUT PHOTO

Remark: The test setup photo and EUT Photo please see appendix.

_____ The End _____