



Test report No:
2060819R-RF-US-P06V01

FCC & ISED TEST REPORT

Product Name	LED Device
Trademark	PHILIPS
Model and /or type reference	9290024227, 9290024228, 9290024229
FCC ID	2AGBW9290024227X(9290024227) 2AGBW9290024228X(9290024228) 2AGBW9290024229X(9290024229)
IC	20812-4227X(9290024227) 20812-4228X(9290024228) 20812-4229X(9290024229)
Applicant's name / address	Signify (China) Investment Co., Ltd Building no.9, Lane 888, Tianlin Road, Minhang District, Shanghai, 200233, China
Test method requested, standard	FCC CFR Title 47 Part 15 Subpart C Section 15.247 ANSI C63.10: 2013 KD558074 D01 15.247 Meas Guidance v05r02 RSS-Gen Issue 5 RSS-247 Issue 2
Verdict Summary	IN COMPLIANCE
Documented by (name / position & signature)	Kitty Li/Project Assistant <i>Kitty Li</i>
Reviewed by (name / position & signature)	Frank He/ Technical Supervisor <i>Frank He</i>
Approved by (name / position & signature)	Jack Zhang/ Supervisor <i>Jack Zhang</i>
Date of issue	2020-07-14
Report template No	Template_FCC 15.247-RF-V1.0

INDEX

	page
General conditions	4
Environmental conditions	4
Possible test case verdicts	5
Abbreviations	5
Document History	6
Remarks and Comments	6
Used Equipment	7
Uncertainty	9
1 General Information	10
1.1 General Description of the Item(s)	10
1.2 Antenna Information	11
1.3 Channel List	12
2 Description of Test Setup	13
2.1 Operating mode(s) used for tests	13
2.2 Test Configuration / Block diagram used for tests	14
2.3 Testing process	15
3 Verdict summary section	16
3.1 Standards	16
3.2 Deviation(s) from the Standard(s) / Test Specification(s)	16
3.3 Overview of results	17
3.4 Test Facility	18
4 Test Results	19
4.1 AC Power Line Conducted Emission	19
4.1.1 Limit	19
4.1.2 Test Setup	19
4.1.3 Test Procedure	19
4.1.4 Test Data	20
4.2 Emissions in restricted frequency bands	22
4.2.1 Limit	22
4.2.2 Test Setup	24
4.2.3 Test Procedure	24
4.2.4 Test Data	25
4.3 Emissions in non-restricted frequency band	33
4.3.1 Limit	33

4.3.2	Test Setup	33
4.3.3	Test Procedure	33
4.3.4	Test Data	34
4.4	Duty cycle	35
4.4.1	Limit	35
4.4.2	Test Setup	35
4.4.3	Test Procedure	35
4.4.4	Test Data	36
4.5	Radiated Emission Band Edge	37
4.5.1	Limit	37
4.5.2	Test Setup	37
4.5.3	Test Procedure	37
4.5.4	Test Data	38
4.6	DTS Bandwidth	46
4.6.1	Limit	46
4.6.2	Test Setup	46
4.6.3	Test Procedure	46
4.6.4	Test Data	47
4.7	Fundamental emission output power	48
4.7.1	Limit	48
4.7.2	Test Setup	48
4.7.3	Test Procedure	49
4.7.4	Test Data	50
4.8	Power Density	51
4.8.1	Limit:	51
4.8.2	Test Setup	51
4.8.3	Test Procedure	51
4.8.4	Test Data	52
4.9	Antenna Requirement	53
4.9.1	Limit:	53
4.9.2	Antenna Connector Construction:	53
5	Test setup photo and EUT Photo	54

COMPETENCES AND GUARANTEES

DEKRA is a testing laboratory competent to carry out the tests described in this report.

In order to assure the traceability to other national and international laboratories, DEKRA has a calibration and maintenance program for its measurement equipment.

DEKRA guarantees the reliability of the data presented in this report, which is the result of the measurements and the tests performed to the item under test on the date and under the conditions stated in the report and it is based on the knowledge and technical facilities available at DEKRA at the time of performance of the test.

DEKRA is liable to the client for the maintenance of the confidentiality of all information related to the item under test and the results of the test.

The results presented in this Test Report apply only to the particular item under test established in this document.

IMPORTANT: No parts of this report may be reproduced or quoted out of context, in any form or by any means, except in full, without the previous written permission of DEKRA.

GENERAL CONDITIONS

Test Location	No. 99, Hongye Road, Suzhou Industrial Park Suzhou, 215006, P.R. China
Date(receive sample)	Jun. 22, 2020
Date (start test)	Jun. 22, 2020
Date (finish test)	Jul. 14, 2020

1. This report is only referred to the item that has undergone the test.
2. This report does not constitute or imply on its own an approval of the product by the Certification Bodies or Competent Authorities.
3. This document is only valid if complete; no partial reproduction can be made without previous written permission of DEKRA.
4. This test report cannot be used partially or in full for publicity and/or promotional purposes without previous written permission of DEKRA.

ENVIRONMENTAL CONDITIONS

The climatic conditions during the tests are within the limits specified by the manufacturer for the operation of the EUT and the test equipment. The climatic conditions during the tests were within the following limits:

Ambient temperature	15 °C – 35 °C
Relative Humidity air	30% - 60%

If explicitly required in the basic standard or applied product / product family standard the climatic values are recorded and documented separately in this test report.

POSSIBLE TEST CASE VERDICTS

Test case does not apply to test object	N/A
Test object does meet requirement	P (Pass) / PASS
Test object does not meet requirement	F (Fail) / FAIL
Not measured	N/M

ABBREVIATIONS

For the purposes of the present document, the following abbreviations apply:

EUT	: Equipment Under Test
QP	: Quasi-Peak
CAV	: CISPR Average
AV	: Average
CDN	: Coupling Decoupling Network
SAC	: Semi-Anechoic Chamber
OATS	: Open Area Test Site
BW	: Bandwidth
AM	: Amplitude Modulation
PM	: Pulse Modulation
HCP	: Horizontal Coupling Plane
VCP	: Vertical Coupling Plane
U_N	: Nominal voltage
T_x	: Transmitter
R_x	: Receiver
N/A	: Not Applicable
N/M	: Not Measured

DOCUMENT HISTORY

Report No.	Version	Description	Issued Date
2060819R-RF-US-P06V01	V1.0	Initial issue of report.	2020-07-14

REMARKS AND COMMENTS

1. The equipment under test (EUT) does meet the essential requirements of the stated standard(s)/test(s).
2. These test results on a sample of the device are for the purpose of demonstrating Compliance with Part 15 Subpart C Paragraph 15.247, RSS-Gen Issue 5, RSS-247 Issue 2.
3. The measurement result is considered in conformance with the requirement if it is within the prescribed limit, It is not necessary to account the uncertainty associated with the measurement result, unless the specification, standard or customer have special requirements.
4. The test results presented in this report relate only to the object tested.
5. The test results relate only to the samples tested.
6. The test report shall not be reproduced without the written approval of DEKRA Testing and Certification (Suzhou) Co., Ltd.
7. This report will not be used for social proof function in China market.

USED EQUIPMENT

AC Power Line Conducted Emission / TR1

Instrument	Manufacturer	Model No.	Serial No.	Cal. Date	Next Cal. Date
EMI Test Receiver	R&S	ESCI	100906	2020.04.20	2021.04.19
Two-Line V-Network	R&S	ENV216	101190	2019.12.28	2020.12.27
Two-Line V-Network	R&S	ENV216	101044	2019.12.28	2020.12.27
Current Probe	R&S	EZ-17	100678	2020.03.12	2021.04.11
50ohm Termination	SHX	TF2	07081402	2019.09.02	2020.09.01
50ohm Termination	SHX	TF2	07081403	2019.09.02	2020.09.01
50ohm Coaxial Switch	Anritsu	MP59B	6200464462	N/A	N/A
Temperature/Humidity Meter	RTS	RTS-8S	TR1-TH	2019.08.21	2020.08.20
Coaxial Cable	Suhner	RG 223	TR1-C1	2019.08.25	2020.08.24
Coaxial Cable	Suhner	RG 223	TR1-C2	2019.08.25	2020.08.24
Dekra test software	Dekra	-	-	-	-

Emissions in non-restricted frequency bands/ Occupied Bandwidth/ Fundamental emission output power Power Spectral Density / TR8

Instrument	Manufacturer	Model No.	Serial No.	Cal. Date	Next Cal. Date
Spectrum Analyzer	Agilent	N9010A	MY48030494	2019.09.28	2020.09.27
EXA Spectrum Analyzer	Keysight	N9010A	MY55370495	2020.04.17	2021.04.16
MXA Signal Analyzer	Keysight	N9020A	MY56060147	2019.08.30	2020.08.29
Wideband Peak Power Meter	Anritsu	ML2495A	0905006	2019.08.12	2020.08.11
Power Sensor	Anritsu	MA2411B	0846014	2019.08.12	2020.08.11
Coaxial Cable	Woken	SFL402	F02-150410-044	2020.01.01	2020.12.31
Dekra test software	Dekra	-	-	-	-

Radiated Emission(30MHz-1GHz) / AC3

Instrument	Manufacturer	Model No.	Serial No.	Cal. Date	Next Cal. Date
EMI Test Receiver	R&S	ESCI	100573	2020.03.03	2021.03.02
Bilog Antenna	Teseq GmbH	CBL6112D	27611	2019.09.23	2020.09.22
Temperature/Humidity Meter	RTS	RTS-8S	AC2-TH	2019.09.02	2020.09.01
Coaxial Cable	Huber+Suhner	RG 214	AC2-C	2020.04.13	2021.04.12
Dekra test software	Dekra	-	-	-	-

Radiated Emission / AC5(1GHz-40GHz)

Instrument	Manufacturer	Model No.	Serial No.	Cal. Date	Next Cal. Date
Spectrum Analyzer	Agilent	E4446A	MY45300103	2020.05.08	2021.05.07
Preamplifier	Miteq	NSP1800-25	1364185	2020.05.06	2021.05.05
Preamplifier	QuieTek	AP-040G	CHM-0906001	2020.05.06	2021.05.05
DRG Horn	ETS-Lindgren	3117	00123988	2020.01.22	2021.01.21
Temperature/Humidity Meter	Zhichen	ZC1-2	AC5-TH	2019.09.02	2020.09.01
Coaxial Cable	Huber+Suhner	SUCOFLEX 106	AC5-C1	2020.04.13	2021.04.12
Coaxial Cable	Huber+Suhner	SUCOFLEX 106	AC5-C2	2020.04.13	2021.04.12
Coaxial Cable	Huber+Suhner	SUCOFLEX 102	AC5-C3	2020.04.13	2021.04.12
Dekra test software	Dekra	-	-	-	-

UNCERTAINTY

Uncertainties have been calculated according to the DEKRA internal document. The reported expanded uncertainties are based on a standard uncertainty multiplied by a coverage factor of $k=2$, providing a level of confidence of approximately 95%. The Uncertainties is comply with standard required as below.

Test item	Uncertainty
AC Power Line Conducted Emission	9kHz~150kHz: 2.80 dB 150kHz~30MHz: 2.40 dB
Peak Power Output	± 1.27 dB
Radiated Emission(30MHz~1GHz)	Horizontal: 30MHz~200MHz: 3.50 dB 300MHz~1GHz: 3.60 dB Vertical: 30MHz~200MHz: 3.60 dB 300MHz~1GHz: 3.50 dB
Radiated Emission(1GHz~26.5GHz)	Horizontal: 1GHz~18GHz: 5.00 dB Vertical: 1GHz~18GHz: 4.80 dB
RF antenna conducted test	± 1.27 dB
Radiated Emission Band Edge	± 3.9 dB
DTS Bandwidth	± 150 Hz
Occupied Bandwidth	± 1 kHz
Power Density	± 1.27 dB

1 GENERAL INFORMATION

1.1 General Description of the Item(s)

Product Name	LED Device
Model No.	9290024227, 9290024228, 9290024229
FCC ID	2AGBW9290024227X(9290024227) 2AGBW9290024228X(9290024228) 2AGBW9290024229X(9290024229)
IC	20812-4227X(9290024227) 20812-4228X(9290024228) 20812-4229X(9290024229)
Manufacturer	Signify (China) Investment Co., Ltd
Manufacturer Address	Building no.9, Lane 888, Tianlin Road, Minhang District, Shanghai, 200233, China

Wireless specification.....	Zigbee
Operating frequency range(s)	2400~2483.5MHz
Type of Modulation.....	DSSS-OQPSK
Number of channel.....	16
Date Rate	250kbps

Rated power supply	Voltage and Frequency	
	<input type="checkbox"/>	AC: 220 – 240 V, 50/60 Hz
	<input checked="" type="checkbox"/>	AC: 100 – 240 V, 50/60 Hz
	<input type="checkbox"/>	DC: 3.2~4.2 Vdc
	<input type="checkbox"/>	Battery:
Mounting position	<input type="checkbox"/>	Table top equipment
	<input checked="" type="checkbox"/>	Wall/Ceiling mounted equipment
	<input type="checkbox"/>	Floor standing equipment
	<input type="checkbox"/>	Head-mounted equipment
	<input type="checkbox"/>	Other: RF module

Note: Models 9290024227, 9290024228, 9290024229 only differs on the length of the light strip, three models has been pretested and DEKRA has found that model 9290024227 is the worst case. Test results for Model 9290024227, included in this report, are valid and representative for the three models 9290024227, 9290024228, 9290024229.

1.2 Antenna Information

Antenna model / type number	N/A		
Antenna serial number	N/A		
Antenna Delivery	<input checked="" type="checkbox"/>	1TX + 1RX	
	<input type="checkbox"/>	2TX + 2RX	
Antenna technology	<input checked="" type="checkbox"/>	SISO	
	<input type="checkbox"/>	MIMO	<input type="checkbox"/> CDD <input type="checkbox"/> Beam-forming
Antenna Type	<input type="checkbox"/>	External	<input type="checkbox"/> Dipole
			<input type="checkbox"/> Sectorized
	<input checked="" type="checkbox"/>	Internal	<input checked="" type="checkbox"/> PIFA
			<input type="checkbox"/> PCB
			<input type="checkbox"/> Metal Monopole Antenna
		<input type="checkbox"/> Others.....	
Antenna Gain	2.08 dBi		

1.3 Channel List

Working Frequency of Each Channel: For Zigbee							
Channel	Frequency	Channel	Frequency	Channel	Frequency	Channel	Frequency
11	2405 MHz	12	2410 MHz	13	2415 MHz	14	2420 MHz
15	2425 MHz	16	2430 MHz	17	2435 MHz	18	2440 MHz
19	2445 MHz	20	2450 MHz	21	2455 MHz	22	2460 MHz
23	2465 MHz	24	2470 MHz	25	2475 MHz	26	2480 MHz

2 DESCRIPTION OF TEST SETUP

2.1 Operating mode(s) used for tests

During the tests the following operating mode(s) has(have) been used.

Test Mode For Bluetooth	Mode1: Transmit by Zigbee
-------------------------	---------------------------

2.2 Test Configuration / Block diagram used for tests

Test setup Diagram- AC Line Conducted Emission Test

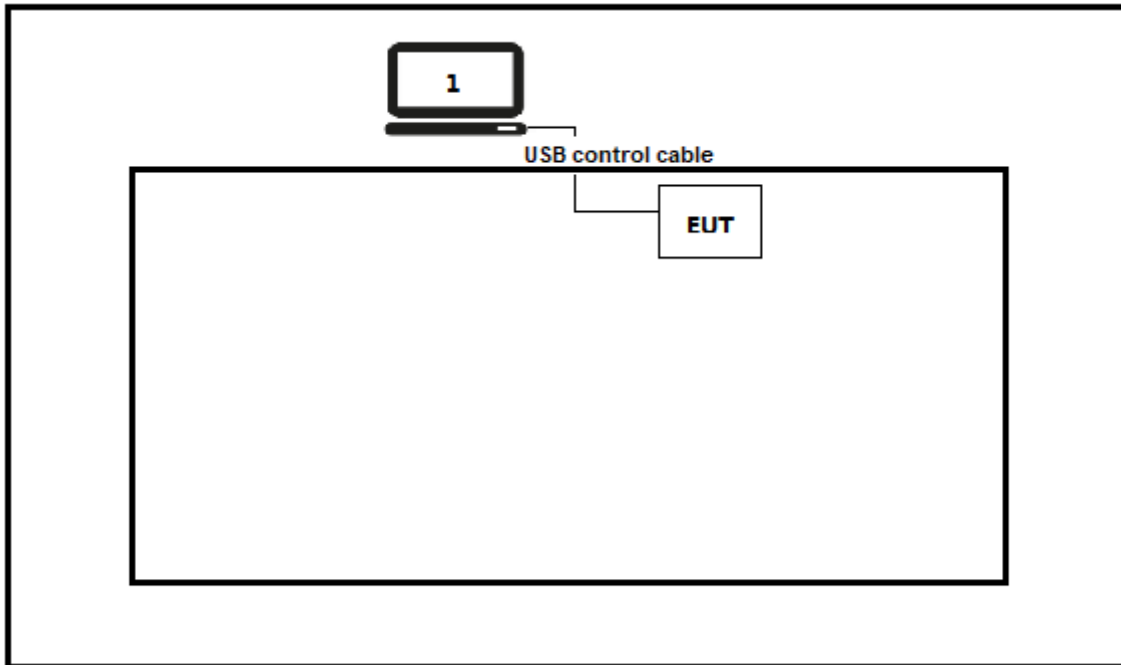

Test setup Diagram- Radiated Emission

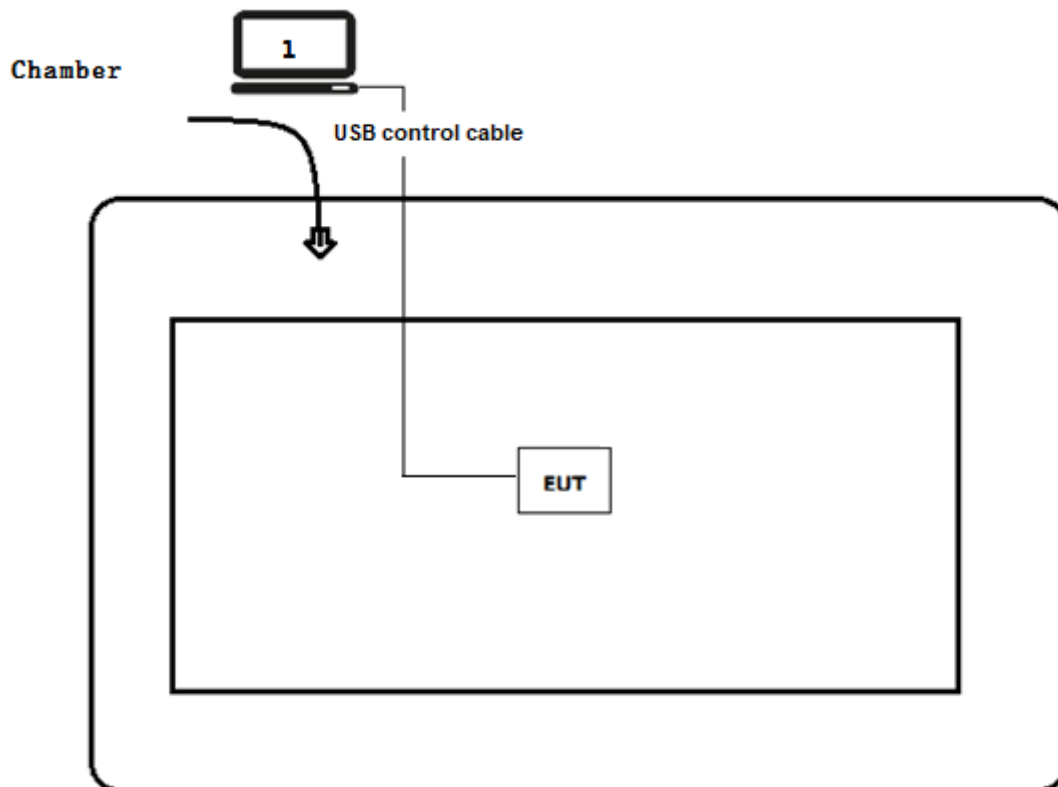

2.3 Testing process

1	Setup the EUT as shown in Section 2.2.
2	Execute Switch channel by repeating power on.
3	Configure the test mode, the test channel, and the data rate.
4	Verify that the EUT works properly.

3 VERDICT SUMMARY SECTION

This chapter presents an overview of standards and results. Refer to the next chapters for details of measured test results and applied test levels.

3.1 Standards

Standard	Year	Description
FCC CFR Title 47 Part 15 Subpart C Section 15.247	2019	Operation within the bands 902–928 MHz, 2400–2483.5 MHz, and 5725–5850 MHz.
ANSI C63.10	2013	American National Standard of Procedures for Compliance Testing of Unlicensed Wireless Devices
KDB 558074 D01 v05r02	2019	Guidance for performing compliance measurements on Digital Transmission System (DTS) operating under section 15.247
RSS-Gen Issue 5 Amendment 1	2019	General Requirements for Compliance of Radio Apparatus
RSS-247 Issue 2	2017	Digital Transmission Systems (DTSs), Frequency Hopping Systems (FHSs) and Licence-Exempt Local Area Network (LE-LAN) Devices

3.2 Deviation(s) from the Standard(s) / Test Specification(s)

The following deviation(s) was / were made from the published requirements of the listed standards: N/A.

(Please define the deviations from the standard(s) if applicable)

3.3 Overview of results

For FCC

Requirement – Test case	Basic standard(s)	Verdict	Remark
AC Power Line Conducted Emission	FCC 15.207	PASS	---
Emissions in restricted frequency bands	FCC 15.247(b)(3)	PASS	---
Duty cycle	ANSI C63.10:2013	PASS	---
Emissions in non-restricted frequency bands	FCC 15.247(d), FCC 15.209	PASS	---
Radiated Emission Band Edge	FCC 15.247(d)	PASS	---
Fundamental emission output power	FCC 15.247(d), FCC 15.209	PASS	---
DTS Bandwidth	FCC 15.247(a)(2)	PASS	---
Power Spectral Density	FCC 15.247(e)	PASS	---
Antenna Requirement	FCC 15.203	PASS	---

For ISED

Requirement – Test case	Basic standard(s)	Verdict	Remark
AC Power Line Conducted Emission	RSS-Gen Issue 5 Section 8.8	PASS	---
Emissions in restricted frequency bands	RSS-Gen Issue 5 Section 8.9	PASS	---
Duty cycle	ANSI C63.10:2013	PASS	---
Emissions in non-restricted frequency bands	RSS-247 Issue 2 Section 5.5	PASS	---
Radiated Emission Band Edge	RSS-Gen Issue 5 Section 8.10	PASS	---
Fundamental emission output power	RSS-247 Issue 2 Section 5.4(d)	PASS	---
DTS Bandwidth	RSS-Gen Issue 5 Section 6.7	PASS	---
Power Spectral Density	RSS-247 Issue 2 Section 5.2(b)	PASS	---
Antenna Requirement	RSS-Gen Issue 5 Section 6.8	PASS	---

3.4 Test Facility

USA	:	FCC Designation Number: CN1199
------------	----------	---------------------------------------

CA	:	ISED CAB identifier: CN0040
-----------	----------	------------------------------------

4 TEST RESULTS

4.1 AC Power Line Conducted Emission

VERDICT: PASS

4.1.1 Limit

Standard		
FCC Part 15 Subpart C Paragraph 15.207		
Frequency range [MHz]	Limit: QP [dB(μV) ¹⁾	Limit: AV [dB(μV) ¹⁾
0,15 - 0,50	66 - 56 ²⁾	56 - 46 ²⁾
0,50 - 5,0	56	46
5,0 - 30	60	50

¹⁾ At the transition frequency, the lower limit applies.

²⁾ The limit decreases linearly with the logarithm of the frequency.

NOTE 1: The exclusion band for transmitters shall be considered for transmitters operating at frequencies below 30 MHz.

NOTE 2: Where the AC output port is directly connected (or via a circuit breaker) to the AC power input port of the EUT the AC power output port need not to be tested.

4.1.2 Test Setup

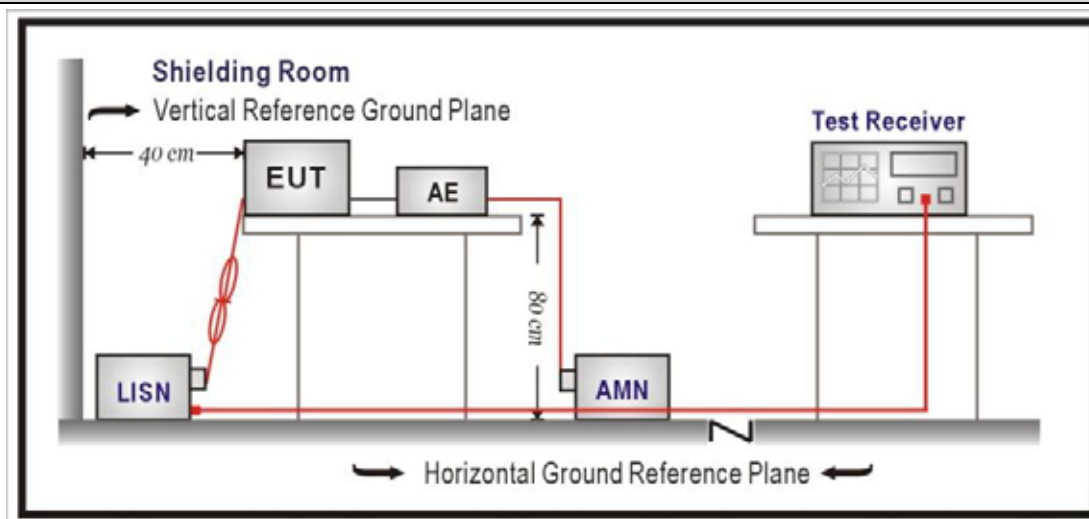

4.1.3 Test Procedure

References Rule	Chapter	Item
<input checked="" type="checkbox"/> ANSI C63.10-2013	6.2	Standard test method for ac power-line conducted emissions from unlicensed wireless devices

4.1.4 Test Data

Engineer: Canon	
Site: TR1	Time: 2020/05/11
Limit: FCC_Part15.207_CE_AC Power_ClassB	Margin: 0
Probe: ENV216_101190(0.009-30MHz)	Polarity: Line
EUT: LED Device	Power: AC 120V/60Hz
Note: Mode 1	

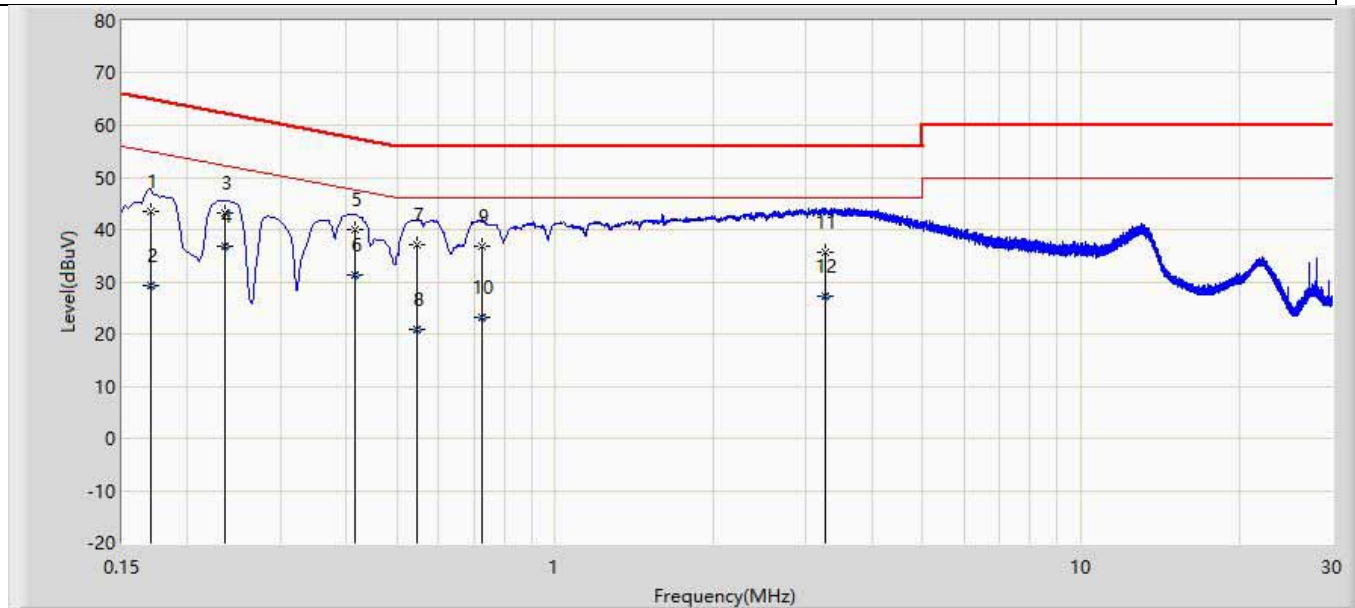

No	Mark	Frequency (MHz)	Measure Level (dBuV)	Reading Level (dBuV)	Over Limit (dB)	Limit (dBuV)	Probe (dB)	Cable (dB)	Amp (dB)	Type
1		0.170	43.593	33.986	-21.374	64.967	9.578	0.028	0.000	QP
2		0.170	29.196	19.589	-25.771	54.967	9.578	0.028	0.000	AV
3		0.235	43.229	33.608	-19.024	62.253	9.592	0.030	0.000	QP
4	*	0.235	36.820	27.198	-15.434	52.253	9.592	0.030	0.000	AV
5		0.415	39.916	30.273	-17.622	57.538	9.604	0.039	0.000	QP
6		0.415	31.352	21.709	-16.186	47.538	9.604	0.039	0.000	AV
7		0.546	37.205	27.548	-18.795	56.000	9.612	0.044	0.000	QP
8		0.546	20.760	11.104	-25.240	46.000	9.612	0.044	0.000	AV
9		0.724	36.735	27.064	-19.265	56.000	9.621	0.050	0.000	QP
10		0.724	23.133	13.462	-22.867	46.000	9.621	0.050	0.000	AV
11		3.273	35.599	25.815	-20.401	56.000	9.670	0.114	0.000	QP
12		3.273	27.204	17.420	-18.796	46.000	9.670	0.114	0.000	AV

Note:

1. " * ", means this data is the worst emission level.
2. Measurement Level = Reading Level + Factor(Probe+Cable-Amp).

Engineer: Canon	
Site: TR1	Time: 2020/05/11
Limit: FCC_Part15.207_CE_AC Power_ClassB	Margin: 0
Probe: ENV216_101190(0.009-30MHz)	Polarity: Neutral
EUT: LED Device	Power: AC 120V/60Hz
Note: Mode 1	

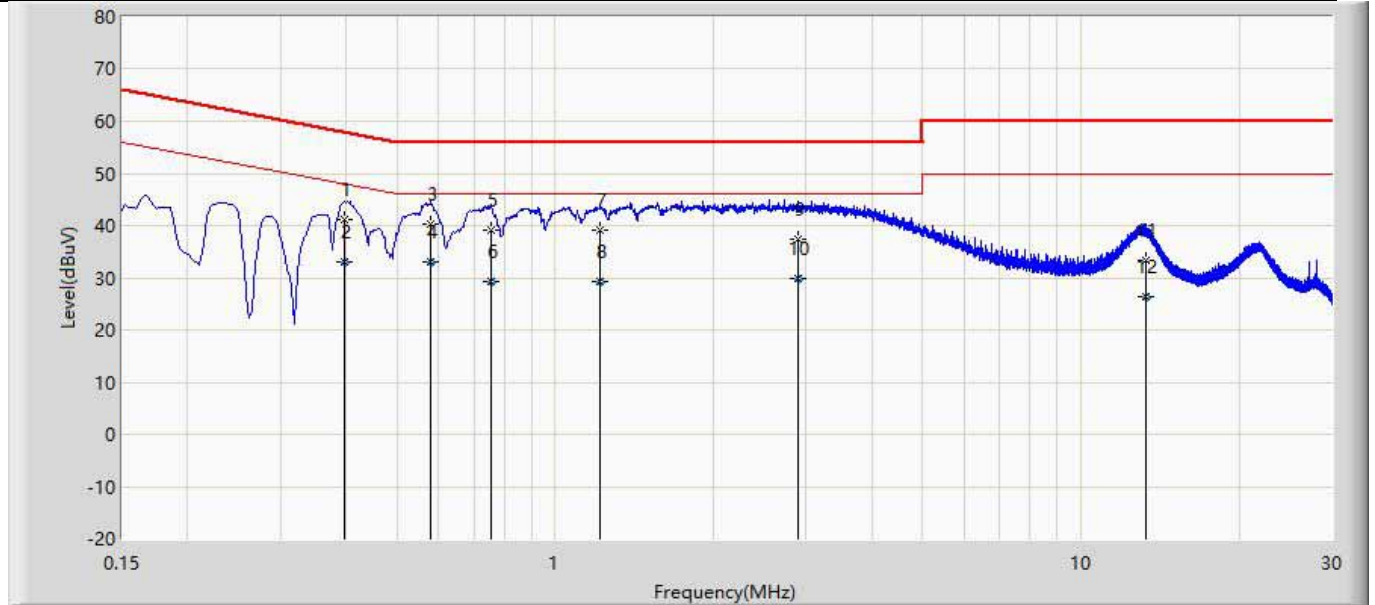

No	Mark	Frequency (MHz)	Measure Level (dBuV)	Reading Level (dBuV)	Over Limit (dB)	Limit (dBuV)	Probe (dB)	Cable (dB)	Amp (dB)	Type
1		0.398	41.029	31.388	-16.877	57.905	9.603	0.038	0.000	QP
2		0.398	33.048	23.407	-14.858	47.905	9.603	0.038	0.000	AV
3		0.580	40.296	30.636	-15.704	56.000	9.614	0.045	0.000	QP
4	*	0.580	32.922	23.262	-13.078	46.000	9.614	0.045	0.000	AV
5		0.753	39.009	29.336	-16.991	56.000	9.622	0.051	0.000	QP
6		0.753	29.363	19.690	-16.637	46.000	9.622	0.051	0.000	AV
7		1.216	39.137	29.441	-16.863	56.000	9.630	0.066	0.000	QP
8		1.216	29.224	19.528	-16.776	46.000	9.630	0.066	0.000	AV
9		2.897	37.476	27.716	-18.524	56.000	9.654	0.106	0.000	QP
10		2.897	29.949	20.189	-16.051	46.000	9.654	0.106	0.000	AV
11		13.326	33.252	23.101	-26.748	60.000	9.917	0.234	0.000	QP
12		13.326	26.281	16.130	-23.719	50.000	9.917	0.234	0.000	AV

Note:

1. " * ", means this data is the worst emission level.
2. Measurement Level = Reading Level + Factor(Probe+Cable-Amp).

4.2 Emissions in restricted frequency bands	VERDICT: PASS
--	----------------------

4.2.1 Limit			
Standard		FCC Part 15 Subpart C Paragraph 15.209	
Restricted Bands of operation			
Frequency (MHz)	Frequency (MHz)	Frequency (MHz)	Frequency (GHz)
0.090 – 0.110	16.42 – 16.423	399.9 – 410	4.5 – 5.15
0.495 – 0.505	16.69475 – 16.69525	608 – 614	5.35 – 5.46
2.1735 – 2.1905	16.80425 – 16.80475	960 – 1240	7.25 – 7.75
4.125 – 4.128	25.5 – 25.67	1300 – 1427	8.025 – 8.5
4.17725 – 4.17775	37.5 – 38.25	1435 – 1626.5	9.0 – 9.2
4.20725 – 4.20775	73 – 74.6	1645.5 – 1646.5	9.3 – 9.5
6.215 – 6.218	74.8 – 75.2	1660 – 1710	10.6 – 12.7
6.26775 – 6.26825	108 – 121.94	1718.8 – 1722.2	13.25 – 13.4
6.31175 – 6.31225	123 – 138	2200 – 2300	14.47 – 14.5
8.291 – 8.294	149.9 – 150.05	2310 – 2390	15.35 – 16.2
8.362 – 8.366	156.52475 – 156.52525	2483.5 – 2500	17.7 – 21.4
8.37625 – 8.38675	156.7 – 156.9	2690 – 2900	22.01 – 23.12
8.81425 – 8.81475	162.0125 – 167.17	3260 – 3267	23.6 – 24.0
12.29 – 12.293	167.72 – 173.2	3332 – 3339	31.2 – 31.8
12.51975 – 12.52025	240 – 285	3345.8 – 3358	36.43 – 36.5
12.57675 – 12.57725	322 – 335.4	3600 – 4400	
13.36 – 13.41			
Restricted Bands of operation for IC			
0.090 - 0.110	13.36 - 13.41	960 - 1427	9.0 - 9.2
0.495 - 0.505	16.42 - 16.423	1435 - 1626.5	9.3 - 9.5
2.1735 - 2.1905	16.69475 - 16.69525	1645.5 - 1646.5	10.6 - 12.7
3.020 - 3.026	16.80425 - 16.80475	1660 - 1710	13.25 - 13.4
4.125 - 4.128	25.5 - 25.67	1718.8 - 1722.2	14.47 - 14.5
4.17725 - 4.17775	37.5 - 38.25	2200 - 2300	15.35 - 16.2
4.20725 - 4.20775	73 - 74.6	2310 - 2390	17.7 - 21.4
5.677 - 5.683	74.8 - 75.2	2483.5 - 2500	22.01 - 23.12
6.215 - 6.218	108 - 138	2655 - 2900	23.6 - 24.0
6.26775 - 6.26825	149.9 - 150.05	3260 - 3267	31.2 - 31.8
6.31175 - 6.31225	156.52475 - 156.52525	3332 - 3339	36.43 - 36.5
8.291 - 8.294	156.7 - 156.9	3345.8 - 3358	Above 38.6
8.362 - 8.366	162.0125 - 167.17	3500 - 4400	
8.37625 - 8.38675	167.72 - 173.2	4500 - 5150	
8.41425 - 8.41475	240 - 285	5350 - 5460	
12.29 - 12.293	322 - 335.4	7250 - 7750	
12.51975 - 12.52025	399.9 - 410	8025 - 8500	
12.57675 - 12.57725	608 - 614	--	

Restricted Band Emissions Limit

Frequency (MHz)	Field strength (μ V/m)	Field strength (dB μ V/m)	Measurement distance (m)
0.009 - 0.49	2400/F(kHz)	48.5 – 13.8	300 _(Note 1)
0.49 - 1.705	24000/F(kHz)	33.8 - 23	30 _(Note 1)
1.705 - 30	30	29.5	30 _(Note 1)
30 - 88	100	40	3 _(Note 2)
88 - 216	150	43.5	3 _(Note 2)
216 - 960	200	46	3 _(Note 2)
Above 960	500	54	3 _(Note 2)

Note 1: At frequencies below 30 MHz, measurements may be performed at a distance closer than that specified in the regulations; however, an attempt should be made to avoid making measurements in the near field. Pending the development of an appropriate measurement procedure for measurements performed below 30 MHz, when performing measurements at a closer distance than specified, the results shall be extrapolated to the specified distance by either making measurements at a minimum of two distances on at least one radial to determine the proper extrapolation factor or by using the square of an inverse linear distance extrapolation factor (40 dB/decade).

Note 2: At frequencies at or above 30 MHz, measurements may be performed at a distance other than what is specified provided: measurements are not made in the near field except where it can be shown that near field measurements are appropriate due to the characteristics of the device; and it can be demonstrated that the signal levels needed to be measured at the distance employed can be detected by the measurement equipment.

Measurements shall not be performed at a distance greater than 30 meters unless it can be further demonstrated that measurements at a distance of 30 meters or less are impractical. When performing measurements at a distance other than that specified, the results shall be extrapolated to the specified distance using an extrapolation factor of 20 dB/decade (inverse linear-distance for field strength measurements; inverse-linear-distance-squared for power density measurements).

4.2.2 Test Setup

30MHz-1GHz Test Setup:

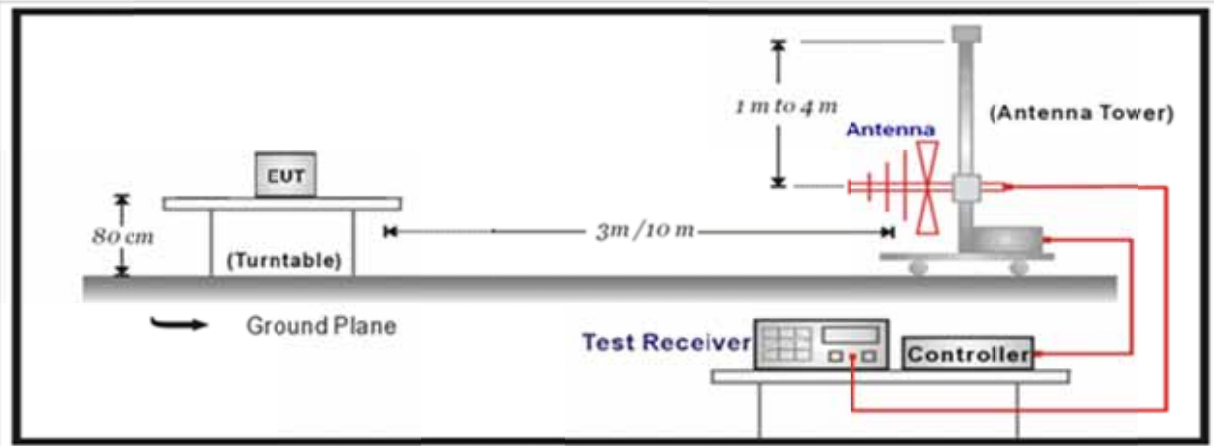

Above 1GHz Test Setup:

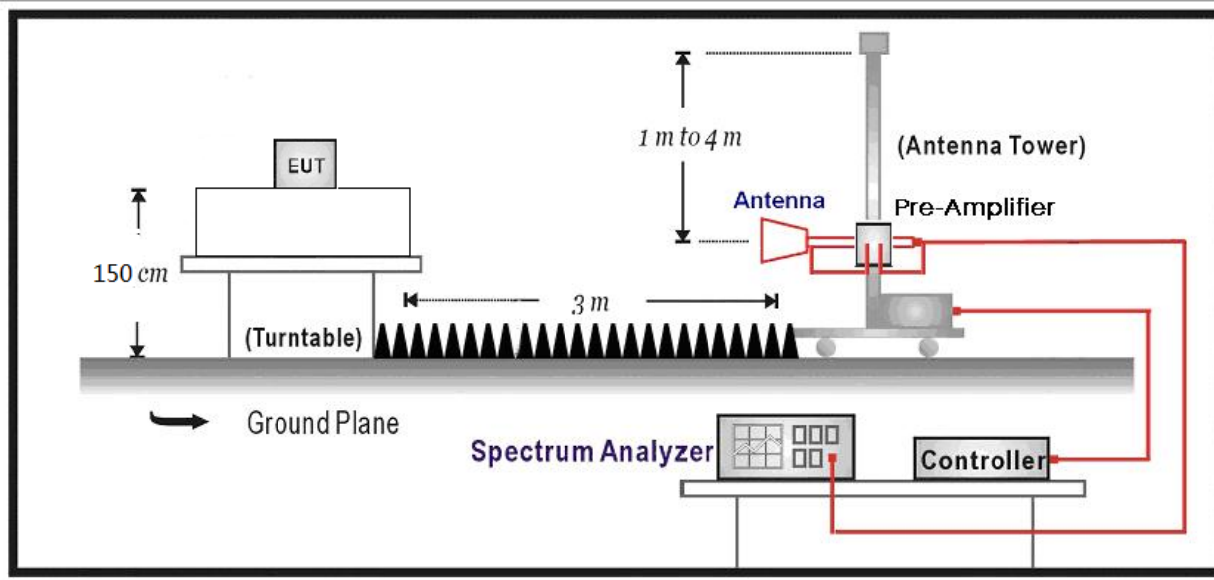

4.2.3 Test Procedure

References Rule	Chapter	Description
<input checked="" type="checkbox"/> ANSI C63.10	11.12	Emissions in restricted frequency bands
<input checked="" type="checkbox"/> ANSI C63.10	11.12.1	Radiated emission measurements
<input checked="" type="checkbox"/> ANSI C63.10	11.12.2.7	Radiated spurious emission test
<input checked="" type="checkbox"/> ANSI C63.10	6.4	Radiated emissions from unlicensed wireless devices below 30 MHz
<input checked="" type="checkbox"/> ANSI C63.10	6.5	Radiated emissions from unlicensed wireless devices in the frequency range of 30 MHz to 1000 MHz
<input checked="" type="checkbox"/> ANSI C63.10	6.6	Radiated emissions from unlicensed wireless devices above 1 GHz

4.2.4 Test Data

Profile: 2060819R	Page No.: 213
Engineer: Yingfeiwang	
Site: AC5	Time: 2020/06/24 - 02:20
Limit: FCC_Part15.209_RE(3m)	Margin: 0
Probe: Horn_3117_00167055(1-18GHz)	Polarity: Horizontal
EUT: LED Device	Power: AC 120V/60Hz
Note: Mode 1: Transmit at 2405MHz by Zigbee	

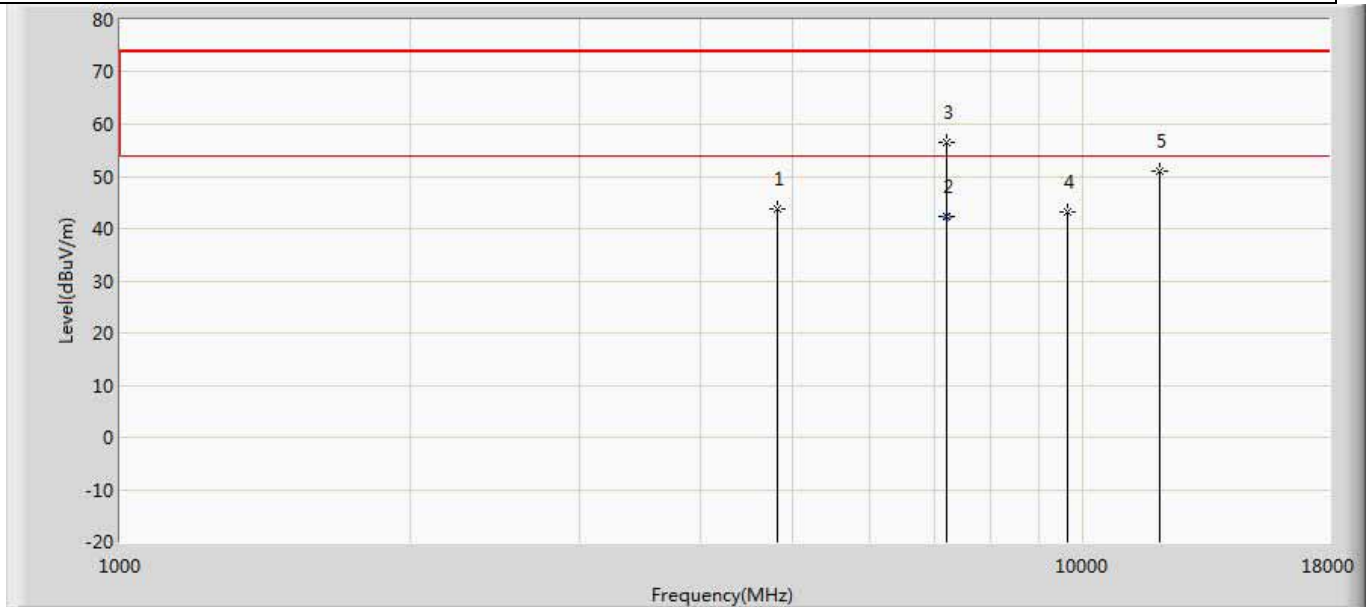

No	Mark	Frequency (MHz)	Measure Level (dBuV/m)	Reading Level (dBuV)	Over Limit (dB)	Limit (dBuV/m)	Factor (dB)	Type
1		4808.000	43.625	39.946	-30.375	74.000	3.678	PK
2	*	7213.320	42.277	35.602	-11.723	54.000	6.675	AV
3		7213.500	56.509	49.834	-17.491	74.000	6.676	PK
4		9620.000	43.076	34.667	-30.924	74.000	8.409	PK
5		12024.500	51.148	38.250	-22.852	74.000	12.898	PK

Profile: 2060819R	Page No.: 214
Engineer: Yingfeiwang	
Site: AC5	Time: 2020/06/24 - 01:20
Limit: FCC_Part15.209_RE(3m)	Margin: 0
Probe: Horn_3117_00167055(1-18GHz)	Polarity: Vertical
EUT: LED Device	Power: AC 120V/60Hz
Note: Mode 1:Transmit at 2405MHz by Zigbee	

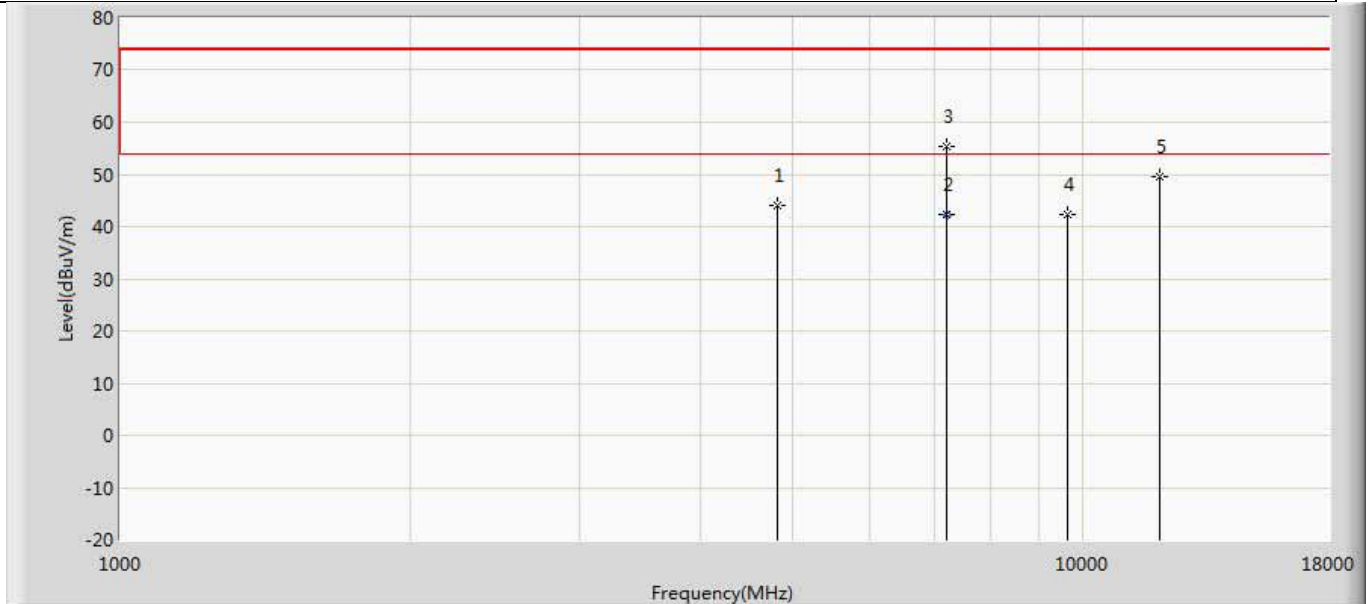

No	Mark	Frequency (MHz)	Measure Level (dBuV/m)	Reading Level (dBuV)	Over Limit (dB)	Limit (dBuV/m)	Factor (dB)	Type
1		4808.000	43.961	40.282	-30.039	74.000	3.678	PK
2	*	7213.320	42.277	35.602	-11.723	54.000	6.675	AV
3		7213.500	55.354	48.679	-18.646	74.000	6.676	PK
4		9620.000	42.191	33.782	-31.809	74.000	8.409	PK
5		12024.500	49.537	36.639	-24.463	74.000	12.898	PK

Profile: 2060819R	Page No.: 215
Engineer: Yingfeiwang	
Site: AC5	Time: 2020/06/24 - 01:21
Limit: FCC_Part15.209_RE(3m)	Margin: 0
Probe: Horn_3117_00167055(1-18GHz)	Polarity: Horizontal
EUT: LED Device	Power: AC 120V/60Hz
Note: Mode 1:Transmit at 2440MHz by Zigbee	

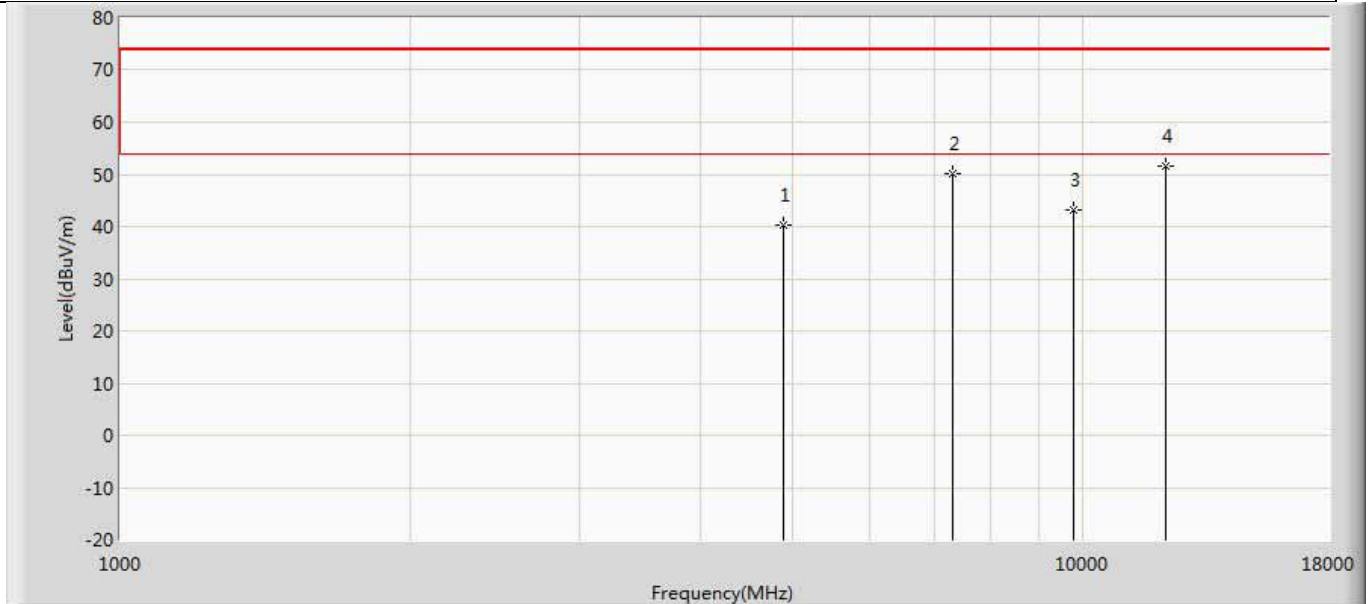

No	Mark	Frequency (MHz)	Measure Level (dBuV/m)	Reading Level (dBuV)	Over Limit (dB)	Limit (dBuV/m)	Factor (dB)	Type
1		4880.000	40.230	36.589	-33.770	74.000	3.640	PK
2		7315.500	50.058	43.401	-23.942	74.000	6.658	PK
3		9760.000	43.205	34.501	-30.795	74.000	8.704	PK
4	*	12194.500	51.645	38.357	-22.355	74.000	13.288	PK

Profile: 2060819R	Page No.: 216
Engineer: Yingfeiwang	
Site: AC5	Time: 2020/06/24 - 01:21
Limit: FCC_Part15.209_RE(3m)	Margin: 0
Probe: Horn_3117_00167055(1-18GHz)	Polarity: Vertical
EUT: LED Device	Power: AC 120V/60Hz
Note: Mode 1:Transmit at 2440MHz by Zigbee	

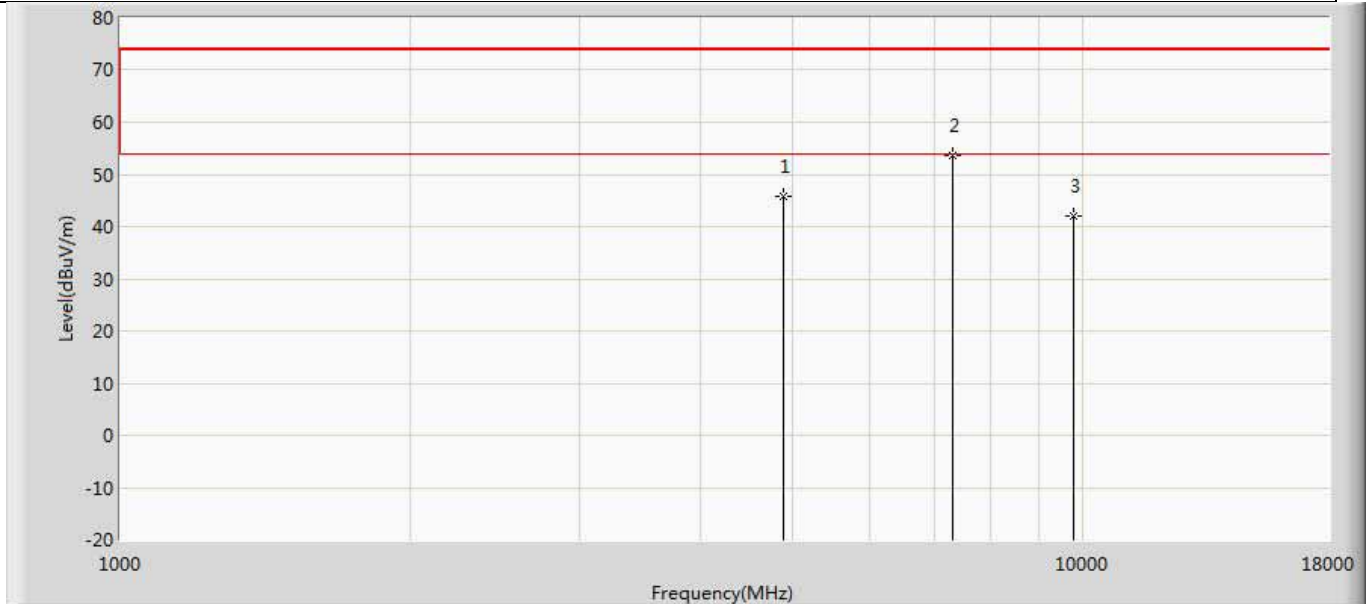

No	Mark	Frequency (MHz)	Measure Level (dBuV/m)	Reading Level (dBuV)	Over Limit (dB)	Limit (dBuV/m)	Factor (dB)	Type
1		4884.500	45.844	42.253	-28.156	74.000	3.591	PK
2	*	7315.500	53.747	47.090	-20.253	74.000	6.658	PK
3		9760.000	42.145	33.441	-31.855	74.000	8.704	PK

Profile: 2060819R	Page No.: 217
Engineer: Yingfeiwang	
Site: AC5	Time: 2020/06/24 - 01:21
Limit: FCC_Part15.209_RE(3m)	Margin: 0
Probe: Horn_3117_00167055(1-18GHz)	Polarity: Horizontal
EUT: LED Device	Power: AC 120V/60Hz
Note: Mode 1:Transmit at 2480MHz by Zigbee	

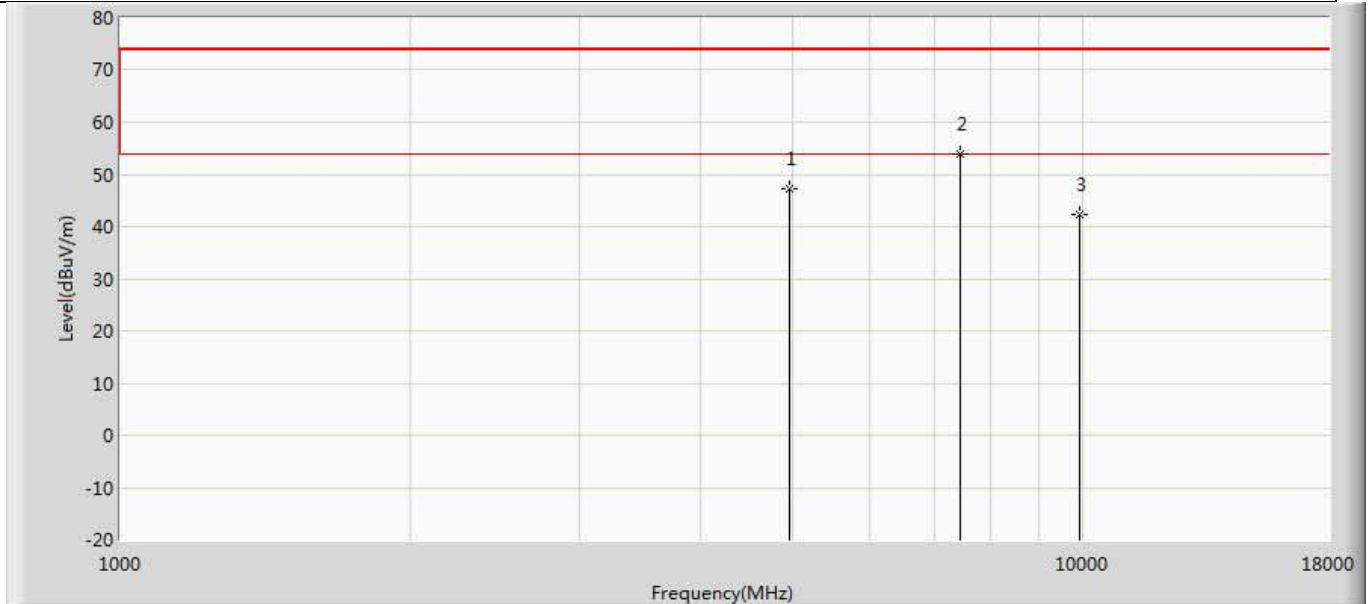

No	Mark	Frequency (MHz)	Measure Level (dBuV/m)	Reading Level (dBuV)	Over Limit (dB)	Limit (dBuV/m)	Factor (dB)	Type
1		4961.000	47.170	43.559	-26.830	74.000	3.611	PK
2	*	7443.000	53.974	47.372	-20.026	74.000	6.601	PK
3		9920.000	42.305	33.580	-31.695	74.000	8.725	PK

Profile: 2060819R	Page No.: 218
Engineer: Yingfeiwang	
Site: AC5	Time: 2020/06/24 - 01:21
Limit: FCC_Part15.209_RE(3m)	Margin: 0
Probe: Horn_3117_00167055(1-18GHz)	Polarity: Vertical
EUT: LED Device	Power: AC 120V/60Hz
Note: Mode 1:Transmit at 2480MHz by Zigbee	

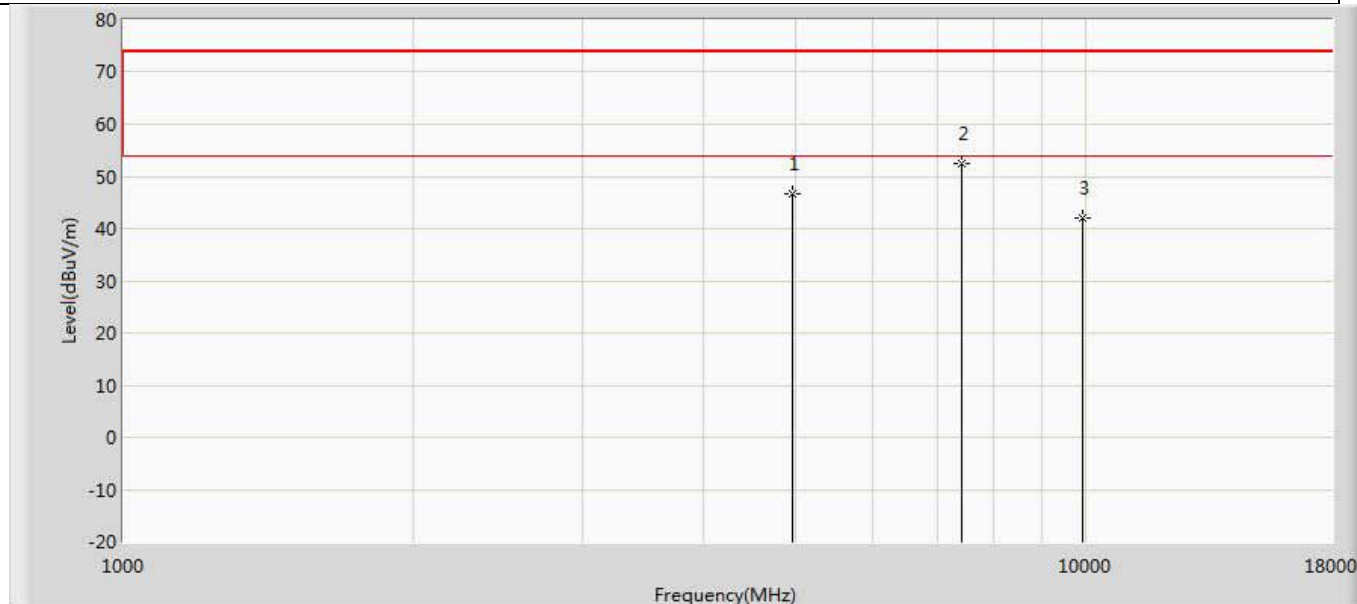

No	Mark	Frequency (MHz)	Measure Level (dBuV/m)	Reading Level (dBuV)	Over Limit (dB)	Limit (dBuV/m)	Factor (dB)	Type
1		4961.000	46.762	43.151	-27.238	74.000	3.611	PK
2	*	7434.500	52.594	46.039	-21.406	74.000	6.555	PK
3		9920.000	41.972	33.247	-32.028	74.000	8.725	PK

Note:

1. Measured Level = Reading Level + Factor.
2. The test frequency range, 9kHz~30MHz, 18GHz~26GHz, both of the worst case are at least 20dB below the limits, therefore no data appear in the report.
3. This limit applies for using average detector, if the test result on peak is lower than average limit, then average measurement needn't be performed.
4. As the radiated emission was performed, so conducted emission was not tested.

The worst case of Radiated Emission below 1GHz:

Profile: 2060819R	Page No.: 1
Engineer: Shuo	
Site: AC3	Time: 2020/05/12 - 14:24
Limit: FCC_Part15.209_RE(3m)_ClassB	Margin: 0
Probe: SuZ-2141	Polarity: Horizontal
EUT: LED Device	Power: AC 120V/60Hz
Note: Mode 1	

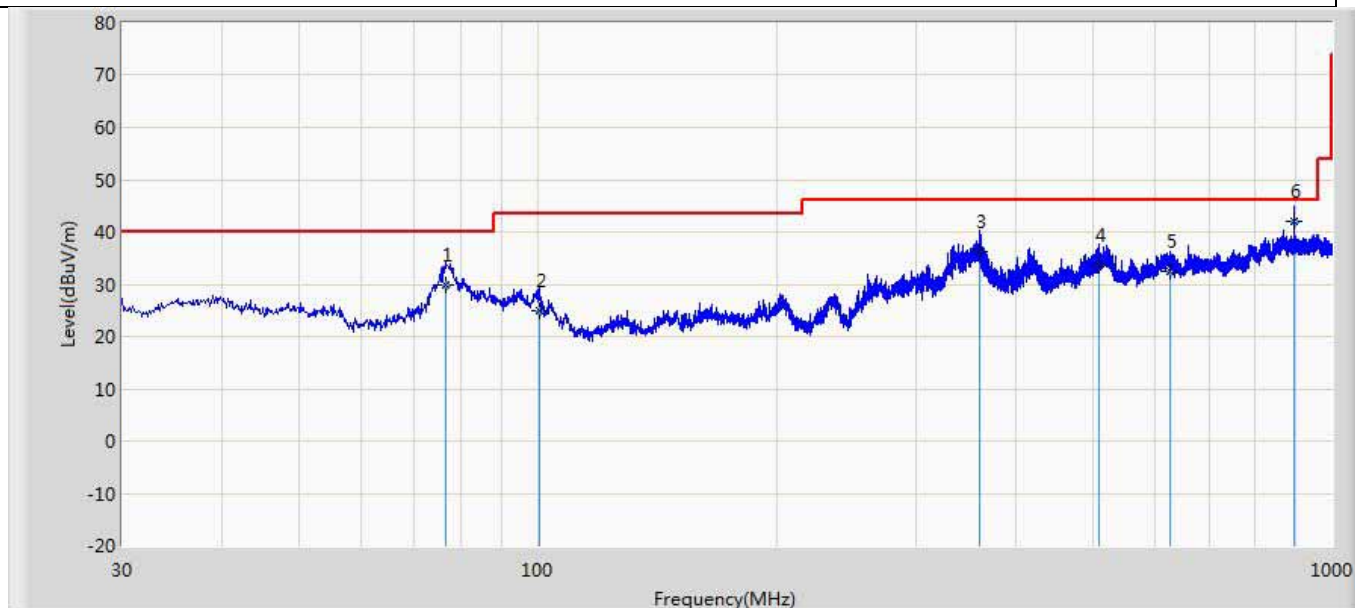

No	Mark	Frequency (MHz)	Measure Level (dBuV/m)	Reading Level (dBuV)	Over Limit (dB)	Limit (dBuV/m)	Probe (dB/m)	Cable (dB)	Amp (dB)	Ant Pos (cm)	Table Pos (deg)	Type
1		76.560	29.855	16.200	-10.145	40.000	7.010	6.645	0.000	100	188	QP
2		100.689	25.045	11.400	-18.455	43.500	6.865	6.780	0.000	100	239	QP
3		360.000	36.297	11.300	-9.703	46.000	17.244	7.753	0.000	0	0	QP
4		508.570	33.521	5.300	-12.479	46.000	20.025	8.196	0.000	0	0	QP
5		624.489	32.328	1.300	-13.672	46.000	22.526	8.503	0.000	0	0	QP
6	*	895.230	41.931	8.200	-4.069	46.000	24.572	9.159	0.000	0	0	QP

Note:

1. All Readings below 1GHz are Quasi-Peak, above are performed with peak and/or average measurements as necessary.
2. " * ", means this data is the worst emission level.
3. Measurement Level = Reading Level + Factor(Probe+Cable-Amp).

Profile: 2060819R	Page No.: 2
Engineer: Shuo	
Site: AC3	Time: 2020/05/12 - 14:27
Limit: FCC_Part15.109_RE(3m)_ClassB	Margin: 0
Probe: SuZ-2141	Polarity: Vertical
EUT: LED Device	Power: AC 120V/60Hz
Note: Mode 1	

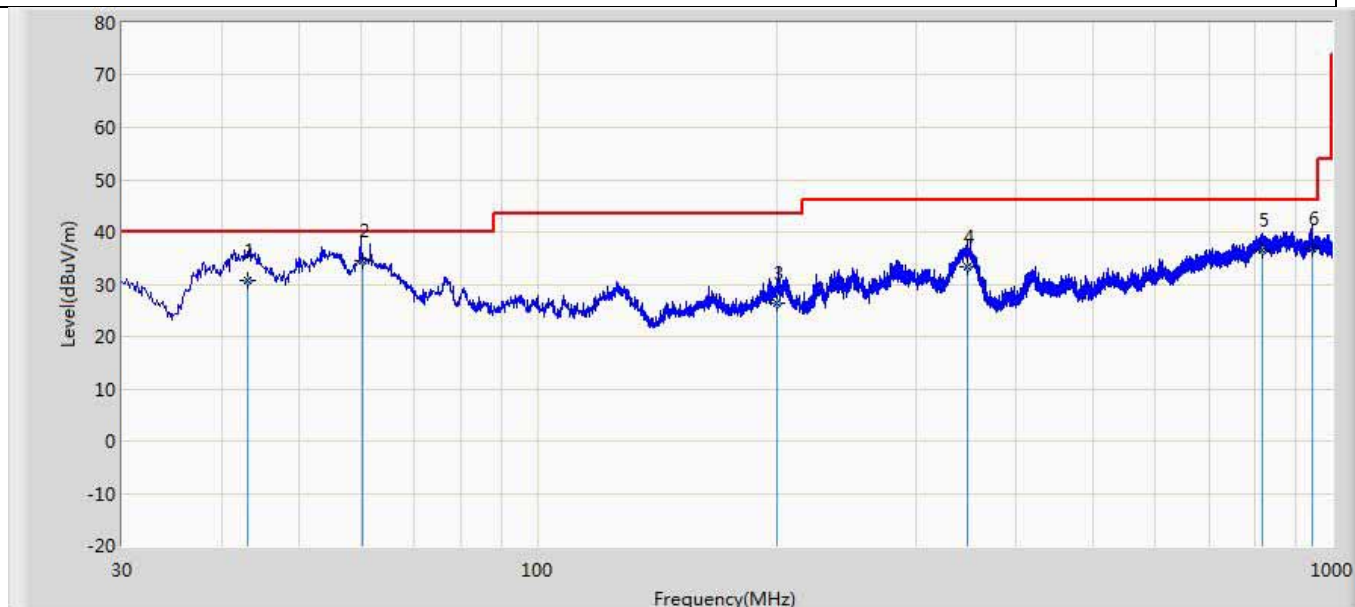

No	Mark	Frequency (MHz)	Measure Level (dBuV/m)	Reading Level (dBuV)	Over Limit (dB)	Limit (dBuV/m)	Probe (dB/m)	Cable (dB)	Amp (dB)	Ant Pos (cm)	Table Pos (deg)	Type
1		43.203	30.845	10.300	-9.155	40.000	14.101	6.443	0.000	100	63	QP
2	*	60.213	34.494	10.200	-5.506	40.000	17.738	6.556	0.000	100	52	QP
3		200.131	26.456	2.600	-17.044	43.500	16.654	7.202	0.000	100	51	QP
4		347.531	33.405	8.600	-12.595	46.000	17.092	7.713	0.000	100	52	QP
5		817.230	36.660	1.300	-9.340	46.000	26.374	8.986	0.000	100	52	QP
6		946.230	36.726	2.300	-9.274	46.000	25.145	9.280	0.000	100	210	QP

Note:

1. All Readings below 1GHz are Quasi-Peak, above are performed with peak and/or average measurements as necessary.
2. " * ", means this data is the worst emission level.
3. Measurement Level = Reading Level + Factor(Probe+Cable-Amp).

4.3 Emissions in non-restricted frequency band	VERDICT: PASS
---	----------------------

4.3.1 Limit	
Standard	FCC Part 15 Subpart C Paragraph 15.247(d)
RF Output power (Detection methods)	Limit(dB)
RF Output power(Average detector)	30dBc(Note1)
RF Output power(PK detector)	20dBc(Note2)
<p>Note 1: If maximum conducted (average) output power was used to demonstrate compliance as described in 9.2, then the peak power in any 100 kHz bandwidth outside of the authorized frequency band shall be attenuated by at least 30 dB relative to the maximum in-band peak PSD level in 100 kHz (i.e., 30 dBc).</p> <p>Note 2: If the maximum peak conducted output power procedure was used, then the peak output power measured in any 100 kHz bandwidth outside of the authorized frequency band shall be attenuated by at least 20 dB relative to the maximum in-band peak PSD level in 100 kHz (i.e., 20 dBc).</p>	

4.3.2 Test Setup

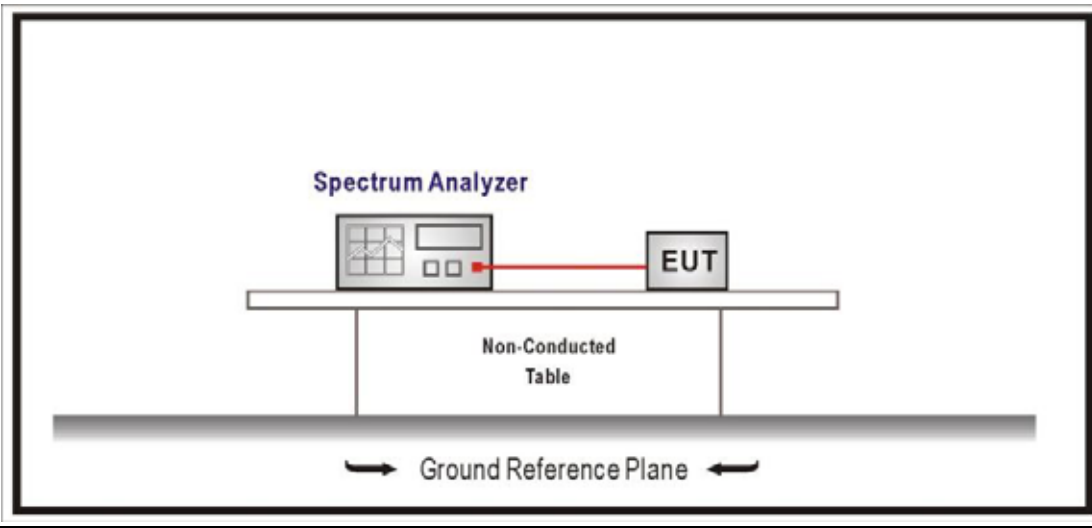

4.3.3 Test Procedure

References Rule	Chapter	Description
<input checked="" type="checkbox"/>	ANSI C63.10	11.11 Emissions in non-restricted frequency bands
<input checked="" type="checkbox"/>	ANSI C63.10	11.11.1 General
<input checked="" type="checkbox"/>	ANSI C63.10	11.11.2 Reference level measurement
<input checked="" type="checkbox"/>	ANSI C63.10	11.11.3 Emission level measurement

4.3.4 Test Data

Mode	Channel	Test Frequency (MHz)	Maximum In-Band PSD[a] (dBm/100kHz)	Frequency (MHz)	Out-Band PSD[b] (dBm/100kHz)	[a]-[b] (dB)	Limit (dB)	Result
1	11	2405	6.554	2400	-46.243	52.797	>20	Pass
	26	2480	6.431	2500	-53.073	59.504	>20	Pass

Note 1: The worst data plot as below:

Mode1/CH11/2405MHz

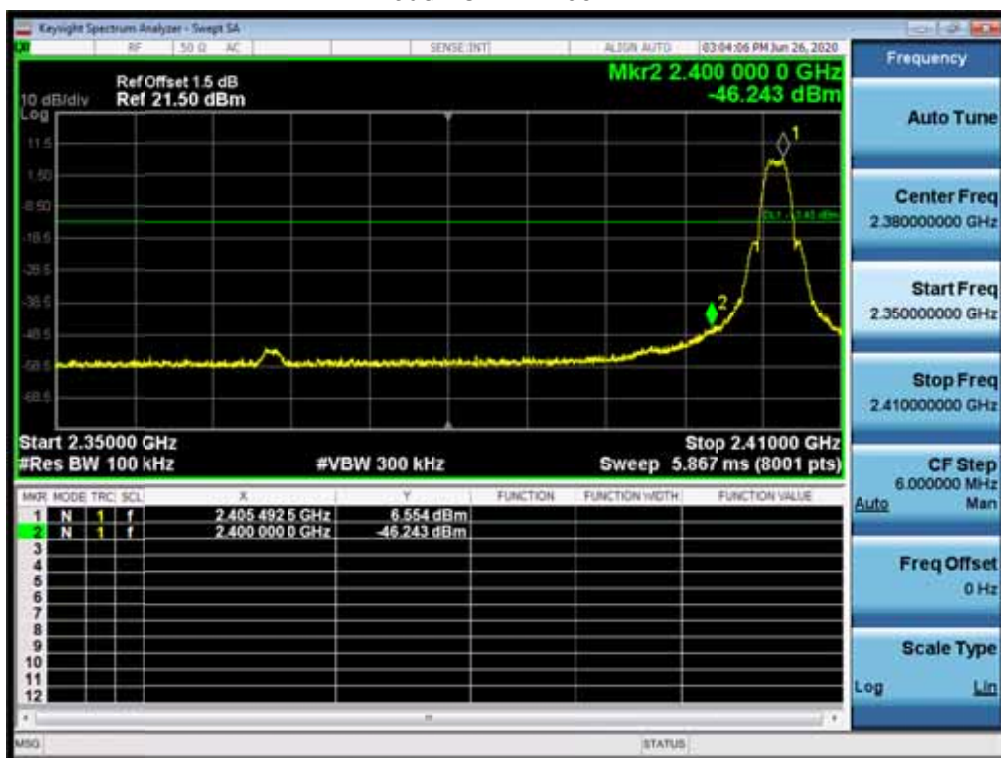

4.4 Duty cycle

VERDICT: PASS

4.4.1 Limit

N/A

4.4.2 Test Setup

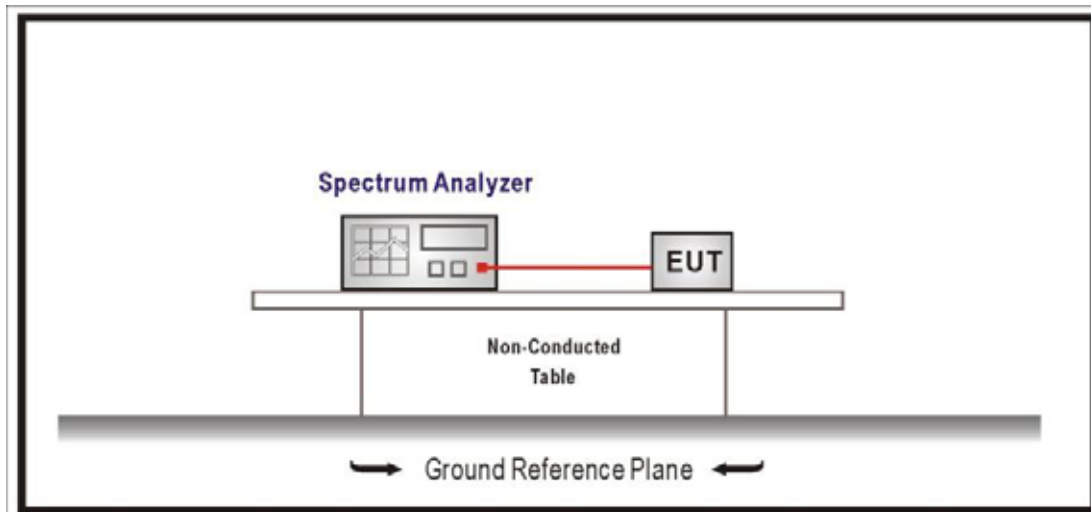

4.4.3 Test Procedure

References Rule	Chapter	Description
<input checked="" type="checkbox"/> ANSI C63.10	11.6	Duty cycle (D), transmission duration (T), and maximum power control level

4.4.4 Test Data

Test Mode	Tx On (us)	Tx Off (us)	VBW (kHz)	Tx On + Tx Off (us)	Duty Cycle (%)
Mode 1	--	--	--	--	100

Note 1: T means the minimum transmission duration over which the transmitter is on and is transmitting at its maximum power control level for the tested mode of operation.

Note 2: According to KDB 558074, when test for Radiated Emission Band Edge and Radiated Emission, for average detector set: VBW 1/T will be used.

Mode 1 CH18 2440MHz

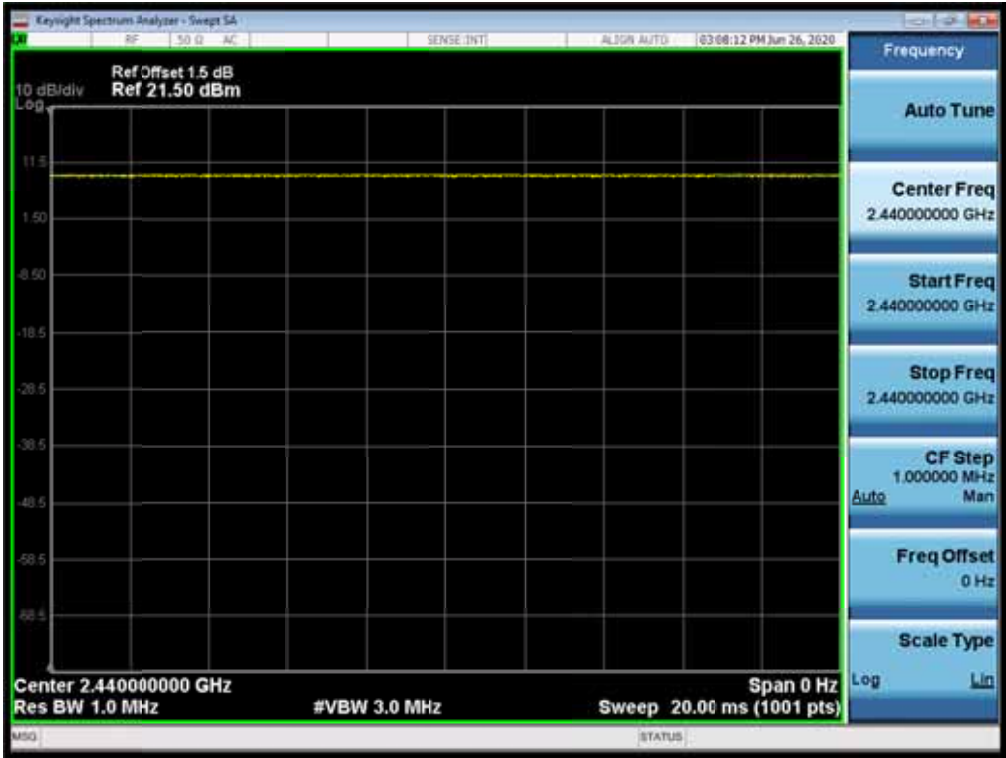

4.5 Radiated Emission Band Edge

VERDICT: PASS

4.5.1 Limit

Standard		FCC Part 15 Subpart C Paragraph 15.247(d) , 15.209		
Frequency bands (MHz)	Detector	Limit (dB μ V/m)	RBW (MHz)	Distance (m)
2310-2390	PK	74	1	3
2483.5-2500	AV	54	1	3

Note: The field strength of emissions appearing within these frequency bands shall not exceed the limits.

4.5.2 Test Setup

Above 1GHz Test Setup:

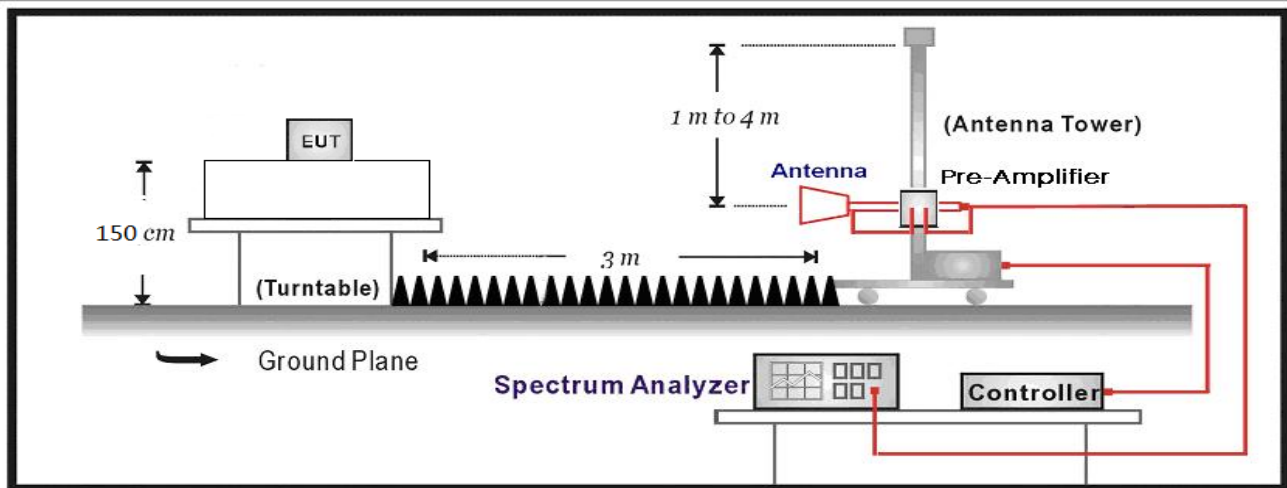

4.5.3 Test Procedure

	References Rule	Chapter	Description
<input checked="" type="checkbox"/>	ANSI C63.10	6.10	Band-edge testing
	<input checked="" type="checkbox"/> ANSI C63.10	6.10.5	Restricted-band band-edge measurements
	<input type="checkbox"/> ANSI C63.10	6.10.6	Marker-delta method
<input checked="" type="checkbox"/>	ANSI C63.10	11.12	Emissions in restricted frequency bands
	<input checked="" type="checkbox"/> ANSI C63.10	11.12.1	Radiated emission measurements
	<input checked="" type="checkbox"/> ANSI C63.10	11.12.2.7	Radiated spurious emission test
<input type="checkbox"/>	ANSI C63.10	6.4	Radiated emissions from unlicensed wireless devices below 30 MHz
<input type="checkbox"/>	ANSI C63.10	6.5	Radiated emissions from unlicensed wireless devices in the frequency range of 30 MHz to 1000 MHz
<input checked="" type="checkbox"/>	ANSI C63.10	6.6	Radiated emissions from unlicensed wireless devices above 1 GHz

4.5.4 Test Data

Profile: 2060819R	Page No.: 1
Engineer: YULIU	
Site: AC5	Time: 2020/03/12 - 00:49
Limit: FCC_Part15.209_RE(3m)	Margin: 0
Probe: Horn_3117_00167055(1-18GHz)	Polarity: Vertical
EUT: LED Device	Power: AC 120V/60Hz
Note: Mode 1:Transmit at 2405MHz	

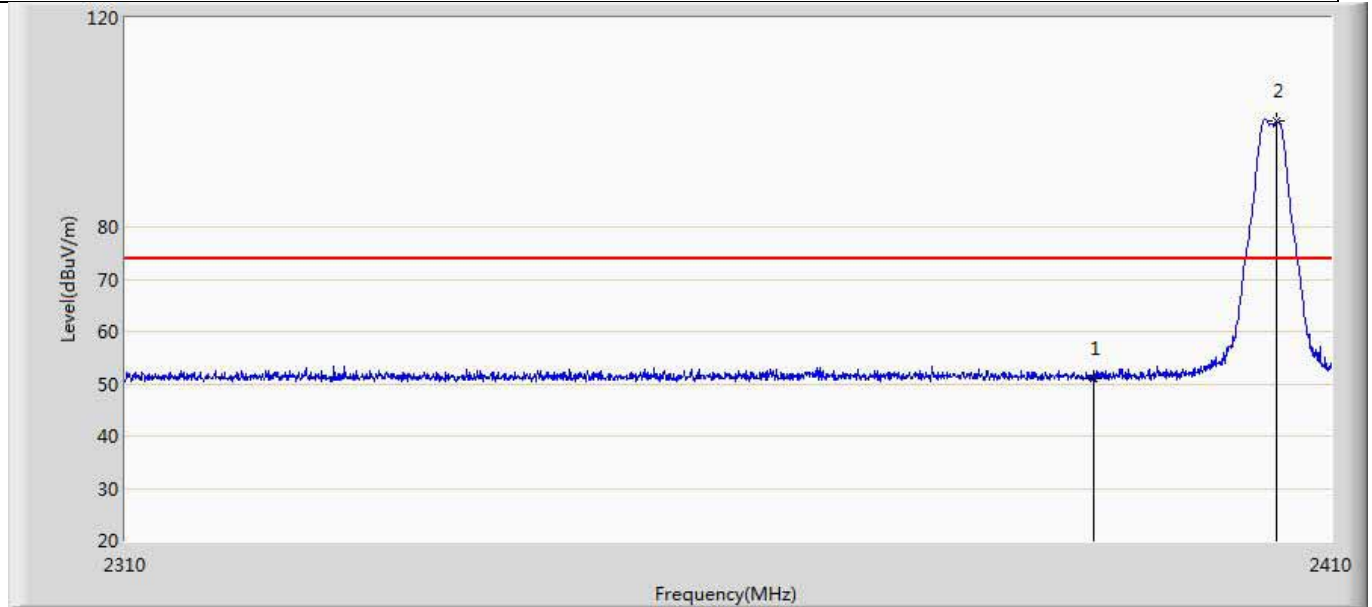

No	Mark	Frequency (MHz)	Measure Level (dBuV/m)	Reading Level (dBuV)	Over Limit (dB)	Limit (dBuV/m)	Factor (dB)	Type
1		2390.000	51.094	15.779	-22.906	74.000	35.315	PK
2	*	2405.450	100.434	65.123	26.434	74.000	35.311	PK

Profile: 2060819R	Page No.: 2
Engineer: YULIU	
Site: AC5	Time: 2020/04/28 - 20:21
Limit: FCC_Part15.209_RE(3m)	Margin: 0
Probe: Horn_3117_00167055(1-18GHz)	Polarity: Vertical
EUT: LED Device	Power: AC 120V/60Hz
Note: Mode 1:Transmit at 2405MHz	

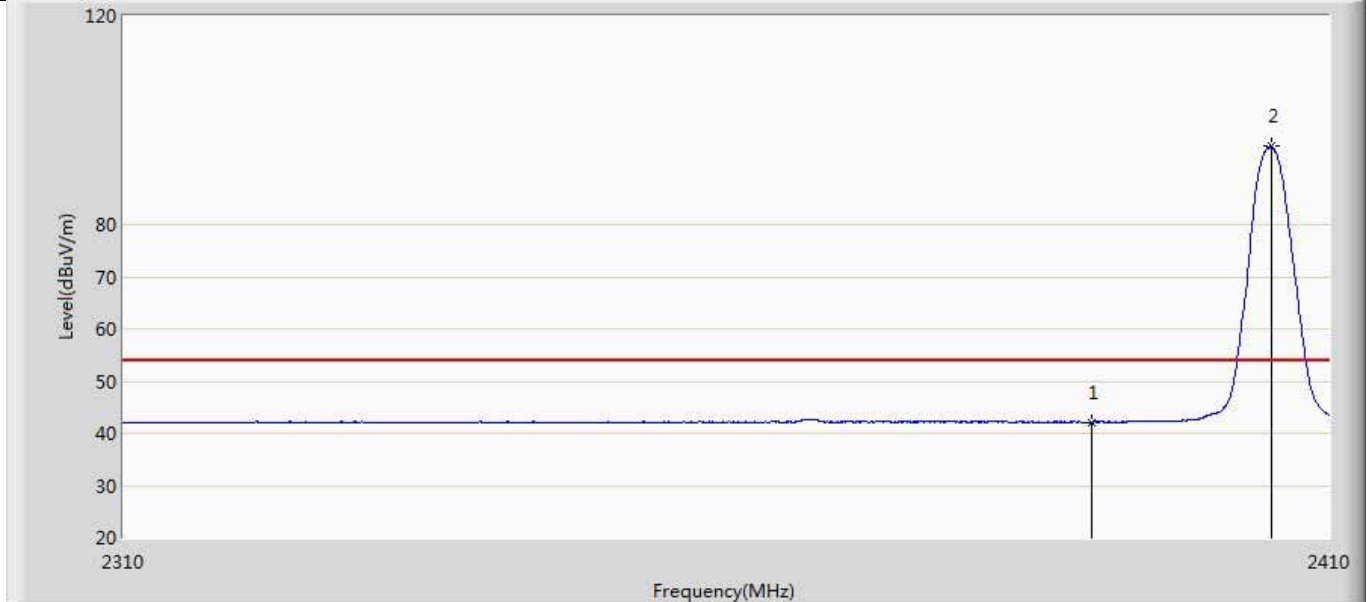

No	Mark	Frequency (MHz)	Measure Level (dBuV/m)	Reading Level (dBuV)	Over Limit (dB)	Limit (dBuV/m)	Factor (dB)	Type
1		2390.000	42.148	6.833	-11.852	54.000	35.315	AV
2	*	2405.150	94.966	59.655	40.966	54.000	35.311	AV

Profile: 2060819R	Page No.: 3
Engineer: YULIU	
Site: AC5	Time: 2020/04/28 - 20:24
Limit: FCC_Part15.209_RE(3m)	Margin: 0
Probe: Horn_3117_00167055(1-18GHz)	Polarity: Horizontal
EUT: LED Device	Power: AC 120V/60Hz
Note: Mode 1:Transmit at 2405MHz by	

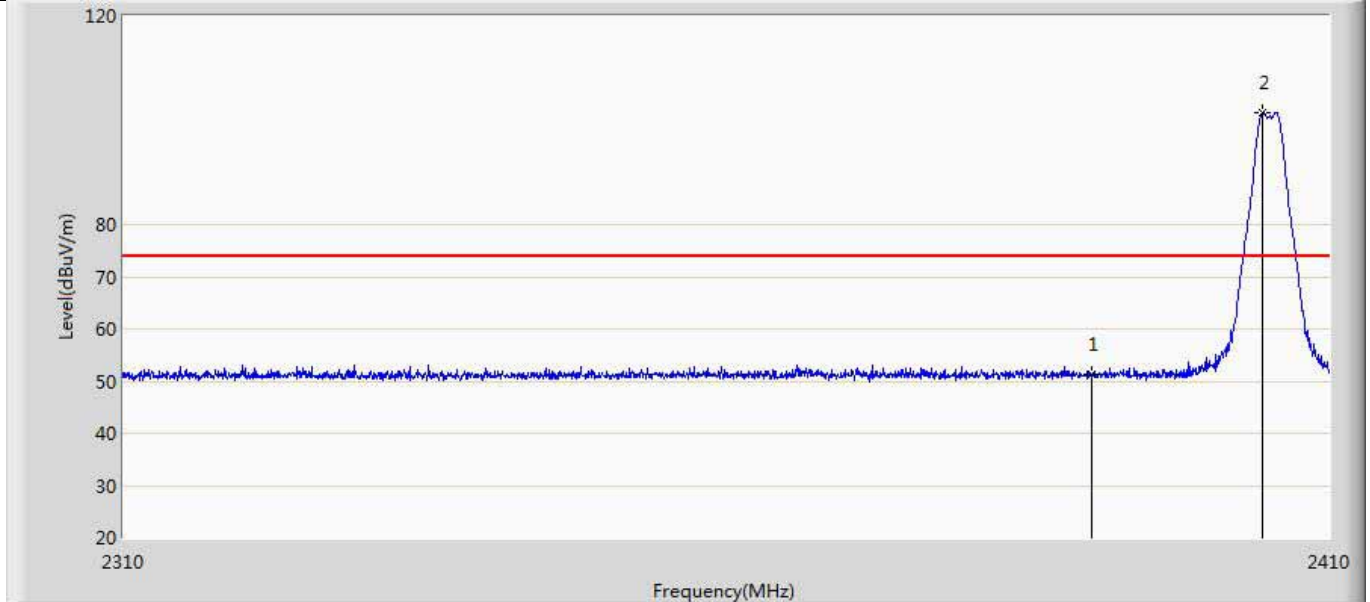

No	Mark	Frequency (MHz)	Measure Level (dBuV/m)	Reading Level (dBuV)	Over Limit (dB)	Limit (dBuV/m)	Factor (dB)	Type
1		2390.000	51.423	16.108	-22.577	74.000	35.315	PK
2	*	2404.350	101.340	66.029	27.340	74.000	35.311	PK

Profile: 2060819R	Page No.: 4
Engineer: YULIU	
Site: AC5	Time: 2020/04/28 - 20:26
Limit: FCC_Part15.209_RE(3m)	Margin: 0
Probe: Horn_3117_00167055(1-18GHz)	Polarity: Horizontal
EUT: LED Device	Power: AC 120V/60Hz
Note: Mode 1:Transmit at 2405MHz	

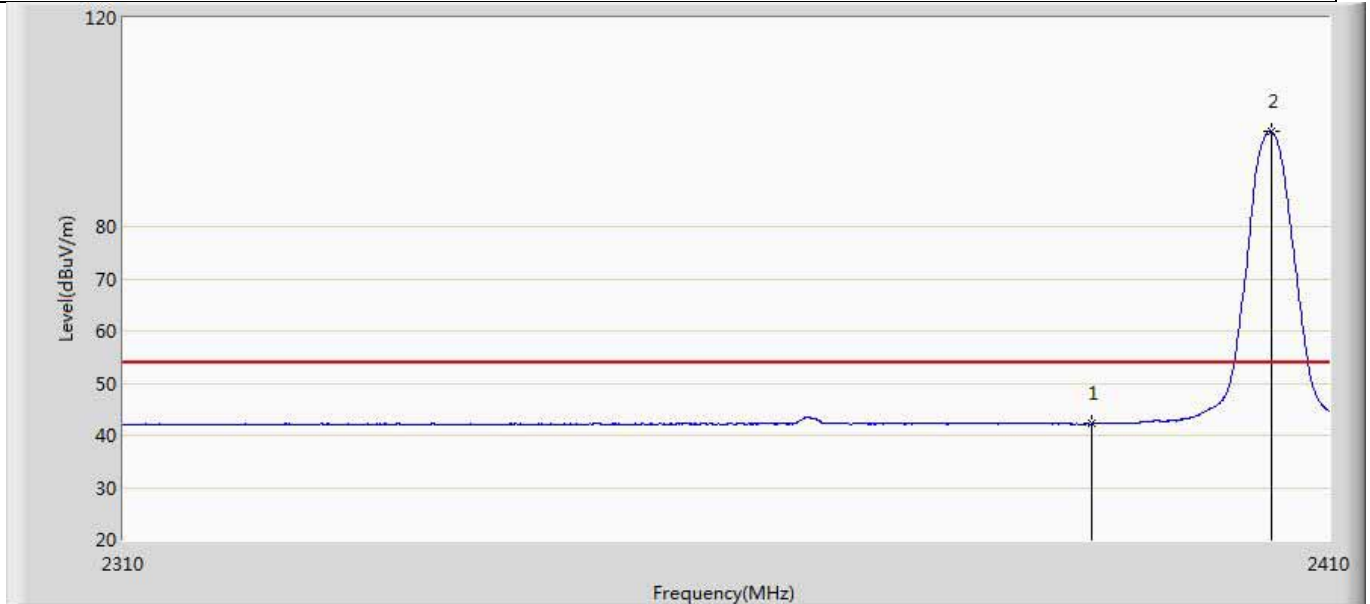

No	Mark	Frequency (MHz)	Measure Level (dBuV/m)	Reading Level (dBuV)	Over Limit (dB)	Limit (dBuV/m)	Factor (dB)	Type
1		2390.000	42.181	6.866	-11.819	54.000	35.315	AV
2	*	2405.150	98.149	62.838	44.149	54.000	35.311	AV

Profile: 2060819R	Page No.: 5
Engineer: YULIU	
Site: AC5	Time: 2020/04/28 - 20:28
Limit: FCC_Part15.209_RE(3m)	Margin: 0
Probe: Horn_3117_00167055(1-18GHz)	Polarity: Vertical
EUT: LED Device	Power: AC 120V/60Hz
Note: Mode 1:Transmit at 2480MHz	

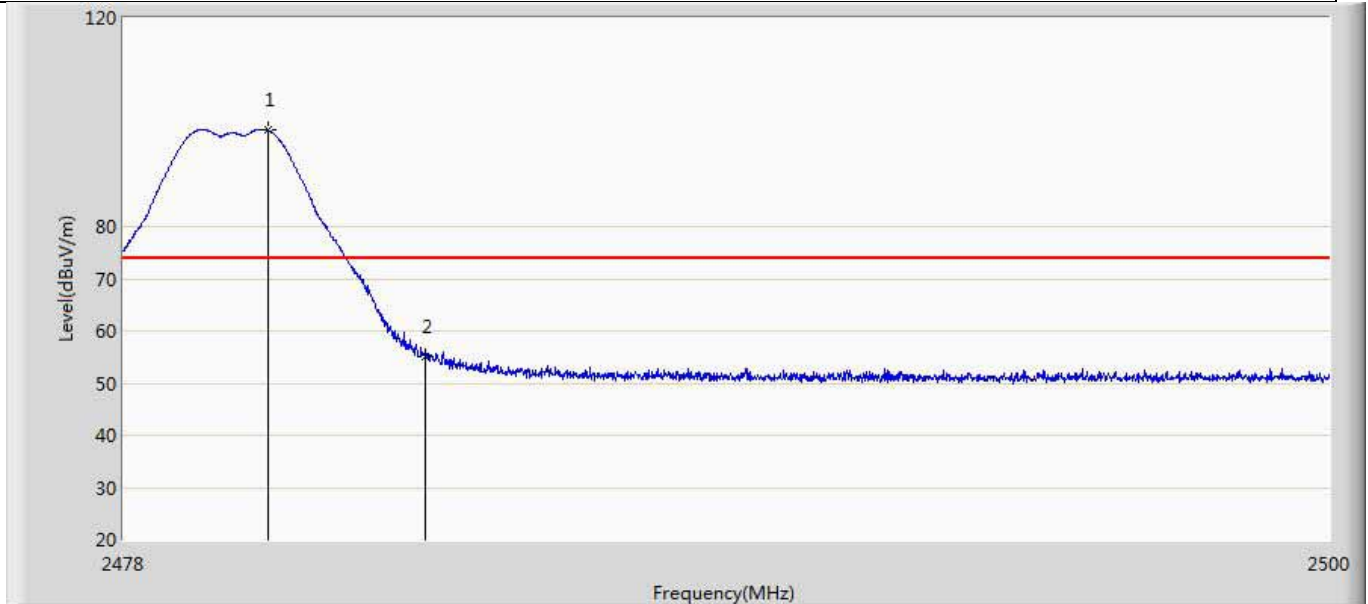

No	Mark	Frequency (MHz)	Measure Level (dBuV/m)	Reading Level (dBuV)	Over Limit (dB)	Limit (dBuV/m)	Factor (dB)	Type
1	*	2480.629	98.458	63.160	24.458	74.000	35.298	PK
2		2483.500	55.189	19.891	-18.811	74.000	35.297	PK

Profile: 2060819R	Page No.: 6
Engineer: YULIU	
Site: AC5	Time: 2020/04/28 - 20:31
Limit: FCC_Part15.209_RE(3m)	Margin: 0
Probe: Horn_3117_00167055(1-18GHz)	Polarity: Vertical
EUT: LED Device	Power: AC 120V/60Hz
Note: Mode 1:Transmit at 2480MHz	

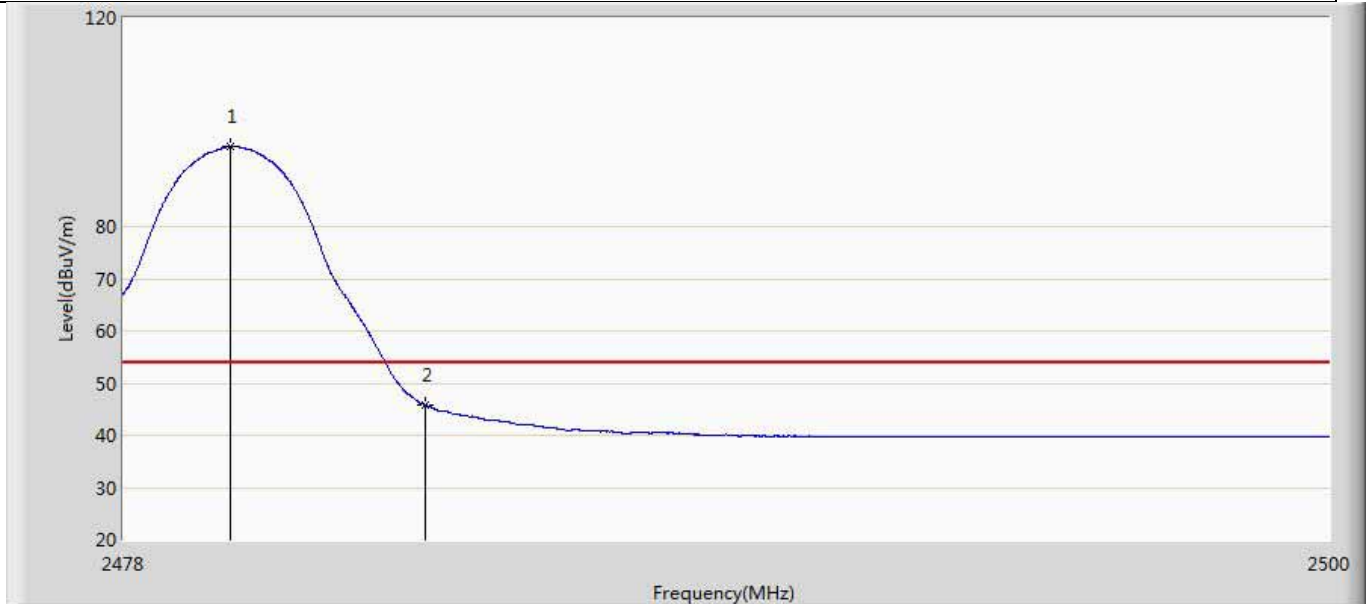

No	Mark	Frequency (MHz)	Measure Level (dBuV/m)	Reading Level (dBuV)	Over Limit (dB)	Limit (dBuV/m)	Factor (dB)	Type
1	*	2479.936	95.336	60.037	41.336	54.000	35.299	AV
2		2483.500	45.721	10.423	-8.279	54.000	35.297	AV

Profile: 2060819R	Page No.: 7
Engineer: YULIU	
Site: AC5	Time: 2020/04/28 - 20:33
Limit: FCC_Part15.209_RE(3m)	Margin: 0
Probe: Horn_3117_00167055(1-18GHz)	Polarity: Horizontal
EUT: LED Device	Power: AC 120V/60Hz
Note: Mode 1:Transmit at 2480MHz	

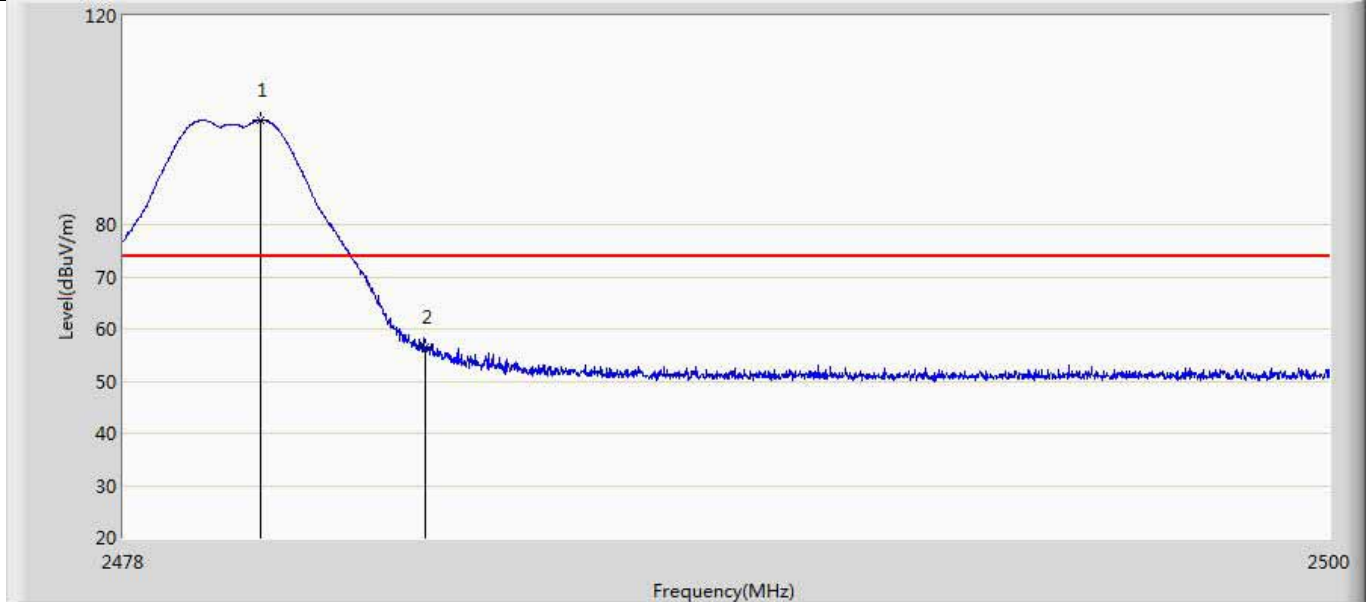

No	Mark	Frequency (MHz)	Measure Level (dBuV/m)	Reading Level (dBuV)	Over Limit (dB)	Limit (dBuV/m)	Factor (dB)	Type
1	*	2480.486	99.971	64.673	25.971	74.000	35.298	PK
2		2483.500	56.607	21.309	-17.393	74.000	35.297	PK

Profile: 2060819R	Page No.: 8
Engineer: YULIU	
Site: AC5	Time: 2020/04/28 - 20:36
Limit: FCC_Part15.209_RE(3m)	Margin: 0
Probe: Horn_3117_00167055(1-18GHz)	Polarity: Horizontal
EUT: LED Device	Power: AC 120V/60Hz
Note: Mode 1:Transmit at 2480MHz	

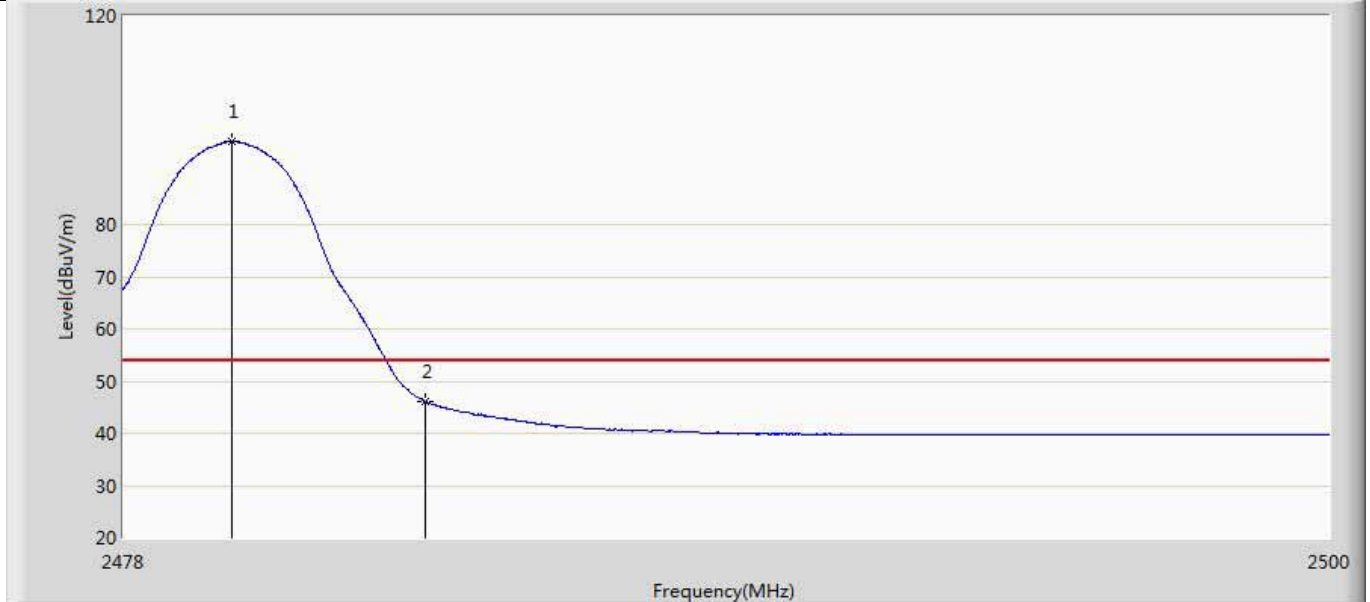

No	Mark	Frequency (MHz)	Measure Level (dBuV/m)	Reading Level (dBuV)	Over Limit (dB)	Limit (dBuV/m)	Factor (dB)	Type
1	*	2479.980	95.934	60.635	41.934	54.000	35.299	AV
2		2483.500	45.997	10.699	-8.003	54.000	35.297	AV

4.6 DTS Bandwidth	VERDICT: PASS
--------------------------	----------------------

4.6.1 Limit	
Standard	FCC Part 15 Subpart C Paragraph 15.247 (a)(2)
Systems using digital modulation techniques operate in the 2400-2483.5 MHz. The minimum 6 dB bandwidth shall be at least 500 kHz	

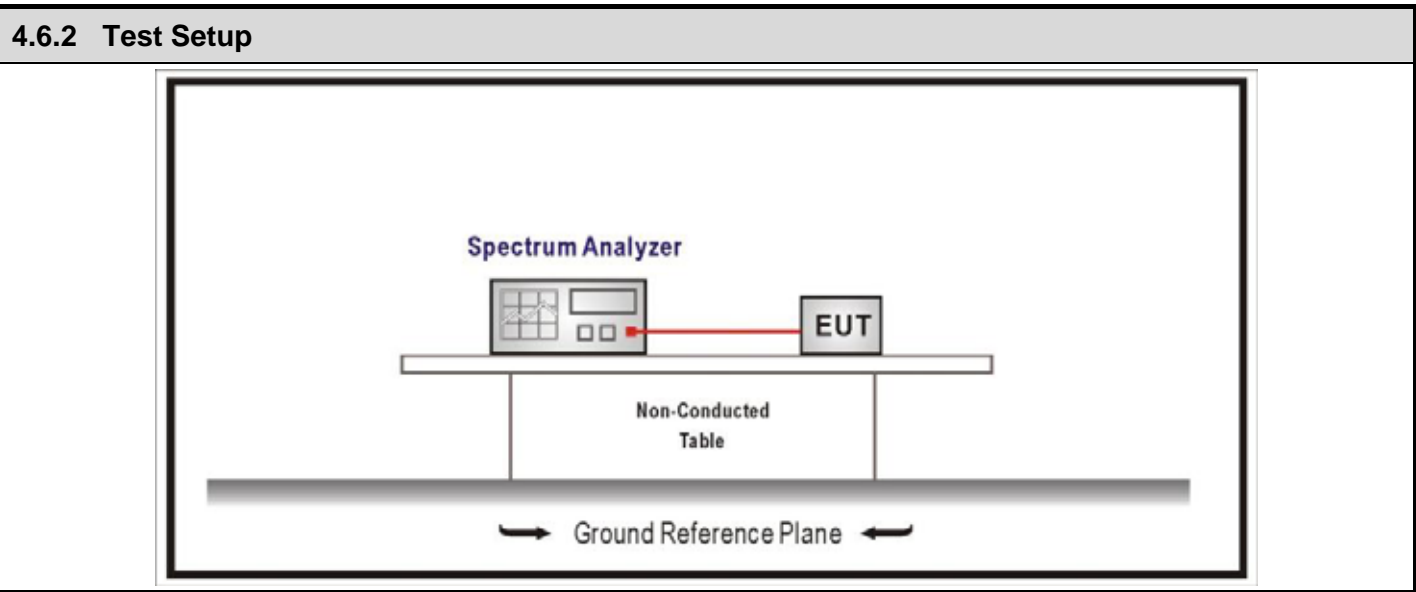

4.6.3 Test Procedure			
	Reference Rule	Chapter	Description
<input checked="" type="checkbox"/>	ANSI C63.10	11.8	DTS bandwidth
<input type="checkbox"/>	ANSI C63.10	11.8.1	Option 1
<input checked="" type="checkbox"/>	ANSI C63.10	11.8.2	Option 2

4.6.4 Test Data

Mode	CH.	Test Freq. (MHz)	99% Occupied Bandwidth (kHz)	6dB Occupied Bandwidth (kHz)	Limit (kHz)	Result
1	11	2405	2268.7	1667.0	>500	Pass
	18	2440	2272.6	1666.0	>500	Pass
	26	2480	2278.5	1667.0	>500	Pass

Note : The worst case of Occupied Bandwidth as below:

99% Occupied Bandwidth Mode 1 CH11 (2405MHz)	6dB Occupied Bandwidth Mode 1 CH18 (2440MHz)
<p>Center Freq: 2.40500000 GHz</p> <p>Center: 2.405 GHz, Res BW: 100 kHz, Span: 10 MHz, Sweep: 1 ms</p> <p>Occupied Bandwidth: 2.2687 MHz</p> <p>Total Power: 17.3 dBm</p> <p>Transmit Freq Error: -8.565 kHz, % of OBW Power: 99.00 %</p> <p>x dB Bandwidth: 1.667 MHz, x dB: -6.00 dB</p>	<p>Center Freq: 2.44000000 GHz</p> <p>Center: 2.44 GHz, Res BW: 100 kHz, Span: 10 MHz, Sweep: 1 ms</p> <p>Occupied Bandwidth: 2.2726 MHz</p> <p>Total Power: 17.0 dBm</p> <p>Transmit Freq Error: -7.565 kHz, % of OBW Power: 99.00 %</p> <p>x dB Bandwidth: 1.666 MHz, x dB: -6.00 dB</p>

4.7 Fundamental emission output power

VERDICT: PASS

4.7.1 Limit

Standard		FCC Part 15 Subpart C Paragraph 15.247 (b)(3)
<input checked="" type="checkbox"/>	GTX < 6dBi	Pout 30dBm
<input type="checkbox"/>	GTX > 6dBi	
<input type="checkbox"/>	Non-Fix point-point	Pout 30-(GTX -6)
<input type="checkbox"/>	Fix point-point	Pout 30-[(GTX-6)]/3
<input type="checkbox"/>	Point-to-multipoint	Pout 30-(GTX-6)
<input type="checkbox"/>	Overlap Beams	Pout 30-[(GTX-6)]/3
<input type="checkbox"/>	Aggregate power transmitted simultaneously on all beams	Pout 30-[(GTX-6)]/3
<input type="checkbox"/>	single directional beam	Pout 30-[(GTX-6)]/3+8dB

Note 1 : GTX directional gain of transmitting antennas.
 Note 2 : Pout is maximum peak conducted output power .

4.7.2 Test Setup

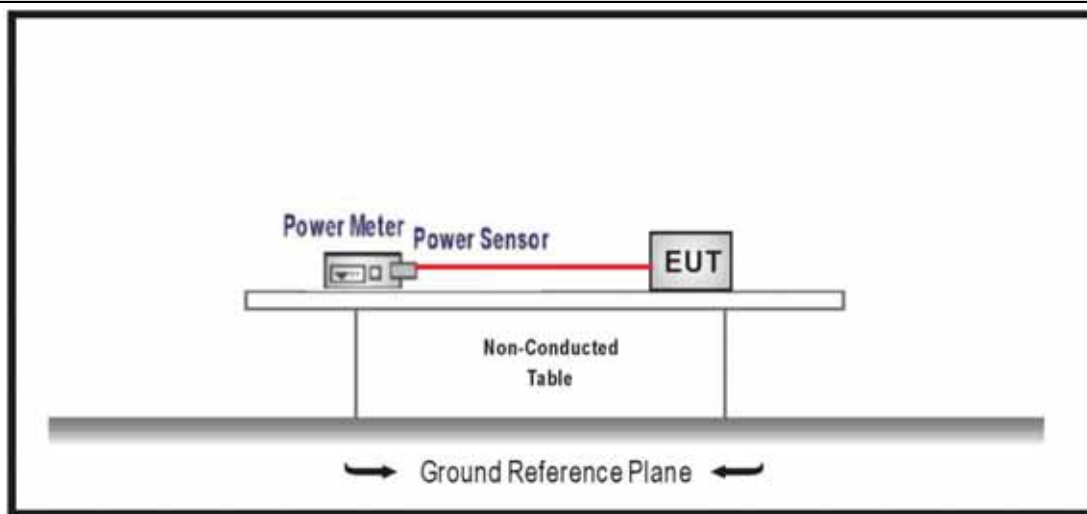

4.7.3 Test Procedure					
	References Rule		Chapter	Description	
<input checked="" type="checkbox"/>	ANSI C63.10		11.9	Fundamental emission output power	
	<input checked="" type="checkbox"/>	ANSI C63.10		11.9.1 Maximum peak conducted output power	
		<input type="checkbox"/>	ANSI C63.10	11.9.1.1 RBW ≥ DTS bandwidth	
		<input type="checkbox"/>	ANSI C63.10	11.9.1.2 Integrated band power method	
		<input type="checkbox"/>	ANSI C63.10	11.9.1.3 PKPM1 Peak power meter method	
	<input type="checkbox"/>	ANSI C63.10		11.9.2 Maximum conducted (average) output power	
		<input type="checkbox"/>	ANSI C63.10		11.9.2.2 Measurement using a spectrum analyzer (SA)
			<input type="checkbox"/>	ANSI C63.10	11.9.2.2.2 Method AVGSA-1(Duty cycle 98%)
			<input type="checkbox"/>	ANSI C63.10	11.9.2.2.3 Method AVGSA-1A(Duty cycle 98%)
			<input type="checkbox"/>	ANSI C63.10	11.9.2.2.4 Method AVGSA-2(Duty cycle 98%)
			<input type="checkbox"/>	ANSI C63.10	11.9.2.2.5 Method AVGSA-2A(Duty cycle 98%)
			<input type="checkbox"/>	ANSI C63.10	11.9.2.2.4 Method AVGSA-3
		<input type="checkbox"/>	ANSI C63.10	11.9.2.2.5 Method AVGSA-3A	
		<input checked="" type="checkbox"/>	ANSI C63.10		11.9.2.3 Measurement using a power meter (PM)
	<input checked="" type="checkbox"/>	ANSI C63.10	11.9.2.3.1 Method AVGPM		
	<input type="checkbox"/>	ANSI C63.10	11.9.2.3.2 Method AVGPM-G		

4.7.4 Test Data					
Mode	Channel	Test Frequency (MHz)	Power Output (dBm)	Limit (dBm)	Result
Mode 1	11	2405	13.21	30	Pass
	18	2440	13.13	30	Pass
	26	2480	13.16	30	Pass

4.8 Power Density

VERDICT: PASS

4.8.1 Limit:

Standard FCC Part 15 Subpart C Paragraph 15.247 (b)(3)

Power Spectral Density 8dBm/3kHz

4.8.2 Test Setup

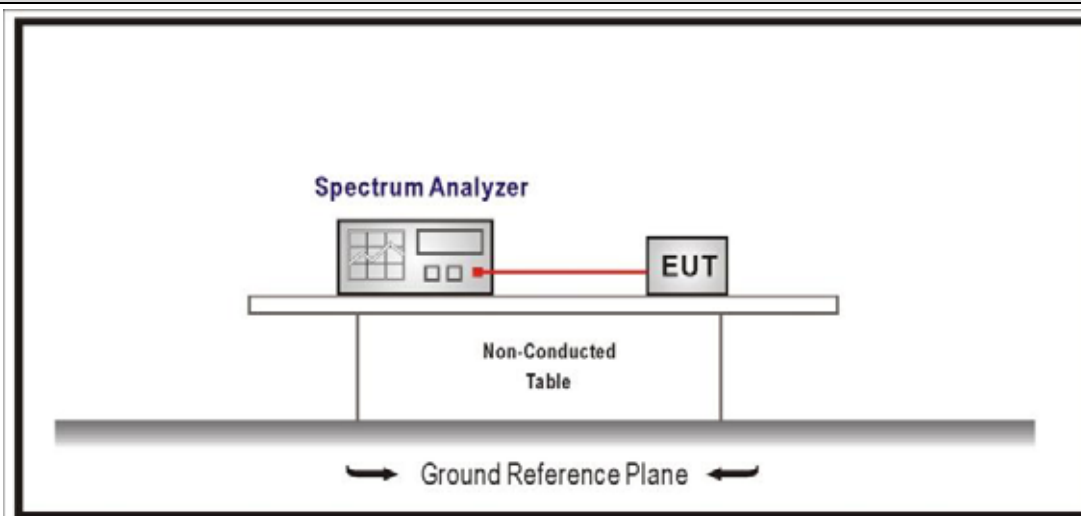

4.8.3 Test Procedure

	References Rule	Chapter	Description
<input checked="" type="checkbox"/>	ANSI C63.10	11.10	Maximum power spectral density level in the fundamental emission
	<input checked="" type="checkbox"/> ANSI C63.10	11.10.2	Method PKPSD (peak PSD)
	<input type="checkbox"/> ANSI C63.10	11.10.3	Method AVGPSD-1(Duty cycle 98%)
	<input type="checkbox"/> ANSI C63.10	11.10.4	Method AVGPSD-1A(Duty cycle 98%)
	<input type="checkbox"/> ANSI C63.10	11.10.5	Method AVGPSD-2(Duty cycle < 98%)
	<input type="checkbox"/> ANSI C63.10	11.10.6	Method AVGPSD-2A(Duty cycle < 98%)
	<input type="checkbox"/> ANSI C63.10	11.10.7	Method AVGPSD-3
	<input type="checkbox"/> ANSI C63.10	11.10.8	Method AVGPSD-3A

4.8.4 Test Data

Mode	Channel	Test Frequency (MHz)	Measurement PSD (dBm/3kHz)	Limit (dBm/3kHz)	Result
Mode 1	11	2405	-5.331	≤8	Pass
	18	2440	-6.425	≤8	Pass
	26	2480	-6.313	≤8	Pass

Note : The worst case of PSD as below:

Mode 1 CH11(2405MHz)



4.9 Antenna Requirement

VERDICT: PASS

4.9.1 Limit:

Standard	FCC Part 15 Subpart C Paragraph 15.203
-----------------	--

An intentional radiator shall be designed to ensure that no antenna other than that furnished by the responsible party shall be used with the device. The use of a permanently attached antenna or of an antenna that uses a unique coupling to the intentional radiator shall be considered sufficient to comply with the provisions of this section. The manufacturer may design the unit so that a broken antenna can be replaced by the user, but the use of a standard antenna jack or electrical connector is prohibited. This requirement does not apply to carrier current devices or to devices operated under the provisions of §15.211, §15.213, §15.217, §15.219, or §15.221. Further, this requirement does not apply to intentional radiators that must be professionally installed, such as perimeter protection systems and some field disturbance sensors, or to other intentional radiators which, in accordance with §15.31(d), must be measured at the installation site. However, the installer shall be responsible for ensuring that the proper antenna is employed so that the limits in this part are not exceeded.

4.9.2 Antenna Connector Construction:

- | | |
|-------------------------------------|--|
| <input checked="" type="checkbox"/> | The use of a permanently attached antenna |
| <input type="checkbox"/> | The antenna use of a unique coupling to the intentional radiator |
| <input type="checkbox"/> | The use of a nonstandard antenna jack or electrical connector |
- Please refer to the attached document "Internal Photograph" to show the antenna connector.

5 TEST SETUP PHOTO AND EUT PHOTO

Remark: The test setup photo and EUT Photo please see appendix.

_____ The End _____