



Test report No:
21C0118R-RF-US-P06V02

FCC & ISED C2PC TEST REPORT

Product Name	LED Device
Trademark	PHILIPS
Model and /or type reference	9290022891A
FCC ID	2AGBW9290022891AX
IC	20812-2891AX
Applicant's name / address	Signify (China) Investment Co., Ltd Building no.9, Lane 888, Tianlin Road, Minhang District, Shanghai, 200233, China
Test method requested, standard	FCC CFR Title 47 Part 15 Subpart C Section 15.247 ANSI C63.10: 2013 KD558074 D01 15.247 Meas Guidance v05r02 RSS-Gen Issue 5 RSS-247 Issue 2
Verdict Summary	IN COMPLIANCE
Documented by (name / position & signature)	Adma Lu/Project Engineer <i>Adma Lu</i>
Approved by (name / position & signature)	Jack Zhang/ Supervisor <i>Jack Zhang</i>
Date of issue	2021-12-22
Report template No	Template_FCC 15.247-RF-V1.0

INDEX

	page
General conditions	4
Environmental conditions	4
Possible test case verdicts	5
Abbreviations.....	5
Document History.....	6
Remarks and Comments	6
Used Equipment.....	7
Uncertainty	9
1 General Information	10
1.1 General Description of the Item(s).....	10
1.2 Antenna Information	11
1.3 Channel List.....	12
2 Description of Test Setup.....	13
2.1 Operating mode(s) used for tests	13
2.2 Test Configuration / Block diagram used for tests.....	14
2.3 Testing process	15
3 Verdict summary section.....	16
3.1 Standards	16
3.2 Deviation(s) from the Standard(s) / Test Specification(s).....	16
3.3 Overview of results	17
3.4 Test Facility.....	18
4 Test Results	19
4.1 AC Power Line Conducted Emission.....	19
4.1.1 Limit	19
4.1.2 Test Setup	19
4.1.3 Test Procedure	19
4.1.4 Test Data	20
4.2 Emissions in restricted frequency bands	22
4.2.1 Limit	22
4.2.2 Test Setup	24
4.2.3 Test Procedure	24
4.2.4 Test Data	25
4.3 Radiated Emission Band Edge.....	51
4.3.1 Limit	51

4.3.2	Test Setup	51
4.3.3	Test Procedure	51
4.3.4	Test Data	52
5	Test setup photo and EUT Photo	87

COMPETENCES AND GUARANTEES

DEKRA is a testing laboratory competent to carry out the tests described in this report.

In order to assure the traceability to other national and international laboratories, DEKRA has a calibration and maintenance program for its measurement equipment.

DEKRA guarantees the reliability of the data presented in this report, which is the result of the measurements and the tests performed to the item under test on the date and under the conditions stated in the report and it is based on the knowledge and technical facilities available at DEKRA at the time of performance of the test.

DEKRA is liable to the client for the maintenance of the confidentiality of all information related to the item under test and the results of the test.

The results presented in this Test Report apply only to the particular item under test established in this document.

IMPORTANT: No parts of this report may be reproduced or quoted out of context, in any form or by any means, except in full, without the previous written permission of DEKRA.

GENERAL CONDITIONS

Test Location	No. 99, Hongye Road, Suzhou Industrial Park Suzhou, 215006, P.R. China
Date(receive sample)	Dec. 06, 2021
Date (start test)	Dec. 06, 2021
Date (finish test)	Dec. 13, 2021

1. This report is only referred to the item that has undergone the test.
2. This report does not constitute or imply on its own an approval of the product by the Certification Bodies or Competent Authorities.
3. This document is only valid if complete; no partial reproduction can be made without previous written permission of DEKRA.
4. This test report cannot be used partially or in full for publicity and/or promotional purposes without previous written permission of DEKRA.

ENVIRONMENTAL CONDITIONS

The climatic conditions during the tests are within the limits specified by the manufacturer for the operation of the EUT and the test equipment. The climatic conditions during the tests were within the following limits:

Ambient temperature	15 °C – 35 °C
Relative Humidity air	30% - 60%

If explicitly required in the basic standard or applied product / product family standard the climatic values are recorded and documented separately in this test report.

POSSIBLE TEST CASE VERDICTS

Test case does not apply to test object	N/A
Test object does meet requirement	P (Pass) / PASS
Test object does not meet requirement	F (Fail) / FAIL
Not measured	N/M

ABBREVIATIONS

For the purposes of the present document, the following abbreviations apply:

EUT	: Equipment Under Test
QP	: Quasi-Peak
CAV	: CISPR Average
AV	: Average
CDN	: Coupling Decoupling Network
SAC	: Semi-Anechoic Chamber
OATS	: Open Area Test Site
BW	: Bandwidth
AM	: Amplitude Modulation
PM	: Pulse Modulation
HCP	: Horizontal Coupling Plane
VCP	: Vertical Coupling Plane
U_N	: Nominal voltage
T_x	: Transmitter
R_x	: Receiver
N/A	: Not Applicable
N/M	: Not Measured

DOCUMENT HISTORY

Report No.	Version	Description	Issued Date
21C0118R-RF-US-P06V02	V1.0	Initial issue of report.	2021-12-22

REMARKS AND COMMENTS

1. The equipment under test (EUT) does meet the essential requirements of the stated standard(s)/test(s).
2. These test results on a sample of the device are for the purpose of demonstrating Compliance with Part 15 Subpart C Paragraph 15.247, RSS-Gen Issue 5, RSS-247 Issue 2.
3. The measurement result is considered in conformance with the requirement if it is within the prescribed limit, It is not necessary to account the uncertainty associated with the measurement result.
4. The test results presented in this report relate only to the object tested.
5. The test report shall not be reproduced without the written approval of DEKRA Testing and Certification (Suzhou) Co., Ltd.
6. This report will not be used for social proof function in China market.
7. DEKRA declines any responsibility with the following test data provided by customer that may affect the validity of result:
 - Chapter 1.1 General Description of the Item(s);
 - Chapter 1.2 Antenna Information;
 - Chapter 1.3 Channel List.

USED EQUIPMENT

AC Power Line Conducted Emission / TR1

Instrument	Manufacturer	Model No.	Serial No.	Cal. Date	Next Cal. Date
EMI Test Receiver	R&S	ESCI	100906	2021.04.28	2022.04.29
Two-Line V-Network	R&S	ENV216	101190	2021.01.27	2022.02.26
Two-Line V-Network	R&S	ENV216	101044	2021.03.20	2022.03.19
Current Probe	R&S	EZ-17	100678	2021.01.27	2022.01.26
50ohm Termination	SHX	TF2	07081403	2021.09.04	2022.09.03
50ohm Coaxial Switch	Anritsu	MP59B	6200464462	N/A	N/A
Temperature/Humidity Meter	RTS	RTS-8S	TR1-TH	2021.07.09	2022.07.08
Coaxial Cable	Suhner	RG 223	TR1-C1	2021.07.09	2022.07.08
Dekra test software	Dekra	-	-	-	-

Emissions in non-restricted frequency bands/ Occupied Bandwidth/ Fundamental emission output power Power Spectral Density / TR8

Instrument	Manufacturer	Model No.	Serial No.	Cal. Date	Next Cal. Date
Spectrum Analyzer	Agilent	N9010A	MY48030494	2021.07.11	2022.07.10
EXA Spectrum Analyzer	Keysight	N9010A	MY55370495	2021.07.11	2022.07.10
MXA Signal Analyzer	Keysight	N9020A	MY56060147	2021.07.11	2022.07.10
Dekra test software	Dekra	-	-	-	-

Radiated Emission(30MHz-1GHz) / AC3

Instrument	Manufacturer	Model No.	Serial No.	Cal. Date	Next Cal. Date
EMI Test Receiver	R&S	ESCI	100573	2021.10.30	2022.10.29
Temperature/Humidity Meter	RTS	RTS-8S	AC2-TH	2021.10.08	2022.10.07
Coaxial Cable	Huber+Suhner	RG 214	AC2-C	2021.03.31	2022.03.30
Dekra test software	Dekra	-	-	-	-

Radiated Emission / AC5(1GHz-40GHz)

Instrument	Manufacturer	Model No.	Serial No.	Cal. Date	Next Cal. Date
Spectrum Analyzer	Agilent	E4446A	MY45300103	2021.05.06	2022.05.05
DRG Horn	ETS-Lindgren	3117	00123988	2021.10.22	2022.10.21
Temperature/Humidity Meter	Zhichen	ZC1-2	AC5-TH	2021.07.09	2022.07.08
Coaxial Cable	Huber+Suhner	SUCOFLEX 106	AC5-C2	2021.03.31	2022.03.30
Dekra test software	Dekra	-	-	-	-

UNCERTAINTY

Uncertainties have been calculated according to the DEKRA internal document. The reported expanded uncertainties are based on a standard uncertainty multiplied by a coverage factor of $k=2$, providing a level of confidence of approximately 95%. The Uncertainties is comply with standard required as below.

Test item	Uncertainty
AC Power Line Conducted Emission	9kHz~150kHz: 2.80 dB 150kHz~30MHz: 2.40 dB
Peak Power Output	± 1.27 dB
Radiated Emission(30MHz~1GHz)	Horizontal: 30MHz~200MHz: 3.50 dB 300MHz~1GHz: 3.60 dB Vertical: 30MHz~200MHz: 3.60 dB 300MHz~1GHz: 3.50 dB
Radiated Emission(1GHz~26.5GHz)	Horizontal: 1GHz~18GHz: 5.00 dB Vertical: 1GHz~18GHz: 4.80 dB
RF antenna conducted test	± 1.27 dB
Radiated Emission Band Edge	± 3.9 dB
DTS Bandwidth	± 150 Hz
Occupied Bandwidth	± 1 kHz
Power Density	± 1.27 dB

1 GENERAL INFORMATION

1.1 General Description of the Item(s)

Product Name	LED Device
Model No.	9290022891A
FCC ID.....	2AGBW9290022891AX
IC	20812-2891AX
Manufacturer	Signify (China) Investment Co., Ltd.
Manufacturer Address	Building no.9, Lane 888, Tianlin Road, Minhang District, Shanghai 200233, China

Wireless specification	Bluetooth 5.0					
Operating frequency range(s)	2400~2483.5MHz					
Type of Modulation	GFSK					
PHYs	<input checked="" type="checkbox"/>	LE 1M	<input checked="" type="checkbox"/>	LE 2M	<input checked="" type="checkbox"/>	LE Coded S=2/8
Data Rate	<input checked="" type="checkbox"/>	1Mbit/s	<input checked="" type="checkbox"/>	2Mbit/s	<input checked="" type="checkbox"/>	500/125 Kbit/s
Number of channel	40					

Rated power supply..... :	Voltage and Frequency					
	<input type="checkbox"/>	AC: 220 – 240 V, 50/60 Hz				
	<input checked="" type="checkbox"/>	AC: 100-125 V; 50/60 Hz;				
	<input type="checkbox"/>	DC: 3.2~4.2 Vdc				
	<input type="checkbox"/>	Battery:				
Mounting position	<input type="checkbox"/>	Table top equipment				
	<input type="checkbox"/>	Wall/Ceiling mounted equipment				
	<input type="checkbox"/>	Floor standing equipment				
	<input type="checkbox"/>	Head-mounted equipment				
	<input checked="" type="checkbox"/>	Other: Outdoor equipment				

1.2 Antenna Information

Antenna model / type number	N/A		
Antenna serial number	N/A		
Antenna Delivery	<input checked="" type="checkbox"/>	1TX + 1RX	
	<input type="checkbox"/>	2TX + 2RX	
Antenna technology.....	<input checked="" type="checkbox"/>	SISO	
	<input type="checkbox"/>	MIMO	<input type="checkbox"/> CDD
			<input type="checkbox"/> Beam-forming
Antenna Type	<input type="checkbox"/>	External	<input type="checkbox"/> Dipole
			<input type="checkbox"/> Sectorized
	<input checked="" type="checkbox"/>	Internal	<input type="checkbox"/> PIFA
			<input checked="" type="checkbox"/> PCB
			<input type="checkbox"/> Metal Monopole Antenna
			<input type="checkbox"/> Others.....
Antenna Gain	2.99 dBi		

1.3 Channel List

Bluetooth Working Frequency of Each Channel:							
Channel	Frequency	Channel	Frequency	Channel	Frequency	Channel	Frequency
00	2402 MHz	01	2404 MHz	02	2406 MHz	03	2408 MHz
04	2410 MHz	05	2412 MHz	06	2414 MHz	07	2416 MHz
08	2418 MHz	09	2420 MHz	10	2422 MHz	11	2424 MHz
12	2426 MHz	13	2428 MHz	14	2430 MHz	15	2432 MHz
16	2434 MHz	17	2436 MHz	18	2438 MHz	19	2440 MHz
20	2442 MHz	21	2444 MHz	22	2446 MHz	23	2448 MHz
24	2450 MHz	25	2452 MHz	26	2454 MHz	27	2456 MHz
28	2458 MHz	29	2460 MHz	30	2462 MHz	31	2464 MHz
32	2466 MHz	33	2468 MHz	34	2470 MHz	35	2472 MHz
36	2474 MHz	37	2476 MHz	38	2478 MHz	39	2480 MHz

2 DESCRIPTION OF TEST SETUP

2.1 Operating mode(s) used for tests

During the tests the following operating mode(s) has(have) been used.

Test Mode For Bluetooth	Mode1: Transmit by LE_1Mbps
	Mode2: Transmit by LE_2Mbps
	Mode3: Transmit by LE_Coded S=8
	Mode4: Transmit by LE_Coded S=2

2.2 Test Configuration / Block diagram used for tests

Test setup Diagram- AC Line Conducted Emission Test

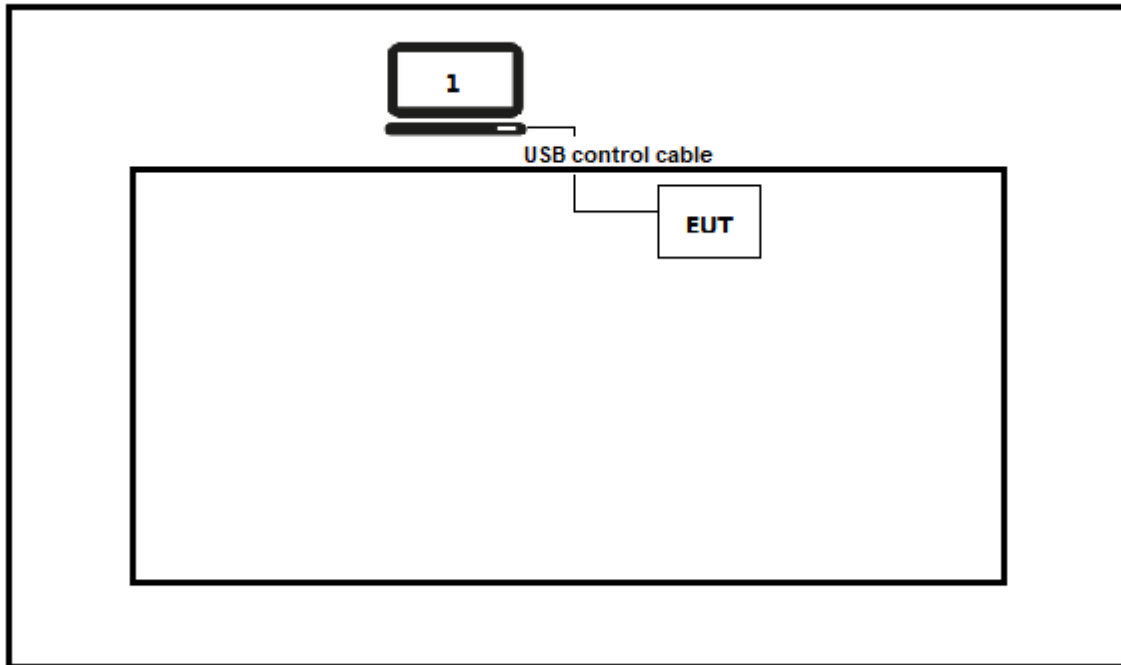

Test setup Diagram- Radiated Emission

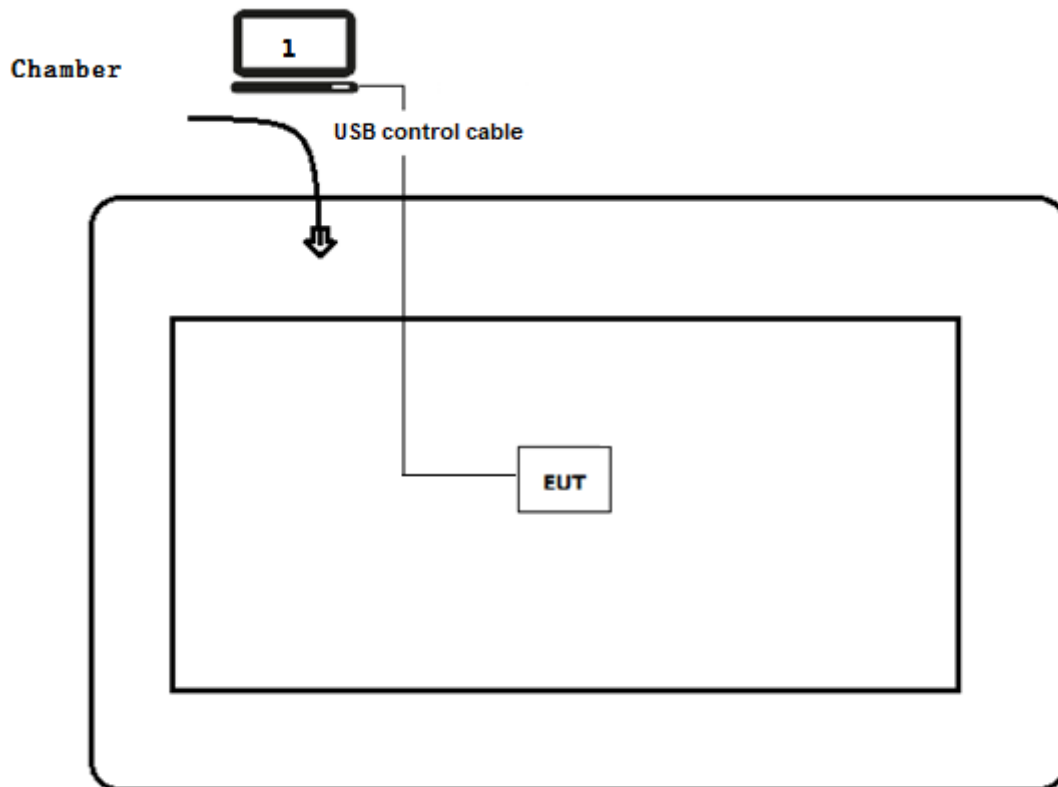

2.3 Testing process

1	Setup the EUT as shown in Section 2.2.
2	Verify that the EUT works properly.

3 VERDICT SUMMARY SECTION

This chapter presents an overview of standards and results. Refer to the next chapters for details of measured test results and applied test levels.

3.1 Standards

Standard	Year	Description
FCC CFR Title 47 Part 15 Subpart C Section 15.247	2019	Operation within the bands 902–928 MHz, 2400–2483.5 MHz, and 5725–5850 MHz.
ANSI C63.10	2013	American National Standard of Procedures for Compliance Testing of Unlicensed Wireless Devices
KDB 558074 D01 v05r02	2019	Guidance for performing compliance measurements on Digital Transmission System (DTS) operating under section 15.247
RSS-Gen Issue 5 Amendment 1	2019	General Requirements for Compliance of Radio Apparatus
RSS-247 Issue 2	2017	Digital Transmission Systems (DTSs), Frequency Hopping Systems (FHSs) and Licence-Exempt Local Area Network (LE-LAN) Devices

3.2 Deviation(s) from the Standard(s) / Test Specification(s)

The following deviation(s) was / were made from the published requirements of the listed standards: N/A.

(Please define the deviations from the standard(s) if applicable)

3.3 Overview of results

For FCC

Requirement – Test case	Basic standard(s)	Verdict	Remark
AC Power Line Conducted Emission	FCC 15.207	PASS	---
Emissions in restricted frequency bands	FCC 15.247(b)(3)	PASS	---
Duty cycle	ANSI C63.10:2013	PASS	---
Emissions in non-restricted frequency bands	FCC 15.247(d), FCC 15.209	PASS	---
Radiated Emission Band Edge	FCC 15.247(d)	PASS	---
Fundamental emission output power	FCC 15.247(d), FCC 15.209	PASS	---
DTS Bandwidth	FCC 15.247(a)(2)	PASS	---
Power Spectral Density	FCC 15.247(e)	PASS	---
Antenna Requirement	FCC 15.203	PASS	---

For ISED

Requirement – Test case	Basic standard(s)	Verdict	Remark
AC Power Line Conducted Emission	RSS-Gen Issue 5 Section 8.8	PASS	---
Emissions in restricted frequency bands	RSS-Gen Issue 5 Section 8.9	PASS	---
Duty cycle	ANSI C63.10:2013	PASS	---
Emissions in non-restricted frequency bands	RSS-247 Issue 2 Section 5.5	PASS	---
Radiated Emission Band Edge	RSS-Gen Issue 5 Section 8.10	PASS	---
Fundamental emission output power	RSS-247 Issue 2 Section 5.4(d)	PASS	---
DTS Bandwidth	RSS-Gen Issue 5 Section 6.7	PASS	---
Power Spectral Density	RSS-247 Issue 2 Section 5.2(b)	PASS	---
Antenna Requirement	RSS-Gen Issue 5 Section 6.8	PASS	---

3.4 Test Facility

USA	:	FCC Designation Number: CN1199
CA	:	ISED CAB identifier: CN0040

4 TEST RESULTS

4.1 AC Power Line Conducted Emission	VERDICT: PASS
---	----------------------

4.1.1 Limit		
Standard	FCC Part 15 Subpart C Paragraph 15.207	
Frequency range [MHz]	Limit: QP [dB(μV) ¹⁾]	Limit: AV [dB(μV) ¹⁾]
0,15 - 0,50	66 - 56 ²⁾	56 - 46 ²⁾
0,50 - 5,0	56	46
5,0 - 30	60	50
<p>¹⁾ At the transition frequency, the lower limit applies.</p> <p>²⁾ The limit decreases linearly with the logarithm of the frequency.</p> <p>NOTE 1: The exclusion band for transmitters shall be considered for transmitters operating at frequencies below 30 MHz.</p> <p>NOTE 2: Where the AC output port is directly connected (or via a circuit breaker) to the AC power input port of the EUT the AC power output port need not to be tested.</p>		

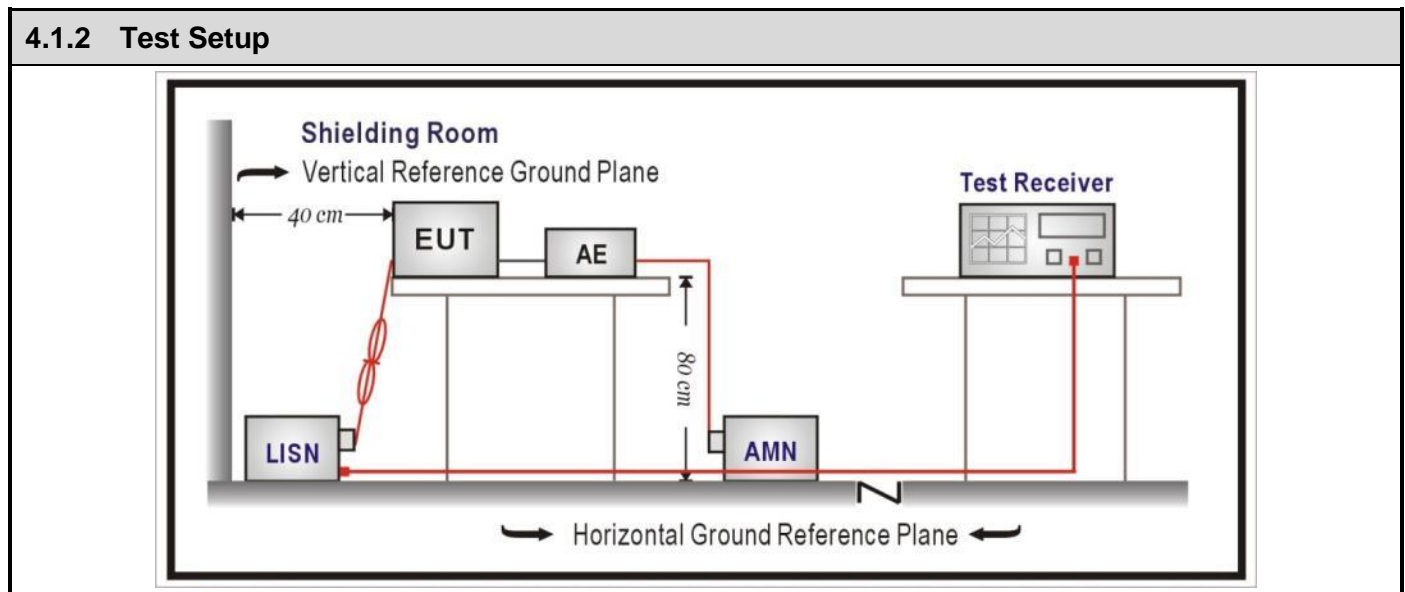

4.1.3 Test Procedure			
	References Rule	Chapter	Item
<input checked="" type="checkbox"/>	ANSI C63.10-2013	6.2	Standard test method for ac power-line conducted emissions from unlicensed wireless devices

4.1.4 Test Data

Profile: 21C0118R	Page No.: 17
Engineer: Tim.Cao	
Site: TR1	Time: 2021/12/08 - 02:17
Limit: FCC_Part15.107_CE_AC Power_ClassB	Margin: 0
Probe: ENV216_101190(0.009-30MHz)	Polarity: Line
EUT: LED device	Power: AC 120V/60Hz
Note: Mode: Model1	

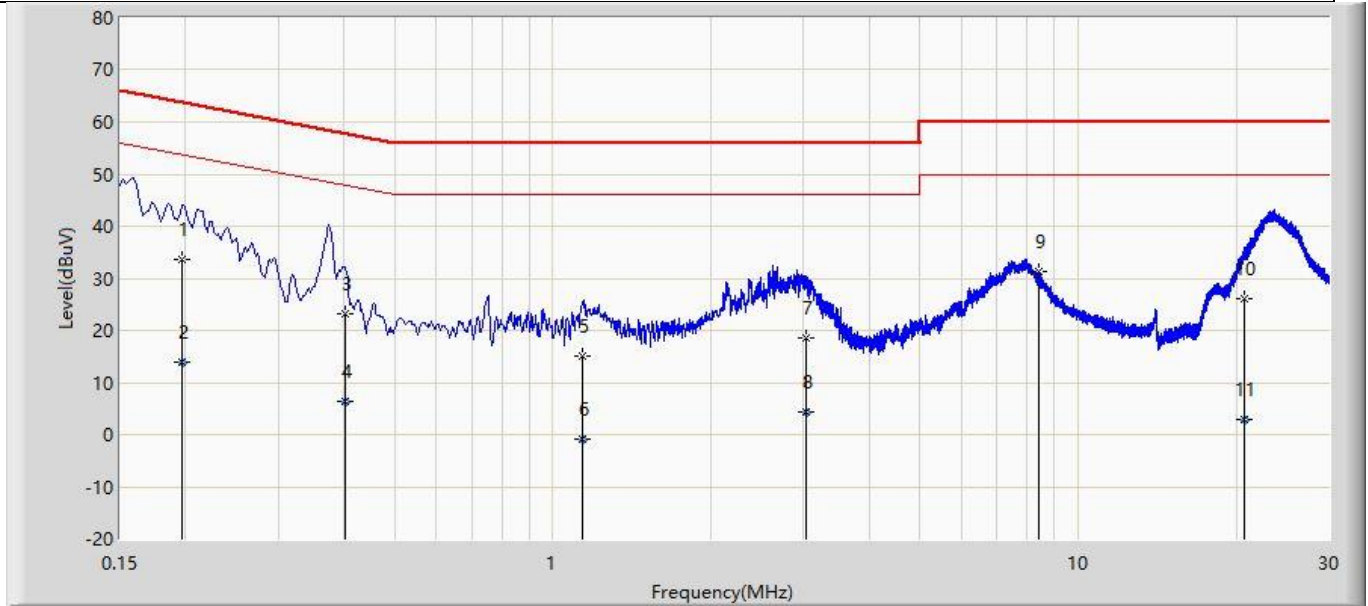

No	Mark	Frequency (MHz)	Measure Level (dBuV)	Reading Level (dBuV)	Over Limit (dB)	Limit (dBuV)	Factor (dB)	Type
1		0.197	33.528	23.843	-30.197	63.726	9.685	QP
2		0.197	13.850	4.165	-39.875	53.726	9.685	AV
3		0.402	23.299	13.513	-34.513	57.812	9.786	QP
4		0.402	6.335	-3.451	-41.477	47.812	9.786	AV
5		1.138	15.060	5.081	-40.940	56.000	9.979	QP
6		1.138	-0.915	-10.894	-46.915	46.000	9.979	AV
7		3.037	18.606	8.528	-37.394	56.000	10.077	QP
8		3.037	4.410	-5.668	-41.590	46.000	10.077	AV
9	*	8.419	31.327	21.040	-28.673	60.000	10.287	QP
10		20.744	26.079	15.477	-33.921	60.000	10.602	QP
11		20.744	2.783	-7.818	-47.217	50.000	10.602	AV

Note:

1. " * ", means this data is the worst emission level.
2. Measurement Level = Reading Level + Factor(Probe+Cable-Amp).

Profile: 21C0118R	Page No.: 18
Engineer: Tim.Cao	
Site: TR1	Time: 2021/12/08 - 02:20
Limit: FCC_Part15.107_CE_AC Power_ClassB	Margin: 0
Probe: ENV216_101190(0.009-30MHz)	Polarity: Neutral
EUT: LED device	Power: AC 120V/60Hz
Note: Mode: Model1	

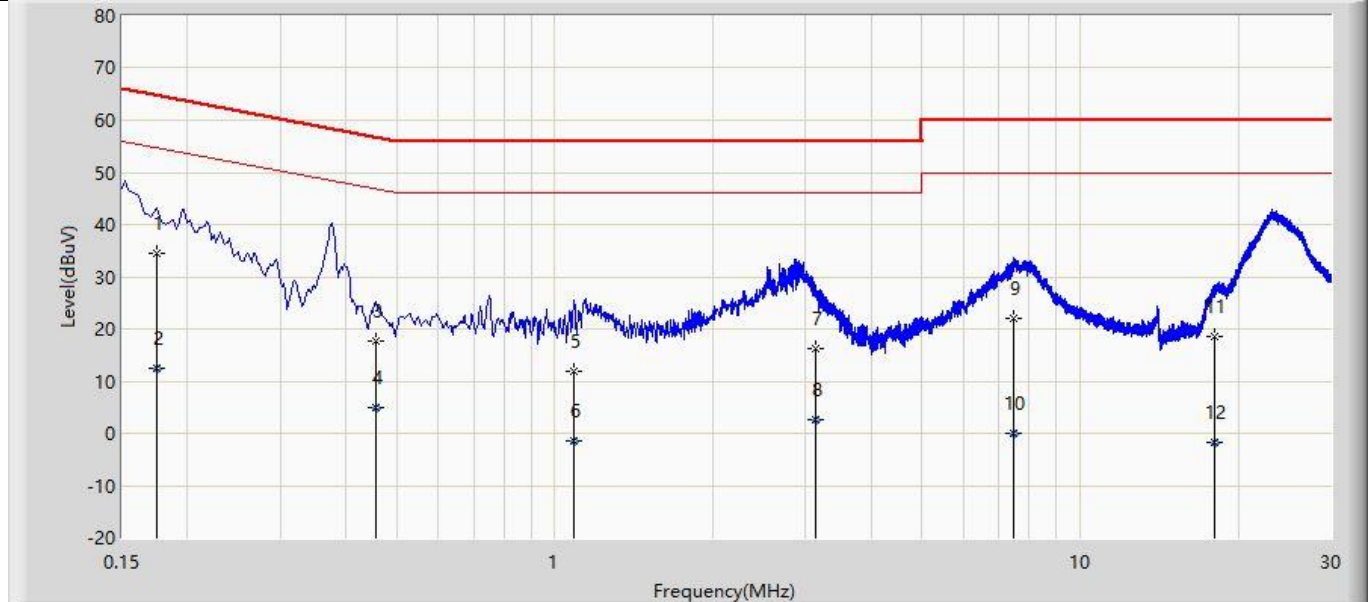

No	Mark	Frequency (MHz)	Measure Level (dBuV)	Reading Level (dBuV)	Over Limit (dB)	Limit (dBuV)	Factor (dB)	Type
1	*	0.175	34.522	24.852	-30.210	64.732	9.670	QP
2		0.175	12.366	2.696	-42.366	54.732	9.670	AV
3		0.456	17.695	7.884	-39.070	56.765	9.811	QP
4		0.456	4.854	-4.957	-41.911	46.765	9.811	AV
5		1.086	11.827	1.853	-44.173	56.000	9.974	QP
6		1.086	-1.446	-11.420	-47.446	46.000	9.974	AV
7		3.143	16.135	6.056	-39.865	56.000	10.080	QP
8		3.143	2.645	-7.435	-43.355	46.000	10.080	AV
9		7.485	22.145	11.897	-37.855	60.000	10.249	QP
10		7.485	0.042	-10.207	-49.958	50.000	10.249	AV
11		18.017	18.688	8.141	-41.312	60.000	10.547	QP
12		18.017	-1.624	-12.172	-51.624	50.000	10.547	AV

Note:

1. " * ", means this data is the worst emission level.
2. Measurement Level = Reading Level + Factor(Probe+Cable-Amp).

4.2 Emissions in restricted frequency bands	VERDICT: PASS
--	----------------------

4.2.1 Limit

Standard	FCC Part 15 Subpart C Paragraph 15.209
-----------------	--

Restricted Bands of operation

Frequency (MHz)	Frequency (MHz)	Frequency (MHz)	Frequency (GHz)
0.090 – 0.110	16.42 – 16.423	399.9 – 410	4.5 – 5.15
0.495 – 0.505	16.69475 – 16.69525	608 – 614	5.35 – 5.46
2.1735 – 2.1905	16.80425 – 16.80475	960 – 1240	7.25 – 7.75
4.125 – 4.128	25.5 – 25.67	1300 – 1427	8.025 – 8.5
4.17725 – 4.17775	37.5 – 38.25	1435 – 1626.5	9.0 – 9.2
4.20725 – 4.20775	73 – 74.6	1645.5 – 1646.5	9.3 – 9.5
6.215 – 6.218	74.8 – 75.2	1660 – 1710	10.6 – 12.7
6.26775 – 6.26825	108 – 121.94	1718.8 – 1722.2	13.25 – 13.4
6.31175 – 6.31225	123 – 138	2200 – 2300	14.47 – 14.5
8.291 – 8.294	149.9 – 150.05	2310 – 2390	15.35 – 16.2
8.362 – 8.366	156.52475 – 156.52525	2483.5 – 2500	17.7 – 21.4
8.37625 – 8.38675	156.7 – 156.9	2690 – 2900	22.01 – 23.12
8.81425 – 8.81475	162.0125 – 167.17	3260 – 3267	23.6 – 24.0
12.29 – 12.293	167.72 – 173.2	3332 – 3339	31.2 – 31.8
12.51975 – 12.52025	240 – 285	3345.8 – 3358	36.43 – 36.5
12.57675 – 12.57725	322 – 335.4	3600 – 4400	
13.36 – 13.41			

Restricted Bands of operation for IC

0.090 - 0.110	13.36 - 13.41	960 - 1427	9.0 - 9.2
0.495 - 0.505	16.42 - 16.423	1435 - 1626.5	9.3 - 9.5
2.1735 - 2.1905	16.69475 - 16.69525	1645.5 - 1646.5	10.6 - 12.7
3.020 - 3.026	16.80425 - 16.80475	1660 - 1710	13.25 - 13.4
4.125 - 4.128	25.5 - 25.67	1718.8 - 1722.2	14.47 - 14.5
4.17725 - 4.17775	37.5 - 38.25	2200 - 2300	15.35 - 16.2
4.20725 - 4.20775	73 - 74.6	2310 - 2390	17.7 - 21.4
5.677 - 5.683	74.8 - 75.2	2483.5 - 2500	22.01 - 23.12
6.215 - 6.218	108 - 138	2655 - 2900	23.6 - 24.0
6.26775 - 6.26825	149.9 - 150.05	3260 - 3267	31.2 - 31.8
6.31175 - 6.31225	156.52475 - 156.52525	3332 - 3339	36.43 - 36.5
8.291 - 8.294	156.7 - 156.9	3345.8 - 3358	Above 38.6
8.362 - 8.366	162.0125 - 167.17	3500 - 4400	
8.37625 - 8.38675	167.72 - 173.2	4500 - 5150	
8.41425 - 8.41475	240 - 285	5350 - 5460	
12.29 - 12.293	322 - 335.4	7250 - 7750	
12.51975 - 12.52025	399.9 - 410	8025 - 8500	
12.57675 - 12.57725	608 - 614	--	

Restricted Band Emissions Limit			
Frequency (MHz)	Field strength ($\mu\text{V/m}$)	Field strength ($\text{dB}\mu\text{V/m}$)	Measurement distance (m)
0.009 - 0.49	2400/F(kHz)	48.5 – 13.8	300 _(Note 1)
0.49 - 1.705	24000/F(kHz)	33.8 - 23	30 _(Note 1)
1.705 - 30	30	29.5	30 _(Note 1)
30 - 88	100	40	3 _(Note 2)
88 - 216	150	43.5	3 _(Note 2)
216 - 960	200	46	3 _(Note 2)
Above 960	500	54	3 _(Note 2)

Note 1: At frequencies below 30 MHz, measurements may be performed at a distance closer than that specified in the regulations; however, an attempt should be made to avoid making measurements in the near field. Pending the development of an appropriate measurement procedure for measurements performed below 30 MHz, when performing measurements at a closer distance than specified, the results shall be extrapolated to the specified distance by either making measurements at a minimum of two distances on at least one radial to determine the proper extrapolation factor or by using the square of an inverse linear distance extrapolation factor (40 dB/decade).

Note 2: At frequencies at or above 30 MHz, measurements may be performed at a distance other than what is specified provided: measurements are not made in the near field except where it can be shown that near field measurements are appropriate due to the characteristics of the device; and it can be demonstrated that the signal levels needed to be measured at the distance employed can be detected by the measurement equipment.

Measurements shall not be performed at a distance greater than 30 meters unless it can be further demonstrated that measurements at a distance of 30 meters or less are impractical. When performing measurements at a distance other than that specified, the results shall be extrapolated to the specified distance using an extrapolation factor of 20 dB/decade (inverse linear-distance for field strength measurements; inverse-linear-distance-squared for power density measurements).

4.2.2 Test Setup

30MHz-1GHz Test Setup:

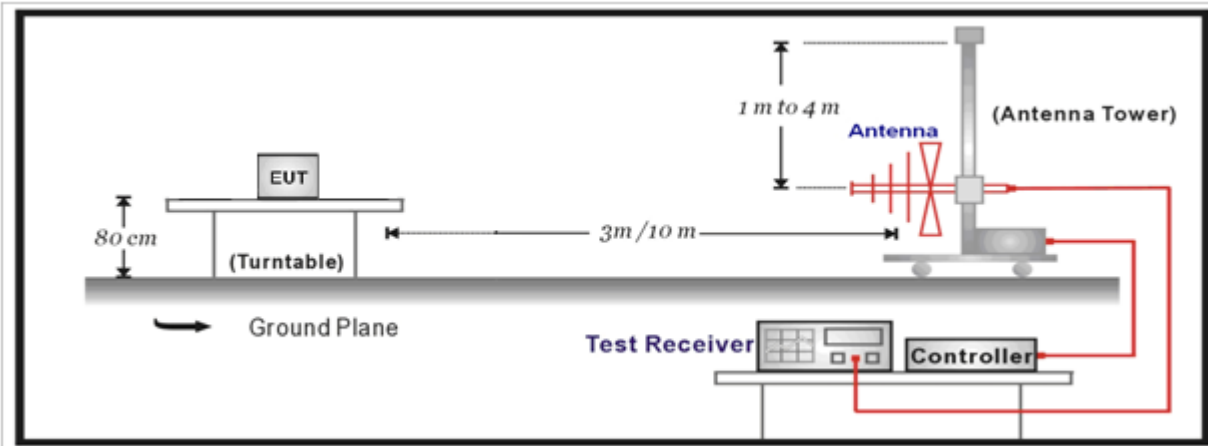

Above 1GHz Test Setup:

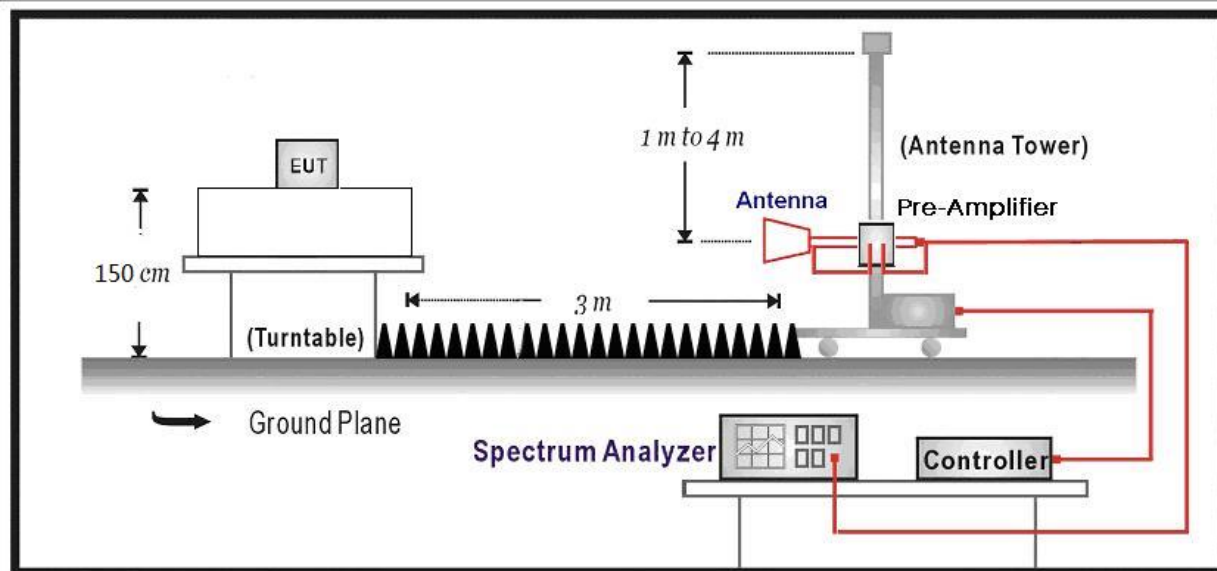

4.2.3 Test Procedure

References Rule	Chapter	Description
<input checked="" type="checkbox"/> ANSI C63.10	11.12	Emissions in restricted frequency bands
<input checked="" type="checkbox"/> ANSI C63.10	11.12.1	Radiated emission measurements
<input checked="" type="checkbox"/> ANSI C63.10	11.12.2.7	Radiated spurious emission test
<input checked="" type="checkbox"/> ANSI C63.10	6.4	Radiated emissions from unlicensed wireless devices below 30 MHz
<input checked="" type="checkbox"/> ANSI C63.10	6.5	Radiated emissions from unlicensed wireless devices in the frequency range of 30 MHz to 1000 MHz
<input checked="" type="checkbox"/> ANSI C63.10	6.6	Radiated emissions from unlicensed wireless devices above 1 GHz

4.2.4 Test Data

Profile: 21C0118R	Page No.: 31
Engineer: Neil	
Site: AC5	Time: 2021/12/07 - 23:27
Limit: FCC_Part15.209_RE(3m)	Margin: 0
Probe: Horn_3117_00123988_(1-18GHz)	Polarity: Horizontal
EUT: LED DEVICE	Power: AC 120V/60Hz
Note: Mode 1:Transmit at 2402MHz by BLE	

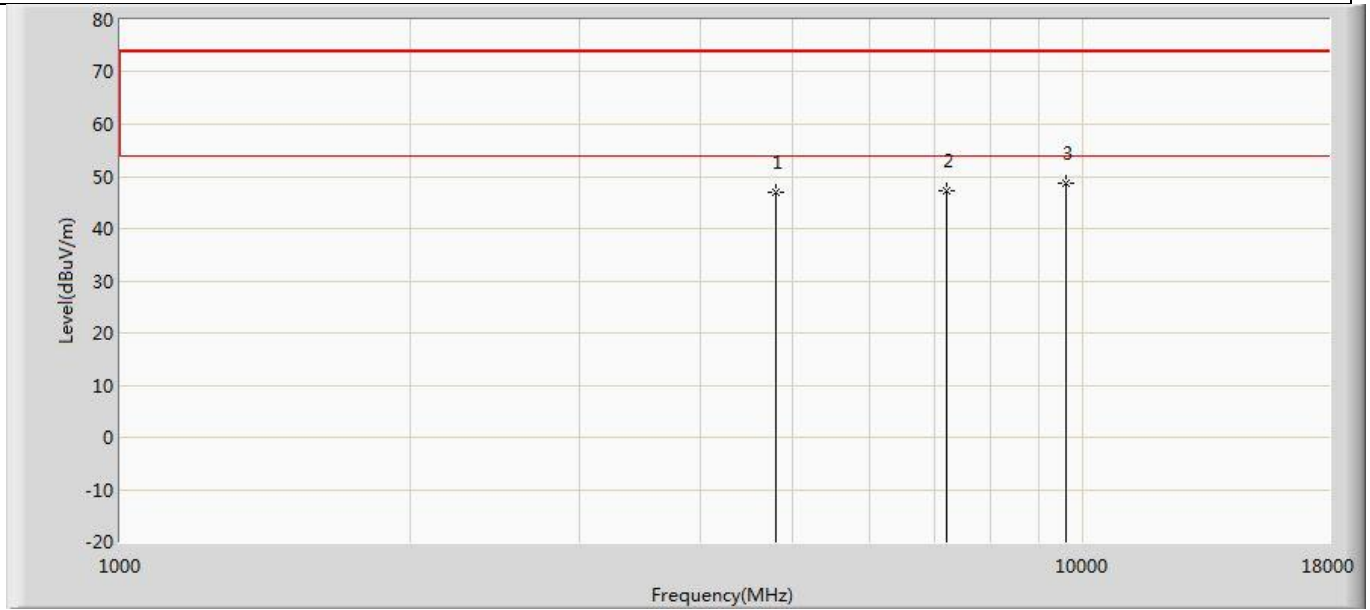

No	Mark	Frequency (MHz)	Measure Level (dBuV/m)	Reading Level (dBuV)	Over Limit (dB)	Limit (dBuV/m)	Factor (dB)	Type
1		4804.000	46.865	41.243	-27.135	74.000	5.621	PK
2		7206.000	47.149	38.081	-26.851	74.000	9.068	PK
3	*	9608.000	48.759	35.674	-25.241	74.000	13.084	PK

Profile: 21C0118R	Page No.: 32
Engineer: Neil	
Site: AC5	Time: 2021/12/07 - 23:28
Limit: FCC_Part15.209_RE(3m)	Margin: 0
Probe: Horn_3117_00123988_(1-18GHz)	Polarity: Vertical
EUT: LED DEVICE	Power: AC 120V/60Hz
Note: Mode 1:Transmit at 2402MHz by BLE	

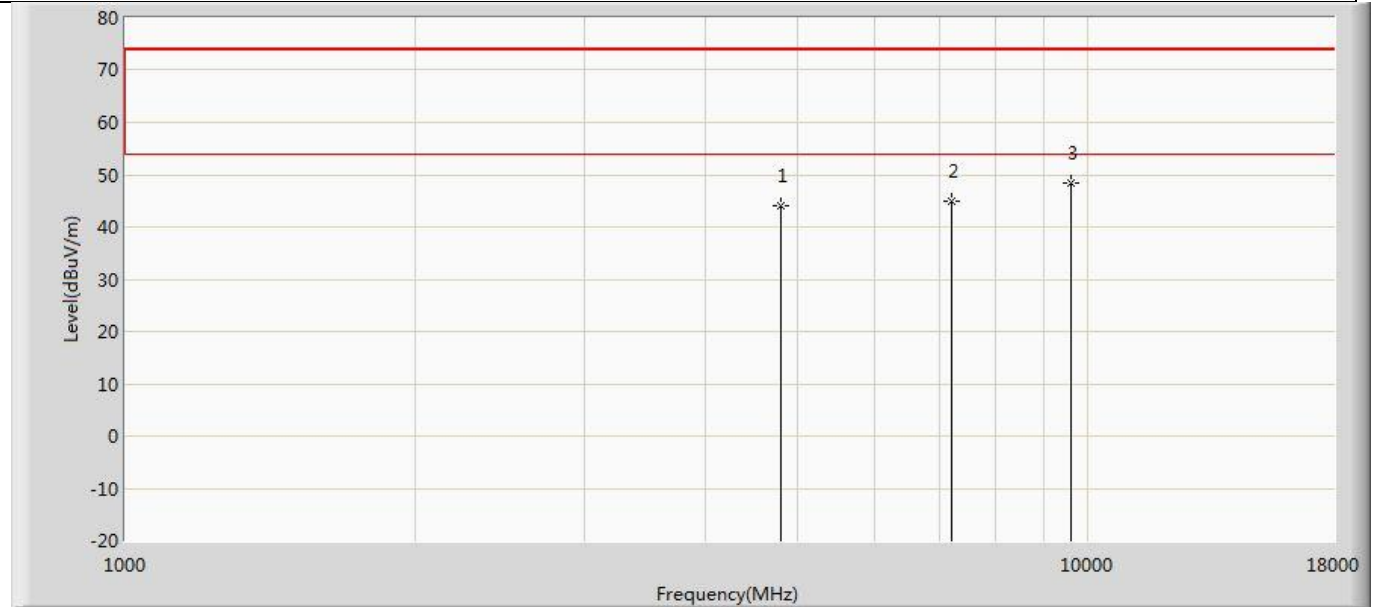

No	Mark	Frequency (MHz)	Measure Level (dBuV/m)	Reading Level (dBuV)	Over Limit (dB)	Limit (dBuV/m)	Factor (dB)	Type
1		4804.000	44.129	38.507	-29.871	74.000	5.621	PK
2		7206.000	45.040	35.972	-28.960	74.000	9.068	PK
3	*	9608.000	48.362	35.277	-25.638	74.000	13.084	PK

Profile: 21C0118R	Page No.: 33
Engineer: Neil	
Site: AC5	Time: 2021/12/07 - 23:28
Limit: FCC_Part15.209_RE(3m)	Margin: 0
Probe: Horn_3117_00123988_(1-18GHz)	Polarity: Horizontal
EUT: LED DEVICE	Power: AC 120V/60Hz
Note: Mode 1:Transmit at 2440MHz by BLE	

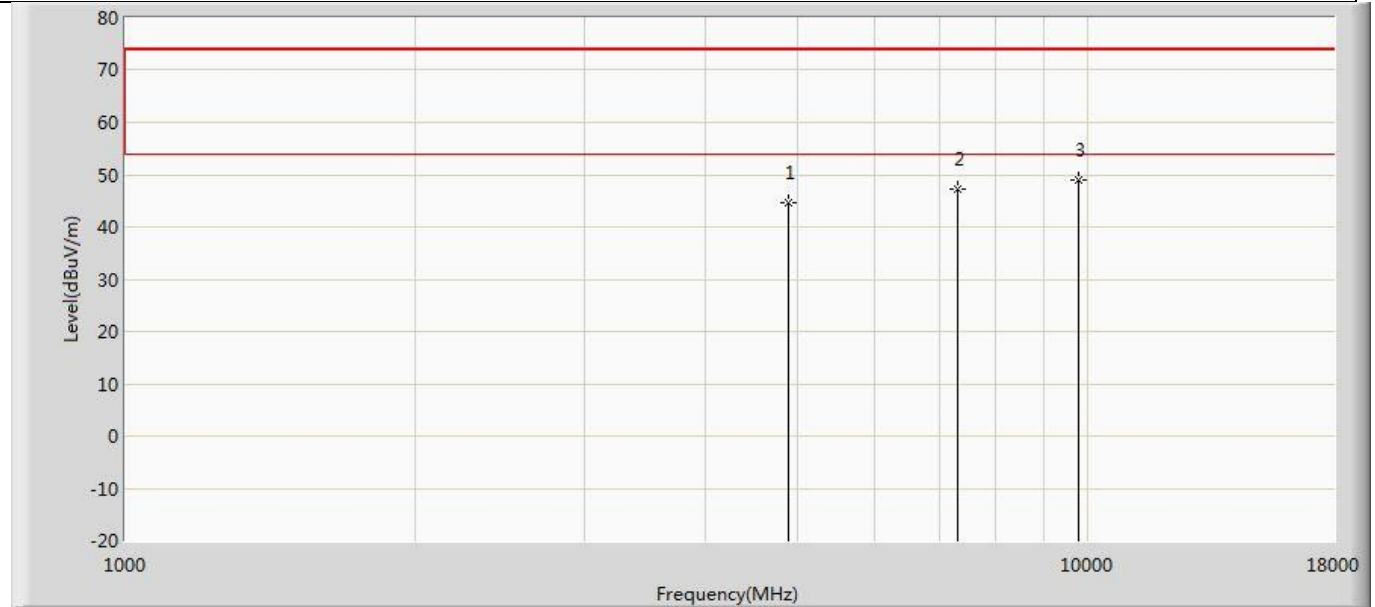

No	Mark	Frequency (MHz)	Measure Level (dBuV/m)	Reading Level (dBuV)	Over Limit (dB)	Limit (dBuV/m)	Factor (dB)	Type
1		4880.000	44.693	38.774	-29.307	74.000	5.919	PK
2		7320.000	47.116	37.610	-26.884	74.000	9.506	PK
3	*	9760.000	49.033	35.979	-24.967	74.000	13.054	PK

Profile: 21C0118R	Page No.: 34
Engineer: Neil	
Site: AC5	Time: 2021/12/07 - 23:28
Limit: FCC_Part15.209_RE(3m)	Margin: 0
Probe: Horn_3117_00123988_(1-18GHz)	Polarity: Vertical
EUT: LED DEVICE	Power: AC 120V/60Hz
Note: Mode 1:Transmit at 2440MHz by BLE	

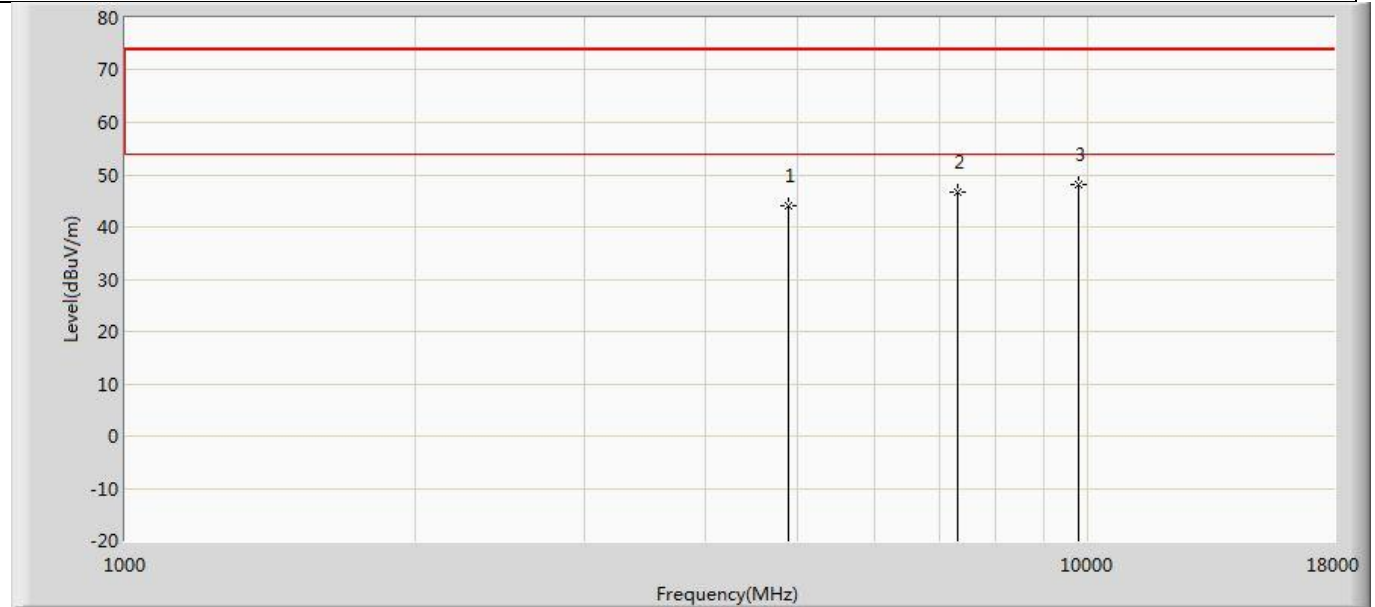

No	Mark	Frequency (MHz)	Measure Level (dBuV/m)	Reading Level (dBuV)	Over Limit (dB)	Limit (dBuV/m)	Factor (dB)	Type
1		4880.000	43.944	38.025	-30.056	74.000	5.919	PK
2		7320.000	46.747	37.241	-27.253	74.000	9.506	PK
3	*	9760.000	48.119	35.065	-25.881	74.000	13.054	PK

Profile: 21C0118R	Page No.: 35
Engineer: Neil	
Site: AC5	Time: 2021/12/07 - 23:28
Limit: FCC_Part15.209_RE(3m)	Margin: 0
Probe: Horn_3117_00123988_(1-18GHz)	Polarity: Horizontal
EUT: LED DEVICE	Power: AC 120V/60Hz
Note: Mode 1:Transmit at 2480MHz by BLE	

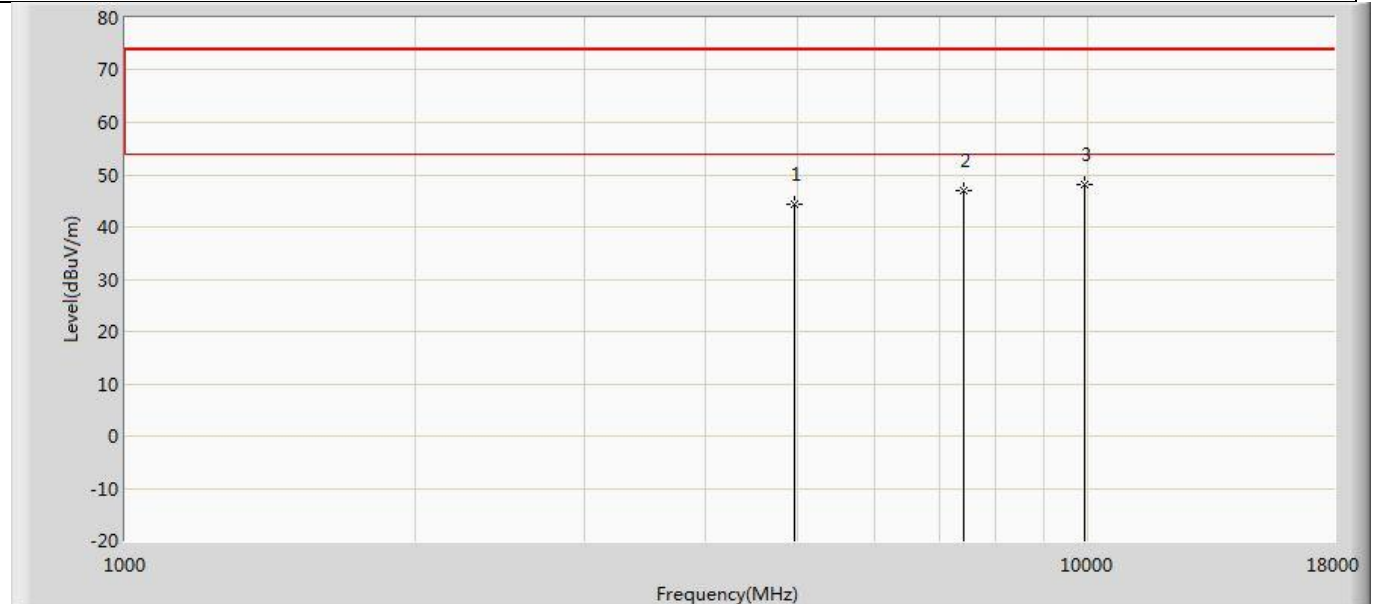

No	Mark	Frequency (MHz)	Measure Level (dBuV/m)	Reading Level (dBuV)	Over Limit (dB)	Limit (dBuV/m)	Factor (dB)	Type
1		4960.000	44.427	38.449	-29.573	74.000	5.978	PK
2		7440.000	46.853	37.326	-27.147	74.000	9.526	PK
3	*	9920.000	48.075	35.088	-25.925	74.000	12.986	PK

Profile: 21C0118R	Page No.: 36
Engineer: Neil	
Site: AC5	Time: 2021/12/07 - 23:28
Limit: FCC_Part15.209_RE(3m)	Margin: 0
Probe: Horn_3117_00123988_(1-18GHz)	Polarity: Vertical
EUT: LED DEVICE	Power: AC 120V/60Hz
Note: Mode 1:Transmit at 2480MHz by BLE	

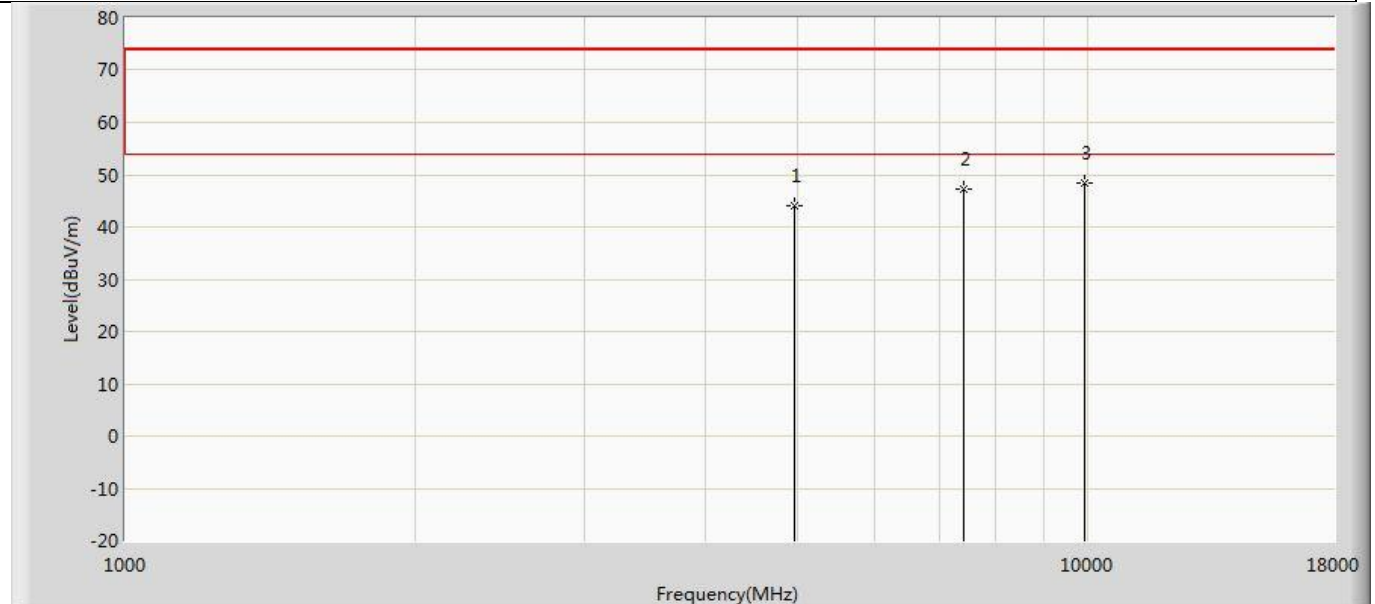

No	Mark	Frequency (MHz)	Measure Level (dBuV/m)	Reading Level (dBuV)	Over Limit (dB)	Limit (dBuV/m)	Factor (dB)	Type
1		4960.000	44.067	38.089	-29.933	74.000	5.978	PK
2		7440.000	47.147	37.620	-26.853	74.000	9.526	PK
3	*	9920.000	48.520	35.533	-25.480	74.000	12.986	PK

Profile: 21C0118R	Page No.: 37
Engineer: Neil	
Site: AC5	Time: 2021/12/07 - 23:28
Limit: FCC_Part15.209_RE(3m)	Margin: 0
Probe: Horn_3117_00123988_(1-18GHz)	Polarity: Horizontal
EUT: LED DEVICE	Power: AC 120V/60Hz
Note: Mode 2:Transmit at 2402MHz by 2LE	

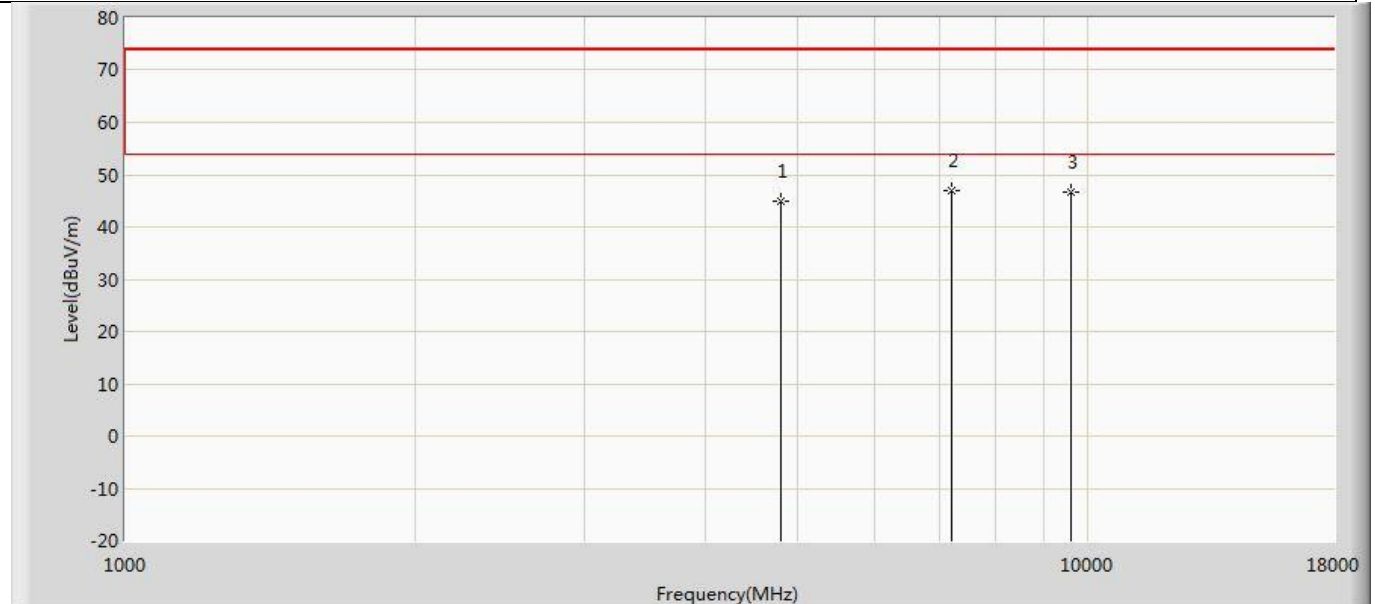

No	Mark	Frequency (MHz)	Measure Level (dBuV/m)	Reading Level (dBuV)	Over Limit (dB)	Limit (dBuV/m)	Factor (dB)	Type
1		4804.000	44.792	39.170	-29.208	74.000	5.621	PK
2	*	7206.000	47.095	38.027	-26.905	74.000	9.068	PK
3		9608.000	46.768	33.683	-27.232	74.000	13.084	PK

Profile: 21C0118R	Page No.: 38
Engineer: Neil	
Site: AC5	Time: 2021/12/07 - 23:28
Limit: FCC_Part15.209_RE(3m)	Margin: 0
Probe: Horn_3117_00123988_(1-18GHz)	Polarity: Vertical
EUT: LED DEVICE	Power: AC 120V/60Hz
Note: Mode 2:Transmit at 2402MHz by 2LE	

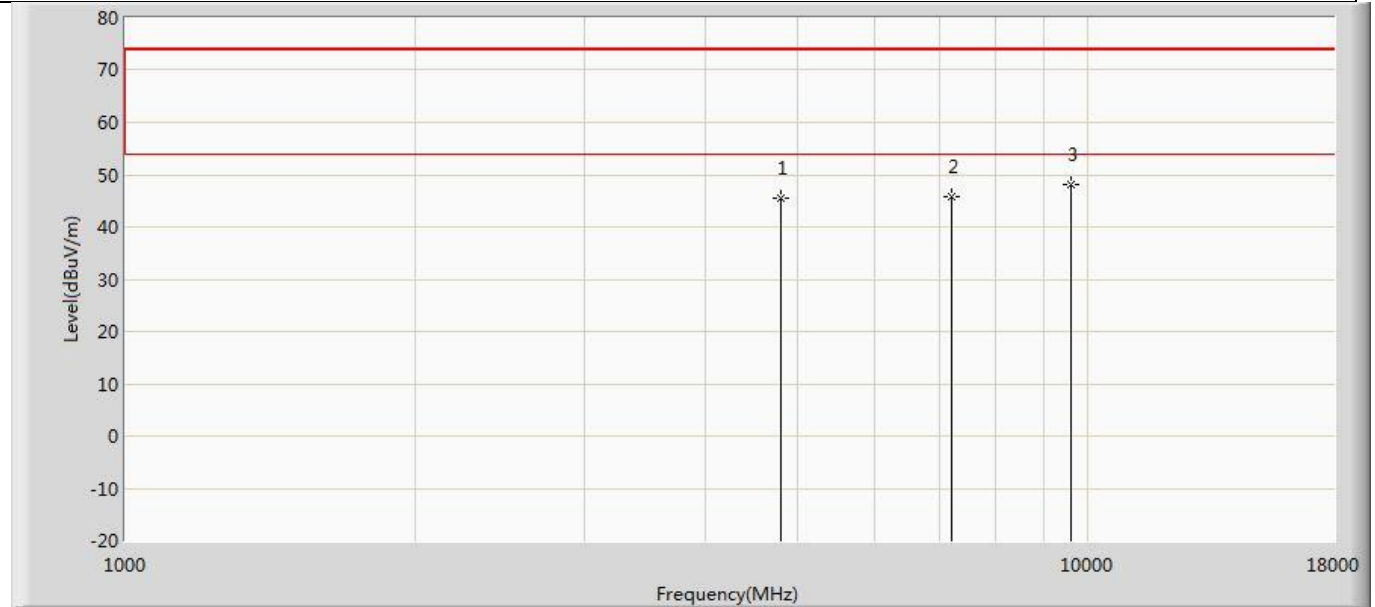

No	Mark	Frequency (MHz)	Measure Level (dBuV/m)	Reading Level (dBuV)	Over Limit (dB)	Limit (dBuV/m)	Factor (dB)	Type
1		4804.000	45.519	39.897	-28.481	74.000	5.621	PK
2		7206.000	45.893	36.825	-28.107	74.000	9.068	PK
3	*	9608.000	48.133	35.048	-25.867	74.000	13.084	PK

Profile: 21C0118R	Page No.: 39
Engineer: Neil	
Site: AC5	Time: 2021/12/07 - 23:28
Limit: FCC_Part15.209_RE(3m)	Margin: 0
Probe: Horn_3117_00123988_(1-18GHz)	Polarity: Horizontal
EUT: LED DEVICE	Power: AC 120V/60Hz
Note: Mode 2:Transmit at 2440MHz by 2LE	

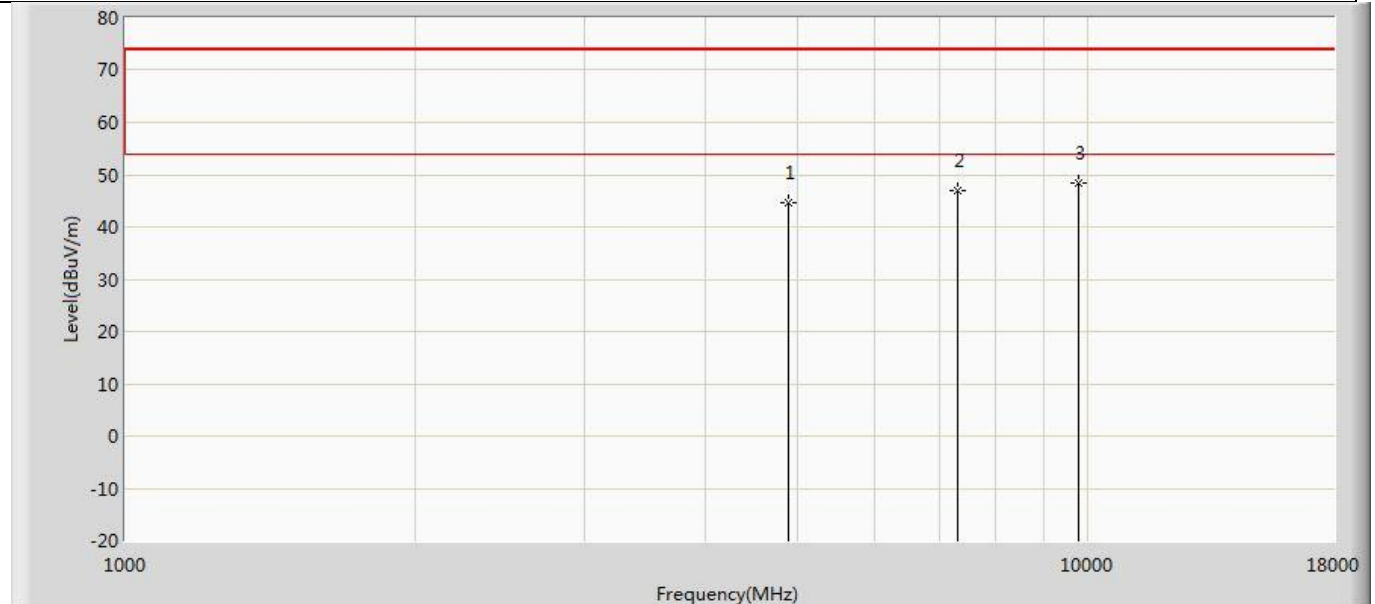

No	Mark	Frequency (MHz)	Measure Level (dBuV/m)	Reading Level (dBuV)	Over Limit (dB)	Limit (dBuV/m)	Factor (dB)	Type
1		4880.000	44.753	38.834	-29.247	74.000	5.919	PK
2		7320.000	47.032	37.526	-26.968	74.000	9.506	PK
3	*	9760.000	48.536	35.482	-25.464	74.000	13.054	PK

Profile: 21C0118R	Page No.: 40
Engineer: Neil	
Site: AC5	Time: 2021/12/07 - 23:28
Limit: FCC_Part15.209_RE(3m)	Margin: 0
Probe: Horn_3117_00123988_(1-18GHz)	Polarity: Vertical
EUT: LED DEVICE	Power: AC 120V/60Hz
Note: Mode 2:Transmit at 2440MHz by 2LE	

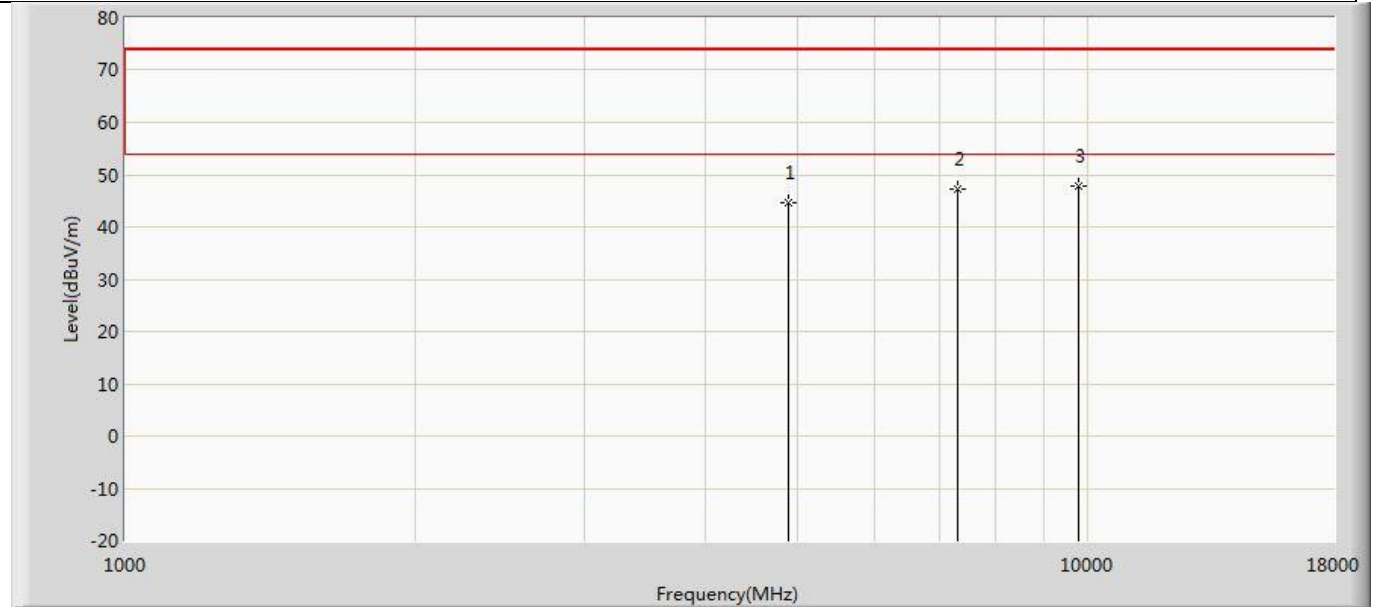

No	Mark	Frequency (MHz)	Measure Level (dBuV/m)	Reading Level (dBuV)	Over Limit (dB)	Limit (dBuV/m)	Factor (dB)	Type
1		4880.000	44.529	38.610	-29.471	74.000	5.919	PK
2		7320.000	47.143	37.637	-26.857	74.000	9.506	PK
3	*	9760.000	47.799	34.745	-26.201	74.000	13.054	PK

Profile: 21C0118R	Page No.: 41
Engineer: Neil	
Site: AC5	Time: 2021/12/07 - 23:28
Limit: FCC_Part15.209_RE(3m)	Margin: 0
Probe: Horn_3117_00123988_(1-18GHz)	Polarity: Horizontal
EUT: LED DEVICE	Power: AC 120V/60Hz
Note: Mode 2:Transmit at 2480MHz by 2LE	

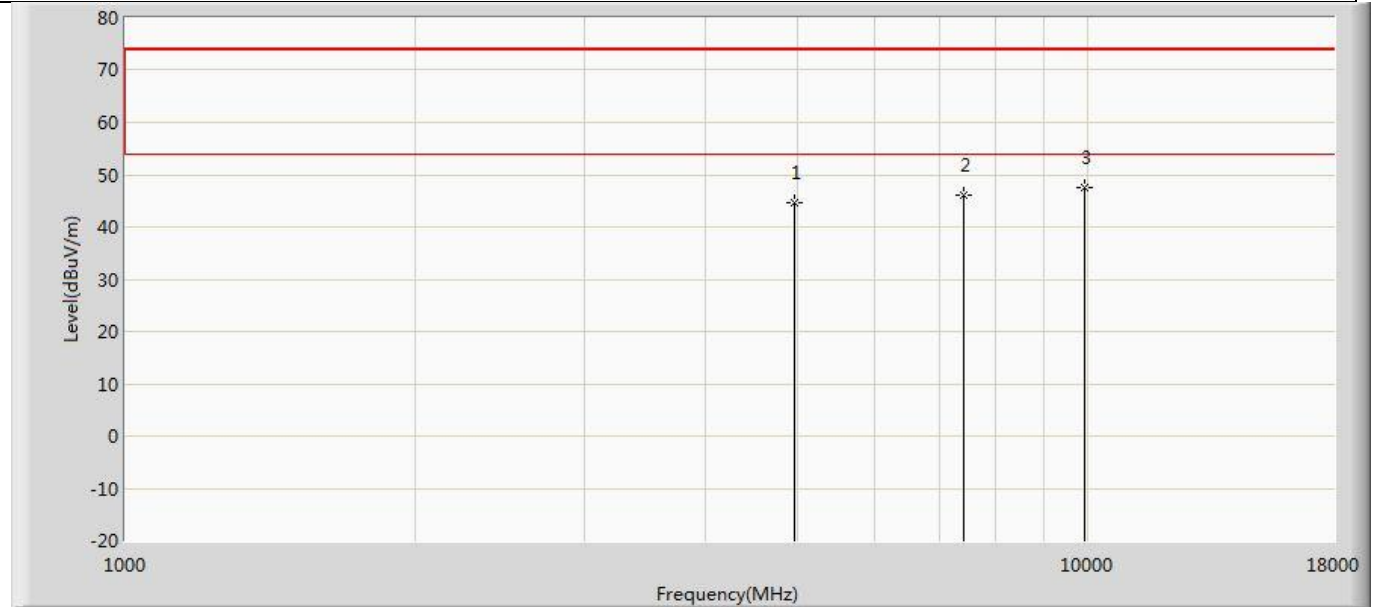

No	Mark	Frequency (MHz)	Measure Level (dBuV/m)	Reading Level (dBuV)	Over Limit (dB)	Limit (dBuV/m)	Factor (dB)	Type
1		4960.000	44.713	38.735	-29.287	74.000	5.978	PK
2		7440.000	46.217	36.690	-27.783	74.000	9.526	PK
3	*	9920.000	47.529	34.542	-26.471	74.000	12.986	PK

Profile: 21C0118R	Page No.: 42
Engineer: Neil	
Site: AC5	Time: 2021/12/07 - 23:28
Limit: FCC_Part15.209_RE(3m)	Margin: 0
Probe: Horn_3117_00123988_(1-18GHz)	Polarity: Vertical
EUT: LED DEVICE	Power: AC 120V/60Hz
Note: Mode 2:Transmit at 2480MHz by 2LE	

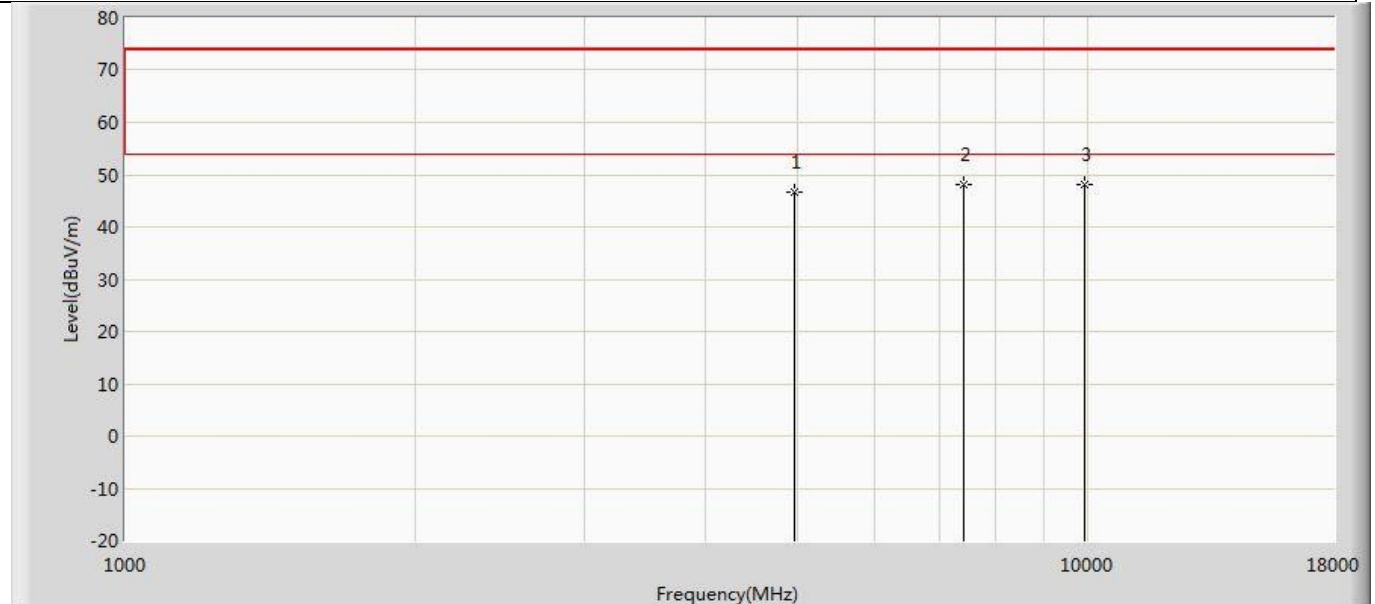

No	Mark	Frequency (MHz)	Measure Level (dBuV/m)	Reading Level (dBuV)	Over Limit (dB)	Limit (dBuV/m)	Factor (dB)	Type
1		4960.000	46.587	40.609	-27.413	74.000	5.978	PK
2	*	7440.000	48.243	38.716	-25.757	74.000	9.526	PK
3		9920.000	48.002	35.015	-25.998	74.000	12.986	PK

Profile: 21C0118R	Page No.: 43
Engineer: Neil	
Site: AC5	Time: 2021/12/07 - 23:28
Limit: FCC_Part15.209_RE(3m)	Margin: 0
Probe: Horn_3117_00123988_(1-18GHz)	Polarity: Horizontal
EUT: LED DEVICE	Power: AC 120V/60Hz
Note: Mode 3:Transmit at 2402MHz by 125k	

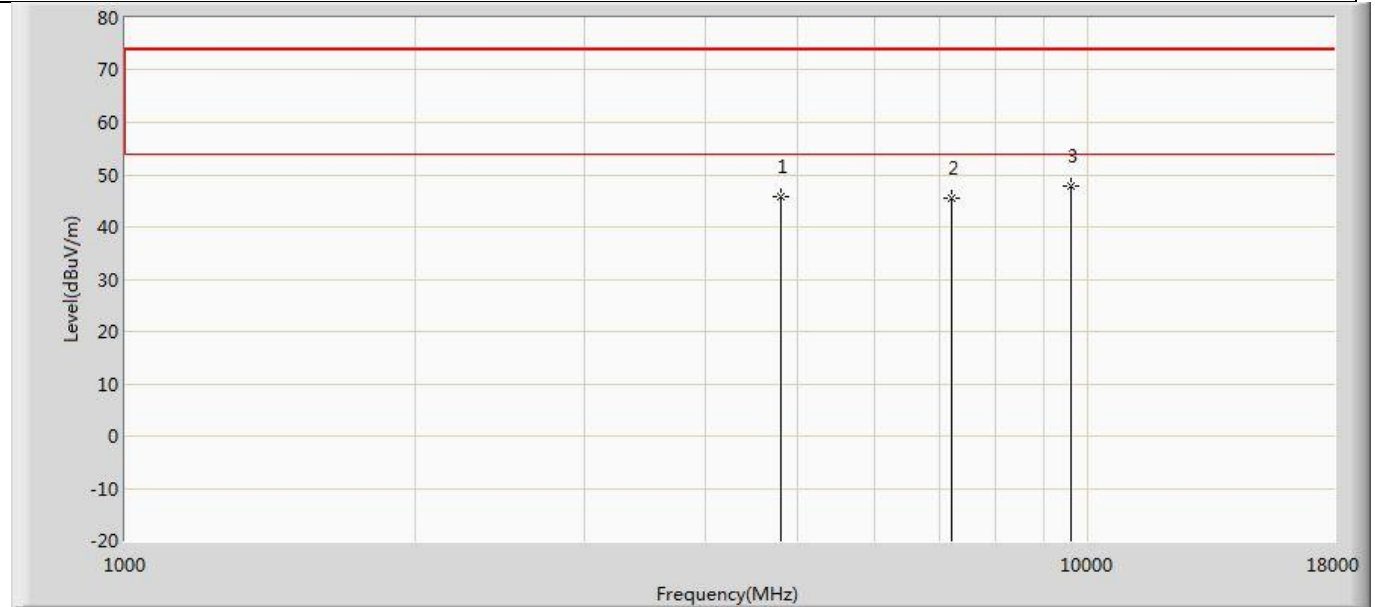

No	Mark	Frequency (MHz)	Measure Level (dBuV/m)	Reading Level (dBuV)	Over Limit (dB)	Limit (dBuV/m)	Factor (dB)	Type
1		4804.000	45.668	40.046	-28.332	74.000	5.621	PK
2		7206.000	45.401	36.333	-28.599	74.000	9.068	PK
3	*	9608.000	47.832	34.747	-26.168	74.000	13.084	PK

Profile: 21C0118R	Page No.: 44
Engineer: Neil	
Site: AC5	Time: 2021/12/07 - 23:28
Limit: FCC_Part15.209_RE(3m)	Margin: 0
Probe: Horn_3117_00123988_(1-18GHz)	Polarity: Vertical
EUT: LED DEVICE	Power: AC 120V/60Hz
Note: Mode 3:Transmit at 2402MHz by 125k	

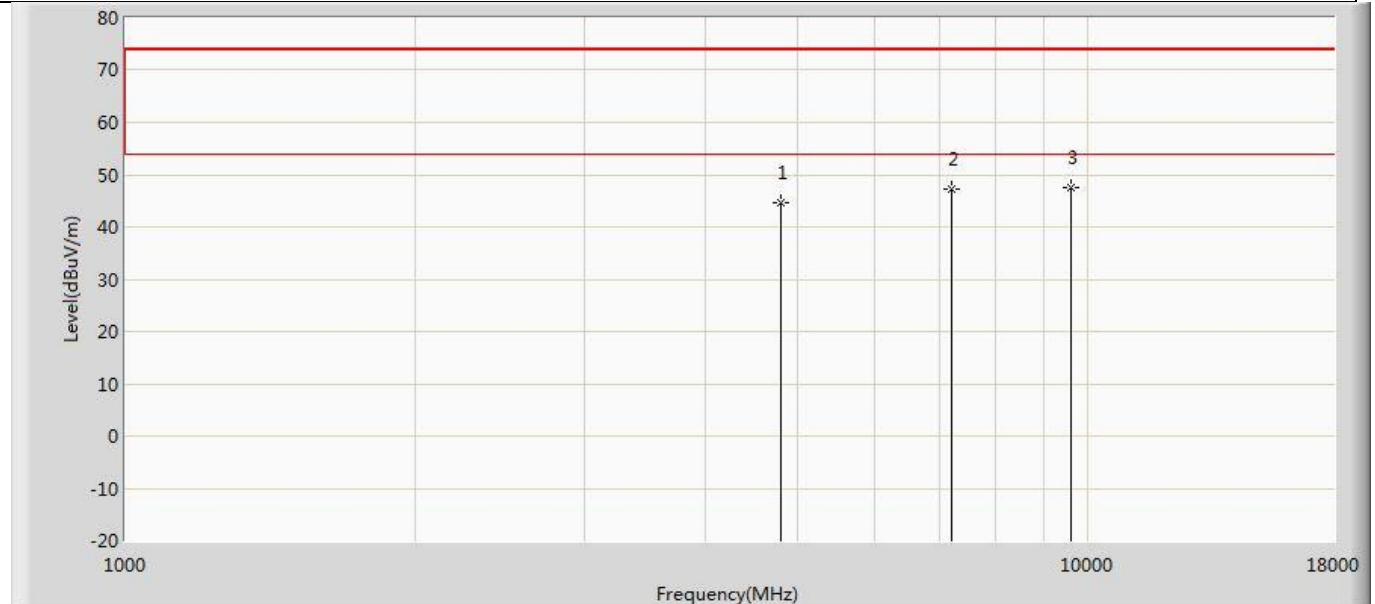

No	Mark	Frequency (MHz)	Measure Level (dBuV/m)	Reading Level (dBuV)	Over Limit (dB)	Limit (dBuV/m)	Factor (dB)	Type
1		4804.000	44.507	38.885	-29.493	74.000	5.621	PK
2		7206.000	47.129	38.061	-26.871	74.000	9.068	PK
3	*	9608.000	47.653	34.568	-26.347	74.000	13.084	PK

Profile: 21C0118R	Page No.: 45
Engineer: Neil	
Site: AC5	Time: 2021/12/07 - 23:28
Limit: FCC_Part15.209_RE(3m)	Margin: 0
Probe: Horn_3117_00123988_(1-18GHz)	Polarity: Horizontal
EUT: LED DEVICE	Power: AC 120V/60Hz
Note: Mode 3:Transmit at 2440MHz by 125k	

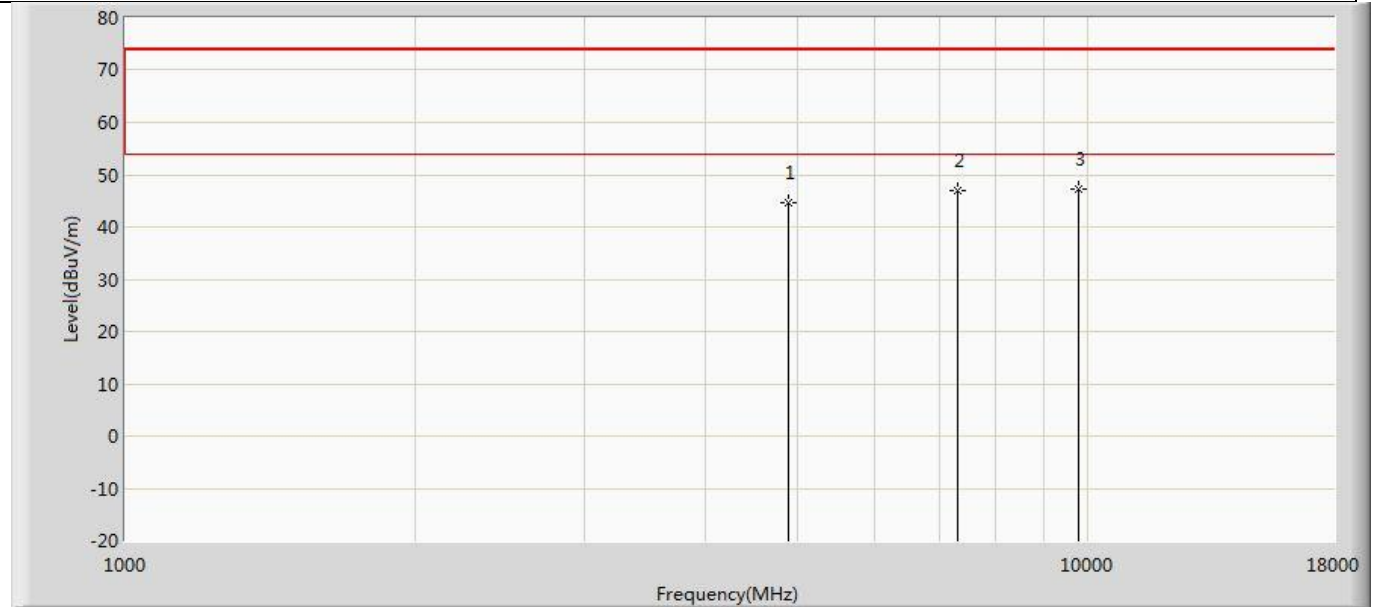

No	Mark	Frequency (MHz)	Measure Level (dBuV/m)	Reading Level (dBuV)	Over Limit (dB)	Limit (dBuV/m)	Factor (dB)	Type
1		4880.000	44.635	38.716	-29.365	74.000	5.919	PK
2		7320.000	47.077	37.571	-26.923	74.000	9.506	PK
3	*	9760.000	47.385	34.331	-26.615	74.000	13.054	PK

Profile: 21C0118R	Page No.: 46
Engineer: Neil	
Site: AC5	Time: 2021/12/07 - 23:29
Limit: FCC_Part15.209_RE(3m)	Margin: 0
Probe: Horn_3117_00123988_(1-18GHz)	Polarity: Vertical
EUT: LED DEVICE	Power: AC 120V/60Hz
Note: Mode 3:Transmit at 2440MHz by 125k	

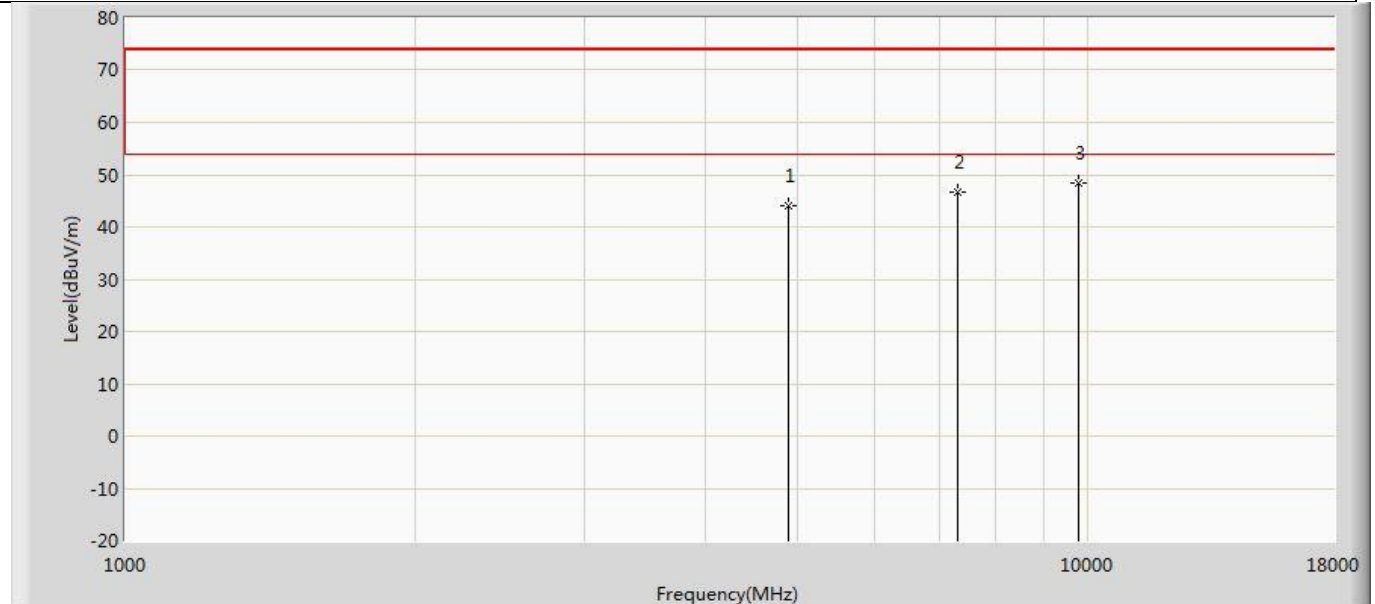

No	Mark	Frequency (MHz)	Measure Level (dBuV/m)	Reading Level (dBuV)	Over Limit (dB)	Limit (dBuV/m)	Factor (dB)	Type
1		4880.000	44.093	38.174	-29.907	74.000	5.919	PK
2		7320.000	46.683	37.177	-27.317	74.000	9.506	PK
3	*	9760.000	48.305	35.251	-25.695	74.000	13.054	PK

Profile: 21C0118R	Page No.: 47
Engineer: Neil	
Site: AC5	Time: 2021/12/07 - 23:29
Limit: FCC_Part15.209_RE(3m)	Margin: 0
Probe: Horn_3117_00123988_(1-18GHz)	Polarity: Horizontal
EUT: LED DEVICE	Power: AC 120V/60Hz
Note: Mode 3:Transmit at 2480MHz by 125k	

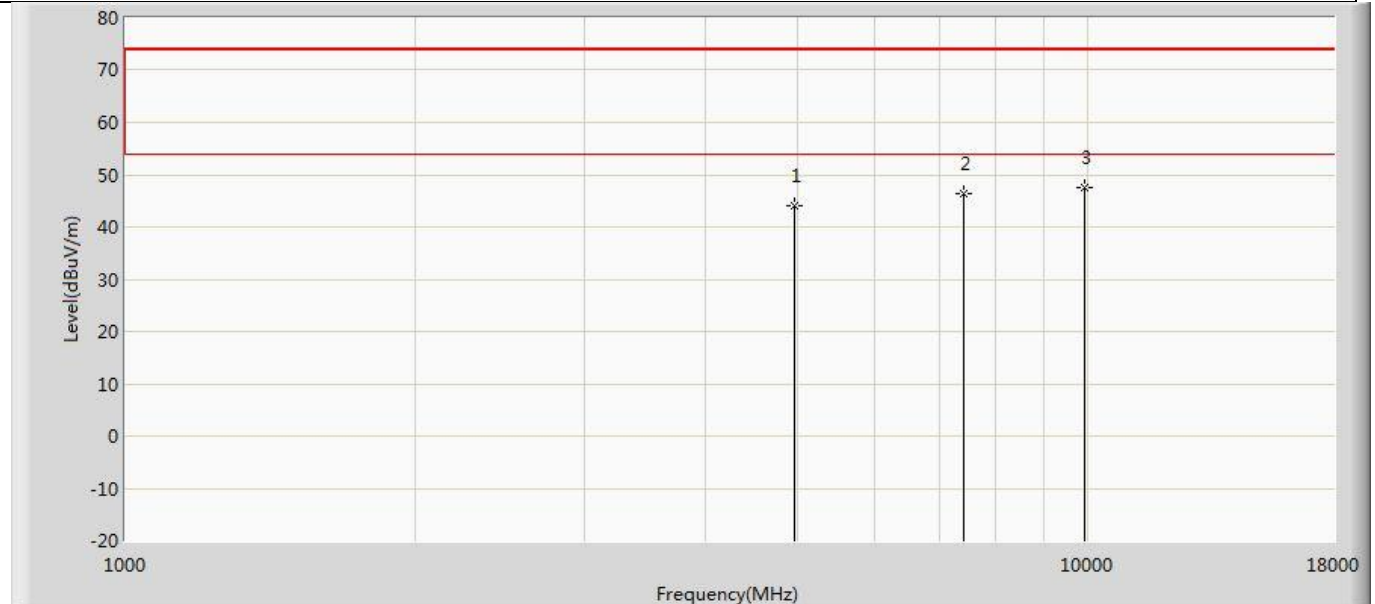

No	Mark	Frequency (MHz)	Measure Level (dBuV/m)	Reading Level (dBuV)	Over Limit (dB)	Limit (dBuV/m)	Factor (dB)	Type
1		4960.000	43.983	38.005	-30.017	74.000	5.978	PK
2		7440.000	46.473	36.946	-27.527	74.000	9.526	PK
3	*	9920.000	47.497	34.510	-26.503	74.000	12.986	PK

Profile: 21C0118R	Page No.: 48
Engineer: Neil	
Site: AC5	Time: 2021/12/07 - 23:29
Limit: FCC_Part15.209_RE(3m)	Margin: 0
Probe: Horn_3117_00123988_(1-18GHz)	Polarity: Vertical
EUT: LED DEVICE	Power: AC 120V/60Hz
Note: Mode 3:Transmit at 2480MHz by 125k	

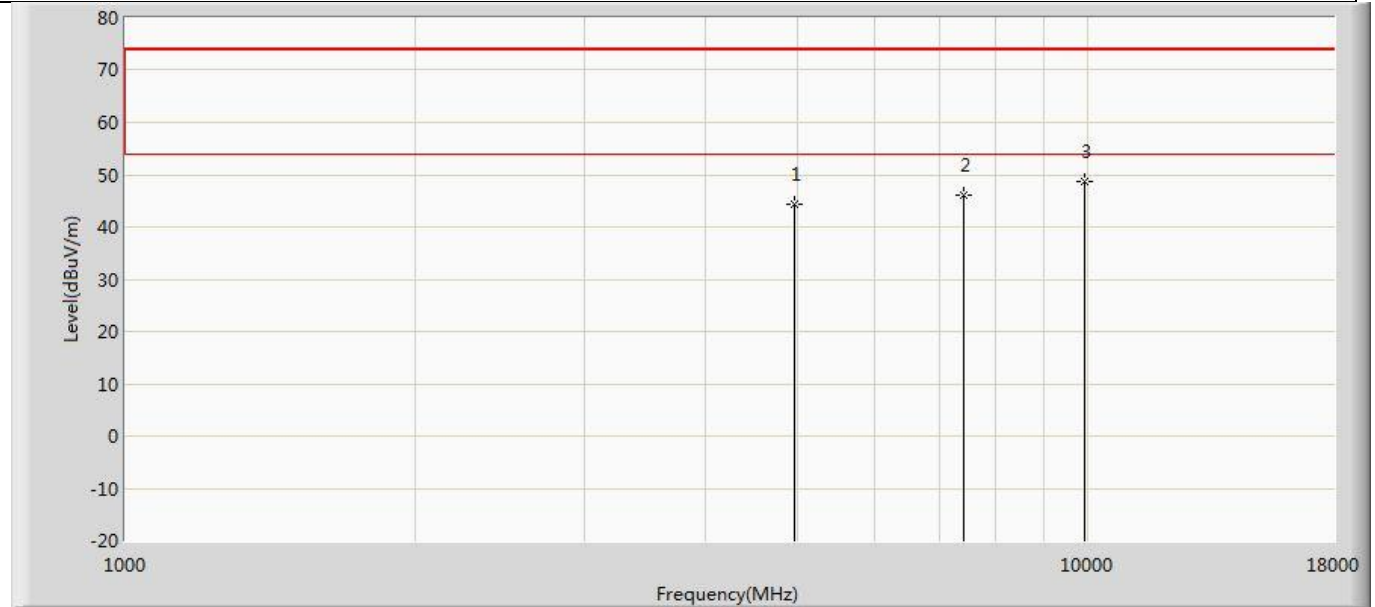

No	Mark	Frequency (MHz)	Measure Level (dBuV/m)	Reading Level (dBuV)	Over Limit (dB)	Limit (dBuV/m)	Factor (dB)	Type
1		4960.000	44.464	38.486	-29.536	74.000	5.978	PK
2		7440.000	46.179	36.652	-27.821	74.000	9.526	PK
3	*	9920.000	48.652	35.665	-25.348	74.000	12.986	PK

Profile: 21C0118R	Page No.: 49
Engineer: Neil	
Site: AC5	Time: 2021/12/07 - 23:29
Limit: FCC_Part15.209_RE(3m)	Margin: 0
Probe: Horn_3117_00123988_(1-18GHz)	Polarity: Horizontal
EUT: LED DEVICE	Power: AC 120V/60Hz
Note: Mode 4:Transmit at 2402MHz by 500k	

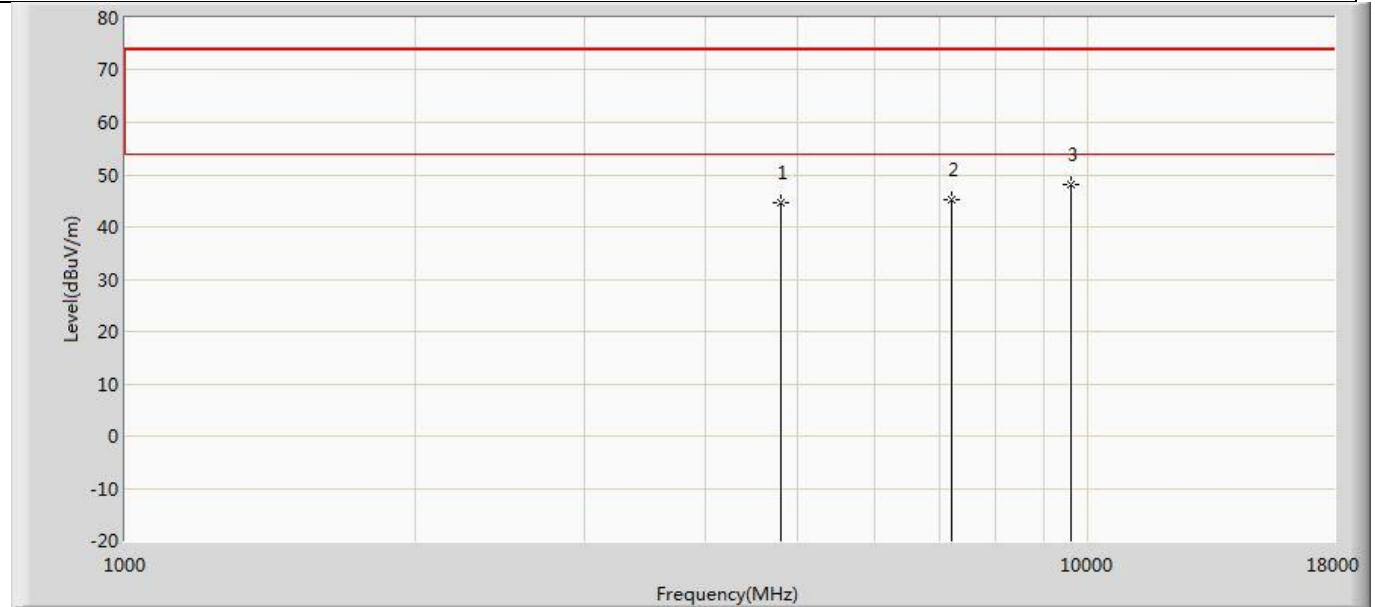

No	Mark	Frequency (MHz)	Measure Level (dBuV/m)	Reading Level (dBuV)	Over Limit (dB)	Limit (dBuV/m)	Factor (dB)	Type
1		4804.000	44.574	38.952	-29.426	74.000	5.621	PK
2		7206.000	45.332	36.264	-28.668	74.000	9.068	PK
3	*	9608.000	48.034	34.949	-25.966	74.000	13.084	PK

Profile: 21C0118R	Page No.: 50
Engineer: Neil	
Site: AC5	Time: 2021/12/07 - 23:29
Limit: FCC_Part15.209_RE(3m)	Margin: 0
Probe: Horn_3117_00123988_(1-18GHz)	Polarity: Vertical
EUT: LED DEVICE	Power: AC 120V/60Hz
Note: Mode 4:Transmit at 2402MHz by 500k	

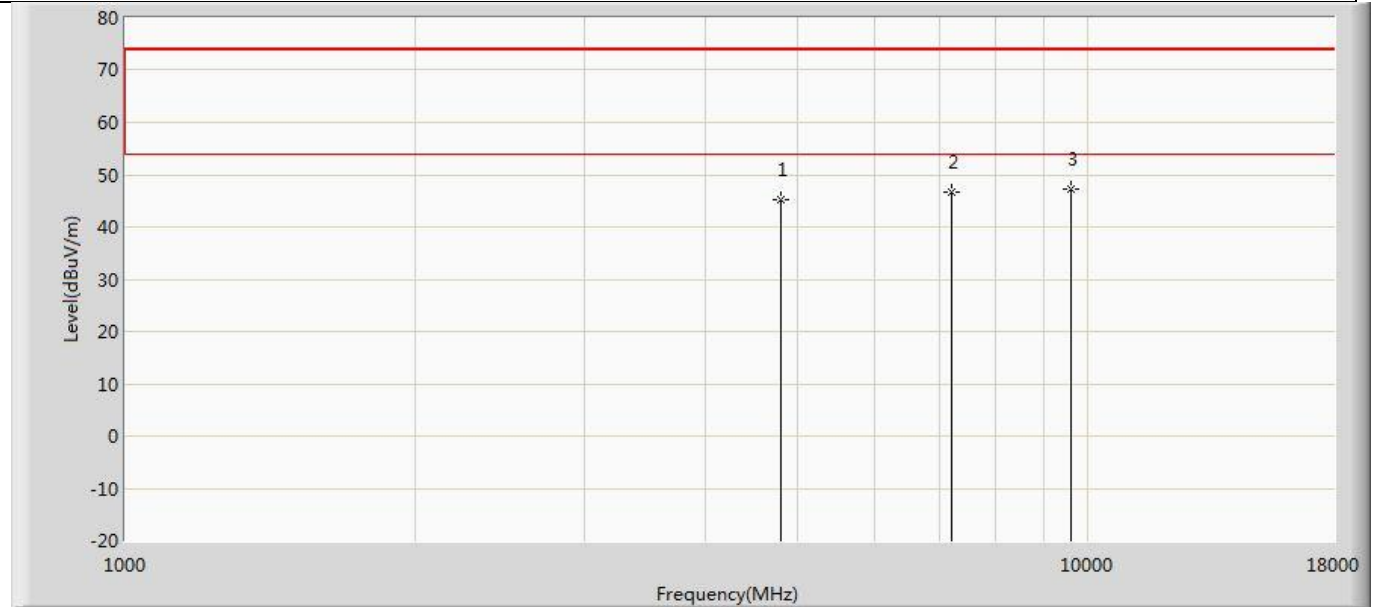

No	Mark	Frequency (MHz)	Measure Level (dBuV/m)	Reading Level (dBuV)	Over Limit (dB)	Limit (dBuV/m)	Factor (dB)	Type
1		4804.000	45.296	39.674	-28.704	74.000	5.621	PK
2		7206.000	46.747	37.679	-27.253	74.000	9.068	PK
3	*	9608.000	47.386	34.301	-26.614	74.000	13.084	PK

Profile: 21C0118R	Page No.: 51
Engineer: Neil	
Site: AC5	Time: 2021/12/07 - 23:29
Limit: FCC_Part15.209_RE(3m)	Margin: 0
Probe: Horn_3117_00123988_(1-18GHz)	Polarity: Horizontal
EUT: LED DEVICE	Power: AC 120V/60Hz
Note: Mode 4:Transmit at 2440MHz by 500k	

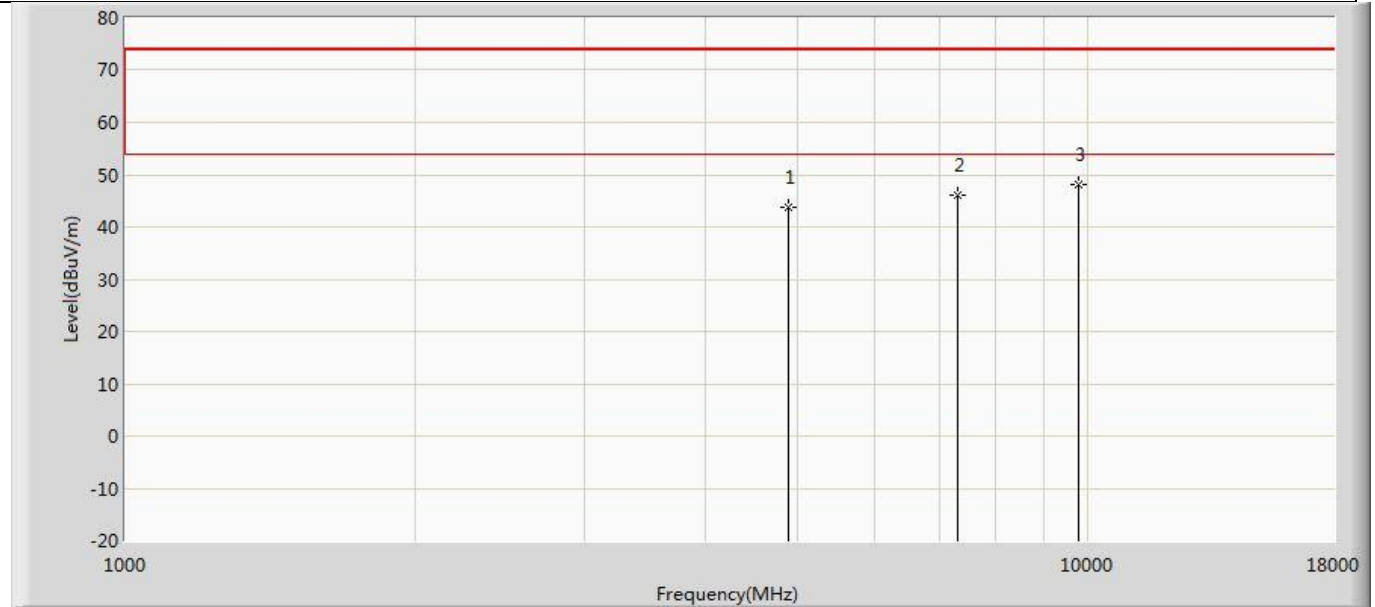

No	Mark	Frequency (MHz)	Measure Level (dBuV/m)	Reading Level (dBuV)	Over Limit (dB)	Limit (dBuV/m)	Factor (dB)	Type
1		4880.000	43.910	37.991	-30.090	74.000	5.919	PK
2		7320.000	46.160	36.654	-27.840	74.000	9.506	PK
3	*	9760.000	48.038	34.984	-25.962	74.000	13.054	PK

Profile: 21C0118R	Page No.: 52
Engineer: Neil	
Site: AC5	Time: 2021/12/07 - 23:29
Limit: FCC_Part15.209_RE(3m)	Margin: 0
Probe: Horn_3117_00123988_(1-18GHz)	Polarity: Vertical
EUT: LED DEVICE	Power: AC 120V/60Hz
Note: Mode 4:Transmit at 2440MHz by 500k	

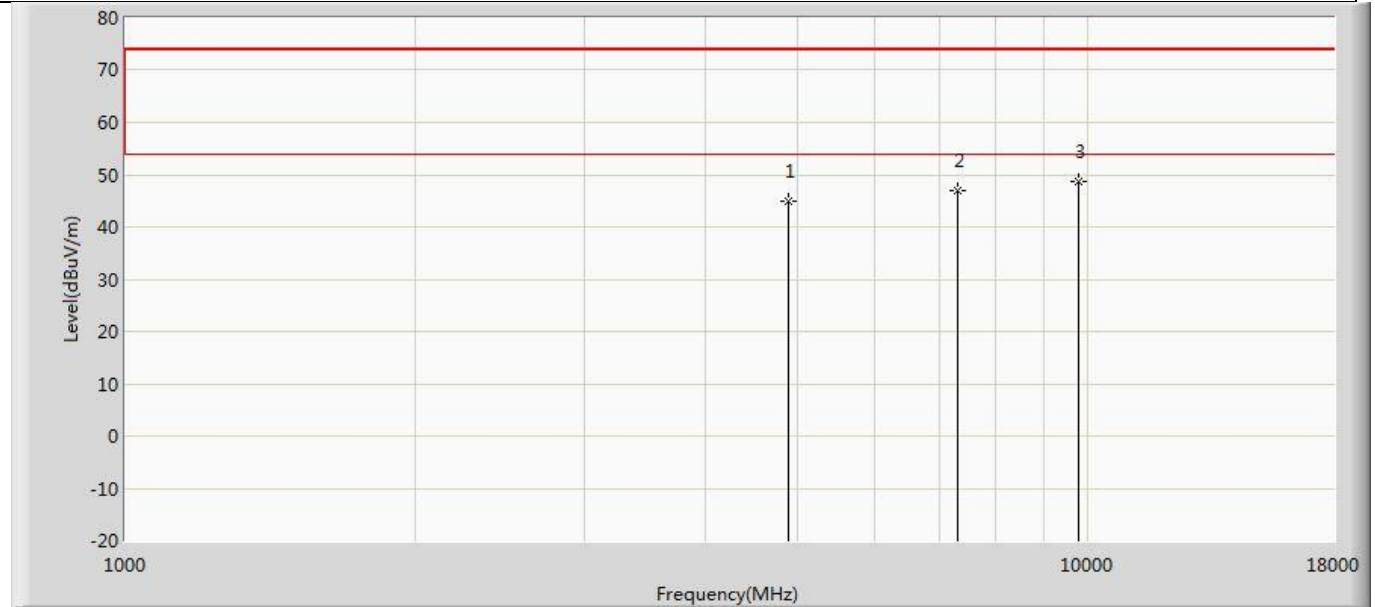

No	Mark	Frequency (MHz)	Measure Level (dBuV/m)	Reading Level (dBuV)	Over Limit (dB)	Limit (dBuV/m)	Factor (dB)	Type
1		4880.000	45.044	39.125	-28.956	74.000	5.919	PK
2		7320.000	46.868	37.362	-27.132	74.000	9.506	PK
3	*	9760.000	48.801	35.747	-25.199	74.000	13.054	PK

Profile: 21C0118R	Page No.: 53
Engineer: Neil	
Site: AC5	Time: 2021/12/07 - 23:29
Limit: FCC_Part15.209_RE(3m)	Margin: 0
Probe: Horn_3117_00123988_(1-18GHz)	Polarity: Horizontal
EUT: LED DEVICE	Power: AC 120V/60Hz
Note: Mode 4:Transmit at 2480MHz by 500k	

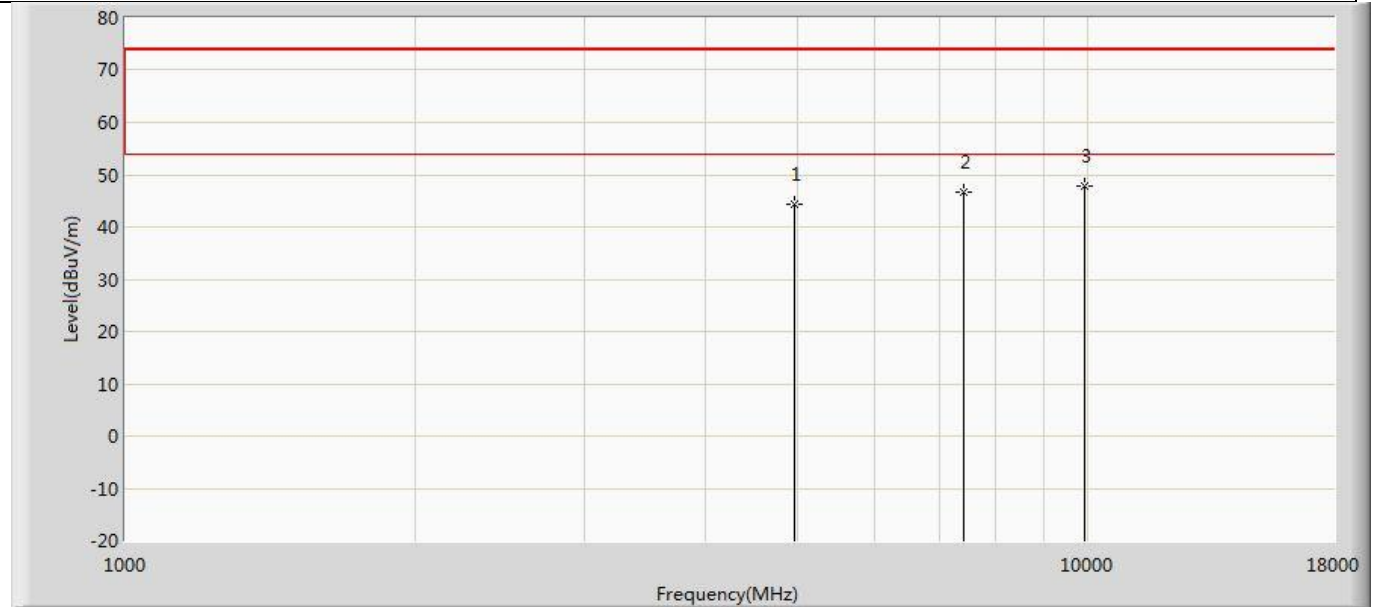

No	Mark	Frequency (MHz)	Measure Level (dBuV/m)	Reading Level (dBuV)	Over Limit (dB)	Limit (dBuV/m)	Factor (dB)	Type
1		4960.000	44.486	38.508	-29.514	74.000	5.978	PK
2		7440.000	46.747	37.220	-27.253	74.000	9.526	PK
3	*	9920.000	47.860	34.873	-26.140	74.000	12.986	PK

Profile: 21C0118R	Page No.: 54
Engineer: Neil	
Site: AC5	Time: 2021/12/07 - 23:29
Limit: FCC_Part15.209_RE(3m)	Margin: 0
Probe: Horn_3117_00123988_(1-18GHz)	Polarity: Vertical
EUT: LED DEVICE	Power: AC 120V/60Hz
Note: Mode 4:Transmit at 2480MHz by 500k	

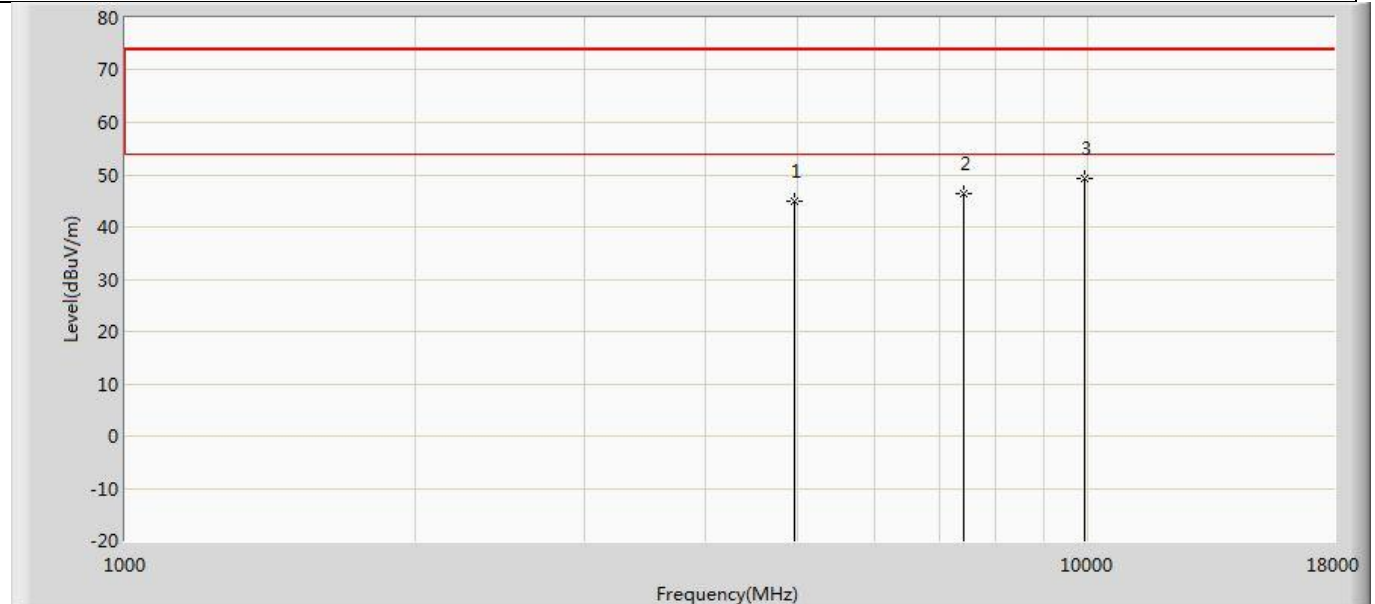

No	Mark	Frequency (MHz)	Measure Level (dBuV/m)	Reading Level (dBuV)	Over Limit (dB)	Limit (dBuV/m)	Factor (dB)	Type
1		4960.000	45.031	39.053	-28.969	74.000	5.978	PK
2		7440.000	46.307	36.780	-27.693	74.000	9.526	PK
3	*	9920.000	49.389	36.402	-24.611	74.000	12.986	PK

Note:

1. Measured Level = Reading Level + Factor.
2. The test frequency range, 9kHz~30MHz, 18GHz~26GHz, both of the worst case are at least 20dB below the limits, therefore no data appear in the report.
3. This limit applies for using average detector, if the test result on peak is lower than average limit, then average measurement needn't be performed.
4. As the radiated emission was performed, so conducted emission was not tested.

The worst case of Radiated Emission below 1GHz:

Profile: 21C0118R	Page No.: 15
Engineer: Carlos shen	
Site: AC2	Time: 2021/09/17 - 05:59
Limit: FCC_Part15.209_RE(3m)	Margin: 0
Probe: AC2_3M(30-1000M)	Polarity: Horizontal
EUT: LED DEVICE	Power: AC 120V/60Hz
Note: Mode1	

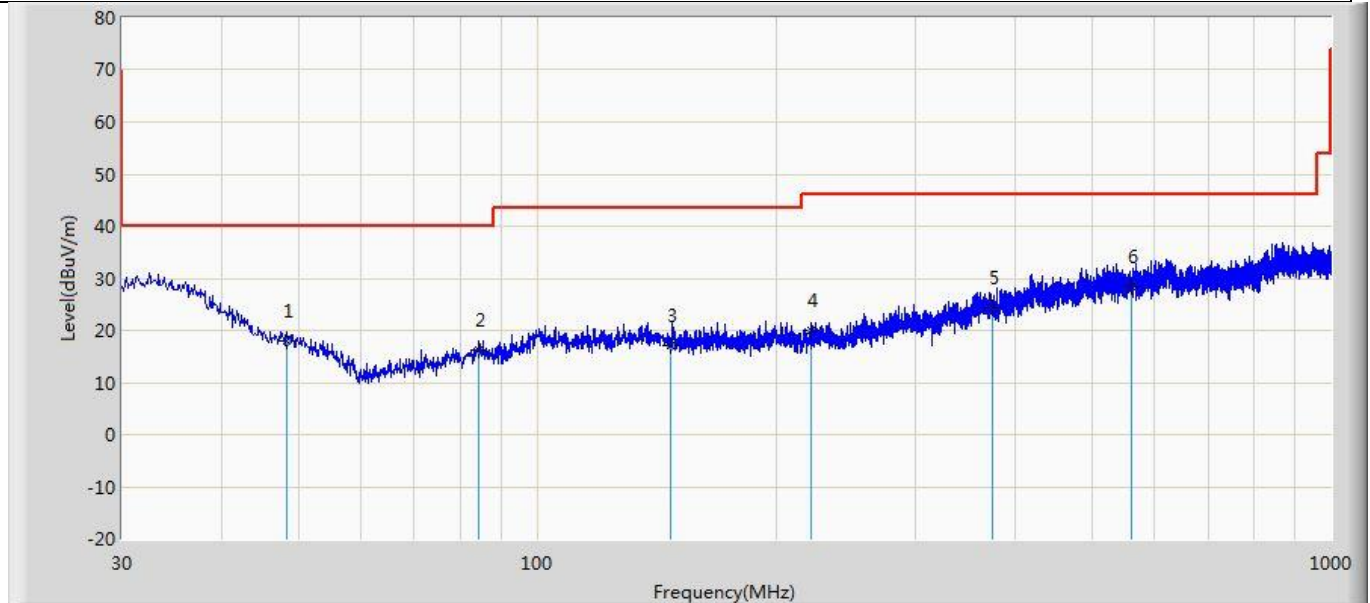

No	Mark	Frequency (MHz)	Measure Level (dBuV/m)	Reading Level (dBuV)	Over Limit (dB)	Limit (dBuV/m)	Factor (dB)	Type
1		48.309	18.002	1.830	-21.998	40.000	16.172	QP
2		84.562	16.248	1.976	-23.752	40.000	14.272	QP
3		147.006	17.069	0.143	-26.431	43.500	16.926	QP
4		221.696	20.127	2.524	-25.873	46.000	17.603	QP
5		373.865	24.269	0.353	-21.731	46.000	23.916	QP
6	*	560.833	28.549	0.003	-17.451	46.000	28.547	QP

Note:

1. All Readings below 1GHz are Quasi-Peak, above are performed with peak and/or average measurements as necessary.
2. " * ", means this data is the worst emission level.
3. Measurement Level = Reading Level + Factor(Probe+Cable-Amp).

Profile: 21C0118R	Page No.: 16
Engineer: Carlos shen	
Site: AC2	Time: 2021/09/17 - 06:02
Limit: FCC_Part15.209_RE(3m)	Margin: 0
Probe: AC2_3M(30-1000M)	Polarity: Vertical
EUT: LED DEVICE	Power: AC 120V/60Hz
Note: Mode1	

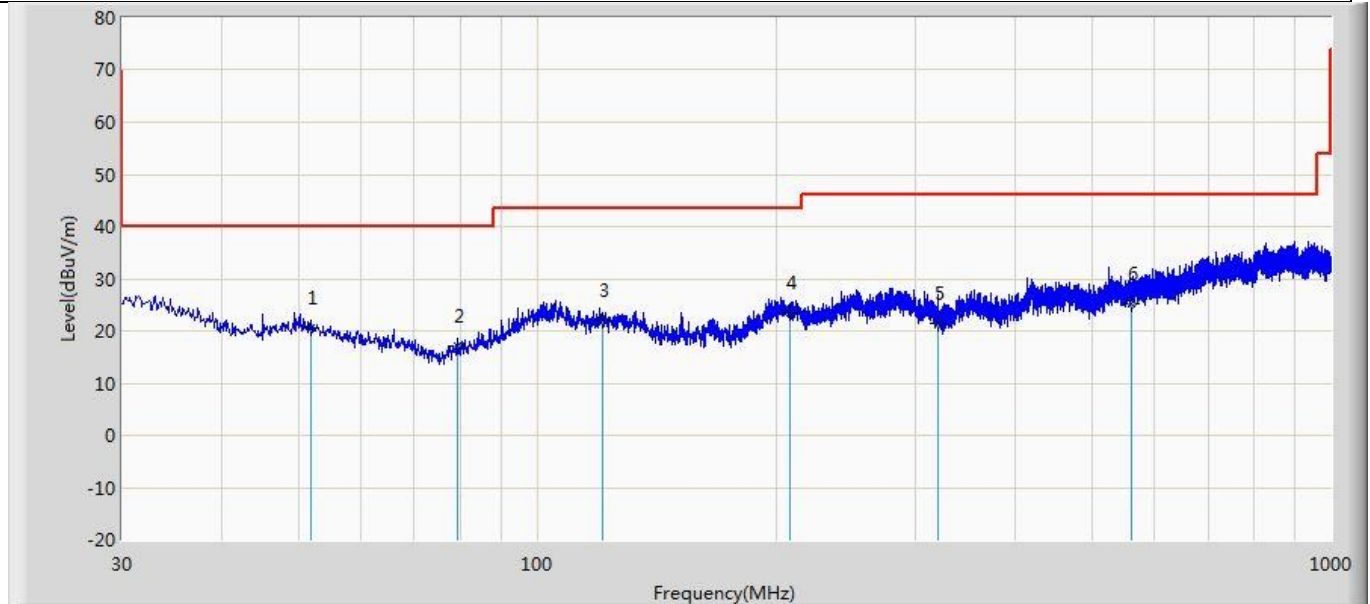

No	Mark	Frequency (MHz)	Measure Level (dBuV/m)	Reading Level (dBuV)	Over Limit (dB)	Limit (dBuV/m)	Factor (dB)	Type
1	*	51.825	20.569	1.785	-19.431	40.000	18.783	QP
2		79.349	17.059	2.258	-22.941	40.000	14.800	QP
3		121.059	22.067	1.431	-21.433	43.500	20.636	QP
4		208.359	23.448	0.164	-20.052	43.500	23.283	QP
5		319.999	21.587	-0.937	-24.413	46.000	22.524	QP
6		561.560	25.181	-1.726	-20.819	46.000	26.907	QP

Note:

1. All Readings below 1GHz are Quasi-Peak, above are performed with peak and/or average measurements as necessary.
2. " * ", means this data is the worst emission level.
3. Measurement Level = Reading Level + Factor(Probe+Cable-Amp).

4.3 Radiated Emission Band Edge	VERDICT: PASS
--	----------------------

4.3.1 Limit

Standard		FCC Part 15 Subpart C Paragraph 15.247(d) , 15.209		
Frequency bands (MHz)	Detector	Limit (dB μ V/m)	RBW (MHz)	Distance (m)
2310-2390	PK	74	1	3
2483.5-2500	AV	54	1	3

Note: The field strength of emissions appearing within these frequency bands shall not exceed the limits.

4.3.2 Test Setup

Above 1GHz Test Setup:

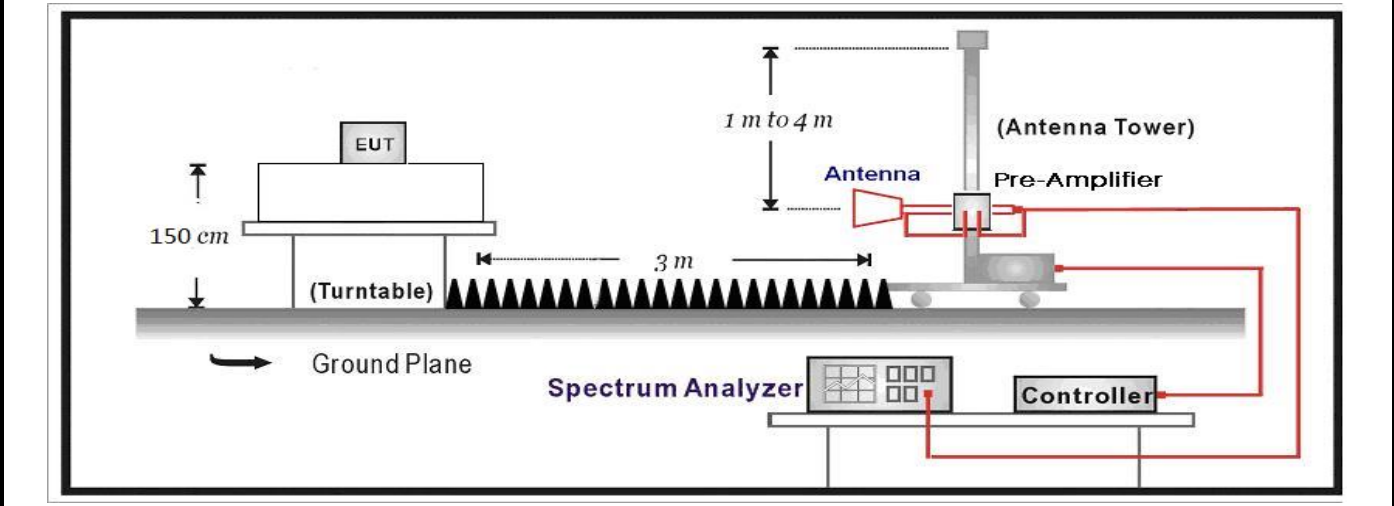

4.3.3 Test Procedure

	References Rule	Chapter	Description
<input checked="" type="checkbox"/>	ANSI C63.10	6.10	Band-edge testing
	<input checked="" type="checkbox"/> ANSI C63.10	6.10.5	Restricted-band band-edge measurements
	<input type="checkbox"/> ANSI C63.10	6.10.6	Marker-delta method
<input checked="" type="checkbox"/>	ANSI C63.10	11.12	Emissions in restricted frequency bands
	<input checked="" type="checkbox"/> ANSI C63.10	11.12.1	Radiated emission measurements
	<input checked="" type="checkbox"/> ANSI C63.10	11.12.2.7	Radiated spurious emission test
<input type="checkbox"/>	ANSI C63.10	6.4	Radiated emissions from unlicensed wireless devices below 30 MHz
<input type="checkbox"/>	ANSI C63.10	6.5	Radiated emissions from unlicensed wireless devices in the frequency range of 30 MHz to 1000 MHz
<input checked="" type="checkbox"/>	ANSI C63.10	6.6	Radiated emissions from unlicensed wireless devices above 1 GHz

4.3.4 Test Data

Profile: 21C0118R	Page No.: 1
Engineer: Carlosshen	
Site: AC5	Time: 2020/03/12 - 00:39
Limit: FCC_Part15.209_RE(3m)	Margin: 0
Probe: Horn_3117_00123988_(1-18GHz)	Polarity: Vertical
EUT: LED Device	Power: AC 120V/60Hz
Note: Mode 1:Transmit at 2402MHz by LE_1Mbps	

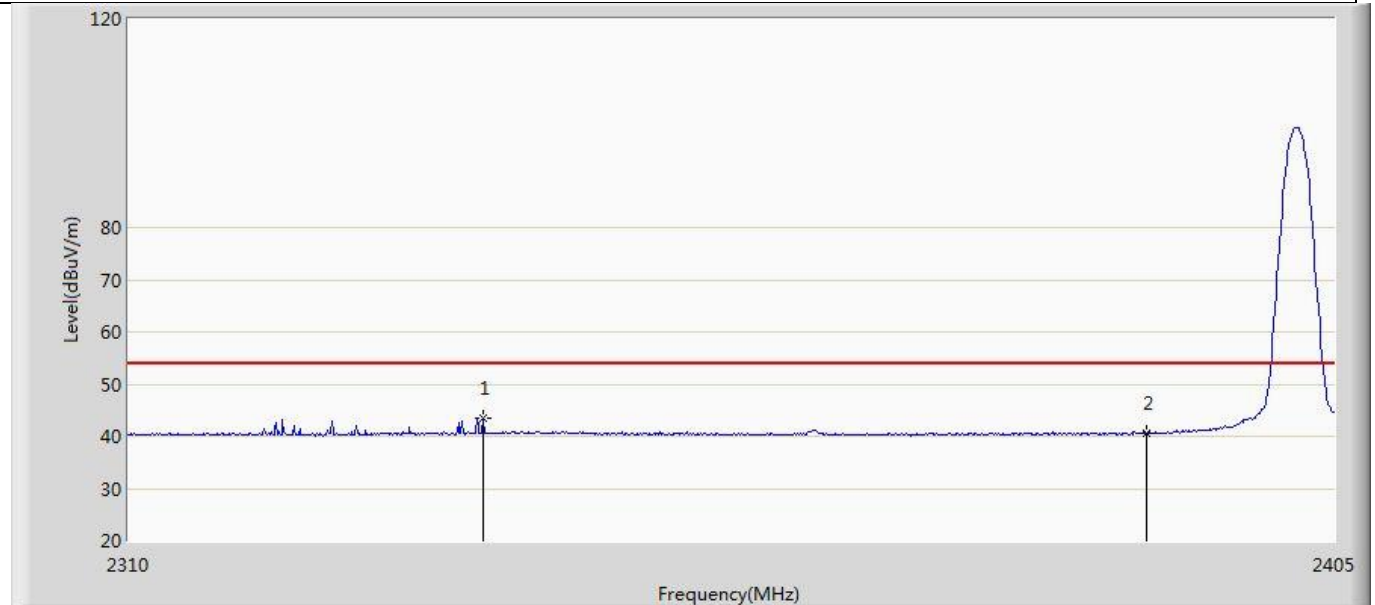

No	Mark	Frequency (MHz)	Measure Level (dBuV/m)	Reading Level (dBuV)	Over Limit (dB)	Limit (dBuV/m)	Factor (dB)	Type
1	*	2337.550	43.521	7.981	-10.479	54.000	35.540	AV
2		2390.000	40.576	5.117	-13.424	54.000	35.459	AV

Profile: 21C0118R	Page No.: 2
Engineer: Carlosshen	
Site: AC5	Time: 2021/05/25 - 20:16
Limit: FCC_Part15.209_RE(3m)	Margin: 0
Probe: Horn_3117_00123988_(1-18GHz)	Polarity: Vertical
EUT: LED Device	Power: AC 120V/60Hz
Note: Mode 1:Transmit at 2402MHz by LE_1Mbps	

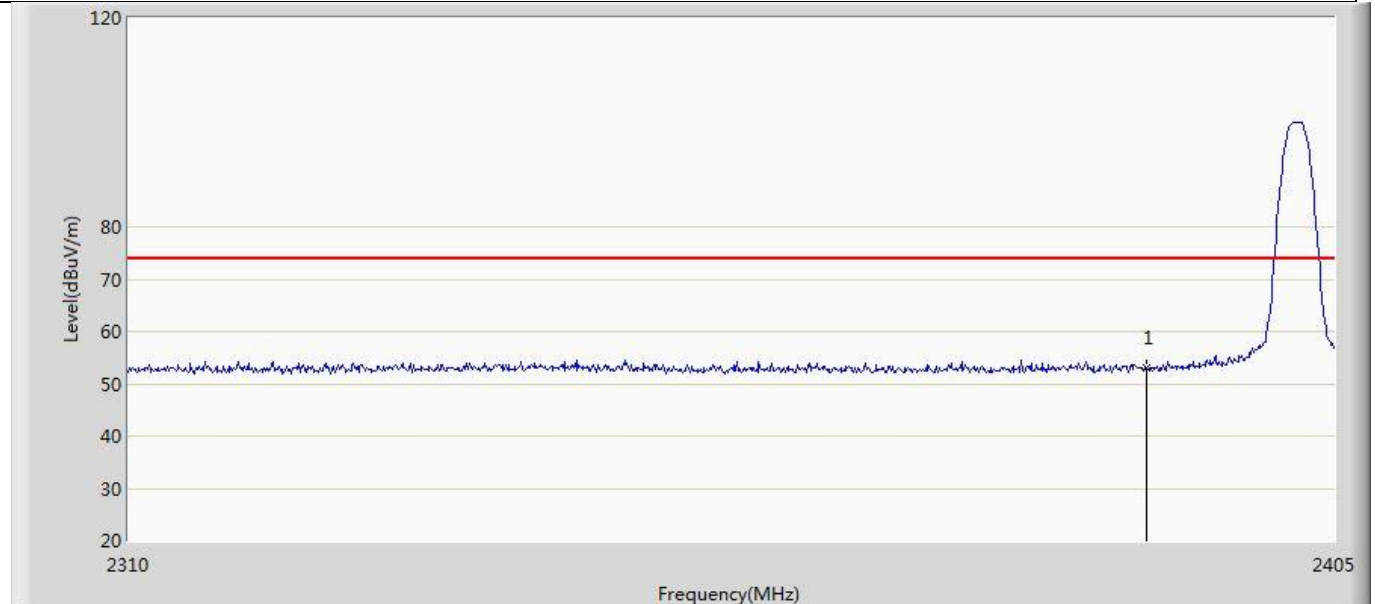

No	Mark	Frequency (MHz)	Measure Level (dBuV/m)	Reading Level (dBuV)	Over Limit (dB)	Limit (dBuV/m)	Factor (dB)	Type
1	*	2390.000	53.008	17.549	-20.992	74.000	35.459	PK

Profile: 21C0118R	Page No.: 3
Engineer: Carlosshen	
Site: AC5	Time: 2021/05/25 - 20:20
Limit: FCC_Part15.209_RE(3m)	Margin: 0
Probe: Horn_3117_00123988_(1-18GHz)	Polarity: Horizontal
EUT: LED Device	Power: AC 120V/60Hz
Note: Mode 1:Transmit at 2402MHz by LE_1Mbps	

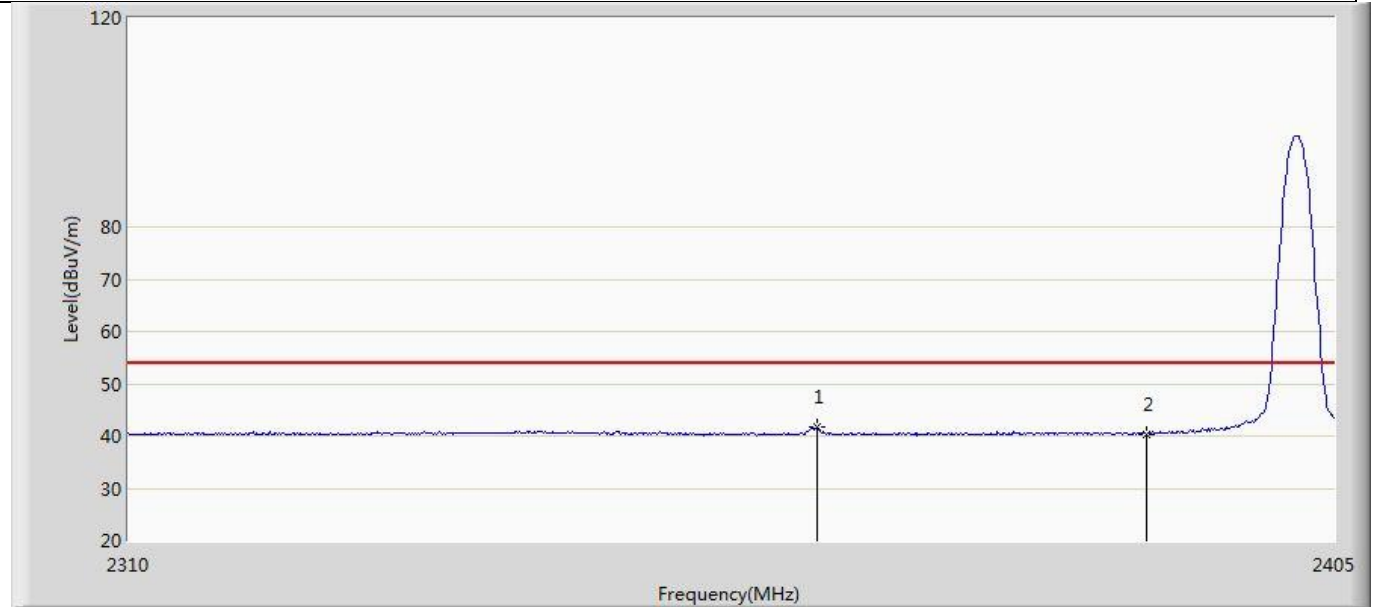

No	Mark	Frequency (MHz)	Measure Level (dBuV/m)	Reading Level (dBuV)	Over Limit (dB)	Limit (dBuV/m)	Factor (dB)	Type
1	*	2363.770	41.623	6.272	-12.377	54.000	35.351	AV
2		2390.000	40.348	4.889	-13.652	54.000	35.459	AV

Profile: 21C0118R	Page No.: 4
Engineer: Carlosshen	
Site: AC5	Time: 2021/05/25 - 20:21
Limit: FCC_Part15.209_RE(3m)	Margin: 0
Probe: Horn_3117_00123988_(1-18GHz)	Polarity: Horizontal
EUT: LED Device	Power: AC 120V/60Hz
Note: Mode 1:Transmit at 2402MHz by LE_1Mbps	

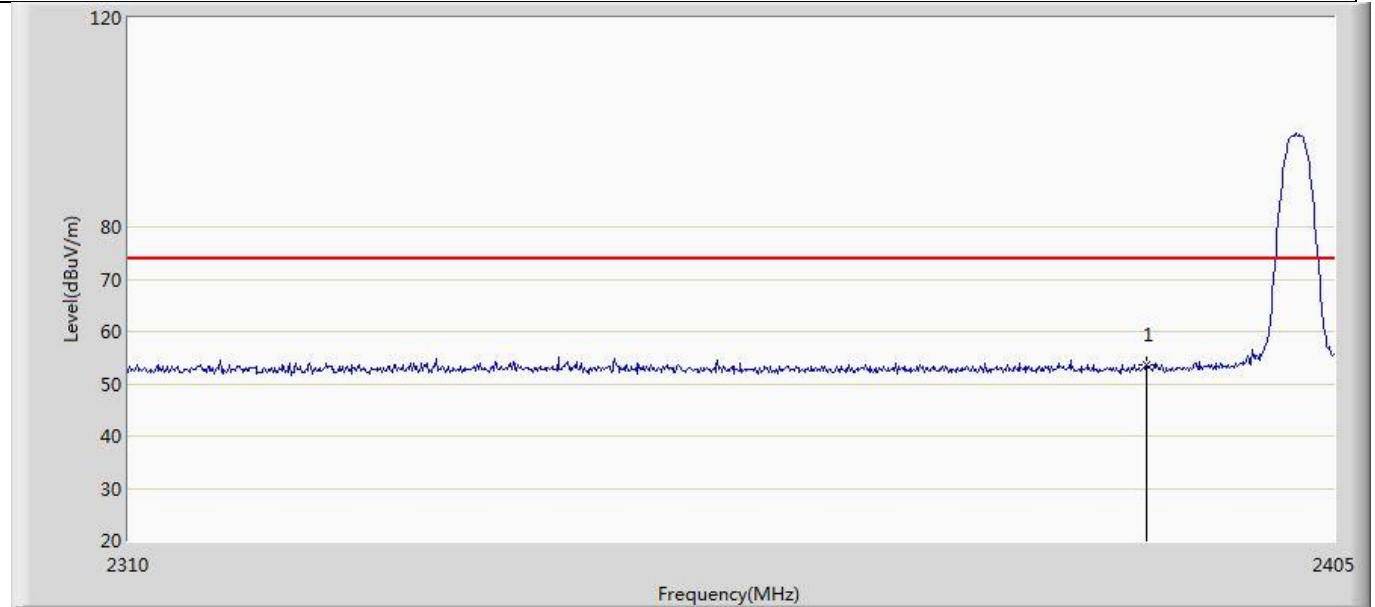

No	Mark	Frequency (MHz)	Measure Level (dBuV/m)	Reading Level (dBuV)	Over Limit (dB)	Limit (dBuV/m)	Factor (dB)	Type
1	*	2390.000	53.538	18.079	-20.462	74.000	35.459	PK

Profile: 21C0118R	Page No.: 17
Engineer: Carlosshen	
Site: AC5	Time: 2021/05/25 - 20:39
Limit: FCC_Part15.209_RE(3m)	Margin: 0
Probe: Horn_3117_00123988_(1-18GHz)	Polarity: Vertical
EUT: LED Device	Power: AC 120V/60Hz
Note: Mode 1:Transmit at 2480MHz by LE_1Mbps	

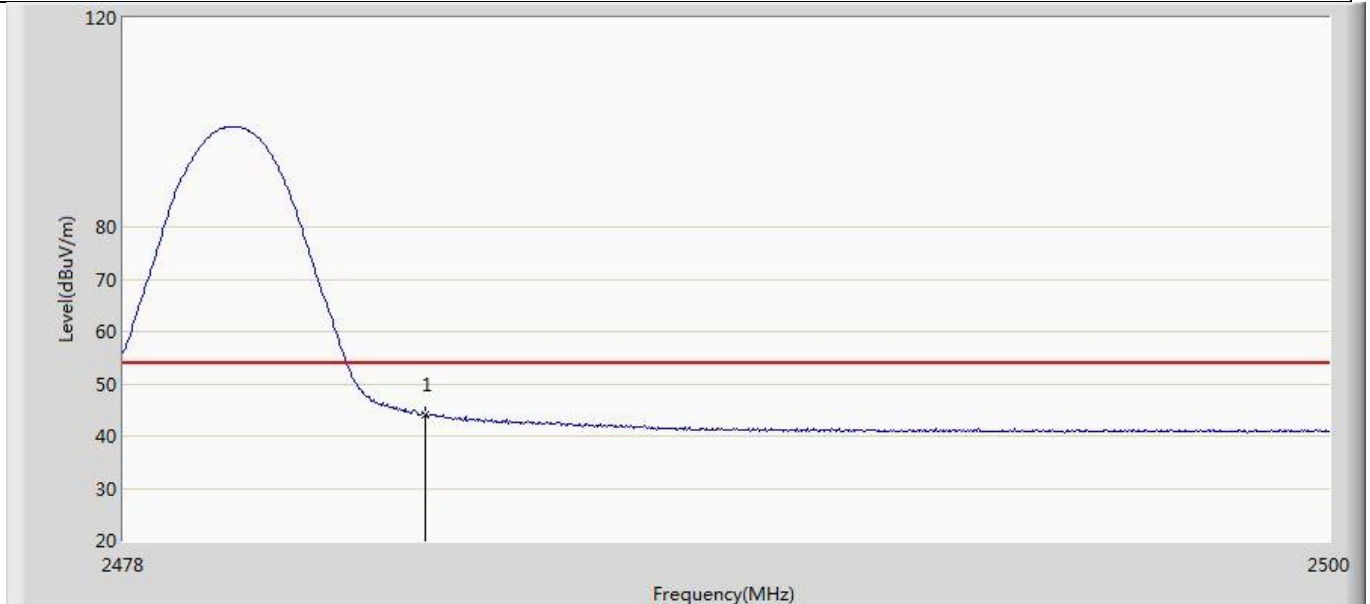

No	Mark	Frequency (MHz)	Measure Level (dBuV/m)	Reading Level (dBuV)	Over Limit (dB)	Limit (dBuV/m)	Factor (dB)	Type
1	*	2483.500	44.070	8.395	-9.930	54.000	35.675	AV

Profile: 21C0118R	Page No.: 18
Engineer: Carlosshen	
Site: AC5	Time: 2021/05/25 - 20:41
Limit: FCC_Part15.209_RE(3m)	Margin: 0
Probe: Horn_3117_00123988_(1-18GHz)	Polarity: Vertical
EUT: LED Device	Power: AC 120V/60Hz
Note: Mode 1:Transmit at 2480MHz by LE_1Mbps	

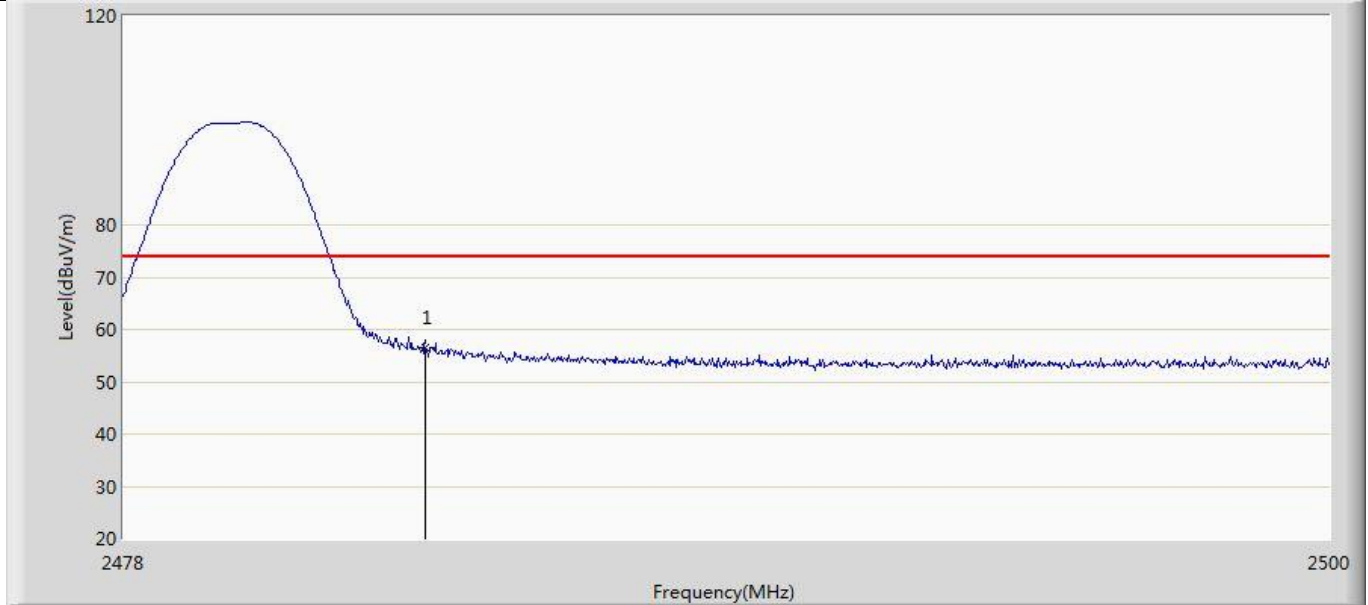

No	Mark	Frequency (MHz)	Measure Level (dBuV/m)	Reading Level (dBuV)	Over Limit (dB)	Limit (dBuV/m)	Factor (dB)	Type
1	*	2483.500	56.650	20.975	-17.350	74.000	35.675	PK

Profile: 21C0118R	Page No.: 19
Engineer: Carlosshen	
Site: AC5	Time: 2021/05/25 - 20:42
Limit: FCC_Part15.209_RE(3m)	Margin: 0
Probe: Horn_3117_00123988_(1-18GHz)	Polarity: Horizontal
EUT: LED Device	Power: AC 120V/60Hz
Note: Mode 1:Transmit at 2480MHz by LE_1Mbps	

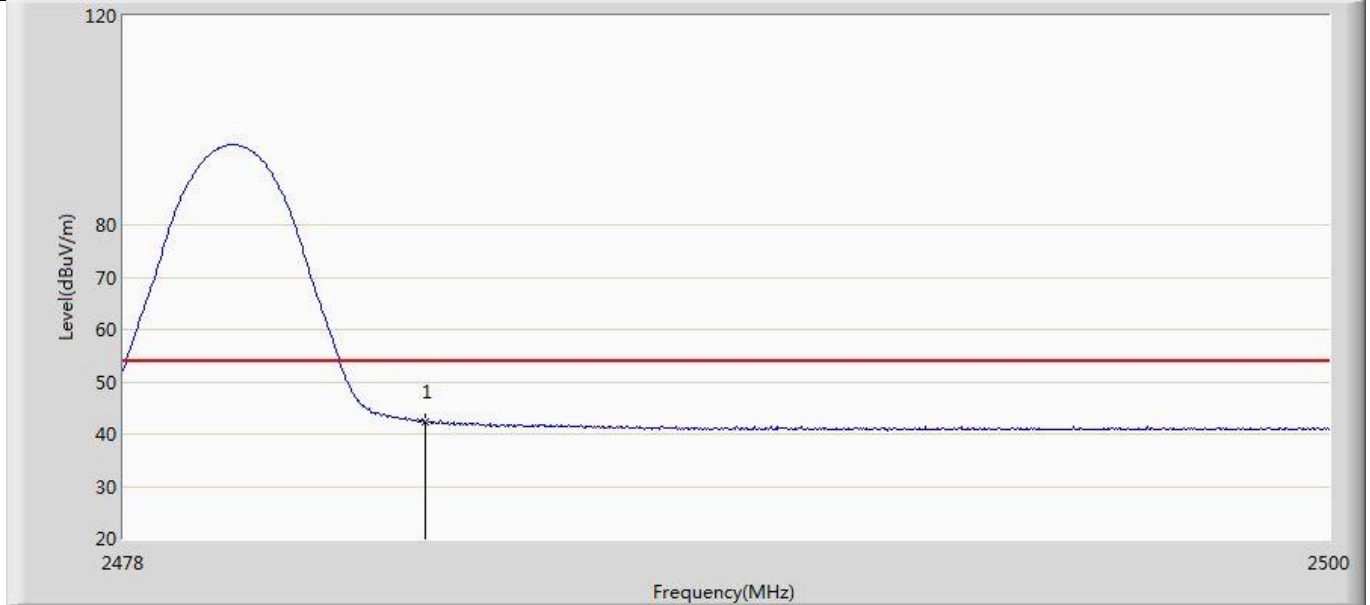

No	Mark	Frequency (MHz)	Measure Level (dBuV/m)	Reading Level (dBuV)	Over Limit (dB)	Limit (dBuV/m)	Factor (dB)	Type
1	*	2483.500	42.463	6.788	-11.537	54.000	35.675	AV

Profile: 21C0118R	Page No.: 20
Engineer: Carlosshen	
Site: AC5	Time: 2021/05/25 - 20:43
Limit: FCC_Part15.209_RE(3m)	Margin: 0
Probe: Horn_3117_00123988_(1-18GHz)	Polarity: Horizontal
EUT: LED Device	Power: AC 120V/60Hz
Note: Mode 1:Transmit at 2480MHz by LE_1Mbps	

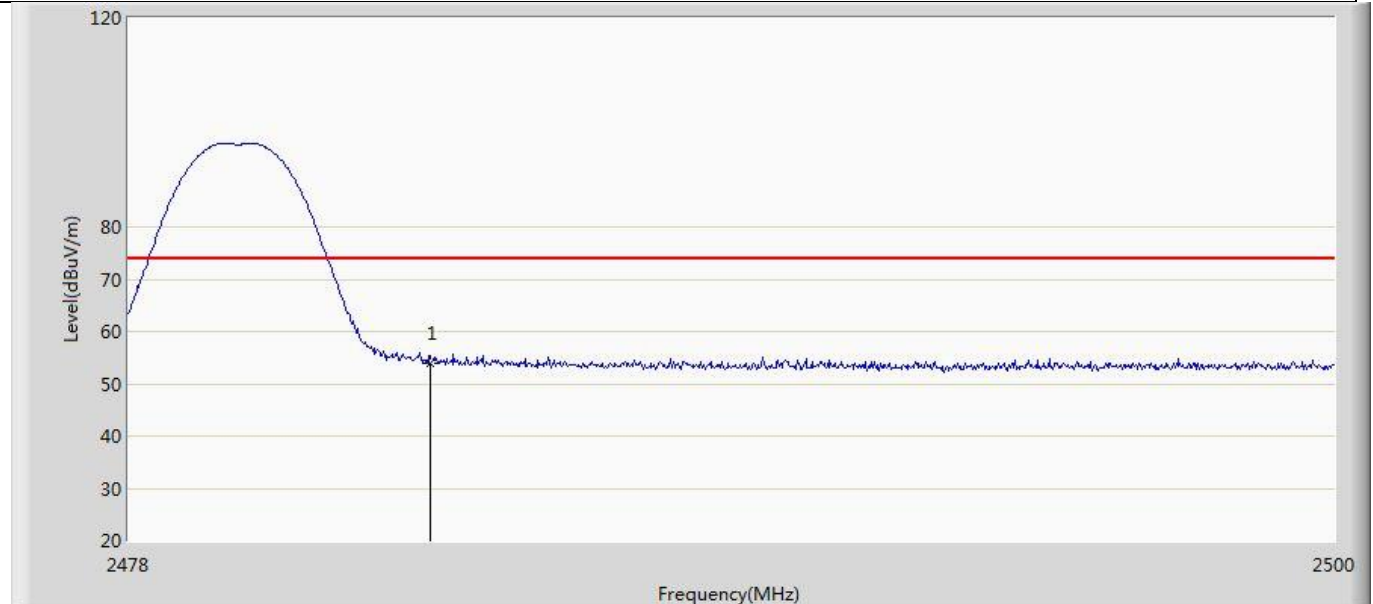

No	Mark	Frequency (MHz)	Measure Level (dBuV/m)	Reading Level (dBuV)	Over Limit (dB)	Limit (dBuV/m)	Factor (dB)	Type
1	*	2483.500	53.793	18.118	-20.207	74.000	35.675	PK

Profile: 21C0118R	Page No.: 5
Engineer: Carlosshen	
Site: AC5	Time: 2021/05/25 - 20:22
Limit: FCC_Part15.209_RE(3m)	Margin: 0
Probe: Horn_3117_00123988_(1-18GHz)	Polarity: Vertical
EUT: LED Device	Power: AC 120V/60Hz
Note: Mode 2:Transmit at 2402MHz by LE_2Mbps	

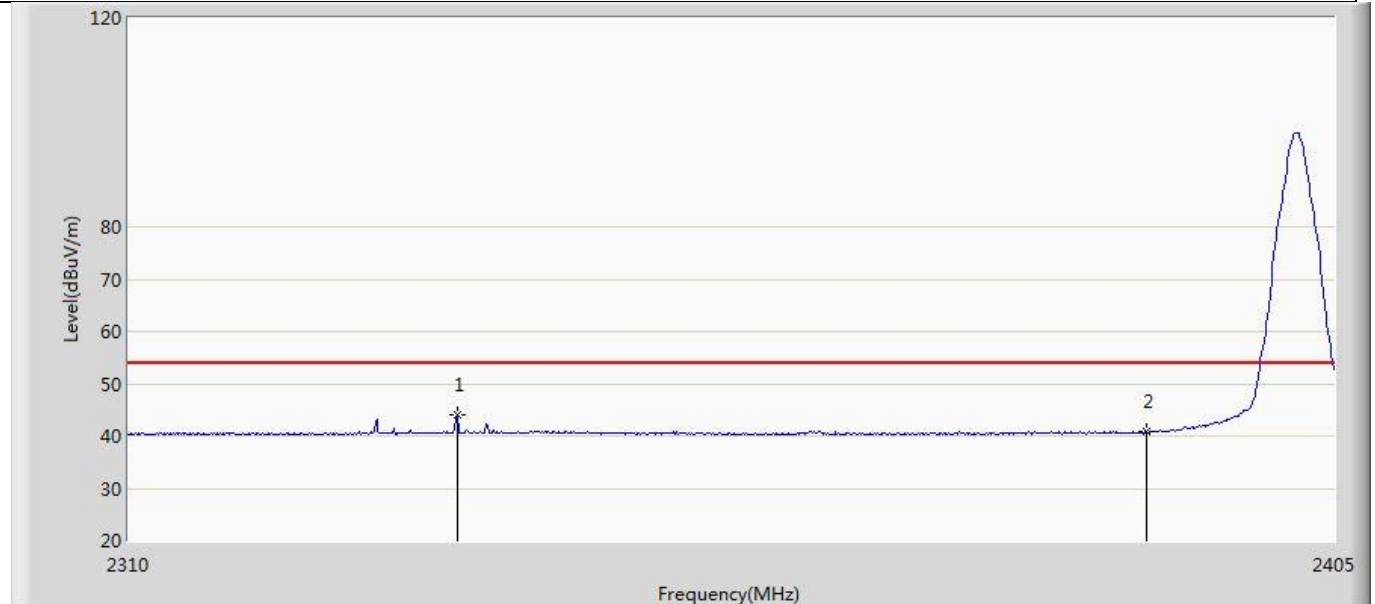

No	Mark	Frequency (MHz)	Measure Level (dBuV/m)	Reading Level (dBuV)	Over Limit (dB)	Limit (dBuV/m)	Factor (dB)	Type
1	*	2335.555	43.957	8.456	-10.043	54.000	35.500	AV
2		2390.000	40.742	5.283	-13.258	54.000	35.459	AV

Profile: 21C0118R	Page No.: 6
Engineer: Carlosshen	
Site: AC5	Time: 2021/05/25 - 20:23
Limit: FCC_Part15.209_RE(3m)	Margin: 0
Probe: Horn_3117_00123988_(1-18GHz)	Polarity: Vertical
EUT: LED Device	Power: AC 120V/60Hz
Note: Mode 2:Transmit at 2402MHz by LE_2Mbps	

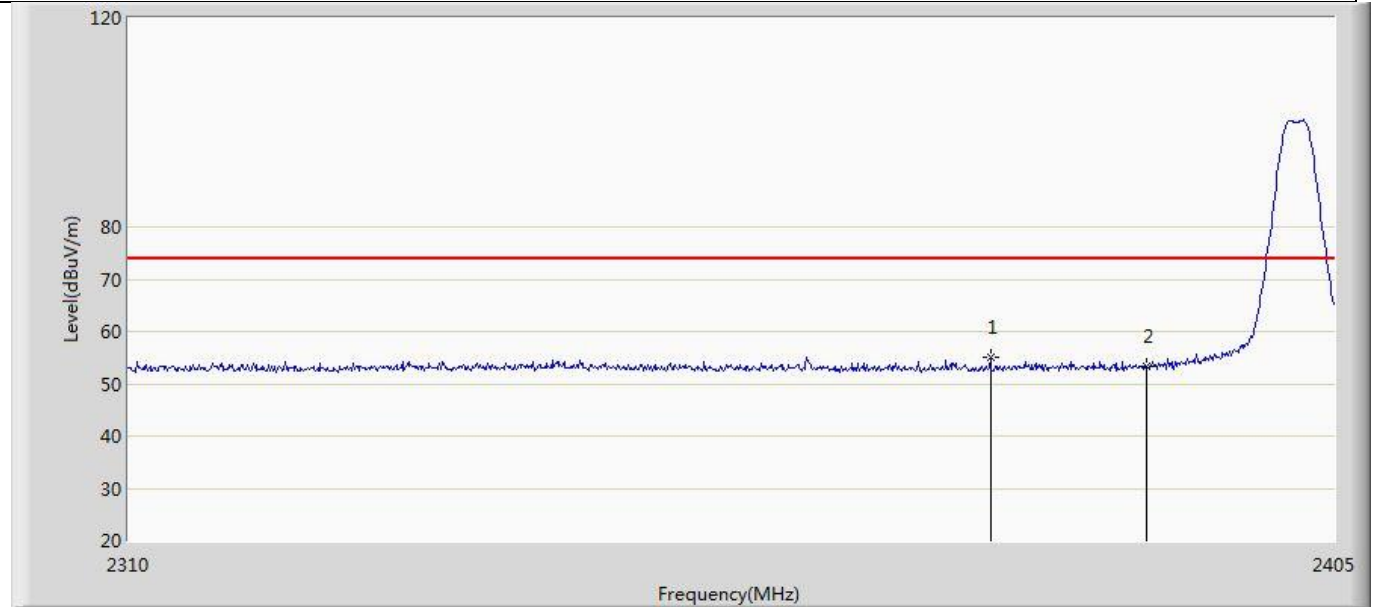

No	Mark	Frequency (MHz)	Measure Level (dBuV/m)	Reading Level (dBuV)	Over Limit (dB)	Limit (dBuV/m)	Factor (dB)	Type
1	*	2377.545	55.110	19.749	-18.890	74.000	35.361	PK
2		2390.000	53.334	17.875	-20.666	74.000	35.459	PK

Profile: 21C0118R	Page No.: 7
Engineer: Carlosshen	
Site: AC5	Time: 2021/05/25 - 20:25
Limit: FCC_Part15.209_RE(3m)	Margin: 0
Probe: Horn_3117_00123988_(1-18GHz)	Polarity: Horizontal
EUT: LED Device	Power: AC 120V/60Hz
Note: Mode 2:Transmit at 2402MHz by LE_2Mbps	

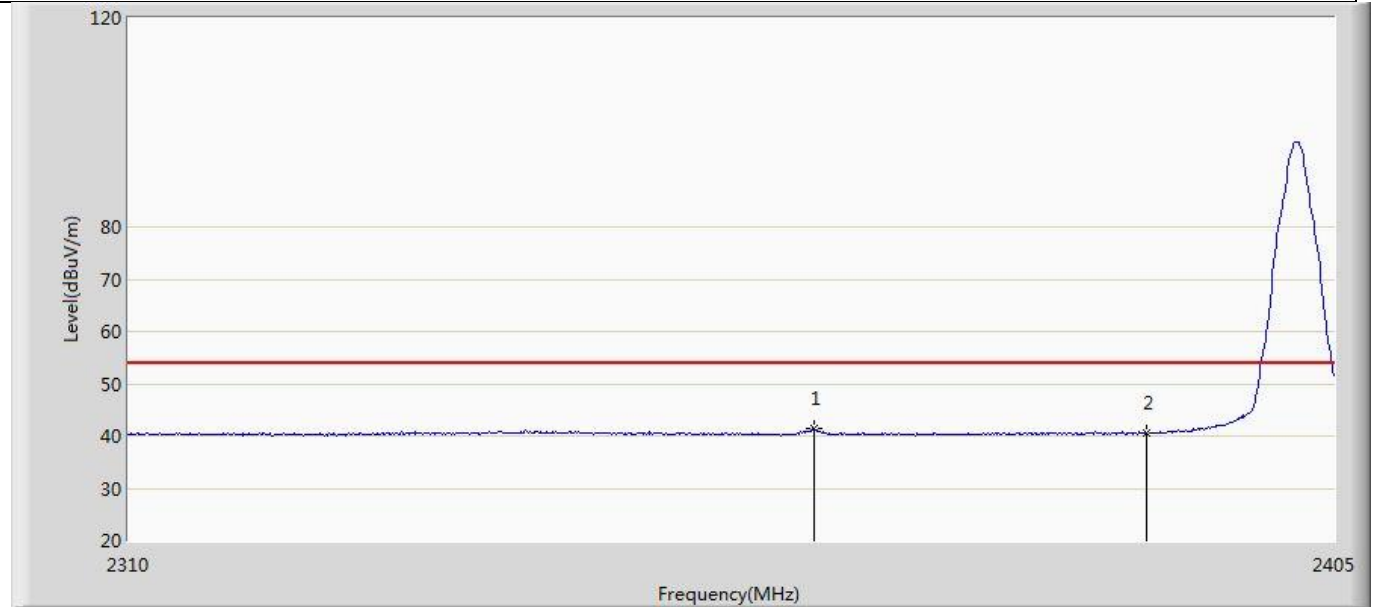

No	Mark	Frequency (MHz)	Measure Level (dBuV/m)	Reading Level (dBuV)	Over Limit (dB)	Limit (dBuV/m)	Factor (dB)	Type
1	*	2363.580	41.348	5.997	-12.652	54.000	35.351	AV
2		2390.000	40.609	5.150	-13.391	54.000	35.459	AV

Profile: 21C0118R	Page No.: 8
Engineer: Carlosshen	
Site: AC5	Time: 2021/05/25 - 20:26
Limit: FCC_Part15.209_RE(3m)	Margin: 0
Probe: Horn_3117_00123988_(1-18GHz)	Polarity: Horizontal
EUT: LED Device	Power: AC 120V/60Hz
Note: Mode 2:Transmit at 2402MHz by LE_2Mbps	

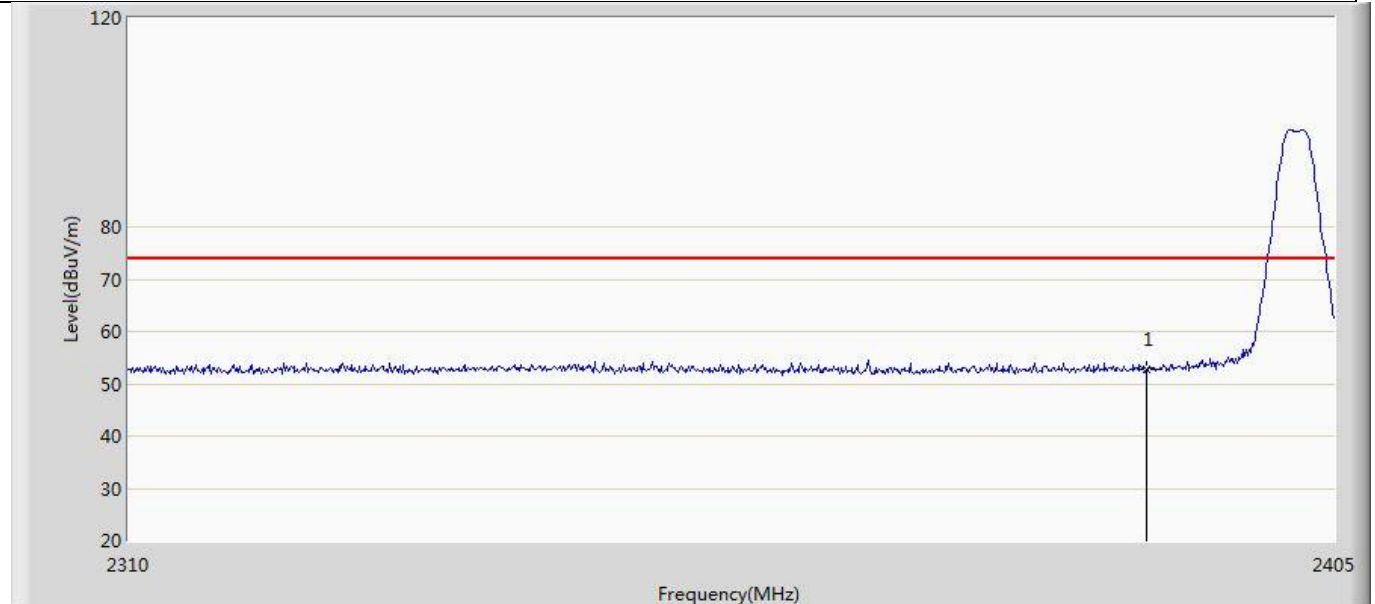

No	Mark	Frequency (MHz)	Measure Level (dBuV/m)	Reading Level (dBuV)	Over Limit (dB)	Limit (dBuV/m)	Factor (dB)	Type
1	*	2390.000	52.652	17.193	-21.348	74.000	35.459	PK

Profile: 21C0118R	Page No.: 21
Engineer: Carlosshen	
Site: AC5	Time: 2021/05/25 - 20:44
Limit: FCC_Part15.209_RE(3m)	Margin: 0
Probe: Horn_3117_00123988_(1-18GHz)	Polarity: Vertical
EUT: LED Device	Power: AC 120V/60Hz
Note: Mode 2:Transmit at 2480MHz by LE_2Mbps	

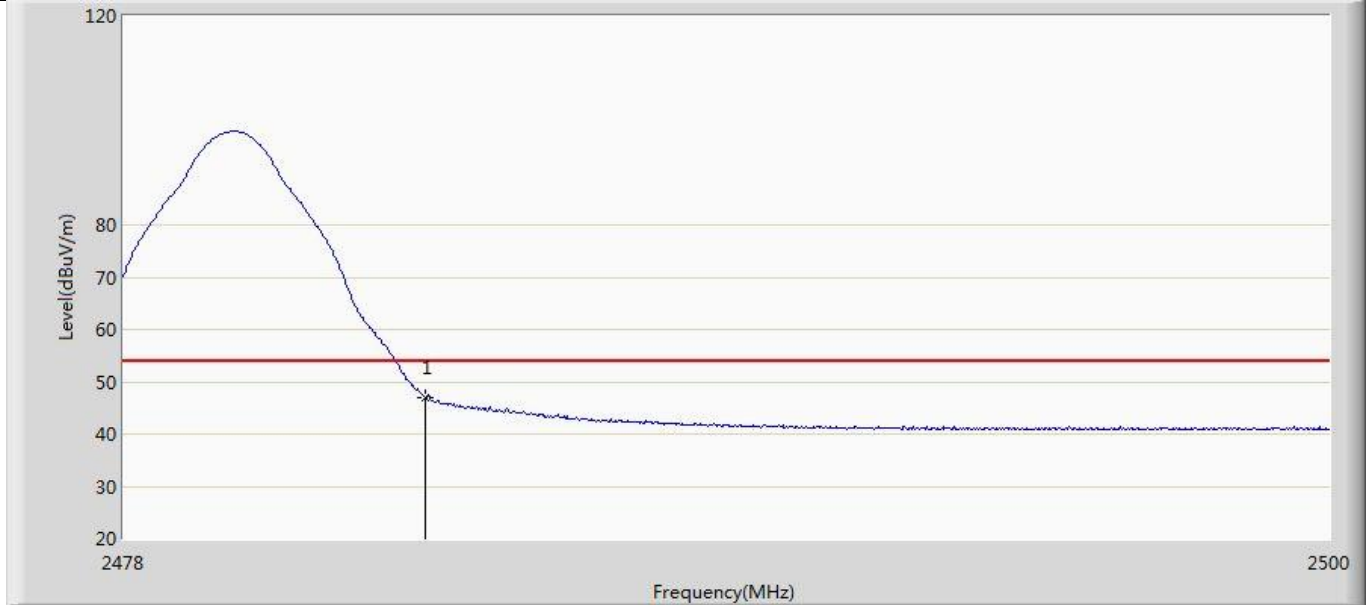

No	Mark	Frequency (MHz)	Measure Level (dBuV/m)	Reading Level (dBuV)	Over Limit (dB)	Limit (dBuV/m)	Factor (dB)	Type
1	*	2483.500	46.932	11.257	-7.068	54.000	35.675	AV

Profile: 21C0118R	Page No.: 22
Engineer: Carlosshen	
Site: AC5	Time: 2021/05/25 - 20:45
Limit: FCC_Part15.209_RE(3m)	Margin: 0
Probe: Horn_3117_00123988_(1-18GHz)	Polarity: Vertical
EUT: LED Device	Power: AC 120V/60Hz
Note: Mode 2:Transmit at 2480MHz by LE_2Mbps	

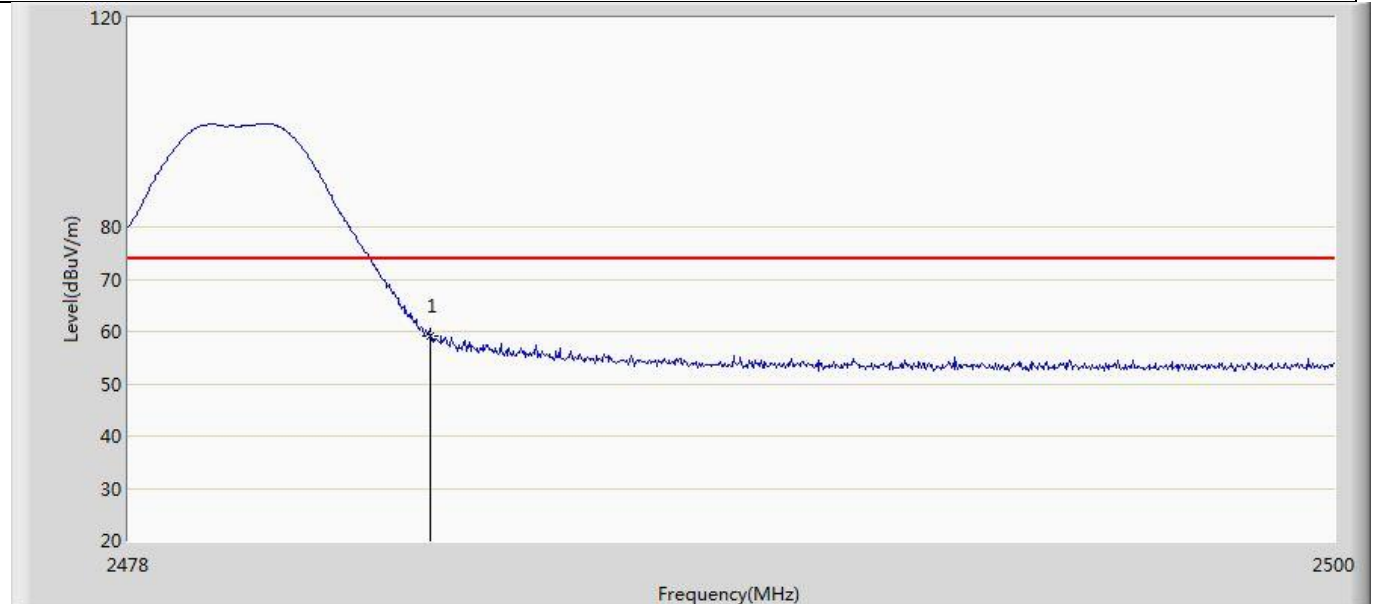

No	Mark	Frequency (MHz)	Measure Level (dBuV/m)	Reading Level (dBuV)	Over Limit (dB)	Limit (dBuV/m)	Factor (dB)	Type
1	*	2483.500	59.043	23.368	-14.957	74.000	35.675	PK

Profile: 21C0118R	Page No.: 23
Engineer: Carlosshen	
Site: AC5	Time: 2021/05/25 - 20:46
Limit: FCC_Part15.209_RE(3m)	Margin: 0
Probe: Horn_3117_00123988_(1-18GHz)	Polarity: Horizontal
EUT: LED Device	Power: AC 120V/60Hz
Note: Mode 2:Transmit at 2480MHz by LE_2Mbps	

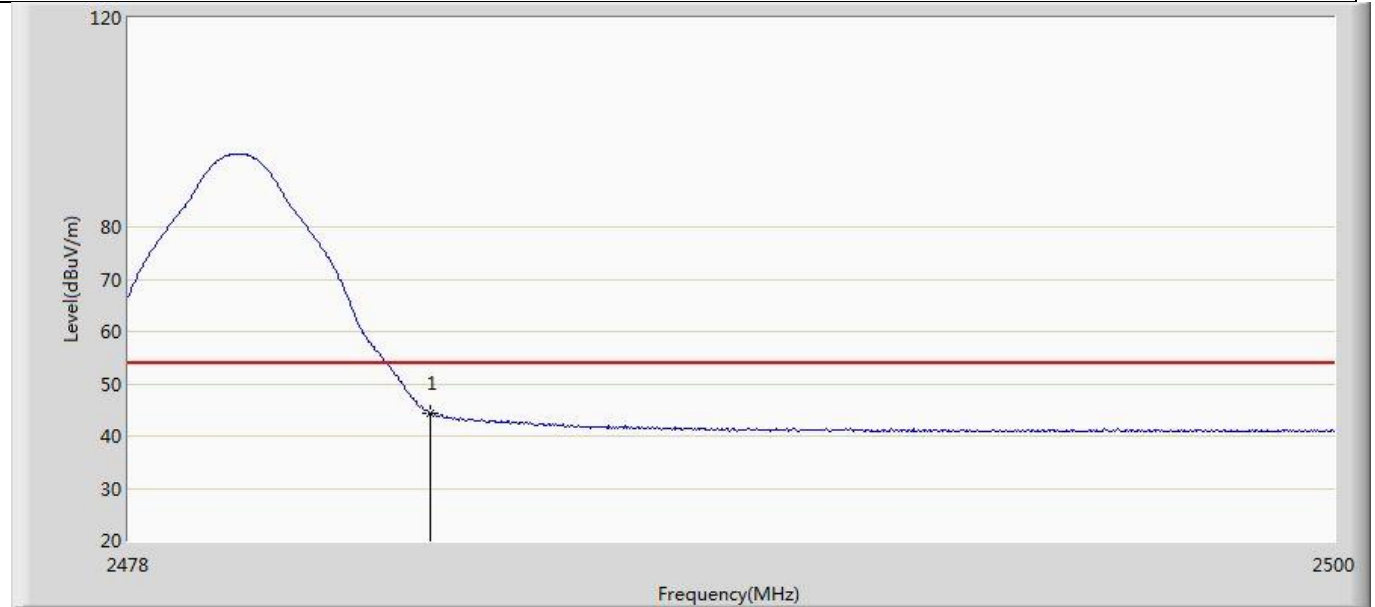

No	Mark	Frequency (MHz)	Measure Level (dBuV/m)	Reading Level (dBuV)	Over Limit (dB)	Limit (dBuV/m)	Factor (dB)	Type
1	*	2483.500	44.422	8.747	-9.578	54.000	35.675	AV

Profile: 21C0118R	Page No.: 24
Engineer: Carlosshen	
Site: AC5	Time: 2021/05/25 - 20:47
Limit: FCC_Part15.209_RE(3m)	Margin: 0
Probe: Horn_3117_00123988_(1-18GHz)	Polarity: Horizontal
EUT: LED Device	Power: AC 120V/60Hz
Note: Mode 2:Transmit at 2480MHz by LE_2Mbps	

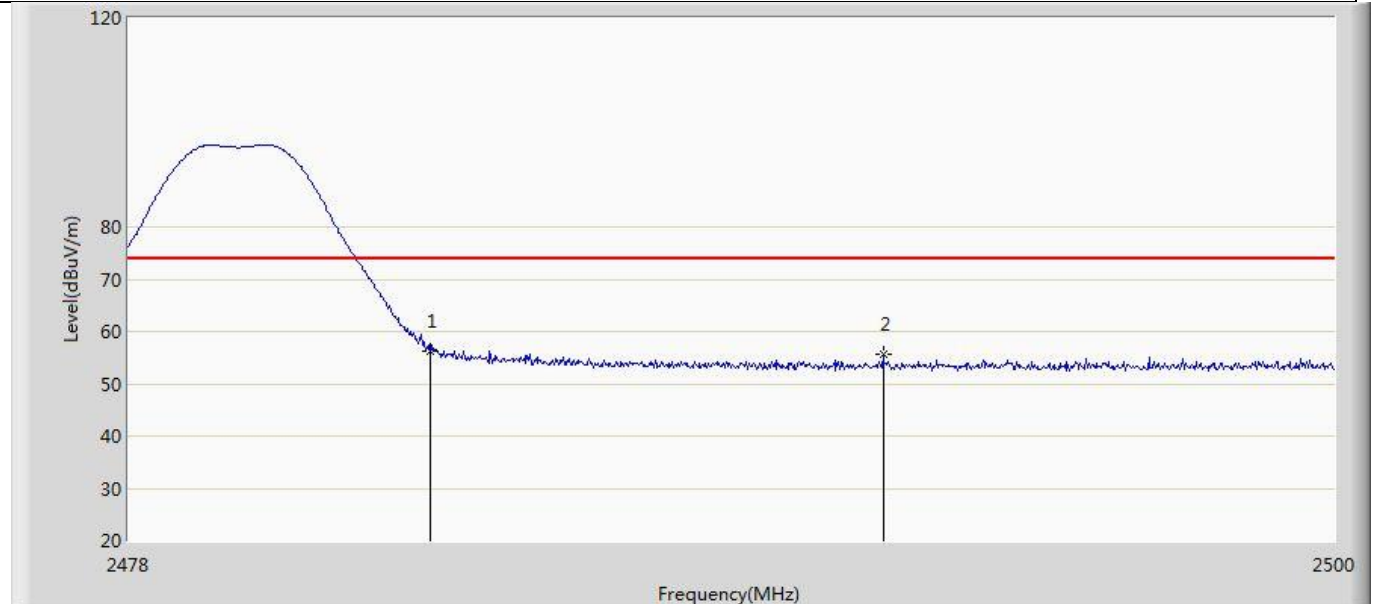

No	Mark	Frequency (MHz)	Measure Level (dBuV/m)	Reading Level (dBuV)	Over Limit (dB)	Limit (dBuV/m)	Factor (dB)	Type
1	*	2483.500	56.293	20.618	-17.707	74.000	35.675	PK
2		2491.750	55.779	20.088	-18.221	74.000	35.691	PK

Profile: 21C0118R	Page No.: 9
Engineer: Carlosshen	
Site: AC5	Time: 2021/05/25 - 20:27
Limit: FCC_Part15.209_RE(3m)	Margin: 0
Probe: Horn_3117_00123988_(1-18GHz)	Polarity: Vertical
EUT: LED Device	Power: AC 120V/60Hz
Note: Mode 3:Transmit at 2402MHz by Code S=8	

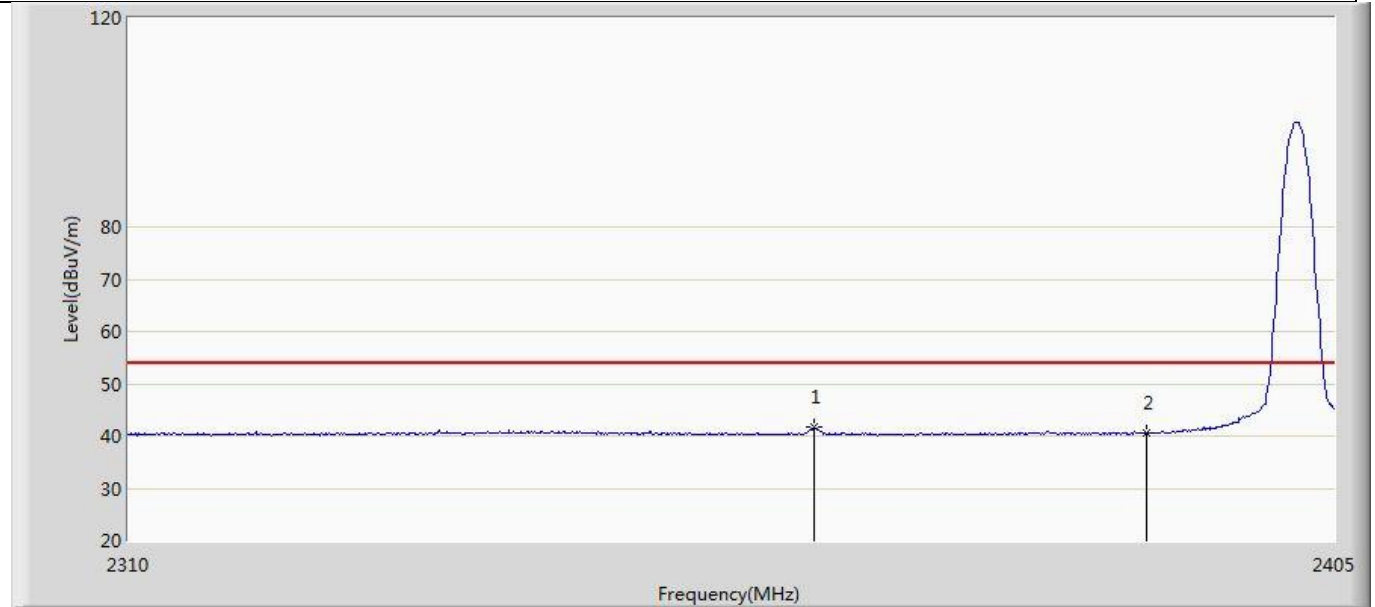

No	Mark	Frequency (MHz)	Measure Level (dBuV/m)	Reading Level (dBuV)	Over Limit (dB)	Limit (dBuV/m)	Factor (dB)	Type
1	*	2363.580	41.720	6.369	-12.280	54.000	35.351	AV
2		2390.000	40.540	5.081	-13.460	54.000	35.459	AV

Profile: 21C0118R	Page No.: 10
Engineer: Carlosshen	
Site: AC5	Time: 2021/05/25 - 20:29
Limit: FCC_Part15.209_RE(3m)	Margin: 0
Probe: Horn_3117_00123988_(1-18GHz)	Polarity: Vertical
EUT: LED Device	Power: AC 120V/60Hz
Note: Mode 3:Transmit at 2402MHz by Code S=8	

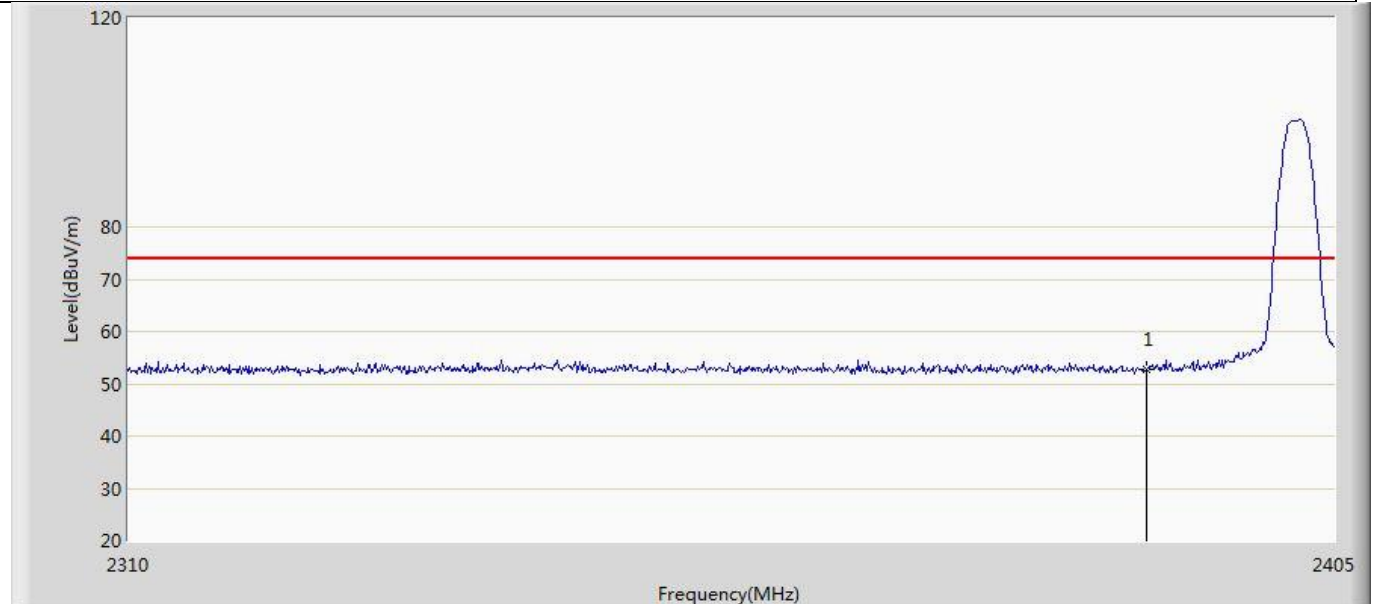

No	Mark	Frequency (MHz)	Measure Level (dBuV/m)	Reading Level (dBuV)	Over Limit (dB)	Limit (dBuV/m)	Factor (dB)	Type
1	*	2390.000	52.734	17.275	-21.266	74.000	35.459	PK

Profile: 21C0118R	Page No.: 11
Engineer: Carlosshen	
Site: AC5	Time: 2021/05/25 - 20:30
Limit: FCC_Part15.209_RE(3m)	Margin: 0
Probe: Horn_3117_00123988_(1-18GHz)	Polarity: Horizontal
EUT: LED Device	Power: AC 120V/60Hz
Note: Mode 3:Transmit at 2402MHz by Code S=8	

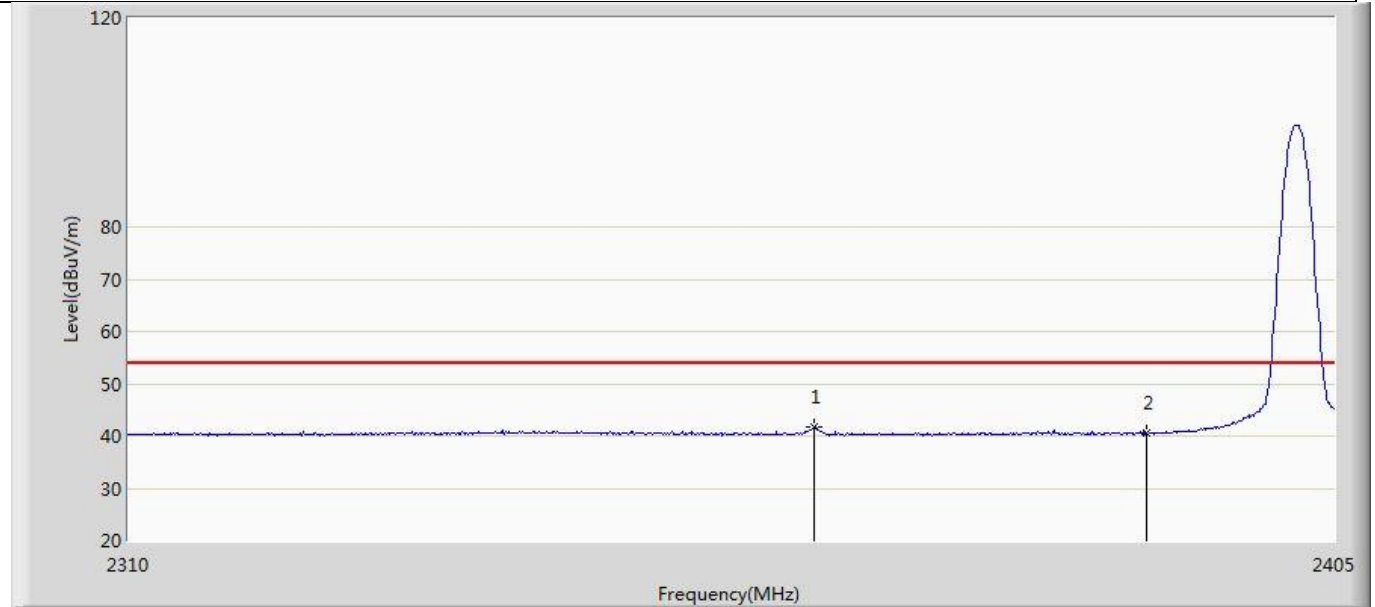

No	Mark	Frequency (MHz)	Measure Level (dBuV/m)	Reading Level (dBuV)	Over Limit (dB)	Limit (dBuV/m)	Factor (dB)	Type
1	*	2363.580	41.604	6.253	-12.396	54.000	35.351	AV
2		2390.000	40.490	5.031	-13.510	54.000	35.459	AV

Profile: 21C0118R	Page No.: 12
Engineer: Carlosshen	
Site: AC5	Time: 2021/05/25 - 20:31
Limit: FCC_Part15.209_RE(3m)	Margin: 0
Probe: Horn_3117_00123988_(1-18GHz)	Polarity: Horizontal
EUT: LED Device	Power: AC 120V/60Hz
Note: Mode 3:Transmit at 2402MHz by Code S=8	

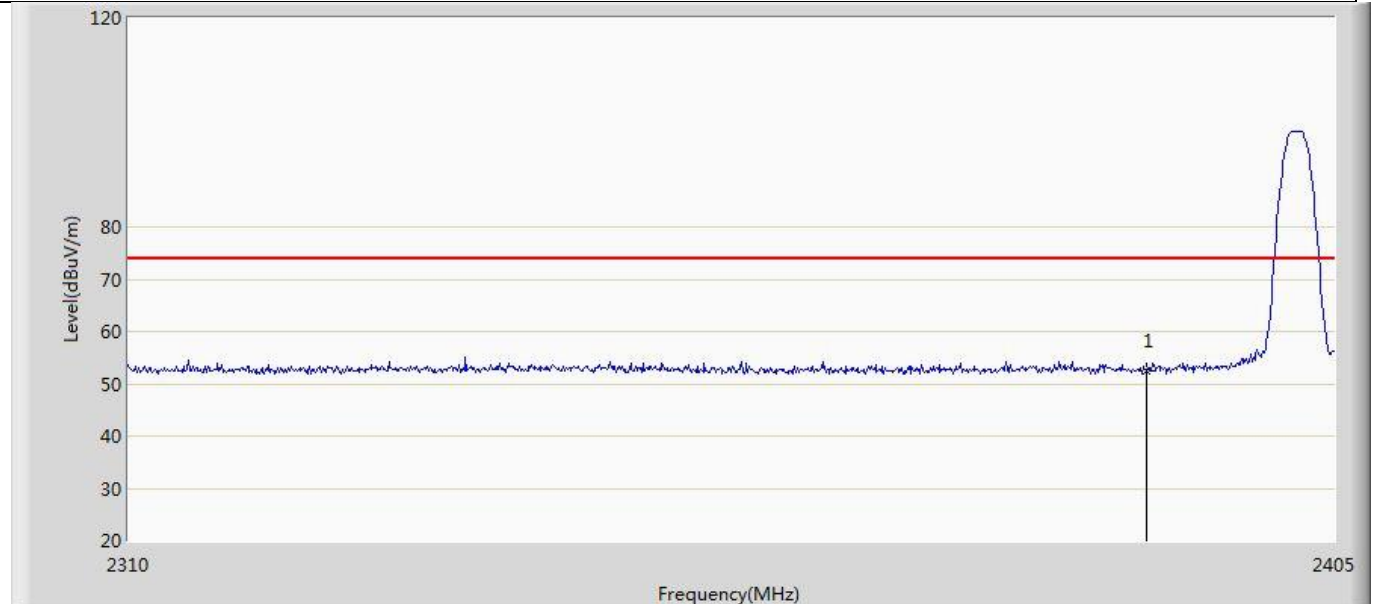

No	Mark	Frequency (MHz)	Measure Level (dBuV/m)	Reading Level (dBuV)	Over Limit (dB)	Limit (dBuV/m)	Factor (dB)	Type
1	*	2390.000	52.592	17.133	-21.408	74.000	35.459	PK

Profile: 21C0118R	Page No.: 25
Engineer: Carlosshen	
Site: AC5	Time: 2021/05/25 - 20:48
Limit: FCC_Part15.209_RE(3m)	Margin: 0
Probe: Horn_3117_00123988_(1-18GHz)	Polarity: Vertical
EUT: LED Device	Power: AC 120V/60Hz
Note: Mode 3:Transmit at 2480MHz by Code S=8	

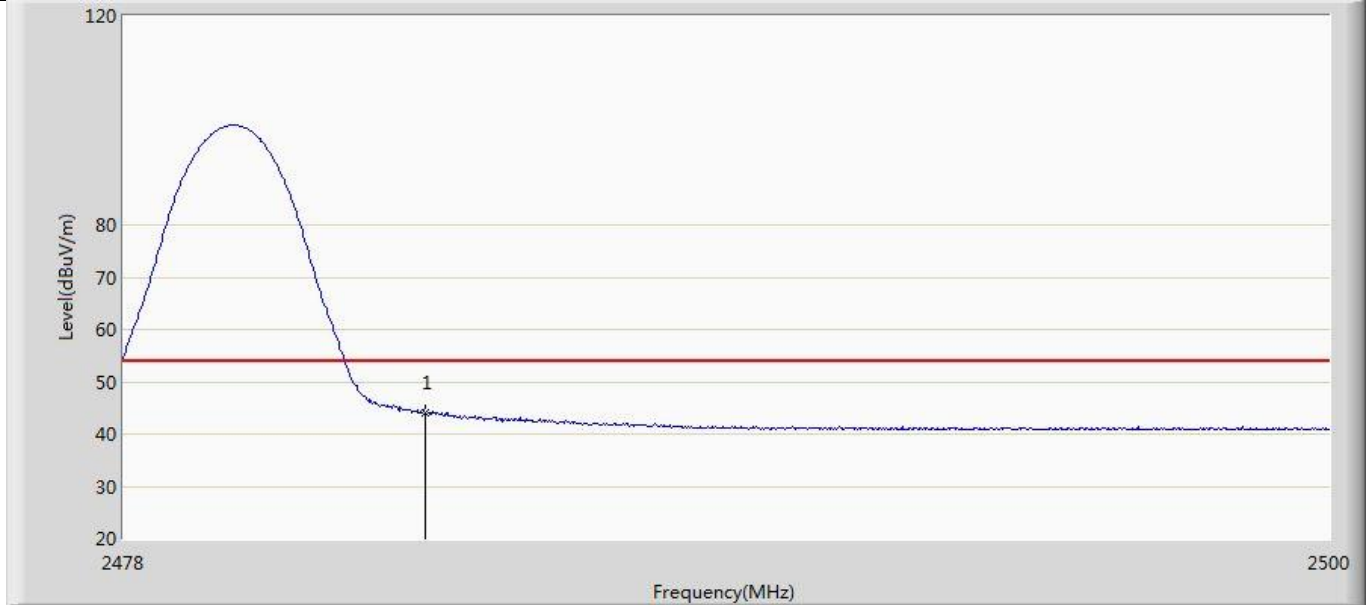

No	Mark	Frequency (MHz)	Measure Level (dBuV/m)	Reading Level (dBuV)	Over Limit (dB)	Limit (dBuV/m)	Factor (dB)	Type
1	*	2483.500	43.931	8.256	-10.069	54.000	35.675	AV

Profile: 21C0118R	Page No.: 26
Engineer: Carlosshen	
Site: AC5	Time: 2021/05/25 - 20:50
Limit: FCC_Part15.209_RE(3m)	Margin: 0
Probe: Horn_3117_00123988_(1-18GHz)	Polarity: Vertical
EUT: LED Device	Power: AC 120V/60Hz
Note: Mode 3:Transmit at 2480MHz by Code S=8	

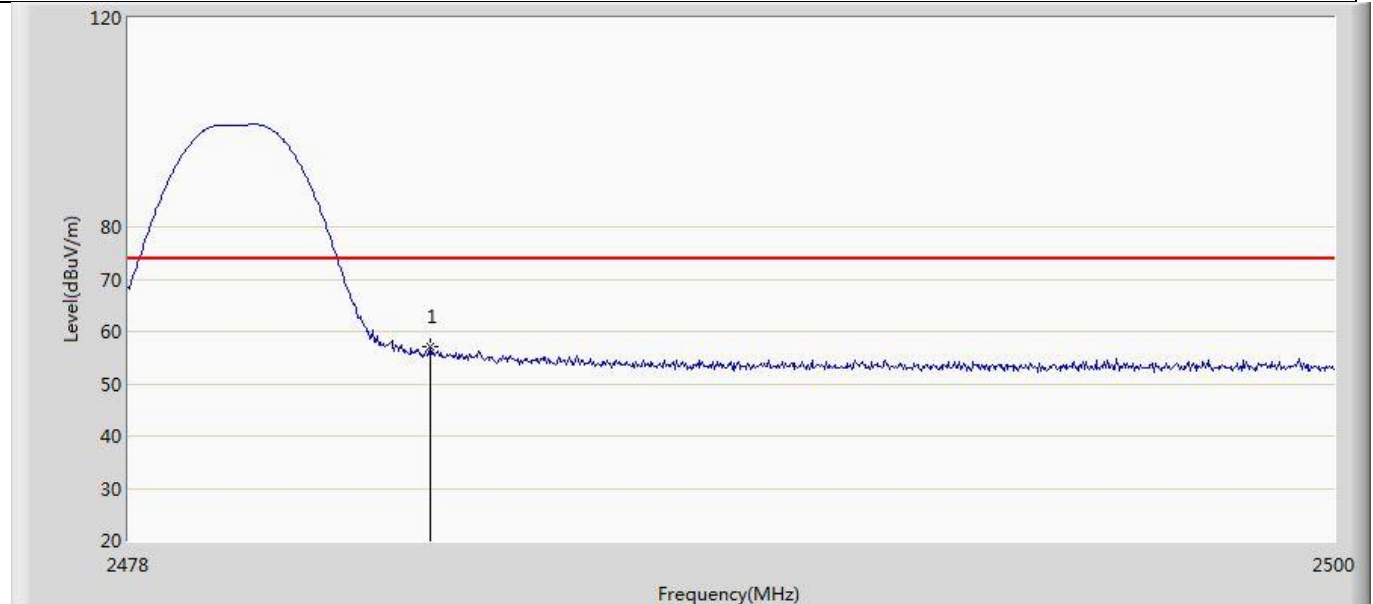

No	Mark	Frequency (MHz)	Measure Level (dBuV/m)	Reading Level (dBuV)	Over Limit (dB)	Limit (dBuV/m)	Factor (dB)	Type
1	*	2483.500	57.129	21.454	-16.871	74.000	35.675	PK

Profile: 21C0118R	Page No.: 27
Engineer: Carlosshen	
Site: AC5	Time: 2021/05/25 - 20:50
Limit: FCC_Part15.209_RE(3m)	Margin: 0
Probe: Horn_3117_00123988_(1-18GHz)	Polarity: Horizontal
EUT: LED Device	Power: AC 120V/60Hz
Note: Mode 3:Transmit at 2480MHz by Code S=8	

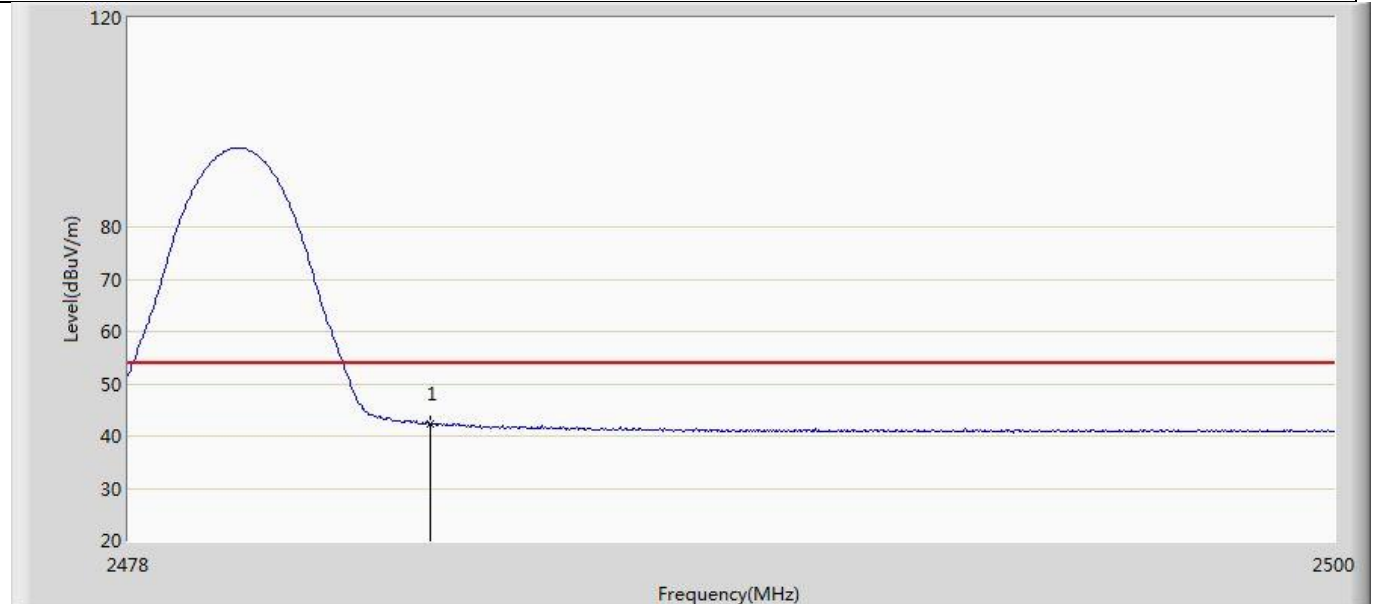

No	Mark	Frequency (MHz)	Measure Level (dBuV/m)	Reading Level (dBuV)	Over Limit (dB)	Limit (dBuV/m)	Factor (dB)	Type
1	*	2483.500	42.309	6.634	-11.691	54.000	35.675	AV

Profile: 21C0118R	Page No.: 28
Engineer: Carlosshen	
Site: AC5	Time: 2021/05/25 - 20:51
Limit: FCC_Part15.209_RE(3m)	Margin: 0
Probe: Horn_3117_00123988_(1-18GHz)	Polarity: Horizontal
EUT: LED Device	Power: AC 120V/60Hz
Note: Mode 3:Transmit at 2480MHz by Code S=8	

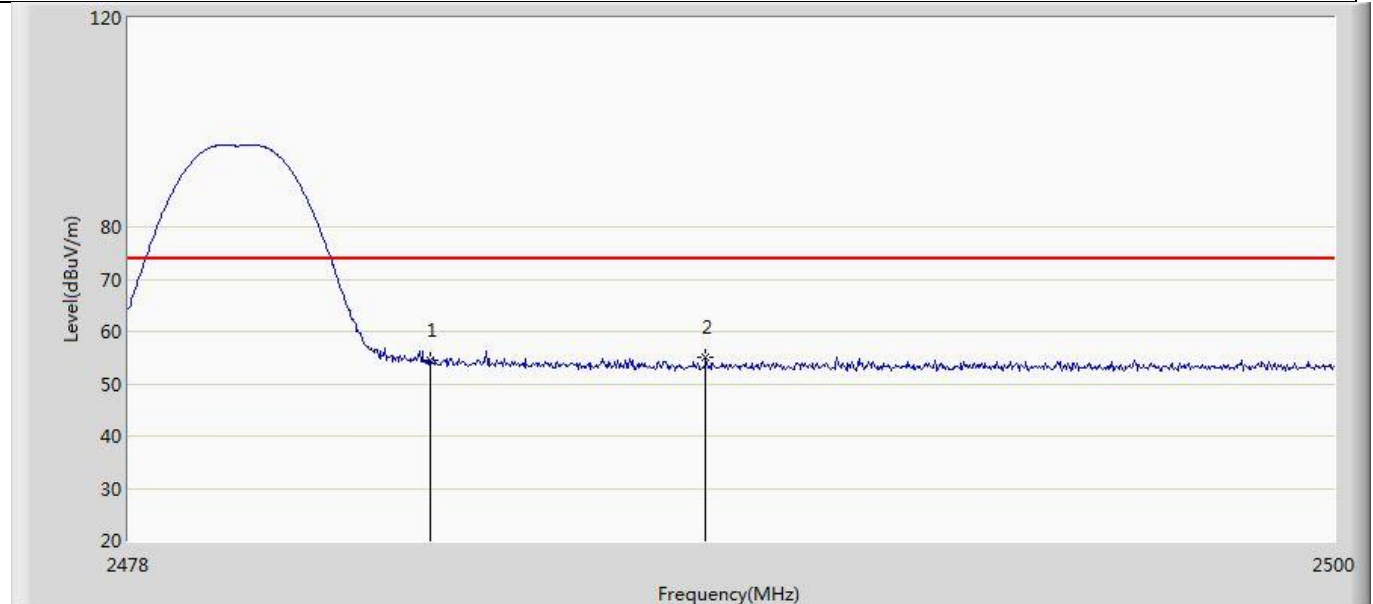

No	Mark	Frequency (MHz)	Measure Level (dBuV/m)	Reading Level (dBuV)	Over Limit (dB)	Limit (dBuV/m)	Factor (dB)	Type
1		2483.500	54.368	18.693	-19.632	74.000	35.675	PK
2	*	2488.516	55.162	19.477	-18.838	74.000	35.685	PK

Profile: 21C0118R	Page No.: 13
Engineer: Carlosshen	
Site: AC5	Time: 2021/05/25 - 20:33
Limit: FCC_Part15.209_RE(3m)	Margin: 0
Probe: Horn_3117_00123988_(1-18GHz)	Polarity: Vertical
EUT: LED Device	Power: AC 120V/60Hz
Note: Mode 4:Transmit at 2402MHz by Code S=2	

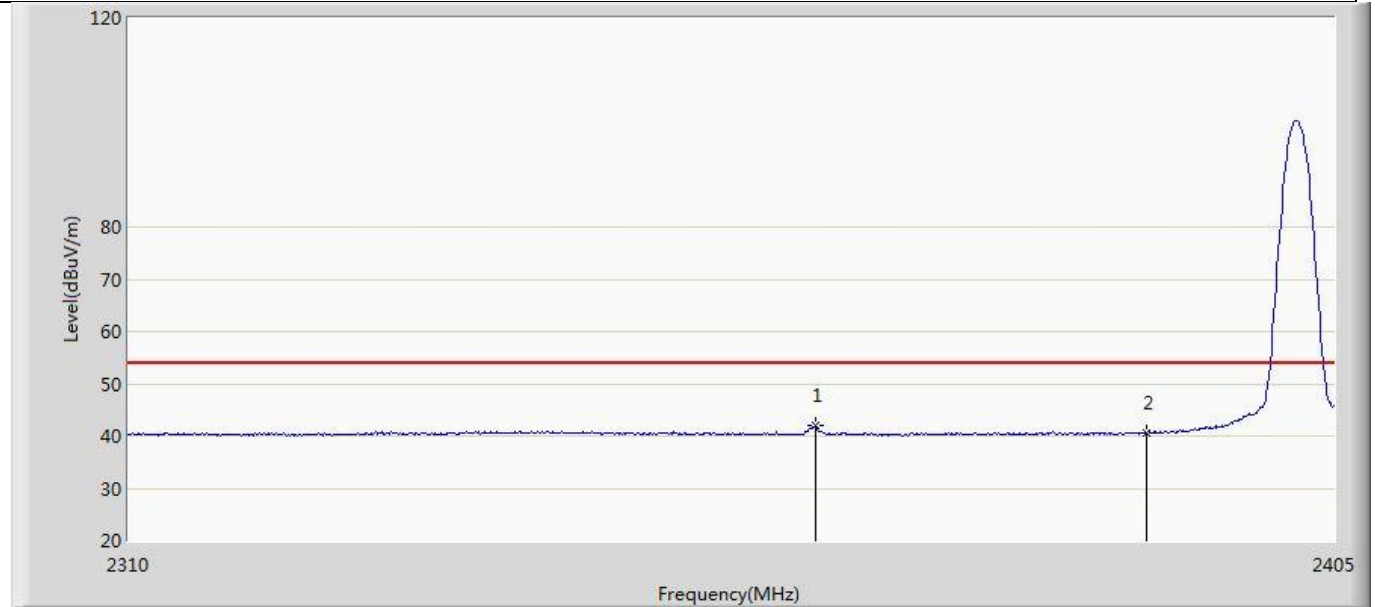

No	Mark	Frequency (MHz)	Measure Level (dBuV/m)	Reading Level (dBuV)	Over Limit (dB)	Limit (dBuV/m)	Factor (dB)	Type
1	*	2363.675	41.921	6.570	-12.079	54.000	35.351	AV
2		2390.000	40.443	4.984	-13.557	54.000	35.459	AV

Profile: 21C0118R	Page No.: 14
Engineer: Carlosshen	
Site: AC5	Time: 2021/05/25 - 20:35
Limit: FCC_Part15.209_RE(3m)	Margin: 0
Probe: Horn_3117_00123988_(1-18GHz)	Polarity: Vertical
EUT: LED Device	Power: AC 120V/60Hz
Note: Mode 4:Transmit at 2402MHz by Code S=2	

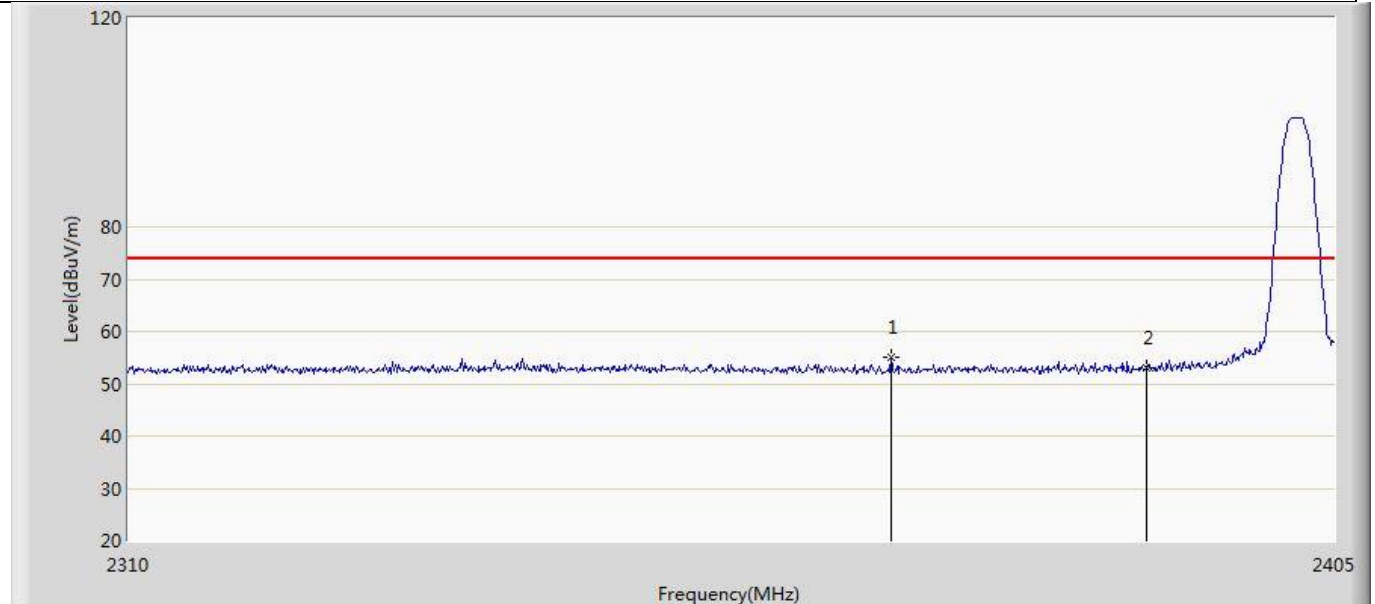

No	Mark	Frequency (MHz)	Measure Level (dBuV/m)	Reading Level (dBuV)	Over Limit (dB)	Limit (dBuV/m)	Factor (dB)	Type
1	*	2369.660	54.974	19.620	-19.026	74.000	35.354	PK
2		2390.000	53.086	17.627	-20.914	74.000	35.459	PK

Profile: 21C0118R	Page No.: 15
Engineer: Carlosshen	
Site: AC5	Time: 2021/05/25 - 20:36
Limit: FCC_Part15.209_RE(3m)	Margin: 0
Probe: Horn_3117_00123988_(1-18GHz)	Polarity: Horizontal
EUT: LED Device	Power: AC 120V/60Hz
Note: Mode 4:Transmit at 2402MHz by Code S=2	

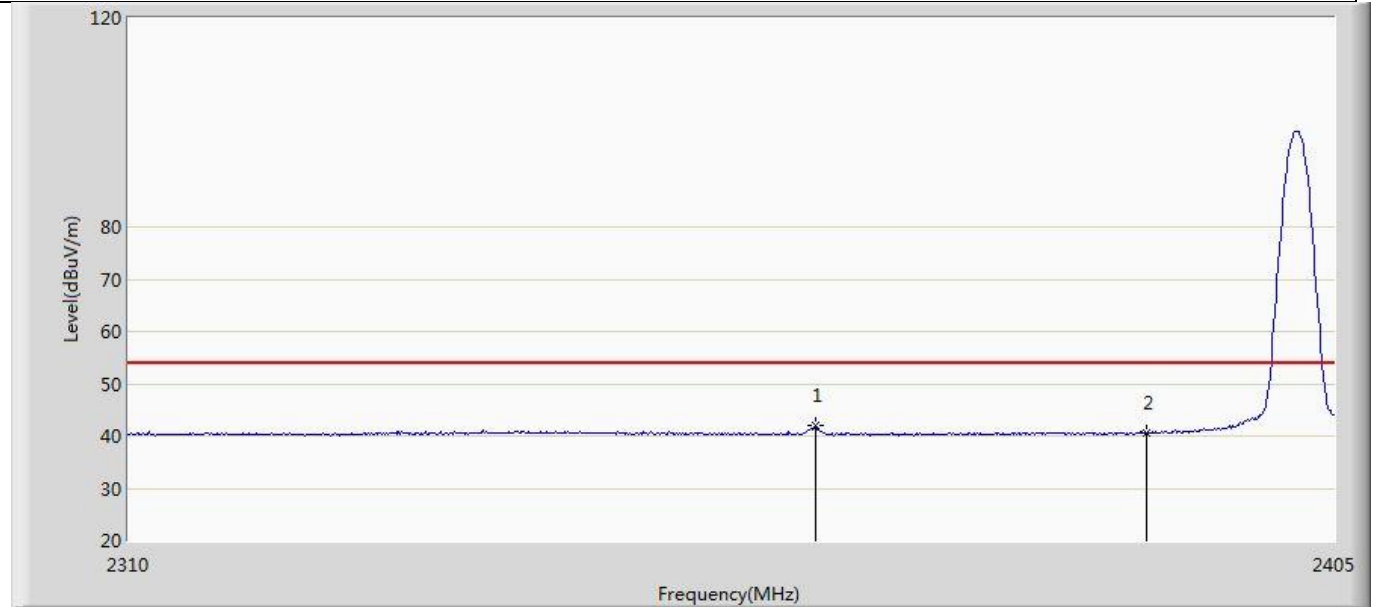

No	Mark	Frequency (MHz)	Measure Level (dBuV/m)	Reading Level (dBuV)	Over Limit (dB)	Limit (dBuV/m)	Factor (dB)	Type
1	*	2363.675	42.001	6.650	-11.999	54.000	35.351	AV
2		2390.000	40.582	5.123	-13.418	54.000	35.459	AV

Profile: 21C0118R	Page No.: 16
Engineer: Carlosshen	
Site: AC5	Time: 2021/05/25 - 20:37
Limit: FCC_Part15.209_RE(3m)	Margin: 0
Probe: Horn_3117_00123988_(1-18GHz)	Polarity: Horizontal
EUT: LED Device	Power: AC 120V/60Hz
Note: Mode 4:Transmit at 2402MHz by Code S=2	

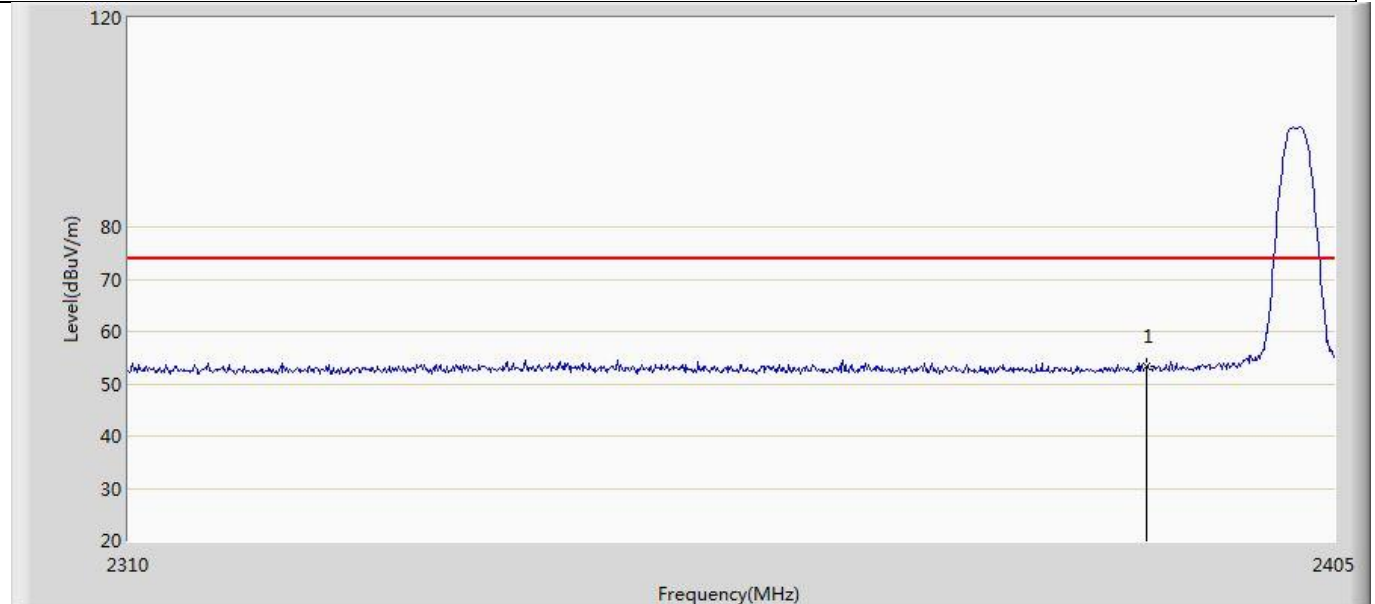

No	Mark	Frequency (MHz)	Measure Level (dBuV/m)	Reading Level (dBuV)	Over Limit (dB)	Limit (dBuV/m)	Factor (dB)	Type
1	*	2390.000	53.425	17.966	-20.575	74.000	35.459	PK

Profile: 21C0118R	Page No.: 29
Engineer: Carlosshen	
Site: AC5	Time: 2021/05/25 - 20:52
Limit: FCC_Part15.209_RE(3m)	Margin: 0
Probe: Horn_3117_00123988_(1-18GHz)	Polarity: Vertical
EUT: LED Device	Power: AC 120V/60Hz
Note: Mode 4:Transmit at 2480MHz by Code S=2	

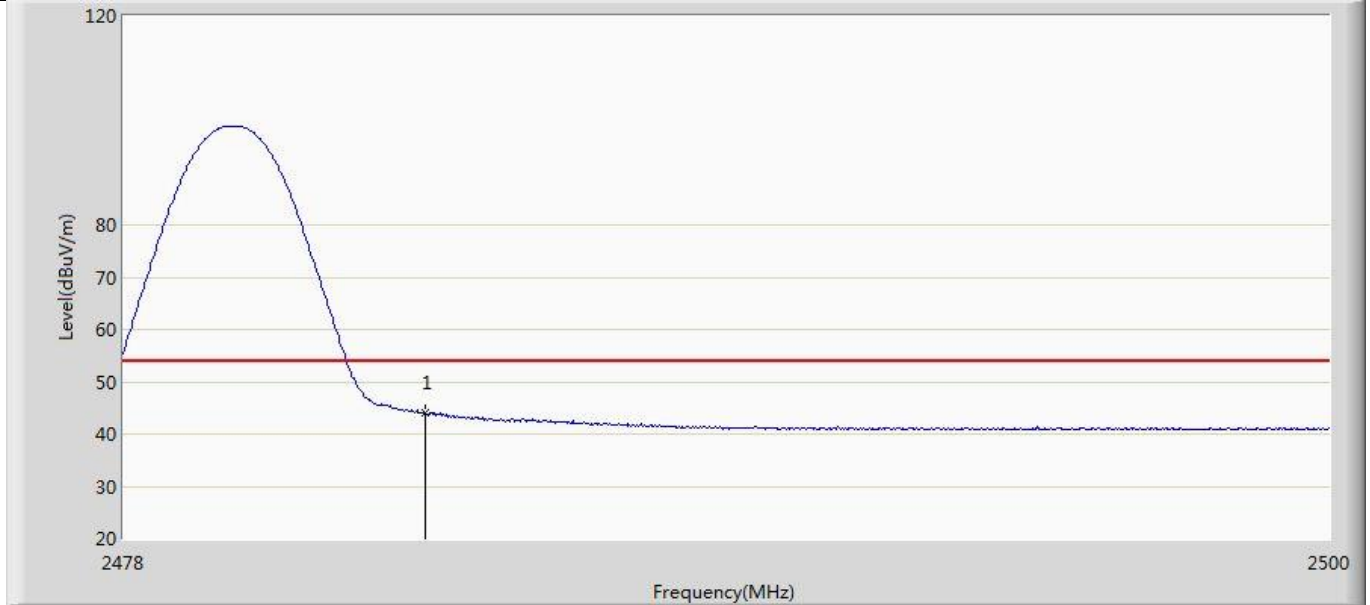

No	Mark	Frequency (MHz)	Measure Level (dBuV/m)	Reading Level (dBuV)	Over Limit (dB)	Limit (dBuV/m)	Factor (dB)	Type
1	*	2483.500	43.939	8.264	-10.061	54.000	35.675	AV

Profile: 21C0118R	Page No.: 30
Engineer: Carlosshen	
Site: AC5	Time: 2021/05/25 - 20:53
Limit: FCC_Part15.209_RE(3m)	Margin: 0
Probe: Horn_3117_00123988_(1-18GHz)	Polarity: Vertical
EUT: LED Device	Power: AC 120V/60Hz
Note: Mode 4:Transmit at 2480MHz by Code S=2	

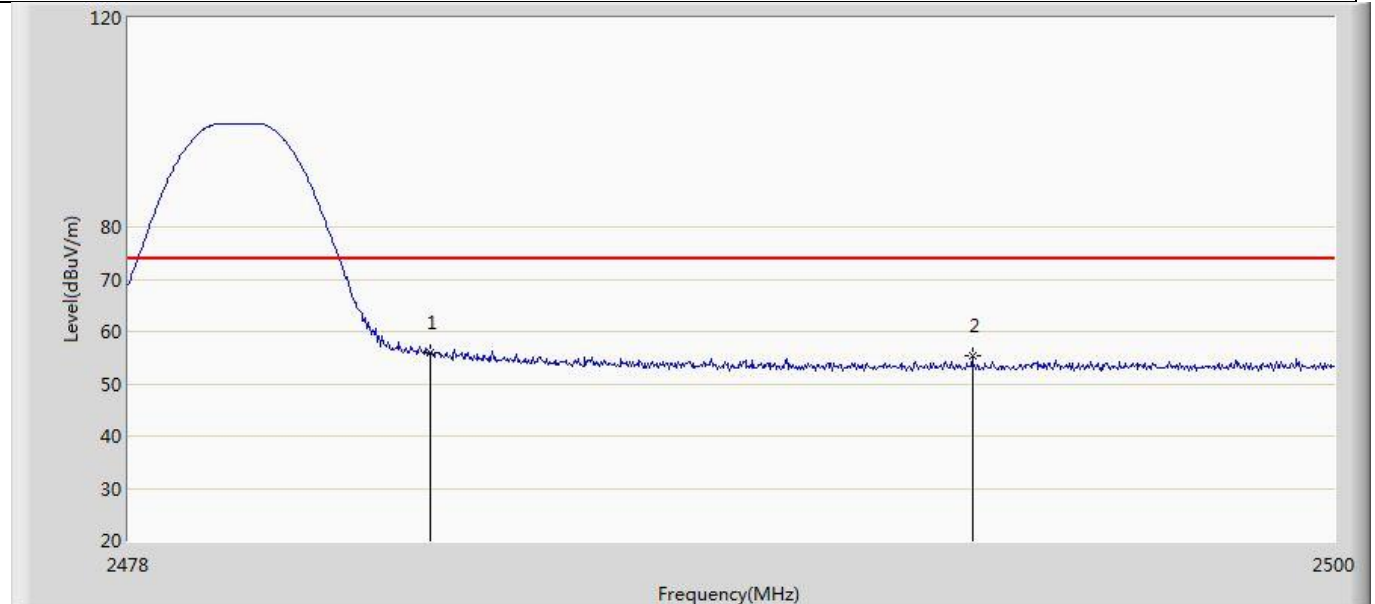

No	Mark	Frequency (MHz)	Measure Level (dBuV/m)	Reading Level (dBuV)	Over Limit (dB)	Limit (dBuV/m)	Factor (dB)	Type
1	*	2483.500	56.027	20.352	-17.973	74.000	35.675	PK
2		2493.378	55.362	19.668	-18.638	74.000	35.694	PK

Profile: 21C0118R	Page No.: 31
Engineer: Carlosshen	
Site: AC5	Time: 2021/05/25 - 20:54
Limit: FCC_Part15.209_RE(3m)	Margin: 0
Probe: Horn_3117_00123988_(1-18GHz)	Polarity: Horizontal
EUT: LED Device	Power: AC 120V/60Hz
Note: Mode 4:Transmit at 2480MHz by Code S=2	

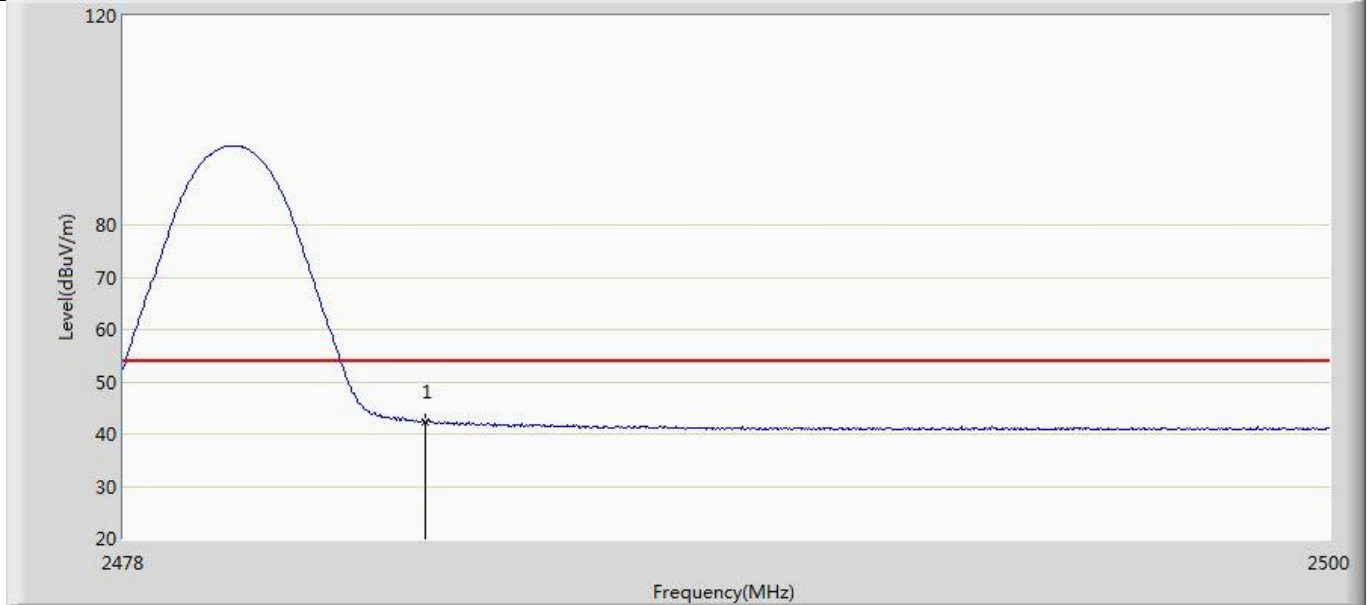

No	Mark	Frequency (MHz)	Measure Level (dBuV/m)	Reading Level (dBuV)	Over Limit (dB)	Limit (dBuV/m)	Factor (dB)	Type
1	*	2483.500	42.328	6.653	-11.672	54.000	35.675	AV

Profile: 21C0118R	Page No.: 32
Engineer: Carlosshen	
Site: AC5	Time: 2021/05/25 - 20:55
Limit: FCC_Part15.209_RE(3m)	Margin: 0
Probe: Horn_3117_00123988_(1-18GHz)	Polarity: Horizontal
EUT: LED Device	Power: AC 120V/60Hz
Note: Mode 4:Transmit at 2480MHz by Code S=2	

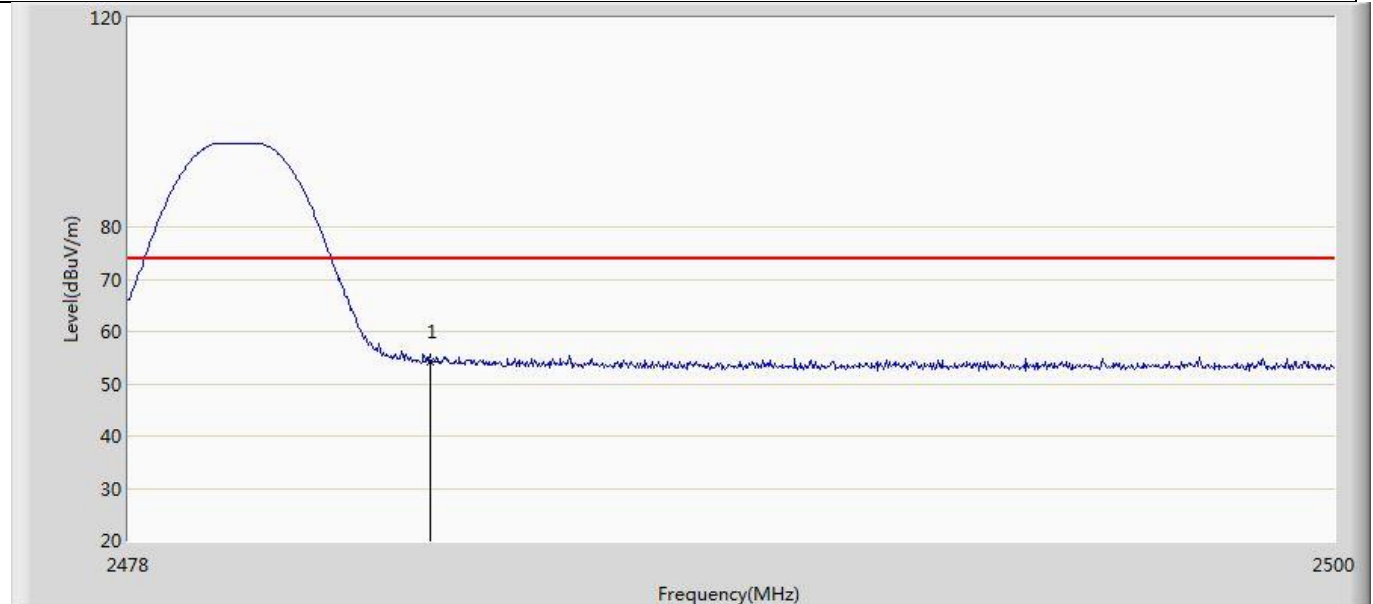

No	Mark	Frequency (MHz)	Measure Level (dBuV/m)	Reading Level (dBuV)	Over Limit (dB)	Limit (dBuV/m)	Factor (dB)	Type
1	*	2483.500	54.101	18.426	-19.899	74.000	35.675	PK

4.4 Fundamental emission output power	VERDICT: PASS
--	----------------------

4.4.1 Limit

Standard	FCC Part 15 Subpart C Paragraph 15.247 (b)(3)	
<input checked="" type="checkbox"/> GTX < 6dBi	Pout ≤ 30dBm	
<input type="checkbox"/> GTX > 6dBi		
<input type="checkbox"/> Non-Fix point-point	Pout ≤ 30 - (GTX - 6)	
<input type="checkbox"/> Fix point-point	Pout ≤ 30 - [(GTX - 6)]/3	
<input type="checkbox"/> Point-to-multipoint	Pout ≤ 30 - (GTX - 6)	
<input type="checkbox"/> Overlap Beams	Pout ≤ 30 - [(GTX - 6)]/3	
<input type="checkbox"/> Aggregate power transmitted simultaneously on all beams	Pout ≤ 30 - [(GTX - 6)]/3	
<input type="checkbox"/> single directional beam	Pout ≤ 30 - [(GTX - 6)]/3 + 8dB	

Note 1 : GTX directional gain of transmitting antennas.

Note 2 : Pout is maximum peak conducted output power .

4.4.2 Test Setup

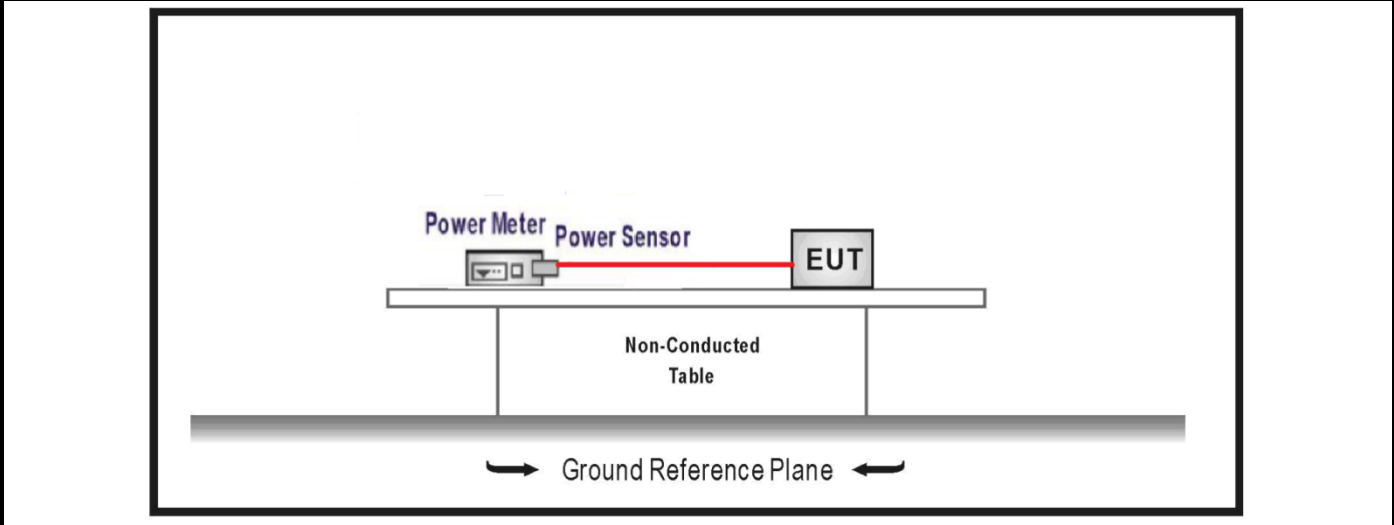

4.4.3 Test Procedure				
	References Rule		Chapter	Description
<input checked="" type="checkbox"/>	ANSI C63.10		11.9	Fundamental emission output power
	<input checked="" type="checkbox"/>	ANSI C63.10	11.9.1	Maximum peak conducted output power
	<input type="checkbox"/>	ANSI C63.10	11.9.1.1	RBW \geq DTS bandwidth
	<input type="checkbox"/>	ANSI C63.10	11.9.1.2	Integrated band power method
	<input type="checkbox"/>	ANSI C63.10	11.9.1.3	PKPM1 Peak power meter method
	<input type="checkbox"/>	ANSI C63.10	11.9.2	Maximum conducted (average) output power
	<input type="checkbox"/>	ANSI C63.10	11.9.2.2	Measurement using a spectrum analyzer (SA)
	<input type="checkbox"/>	ANSI C63.10	11.9.2.2.2	Method AVGSA-1(Duty cycle \geq 98%)
	<input type="checkbox"/>	ANSI C63.10	11.9.2.2.3	Method AVGSA-1A(Duty cycle \geq 98%)
	<input type="checkbox"/>	ANSI C63.10	11.9.2.2.4	Method AVGSA-2(Duty cycle \leq 98%)
	<input type="checkbox"/>	ANSI C63.10	11.9.2.2.5	Method AVGSA-2A(Duty cycle \leq 98%)
	<input type="checkbox"/>	ANSI C63.10	11.9.2.2.4	Method AVGSA-3
	<input type="checkbox"/>	ANSI C63.10	11.9.2.2.5	Method AVGSA-3A
	<input checked="" type="checkbox"/>	ANSI C63.10	11.9.2.3	Measurement using a power meter (PM)
	<input checked="" type="checkbox"/>	ANSI C63.10	11.9.2.3.1	Method AVGPM
<input type="checkbox"/>	ANSI C63.10	11.9.2.3.2	Method AVGPM-G	

4.4.4 Test Data							
Mode	Channel	Test Frequency (MHz)	Power Output (dBm)	EIRP Power Output (dBm)	Limit (dBm)	EIRP Limit (dBm)	Result
Mode 1	00	2402	7.48	10.47	≤30	≤36	Pass
	19	2440	7.24	10.23	≤30	≤36	Pass
	39	2480	6.73	9.72	≤30	≤36	Pass
Mode 2	00	2402	8.62	11.61	≤30	≤36	Pass
	19	2440	8.39	11.38	≤30	≤36	Pass
	39	2480	7.85	10.84	≤30	≤36	Pass
Mode 3	00	2402	7.67	10.66	≤30	≤36	Pass
	19	2440	7.50	10.49	≤30	≤36	Pass
	39	2480	6.95	9.94	≤30	≤36	Pass
Mode 4	00	2402	7.71	10.70	≤30	≤36	Pass
	19	2440	7.48	10.47	≤30	≤36	Pass
	39	2480	6.91	9.90	≤30	≤36	Pass

5 TEST SETUP PHOTO AND EUT PHOTO

Remark: The test setup photo and EUT Photo please see appendix.

_____ The End _____