



Test Report

FCC Part15 Subpart C & RSS-247 Issue 2

Product Name : LED lamp
Model No. : 9290019532
FCC ID : 2AGBW9290019532X
IC : 20812-9532X

Applicant : Signify (China) Investment Co., Ltd.

Address : Building no.9, Lane 888, Tianlin Road, Minhang District,
Shanghai 200233, China

Date of Receipt : Mar. 05, 2019
Test Date : Mar. 06, 2019~ Apr. 05, 2019
Issued Date : Apr. 17, 2019
Report No. : 1932048R-RF-US-P06V01
Report Version : V1.0

The test results relate only to the samples tested.

The test results shown in the test report are traceable to the national/international standard through the calibration of the equipment and evaluated measurement uncertainty herein.

This report must not be used to claim product endorsement by A2LA or any agency of the government.

The test report shall not be reproduced without the written approval of DEKRA Testing & Certification (Suzhou) Co., Ltd.

Test Report Certification

Issued Date : Apr. 17, 2019
Report No. : 1932048R-RF-US-P06V01



Product Name : LED lamp
 Applicant : Signify (China) Investment Co., Ltd.
 Address : Building no.9, Lane 888, Tianlin Road, Minhang District, Shanghai 200233, China
 Manufacturer : Signify (China) Investment Co., Ltd.
 Address : Building no.9, Lane 888, Tianlin Road, Minhang District, Shanghai 200233, China
 Model No. : 9290019532
 FCC ID : 2AGBW9290019532X
 IC : 20812-9532X
 EUT Voltage : 110-130 Vac, 50-60 Hz, 6W
 Test Voltage : AC 120V/60Hz
 Brand Name : PHILIPS
 Applicable Standard : FCC CFR Title 47 Part 15 Subpart C: 2017
 KDB 558074 D01v05
 RSS 247: Issue2; RSS GEN: Issue5
 ANSI C63.4:2014; ANSI C63.10:2013;
 Test Result : Complied
 Performed Location : DEKRA Testing and Certification (Suzhou) Co., Ltd.
 No.99 Hongye Rd., Suzhou Industrial Park, Suzhou, 215006, Jiangsu, China
 TEL: +86-512-6251-5088 / FAX: +86-512-6251-5098
 FCC Designation Number: CN1199; IC Lab Code: 4075B

Documented By : Kitty Li
 (Adm. Specialist: Kitty Li)

Reviewed By : Frank He
 (Senior Project Manager: Frank He)

Approved By : Jack Zhang
 (Engineering Supervisor: Jack Zhang)

TABLE OF CONTENTS

Description	Page
1. General Information.....	6
1.1. EUT Description	6
1.2. Working Frequency of Each Channel:	7
1.3. Antenna information	7
1.4. Mode of Operation.....	8
1.5. Tested System Details	8
1.6. Configuration of Tested System.....	9
1.7. EUT Exercise Software.....	10
2. Technical Test.....	11
2.1. Summary of Test Result.....	11
2.2. Test Environment.....	13
2.3. Measurement Uncertainty	13
3. AC Power Line Conducted Emission	14
3.1. Test Equipment.....	14
3.2. Test Setup.....	14
3.3. Limit.....	15
3.4. Test Procedure	15
3.5. Test Result.....	16
4. Emissions in restricted frequency bands	18
4.1. Test Equipment.....	18
4.2. Test Setup.....	19
4.3. Limit.....	20
4.4. Test Procedure	20
4.5. EUT test Axis definition.....	24
4.6. Test Result.....	25
5. Emissions in non-restricted frequency bands	45
5.1. Test Equipment.....	45
5.2. Test Setup.....	45
5.3. Limit.....	46
5.4. Test Procedure	47
5.5. EUT test Axis definition.....	48
5.6. Test Result.....	49
6. Radiated Emission Band Edge	50
6.1. Test Equipment.....	50
6.2. Test Setup.....	51
6.3. Limit.....	51
6.4. Test Procedure	52

- 6.5. EUT test definition 53
- 6.6. Duty Cycle 54
- 6.7. Test Result 55
- 7. Occupied Bandwidth 79
- 7.1. Test Equipment..... 79
- 7.2. Test Setup..... 79
- 7.3. Limit..... 80
- 7.4. Test Procedure 80
- 7.5. EUT test definition 81
- 7.6. Test Result..... 82
- 8. Fundamental emission output power 86
- 8.1. Test Equipment..... 86
- 8.2. Test Setup..... 86
- 8.3. Limit..... 87
- 8.4. Test Procedure 88
- 8.5. EUT test definition 89
- 8.6. Test Result..... 90
- 9. Power Spectral Density 91
- 9.1. Test Equipment..... 91
- 9.2. Test Setup..... 91
- 9.3. Limit..... 91
- 9.4. Test Procedure 92
- 9.5. EUT test definition 93
- 9.6. Test Result..... 94
- 10. Antenna Requirement..... 95
- 10.1. Limit..... 95
- 10.2. Antenna Connector Construction..... 95

History of This Test Report

REPORT NO.	VERSION	DESCRIPTION	ISSUED DATE
1932048R-RF-US-P06V01	V1.0	Initial Issued Report	Apr. 17, 2019

1. General Information

1.1. EUT Description

Product Name	LED lamp
Model No.	9290019532
EUT Voltage	110-130 Vac, 50-60 Hz, 6W
Test Voltage	AC 120V/60Hz
Zigbee	
Frequency Range	2405 ~ 2480MHz
Channel Number	16
Type of Modulation	DSSS-OQPSK
Data Rate	250kbps
Antenna Type	Reference to Antenna List

Note 1: LED lamp supports three kinds of Crystal oscillator (murata/ Diodes/kdx), there is not any change in RF design, circuitry or construction for this device, including RF parameters (antenna, software, firmware and hardware versions, power, frequency ranges, etc.), so only power, spurious emission and band-edge were tested for different crystal oscillator, the test data of worse mode is showed with other test items.

1.2. Working Frequency of Each Channel:

Zigbee Working Frequency of Each Channel:							
Channel	Frequency	Channel	Frequency	Channel	Frequency	Channel	Frequency
11	2405 MHz	12	2410 MHz	13	2415 MHz	14	2420 MHz
15	2425 MHz	16	2430 MHz	17	2435 MHz	18	2440 MHz
19	2445 MHz	20	2450 MHz	21	2455 MHz	22	2460 MHz
23	2465 MHz	24	2470 MHz	25	2475 MHz	26	2480 MHz

1.3. Antenna information

Antenna manufacturer	N/A						
Antenna Delivery	<input checked="" type="checkbox"/>	1*TX+1*RX	<input type="checkbox"/>	2*TX+2*RX	<input type="checkbox"/>	3*TX+3*RX	
Antenna technology	<input checked="" type="checkbox"/>	SISO					
	<input type="checkbox"/>	MIMO	<input type="checkbox"/>	Basic			
			<input type="checkbox"/>	CDD			
			<input type="checkbox"/>	Beam-forming			
Antenna Type	<input type="checkbox"/>	External	<input type="checkbox"/>	Dipole			
	<input checked="" type="checkbox"/>	Internal	<input type="checkbox"/>	PIFA			
			<input checked="" type="checkbox"/>	PCB			
			<input type="checkbox"/>	Ceramic Chip Antenna			
			<input type="checkbox"/>	Metal plate type F antenna			
Antenna Gain	1.5dBi						

1.4. Mode of Operation

Test Mode
Mode 1: Transmit

1.5. Tested System Details

The types for all equipment, plus descriptions of all cables used in the tested system (including inserted cards) are:

No.	Product	Manufacturer	Model No.	Serial No.	Power Cord
1	Notebook	Think Pad	2526	LV-A3285	Power by adapter
2	Zigbee Receiver	N/A	N/A	N/A	N/A
A	USB Control Cable	N/A	N/A	N/A	Shield, 1m
B	USB Control Cable	N/A	N/A	N/A	Shield, 10m

1.6. Configuration of Tested System

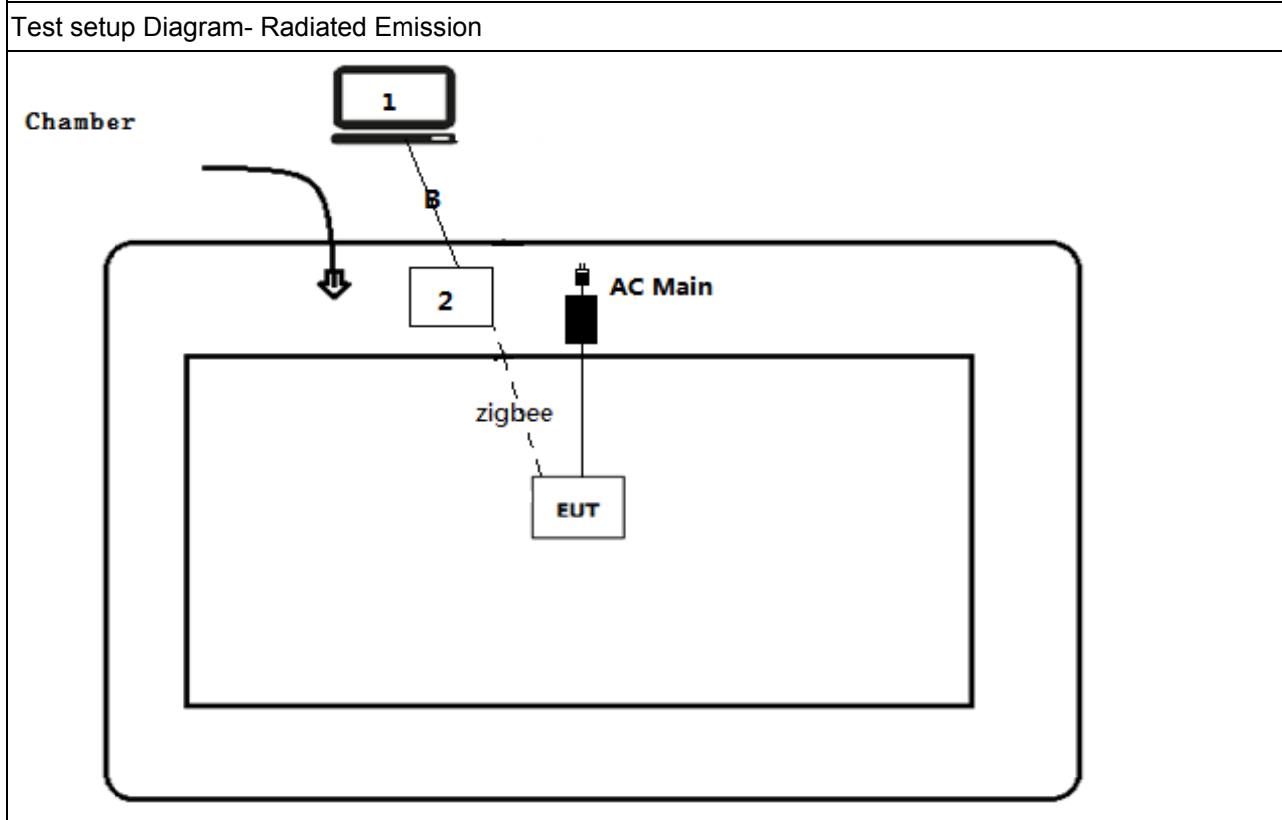
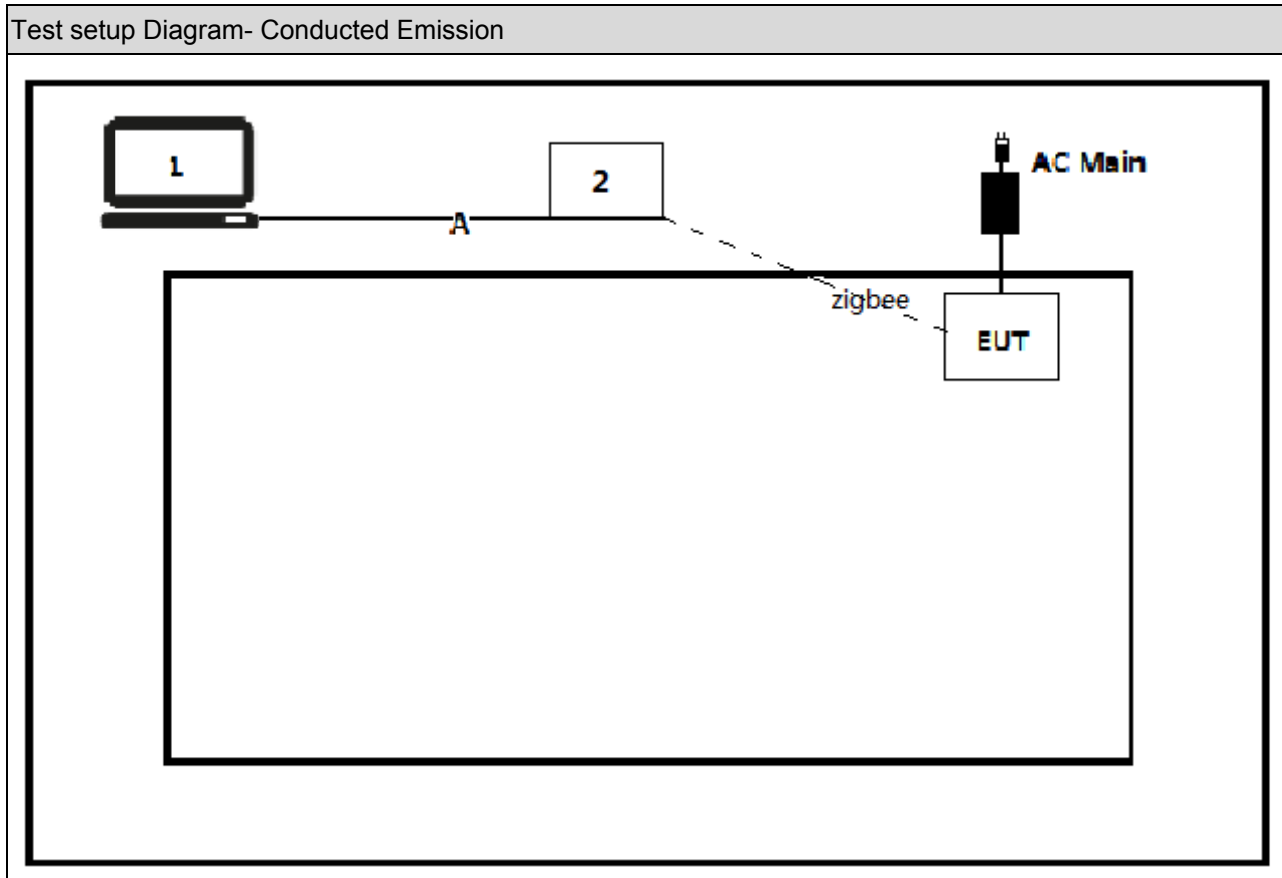

1.7. EUT Exercise Software

1	Setup the EUT and simulators as shown on above.
2	Turn on the power of equipment.
3	Run the test software (HueApprobaton Tool).
4	Select the transmission mode and test channel, then start test.

2. Technical Test

2.1. Summary of Test Result

FCC:

Performed Test Item	Normative References	Worst case mode	Limit	Result
AC Power Line Conducted Emission	FCC CFR Title 47 Part 15 Subpart C: 2015 Section 15.207	Mode 1	FCC 15.207	PASS
Emissions in restricted frequency bands	FCC CFR Title 47 Part 15 Subpart C: 2015 Section 15.209	Mode 1	FCC 15.209	PASS
Emissions in non-restricted frequency bands	FCC CFR Title 47 Part 15 Subpart C: 2015 Section 15.247(d)	Mode 1	20dBc	PASS
Radiated Emission Band Edge	FCC CFR Title 47 Part 15 Subpart C: 2015 15.247(d)	Mode 1	FCC 15.209	PASS
Occupied Bandwidth	FCC CFR Title 47 Part 15 Subpart C: 2015 Section 15.247(a)(2)	Mode 1	500kHz	PASS
Fundamental emission output power	FCC CFR Title 47 Part 15 Subpart C: 2015 Section 15.247(b)(3)	Mode 1	30dBm	PASS
Power Spectral Density	FCC CFR Title 47 Part 15 Subpart C: 2015 Section 15.247(e)	Mode 1	8dBm/3kHz	PASS
Antenna Requirement	FCC CFR Title 47 Part 15 Subpart C: 2015 Section 15.203	N/A	FCC 15.203	PASS

ISED:

Performed Test Item	Normative References	Worse case mode	Limit	Result
AC Power Line Conducted Emission	RSS-Gen Issue 4 November 2014 Section 8.8	N/A	RSS-Gen	PASS
Emissions in restricted frequency bands	RSS-247 Issue 1 May 2015 Section 5.5	Mode1	RSS-247	PASS
Emissions in non-restricted frequency bands	RSS-247 Issue 1 May 2015 Section 5.5	Mode1	30dBc	PASS
Radiated Emission Band Edge	RSS-Gen Issue 4 November 2014 Section 8.10	Mode1	RSS-Gen	PASS
Occupied Bandwidth	RSS-Gen Issue 4 November 2014 Section 6.6 RSS-247 Issue 1 May 2015 Section 5.2	Mode1	500kHz	PASS
Fundamental emission output power	RSS-247 Issue 1 May 2015 Section 5.4	Mode1	30dBm	PASS
Power Spectral Density	RSS-247 Issue 1 May 2015 Section 5.2	Mode1	8dBm/3kHz	PASS
Antenna Requirement	FCC CFR Title 47 Part 15 Subpart C: 2015 Section 15.203	N/A	RSS-Gen	PASS

2.2. Test Environment

Items	Required (IEC 68-1)	Actual
Temperature (°C)	15-35	21
Humidity (%RH)	25-75	50
Barometric pressure (mbar)	860-1060	950-1000

2.3. Measurement Uncertainty

Test Items	Uncertainty
AC Power Line Conducted Emission	± 2.02dB
Radiated Emission	Below 1GHz ± 3.8 dB
	Above 1GHz ± 3.9 dB
RF Antenna Port Conducted Emission	± 1.27dB
Radiated Emission Band Edge	± 3.9dB
Occupied Bandwidth	± 1kHz
Power Spectral Density	± 1.27dB

3. AC Power Line Conducted Emission

3.1. Test Equipment

AC Power Line Conducted Emission / TR-1					
Instrument	Manufacturer	Type No.	Serial No.	Cal. Date	Cal. Due Date
EMI Test Receiver	R&S	ESCI	100906	2019.03.05	2020.03.04
Two-Line V-Network	R&S	ENV 216	101189	2018.07.16	2019.07.15
Two-Line V-Network	R&S	ENV 216	101044	2018.09.16	2019.09.15
50ohm Coaxial Switch	Anritsu	MP59B	6200464462	N/A	N/A
50ohm Termination	SHX	TF2	07081402	2018.09.16	2019.09.15
Temperature/Humidity Meter	Zhichen	ZC1-2	TR1-TH	2019.01.05	2020.01.04

Note: All equipments are calibrated with traceable calibrations. Each calibration is traceable to the national or international standards.

3.2. Test Setup

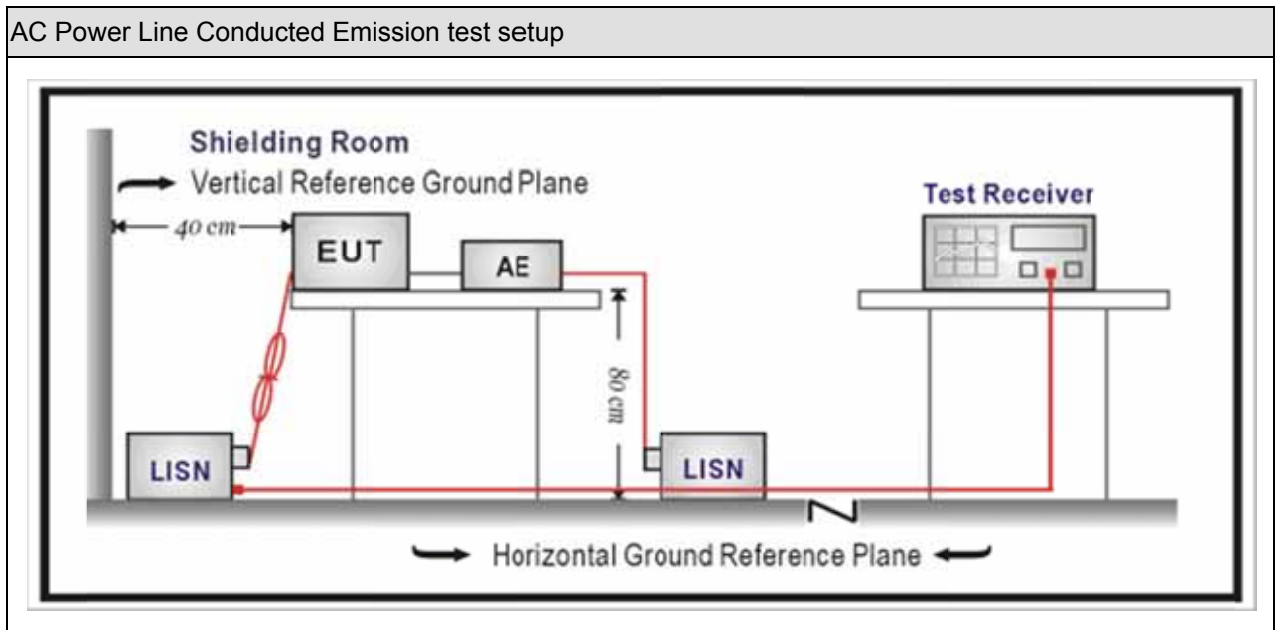

3.3. Limit

Frequency of Emission (MHz)	Conducted Limit	
	Quasi-peak (dB μ V)	Average (dB μ V)
0.15-0.5	66 to 56	56 to 46
0.5-5	56	46
5-30	60	50

Note 1: The lower limit shall apply at the transition frequencies.
 Note 2: The limit decreases linearly with the logarithm of the frequency in the range 0.15 MHz to 0.5 MHz.

3.4. Test Procedure

Test Method			
	References Rule	Chapter	Item
<input checked="" type="checkbox"/>	ANSI C63.10-2013	6.2	Standard test method for ac power-line conducted emissions from unlicensed wireless devices
<input checked="" type="checkbox"/>	ANSI C63.4-2014	7	AC power-line conducted emission measurements

3.5. Test Result

Engineer: LiuYu	
Site: TR1	Time: 2019/04/13 - 11:10
Limit: FCC_Part15.107_CE_AC Power_ClassB	Margin: 4
Probe: ENV216_101190(0.009-30MHz)	Polarity: Neutral
EUT: LED LAMP	Power: AC 120V/60Hz
Note: Mode 1	

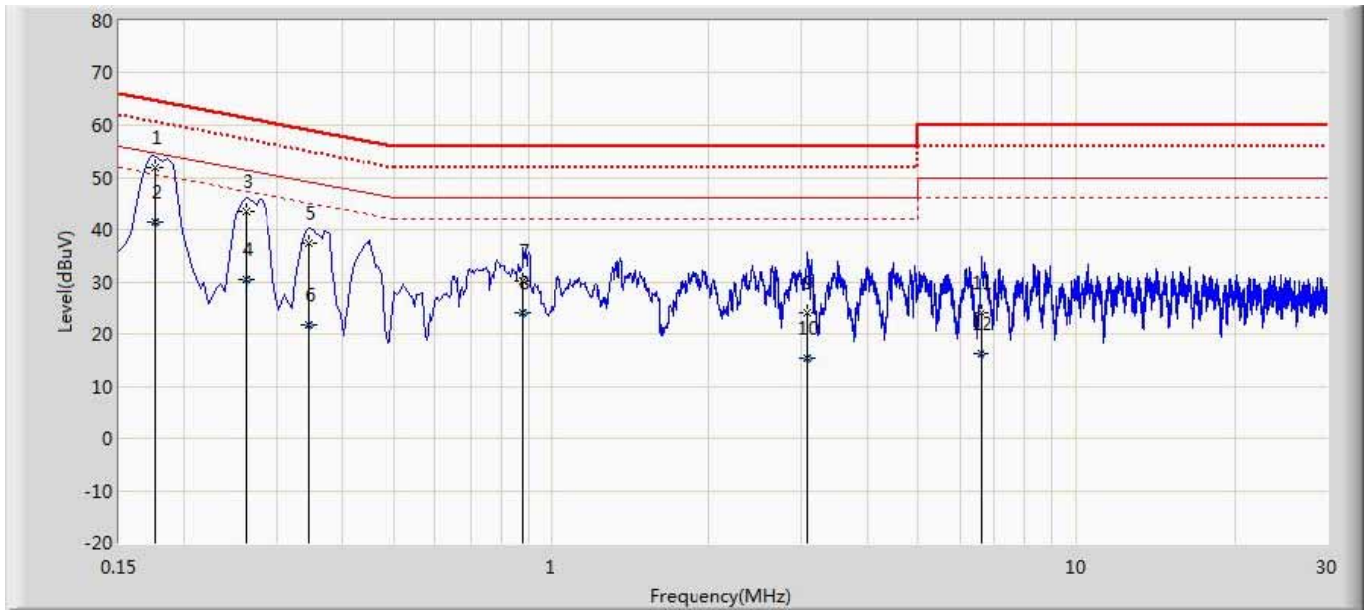

No	Mark	Frequency (MHz)	Measure Level (dBuV)	Reading Level (dBuV)	Over Limit (dB)	Limit (dBuV)	Factor (dB)	Type
1	*	0.176	51.949	42.329	-12.743	64.692	9.619	QP
2		0.176	41.459	31.839	-13.233	54.692	9.619	AV
3		0.262	43.434	33.805	-17.933	61.368	9.630	QP
4		0.262	30.352	20.722	-21.016	51.368	9.630	AV
5		0.346	37.396	27.766	-21.662	59.058	9.630	QP
6		0.346	21.719	12.090	-27.339	49.058	9.630	AV
7		0.882	30.008	20.362	-25.992	56.000	9.646	QP
8		0.882	24.166	14.520	-21.834	46.000	9.646	AV
9		3.078	23.978	14.240	-32.022	56.000	9.737	QP
10		3.078	15.362	5.625	-30.638	46.000	9.737	AV
11		6.582	23.968	14.114	-36.032	60.000	9.855	QP
12		6.582	16.239	6.384	-33.761	50.000	9.855	AV

Note:

1. " * ", means this data is the worst emission level.

2. Measurement Level = Reading Level + Factor(Probe+Cable-Amp).

Engineer: LiuYu	
Site: TR1	Time: 2019/04/13 - 11:58
Limit: FCC_Part15.107_CE_AC Power_ClassB	Margin: 4
Probe: ENV216_101190(0.009-30MHz)	Polarity: Line
EUT: LED LAMP	Power: AC 120V/60Hz
Note: Mode 1	

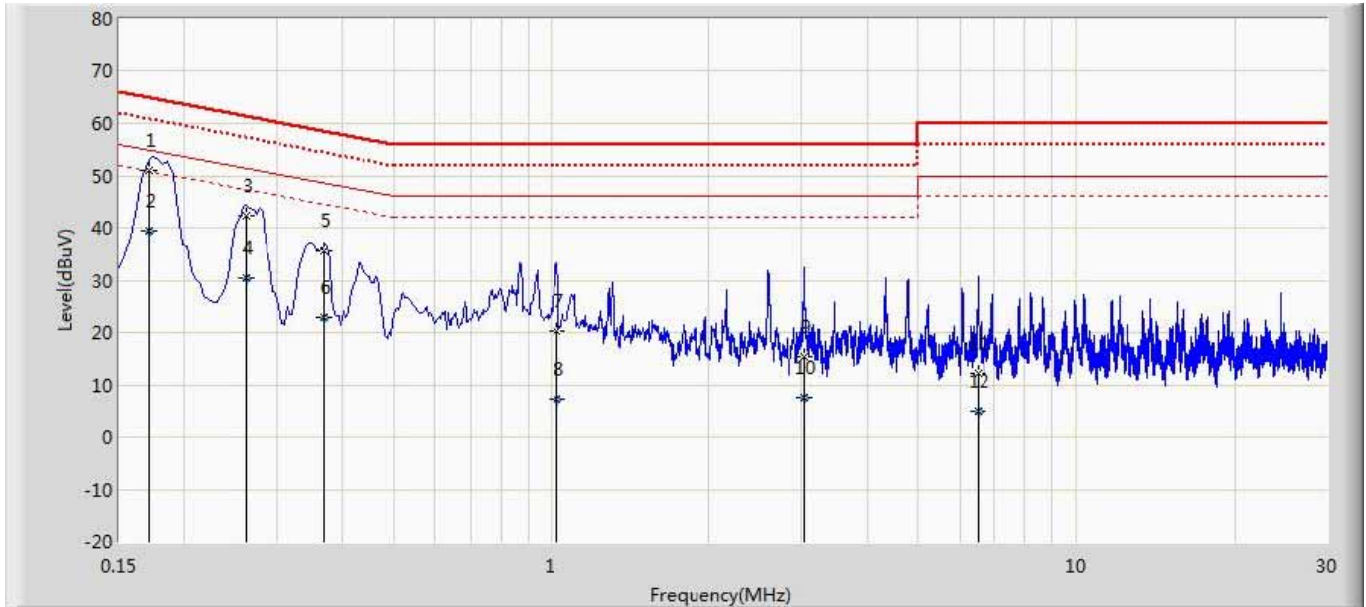

No	Mark	Frequency (MHz)	Measure Level (dBuV)	Reading Level (dBuV)	Over Limit (dB)	Limit (dBuV)	Factor (dB)	Type
1	*	0.171	50.955	41.326	-13.943	64.898	9.630	QP
2		0.171	39.527	29.897	-15.371	54.898	9.630	AV
3		0.262	42.232	32.600	-19.136	61.368	9.632	QP
4		0.262	30.568	20.936	-20.800	51.368	9.632	AV
5		0.370	35.610	25.973	-22.891	58.501	9.637	QP
6		0.370	22.800	13.162	-25.701	48.501	9.637	AV
7		1.026	20.245	10.568	-35.755	56.000	9.677	QP
8		1.026	7.154	-2.524	-38.846	46.000	9.677	AV
9		3.030	15.440	5.703	-40.560	56.000	9.738	QP
10		3.030	7.484	-2.254	-38.516	46.000	9.738	AV
11		6.498	12.132	2.282	-47.868	60.000	9.850	QP
12		6.498	5.026	-4.824	-44.974	50.000	9.850	AV

Note:

1. " * ", means this data is the worst emission level.
2. Measurement Level = Reading Level + Factor(Probe+Cable-Amp).

4. Emissions in restricted frequency bands

4.1. Test Equipment

Radiated Emission(Below 1GHz) / AC-2					
Instrument	Manufacturer	Type No.	Serial No.	Cal. Date	Cal. Due Date
EMI Test Receiver	R&S	ESCI	100573	2019.03.29	2020.03.28
Loop Antenna	R&S	HFH2-Z2	833799/003	2018.11.16	2019.11.15
Bilog Antenna	Teseq GmbH	CBL6112D	27611	2018.10.16	2019.10.15
Coaxial Cable	Huber+Suhner	SUCOFLEX 106	AC2-C	2019.03.02	2020.03.01
Temperature/Humidity Meter	Zhichen	ZC1-2	AC2-TH	2019.01.04	2020.01.03
Note: All equipments are calibrated with traceable calibrations. Each calibration is traceable to the national or international standards.					

Radiated Emission(Above 1GHz) / AC-5					
Instrument	Manufacturer	Type No.	Serial No.	Cal. Date	Cal. Due Date
Spectrum Analyzer	Agilent	E4446A	MY45300103	2019.01.04	2020.01.03
Preamplifier	Miteq	NSP1800-25	1364185	2018.05.06	2019.05.05
Preamplifier	QuieTek	AP-040G	CHM-0906001	2018.05.06	2019.05.05
DRG Horn	ETS-Lindgren	3117	00123988	2019.01.22	2020.01.21
Broad-Band Horn Antenna	Schwarzbeck	BBHA9170	294	2018.11.25	2019.11.24
Coaxial Cable	Huber+Suhner	SUCOFLEX 106	AC5-C1	2019.03.02	2020.03.01
Coaxial Cable	Huber+Suhner	SUCOFLEX 106	AC5-C2	2019.03.02	2020.03.01
Coaxial Cable	Huber+Suhner	SUCOFLEX 102	AC5-C3	2019.03.02	2020.03.01
EMI Receiver	Agilent	N9038A	MY51210196	2018.06.10	2019.06.09
Temperature/Humidity Meter	Zhichen	ZC1-2	AC5-TH	2019.01.04	2020.01.03
Note: All equipments are calibrated with traceable calibrations. Each calibration is traceable to the national or international standards.					

4.2. Test Setup

Below 30MHz Test Setup:

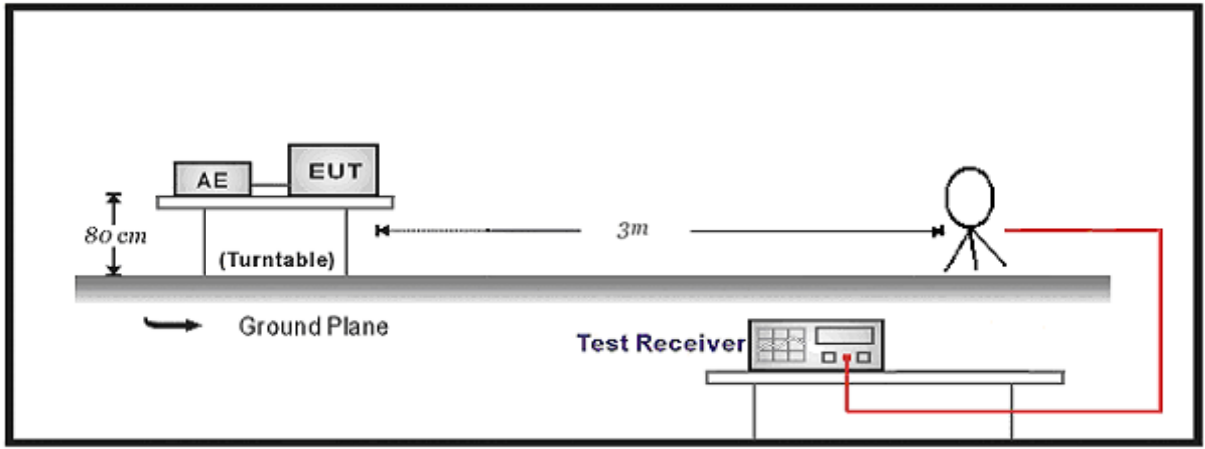

30MHz-1GHz Test Setup:

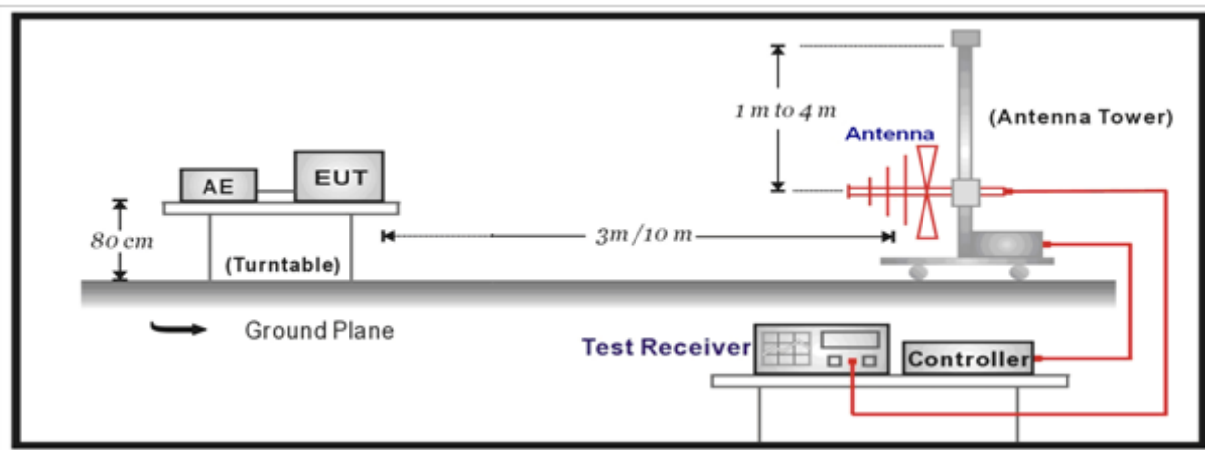

Above 1GHz Test Setup:

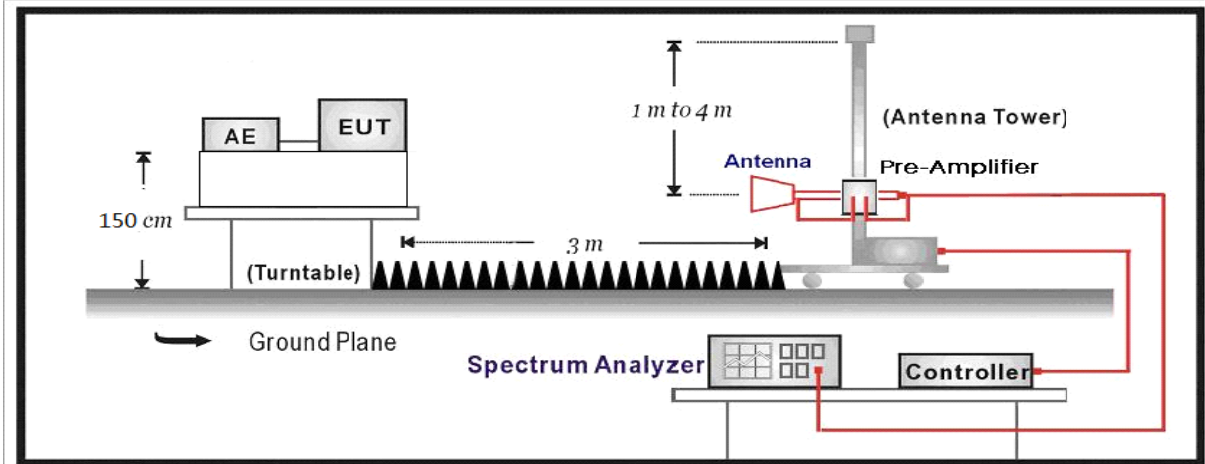

4.3. Limit

For FCC:

Restricted Bands of operation			
Frequency (MHz)	Frequency (MHz)	Frequency (MHz)	Frequency (GHz)
0.090 – 0.110	16.42 – 16.423	399.9 – 410	4.5 – 5.15
0.495 – 0.505	16.69475 – 16.69525	608 – 614	5.35 – 5.46
2.1735 – 2.1905	16.80425 – 16.80475	960 – 1240	7.25 – 7.75
4.125 – 4.128	25.5 – 25.67	1300 – 1427	8.025 – 8.5
4.17725 – 4.17775	37.5 – 38.25	1435 – 1626.5	9.0 – 9.2
4.20725 – 4.20775	73 – 74.6	1645.5 – 1646.5	9.3 – 9.5
6.215 – 6.218	74.8 – 75.2	1660 – 1710	10.6 – 12.7
6.26775 – 6.26825	108 – 121.94	1718.8 – 1722.2	13.25 – 13.4
6.31175 – 6.31225	123 – 138	2200 – 2300	14.47 – 14.5
8.291 – 8.294	149.9 – 150.05	2310 – 2390	15.35 – 16.2
8.362 – 8.366	156.52475 – 156.52525	2483.5 – 2500	17.7 – 21.4
8.37625 – 8.38675	156.7 – 156.9	2690 – 2900	22.01 – 23.12
8.81425 – 8.81475	162.0125 – 167.17	3260 – 3267	23.6 – 24.0
12.29 – 12.293	167.72 – 173.2	3332 – 3339	31.2 – 31.8
12.51975 – 12.52025	240 – 285	3345.8 – 3358	36.43 – 36.5
12.57675 – 12.57725	322 – 335.4	3600 – 4400	
13.36 – 13.41			

For ISED:

Restricted Bands of operation			
Frequency (MHz)	Frequency (MHz)	Frequency (MHz)	Frequency (GHz)
	13.36 - 13.41	960 - 1427	9.0 - 9.2
0.495 - 0.505	16.42 - 16.423	1435 - 1626.5	9.3 - 9.5
2.1735 - 2.1905	16.69475 - 16.69525	1645.5 - 1646.5	10.6 - 12.7
3.020 - 3.026	16.80425 - 16.80475	1660 - 1710	13.25 - 13.4
4.125 - 4.128	25.5 - 25.67	1718.8 - 1722.2	14.47 - 14.5
4.17725 - 4.17775	37.5 - 38.25	2200 - 2300	15.35 - 16.2
4.20725 - 4.20775	73 - 74.6	2310 - 2390	17.7 - 21.4
5.677 - 5.683	74.8 - 75.2	2483.5 - 2500	22.01 - 23.12
6.215 - 6.218	108 - 138	2655 - 2900	23.6 - 24.0
6.26775 - 6.26825	149.9 - 150.05	3260 - 3267	31.2 - 31.8
6.31175 - 6.31225	156.52475 - 156.52525	3332 - 3339	36.43 - 36.5
8.291 - 8.294	156.7 - 156.9	3345.8 - 3358	Above 38.6
8.362 - 8.366	162.0125 - 167.17	3500 - 4400	
8.37625 - 8.38675	167.72 - 173.2	4500 - 5150	
8.41425 - 8.41475	240 - 285	5350 - 5460	
12.29 - 12.293	322 - 335.4	7250 - 7750	
12.51975 - 12.52025	399.9 - 410	8025 - 8500	
12.57675 - 12.57725	608 - 614	--	

Restricted Band Emissions Limit			
Frequency (MHz)	Field strength (μ V/m)	Field strength (dB μ V/m)	Measurement distance (m)
0.009 - 0.49	2400/F(kHz)	48.5 – 13.8	300 _(Note 1)
0.49 - 1.705	24000/F(kHz)	33.8 - 23	30 _(Note 1)
1.705 - 30	30	29.5	30 _(Note 1)
30 - 88	100	40	3 _(Note 2)
88 - 216	150	43.5	3 _(Note 2)
216 - 960	200	46	3 _(Note 2)
Above 960	500	54	3 _(Note 2)





Note 1: At frequencies below 30 MHz, measurements may be performed at a distance closer than that specified in the regulations; however, an attempt should be made to avoid making measurements in the near field. Pending the development of an appropriate measurement procedure for measurements performed below 30 MHz, when performing measurements at a closer distance than specified, the results shall be extrapolated to the specified distance by either making measurements at a minimum of two distances on at least one radial to determine the proper extrapolation factor or by using the square of an inverse linear distance extrapolation factor (40 dB/decade).

Note 2: At frequencies at or above 30 MHz, measurements may be performed at a distance other than what is specified provided: measurements are not made in the near field except where it can be shown that near field measurements are appropriate due to the characteristics of the device; and it can be demonstrated that the signal levels needed to be measured at the distance employed can be detected by the measurement equipment. Measurements shall not be performed at a distance greater than 30 meters unless it can be further demonstrated that measurements at a distance of 30 meters or less are impractical. When performing measurements at a distance other than that specified, the results shall be extrapolated to the specified distance using an extrapolation factor of 20 dB/decade (inverse linear-distance for field strength measurements; inverse-linear-distance-squared for power density measurements).

4.4. Test Procedure

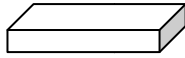
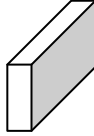
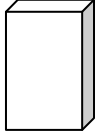
Test Method			
	References Rule	Chapter	Description
<input type="checkbox"/>	ANSI C63.10	11.11	Emissions in non-restricted frequency bands
	<input type="checkbox"/> ANSI C63.10	11.11.2	Reference level measurement
	<input type="checkbox"/> ANSI C63.10	11.11.3	Emission level measurement
<input checked="" type="checkbox"/>	ANSI C63.10	11.12	Emissions in restricted frequency bands
	<input checked="" type="checkbox"/> ANSI C63.10	11.12.1	Radiated emission measurements
	<input checked="" type="checkbox"/> ANSI C63.10	11.12.2.7	Radiated spurious emission test
	<input checked="" type="checkbox"/> ANSI C63.10	6.4	Radiated emissions from unlicensed wireless devices below 30 MHz
	<input checked="" type="checkbox"/> ANSI C63.10	6.5	Radiated emissions from unlicensed wireless devices in the frequency range of 30 MHz to 1000 MHz
	<input checked="" type="checkbox"/> ANSI C63.10	6.6	Radiated emissions from unlicensed wireless devices above 1 GHz
	<input type="checkbox"/> ANSI C63.10	11.12.2.3	Quasi-peak measurement procedure
	<input type="checkbox"/> ANSI C63.10	11.12.2.4	Peak power measurement procedure
	<input type="checkbox"/> ANSI C63.10	11.12.2.5	Average power measurement procedures
	<input type="checkbox"/> ANSI C63.10	11.12.2.5.1	Trace averaging with continuous EUT transmission at full power
	<input type="checkbox"/> ANSI C63.10	11.12.2.5.2	Trace averaging across ON and OFF times of the EUT transmissions followed by duty cycle correction
	<input type="checkbox"/> ANSI C63.10	11.12.2.5.3	Reduced VBW averaging across ON and OFF times of the EUT transmissions with max hold

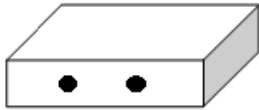
4.5. EUT test Axis definition

Item	Emissions in restricted frequency bands			
Device Category	<input type="checkbox"/>	Fixed point-to-point		
	<input type="checkbox"/>	Emit multiple directional beams, simultaneously or sequentially		
	<input checked="" type="checkbox"/>	Other cases		
Test mode	Mode 1			
Test method	<input checked="" type="checkbox"/>	Radiated		
		X Axis	Y Axis	Z Axis
				
		Worst Axis <input checked="" type="checkbox"/>	Worst Axis <input type="checkbox"/>	Worst Axis <input type="checkbox"/>
	<input type="checkbox"/>	Conducted		
	<input type="checkbox"/>	Chain 0		
				
	<input type="checkbox"/>	Chain 0	Chain 1	
				
	<input type="checkbox"/>	Chain 0	Chain 1	Chain 2
				

4.6. Test Result

Muruta:

Engineer: YULIU	
Site: AC5	Time: 2019/04/10 - 21:12
Limit: FCC_Part15.209_RE(3m)	Margin: 0
Probe: Horn_3117_00167055(1-18GHz)	Polarity: Vertical
EUT: LED LAMP	Power: AC 120V/60Hz
Note: Mode1:Transmit at 2405Mhz by Zigbee	

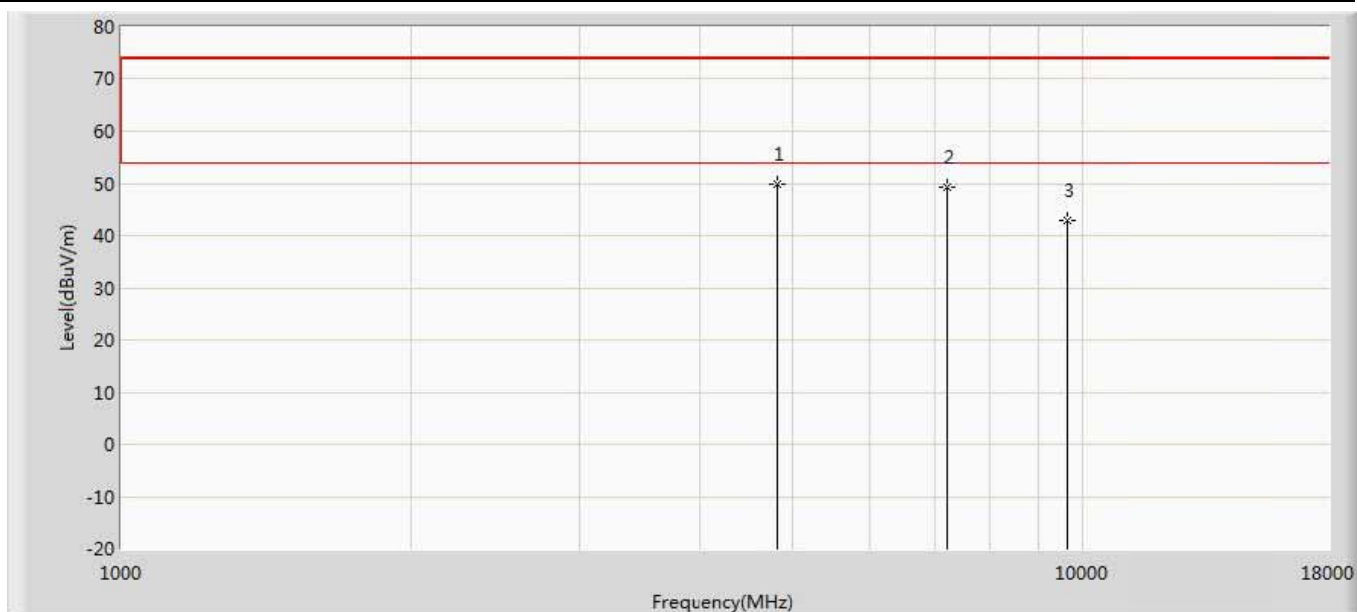

No	Mark	Frequency (MHz)	Measure Level (dBuV/m)	Reading Level (dBuV)	Over Limit (dB)	Limit (dBuV/m)	Factor (dB)	Type
1	*	4810.000	49.754	51.521	-24.246	74.000	-1.768	PK
2		7215.000	49.280	47.514	-24.720	74.000	1.766	PK
3		9620.000	42.769	38.661	-31.231	74.000	4.108	PK

Engineer: YULIU	
Site: AC5	Time: 2019/04/10 - 21:12
Limit: FCC_Part15.209_RE(3m)	Margin: 0
Probe: Horn_3117_00167055(1-18GHz)	Polarity: Horizontal
EUT: LED LAMP	Power: AC 120V/60Hz
Note: Mode1:Transmit at 2405Mhz by Zigbee	

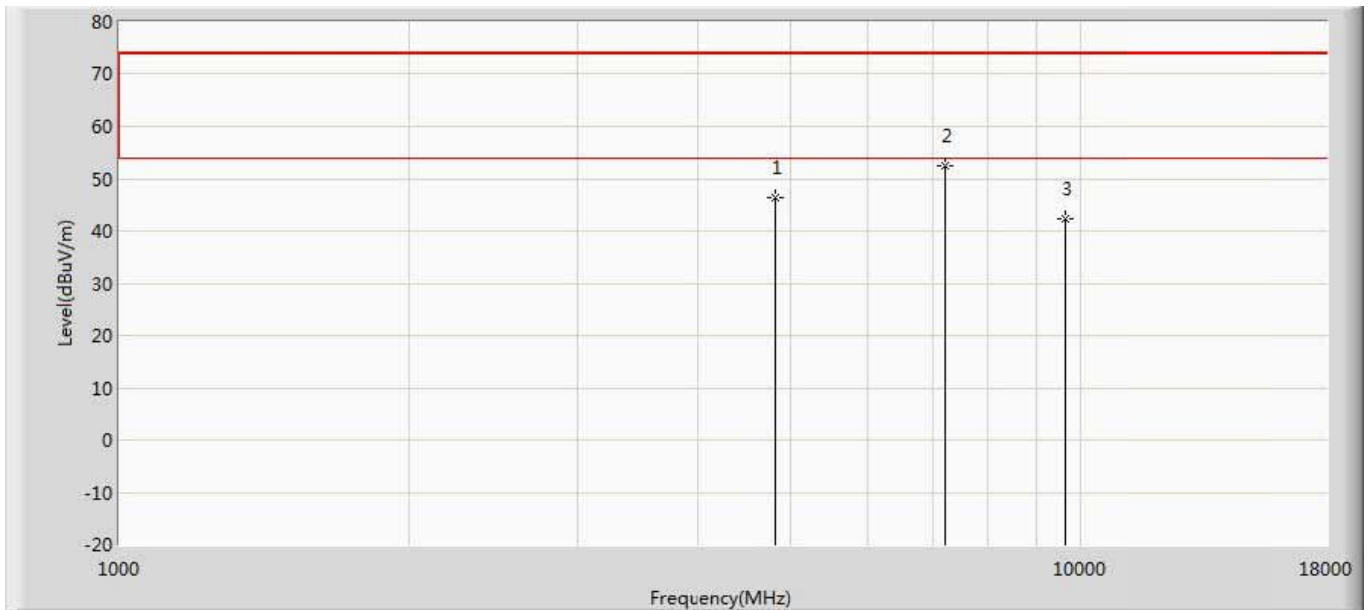

No	Mark	Frequency (MHz)	Measure Level (dBuV/m)	Reading Level (dBuV)	Over Limit (dB)	Limit (dBuV/m)	Factor (dB)	Type
1		4810.000	46.356	48.123	-27.644	74.000	-1.768	PK
2	*	7215.000	52.419	50.653	-21.581	74.000	1.766	PK
3		9620.000	42.308	38.200	-31.692	74.000	4.108	PK

Engineer: YULIU	
Site: AC5	Time: 2019/04/10 - 21:12
Limit: FCC_Part15.209_RE(3m)	Margin: 0
Probe: Horn_3117_00167055(1-18GHz)	Polarity: Vertical
EUT: LED LAMP	Power: AC 120V/60Hz
Note: Mode1:Transmit at 2440Mhz by Zigbee	

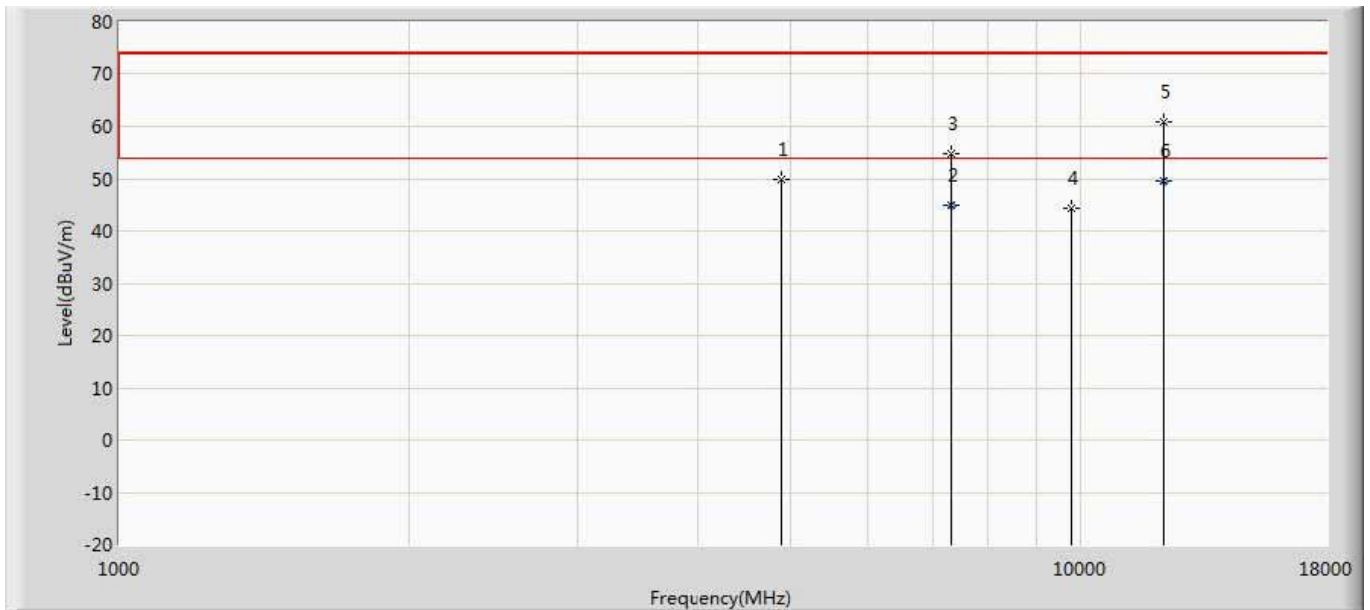

No	Mark	Frequency (MHz)	Measure Level (dBuV/m)	Reading Level (dBuV)	Over Limit (dB)	Limit (dBuV/m)	Factor (dB)	Type
1		4876.000	49.830	51.049	-24.170	74.000	-1.219	PK
2		7318.000	44.841	42.975	-9.159	54.000	1.867	AV
3		7324.000	54.795	52.878	-19.205	74.000	1.917	PK
4		9760.000	44.425	38.613	-29.575	74.000	5.812	PK
5		12203.000	60.728	50.534	-13.272	74.000	10.194	PK
6	*	12203.000	49.489	39.295	-4.511	54.000	10.194	AV

Engineer: YULIU	
Site: AC5	Time: 2019/04/10 - 21:12
Limit: FCC_Part15.209_RE(3m)	Margin: 0
Probe: Horn_3117_00167055(1-18GHz)	Polarity: Horizontal
EUT: LED LAMP	Power: AC 120V/60Hz
Note: Mode1:Transmit at 2440Mhz by Zigbee	

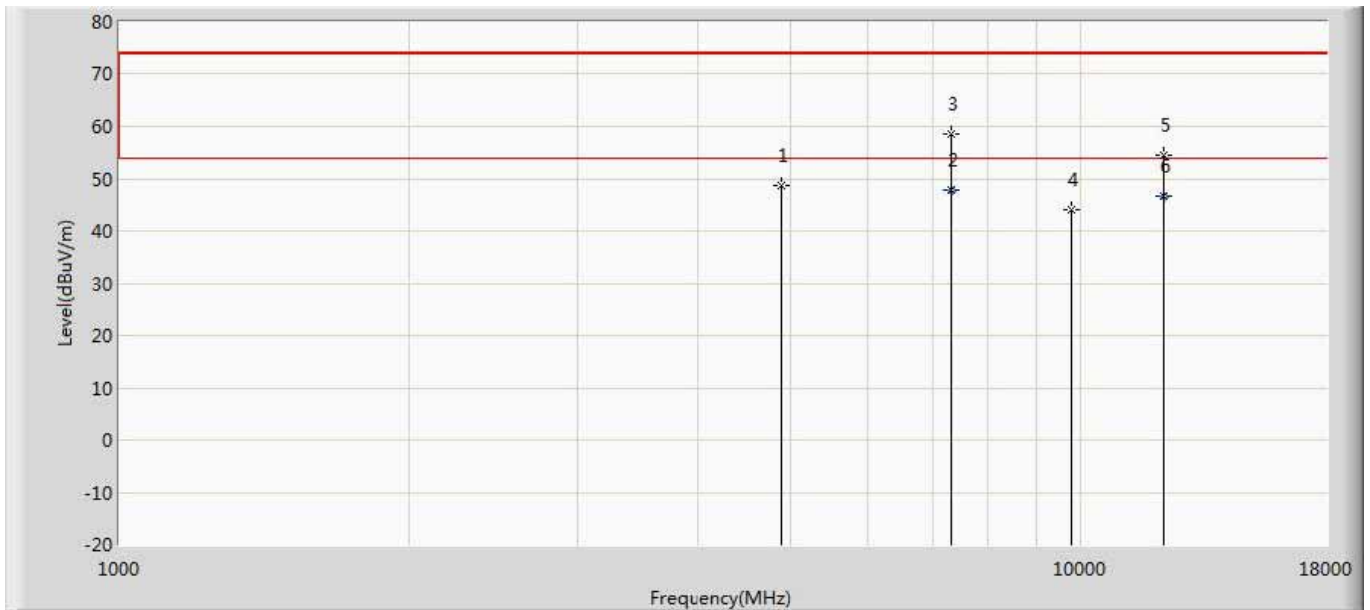

No	Mark	Frequency (MHz)	Measure Level (dBuV/m)	Reading Level (dBuV)	Over Limit (dB)	Limit (dBuV/m)	Factor (dB)	Type
1		4876.000	48.590	49.809	-25.410	74.000	-1.219	PK
2	*	7320.000	47.725	45.842	-6.275	54.000	1.884	AV
3		7324.000	58.427	56.510	-15.573	74.000	1.917	PK
4		9760.000	44.088	38.276	-29.912	74.000	5.812	PK
5		12203.000	54.394	44.200	-19.606	74.000	10.194	PK
6		12203.000	46.562	36.368	-7.438	54.000	10.194	AV

Engineer: YULIU	
Site: AC5	Time: 2019/04/10 - 21:12
Limit: FCC_Part15.209_RE(3m)	Margin: 0
Probe: Horn_3117_00167055(1-18GHz)	Polarity: Vertical
EUT: LED LAMP	Power: AC 120V/60Hz
Note: Mode1:Transmit at 2480Mhz by Zigbee	

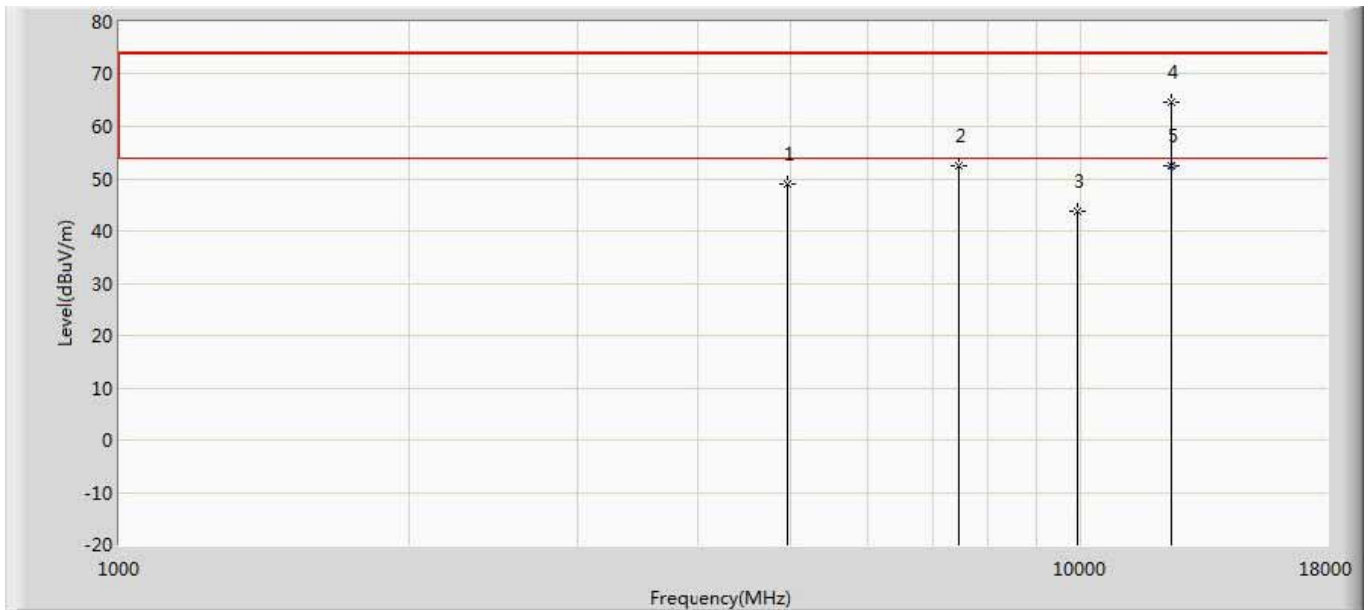

No	Mark	Frequency (MHz)	Measure Level (dBuV/m)	Reading Level (dBuV)	Over Limit (dB)	Limit (dBuV/m)	Factor (dB)	Type
1		4961.000	48.898	50.054	-25.102	74.000	-1.156	PK
2		7443.000	52.564	50.075	-21.436	74.000	2.489	PK
3		9920.000	43.642	38.388	-30.358	74.000	5.253	PK
4		12390.000	64.571	53.960	-9.429	74.000	10.611	PK
5	*	12390.000	52.605	41.994	-1.395	54.000	10.611	AV

Engineer: YULIU	
Site: AC5	Time: 2019/04/10 - 21:12
Limit: FCC_Part15.209_RE(3m)	Margin: 0
Probe: Horn_3117_00167055(1-18GHz)	Polarity: Horizontal
EUT: LED LAMP	Power: AC 120V/60Hz
Note: Mode1:Transmit at 2480Mhz by Zigbee	

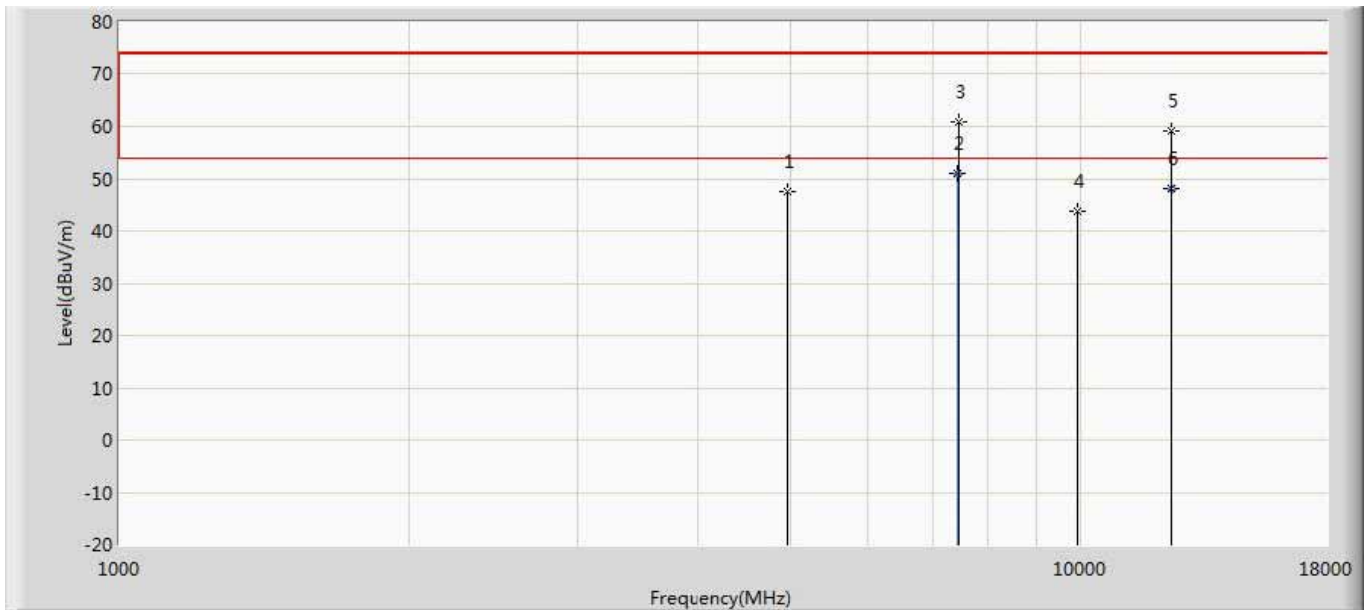

No	Mark	Frequency (MHz)	Measure Level (dBuV/m)	Reading Level (dBuV)	Over Limit (dB)	Limit (dBuV/m)	Factor (dB)	Type
1		4961.000	47.495	48.651	-26.505	74.000	-1.156	PK
2	*	7440.000	51.040	48.614	-2.960	54.000	2.426	AV
3		7443.000	60.817	58.328	-13.183	74.000	2.489	PK
4		9920.000	43.802	38.548	-30.198	74.000	5.253	PK
5		12390.000	58.992	48.381	-15.008	74.000	10.611	PK
6		12390.000	48.233	37.622	-5.767	54.000	10.611	AV

Diodes:

Engineer: YULIU	
Site: AC5	Time: 2019/04/10 - 21:24
Limit: FCC_Part15.209_RE(3m)	Margin: 0
Probe: Horn_3117_00167055(1-18GHz)	Polarity: Vertical
EUT: LED LAMP	Power: AC 120V/60Hz
Note: Mode1:Transmit at 2405Mhz by Zigbee	

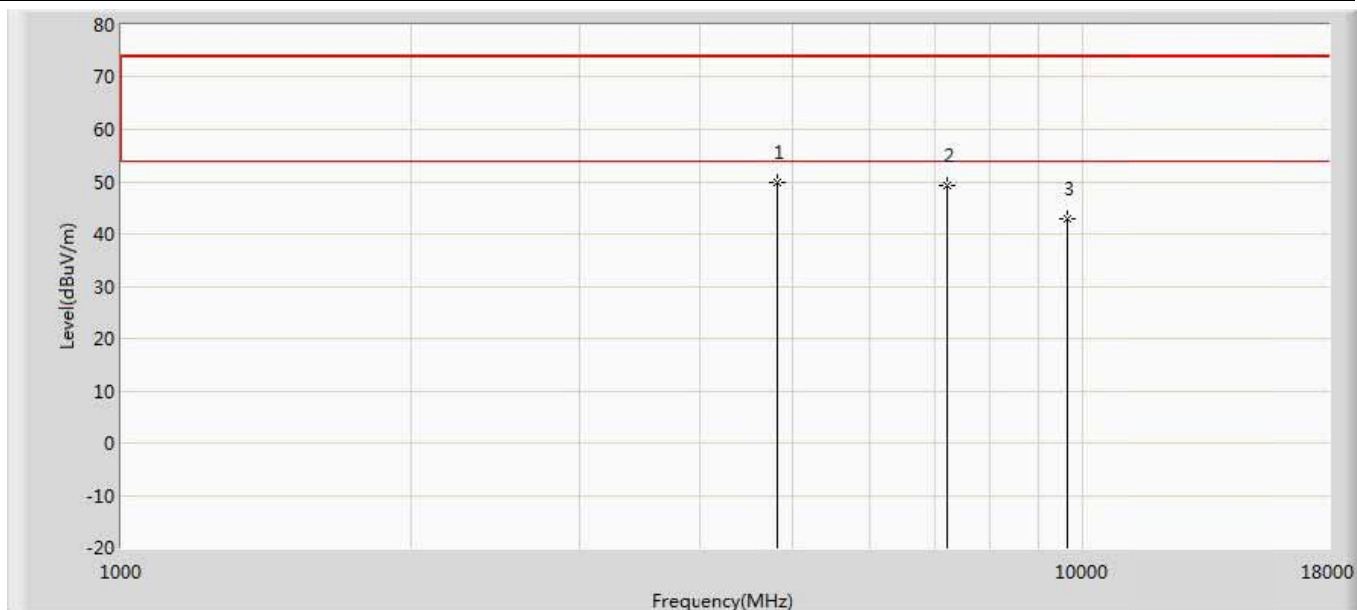

No	Mark	Frequency (MHz)	Measure Level (dBuV/m)	Reading Level (dBuV)	Over Limit (dB)	Limit (dBuV/m)	Factor (dB)	Type
1	*	4810.000	49.754	51.521	-24.246	74.000	-1.768	PK
2		7215.000	49.280	47.514	-24.720	74.000	1.766	PK
3		9620.000	42.769	38.661	-31.231	74.000	4.108	PK

Engineer: YULIU	
Site: AC5	Time: 2019/04/10 - 21:24
Limit: FCC_Part15.209_RE(3m)	Margin: 0
Probe: Horn_3117_00167055(1-18GHz)	Polarity: Horizontal
EUT: LED LAMP	Power: AC 120V/60Hz
Note: Mode1:Transmit at 2405Mhz by Zigbee	

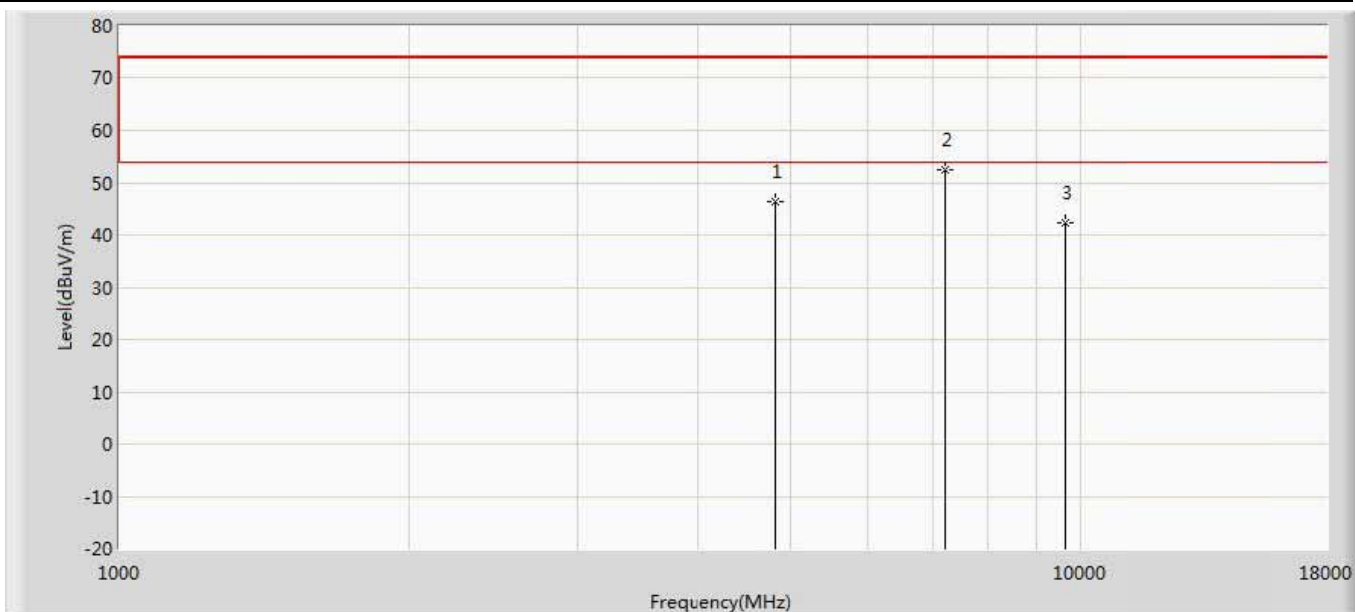

No	Mark	Frequency (MHz)	Measure Level (dBuV/m)	Reading Level (dBuV)	Over Limit (dB)	Limit (dBuV/m)	Factor (dB)	Type
1		4810.000	46.356	48.123	-27.644	74.000	-1.768	PK
2	*	7215.000	52.419	50.653	-21.581	74.000	1.766	PK
3		9620.000	42.308	38.200	-31.692	74.000	4.108	PK

Engineer: YULIU	
Site: AC5	Time: 2019/04/10 - 21:24
Limit: FCC_Part15.209_RE(3m)	Margin: 0
Probe: Horn_3117_00167055(1-18GHz)	Polarity: Vertical
EUT: LED LAMP	Power: AC 120V/60Hz
Note: Mode1:Transmit at 2440Mhz by Zigbee	

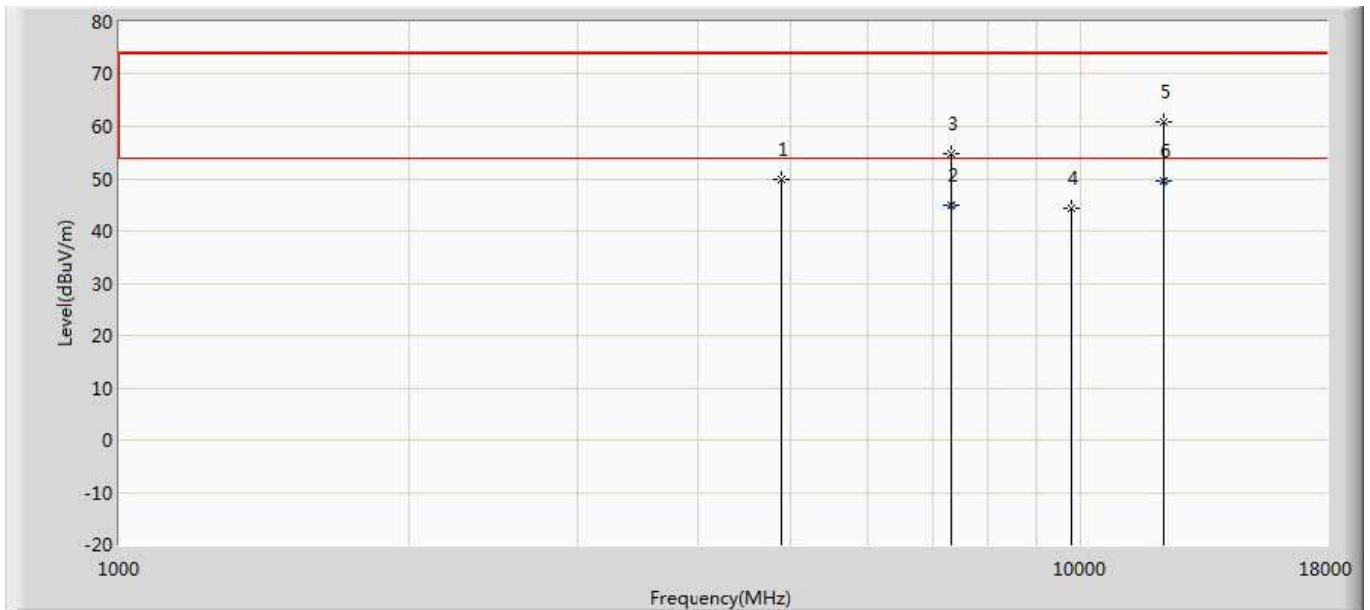

No	Mark	Frequency (MHz)	Measure Level (dBuV/m)	Reading Level (dBuV)	Over Limit (dB)	Limit (dBuV/m)	Factor (dB)	Type
1		4876.000	49.830	51.049	-24.170	74.000	-1.219	PK
2		7318.000	44.841	42.975	-9.159	54.000	1.867	AV
3		7324.000	54.795	52.878	-19.205	74.000	1.917	PK
4		9760.000	44.425	38.613	-29.575	74.000	5.812	PK
5		12203.000	60.728	50.534	-13.272	74.000	10.194	PK
6	*	12203.000	49.489	39.295	-4.511	54.000	10.194	AV

Engineer: YULIU	
Site: AC5	Time: 2019/04/10 - 21:24
Limit: FCC_Part15.209_RE(3m)	Margin: 0
Probe: Horn_3117_00167055(1-18GHz)	Polarity: Horizontal
EUT: LED LAMP	Power: AC 120V/60Hz
Note: Mode1:Transmit at 2440Mhz by Zigbee	

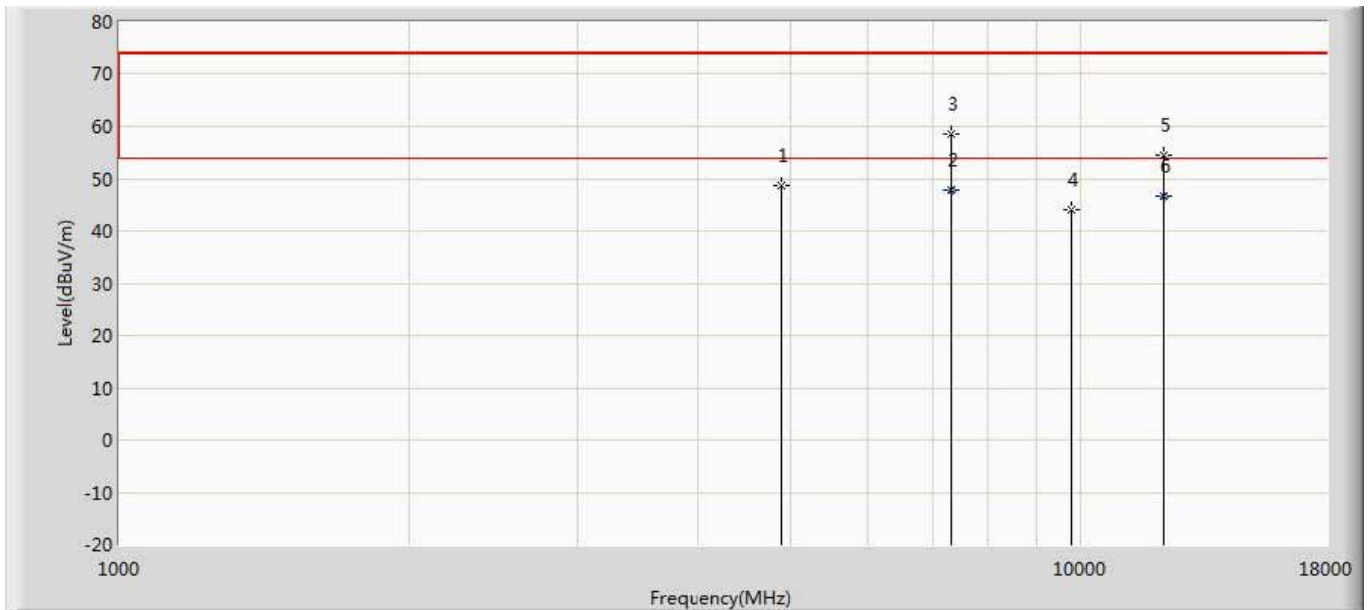

No	Mark	Frequency (MHz)	Measure Level (dBuV/m)	Reading Level (dBuV)	Over Limit (dB)	Limit (dBuV/m)	Factor (dB)	Type
1		4876.000	48.590	49.809	-25.410	74.000	-1.219	PK
2	*	7320.000	47.725	45.842	-6.275	54.000	1.884	AV
3		7324.000	58.427	56.510	-15.573	74.000	1.917	PK
4		9760.000	44.088	38.276	-29.912	74.000	5.812	PK
5		12203.000	54.394	44.200	-19.606	74.000	10.194	PK
6		12203.000	46.562	36.368	-7.438	54.000	10.194	AV

Engineer: YULIU	
Site: AC5	Time: 2019/04/10 - 21:24
Limit: FCC_Part15.209_RE(3m)	Margin: 0
Probe: Horn_3117_00167055(1-18GHz)	Polarity: Vertical
EUT: LED LAMP	Power: AC 120V/60Hz
Note: Mode1:Transmit at 2480Mhz by Zigbee	

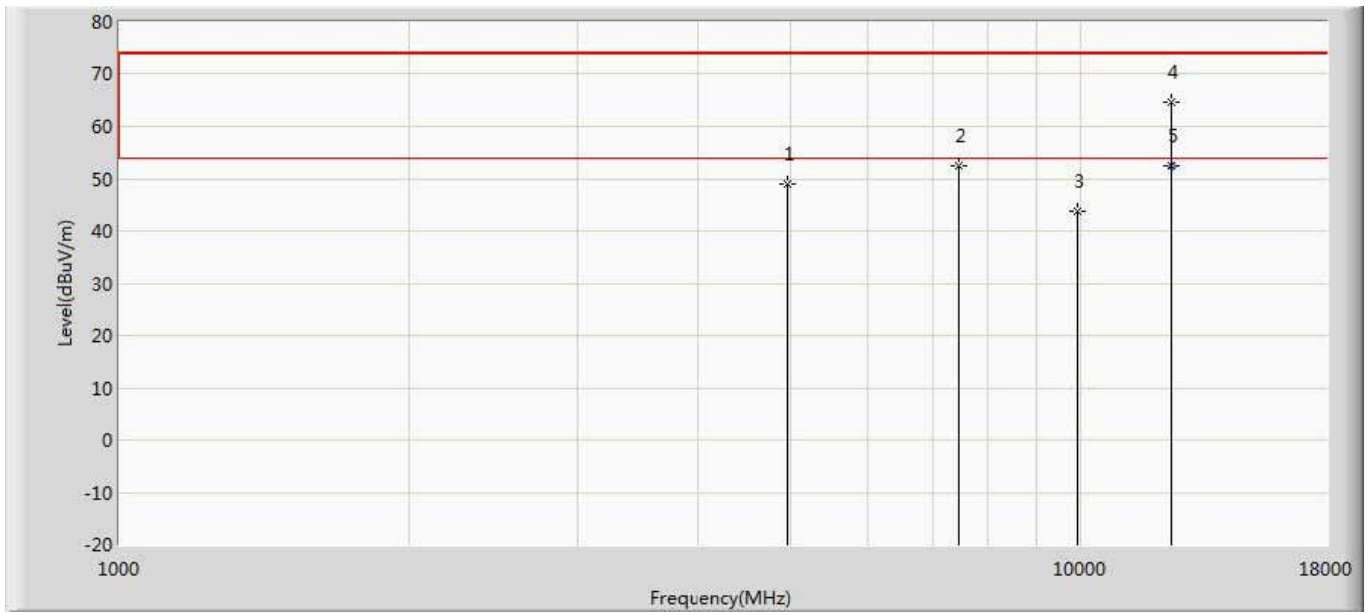

No	Mark	Frequency (MHz)	Measure Level (dBuV/m)	Reading Level (dBuV)	Over Limit (dB)	Limit (dBuV/m)	Factor (dB)	Type
1		4961.000	48.898	50.054	-25.102	74.000	-1.156	PK
2		7443.000	52.564	50.075	-21.436	74.000	2.489	PK
3		9920.000	43.642	38.388	-30.358	74.000	5.253	PK
4		12390.000	64.571	53.960	-9.429	74.000	10.611	PK
5	*	12390.000	52.605	41.994	-1.395	54.000	10.611	AV

Engineer: YULIU	
Site: AC5	Time: 2019/04/10 - 21:25
Limit: FCC_Part15.209_RE(3m)	Margin: 0
Probe: Horn_3117_00167055(1-18GHz)	Polarity: Horizontal
EUT: LED LAMP	Power: AC 120V/60Hz
Note: Mode1:Transmit at 2480Mhz by Zigbee	

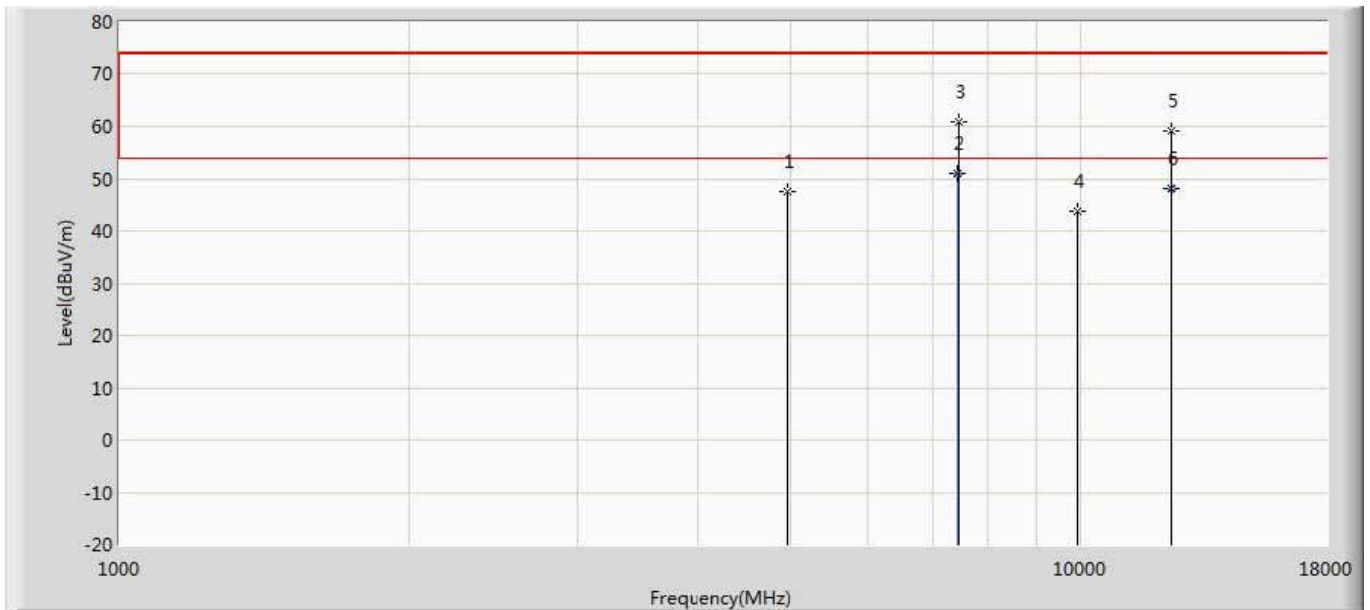

No	Mark	Frequency (MHz)	Measure Level (dBuV/m)	Reading Level (dBuV)	Over Limit (dB)	Limit (dBuV/m)	Factor (dB)	Type
1		4961.000	47.495	48.651	-26.505	74.000	-1.156	PK
2	*	7440.000	51.040	48.614	-2.960	54.000	2.426	AV
3		7443.000	60.817	58.328	-13.183	74.000	2.489	PK
4		9920.000	43.802	38.548	-30.198	74.000	5.253	PK
5		12390.000	58.992	48.381	-15.008	74.000	10.611	PK
6		12390.000	48.233	37.622	-5.767	54.000	10.611	AV

Kdx:

Engineer: YULIU	
Site: AC5	Time: 2019/04/12 - 14:27
Limit: FCC_Part15.209_RE(3m)	Margin: 0
Probe: Horn_3117_00167055(1-18GHz)	Polarity: Vertical
EUT:LED LAMP	Power: AC 120V/60Hz
Note: Mode1:Transmit at 2405MHz by Zigbee	

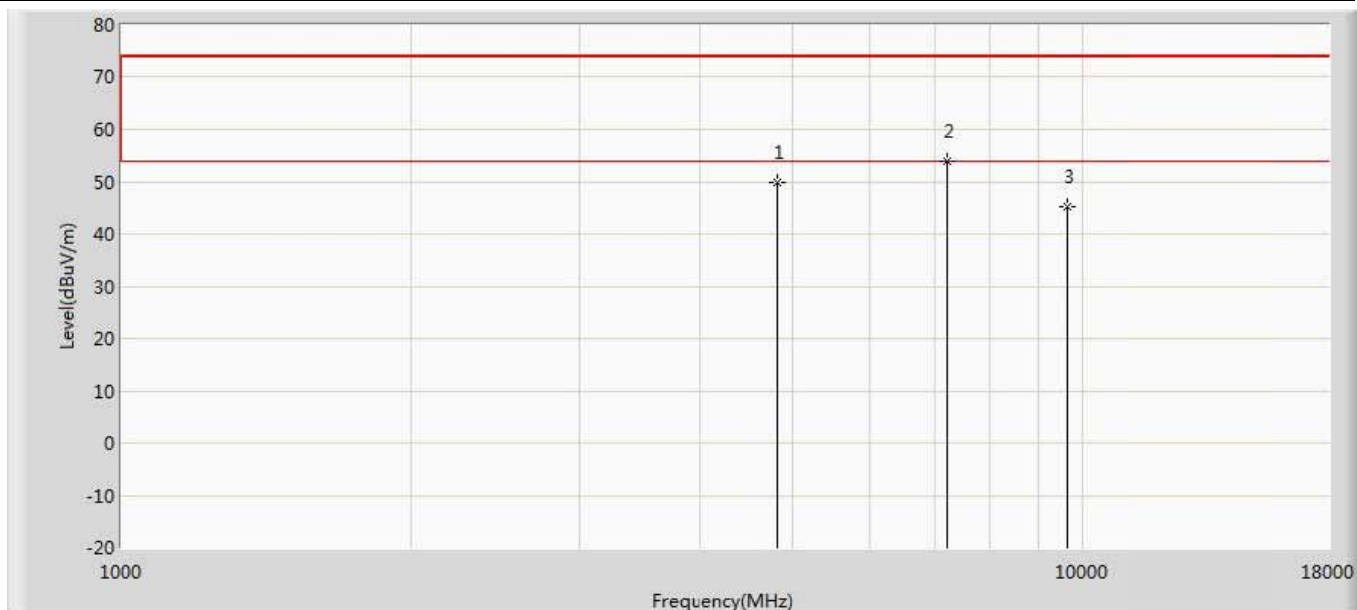

No	Mark	Frequency (MHz)	Measure Level (dBuV/m)	Reading Level (dBuV)	Over Limit (dB)	Limit (dBuV/m)	Factor (dB)	Type
1		4808.000	49.928	48.219	-24.072	74.000	1.709	PK
2	*	7213.500	53.955	48.682	-20.045	74.000	5.273	PK
3		9620.000	45.298	38.631	-28.702	74.000	6.667	PK

Engineer: YULIU	
Site: AC5	Time: 2019/04/12 - 14:27
Limit: FCC_Part15.209_RE(3m)	Margin: 0
Probe: Horn_3117_00167055(1-18GHz)	Polarity: Horizontal
EUT:LED LAMP	Power: AC 120V/60Hz
Note: Mode1:Transmit at 2405MHz by Zigbee	

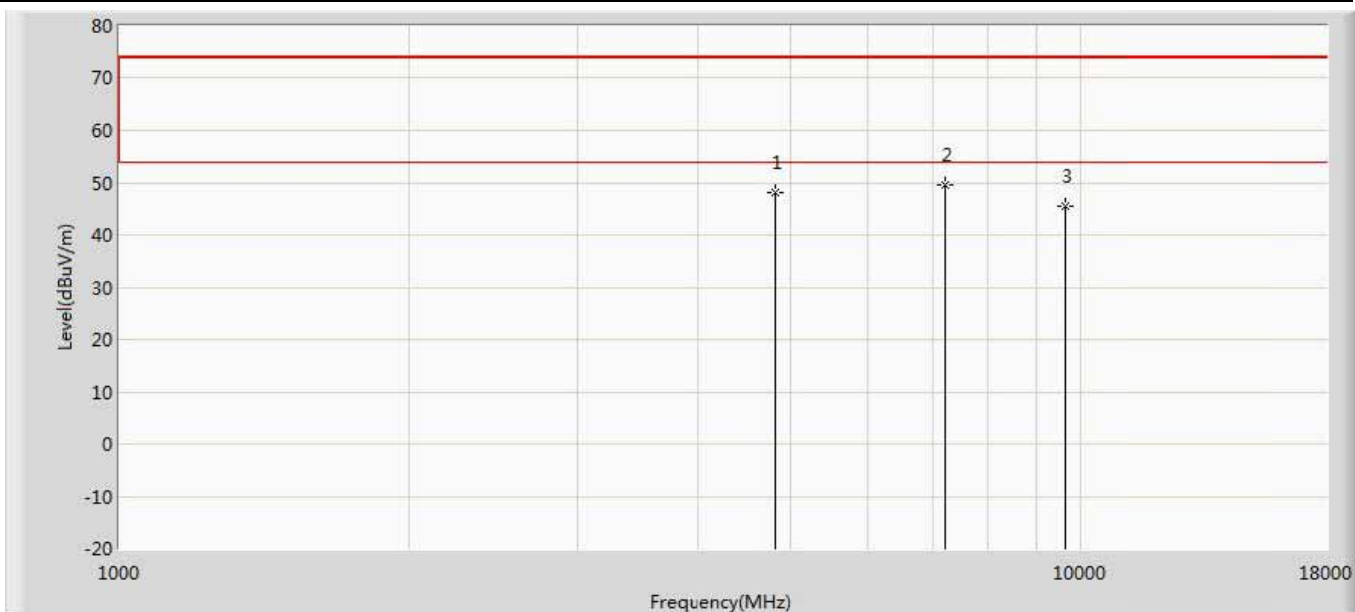

No	Mark	Frequency (MHz)	Measure Level (dBuV/m)	Reading Level (dBuV)	Over Limit (dB)	Limit (dBuV/m)	Factor (dB)	Type
1		4808.000	48.113	46.404	-25.887	74.000	1.709	PK
2	*	7213.500	49.668	44.395	-24.332	74.000	5.273	PK
3		9620.000	45.563	38.896	-28.437	74.000	6.667	PK

Engineer: YULIU	
Site: AC5	Time: 2019/04/12 - 14:27
Limit: FCC_Part15.209_RE(3m)	Margin: 0
Probe: Horn_3117_00167055(1-18GHz)	Polarity: Vertical
EUT:LED LAMP	Power: AC 120V/60Hz
Note: Mode1:Transmit at 2440MHz by Zigbee	

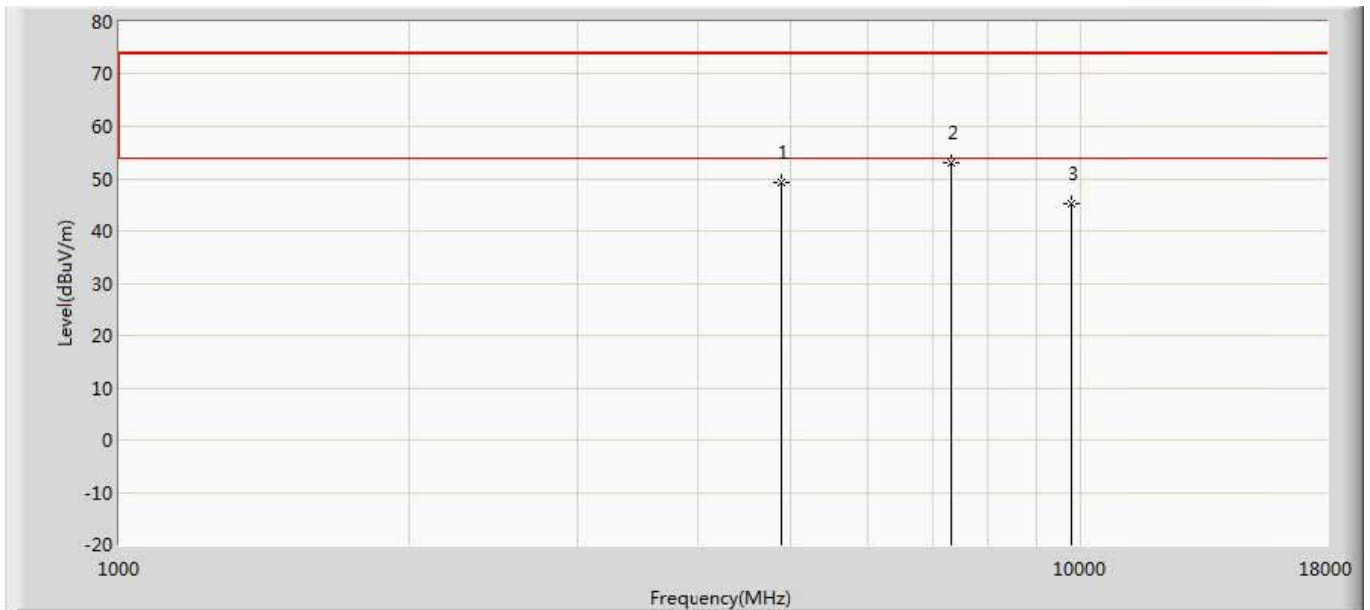

No	Mark	Frequency (MHz)	Measure Level (dBuV/m)	Reading Level (dBuV)	Over Limit (dB)	Limit (dBuV/m)	Factor (dB)	Type
1		4884.500	49.182	47.353	-24.818	74.000	1.829	PK
2	*	7324.000	53.045	47.450	-20.955	74.000	5.595	PK
3		9760.000	45.131	38.012	-28.869	74.000	7.120	PK

Engineer: YULIU	
Site: AC5	Time: 2019/04/12 - 14:27
Limit: FCC_Part15.209_RE(3m)	Margin: 0
Probe: Horn_3117_00167055(1-18GHz)	Polarity: Horizontal
EUT:LED LAMP	Power: AC 120V/60Hz
Note: Mode1:Transmit at 2440MHz by Zigbee	

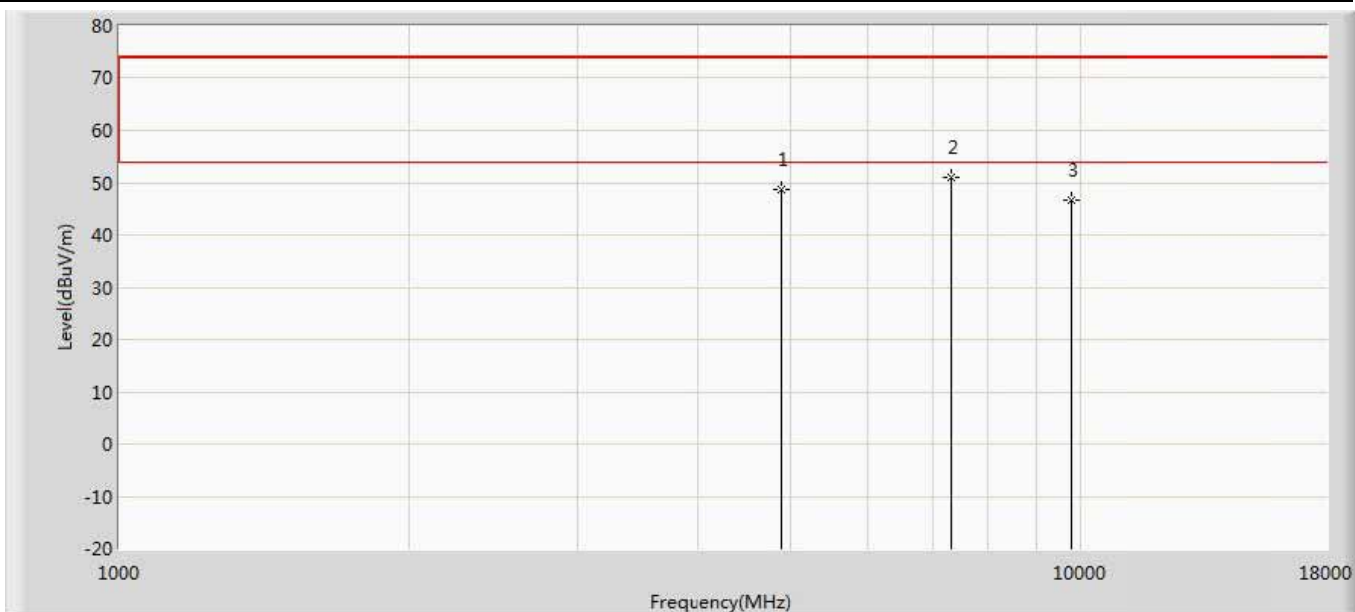

No	Mark	Frequency (MHz)	Measure Level (dBuV/m)	Reading Level (dBuV)	Over Limit (dB)	Limit (dBuV/m)	Factor (dB)	Type
1		4876.000	48.746	46.868	-25.254	74.000	1.878	PK
2	*	7324.000	50.953	45.358	-23.047	74.000	5.595	PK
3		9760.000	46.650	39.531	-27.350	74.000	7.120	PK

Engineer: YULIU	
Site: AC5	Time: 2019/04/12 - 14:27
Limit: FCC_Part15.209_RE(3m)	Margin: 0
Probe: Horn_3117_00167055(1-18GHz)	Polarity: Vertical
EUT:LED LAMP	Power: AC 120V/60Hz
Note: Mode1:Transmit at 2480MHz by Zigbee	

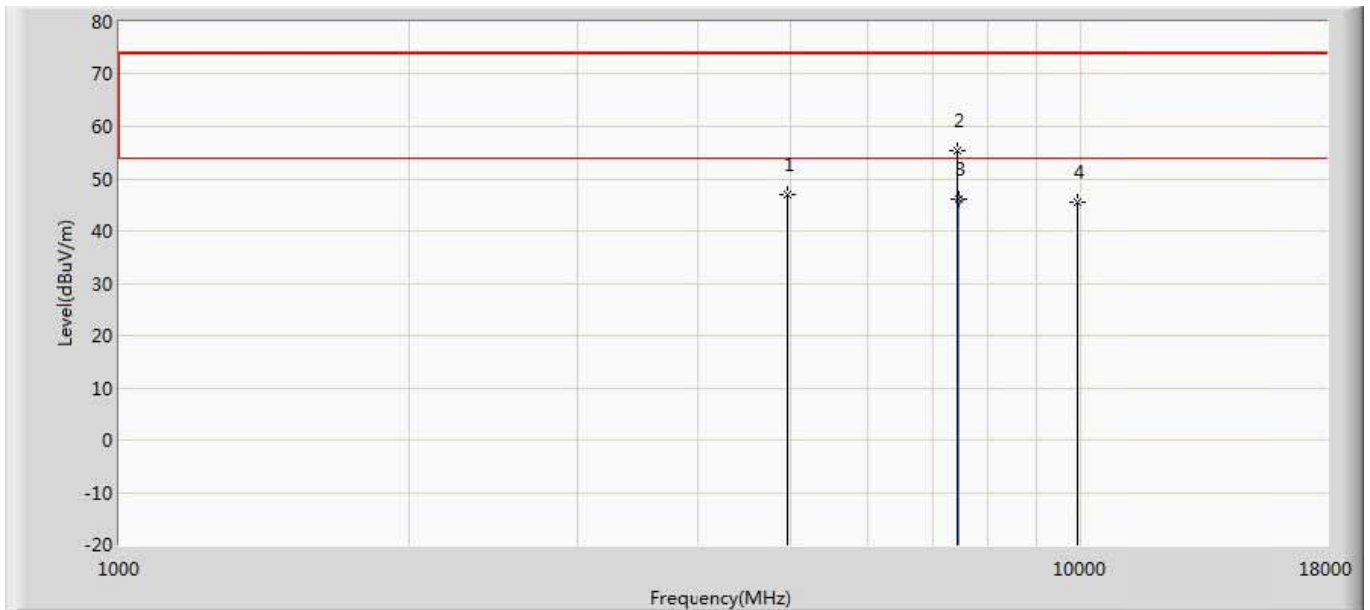

No	Mark	Frequency (MHz)	Measure Level (dBuV/m)	Reading Level (dBuV)	Over Limit (dB)	Limit (dBuV/m)	Factor (dB)	Type
1		4960.000	47.057	45.076	-26.943	74.000	1.981	PK
2		7434.500	55.378	50.018	-18.622	74.000	5.360	PK
3	*	7441.100	46.031	40.694	-7.969	54.000	5.338	AV
4		9920.000	45.434	38.345	-28.566	74.000	7.088	PK

Engineer: YULIU	
Site: AC5	Time: 2019/04/12 - 14:27
Limit: FCC_Part15.209_RE(3m)	Margin: 0
Probe: Horn_3117_00167055(1-18GHz)	Polarity: Horizontal
EUT:LED LAMP	Power: AC 120V/60Hz
Note: Mode1:Transmit at 2480MHz by Zigbee	

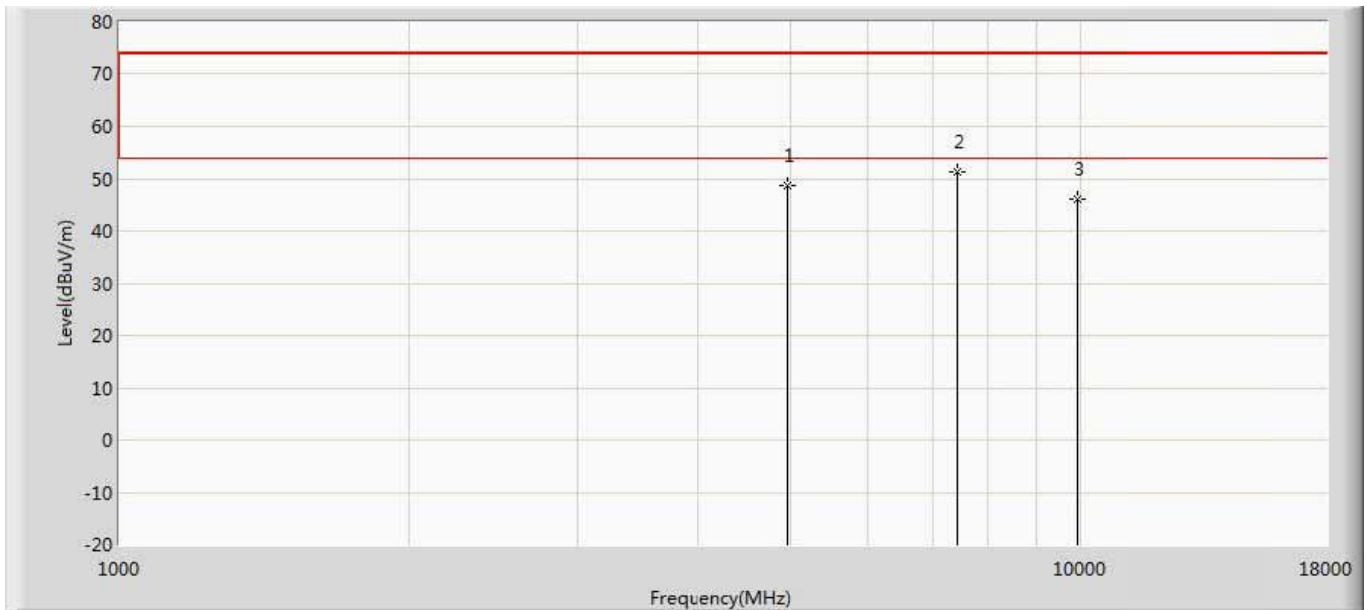

No	Mark	Frequency (MHz)	Measure Level (dBuV/m)	Reading Level (dBuV)	Over Limit (dB)	Limit (dBuV/m)	Factor (dB)	Type
1		4961.000	48.722	46.733	-25.278	74.000	1.989	PK
2	*	7434.500	51.360	46.000	-22.640	74.000	5.360	PK
3		9920.000	46.158	39.069	-27.842	74.000	7.088	PK

Note: 1. Measure Level = Reading Level + Factor.

Note: 2. The test frequency range, 9kHz~30MHz, 18GHz~25GHz, both of the worst case are at least 20dB below the limits, therefore no data appear in the report.

Note: 3. This limit applies for using average detector, if the test result on peak is lower than average limit, then average measurement needn't be performed.

Note: 4. The RBW set up, see Clause 6.6.

The worst case of Radiated Emission below 1GHz:

Engineer: LiuYu	
Site: AC2	Time: 2019/04/03 - 15:23
Limit: FCC_Part15.109_RE(3m)_ClassB	Margin: 0
Probe: AC2_3M(30-1000M)	Polarity: Horizontal
EUT: LED LAMP	Power: AC 120V/60Hz
Note: Mode 1	

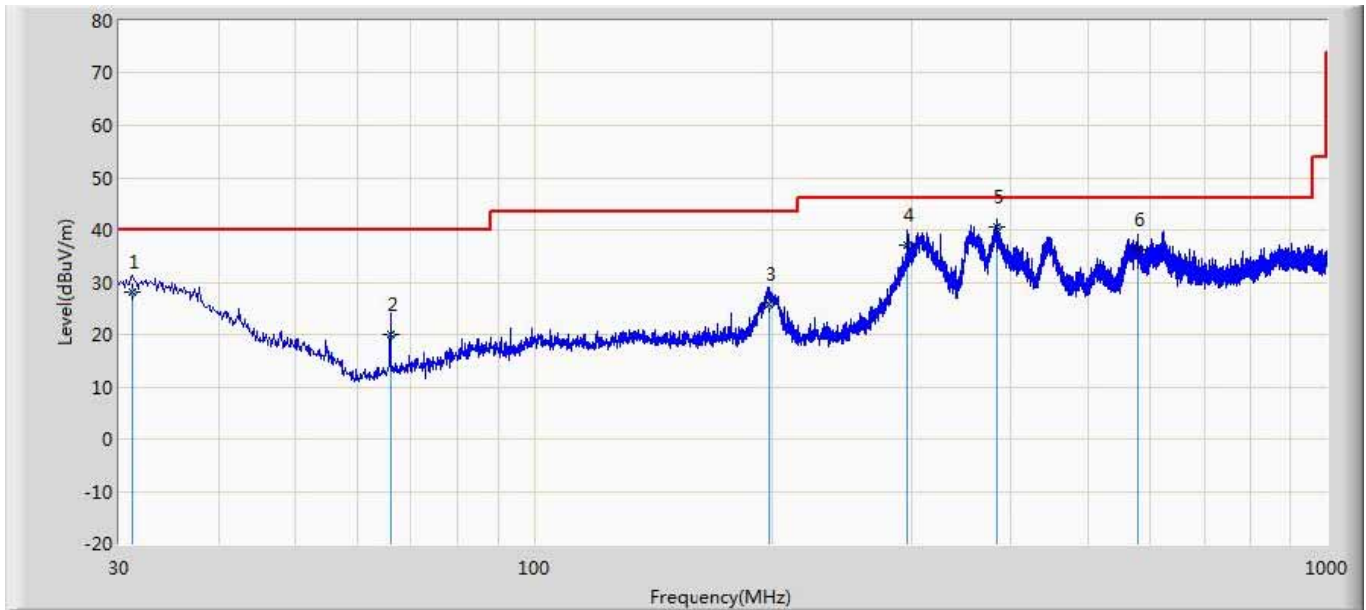

No	Mark	Frequency (MHz)	Measure Level (dBuV/m)	Reading Level (dBuV)	Over Limit (dB)	Limit (dBuV/m)	Factor (dB)	Ant Pos (cm)	Table Pos (deg)	Type
1		31.212	28.005	0.500	-11.995	40.000	27.504	100	77	QP
2		65.890	20.122	9.694	-19.878	40.000	10.428	200	165	QP
3		198.053	25.673	7.863	-17.827	43.500	17.811	200	248	QP
4		296.144	36.984	16.403	-9.016	46.000	20.581	100	75	QP
5	*	385.001	40.471	15.600	-5.529	46.000	24.871	100	82	QP
6		577.080	36.270	8.045	-9.730	46.000	28.225	164	360	QP

Note:

1. All Readings below 1GHz are Quasi-Peak, above are performed with peak and/or average measurements as necessary.
2. " * ", means this data is the worst emission level.
3. Measurement Level = Reading Level + Factor(Probe+Cable-Amp).

Engineer: LiuYu	
Site: AC2	Time: 2019/04/03 - 15:26
Limit: FCC_Part15.109_RE(3m)_ClassB	Margin: 0
Probe: AC2_3M(30-1000M)	Polarity: Vertical
EUT: LED LAMP	Power: AC 120V/60Hz
Note: Mode 1	

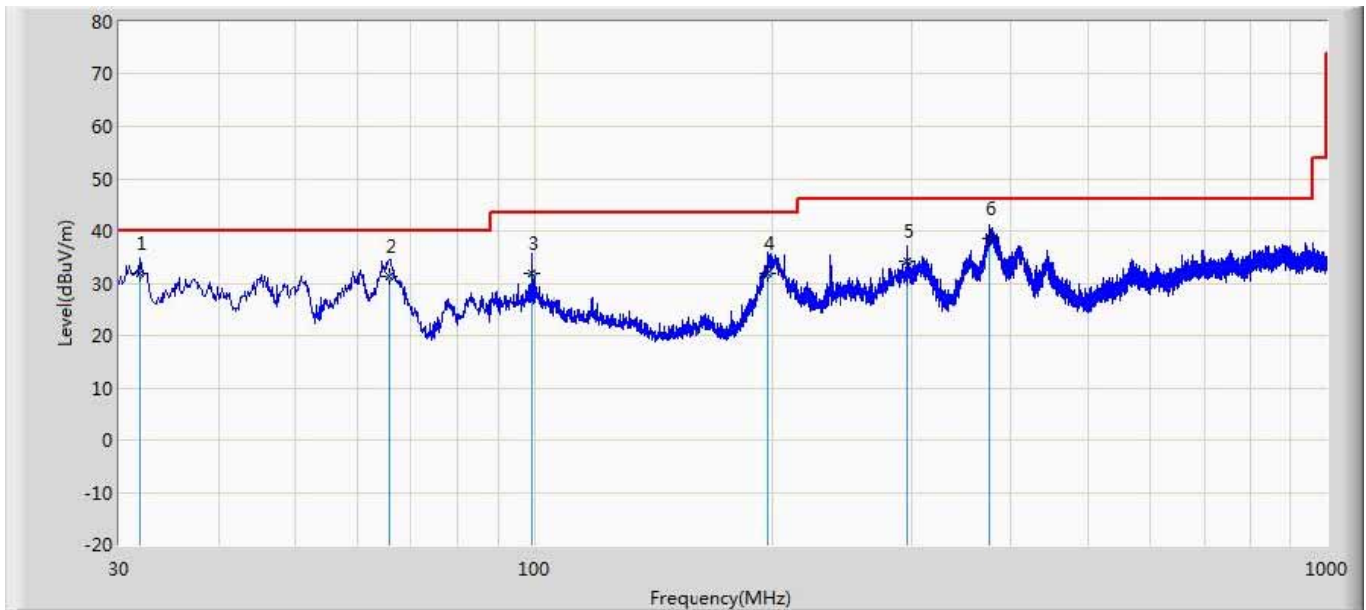

No	Mark	Frequency (MHz)	Measure Level (dBuV/m)	Reading Level (dBuV)	Over Limit (dB)	Limit (dBuV/m)	Factor (dB)	Ant Pos (cm)	Table Pos (deg)	Type
1		31.940	32.014	8.368	-7.986	40.000	23.646	100	247	QP
2		65.647	31.224	15.273	-8.776	40.000	15.951	200	0	QP
3		99.476	31.847	10.054	-11.653	43.500	21.793	105	306	QP
4		197.931	31.957	8.886	-11.543	43.500	23.070	100	156	QP
5		296.144	34.282	10.339	-11.718	46.000	23.942	200	17	QP
6	*	375.562	38.477	14.850	-7.523	46.000	23.627	151	360	QP

Note:

1. All Readings below 1GHz are Quasi-Peak, above are performed with peak and/or average measurements as necessary.
2. " * ", means this data is the worst emission level.
3. Measurement Level = Reading Level + Factor(Probe+Cable-Amp).

5. Emissions in non-restricted frequency bands

5.1. Test Equipment

Emissions in non-restricted frequency bands / TR-8					
Instrument	Manufacturer	Type No.	Serial No.	Cal. Date	Cal. Due Date
Spectrum Analyzer	Agilent	N9010A	MY48030494	2019.02.04	2020.02.03
EXA Spectrum Analyzer	Keysight	N9010A	MY55370495	2018.04.09	2019.04.08
MXA Signal Analyzer	Keysight	N9020A	MY56060147	2018.04.09	2019.04.08
Temperature/Humidity Meter	zhichen	ZC1-2	TR8-TH	2018.04.10	2019.04.09

Note: All equipments are calibrated with traceable calibrations. Each calibration is traceable to the national or international standards.

5.2. Test Setup

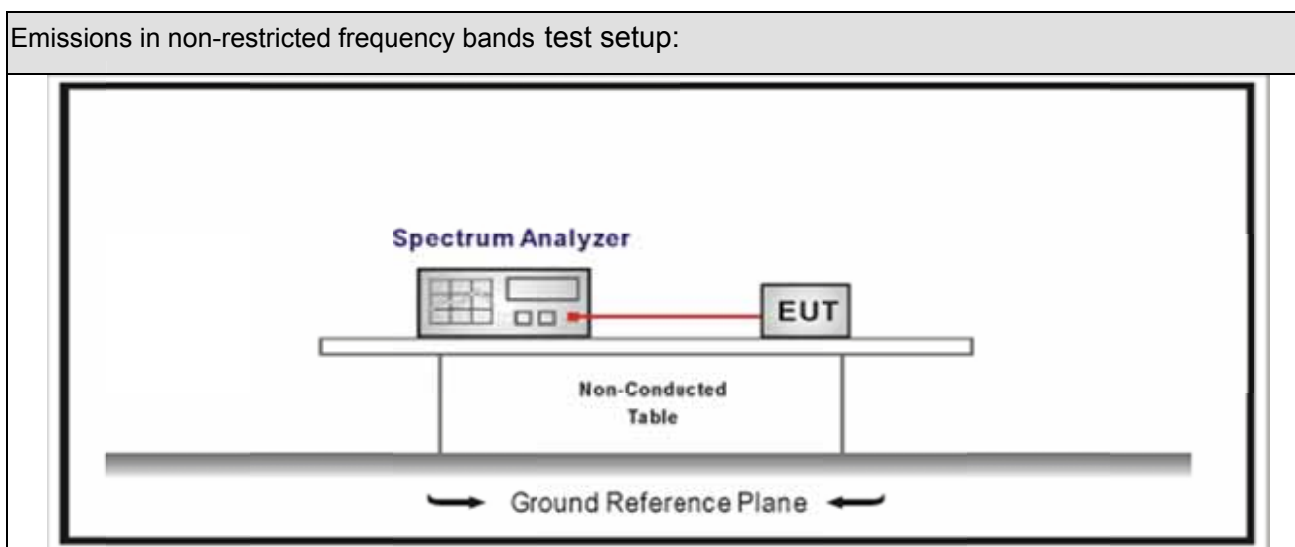



5.3. Limit

Un-Restricted Band Emissions Limit	
RF Output power (Detection methods)	Limit(dB)
RF Output power(Average detector)	30c(Note1)
RF Output power(PK detector)	20c(Note2)
<p>Note 1: If maximum conducted (average) output power was used to demonstrate compliance as described in 9.2, then the peak power in any 100 kHz bandwidth outside of the authorized frequency band shall be attenuated by at least 30 dB relative to the maximum in-band peak PSD level in 100 kHz (i.e., 30 dBc).</p> <p>Note 2: If the maximum peak conducted output power procedure was used, then the peak output power measured in any 100 kHz bandwidth outside of the authorized frequency band shall be attenuated by at least 20 dB relative to the maximum in-band peak PSD level in 100 kHz (i.e., 20 dBc).</p>	

5.4. Test Procedure

Test Method			
	References Rule	Chapter	Description
<input checked="" type="checkbox"/>	ANSI C63.10	11.11	Emissions in non-restricted frequency bands
	<input checked="" type="checkbox"/> ANSI C63.10	11.11.2	Reference level measurement
	<input checked="" type="checkbox"/> ANSI C63.10	11.11.3	Emission level measurement
<input type="checkbox"/>	ANSI C63.10	11.12	Emissions in restricted frequency bands
	<input type="checkbox"/> ANSI C63.10	11.12.1	Radiated emission measurements
	<input type="checkbox"/> ANSI C63.10	11.12.2.7	Radiated spurious emission test
<input type="checkbox"/>	ANSI C63.10	6.4	Radiated emissions from unlicensed wireless devices below 30 MHz
<input type="checkbox"/>	ANSI C63.10	6.5	Radiated emissions from unlicensed wireless devices in the frequency range of 30 MHz to 1000 MHz
<input type="checkbox"/>	ANSI C63.10	6.6	Radiated emissions from unlicensed wireless devices above 1 GHz
	<input type="checkbox"/> ANSI C63.10	11.12.2	Antenna-port conducted measurements
	<input type="checkbox"/> ANSI C63.10	11.12.2.3	Quasi-peak measurement procedure
	<input type="checkbox"/> ANSI C63.10	11.12.2.4	Peak power measurement procedure
	<input type="checkbox"/> ANSI C63.10	11.12.2.5	Average power measurement procedures
	<input type="checkbox"/> ANSI C63.10	11.12.2.5.1	Trace averaging with continuous EUT transmission at full power
	<input type="checkbox"/> ANSI C63.10	11.12.2.5.2	Trace averaging across ON and OFF times of the EUT transmissions followed by duty cycle correction
	<input type="checkbox"/> ANSI C63.10	11.12.2.5.3	Reduced VBW averaging across ON and OFF times of the EUT transmissions with max hold

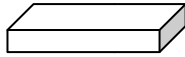
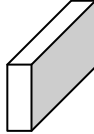
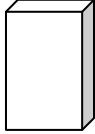
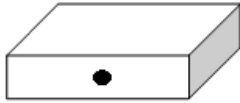
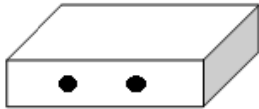
5.5. EUT test Axis definition

Item	Emissions in non-restricted frequency bands			
Device Category	<input type="checkbox"/>	Fixed point-to-point		
	<input type="checkbox"/>	Emit multiple directional beams, simultaneously or sequentially		
	<input checked="" type="checkbox"/>	Other cases		
Test mode	Mode 1			
Test method	<input type="checkbox"/>	Radiated		
		X Axis	Y Axis	Z Axis
				
		Worst Axis <input type="checkbox"/>	Worst Axis <input type="checkbox"/>	Worst Axis <input type="checkbox"/>
	<input checked="" type="checkbox"/>	Conducted		
	<input checked="" type="checkbox"/>	Chain 0		
				
	<input type="checkbox"/>	Chain 0	Chain 1	
				
		Worst Chain <input type="checkbox"/>	Worst Chain <input type="checkbox"/>	
	<input type="checkbox"/>	Chain 0	Chain 1	Chain 2
				
	Worst Chain <input type="checkbox"/>	Worst Chain <input type="checkbox"/>	Worst Chain <input type="checkbox"/>	

5.6. Test Result

Product Name	: LED lamp	Power	: AC 120V/60Hz
Test Mode	: Mode 1	Test Site	: TR-8
Test Date	: 2019.03.15		

Mode	Channel	Test Frequency (MHz)	In-Band PSD[a] (dBm/100kHz)	Frequency (MHz)	Out-Band PSD[b] (dBm/100kHz)	[a]-[b] (dB)	Limit (dB)	Result
1	11	2405	6.124	2400.00	-46.534	52.658	>20	Pass
1	26	2480	6.790	2500.00	-60.977	67.767	>20	Pass

Note: The worst case of Emissions in non-restricted frequency bands as below:

Mode 1 CH11 (2405MHz)



6. Radiated Emission Band Edge

6.1. Test Equipment

Radiated Emission Band Edge / AC-5					
Instrument	Manufacturer	Type No.	Serial No.	Cal. Date	Cal. Due Date
EMI Receiver	Agilent	N9038A	MY51210196	2018.07.16	2019.07.15
Pre-Amplifier	Miteq	NSP1800-25	1364185	2018.05.03	2019.05.02
DRG Horn Antenna	ETS-Lindgren	3117	00167055	2018.07.12	2019.07.11
Broad-Band Horn Antenna	Schwarzbeck	BBHA9170	294	2018.09.18	2019.09.17
Coaxial Cable	Huber+Suhner	SUCOFLEX 106	AC5-C1	2019.02.28	2020.02.27
Coaxial Cable	Huber+Suhner	SUCOFLEX 106	AC5-C2	2019.02.28	2020.02.27
Temperature/Humidity Meter	Zhichen	ZC1-2	AC5-TH	2019.01.05	2020.01.04

6.2. Test Setup

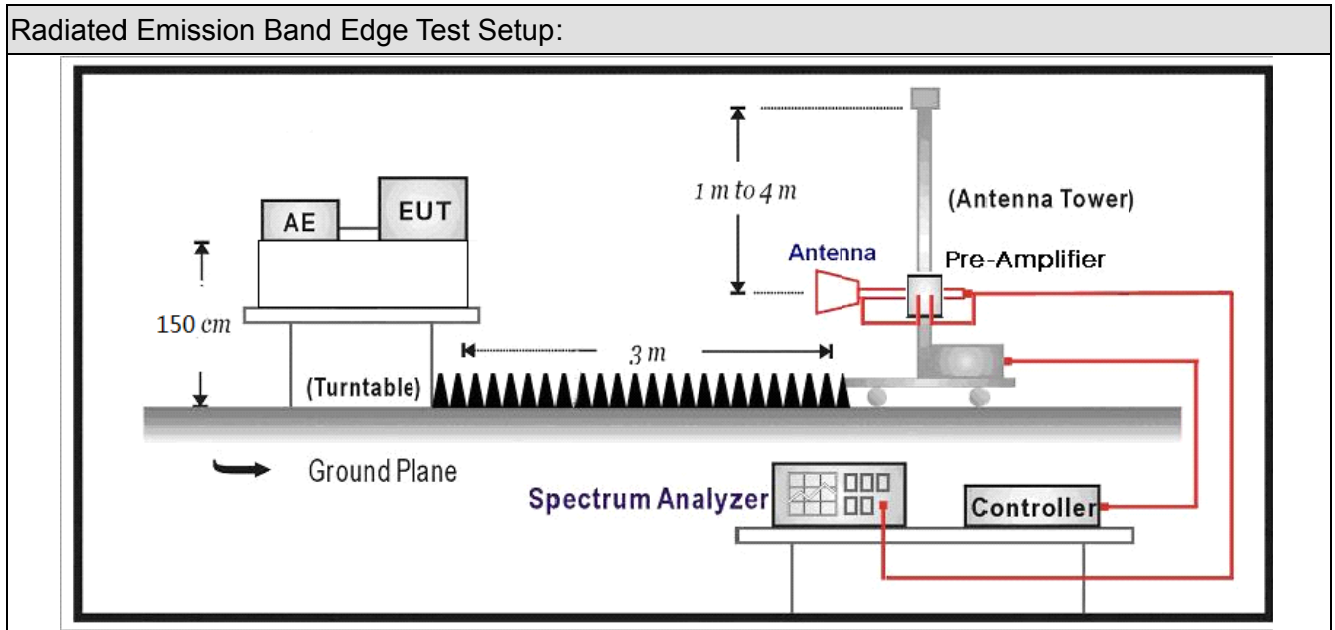

6.3. Limit



Band edge Limit				
Frequency bands (MHz)	Detector	Limit (dB μ V/m)	RBW (MHz)	Distance (m)
2310-2390	PK	74	1	3
2483.5-2500	AV	54	1	3

Note: The field strength of emissions appearing within these frequency bands shall not exceed the limits.

6.4. Test Procedure

Test Method			
	References Rule	Chapter	Description
<input checked="" type="checkbox"/>	ANSI C63.10	6.10	Band-edge testing
	<input checked="" type="checkbox"/> ANSI C63.10	6.10.5	Restricted-band band-edge measurements
	<input type="checkbox"/> ANSI C63.10	6.10.6	Marker-delta method
<input checked="" type="checkbox"/>	ANSI C63.10	11.12	Emissions in restricted frequency bands
	<input checked="" type="checkbox"/> ANSI C63.10	11.12.1	Radiated emission measurements
	<input checked="" type="checkbox"/> ANSI C63.10	11.12.2.7	Radiated spurious emission test
<input type="checkbox"/>	ANSI C63.10	6.4	Radiated emissions from unlicensed wireless devices below 30 MHz
<input type="checkbox"/>	ANSI C63.10	6.5	Radiated emissions from unlicensed wireless devices in the frequency range of 30 MHz to 1000 MHz
<input checked="" type="checkbox"/>	ANSI C63.10	6.6	Radiated emissions from unlicensed wireless devices above 1 GHz
	<input type="checkbox"/> ANSI C63.10	11.12.2.3	Quasi-peak measurement procedure
	<input type="checkbox"/> ANSI C63.10	11.12.2.4	Peak power measurement procedure
	<input type="checkbox"/> ANSI C63.10	11.12.2.5	Average power measurement procedures
	<input type="checkbox"/> ANSI C63.10	11.12.2.5.1	Trace averaging with continuous EUT transmission at full power
	<input type="checkbox"/> ANSI C63.10	11.12.2.5.2	Trace averaging across ON and OFF times of the EUT transmissions followed by duty cycle correction
	<input type="checkbox"/> ANSI C63.10	11.12.2.5.3	Reduced VBW averaging across ON and OFF times of the EUT transmissions with max hold

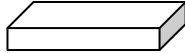
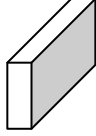
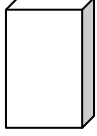
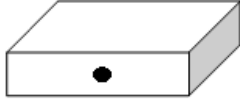
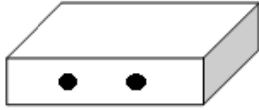
6.5. EUT test definition

Item	Radiated Emission Band Edge			
Device Category	<input type="checkbox"/>	Fixed point-to-point		
	<input type="checkbox"/>	Emit multiple directional beams, simultaneously or sequentially		
	<input checked="" type="checkbox"/>	Other cases		
Test mode	Mode 1			
Test method	<input checked="" type="checkbox"/>	Radiated		
		X Axis	Y Axis	Z Axis
				
		Worst Axis <input checked="" type="checkbox"/>	Worst Axis <input type="checkbox"/>	Worst Axis <input type="checkbox"/>
	<input type="checkbox"/>	Conducted		
	<input type="checkbox"/>	Chain 0		
				
	<input type="checkbox"/>	Chain 0	Chain 1	
				
	<input type="checkbox"/>	Chain 0	Chain 1	Chain 2
				

6.6. Duty Cycle

Test Mode	Tx On (ms)	Tx Off (ms)	Reduced VBW (Hz)	Tx On + Tx Off (ms)	Duty Cycle
Zigbee	N/A	N/A	10	N/A	100%

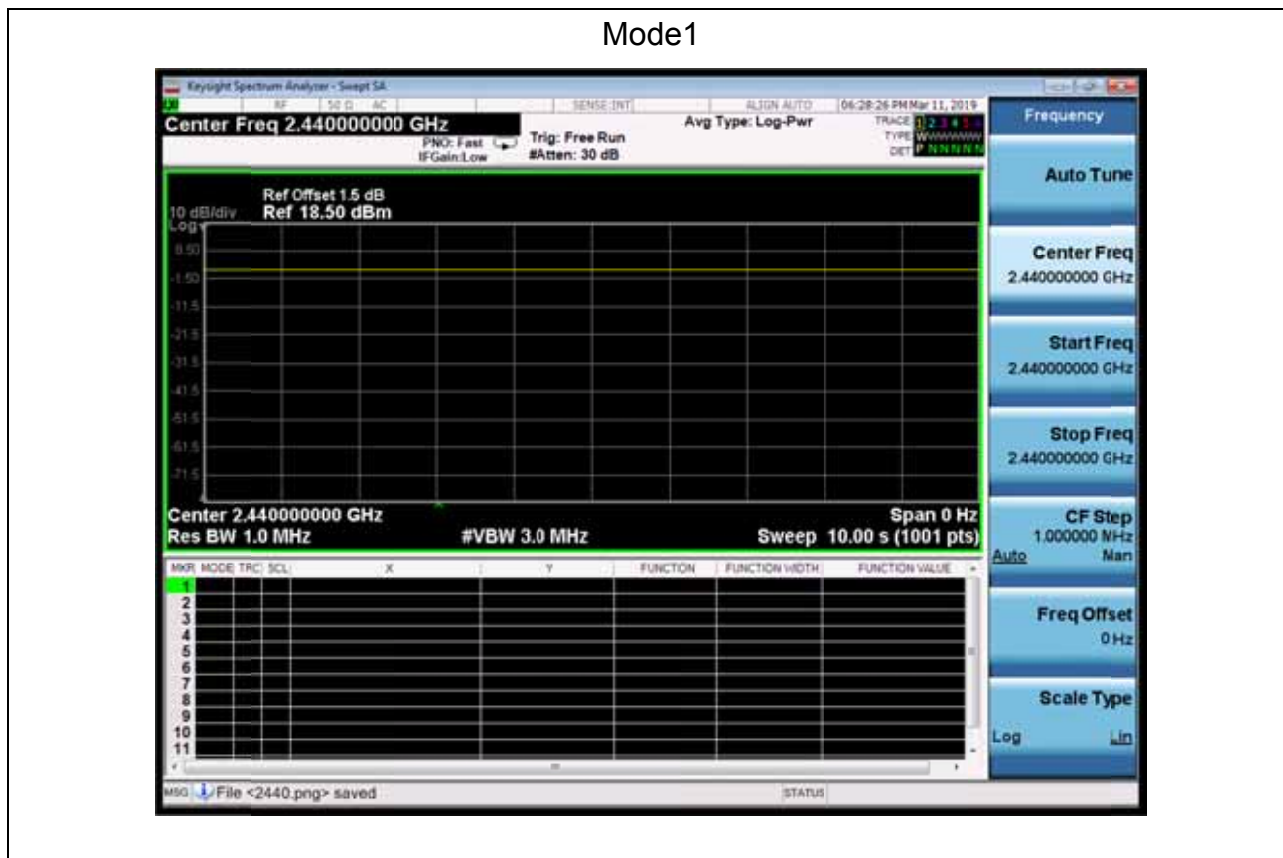

6.7 Test Result

Muruta:

Engineer: YULIU	
Site: AC5	Time: 2019/03/08 - 15:56
Limit: FCC_Part15.209_RE(3m)	Margin: 0
Probe: Horn_3117_00167055(1-18GHz)	Polarity: Vertical
EUT: LED LAMP	Power: AC 120V/60Hz
Note: Mode1:Transmit at 2405Mhz by Zigbee	

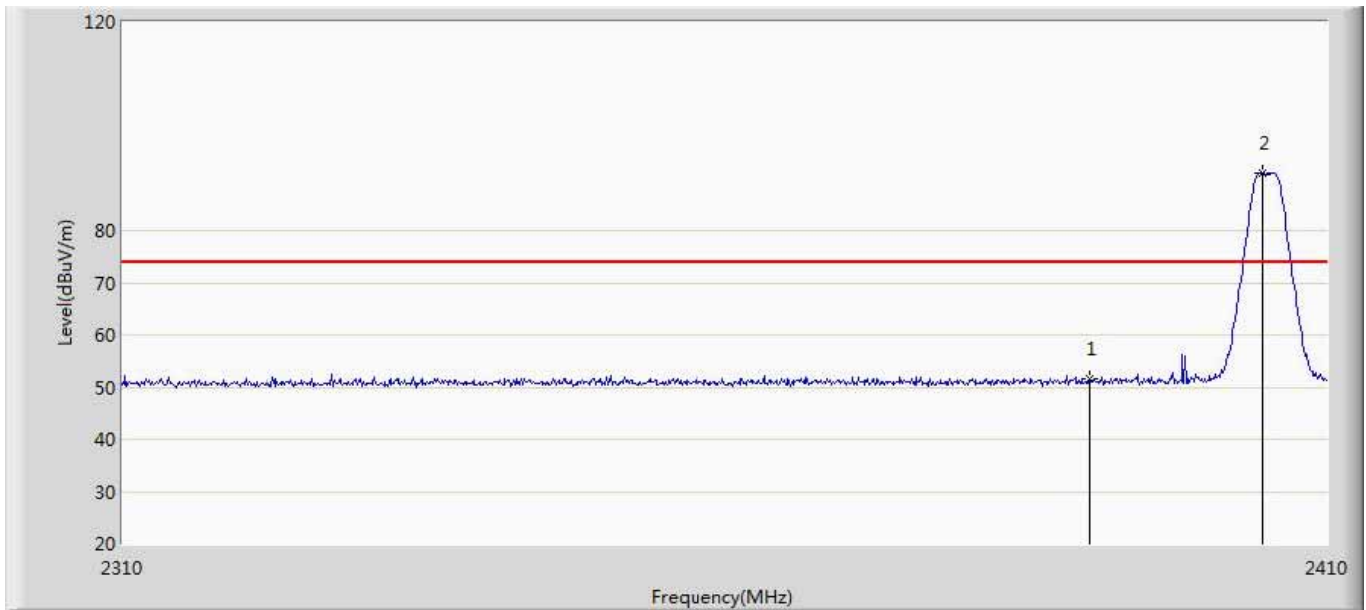

No	Mark	Frequency (MHz)	Measure Level (dBuV/m)	Reading Level (dBuV)	Over Limit (dB)	Limit (dBuV/m)	Factor (dB)	Type
1		2390.000	51.453	15.771	-22.547	74.000	35.682	PK
2	*	2404.500	91.153	55.434	17.153	74.000	35.719	PK

Engineer: YULIU	
Site: AC5	Time: 2019/03/09 - 12:29
Limit: FCC_Part15.209_RE(3m)	Margin: 0
Probe: Horn_3117_00167055(1-18GHz)	Polarity: Vertical
EUT: LED LAMP	Power: AC 120V/60Hz
Note: Mode1:Transmit at 2405Mhz by Zigbee	

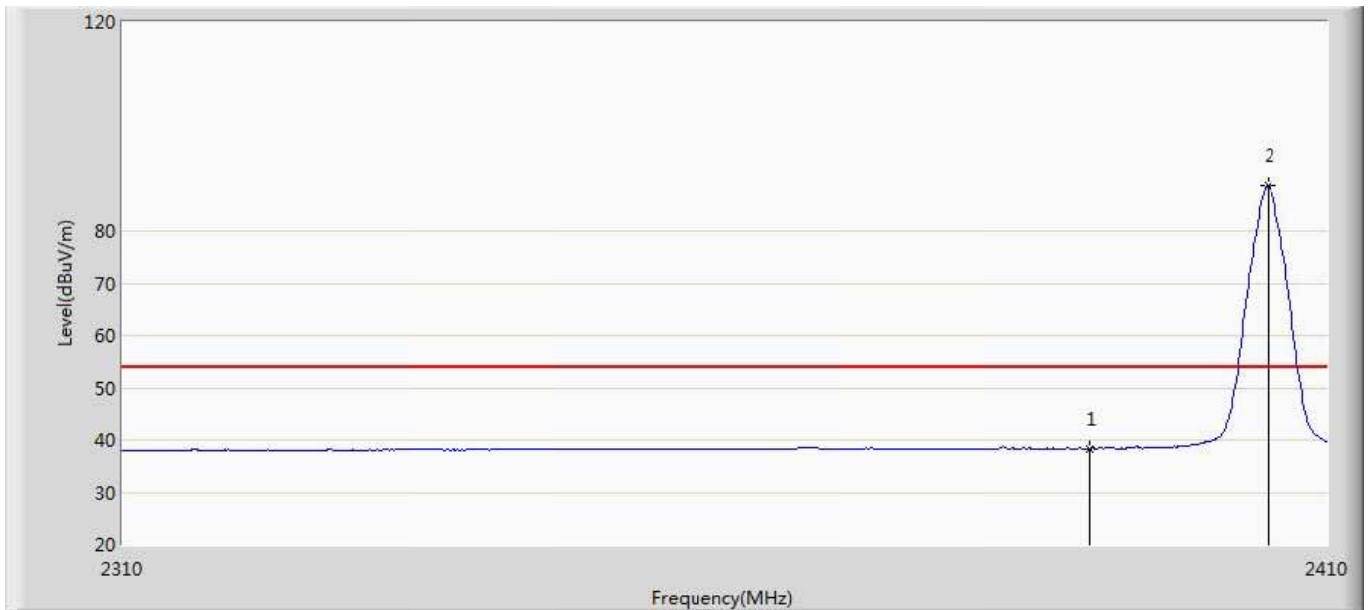

No	Mark	Frequency (MHz)	Measure Level (dBuV/m)	Reading Level (dBuV)	Over Limit (dB)	Limit (dBuV/m)	Factor (dB)	Type
1		2390.000	38.396	2.714	-15.604	54.000	35.682	AV
2	*	2405.000	88.606	52.885	34.606	54.000	35.721	AV

Engineer: YULIU	
Site: AC5	Time: 2019/03/09 - 12:42
Limit: FCC_Part15.209_RE(3m)	Margin: 0
Probe: Horn_3117_00167055(1-18GHz)	Polarity: Horizontal
EUT: LED LAMP	Power: AC 120V/60Hz
Note: Mode1:Transmit at 2405Mhz by Zigbee	

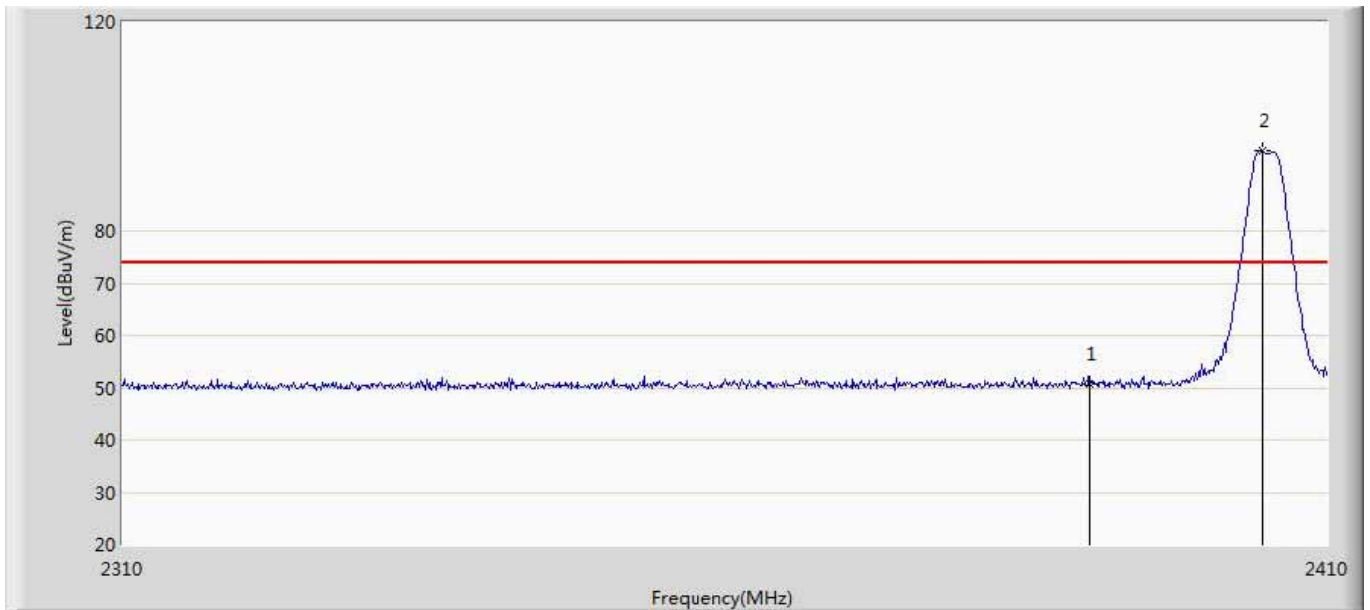

No	Mark	Frequency (MHz)	Measure Level (dBuV/m)	Reading Level (dBuV)	Over Limit (dB)	Limit (dBuV/m)	Factor (dB)	Type
1		2390.000	50.707	15.025	-23.293	74.000	35.682	PK
2	*	2404.500	95.314	59.595	21.314	74.000	35.719	PK

Engineer: YULIU	
Site: AC5	Time: 2019/03/09 - 12:45
Limit: FCC_Part15.209_RE(3m)	Margin: 0
Probe: Horn_3117_00167055(1-18GHz)	Polarity: Horizontal
EUT: LED LAMP	Power: AC 120V/60Hz
Note: Mode1:Transmit at 2405Mhz by Zigbee	

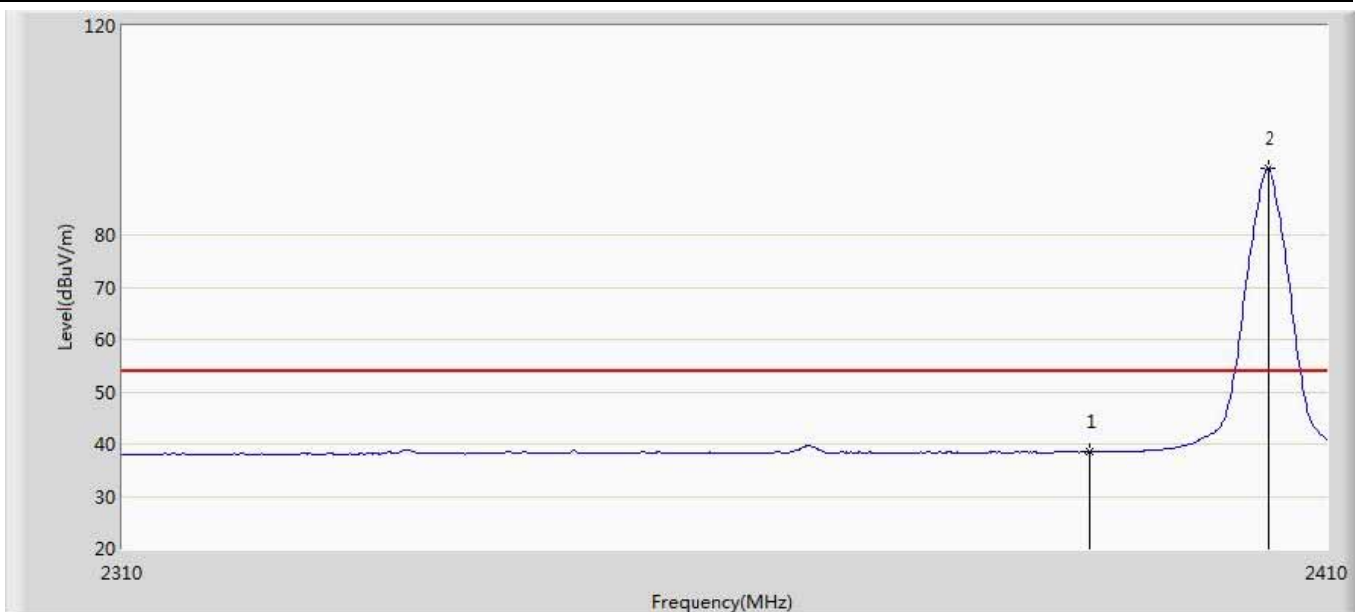

No	Mark	Frequency (MHz)	Measure Level (dBuV/m)	Reading Level (dBuV)	Over Limit (dB)	Limit (dBuV/m)	Factor (dB)	Type
1		2390.000	38.445	2.763	-15.555	54.000	35.682	AV
2	*	2405.000	92.708	56.987	38.708	54.000	35.721	AV

Engineer: YULIU	
Site: AC5	Time: 2019/03/09 - 12:58
Limit: FCC_Part15.209_RE(3m)	Margin: 0
Probe: Horn_3117_00167055(1-18GHz)	Polarity: Vertical
EUT: LED LAMP	Power: AC 120V/60Hz
Note: Mode1:Transmit at 2480Mhz by Zigbee	

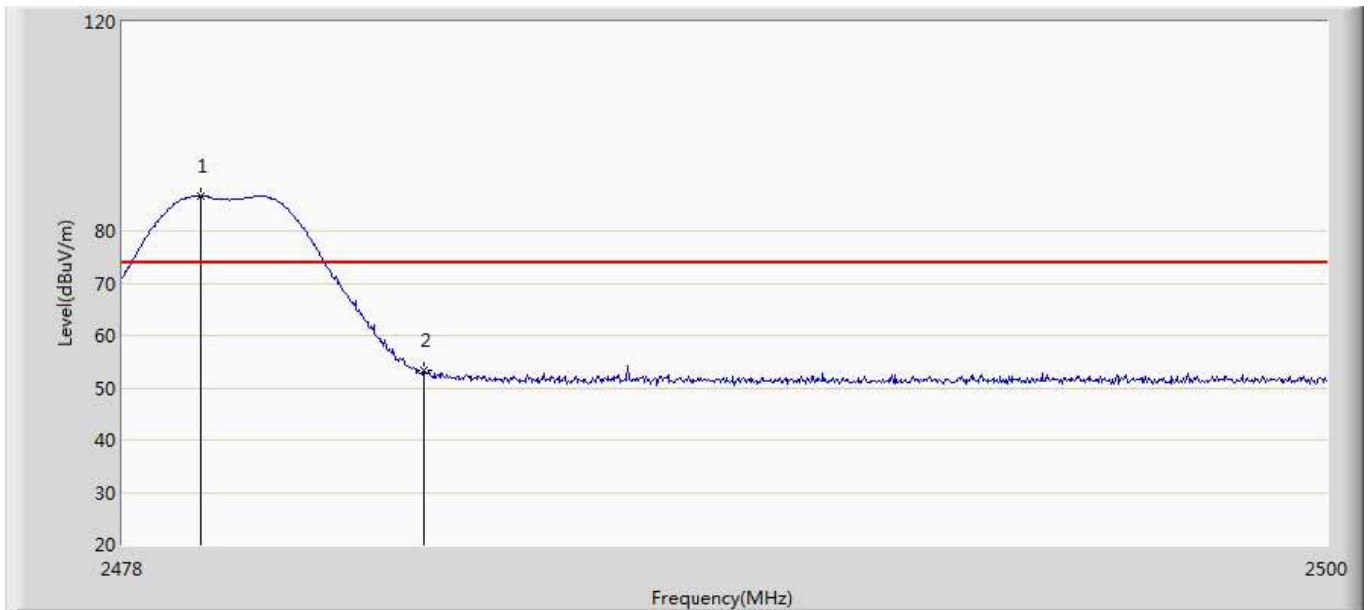

No	Mark	Frequency (MHz)	Measure Level (dBuV/m)	Reading Level (dBuV)	Over Limit (dB)	Limit (dBuV/m)	Factor (dB)	Type
1	*	2479.430	86.666	50.804	12.666	74.000	35.863	PK
2		2483.500	53.380	17.488	-20.620	74.000	35.891	PK

Engineer: YULIU	
Site: AC5	Time: 2019/03/09 - 13:14
Limit: FCC_Part15.209_RE(3m)	Margin: 0
Probe: Horn_3117_00167055(1-18GHz)	Polarity: Vertical
EUT: LED LAMP	Power: AC 120V/60Hz
Note: Mode1:Transmit at 2480Mhz by Zigbee	

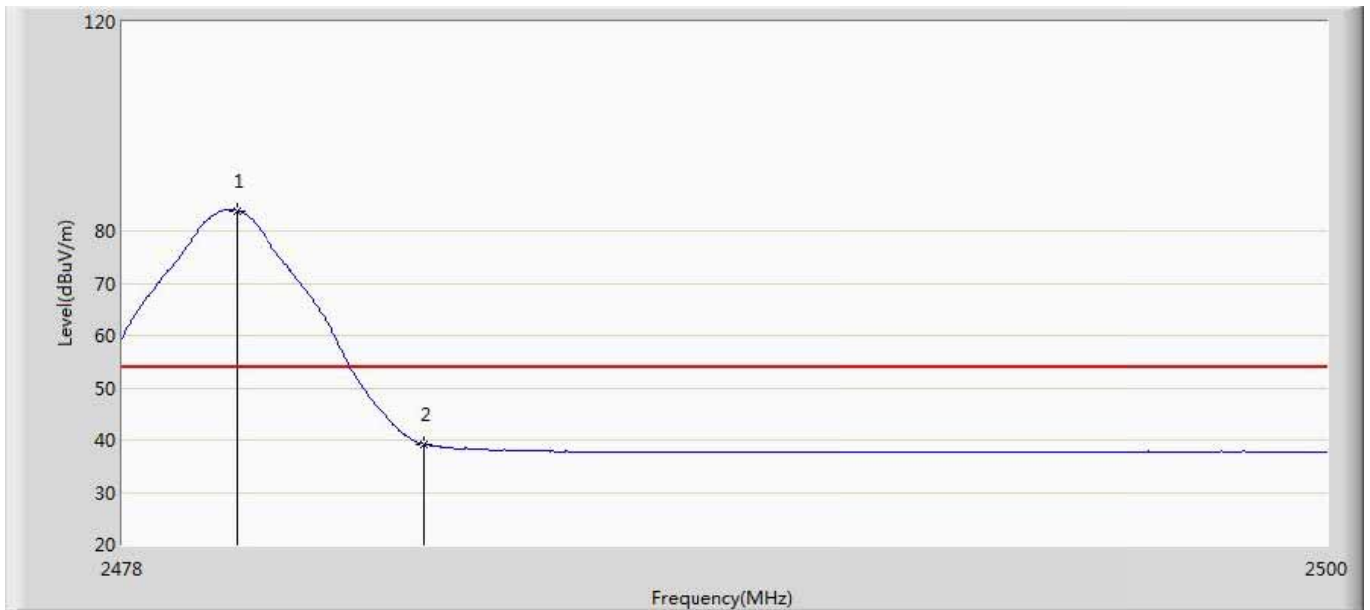

No	Mark	Frequency (MHz)	Measure Level (dBuV/m)	Reading Level (dBuV)	Over Limit (dB)	Limit (dBuV/m)	Factor (dB)	Type
1	*	2480.090	83.901	48.034	29.901	54.000	35.867	AV
2		2483.500	39.191	3.299	-14.809	54.000	35.891	AV

Engineer: YULIU	
Site: AC5	Time: 2019/03/09 - 13:18
Limit: FCC_Part15.209_RE(3m)	Margin: 0
Probe: Horn_3117_00167055(1-18GHz)	Polarity: Horizontal
EUT: LED LAMP	Power: AC 120V/60Hz
Note: Mode1:Transmit at 2480Mhz by Zigbee	

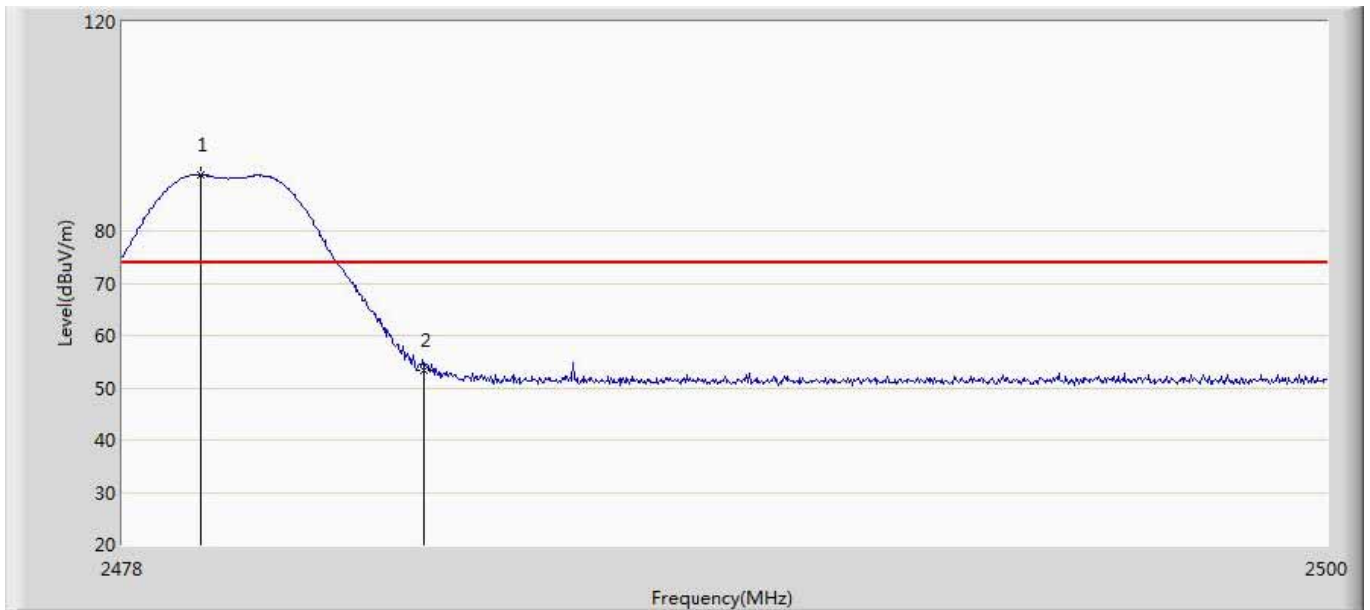

No	Mark	Frequency (MHz)	Measure Level (dBuV/m)	Reading Level (dBuV)	Over Limit (dB)	Limit (dBuV/m)	Factor (dB)	Type
1	*	2479.430	90.727	54.865	16.727	74.000	35.863	PK
2		2483.500	53.338	17.446	-20.662	74.000	35.891	PK

Engineer: YULIU	
Site: AC5	Time: 2019/03/09 - 13:22
Limit: FCC_Part15.209_RE(3m)	Margin: 0
Probe: Horn_3117_00167055(1-18GHz)	Polarity: Horizontal
EUT: LED LAMP	Power: AC 120V/60Hz
Note: Mode1:Transmit at 2480Mhz by Zigbee	

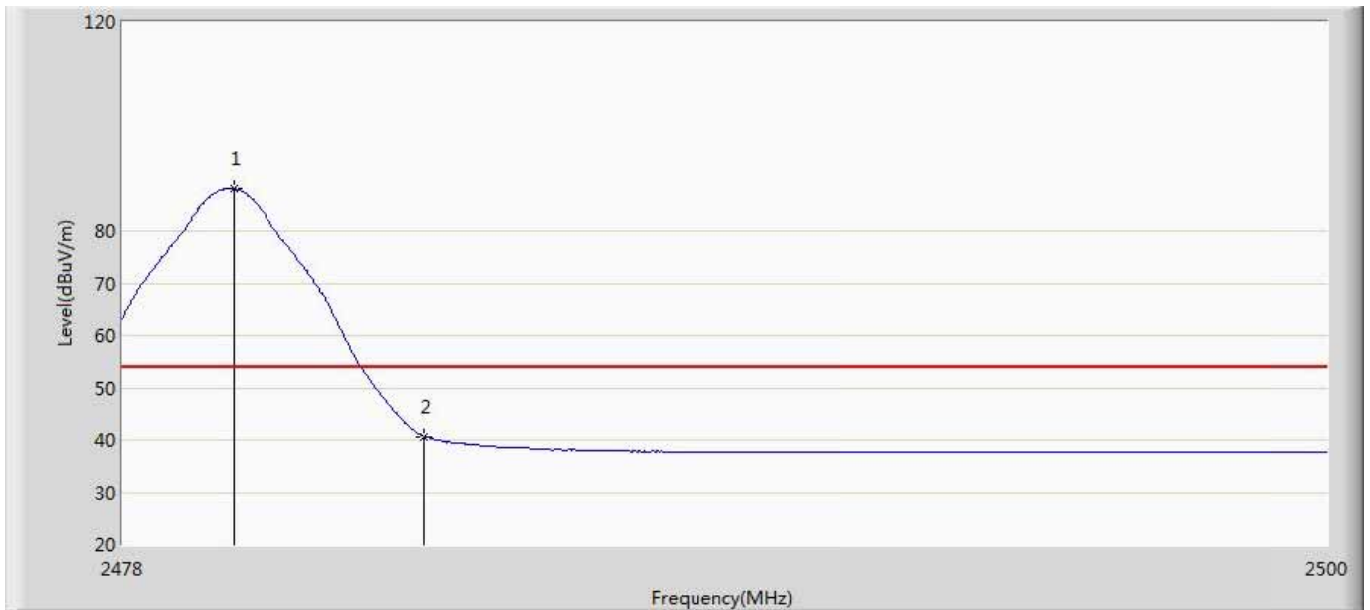

No	Mark	Frequency (MHz)	Measure Level (dBuV/m)	Reading Level (dBuV)	Over Limit (dB)	Limit (dBuV/m)	Factor (dB)	Type
1	*	2480.024	88.055	52.188	34.055	54.000	35.866	AV
2		2483.500	40.674	4.782	-13.326	54.000	35.891	AV

Diodes:

Engineer: YULIU	
Site: AC5	Time: 2019/03/08 - 15:56
Limit: FCC_Part15.209_RE(3m)	Margin: 0
Probe: Horn_3117_00167055(1-18GHz)	Polarity: Vertical
EUT: LED LAMP	Power: AC 120V/60Hz
Note: Mode1:Transmit at 2405Mhz by Zigbee	

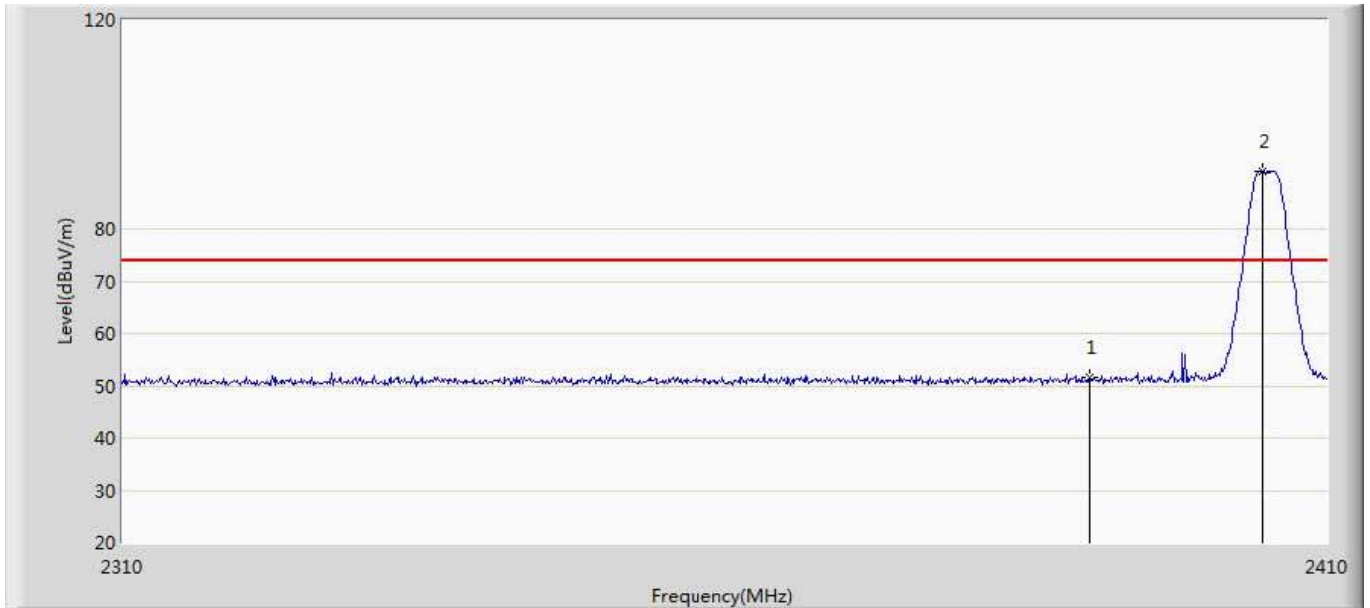

No	Mark	Frequency (MHz)	Measure Level (dBuV/m)	Reading Level (dBuV)	Over Limit (dB)	Limit (dBuV/m)	Factor (dB)	Type
1		2390.000	51.453	15.771	-22.547	74.000	35.682	PK
2	*	2404.500	91.153	55.434	17.153	74.000	35.719	PK

Engineer: YULIU	
Site: AC5	Time: 2019/03/09 - 12:29
Limit: FCC_Part15.209_RE(3m)	Margin: 0
Probe: Horn_3117_00167055(1-18GHz)	Polarity: Vertical
EUT: LED LAMP	Power: AC 120V/60Hz
Note: Mode1:Transmit at 2405Mhz by Zigbee	

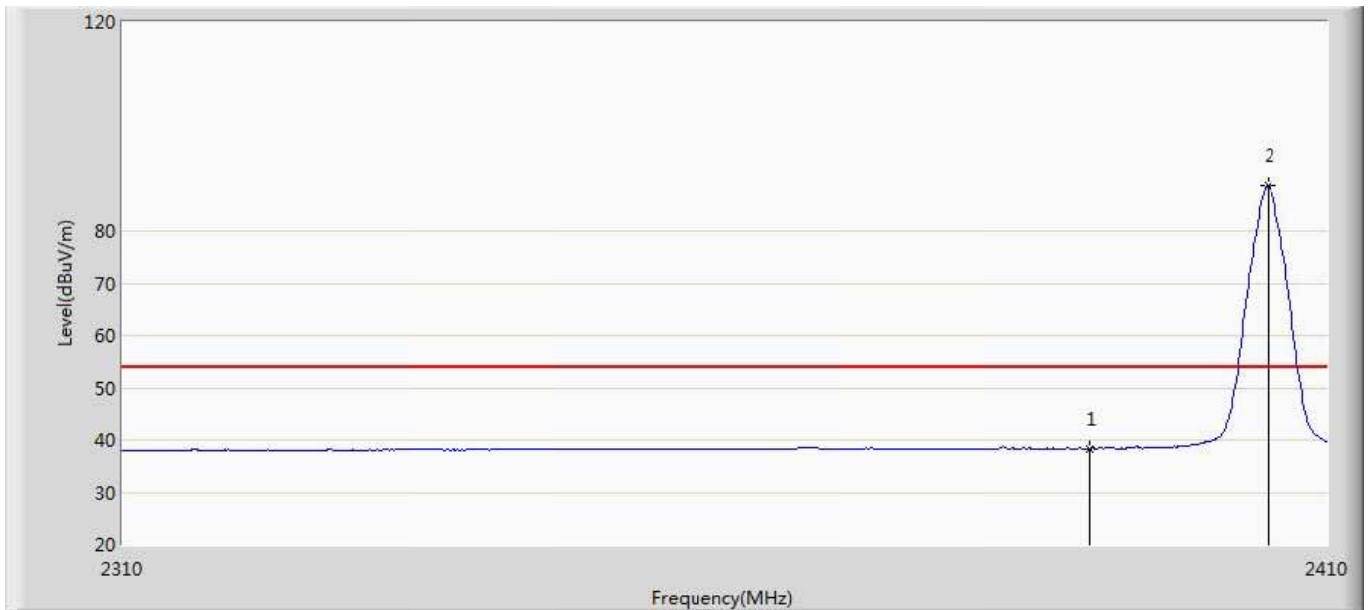

No	Mark	Frequency (MHz)	Measure Level (dBuV/m)	Reading Level (dBuV)	Over Limit (dB)	Limit (dBuV/m)	Factor (dB)	Type
1		2390.000	38.396	2.714	-15.604	54.000	35.682	AV
2	*	2405.000	88.606	52.885	34.606	54.000	35.721	AV

Engineer: YULIU	
Site: AC5	Time: 2019/03/09 - 12:42
Limit: FCC_Part15.209_RE(3m)	Margin: 0
Probe: Horn_3117_00167055(1-18GHz)	Polarity: Horizontal
EUT: LED LAMP	Power: AC 120V/60Hz
Note: Mode1:Transmit at 2405Mhz by Zigbee	

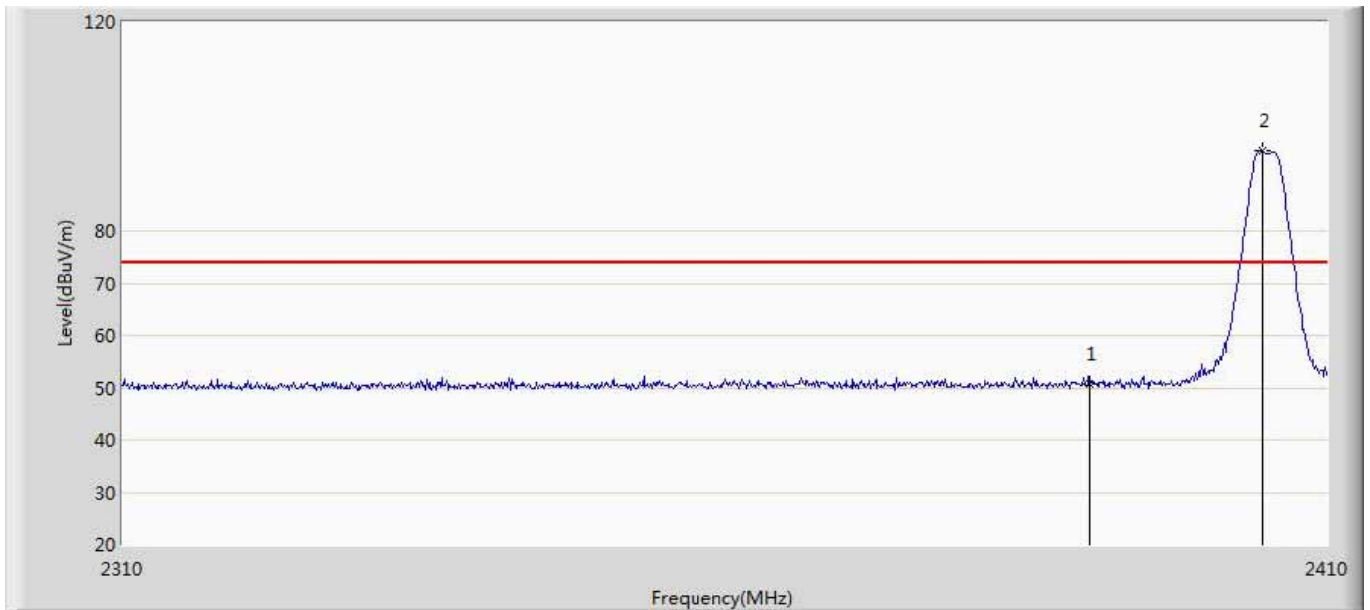

No	Mark	Frequency (MHz)	Measure Level (dBuV/m)	Reading Level (dBuV)	Over Limit (dB)	Limit (dBuV/m)	Factor (dB)	Type
1		2390.000	50.707	15.025	-23.293	74.000	35.682	PK
2	*	2404.500	95.314	59.595	21.314	74.000	35.719	PK

Engineer: YULIU	
Site: AC5	Time: 2019/03/09 - 12:45
Limit: FCC_Part15.209_RE(3m)	Margin: 0
Probe: Horn_3117_00167055(1-18GHz)	Polarity: Horizontal
EUT: LED LAMP	Power: AC 120V/60Hz
Note: Mode1:Transmit at 2405Mhz by Zigbee	

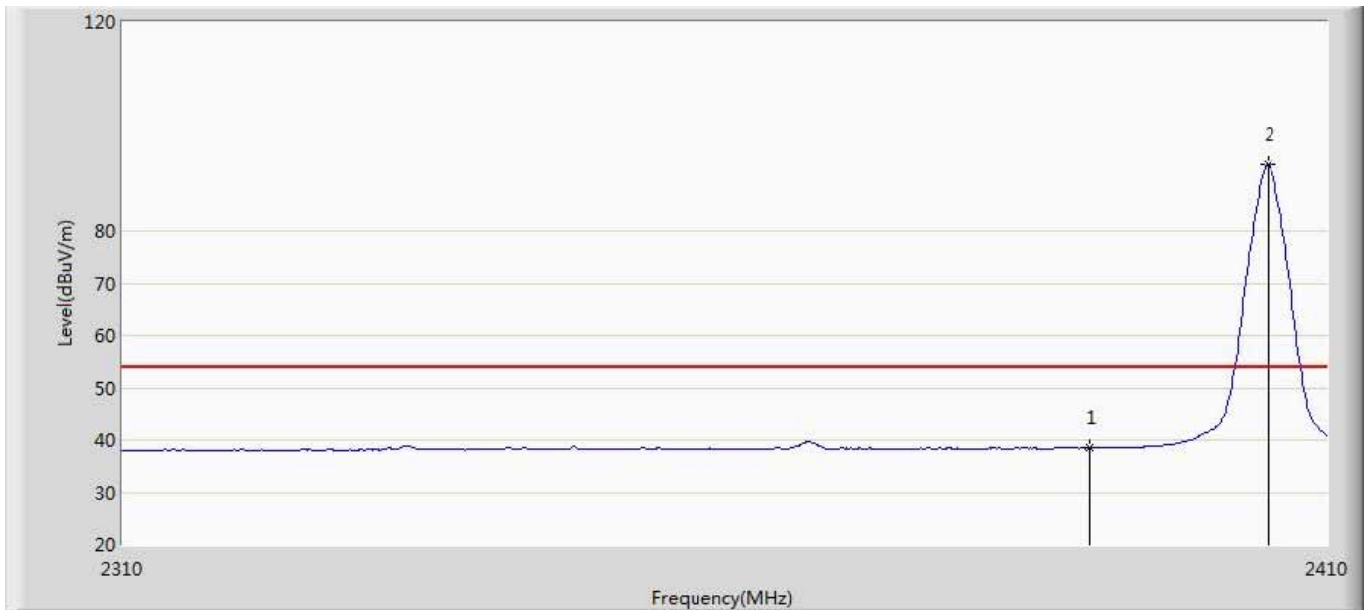

No	Mark	Frequency (MHz)	Measure Level (dBuV/m)	Reading Level (dBuV)	Over Limit (dB)	Limit (dBuV/m)	Factor (dB)	Type
1		2390.000	38.445	2.763	-15.555	54.000	35.682	AV
2	*	2405.000	92.708	56.987	38.708	54.000	35.721	AV

Engineer: YULIU	
Site: AC5	Time: 2019/03/09 - 12:58
Limit: FCC_Part15.209_RE(3m)	Margin: 0
Probe: Horn_3117_00167055(1-18GHz)	Polarity: Vertical
EUT: LED LAMP	Power: AC 120V/60Hz
Note: Mode1:Transmit at 2480Mhz by Zigbee	

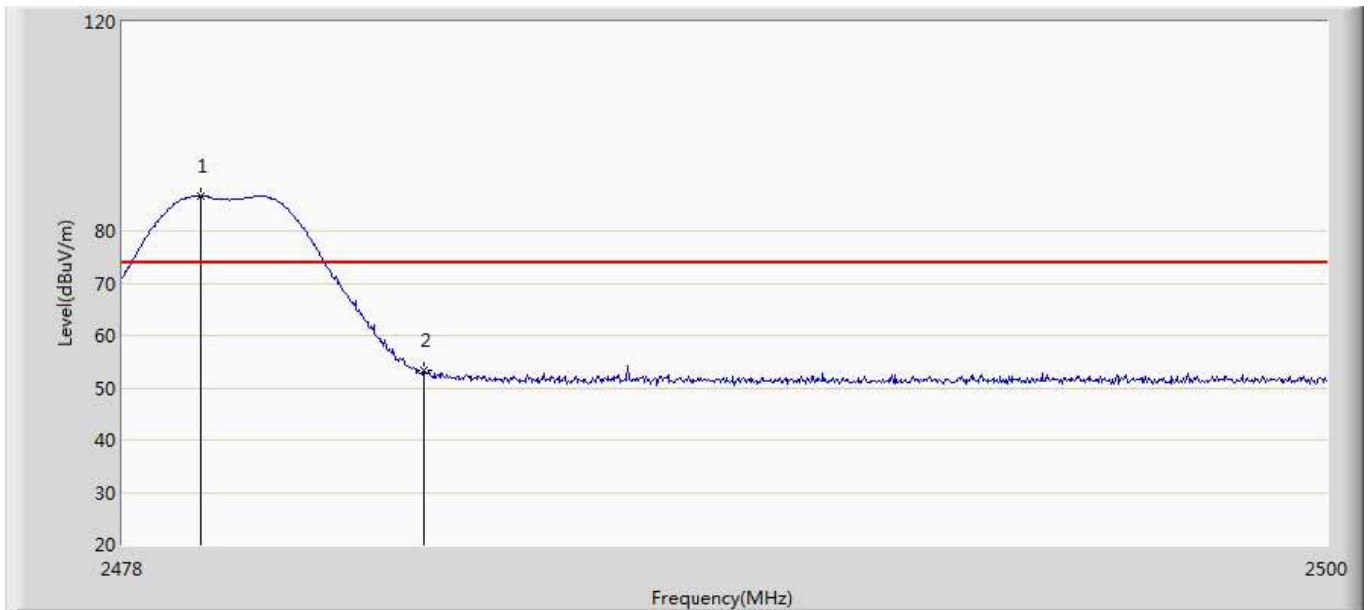

No	Mark	Frequency (MHz)	Measure Level (dBuV/m)	Reading Level (dBuV)	Over Limit (dB)	Limit (dBuV/m)	Factor (dB)	Type
1	*	2479.430	86.666	50.804	12.666	74.000	35.863	PK
2		2483.500	53.380	17.488	-20.620	74.000	35.891	PK

Engineer: YULIU	
Site: AC5	Time: 2019/03/09 - 13:14
Limit: FCC_Part15.209_RE(3m)	Margin: 0
Probe: Horn_3117_00167055(1-18GHz)	Polarity: Vertical
EUT: LED LAMP	Power: AC 120V/60Hz
Note: Mode1:Transmit at 2480Mhz by Zigbee	

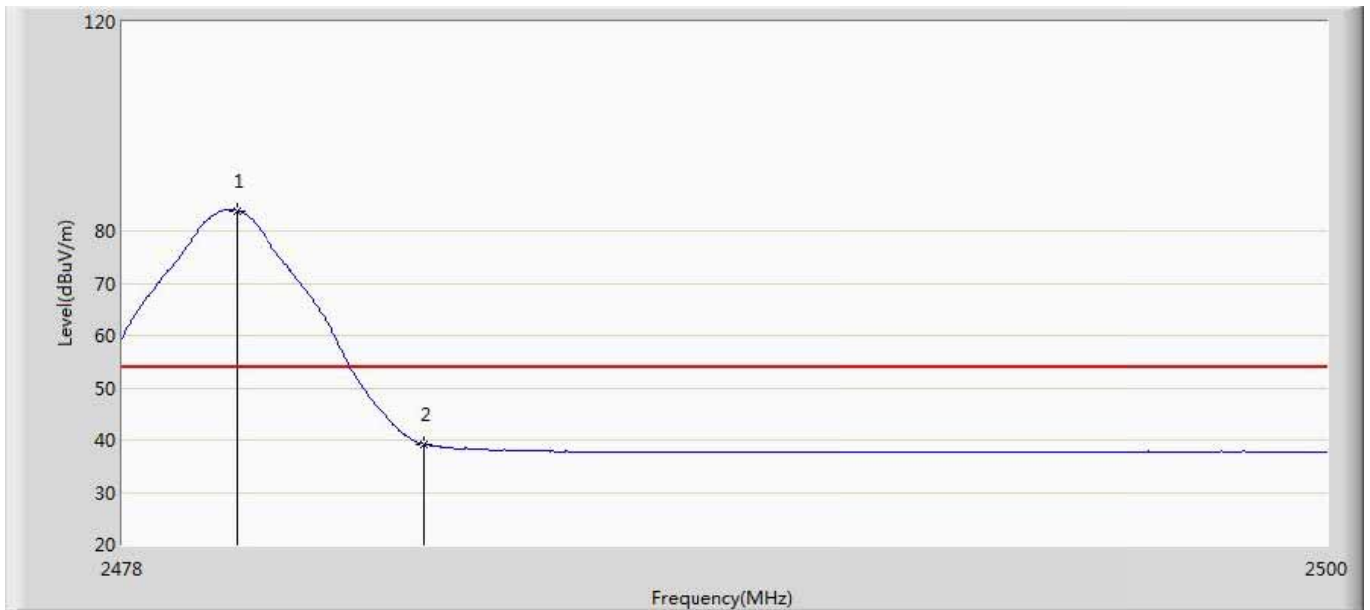

No	Mark	Frequency (MHz)	Measure Level (dBuV/m)	Reading Level (dBuV)	Over Limit (dB)	Limit (dBuV/m)	Factor (dB)	Type
1	*	2480.090	83.901	48.034	29.901	54.000	35.867	AV
2		2483.500	39.191	3.299	-14.809	54.000	35.891	AV

Engineer: YULIU	
Site: AC5	Time: 2019/03/09 - 13:18
Limit: FCC_Part15.209_RE(3m)	Margin: 0
Probe: Horn_3117_00167055(1-18GHz)	Polarity: Horizontal
EUT: LED LAMP	Power: AC 120V/60Hz
Note: Mode1:Transmit at 2480Mhz by Zigbee	

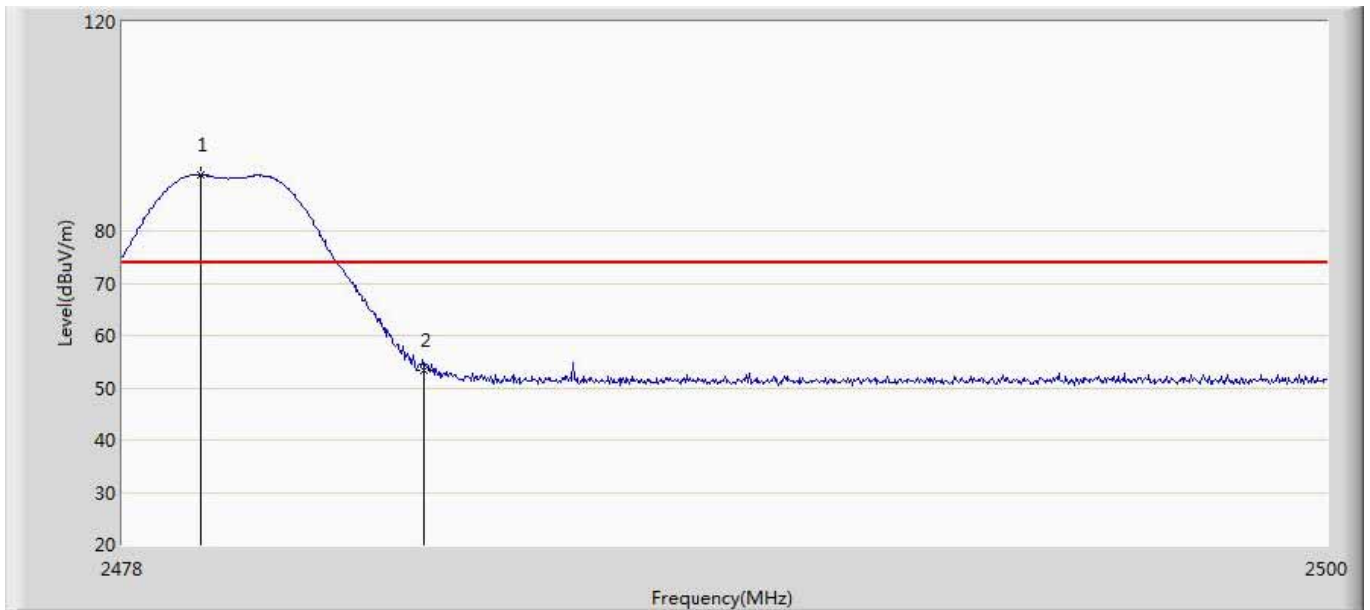

No	Mark	Frequency (MHz)	Measure Level (dBuV/m)	Reading Level (dBuV)	Over Limit (dB)	Limit (dBuV/m)	Factor (dB)	Type
1	*	2479.430	90.727	54.865	16.727	74.000	35.863	PK
2		2483.500	53.338	17.446	-20.662	74.000	35.891	PK

Engineer: YULIU	
Site: AC5	Time: 2019/03/09 - 13:22
Limit: FCC_Part15.209_RE(3m)	Margin: 0
Probe: Horn_3117_00167055(1-18GHz)	Polarity: Horizontal
EUT: LED LAMP	Power: AC 120V/60Hz
Note: Mode1:Transmit at 2480Mhz by Zigbee	

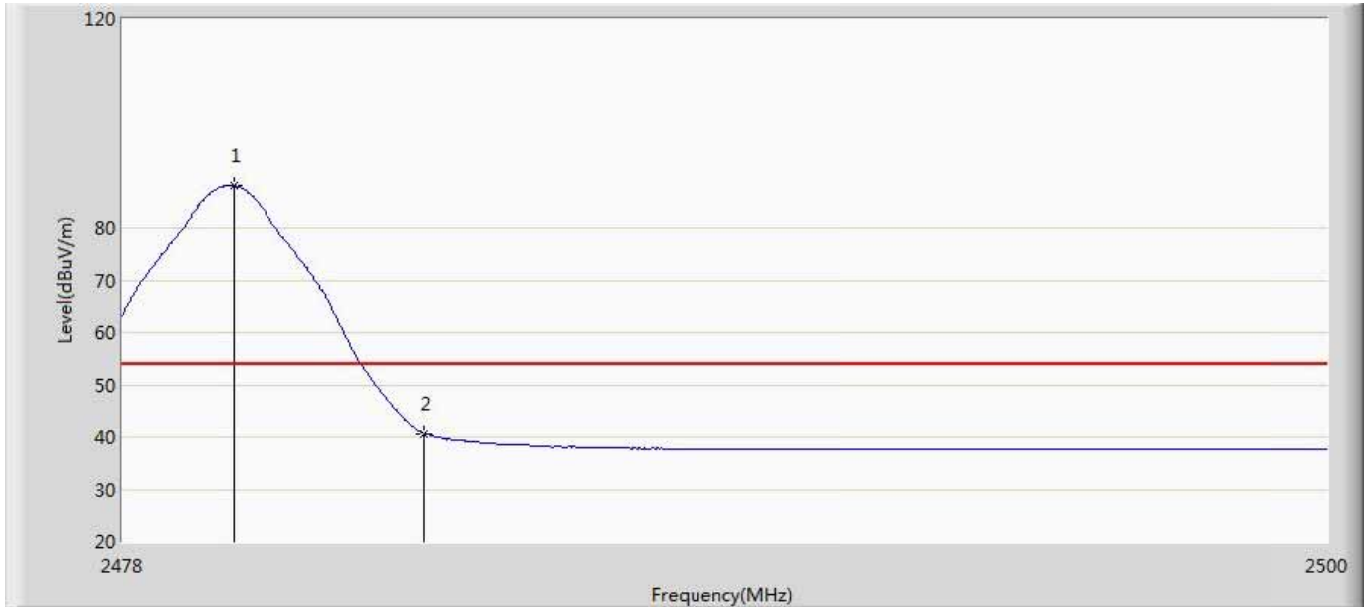

No	Mark	Frequency (MHz)	Measure Level (dBuV/m)	Reading Level (dBuV)	Over Limit (dB)	Limit (dBuV/m)	Factor (dB)	Type
1	*	2480.024	88.055	52.188	34.055	54.000	35.866	AV
2		2483.500	40.674	4.782	-13.326	54.000	35.891	AV

Kdx:

Engineer: YULIU	
Site: AC5	Time: 2019/04/11 - 21:27
Limit: FCC_Part15.209_RE(3m)	Margin: 0
Probe: Horn_3117_00167055(1-18GHz)	Polarity: Vertical
EUT:LED LAMP	Power: AC 120V/60Hz
Note: Mode 1:Transmit at 2405MHz by Zigbee	

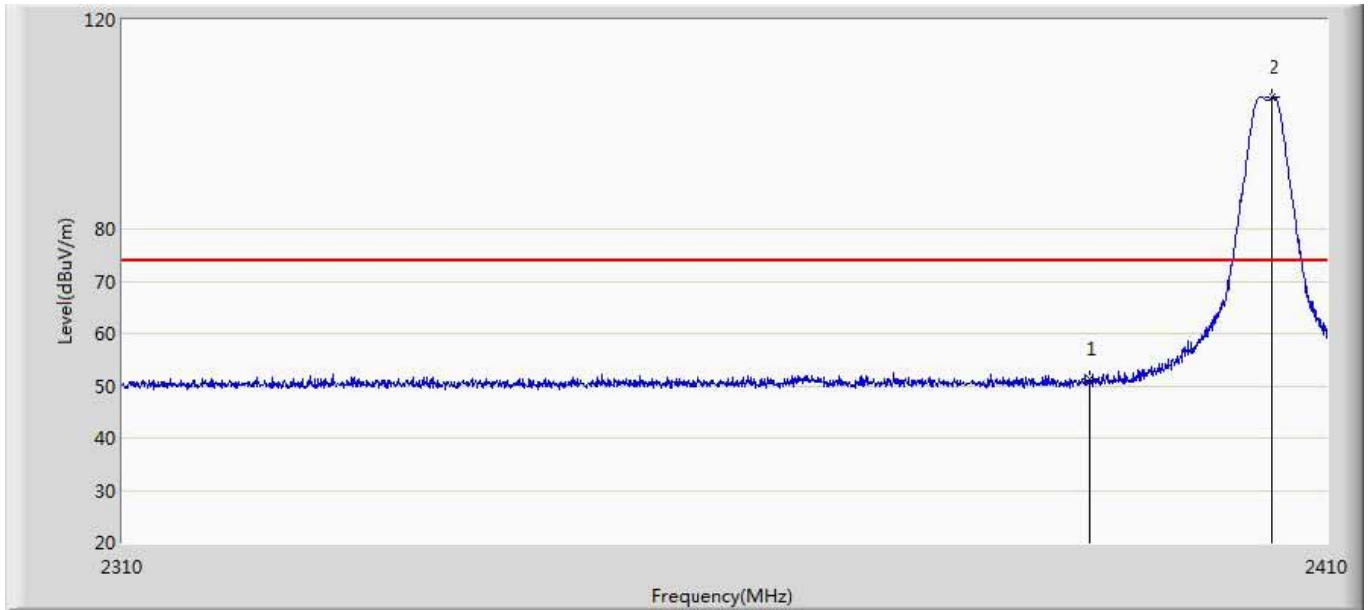

No	Mark	Frequency (MHz)	Measure Level (dBuV/m)	Reading Level (dBuV)	Over Limit (dB)	Limit (dBuV/m)	Factor (dB)	Type
1		2390.000	51.280	15.598	-22.720	74.000	35.682	PK
2	*	2405.350	105.259	69.537	31.259	74.000	35.721	PK

Engineer: YULIU	
Site: AC5	Time: 2019/04/11 - 21:29
Limit: FCC_Part15.209_RE(3m)	Margin: 0
Probe: Horn_3117_00167055(1-18GHz)	Polarity: Vertical
EUT:LED LAMP	Power: AC 120V/60Hz
Note: Mode 1:Transmit at 2405MHz by Zigbee	

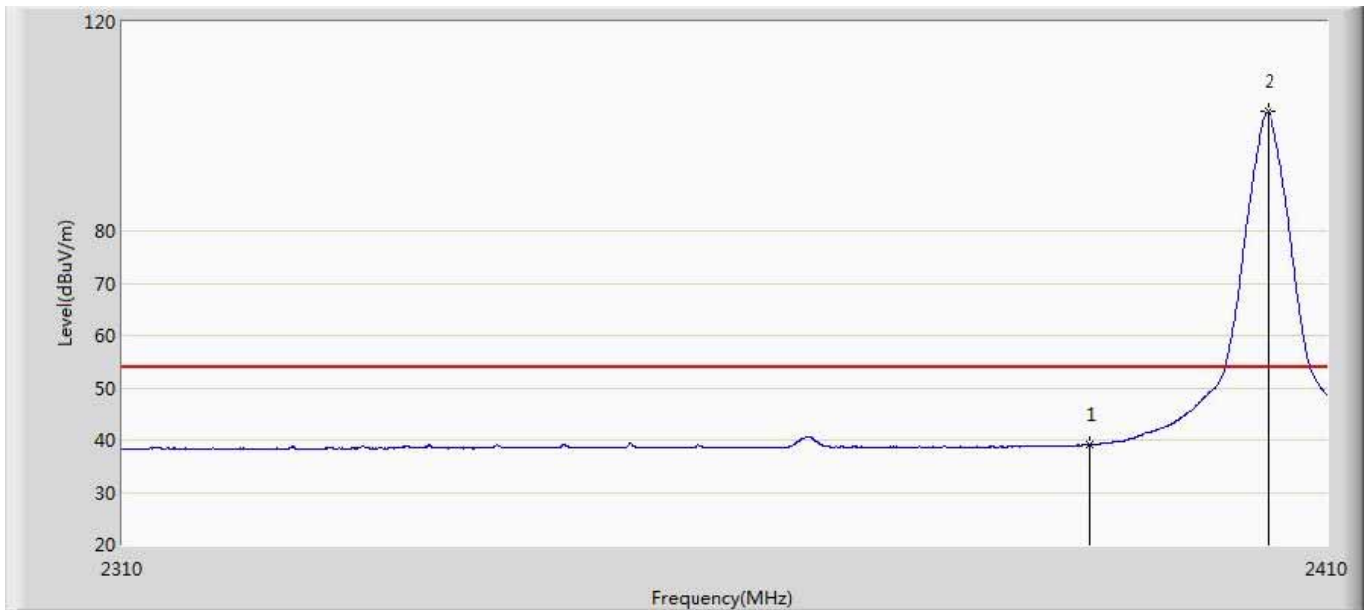

No	Mark	Frequency (MHz)	Measure Level (dBuV/m)	Reading Level (dBuV)	Over Limit (dB)	Limit (dBuV/m)	Factor (dB)	Type
1		2390.000	39.099	3.417	-14.901	54.000	35.682	AV
2	*	2405.000	102.766	67.045	48.766	54.000	35.721	AV

Engineer: YULIU	
Site: AC5	Time: 2019/04/11 - 21:32
Limit: FCC_Part15.209_RE(3m)	Margin: 0
Probe: Horn_3117_00167055(1-18GHz)	Polarity: Horizontal
EUT:LED LAMP	Power: AC 120V/60Hz
Note: Mode 1:Transmit at 2405MHz by Zigbee	

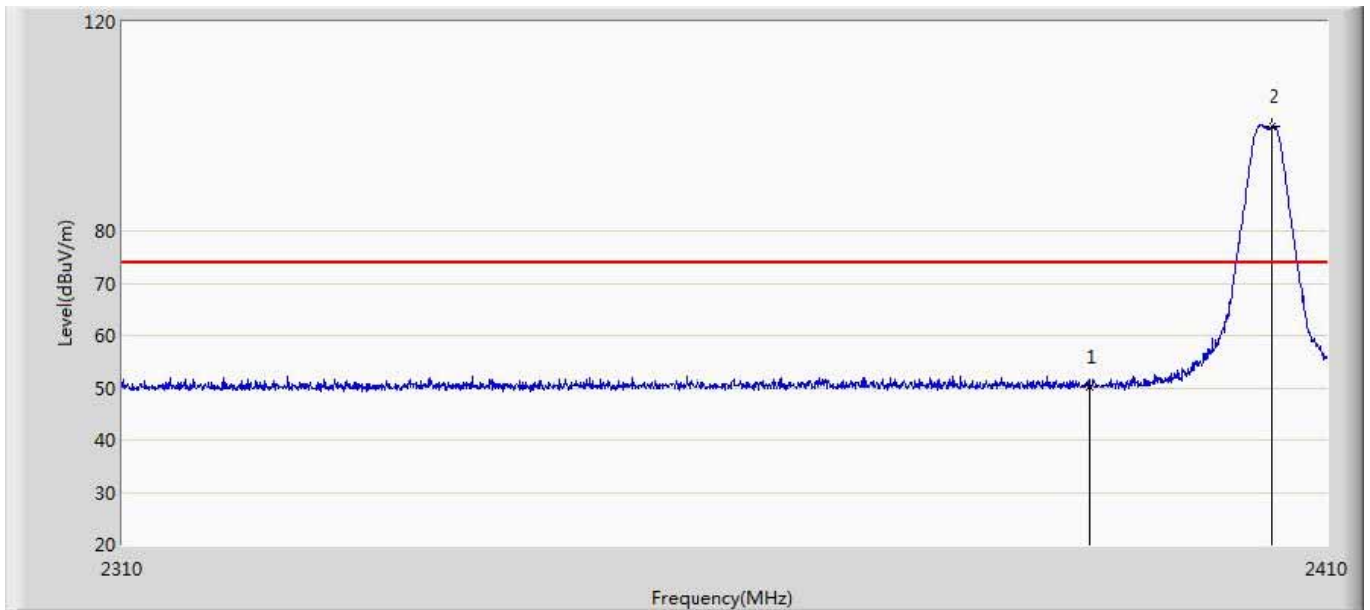

No	Mark	Frequency (MHz)	Measure Level (dBuV/m)	Reading Level (dBuV)	Over Limit (dB)	Limit (dBuV/m)	Factor (dB)	Type
1		2390.000	50.247	14.565	-23.753	74.000	35.682	PK
2	*	2405.350	100.053	64.331	26.053	74.000	35.721	PK

Engineer: YULIU	
Site: AC5	Time: 2019/04/11 - 21:33
Limit: FCC_Part15.209_RE(3m)	Margin: 0
Probe: Horn_3117_00167055(1-18GHz)	Polarity: Horizontal
EUT:LED LAMP	Power: AC 120V/60Hz
Note: Mode 1:Transmit at 2405MHz by Zigbee	

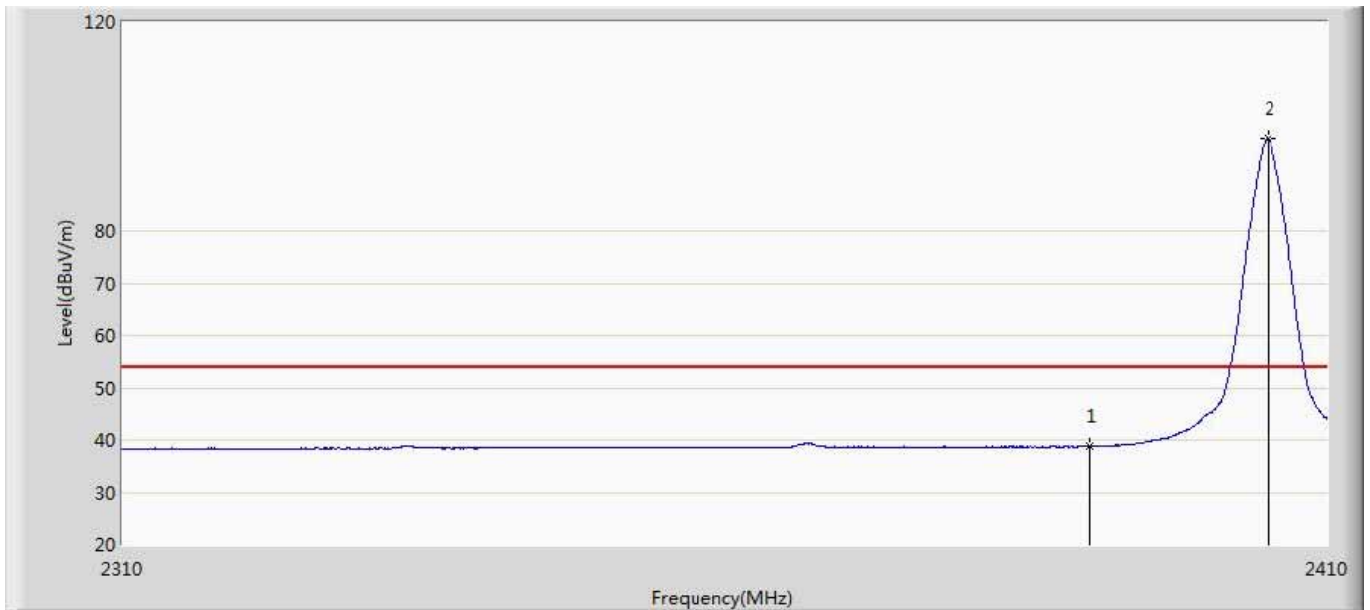

No	Mark	Frequency (MHz)	Measure Level (dBuV/m)	Reading Level (dBuV)	Over Limit (dB)	Limit (dBuV/m)	Factor (dB)	Type
1		2390.000	38.776	3.094	-15.224	54.000	35.682	AV
2	*	2405.000	97.635	61.914	43.635	54.000	35.721	AV

Engineer: YULIU	
Site: AC5	Time: 2019/04/11 - 21:36
Limit: FCC_Part15.209_RE(3m)	Margin: 0
Probe: Horn_3117_00167055(1-18GHz)	Polarity: Vertical
EUT:LED LAMP	Power: AC 120V/60Hz
Note: Mode 1:Transmit at 2480MHz by Zigbee	

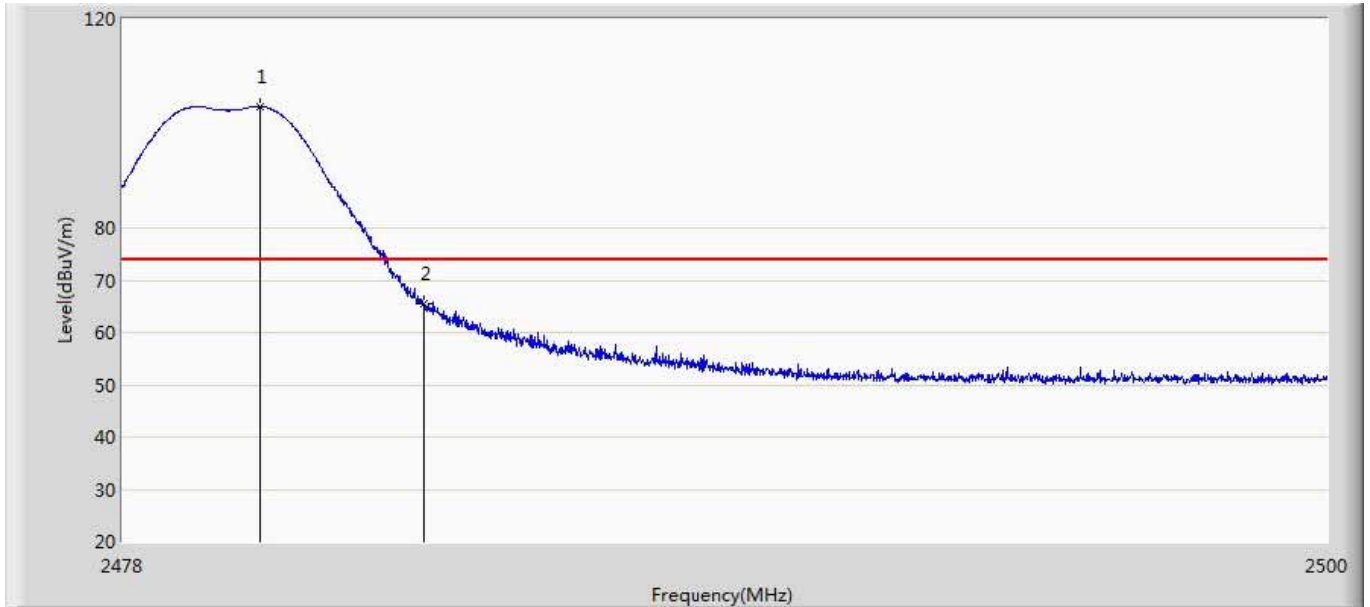

No	Mark	Frequency (MHz)	Measure Level (dBuV/m)	Reading Level (dBuV)	Over Limit (dB)	Limit (dBuV/m)	Factor (dB)	Type
1	*	2480.497	103.158	67.288	29.158	74.000	35.870	PK
2		2483.500	65.392	29.500	-8.608	74.000	35.891	PK

Engineer: YULIU	
Site: AC5	Time: 2019/04/11 - 21:37
Limit: FCC_Part15.209_RE(3m)	Margin: 0
Probe: Horn_3117_00167055(1-18GHz)	Polarity: Vertical
EUT:LED LAMP	Power: AC 120V/60Hz
Note: Mode 1:Transmit at 2480MHz by Zigbee	

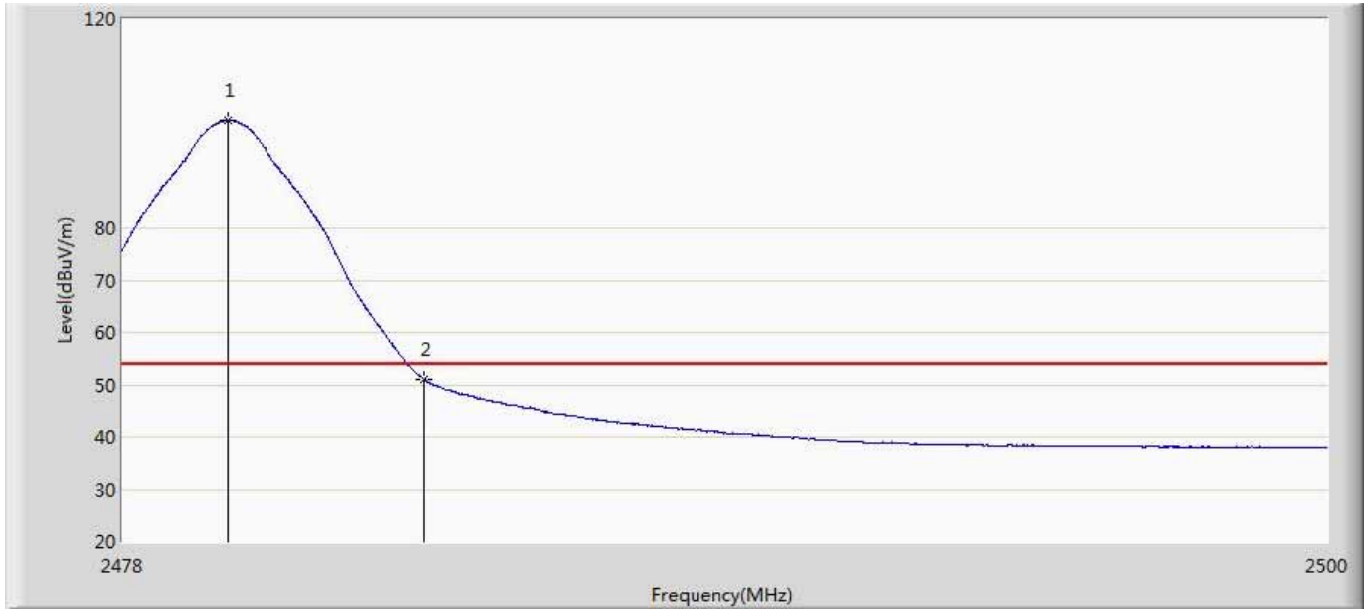

No	Mark	Frequency (MHz)	Measure Level (dBuV/m)	Reading Level (dBuV)	Over Limit (dB)	Limit (dBuV/m)	Factor (dB)	Type
1	*	2479.914	100.553	64.687	46.553	54.000	35.866	AV
2		2483.500	51.058	15.166	-2.942	54.000	35.891	AV

Engineer: YULIU	
Site: AC5	Time: 2019/04/11 - 21:38
Limit: FCC_Part15.209_RE(3m)	Margin: 0
Probe: Horn_3117_00167055(1-18GHz)	Polarity: Horizontal
EUT:LED LAMP	Power: AC 120V/60Hz
Note: Mode 1:Transmit at 2480MHz by Zigbee	

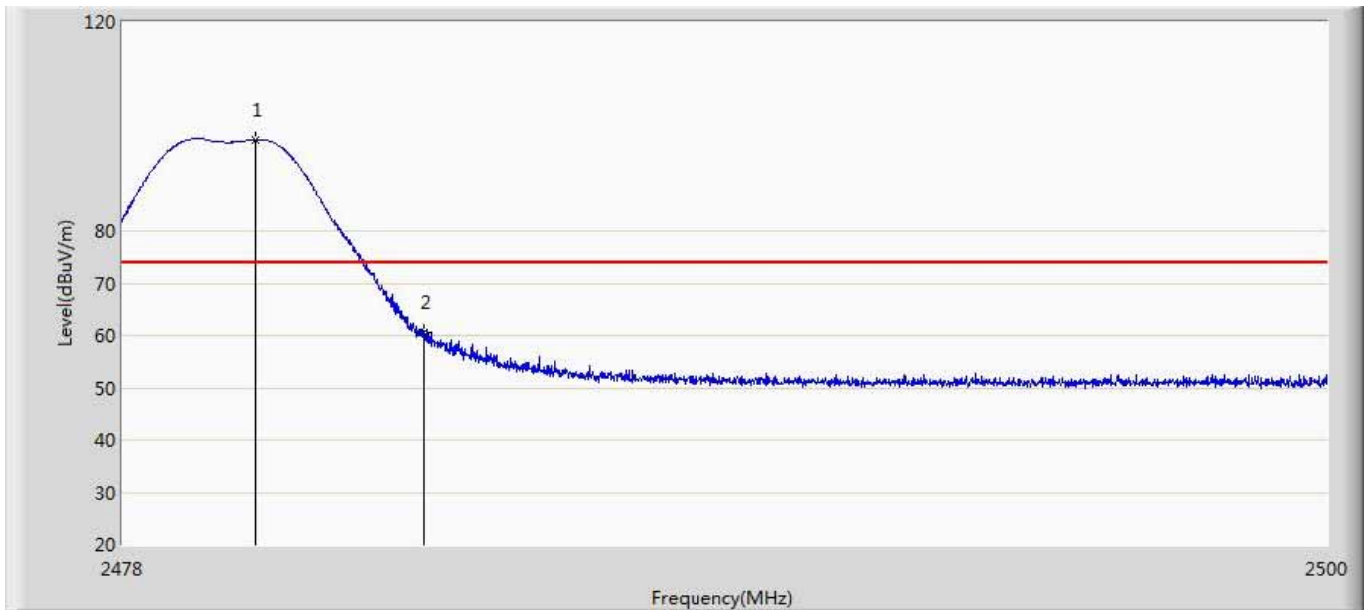

No	Mark	Frequency (MHz)	Measure Level (dBuV/m)	Reading Level (dBuV)	Over Limit (dB)	Limit (dBuV/m)	Factor (dB)	Type
1	*	2480.420	97.521	61.652	23.521	74.000	35.870	PK
2		2483.500	60.581	24.689	-13.419	74.000	35.891	PK

Engineer: YULIU	
Site: AC5	Time: 2019/04/11 - 21:40
Limit: FCC_Part15.209_RE(3m)	Margin: 0
Probe: Horn_3117_00167055(1-18GHz)	Polarity: Horizontal
EUT:LED LAMP	Power: AC 120V/60Hz
Note: Mode 1:Transmit at 2480MHz by Zigbee	

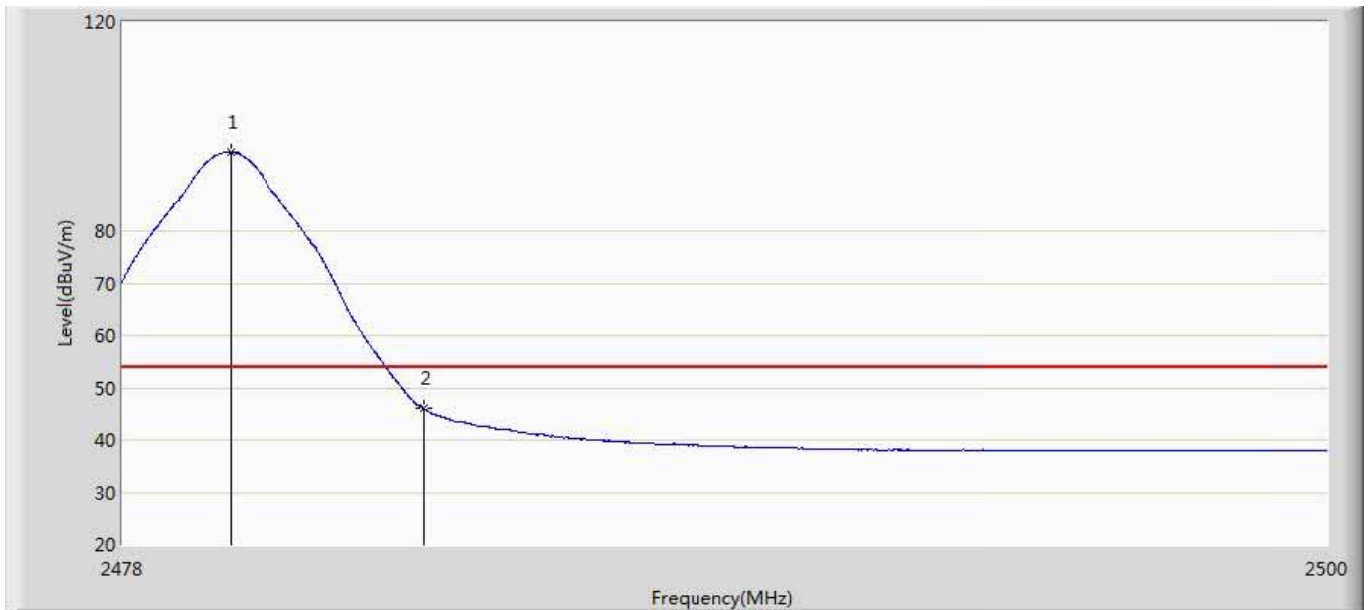

No	Mark	Frequency (MHz)	Measure Level (dBuV/m)	Reading Level (dBuV)	Over Limit (dB)	Limit (dBuV/m)	Factor (dB)	Type
1	*	2479.980	95.078	59.212	41.078	54.000	35.866	AV
2		2483.500	46.025	10.133	-7.975	54.000	35.891	AV

7. Occupied Bandwidth

7.1. Test Equipment

Occupied Bandwidth / TR-8					
Instrument	Manufacturer	Type No.	Serial No.	Cal. Date	Cal. Due Date
Spectrum Analyzer	Agilent	N9010A	MY48030494	2019.02.04	2020.02.03
EXA Spectrum Analyzer	Keysight	N9010A	MY55370495	2018.04.09	2019.04.08
MXA Signal Analyzer	Keysight	N9020A	MY56060147	2018.04.09	2019.04.08
Temperature/Humidity Meter	zhichen	ZC1-2	TR8-TH	2018.04.10	2019.04.09

Note: All equipments are calibrated with traceable calibrations. Each calibration is traceable to the national or international standards.

7.2. Test Setup

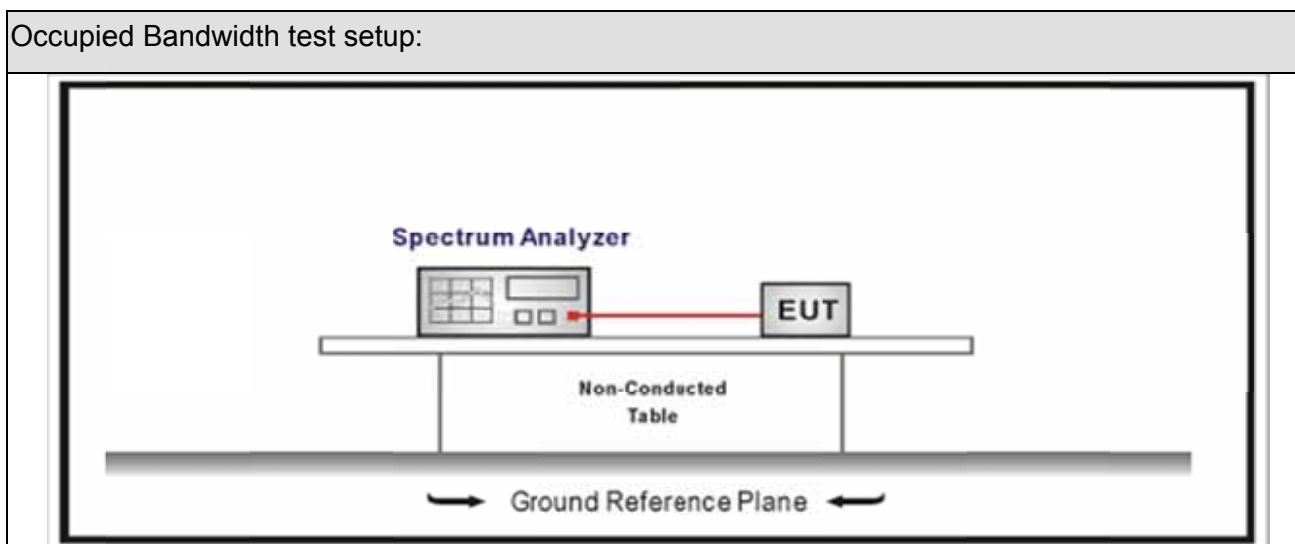



7.3. Limit

Occupied Bandwidth
Systems using digital modulation techniques operate in the 2400-2483.5 MHz. The minimum 6 dB bandwidth shall be at least 500 kHz

7.4. Test Procedure

Test Method			
	Reference Rule	Chapter	Description
<input checked="" type="checkbox"/>	ANSI C63.10	11.8	DTS bandwidth
	<input type="checkbox"/> ANSI C63.10	11.8.1	Option 1
	<input checked="" type="checkbox"/> ANSI C63.10	11.8.2	Option 2

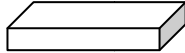
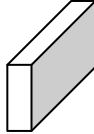
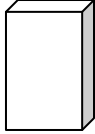
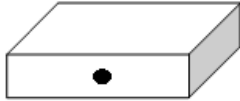
7.5. EUT test definition

Item	Occupied Bandwidth			
Device Category	<input type="checkbox"/>	Fixed point-to-point		
	<input type="checkbox"/>	Emit multiple directional beams, simultaneously or sequentially		
	<input checked="" type="checkbox"/>	Other cases		
Test mode	Mode 1			
Test method	<input type="checkbox"/>	Radiated		
		X Axis	Y Axis	Z Axis
				
		Worst Axis <input type="checkbox"/>	Worst Axis <input type="checkbox"/>	Worst Axis <input type="checkbox"/>
	<input checked="" type="checkbox"/>	Conducted		
	<input checked="" type="checkbox"/>	Chain 0		
				
	<input type="checkbox"/>	Chain 0	Chain 1	
				
	<input type="checkbox"/>	Chain 0	Chain 1	Chain 2
				

7.6. Test Result

Product Name	: LED lamp	Power	: AC 120V/60Hz
Test Mode	: Mode 1	Test Site	: TR-8
Test Date	: 2019.03.15		

Mode	CH.	Test Freq. (MHz)	99% Occupied Bandwidth (kHz)	Limit (kHz)	Result
1	11	2405	2241.4	>500	Pass
1	18	2440	2263.2	>500	Pass
1	39	2480	2259.2	>500	Pass

Mode 1 CH11 (2405MHz)

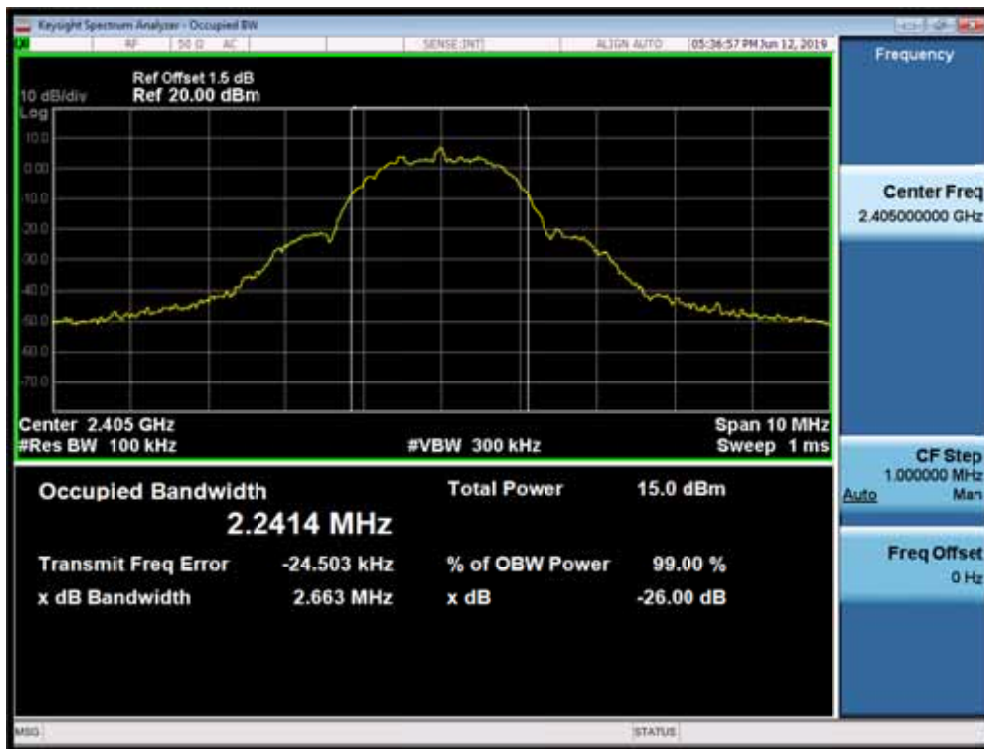

Mode 1 CH18 (2440MHz)

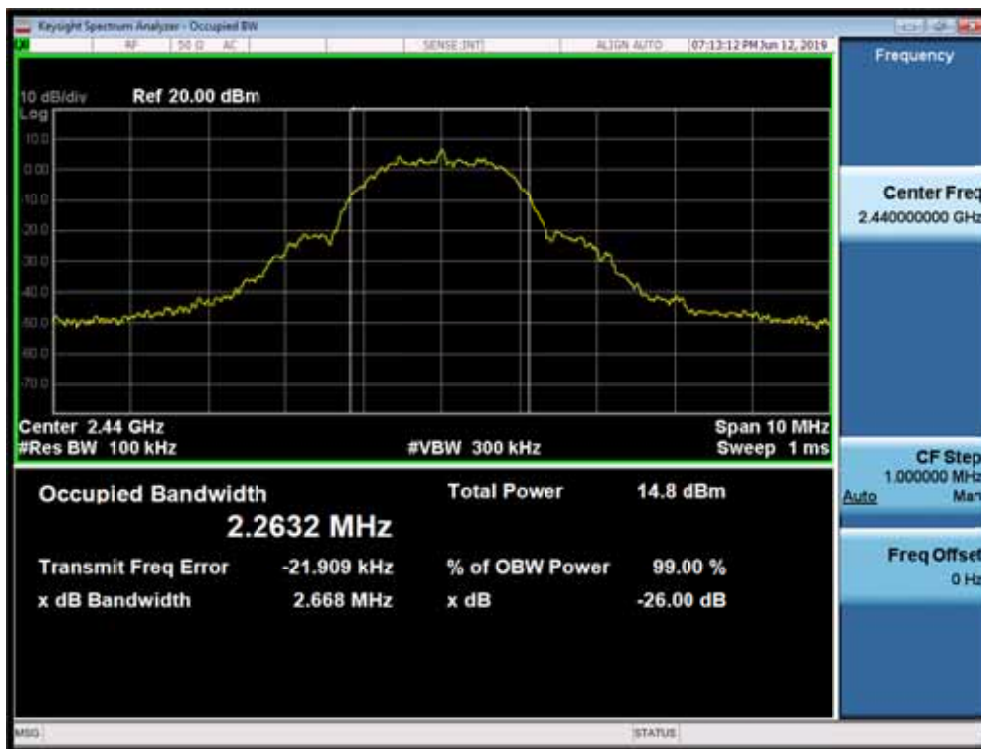

Mode 1 CH39 (2480MHz)

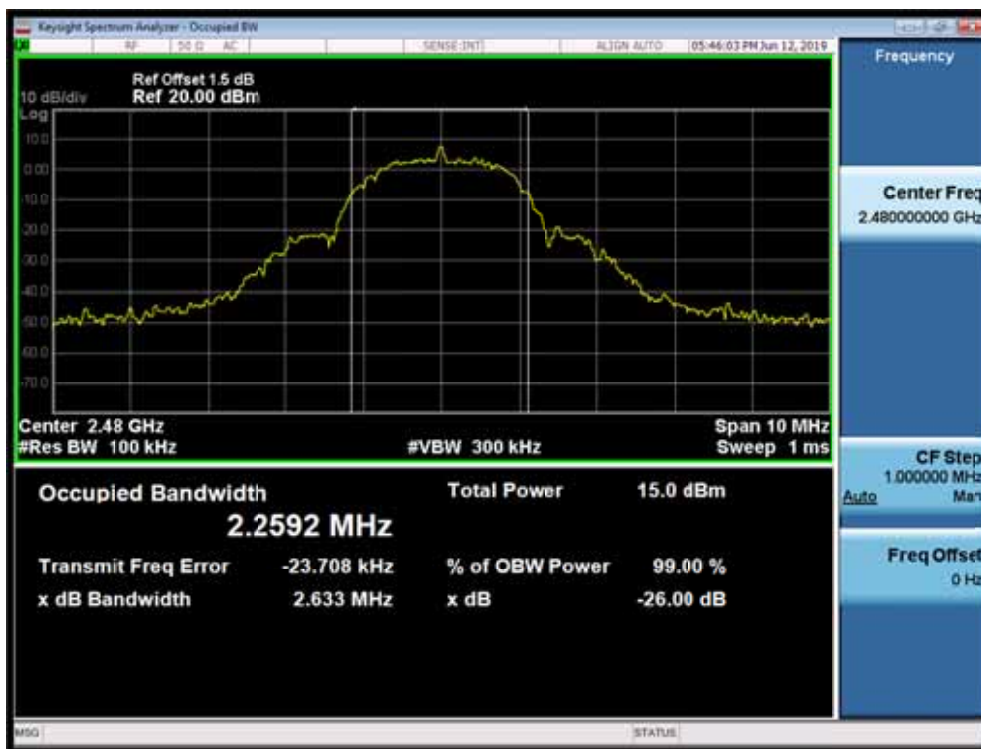

Mode	CH.	Test Freq. (MHz)	6dB Occupied Bandwidth (kHz)	Limit (kHz)	Result
1	11	2405	1675	>500	Pass
1	18	2440	1722	>500	Pass
1	26	2480	1679	>500	Pass

Note : The worst case of Occupied Bandwidth as below:

Mode 1 CH11 (2405MHz)



Mode 1 CH18 (2440MHz)



Mode 1 CH39 (2480MHz)



8. Fundamental emission output power

8.1. Test Equipment

Fundamental emission output power/ TR-8					
Instrument	Manufacturer	Type No.	Serial No.	Cal. Date	Cal. Due Date
Spectrum Analyzer	Agilent	E4446A	MY45300103	2019.01.04	2020.01.03
Spectrum Analyzer	Agilent	N9010A	MY48030494	2019.02.04	2020.01.15
Wideband Peak Power Meter	Anritsu	ML2495A	0905006	2018.10.14	2019.10.13
Power Sensor	Anritsu	MA2411B	0846014	2018.10.14	2019.10.13
Temperature/Humidity Meter	zhicheng	ZC1-2	TR8-TH	2018.04.10	2019.04.09

Note: All equipments are calibrated with traceable calibrations. Each calibration is traceable to the national or international standards.

8.2. Test Setup

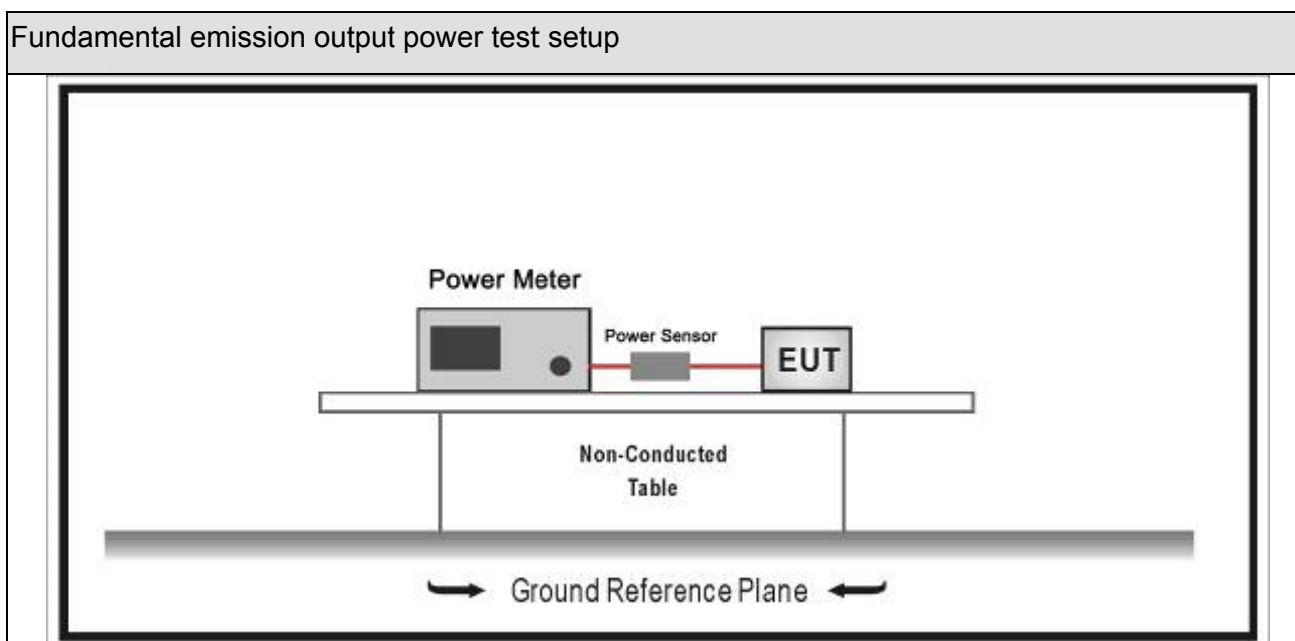



8.3. Limit

Fundamental emission output power Limit		
<input checked="" type="checkbox"/>	$G_{TX} < 6\text{dBi}$	$P_{out} \ 30\text{dBm}$
<input type="checkbox"/>	$G_{TX} > 6\text{dBi}$	
<input type="checkbox"/>	Non-Fix point-point	$P_{out} \ 30-(G_{TX}-6)$
<input type="checkbox"/>	Fix point-point	$P_{out} \ 30-[(G_{TX}-6)]/3$
<input type="checkbox"/>	Point-to-multipoint	$P_{out} \ 30-(G_{TX}-6)$
<input type="checkbox"/>	Overlap Beams	$P_{out} \ 30-[(G_{TX}-6)]/3$
<input type="checkbox"/>	Aggregate power transmitted simultaneously on all beams	$P_{out} \ 30-[(G_{TX}-6)]/3$
<input type="checkbox"/>	single directional beam	$P_{out} \ 30-[(G_{TX}-6)]/3+8\text{dB}$
<p>Note 1 : G_{TX} directional gain of transmitting antennas.</p> <p>Note 2 : P_{out} is maximum peak conducted output power .</p>		

8.4. Test Procedure

Fundamental emission output power Test Method				
	References Rule		Chapter	Description
<input checked="" type="checkbox"/>	ANSI C63.10		11.9	Fundamental emission output power
	<input checked="" type="checkbox"/>	ANSI C63.10	11.9.1	Maximum peak conducted output power
	<input type="checkbox"/>	ANSI C63.10	11.9.1.1	RBW ≥ DTS bandwidth
	<input type="checkbox"/>	ANSI C63.10	11.9.1.2	Integrated band power method
	<input checked="" type="checkbox"/>	ANSI C63.10	11.9.1.3	PKPM1 Peak power meter method
	<input checked="" type="checkbox"/>	ANSI C63.10	11.9.2	Maximum conducted (average) output power
	<input type="checkbox"/>	ANSI C63.10	11.9.2.2	Measurement using a spectrum analyzer (SA)
	<input type="checkbox"/>	ANSI C63.10	11.9.2.2.2	Method AVGSA-1(Duty cycle 98%)
	<input type="checkbox"/>	ANSI C63.10	11.9.2.2.3	Method AVGSA-1A(Duty cycle 98%)
	<input type="checkbox"/>	ANSI C63.10	11.9.2.2.4	Method AVGSA-2(Duty cycle 98%)
	<input type="checkbox"/>	ANSI C63.10	11.9.2.2.5	Method AVGSA-2A(Duty cycle 98%)
	<input type="checkbox"/>	ANSI C63.10	11.9.2.2.4	Method AVGSA-3
	<input type="checkbox"/>	ANSI C63.10	11.9.2.2.5	Method AVGSA-3A
	<input checked="" type="checkbox"/>	ANSI C63.10	11.9.2.3	Measurement using a power meter (PM)
	<input checked="" type="checkbox"/>	ANSI C63.10	11.9.2.3.1	Method AVGPM
	<input type="checkbox"/>	ANSI C63.10	11.9.2.3.2	Method AVGPM-G

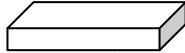
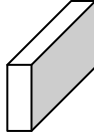
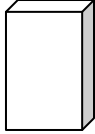
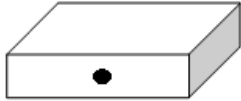
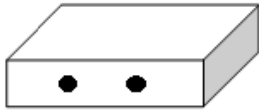
8.5. EUT test definition

Item	Fundamental emission output power			
Device Category	<input type="checkbox"/>	Fixed point-to-point		
	<input type="checkbox"/>	Emit multiple directional beams, simultaneously or sequentially		
	<input checked="" type="checkbox"/>	Other cases		
Test mode	Mode 1			
Test method	<input type="checkbox"/>	Radiated		
		X Axis	Y Axis	Z Axis
				
	Worst Axis <input type="checkbox"/>	Worst Axis <input type="checkbox"/>	Worst Axis <input type="checkbox"/>	
	<input checked="" type="checkbox"/>	Conducted		
	<input checked="" type="checkbox"/>	Chain 0		
				
	<input type="checkbox"/>	Chain 0	Chain 1	
				
	<input type="checkbox"/>	Chain 0	Chain 1	Chain 2
				

8.6. Test Result

Product Name	: LED lamp	Power	: AC 120V/60Hz
Test Mode	: Mode 1	Test Site	: TR-8
Test Date	: 2019.03.16		

Muruta:

Mode	Channel	Test Frequency (MHz)	Measurement Power Output (dBm)	Limit (dBm)	Result
1	11	2405	11.35	30	Pass
1	18	2440	11.78	30	Pass
1	26	2480	11.91	30	Pass

Diodes:

Mode	Channel	Test Frequency (MHz)	Measurement Power Output (dBm)	Limit (dBm)	Result
1	11	2405	11.52	30	Pass
1	18	2440	12.04	30	Pass
1	26	2480	12.13	30	Pass

Kdx:

Mode	Channel	Test Frequency (MHz)	Measurement Power Output (dBm)	Limit (dBm)	Result
1	11	2405	11.39	30	Pass
1	18	2440	11.98	30	Pass
1	26	2480	12.11	30	Pass

9. Power Spectral Density

9.1. Test Equipment

Power Spectral Density / TR-8					
Instrument	Manufacturer	Type No.	Serial No.	Cal. Date	Cal. Due Date
Spectrum Analyzer	Agilent	N9010A	MY48030494	2019.02.04	2020.02.03
EXA Spectrum Analyzer	Keysight	N9010A	MY55370495	2018.04.09	2019.04.08
MXA Signal Analyzer	Keysight	N9020A	MY56060147	2018.04.09	2019.04.08
Temperature/Humidity Meter	zhichen	ZC1-2	TR8-TH	2018.04.10	2019.04.09

Note: All equipments are calibrated with traceable calibrations. Each calibration is traceable to the national or international standards.

9.2. Test Setup

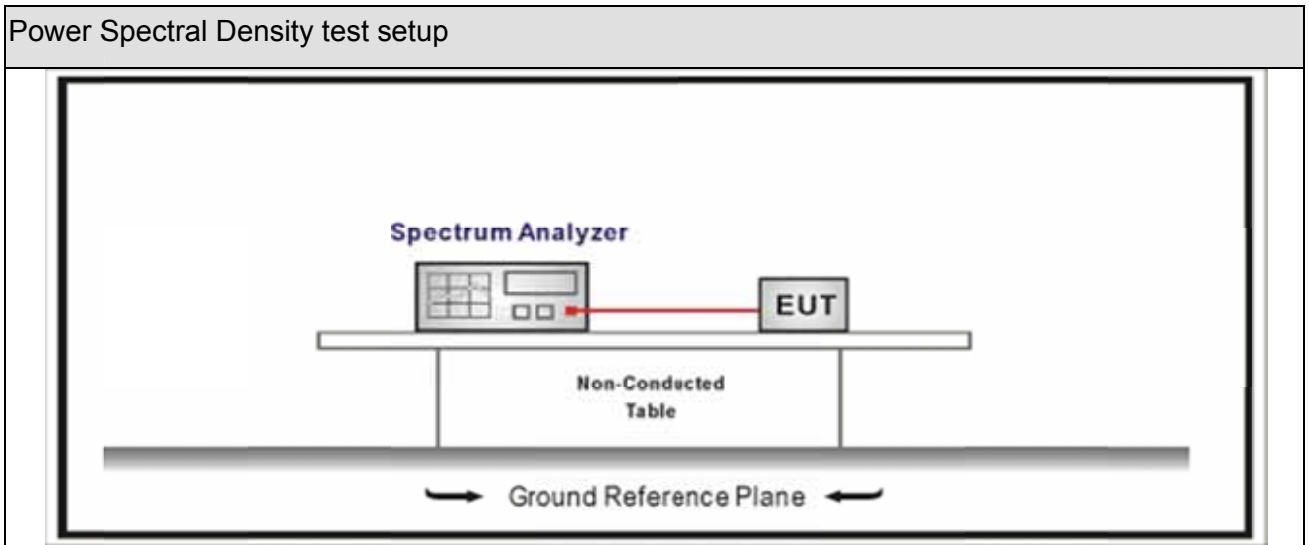





9.3. Limit

Power Spectral Density Limit
Power Spectral Density 8dBm/3kHz

9.4. Test Procedure

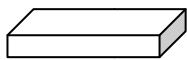
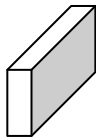
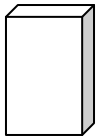
Power Spectral Density Test Method			
	References Rule	Chapter	Description
<input checked="" type="checkbox"/>	ANSI C63.10	11.10	Maximum power spectral density level in the fundamental emission
<input checked="" type="checkbox"/>	ANSI C63.10	11.10.2	Method PKPSD (peak PSD)
<input type="checkbox"/>	ANSI C63.10	11.10.3	Method AVGPSD-1(Duty cycle 98%)
<input type="checkbox"/>	ANSI C63.10	11.10.4	Method AVGPSD-1A(Duty cycle 98%)
<input type="checkbox"/>	ANSI C63.10	11.10.5	Method AVGPSD-2(Duty cycle < 98%)
<input type="checkbox"/>	ANSI C63.10	11.10.6	Method AVGPSD-2A(Duty cycle < 98%)
<input type="checkbox"/>	ANSI C63.10	11.10.7	Method AVGPSD-3
<input type="checkbox"/>	ANSI C63.10	11.10.8	Method AVGPSD-3A

9.5. EUT test definition

Item	Power Spectral Density Test Method			
Device Category	<input type="checkbox"/>	Fixed point-to-point		
	<input type="checkbox"/>	Emit multiple directional beams, simultaneously or sequentially		
	<input checked="" type="checkbox"/>	Other cases		
Test mode	Mode 1			
Test method	<input type="checkbox"/>	Radiated		
		X Axis	Y Axis	Z Axis
				
		Worst Axis <input type="checkbox"/>	Worst Axis <input type="checkbox"/>	Worst Axis <input type="checkbox"/>
	<input checked="" type="checkbox"/>	Conducted		
	<input checked="" type="checkbox"/>	Chain 0		
				
	<input type="checkbox"/>	Chain 0	Chain 1	
				
	<input type="checkbox"/>	Chain 0	Chain 1	Chain 2
				

9.6. Test Result

Product Name	: LED lamp	Power	: AC 120V/60Hz
Test Mode	: Mode 1	Test Site	: TR-8
Test Date	: 2019.03.16		

Mode	Channel	Test Frequency (MHz)	Measurement PSD (dBm/3kHz)	Total PSD (dBm/3kHz)	Limit (dBm/3kHz)	Result
1	11	2405	-5.857	-5.857	8	Pass
1	18	2440	-6.198	-6.198	8	Pass
1	26	2480	-6.952	-6.952	8	Pass

Note : The worst case of Power Spectral Density as below:

Mode 1 CH11(2405MHz)

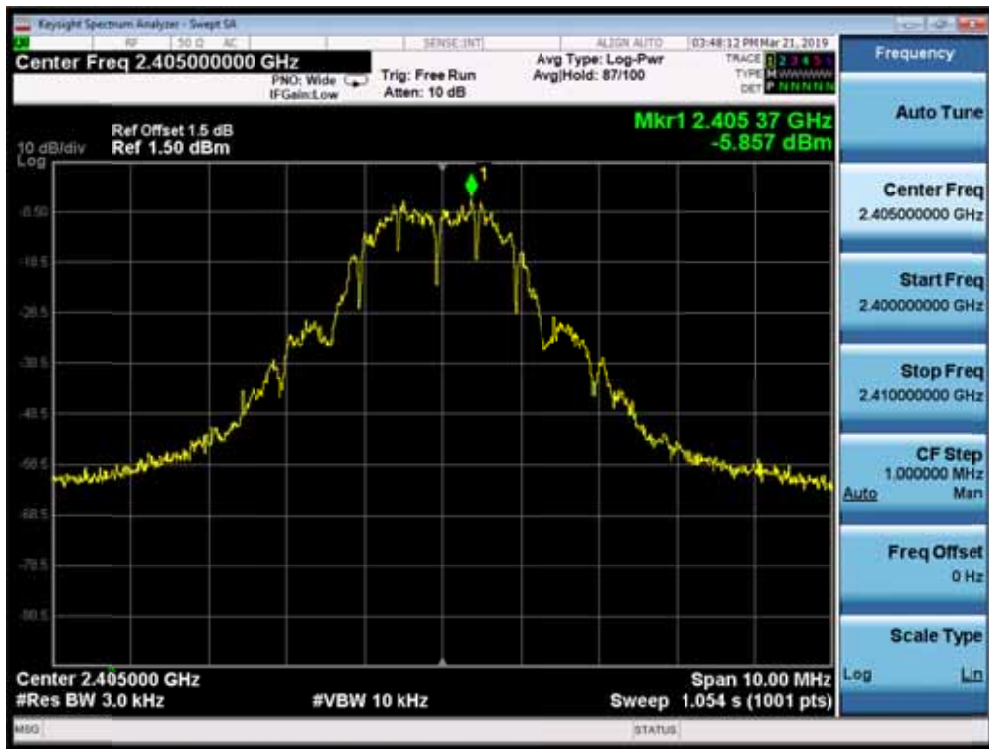

10. Antenna Requirement

10.1. Limit

Antenna Requirement Limit
<p>An intentional radiator shall be designed to ensure that no antenna other than that furnished by the responsible party shall be used with the device. The use of a permanently attached antenna or of an antenna that uses a unique coupling to the intentional radiator shall be considered sufficient to comply with the provisions of this section. The manufacturer may design the unit so that a broken antenna can be replaced by the user, but the use of a standard antenna jack or electrical connector is prohibited. This requirement does not apply to carrier current devices or to devices operated under the provisions of §15.211, §15.213, §15.217, §15.219, or §15.221. Further, this requirement does not apply to intentional radiators that must be professionally installed, such as perimeter protection systems and some field disturbance sensors, or to other intentional radiators which, in accordance with §15.31(d), must be measured at the installation site. However, the installer shall be responsible for ensuring that the proper antenna is employed so that the limits in this part are not exceeded.</p>

10.2. Antenna Connector Construction

Antenna Connector Construction	
<input checked="" type="checkbox"/>	The use of a permanently attached antenna
<input type="checkbox"/>	The antenna use of a unique coupling to the intentional radiator
<input type="checkbox"/>	The use of a nonstandard antenna jack or electrical connector
Please refer to the attached document "Internal Photograph" to show the antenna connector.	

_____ The End _____