

**FCC 47 CFR PART 15 SUBPART E**

**CERTIFICATION TEST REPORT**

*For*

WIRELESS SUBWOOFER

Model No.: SHOCKWAFE PRO 5.1

FCC ID: 2AGB6SWPRO51S

Trademark: Nakamichi

REPORT NO.: ES150731444E

ISSUE DATE: October 13, 2015

*Prepared for*

WOW Technologies (Singapore) Pte Ltd

62 Burn Road #06-01 TSH Centre Singapore, Singapore369976, Singapore.

*Prepared by*

EMTEK (SHENZHEN) CO., LTD

Bldg 69, Majialong Industry Zone, Nanshan District,  
Shenzhen, Guangdong, China

TEL: 86-755-26954280

FAX: 86-755-26954282

# 1 TEST RESULT CERTIFICATION

Applicant:	WOW Technologies (Singapore) Pte Ltd 62 Burn Road #06-01 TSH Centre Singapore, Singapore369976, Singapore.
Manufacturer:	SHENZHEN FENDA TECHNOLOGY CO., LTD. Fenda Hi-Tech Park, Zhoushi Road, Shiyan Town, Baoan District, Shenzhen City, Guangdong, China
Product Description:	WIRELESS SUBWOOFER
Model Number:	SHOCKWAFE PRO 5.1
File Number:	ES150731444E
Date of Test:	July 30, 2015 to October 13, 2015

Measurement Procedure Used:

APPLICABLE STANDARDS	
STANDARD	TEST RESULT
FCC 47 CFR Part 2, Subpart J:2014 FCC 47 CFR Part 15, Subpart E:2014	PASS

The above equipment was tested by EMTEK (SHENZHEN) CO., LTD. The test data, data evaluation, test procedures, and equipment configurations shown in this report were made in accordance with the procedures given in ANSI C63.10 (2013) and the energy emitted by the sample EUT tested as described in this report is in compliance with the requirements of FCC Rules Part 2 and Part 15.407

The test results of this report relate only to the tested sample identified in this report.

Date of Test : July 30, 2015 to October 13, 2015

Prepared by : Jack Li  
Jack Li /Editor

Reviewer : Joe Xia  
Joe Xia /Supervisor

Approve & Authorized Signer : [Signature]  
Lisa Wang/Manager

## TABLE OF CONTENTS

<b>1</b>	<b>TEST RESULT CERTIFICATION .....</b>	<b>2</b>
<b>2</b>	<b>EUT TECHNICAL DESCRIPTION .....</b>	<b>4</b>
<b>3</b>	<b>SUMMARY OF TEST RESULT .....</b>	<b>6</b>
<b>4</b>	<b>TEST METHODOLOGY .....</b>	<b>7</b>
4.1	GENERAL DESCRIPTION OF APPLIED STANDARDS .....	7
4.2	MEASUREMENT EQUIPMENT USED .....	7
4.3	DESCRIPTION OF TEST MODES .....	8
<b>5</b>	<b>FACILITIES AND ACCREDITATIONS .....</b>	<b>9</b>
5.1	FACILITIES.....	9
5.2	LABORATORY ACCREDITATIONS AND LISTINGS .....	9
<b>6</b>	<b>TEST SYSTEM UNCERTAINTY .....</b>	<b>10</b>
<b>7</b>	<b>SETUP OF EQUIPMENT UNDER TEST .....</b>	<b>11</b>
7.1	RADIO FREQUENCY TEST SETUP .....	11
7.2	RADIO FREQUENCY TEST SETUP .....	11
7.3	CONDUCTED EMISSION TEST SETUP .....	13
7.4	BLOCK DIAGRAM CONFIGURATION OF TEST SYSTEM.....	14
7.5	SUPPORT EQUIPMENT.....	14
<b>8</b>	<b>TEST REQUIREMENTS .....</b>	<b>15</b>
8.1	BANDWIDTH MEASUREMENT .....	15
8.2	MAXIMUM CONDUCTED OUTPUT POWER.....	23
8.3	MAXIMUM PEAK POWER DENSITY .....	25
8.4	FREQUENCY STABILITY .....	30
8.5	UNDESIRABLE RADIATED SPURIOUS EMISSION.....	33
8.6	POWER LINE CONDUCTED EMISSIONS.....	54
8.7	ANTENNA APPLICATION .....	57

## 2 EUT TECHNICAL DESCRIPTION

Characteristics	Description
Device Type:	Wifi 5.8G Device
Modulation:	OFDM;
Operating Frequency Range:	<input checked="" type="checkbox"/> 5725-5875 MHz;
Number of Channels:	<input checked="" type="checkbox"/> 3 channels;
Transmit Power Max:	16.25dBm for Antenna A port; 10.14dBm for Antenna B port;
Antenna Type:	PCB Antenna
Antenna Gain:	2dBi for wifi 5.8G
Power supply:	<input checked="" type="checkbox"/> AC supply: 120V AC~ 60Hz 0.6A
	<input type="checkbox"/> Adapter supply:
Temperature Range:	-10°C ~ +55°C

*Note: for more details, please refer to the User's manual of the EUT.*



### 3 SUMMARY OF TEST RESULT

FCC Part Clause	Test Parameter	Verdict	Remark
15.407 (a)(1) 15.407 (a)(3)	99%, 6dB and 26dB Bandwidth	PASS	
15.407 (a)(1) 15.407 (a)(3)	Maximum Conducted Output Power	PASS	
15.407 (a)(1) 15.407 (a)(3)	Peak Power Spectral Density	PASS	
15.407 (b)(1) 15.407 (b)(4) 15.407 (b)(6)	Radiated Spurious Emission	PASS	
15.407 (a)(6)	Peak Excursion	PASS	
15.209	Radiated Spurious Emission	PASS	
15.407(g)	Frequency Stability	PASS	
15.407 (b)(6) 15.207	Power Line Conducted Emission	PASS	
§15.407(a)&§15.203	Antenna Application	PASS	
NOTE1: N/A (Not Applicable) NOTE2: According to FCC OET KDB 789033 D2 General UNII Test Procedures New Rules v01, In addition, the radiated test is also performed to ensure the emissions emanating from the device cabinet also comply with the applicable limits.			

**RELATED SUBMITTAL(S) / GRANT(S):**

This submittal(s) (test report) is intended for FCC ID: 2AGB6SWPRO51S filing to comply with Section 15.247 of the FCC Part 15, Subpart E Rules.

The device is compliance with Subpart B is authorized under a DOC procedure

## 4 TEST METHODOLOGY

### 4.1 GENERAL DESCRIPTION OF APPLIED STANDARDS

According to its specifications, the EUT must comply with the requirements of the following standards:

FCC 47 CFR Part 2, Subpart J

FCC 47 CFR Part 15, Subpart E

FCC KDB 789033 D2 General UNII Test Procedures New Rules v01

FCC KDB 662911 D01 Multiple Transmitter Output v02r01

FCC KDB 662911 D02 MIMO With Cross Polarized Antenna V01

### 4.2 MEASUREMENT EQUIPMENT USED

#### 4.2.1 Conducted Emission Test Equipment

EQUIPMENT TYPE	MFR	MODEL NUMBER	SERIAL NUMBER	LAST CAL.
Test Receiver	Rohde & Schwarz	ESCS30	828985/018	05/16/2015
L.I.S.N.	Schwarzbeck	NNLK8129	8129203	05/16/2015
50Ω Coaxial Switch	Anritsu	MP59B	M20531	N/A
Pulse Limiter	Rohde & Schwarz	ESH3-Z2	100006	05/16/2015
Voltage Probe	Rohde & Schwarz	TK9416	N/A	05/16/2015
I.S.N	Rohde & Schwarz	ENY22	1109.9508.02	05/16/2015

#### 4.2.2 Radiated Emission Test Equipment

EQUIPMENT TYPE	MFR	MODEL NUMBER	SERIAL NUMBER	LAST CAL.
EMI Test Receiver	Rohde & Schwarz	ESU	1302.6005.26	05/16/2015
Pre-Amplifier	HP	8447D	2944A07999	05/16/2015
Bilog Antenna	Schwarzbeck	VULB9163	142	05/16/2015
Loop Antenna	ARA	PLA-1030/B	1029	05/16/2015
Horn Antenna	Schwarzbeck	BBHA 9170	BBHA9170399	05/16/2015
Horn Antenna	Schwarzbeck	BBHA 9120	D143	05/16/2015
Cable	Schwarzbeck	AK9513	ACRX1	05/16/2015
Cable	Rosenberger	N/A	FP2RX2	05/16/2015
Cable	Schwarzbeck	AK9513	CRPX1	05/16/2015
Cable	Schwarzbeck	AK9513	CRRX2	05/16/2015

#### 4.2.3 Radio Frequency Test Equipment

EQUIPMENT TYPE	MFR	MODEL NUMBER	SERIAL NUMBER	LAST CAL.
Spectrum Analyzer	Agilent	E4407B	88156318	05/16/2015
Signal Analyzer	Agilent	N9010A	My53470879	05/16/2015
EMI Test Receiver	Rohde & Schwarz	FSV30	103040	05/16/2015
Power meter	Anritsu	ML2495A	0824006	05/16/2015
Power sensor	Anritsu	MA2411B	0738172	05/16/2015

**Remark:** Each piece of equipment is scheduled for calibration once a year.

### 4.3 DESCRIPTION OF TEST MODES

The EUT has been tested under its typical operating condition.

The EUT configuration for testing is installed on RF field strength measurement to meet the Commissions requirement and operating in a manner which intends to maximize its emission characteristics in a continuous normal application.

The Transmitter was operated in the normal operating mode. The TX frequency was fixed which was for the purpose of the measurements.

Test of channel included the lowest and middle and highest frequency to perform the test, then record on this report.

Those data rates were used for all test.

Pre-defined engineering program for regulatory testing used to control the EUT for staying in continuous transmitting and receiving mode is programmed.

■  Test Frequency and Channel for 5.8G Band (5725-5875MHz):

Lowest Frequency		Middle Frequency		Highest Frequency	
Channel	Frequency (MHz)	Channel	Frequency (MHz)	Channel	Frequency (MHz)
CH1	5736	CH2	5762	CH3	5814



## 5 FACILITIES AND ACCREDITATIONS

### 5.1 FACILITIES

All measurement facilities used to collect the measurement data are located at

Bldg 69, Majialong Industry Zone District, Nanshan District, Shenzhen, China

The sites are constructed in conformance with the requirements of ANSI C63.7, ANSI C63.10 and CISPR Publication 22.

### 5.2 LABORATORY ACCREDITATIONS AND LISTINGS

Site Description

- EMC Lab.
- : Accredited by CNAS, 2013.10.29  
The certificate is valid until 2016.10.28  
The Laboratory has been assessed and proved to be in compliance with CNAS-CL01: 2006(identical to ISO/IEC17025: 2005)  
The Certificate Registration Number is L2291
  - : Accredited by TUV Rheinland Shenzhen, 2010.5.25  
The Laboratory has been assessed according to the requirements ISO/IEC 17025.
  - : Accredited by FCC, April 17, 2014  
The Certificate Registration Number is 406365.
  - : Accredited by FCC, February 28, 2013  
The Certificate Registration Number is 709623.
  - : Accredited by Industry Canada, May 24, 2008  
The Certificate Registration Number is 4480A-2.

## 6 TEST SYSTEM UNCERTAINTY

The following measurement uncertainty levels have been estimated for tests performed on the apparatus:

Parameter	Uncertainty
Radio Frequency	$\pm 1 \times 10^{-5}$
Maximum Peak Output Power Test	$\pm 1.0\text{dB}$
Conducted Emissions Test	$\pm 2.0\text{dB}$
Radiated Emission Test	$\pm 2.0\text{dB}$
Power Density	$\pm 2.0\text{dB}$
Occupied Bandwidth Test	$\pm 1.0\text{dB}$
Band Edge Test	$\pm 3\text{dB}$
All emission, radiated	$\pm 3\text{dB}$
Antenna Port Emission	$\pm 3\text{dB}$
Temperature	$\pm 0.5^\circ\text{C}$
Humidity	$\pm 3\%$

Measurement Uncertainty for a level of Confidence of 95%

## 7 SETUP OF EQUIPMENT UNDER TEST

### 7.1 RADIO FREQUENCY TEST SETUP

The WLAN component's antenna ports(s) of the EUT are connected to the measurement instrument per an appropriate attenuator. The EUT is controlled by PC/software to emit the specified signals for the purpose of measurements.

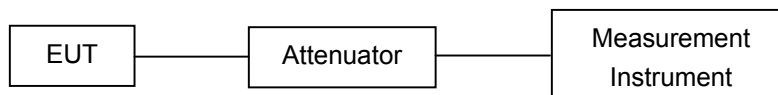

### 7.2 RADIO FREQUENCY TEST SETUP

The test site semi-anechoic chamber has met the requirement of NSA tolerance 4 dB according to the standards: ANSI C63.10. The test distance is 3m. The setup is according to the requirements in Section 13.1.4.1 of ANSI C63.10-2013 and CAN/CSA-CEI/IEC CISPR 22.

Below 30MHz:

The EUT is placed on a turntable 0.8 meters above the ground in the chamber, 3 meter away from the antenna (loop antenna). The Antenna should be positioned with its plane vertical at the specified distance from the EUT and rotated about its vertical axis for maximum response at each azimuth about the EUT. The center of the loop shall be 1 m above the ground. For certain applications, the loop antenna plane may also need to be positioned horizontally at the specified distance from the EUT.

Above 30MHz:

The EUT is placed on a turntable 0.8 meters above the ground in the chamber, 3 meter away from the antenna. The maximal emission value is acquired by adjusting the antenna height, polarisation and turntable azimuth. Normally, the height range of antenna is 1 m to 4 m, the azimuth range of turntable is 0° to 360°, and the receive antenna has two polarizations Vertical (V) and Horizontal (H).

Above 1GHz:

The EUT is placed on a turntable 1.5 meters above the ground in the chamber, 3 meter away from the antenna. The maximal emission value is acquired by adjusting the antenna height, polarisation and turntable azimuth. Normally, the height range of antenna is 1 m to 4 m, the azimuth range of turntable is 0° to 360°, and the receive antenna has two polarizations Vertical (V) and Horizontal (H).

(a) Radiated Emission Test Set-Up, Frequency Below 30MHz

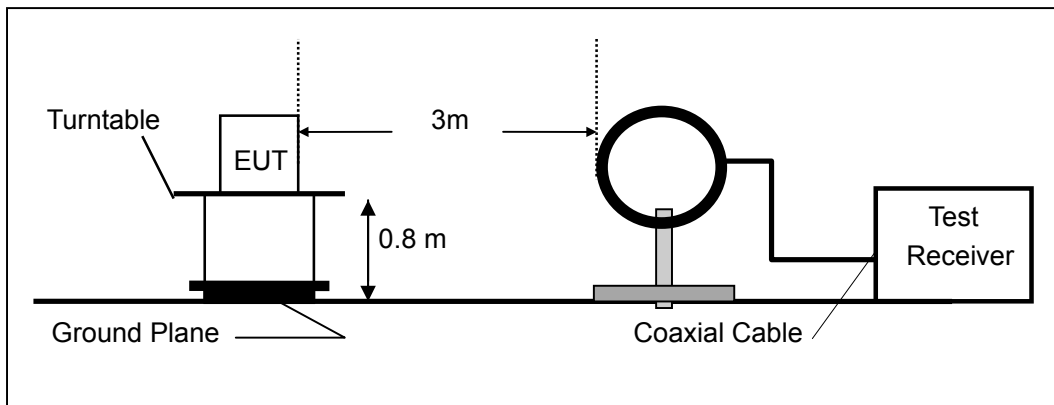

(b) Radiated Emission Test Set-Up, Frequency Below 1000MHz

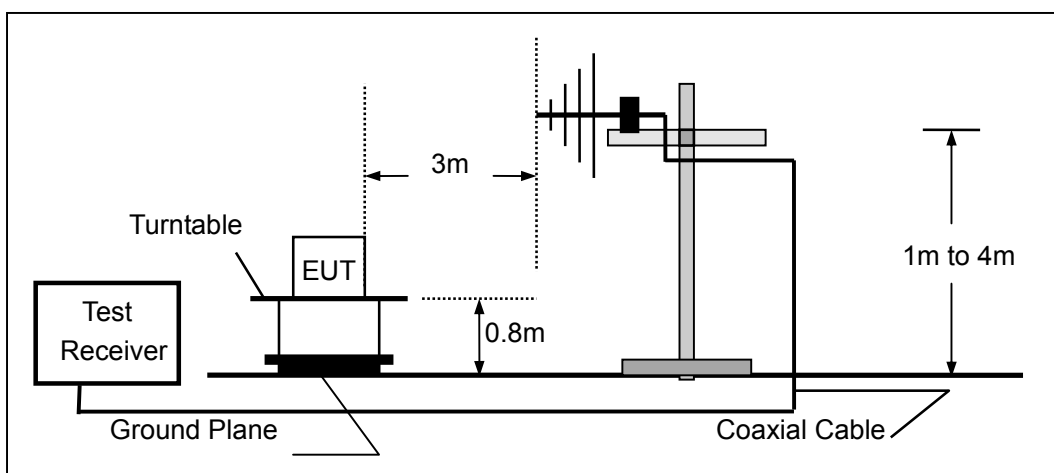

(c) Radiated Emission Test Set-Up, Frequency above 1000MHz

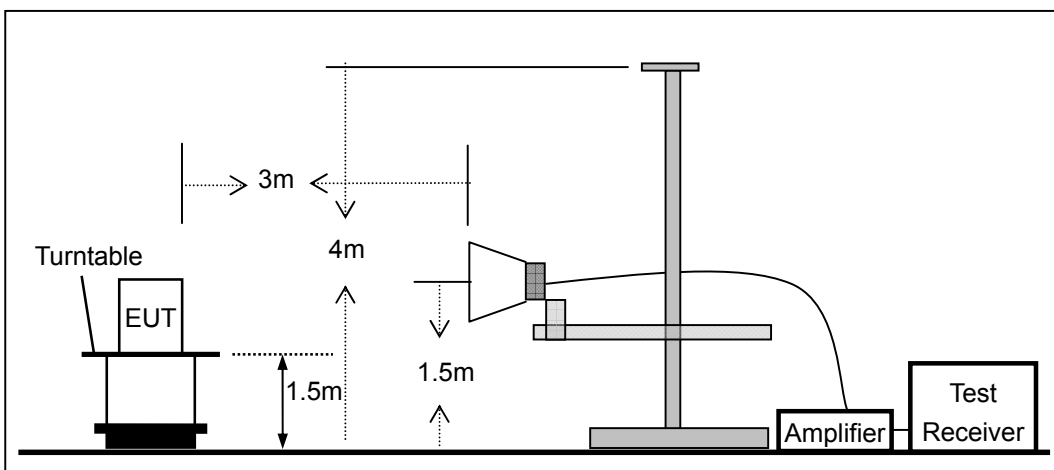

### 7.3 CONDUCTED EMISSION TEST SETUP

The mains cable of the EUT (WIRELESS SUBWOOFERr) must be connected to LISN. The LISN shall be placed 0.8 m from the boundary of EUT and bonded to a ground reference plane for LISN mounted on top of the ground reference plane. This distance is between the closest points of the LISN and the EUT. All other units of the EUT and associated equipment shall be at least 0.8m from the LISN.

Ground connections, where required for safety purposes, shall be connected to the reference ground point of the LISN and, where not otherwise provided or specified by the manufacturer, shall be of same length as the mains cable and run parallel to the mains connection at a separation distance of not more than 0.1 m.

According to the requirements in Section 13.1.4.1 of ANSI C63.10-2013 Conducted emissions from the EUT measured in the frequency range between 0.15 MHz and 30 MHz using CISPR Quasi-Peak and average detector mode.

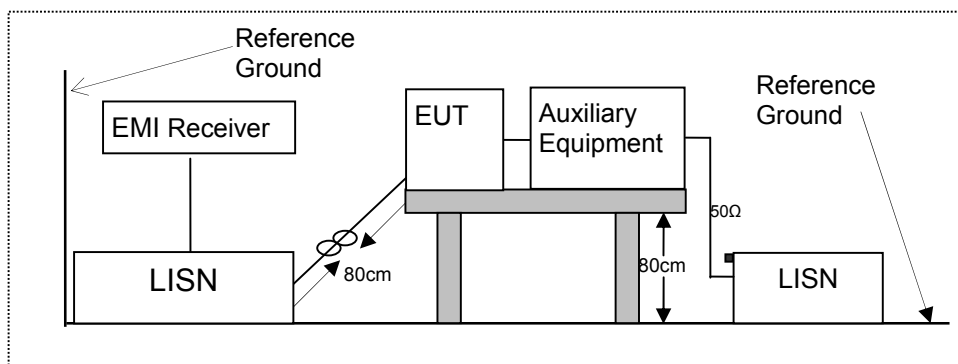

## 7.4 BLOCK DIAGRAM CONFIGURATION OF TEST SYSTEM

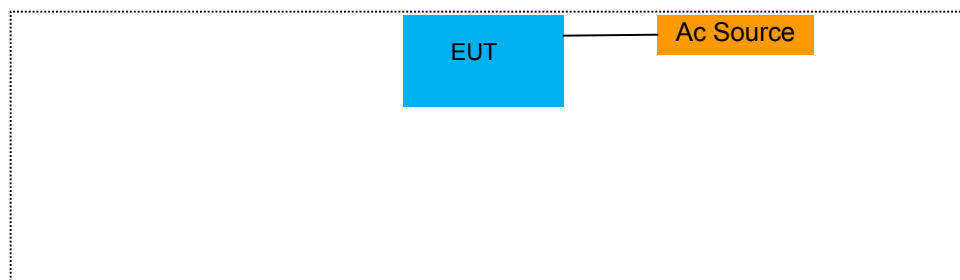

## 7.5 SUPPORT EQUIPMENT

Item	Equipment	Mfr/Brand	Model/Type No.	FCC ID	Series No.	Note
1.	WIRELESS SUBWOOFER	Nakamichi	SHOCKWAFE PRO 5.1	2AGB6SWPRO51S	N/A	EUT

**Notes:**

1. All the equipment/cables were placed in the worst-case configuration to maximize the emission during the test.
2. Grounding was established in accordance with the manufacturer's requirements and conditions for the intended use.

## 8 TEST REQUIREMENTS

### 8.1 BANDWIDTH MEASUREMENT

#### 8.1.1 Applicable Standard

According to FCC Part 15.407(a)(1) for band 5150-5250MHz and KDB 789033 D2  
According to FCC Part 15.407(a)(3) for band 5725-5850MHz and KDB 789033 D2

#### 8.1.2 Conformance Limit

No limit requirement.

The minimum 6 dB emission bandwidth of at least 500 KHz for the band 5.725-5.850 GHz.

#### 8.1.3 Test Configuration

Test according to clause 7.1 radio frequency test setup

#### 8.1.4 Test Procedure

Connect the antenna port(s) to the spectrum analyzer input. Using the spectrum analyzer Channel Bandwidth mode, configure the spectrum analyzer as shown below

■ The following procedure shall be used for measuring (26 dB) power bandwidth:

Center Frequency: test Frequency

Set RBW = approximately 1% of the emission bandwidth.

Set the VBW > RBW.

Detector = Peak.

Trace mode = max hold.

X dB Bandwidth: 26 dB

Measure the maximum width of the emission that is 26 dB down from the maximum of the emission.

Compare this with the RBW setting of the analyzer. Readjust RBW and repeat measurement as needed until the RBW/EBW ratio is approximately 1%.

■ Minimum Emission Bandwidth for the band 5.725-5.85 GHz

Center Frequency: test Frequency

Set RBW = 100 kHz

Set VBW  $\geq 3 \cdot$  RBW

Detector = Peak

Trace mode = max hold

Sweep = auto couple

X dB Bandwidth: 6 dB

Note: The automatic bandwidth measurement capability of a spectrum analyzer or EMI receiver may be employed if it implements the functionality described above.

■ The following procedure shall be used for measuring (99 %) power bandwidth:

Set center frequency to the nominal EUT channel center frequency.

Set span = 1.5 times to 5.0 times the OBW.

Set RBW = 1 % to 5 % of the OBW

Set VBW  $\geq 3 \cdot$  RBW

Video averaging is not permitted. Where practical, a sample detection and single sweep mode shall be used. Otherwise, peak detection and max hold mode (until the trace stabilizes) shall be used.

Use the 99 % power bandwidth function of the instrument (if available).

If the instrument does not have a 99 % power bandwidth function, the trace data points are recovered and directly summed in power units. The recovered amplitude data points, beginning at the lowest frequency, are placed in a running sum until 0.5 % of the total is reached; that frequency is recorded as the lower frequency.

The process is repeated until 99.5 % of the total is reached; that frequency is recorded as the upper frequency. The 99% occupied bandwidth is the difference between these two frequencies.

8.1.5 Test Results

		<input checked="" type="checkbox"/> Frequency Band (5725-5875MHz)	
Temperature:	24 °C	Test Date:	September 17, 2015
Humidity:	53 %	Test By:	King Kong
Antenna:	Ant A		

Operation Mode	Channel Number	Channel Frequency (MHz)	26dB EBW	99% OBW	6dB EBW	Limit (MHz)	Verdict
5.8G Band	CH 1	5736	16.550	13.784	9.853	N/A	PASS
	CH 2	5762	16.510	13.763	9.855	N/A	PASS
	CH 3	5814	16.530	13.778	9.856	N/A	PASS
Note: N/A (Not Applicable)							

		<input checked="" type="checkbox"/> Frequency Band (5725-5875MHz)	
Temperature:	24 °C	Test Date:	September 17, 2015
Humidity:	53 %	Test By:	King Kong
Antenna:	Ant B		

Operation Mode	Channel Number	Channel Frequency (MHz)	26dB EBW	99% OBW	6dB EBW	Limit (MHz)	Verdict
5.8G Band	CH 1	5736	16.510	13.755	9.851	N/A	PASS
	CH 2	5762	16.500	13.761	9.855	N/A	PASS
	CH 3	5814	16.520	13.767	9.855	N/A	PASS
Note: N/A (Not Applicable)							



Ant A

Test Mode	99% Occupied Bandwidth & and 26dB emission bandwidth	
	5.8G Band	
	Channel 1: 5736MHz	Ant A

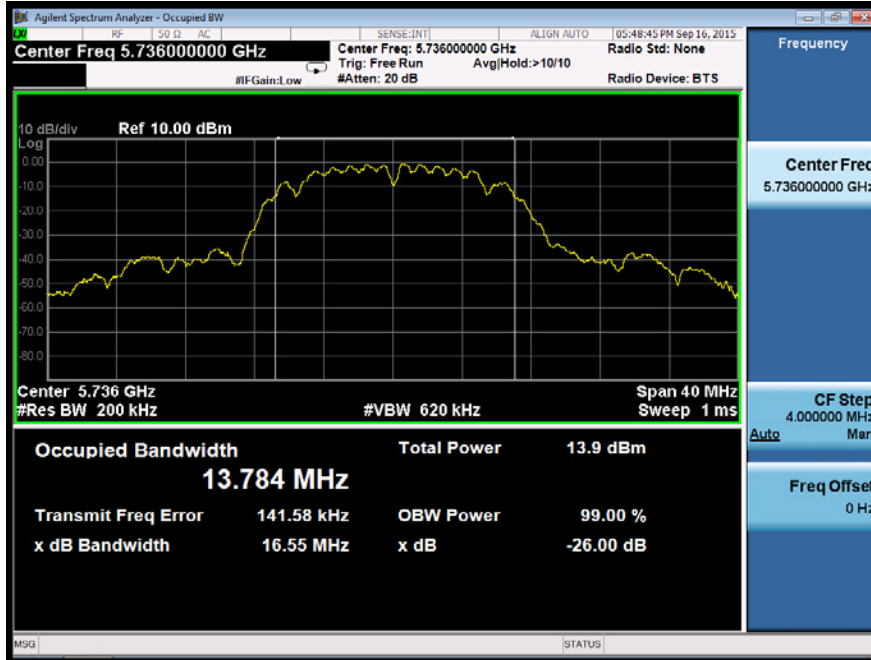

Test Mode	99% Occupied Bandwidth & and 26dB emission bandwidth	
	5.8G Band	
	Channel 2: 5762MHz	Ant A

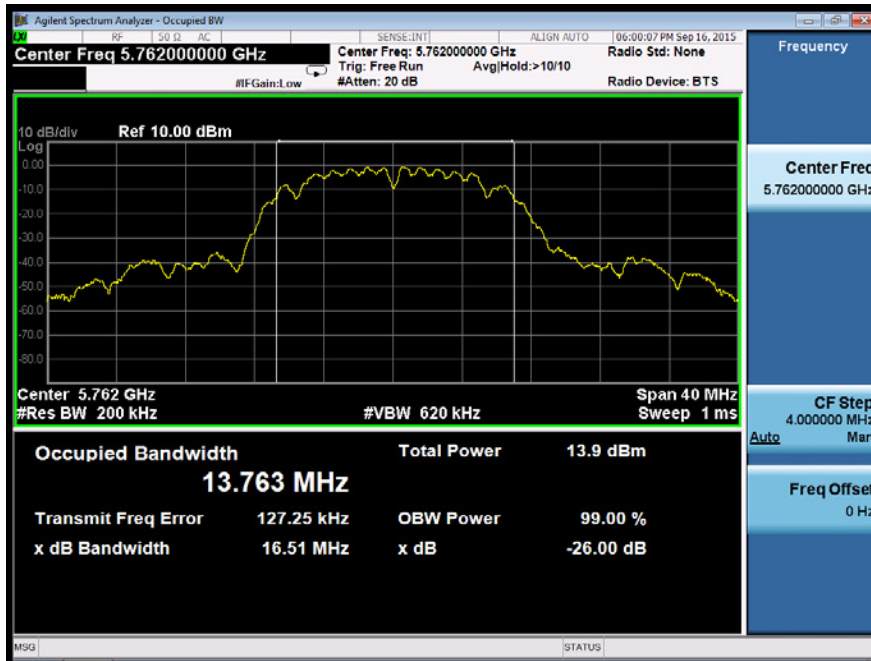

Test Model	99% Occupied Bandwidth & and 26dB emission bandwidth	
	5.8G Band	
	Channel 3: 5814MHz	Ant A

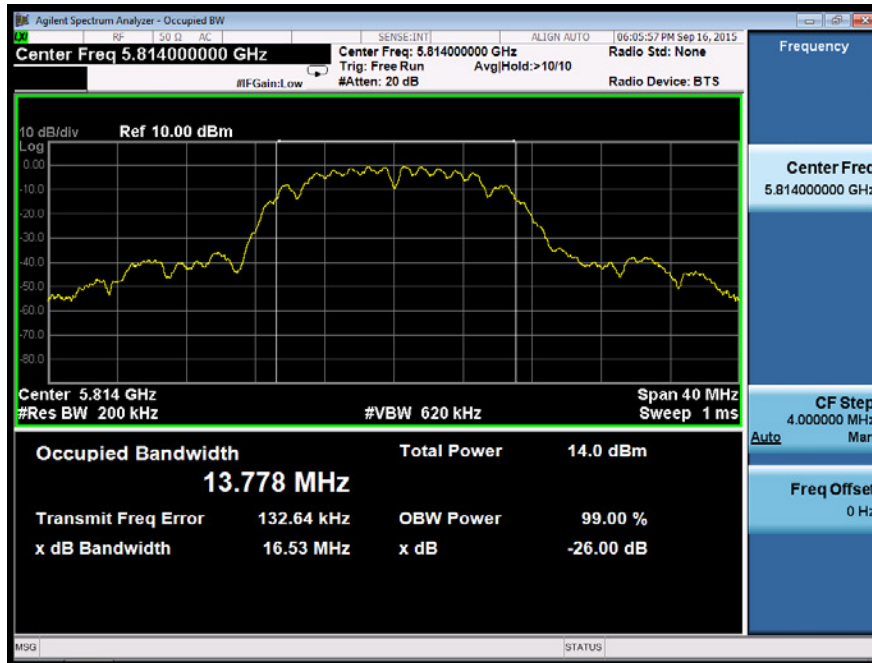

Test Model	6dB Minimum Emission Bandwidth	
	5.8G Band	
	Channel 1: 5736MHz	Ant A



Test Mode	6dB Minimum Emission Bandwidth	
	5.8G Band	
	Channel 2: 5762MHz	Ant A



Test Mode	6dB Minimum Emission Bandwidth	
	5.8G Band	
	Channel 3: 5814MHz	Ant A



Ant B

Test Mode	99% Occupied Bandwidth & and 26dB emission bandwidth	
	5.8G Band	
	Channel 1: 5736MHz	Ant B

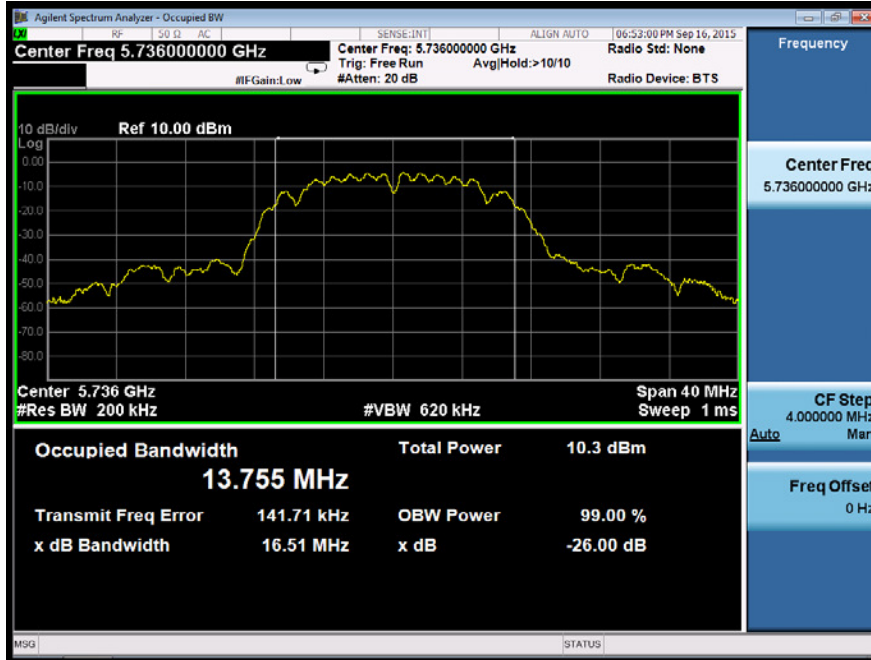

Test Mode	99% Occupied Bandwidth & and 26dB emission bandwidth	
	5.8G Band	
	Channel 2: 5762MHz	Ant B



Test Model	99% Occupied Bandwidth & and 26dB emission bandwidth	
	5.8G Band	
	Channel 3: 5814MHz	Ant B



Test Model	6dB Minimum Emission Bandwidth	
	5.8G Band	
	Channel 1: 5736MHz	Ant B

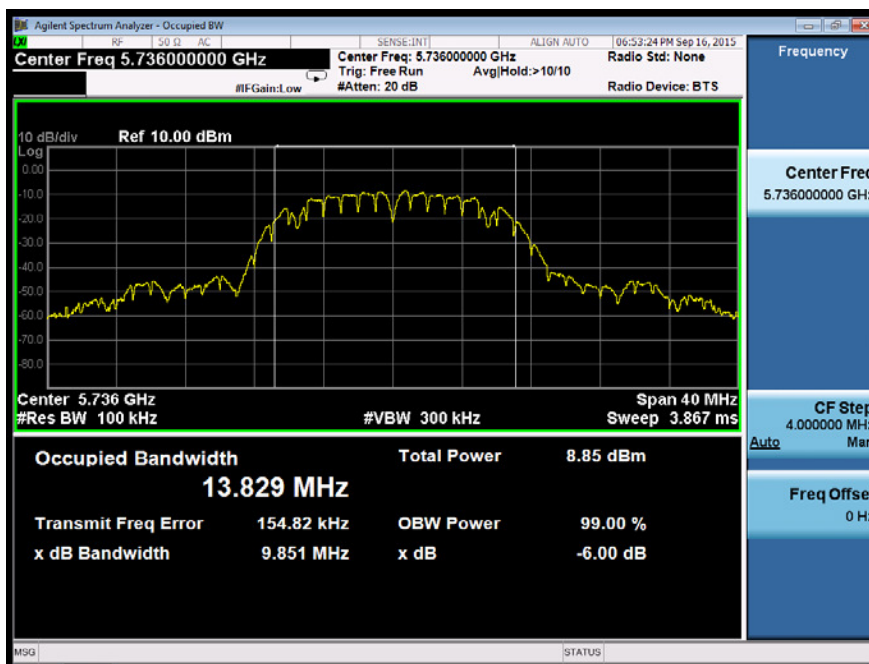

Test Mode	6dB Minimum Emission Bandwidth	
	5.8G Band	
	Channel 2: 5762MHz	Ant B



Test Mode	6dB Minimum Emission Bandwidth	
	5.8G Band	
	Channel 3: 5814MHz	Ant B

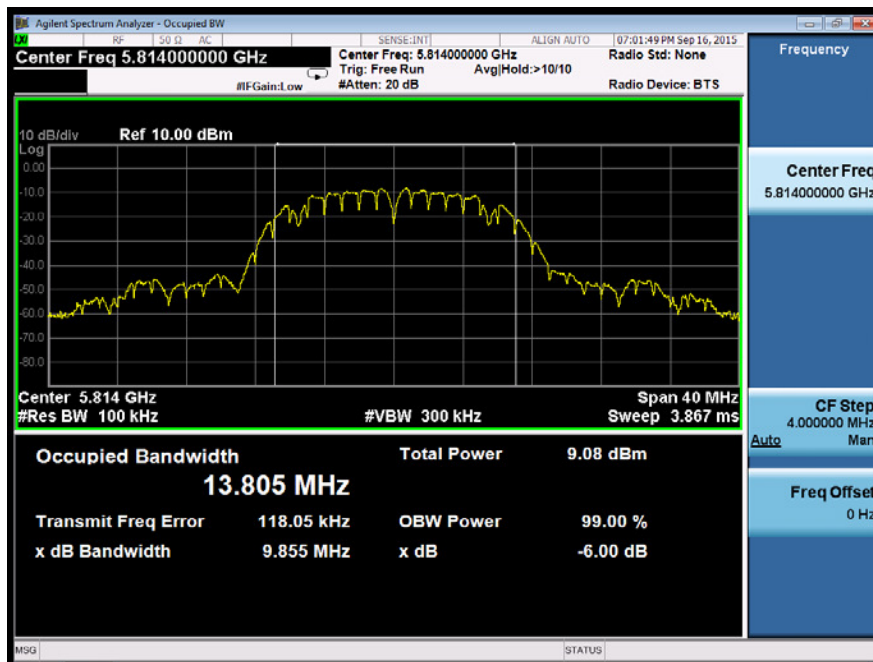



## 8.2 MAXIMUM CONDUCTED OUTPUT POWER

### 8.2.1 Applicable Standard

According to FCC Part 15.407 (a)(1) for band 5150-5250MHz and KDB 789033 D2

According to FCC Part 15.407 (a)(3) for band 5725-5850MHz and KDB 789033 D2

### 8.2.2 Conformance Limit

■ For the band 5.15-5.25 GHz,

(a) (1) (i) For an outdoor access point operating in the band 5.15-5.25 GHz, the maximum conducted output power over the frequency band of operation shall not exceed 1 W provided the maximum antenna gain does not exceed 6 dBi. If transmitting antennas of directional gain greater than 6 dBi are used, both the maximum conducted output power and the maximum power spectral density shall be reduced by the amount in dB that the directional gain of the antenna exceeds 6 dBi. The maximum e.i.r.p. at any elevation angle above 30 degrees as measured from the horizon must not exceed 125 mW (21 dBm).

(a) (1) (ii) For an indoor access point operating in the band 5.15-5.25 GHz, the maximum conducted output power over the frequency band of operation shall not exceed 1 W provided the maximum antenna gain does not exceed 6 dBi. If transmitting antennas of directional gain greater than 6 dBi are used, both the maximum conducted output power and the maximum power spectral density shall be reduced by the amount in dB that the directional gain of the antenna exceeds 6 dBi.

(a) (1) (iii) For fixed point-to-point access points operating in the band 5.15-5.25 GHz, the maximum conducted output power over the frequency band of operation shall not exceed 1 W. Fixed point-to-point U-NII devices may employ antennas with directional gain up to 23 dBi without any corresponding reduction in the maximum conducted output power or maximum power spectral density. For fixed point-to-point transmitters that employ a directional antenna gain greater than 23 dBi, a 1 dB reduction in maximum conducted output power and maximum power spectral density is required for each 1 dB of antenna gain in excess of 23 dBi. Fixed, point-to-point operations exclude the use of point-to-multipoint systems, omnidirectional applications, and multiple collocated transmitters transmitting the same information. The operator of the U-NII device, or if the equipment is professionally installed, the installer, is responsible for ensuring that systems employing high gain directional antennas are used exclusively for fixed, point-to-point operations.

(a) (1) (iv) For mobile and portable client devices in the 5.15-5.25 GHz band, the maximum conducted output power over the frequency band of operation shall not exceed 250 mW provided the maximum antenna gain does not exceed 6 dBi. If transmitting antennas of directional gain greater than 6 dBi are used, both the maximum conducted output power and the maximum power spectral density shall be reduced by the amount in dB that the directional gain of the antenna exceeds 6 dBi.

■ For the band 5.725-5.85 GHz

(a) (3) For the band 5.725-5.85 GHz, the maximum conducted output power over the frequency band of operation shall not exceed 1 W. In addition, the maximum power spectral density shall not exceed 30 dBm in any 500-kHz band. If transmitting antennas of directional gain greater than 6 dBi are used, both the maximum conducted output power and the maximum power spectral density shall be reduced by the amount in dB that the directional gain of the antenna exceeds 6 dBi.

### 8.2.3 Test Configuration

Test according to clause 7.1 radio frequency test setup

### 8.2.4 Test Procedure

The maximum average conducted output power can be measured using Method PM-G (Measurement using a gated RF average power meter):

Measurements may be performed using a wideband gated RF power meter provided that the gate parameters are adjusted such that the power is measured only when the EUT is transmitting at its maximum power control level. Since the measurement is made only during the ON time of the transmitter, no duty cycle correction factor is required.

- a. The Transmitter output (antenna port) was connected to the power meter.
- b. Turn on the EUT and power meter and then record the power value.
- c. Repeat above procedures on all channels needed to be tested.

8.2.5 Test Results

<input checked="" type="checkbox"/> Frequency Band (5725-5875MHz)						
Temperature:	24 °C	Test Date:	September 17, 2015			
Humidity:	53 %	Test By:	King Kong			
Antenna:	Ant A					
Operation Mode	Channel Number	Channel Frequency (MHz)	26dB OBW (MHz)	Measurement Level (dBm)	Limit (dBm)	Verdict
5.8G Band	CH 1	5736	16.550	14.36	30	PASS
	CH 2	5762	16.510	15.06	30	PASS
	CH 3	5814	16.530	16.25	30	PASS
Note: N/A (Not Applicable)						

<input checked="" type="checkbox"/> Frequency Band (5725-5875MHz)						
Temperature:	24 °C	Test Date:	September 17, 2015			
Humidity:	53 %	Test By:	King Kong			
Antenna:	Ant B					
Operation Mode	Channel Number	Channel Frequency (MHz)	26dB OBW (MHz)	Measurement Level (dBm)	Limit (dBm)	Verdict
5.8G Band	CH 1	5736	16.510	9.46	30	PASS
	CH 2	5762	16.500	10.05	30	PASS
	CH 3	5814	16.520	10.14	30	PASS
Note: N/A						



## 8.3 MAXIMUM PEAK POWER DENSITY

### 8.3.1 Applicable Standard

According to FCC Part 15.407 (a)(1) for band 5150-5250MHz and KDB 789033 D2  
According to FCC Part 15.407 (a)(3) for band 5725-5850MHz and KDB 789033 D2

### 8.3.2 Conformance Limit

■ For the band 5.15-5.25 GHz,

(a) (1) (i) For an outdoor access point operating in the band 5.15-5.25 GHz, the maximum power spectral density shall not exceed 17 dBm in any 1 megahertz band. If transmitting antennas of directional gain greater than 6 dBi are used, both the maximum conducted output power and the maximum power spectral density shall be reduced by the amount in dB that the directional gain of the antenna exceeds 6 dBi. The maximum e.i.r.p. at any elevation angle above 30 degrees as measured from the horizon must not exceed 125 mW (21 dBm).

(a) (1) (ii) For an indoor access point operating in the band 5.15-5.25 GHz, the maximum power spectral density shall not exceed 17 dBm in any 1 megahertz band. If transmitting antennas of directional gain greater than 6 dBi are used, both the maximum conducted output power and the maximum power spectral density shall be reduced by the amount in dB that the directional gain of the antenna exceeds 6 dBi.

(a) (1) (iii) For fixed point-to-point access points operating in the band 5.15-5.25 GHz, the maximum power spectral density shall not exceed 17 dBm in any 1 megahertz band. Fixed point-to-point U-NII devices may employ antennas with directional gain up to 23 dBi without any corresponding reduction in the maximum conducted output power or maximum power spectral density. For fixed point-to-point transmitters that employ a directional antenna gain greater than 23 dBi, a 1 dB reduction in maximum conducted output power and maximum power spectral density is required for each 1 dB of antenna gain in excess of 23 dBi. Fixed, point-to-point operations exclude the use of point-to-multipoint systems, omnidirectional applications, and multiple collocated transmitters transmitting the same information. The operator of the U-NII device, or if the equipment is professionally installed, the installer, is responsible for ensuring that systems employing high gain directional antennas are used exclusively for fixed, point-to-point operations.

(a) (1) (iv) For mobile and portable client devices in the 5.15-5.25 GHz band, the maximum power spectral density shall not exceed 11 dBm in any 1 megahertz band. If transmitting antennas of directional gain greater than 6 dBi are used, both the maximum conducted output power and the maximum power spectral density shall be reduced by the amount in dB that the directional gain of the antenna exceeds 6 dBi.

■ For the band 5.725-5.85 GHz

(a) (3) For the band 5.725-5.85 GHz, the maximum power spectral density shall not exceed 30 dBm in any 500-kHz band. If transmitting antennas of directional gain greater than 6 dBi are used, both the maximum conducted output power and the maximum power spectral density shall be reduced by the amount in dB that the directional gain of the antenna exceeds 6 dBi.

### 8.3.3 Test Configuration

Test according to clause 7.1 radio frequency test setup

### 8.3.4 Test Procedure

Methods refer to FCC KDB 789033

1) Create an average power spectrum for the EUT operating mode being tested by following the instructions in section E)2) for measuring maximum conducted output power using a spectrum analyzer or EMI receiver: select the appropriate test method (SA-3, or alternatives to each) and apply it up to, but not including, the step labeled, "Compute power...".

2) Use the peak search function on the instrument to find the peak of the spectrum.

3) The result is the PPSD.

4) The above procedures make use of 500kHz resolution bandwidth to satisfy the 500kHz measurement bandwidth specified in the 15.407(a)(5). That rule section also permits use of resolution bandwidths less than 1 MHz "provided that the measured power is integrated to show the total power over the measurement bandwidth" (i.e., 1 MHz). If measurements are performed using a reduced resolution bandwidth and integrated over 500kHz bandwidth

Note: As a practical matter, it is recommended to use reduced RBW of 500 kHz for the sections 5.c) and 5.d) above, since RBW=500 kHz is available on nearly all spectrum analyzers.

8.3.5 Test Results

<input checked="" type="checkbox"/> Frequency Band (5725-5875MHz)						
Temperature:		24 °C	Test Date:		September 17, 2015	
Humidity:		53 %	Test By:		King Kong	
Operation Mode	Channel Number	Channel Frequency (MHz)	Measurement Level (dBm/500KHz)		Limit (dBm/500KHz)	Verdict
			Ant A	Ant B		
5.8G Band	CH 1	5736	-2.037	-5.170	30	PASS
	CH 2	5762	-1.399	-4.481	30	PASS
	CH 3	5814	-0.824	-4.810	30	PASS
Note: N/A (Not Applicable)						

Test Model	Peak Power Spectral Density	
	5.8G Band	
	Channel 1: 5736MHz	Ant A

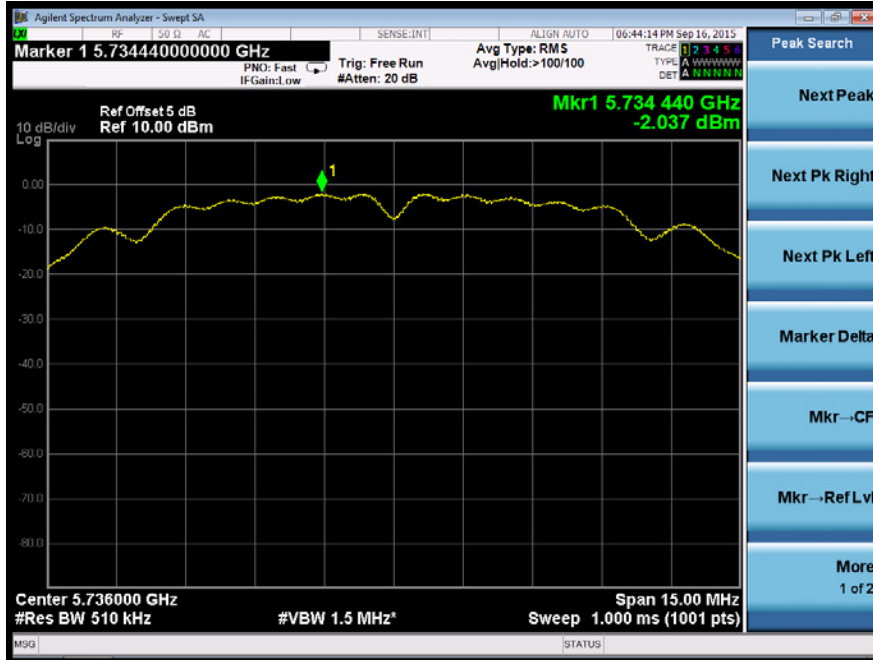

Test Model	Peak Power Spectral Density	
	5.8G Band	
	Channel 2: 5762MHz	Ant A

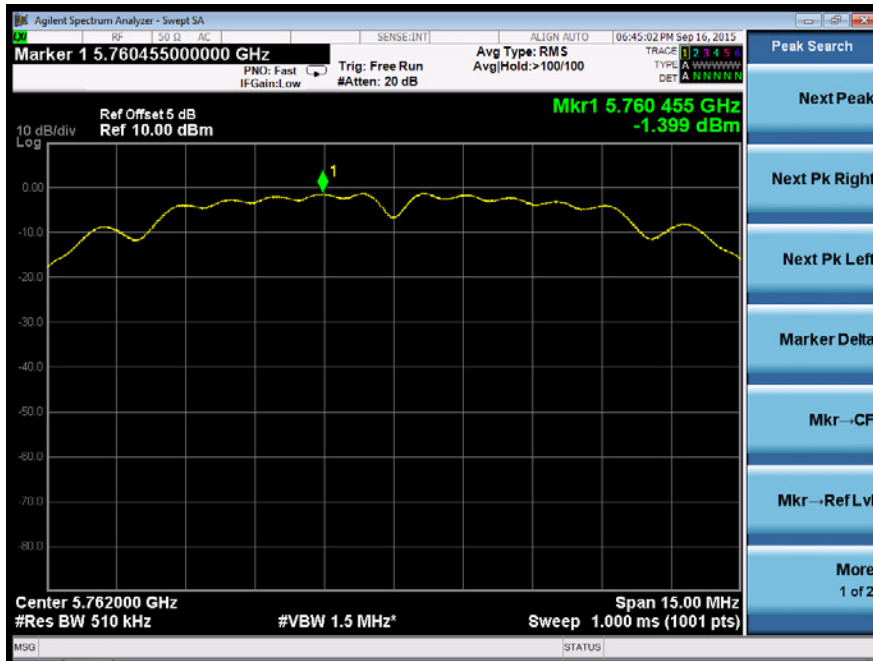

Test Model	Peak Power Spectral Density	
	5.8G Band	
	Channel 3: 5814MHz	Ant A

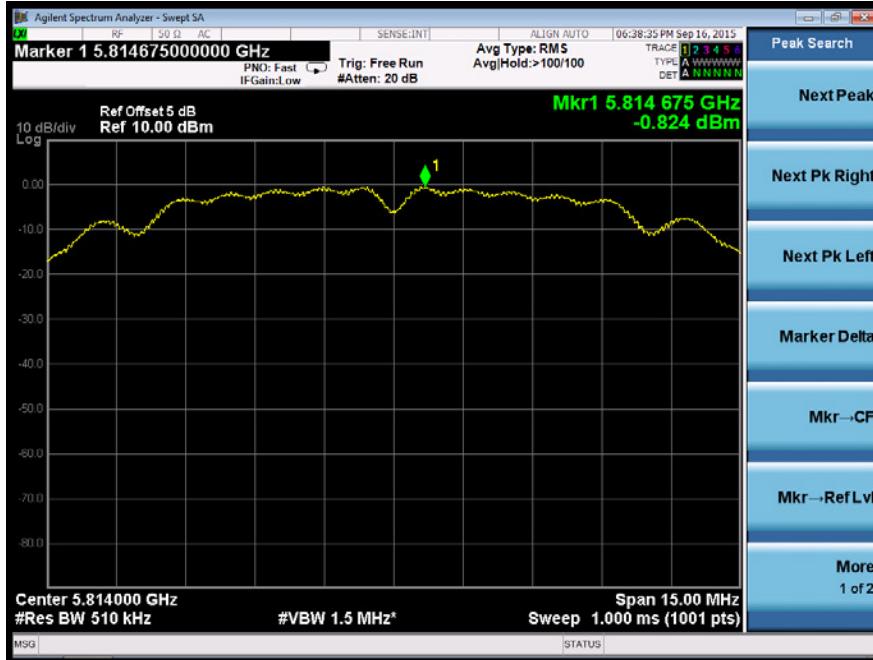

Test Model	Peak Power Spectral Density	
	5.8G Band	
	Channel 1: 5736MHz	Ant B

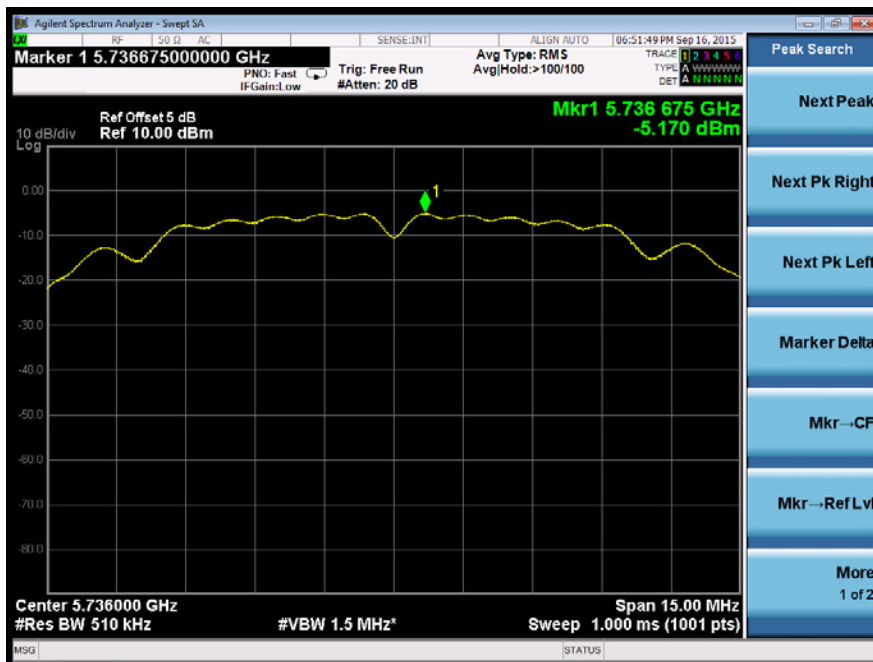

Test Model	Peak Power Spectral Density	
	5.8G Band	
	Channel 2: 5762MHz	Ant B

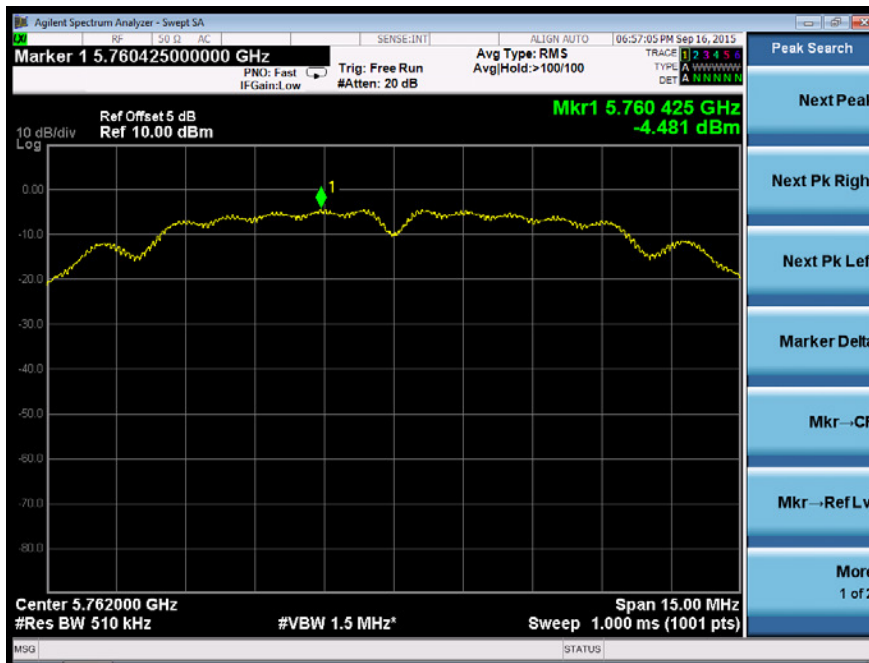

Test Model	Peak Power Spectral Density	
	5.8G Band	
	Channel 3: 5814MHz	Ant B

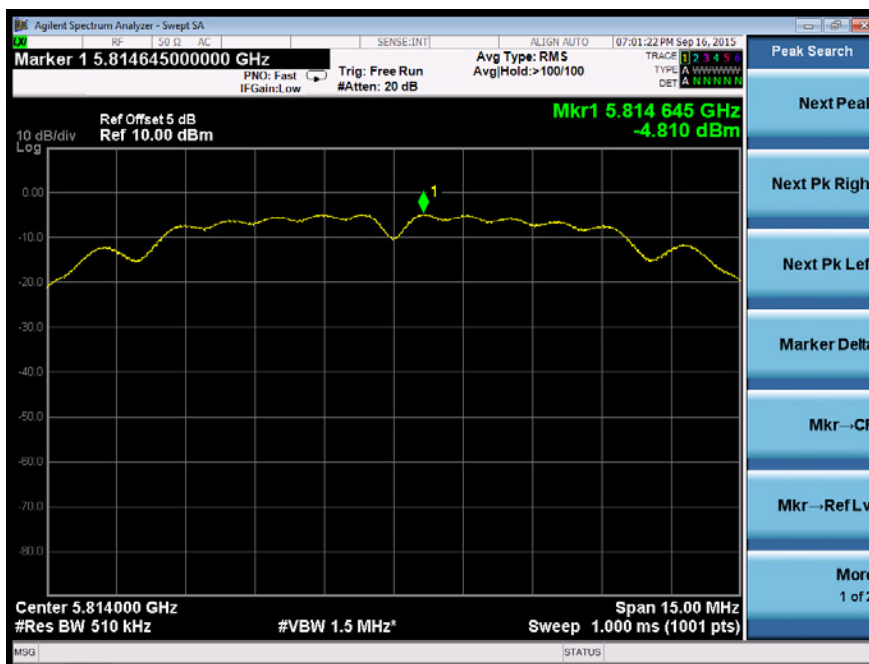

## 8.4 FREQUENCY STABILITY

### 8.4.1 Applicable Standard

According to FCC Part 15.407(g) and KDB 789033 D2

### 8.4.2 Conformance Limit

Manufacturers of U-NII devices are responsible for ensuring frequency stability such that an emission is maintained within the band of operation under all conditions of normal operation as specified in the users manual.

### 8.4.3 Test Configuration

Test according to clause 7.1 radio frequency test setup

### 8.4.4 Test Procedure

The RF output of EUT was connected to the spectrum analyzer by RF cable and attenuator. The path loss was compensated to the results for each measurement.

Set to the maximum power setting and enable the EUT transmit continuously

Set RBW = 10 kHz.

Set the video bandwidth (VBW) =30 kHz.

Set Span= Entire absence of modulation emissions bandwidth

Set Detector = Peak.

Set Trace mode = max hold.

Set Sweep = auto couple.

Allow the trace to stabilize.

The test extreme voltage is to change the primary supply voltage from 85 to 115 percent of the nominal value.

Beginning at each temperature level specified in user manual , the frequency shall be measured within one minute after application of primary power to the transmitter and at intervals of no more than one minute thereafter until ten minutes have elapsed or until sufficient measurements are obtained to indicate clearly that the frequency has stabilized within the applicable tolerance, whichever time period is greater. During each test, the ambient temperature shall not be allowed to rise more than 10° centigrade above the respective beginning ambient temperature level

Measure and record the results in the test report.

### 8.4.5 Test Results

<input checked="" type="checkbox"/> Frequency Band (5725-5875MHz)			
Temperature:	24 °C	Test Date:	September 17, 2015
Humidity:	53 %	Test By:	King Kong
Antenna:	Ant A		

Channel Number	Test Conditions		Test Frequency (MHz)	Max. Deviation (MHz)	Max. Deviation (ppm)	Verdict
	Voltage(V)	Temp(°C)				
CH 1	Vnom	-20	5736.000	0.0000	0.0000	PASS
		-10	5736.000	0.0000	0.0000	PASS
		0	5736.000	0.0000	0.0000	PASS
		10	5736.000	0.0000	0.0000	PASS
		20	5736.000	0.0000	0.0000	PASS
		30	5736.002	0.0020	0.3487	PASS
		40	5736.002	0.0020	0.3487	PASS
		50	5736.001	0.0010	0.1743	PASS
	85% Vnom	20	5736.001	0.0010	0.1743	PASS
	115% Vnom	20	5736.001	0.0010	0.1743	PASS
CH 2	Vnom	-20	5761.999	-0.0010	-0.1736	PASS
		-10	5761.999	-0.0010	-0.1736	PASS
		0	5761.999	-0.0010	-0.1736	PASS
		10	5762.000	0.0000	0.0000	PASS
		20	5761.999	-0.0010	-0.1736	PASS
		30	5761.998	-0.0020	-0.3471	PASS
		40	5761.998	-0.0020	-0.3471	PASS
		50	5762.000	0.0000	0.0000	PASS
	85% Vnom	20	5761.999	-0.0010	-0.1736	PASS
	115% Vnom	20	5761.997	-0.0030	-0.5207	PASS
CH 3	Vnom	-20	5814.000	0.0000	0.0000	PASS
		-10	5814.000	0.0000	0.0000	PASS
		0	5814.000	0.0000	0.0000	PASS
		10	5814.000	0.0000	0.0000	PASS
		20	5814.000	0.0000	0.0000	PASS
		30	5814.000	0.0000	0.0000	PASS
		40	5814.001	0.0010	0.1720	PASS
		50	5814.002	0.0020	0.3440	PASS
	85% Vnom	20	5814.002	0.0020	0.3440	PASS
	115% Vnom	20	5814.002	0.0020	0.3440	PASS
Note: N/A (Not Applicable)						

<input checked="" type="checkbox"/> Frequency Band (5725-5875MHz)			
Temperature:	24 °C	Test Date:	September 17, 2015
Humidity:	53 %	Test By:	King Kong
Antenna:	Ant B		

Channel Number	Test Conditions		Test Frequency (MHz)	Max. Deviation (MHz)	Max. Deviation (ppm)	Verdict
	Voltage(V)	Temp(°C)				
CH 1	Vnom	-20	5736.001	0.0010	0.1743	PASS
		-10	5736.001	0.0010	0.1743	PASS
		0	5736.000	0.0000	0.0000	PASS
		10	5736.000	0.0000	0.0000	PASS
		20	5736.000	0.0000	0.0000	PASS
		30	5736.002	0.0020	0.3487	PASS
		40	5736.003	0.0030	0.5230	PASS
		50	5736.001	0.0010	0.1743	PASS
	85% Vnom	20	5736.001	0.0010	0.1743	PASS
115% Vnom	20	5736.002	0.0020	0.3487	PASS	
CH 2	Vnom	-20	5762.000	0.0000	0.0000	PASS
		-10	5762.000	0.0000	0.0000	PASS
		0	5762.000	0.0000	0.0000	PASS
		10	5762.000	0.0000	0.0000	PASS
		20	5762.000	0.0000	0.0000	PASS
		30	5762.001	0.0010	0.1736	PASS
		40	5762.001	0.0010	0.1736	PASS
		50	5762.002	0.0020	0.3471	PASS
	85% Vnom	20	5762.002	0.0020	0.3471	PASS
115% Vnom	20	5762.002	0.0020	0.3471	PASS	
CH 3	Vnom	-20	5814.000	0.0000	0.0000	PASS
		-10	5814.000	0.0000	0.0000	PASS
		0	5814.000	0.0000	0.0000	PASS
		10	5814.000	0.0000	0.0000	PASS
		20	5814.000	0.0000	0.0000	PASS
		30	5814.002	0.0020	0.3440	PASS
		40	5814.002	0.0020	0.3440	PASS
		50	5814.001	0.0010	0.1720	PASS
	85% Vnom	20	5814.001	0.0010	0.1720	PASS
115% Vnom	20	5814.001	0.0010	0.1720	PASS	
Note: N/A (Not Applicable)						



## 8.5 UNDESIRABLE RADIATED SPURIOUS EMISSION

### 8.5.1 Applicable Standard

According to FCC Part 15.407 (b)(1)(5)(6) for band 5150-5250MHz and KDB 789033 D2

According to FCC Part 15.407 (b)(4)(5)(6)for band 5725-5850MHz and KDB 789033 D2

### 8.5.2 Conformance Limit

For transmitters operating in the 5.15-5.25 GHz band: all emissions outside of the 5.15-5.35 GHz band shall not exceed an EIRP of -27dBm/MHz

For transmitters operating in the 5.725-5.850 GHz band: all emissions within the frequency range from the band edge to 10 MHz above or below the band edge shall not exceed an EIRP of -17 dBm/MHz; for frequencies 10 MHz or greater above or below the band edge, emissions shall not exceed an EIRP of -27 dBm/MHz

The emission measurements shall be performed using a minimum resolution bandwidth of 1 MHz. A lower resolution bandwidth may be employed near the band edge, when necessary, provided the measured energy is integrated to show the total power over 1 MHz.

Unwanted emissions below 1 GHz must comply with the general field strength limits set forth in §15.209

The emissions from an intentional radiator shall not exceed the field strength levels specified in the following table 15.209(a):

Restricted Frequency(MHz)	Field Strength ( $\mu\text{V/m}$ )	Field Strength ( $\text{dB}\mu\text{V/m}$ )	Measurement Distance
0.009-0.490	2400/F(KHz)	20 log ( $\mu\text{V/m}$ )	300
0.490-1.705	2400/F(KHz)	20 log ( $\mu\text{V/m}$ )	30
1.705-30	30	29.5	30
30-88	100	40	3
88-216	150	43.5	3
216-960	200	46	3
Above 960	500	54	3

The provisions of §15.205 apply to intentional radiators operating under this section, 15.205 Restricted bands of operation

MHz	MHz	MHz	GHz
0.090-0.110	16.42-16.423	399.9-410	4.5-5.15
10.495-0.505	16.69475-16.69525	608-614	5.35-5.46
2.1735-2.1905	16.80425-16.80475	960-1240	7.25-7.75
4.125-4.128	25.5-25.67	1300-1427	8.025-8.5
4.17725-4.17775	37.5-38.25	1435-1626.5	9.0-9.2
4.20725-4.20775	73-74.6	1645.5-1646.5	9.3-9.5
6.215-6.218	74.8-75.2	1660-1710	10.6-12.7
6.26775-6.26825	123-138	2200-2300	14.47-14.5
8.291-8.294	149.9-150.05	2310-2390	15.35-16.2
8.362-8.366	156.52475-156.52525	2483.5-2500	17.7-21.4
8.37625-8.38675	156.7-156.9	2690-2900	22.01-23.12
8.41425-8.41475	162.0125-167.17	3260-3267	23.6-24.0
12.29-12.293	167.72-173.2	3332-3339	31.2-31.8
12.51975-12.52025	240-285	3345.8-3358	36.43-36.5
12.57675-12.57725	322-335.4	3600-4400	(2)
13.36-13.41			

- Remark:
1. Emission level in  $\text{dB}\mu\text{V/m}=20 \log (\mu\text{V/m})$
  2. Measurement was performed at an antenna to the closed point of EUT distance of meters.
  3. Only spurious frequency is permitted to locate within the Restricted Bands specified in provision of § 15.205, and the emissions located in restricted bands also comply with 15.209 limit.

### 8.5.3 Test Configuration

Test according to clause 7.2 radio frequency test setup

### 8.5.4 Test Procedure

#### ■ Unwanted Emissions Measurements below 1000 MHz

Compliance shall be demonstrated using CISPR quasi-peak detection; however, peak detection is permitted as an alternative to quasi-peak detection.

The EUT was placed on a turn table which is 0.8m above ground plane.

And also, each emission was to be maximized by changing the polarization of receiving antenna both horizontal and vertical.

Repeat above procedures until all frequency measured was complete.

We use software control the EUT, Let EUT hopping on and transmit with highest power, All the modes have been tested and the worst result was reported.

Use the following spectrum analyzer settings:

Set RBW=120kHz for  $f < 1$  GHz(30MHz to 1GHz), 200Hz for  $f < 150$ KHz(9KHz to 150KHz), 9KHz for  $< 30$ MHz (150KHz to 30KHz).

Set the VBW > RBW.

Detector = Peak.

Trace mode = max hold.

Follow the guidelines in ANSI C63.10-2013 with respect to maximizing the emission by rotating the EUT, measuring the emission while the EUT is situated in three orthogonal planes (if appropriate), adjusting the measurement antenna height and polarization, etc. A pre-amp and a high pass filter are required for this test, in order to provide the measuring system with sufficient sensitivity. Allow the trace to stabilize. The peak reading of the emission, after being corrected by the antenna factor, cable loss, pre-amp gain, etc., is the peak field strength, which must comply with the limit specified in Section 15.35(b). Submit this data.

Repeat above procedures until all frequency measured was complete.

#### ■ Unwanted Maximum peak Emissions Measurements above 1000 MHz

Maximum emission levels are measured by setting the analyzer as follows:

RBW = 1 MHz.

VBW  $\geq$  3 MHz.

Detector = Peak.

Sweep time = auto.

Trace mode = max hold.

Allow sweeps to continue until the trace stabilizes. Note that if the transmission is not continuous, the time required for the trace to stabilize will increase by a factor of approximately  $1/x$ , where  $x$  is the duty cycle. For example, at 50 percent duty cycle, the measurement time will increase by a factor of two relative to measurement time for continuous transmission.

#### ■ Unwanted Average Emissions Measurements above 1000 MHz

Method VB (Averaging using reduced video bandwidth): Alternative method.

RBW = 1 MHz.

Video bandwidth. • If the EUT is configured to transmit with duty cycle  $\geq$  98 percent, set VBW  $\leq$  RBW/100 (i.e., 10 kHz) but not less than 10 Hz.

• If the EUT duty cycle is  $<$  98 percent, set VBW  $\geq$   $1/T$ , where  $T$  is defined in section II.B.1.a).

Video bandwidth mode or display mode • The instrument shall be set to ensure that video filtering is applied in the power domain. Typically, this requires setting the detector mode to RMS and setting the Average-VBW Type to Power (RMS).

• As an alternative, the analyzer may be set to linear detector mode. Ensure that video filtering is applied in linear voltage domain (rather than in a log or dB domain). Some analyzers require linear display mode in order to accomplish this. Others have a setting for Average-VBW Type, which can be set to "Voltage" regardless of the display mode.

Detector = Peak.

Sweep time = auto.

Trace mode = max hold.

Allow max hold to run for at least 50 traces if the transmitted signal is continuous or has at least 98 percent duty cycle. For lower duty cycles, increase the minimum number of traces by a factor of  $1/x$ , where  $x$  is the duty cycle. For example, use at least 200 traces if the duty cycle is 25 percent. (If a specific emission is demonstrated to be continuous—i.e., 100 percent duty cycle—rather than turning on and off with the transmit cycle, at least 50 traces shall be averaged.)

■ Band edge measurements.

Unwanted band-edge emissions may be measured using either of the special band-edge measurement techniques (the marker-delta or integration methods) described below. Note that the marker-delta method is primarily a radiated measurement technique that requires the 99% occupied bandwidth edge to be within 2 MHz of the authorized band edge, whereas the integration method can be used in either a radiated or conducted measurement without any special requirement with regards to the displacement of the unwanted emission(s) relative to the authorized bandwidth.

Marker-Delta Method.

The marker-delta method, as described in ANSI C63.10, can be used to perform measurements of the radiated unwanted emissions level of emissions provided that the 99% occupied bandwidth of the fundamental is within 2 MHz of the authorized band-edge.

#### 8.5.5 Test Results

● Undesirable radiated Spurious Emission below 1GHz (30MHz to 1GHz)

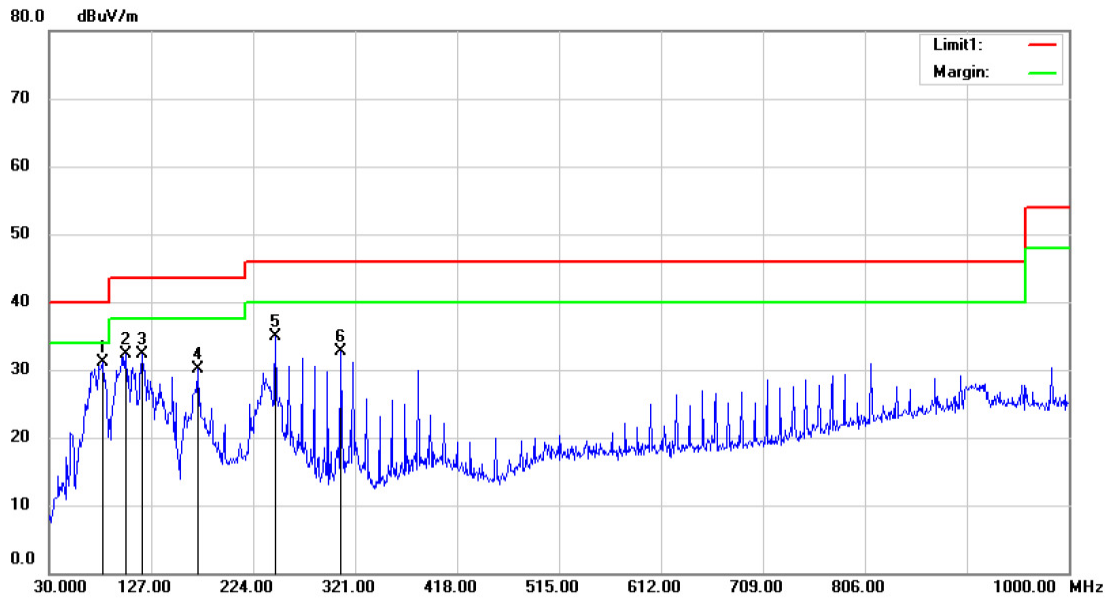

Site 3m Chamber #3 Polarization: *Horizontal* Temperature: 24 C  
 Limit: (RE)FCC PART 15 Class B Power: AC 120V/60Hz Humidity: 53 %  
 Mode:5G Wifi(5736MHz)  
 Note:

No.	Mk.	Freq.	Reading Level	Correct Factor	Measure-ment	Limit	Over	Antenna Height	Table Degree	
		MHz	dBuV	dB	dBuV/m	dBuV/m	dB	cm	degree	Comment
1	*	80.4400	50.35	-19.33	31.02	40.00	-8.98	QP		
2		102.7500	46.34	-14.05	32.29	43.50	-11.21	QP		
3		118.2700	48.19	-15.97	32.22	43.50	-11.28	QP		
4		171.6200	49.41	-19.37	30.04	43.50	-13.46	QP		
5		245.3400	48.47	-13.56	34.91	46.00	-11.09	QP		
6		307.4200	46.40	-13.71	32.69	46.00	-13.31	QP		

\*:Maximum data x:Over limit !:over margin

Operator: CSL

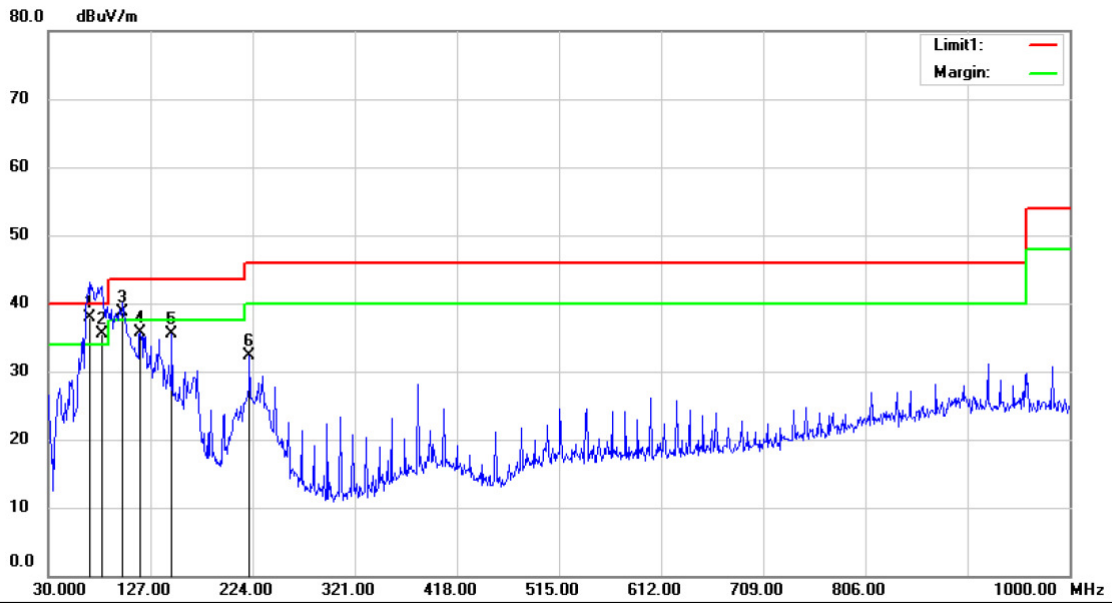

Site 3m Chamber #3 Polarization: **Vertical** Temperature: 24 C  
 Limit: ( RE)FCC PART 15 Class B Power: AC 120V/60Hz Humidity: 53 %  
 Mode:5G Wifi(5736MHz)  
 Note:

No.	Mk.	Freq.	Reading	Correct	Measure-	Limit	Over	Antenna	Table	
		MHz	dBuV	Factor	ment	dBuV/m	dB	Height	Degree	Comment
					dBuV/m			cm	degree	
1	*	68.8000	55.99	-18.15	37.84	40.00	-2.16	QP		
2	!	80.4400	54.75	-19.33	35.42	40.00	-4.58	QP		
3	!	100.8100	52.64	-14.02	38.62	43.50	-4.88	QP		
4		117.3000	51.42	-15.77	35.65	43.50	-7.85	QP		
5		147.3700	53.58	-18.02	35.56	43.50	-7.94	QP		
6		221.0900	48.56	-16.22	32.34	46.00	-13.66	QP		

\*:Maximum data x:Over limit !:over margin

Operator: CSL

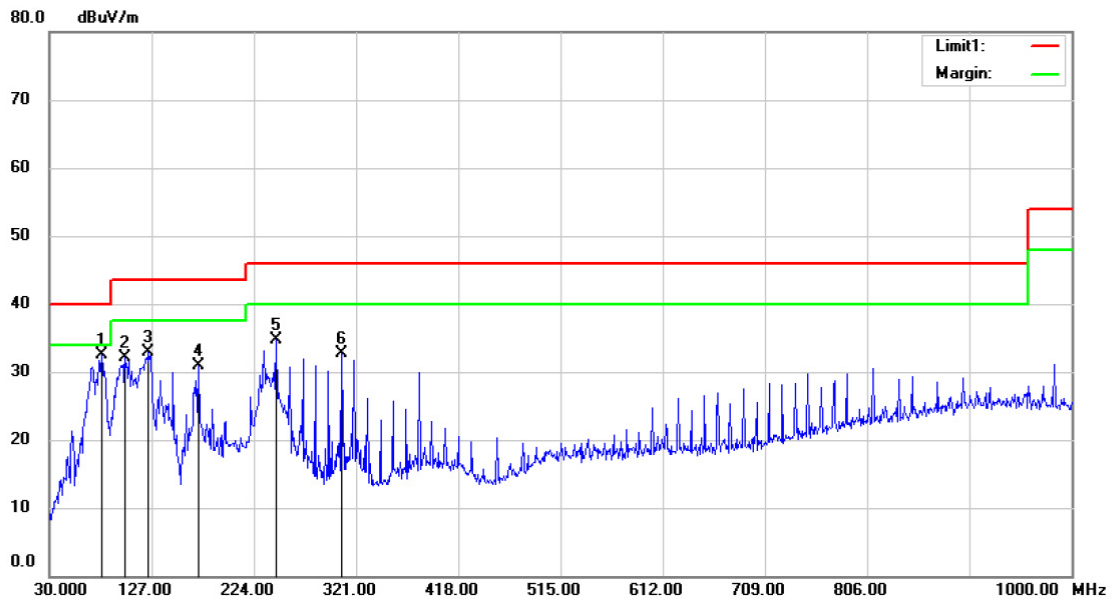

Site 3m Chamber #3 Polarization: *Horizontal* Temperature: 24 C  
 Limit: (RE)FCC PART 15 Class B Power: AC 120V/60Hz Humidity: 53 %  
 Mode:5G Wifi(5762MHz)  
 Note:

No.	Mk.	Freq.	Reading Level	Correct Factor	Measurement	Limit	Over	Antenna Height	Table Degree	
		MHz	dBuV	dB	dBuV/m	dBuV/m	dB	cm	degree	Comment
1	*	79.4700	51.89	-19.42	32.47	40.00	-7.53	QP		
2		101.7800	46.10	-14.05	32.05	43.50	-11.45	QP		
3		124.0900	49.53	-16.72	32.81	43.50	-10.69	QP		
4		171.6200	50.36	-19.37	30.99	43.50	-12.51	QP		
5		245.3400	48.22	-13.56	34.66	46.00	-11.34	QP		
6		307.4200	46.44	-13.71	32.73	46.00	-13.27	QP		

\*:Maximum data x:Over limit !:over margin

Operator: CSL

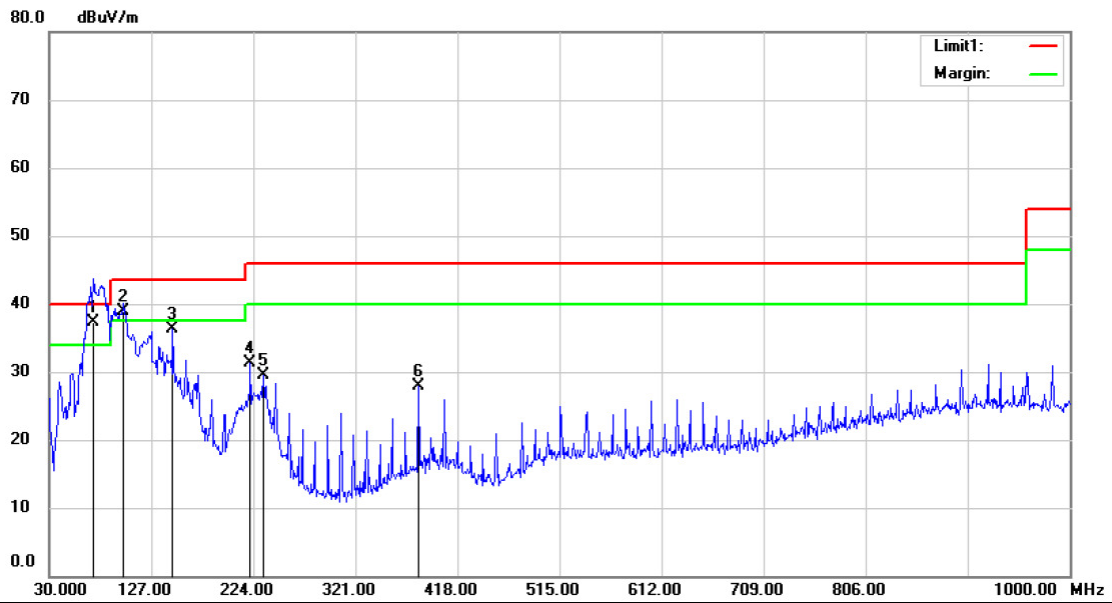

Site 3m Chamber #3 Polarization: *Vertical* Temperature: 24 C  
 Limit: (RE)FCC PART 15 Class B Power: AC 120V/60Hz Humidity: 53 %  
 Mode:5G Wifi(5762MHz)  
 Note:

No.	Mk.	Freq.	Reading Level	Correct Factor	Measurement	Limit	Over	Antenna Height	Table Degree	
		MHz	dBuV	dB	dBuV/m	dBuV/m	dB	cm	degree	Comment
1	*	71.7100	56.09	-18.85	37.24	40.00	-2.76	QP		
2	!	100.8100	52.94	-14.02	38.92	43.50	-4.58	QP		
3		147.3700	54.26	-18.02	36.24	43.50	-7.26	QP		
4		221.0900	47.51	-16.22	31.29	46.00	-14.71	QP		
5		233.7000	44.07	-14.63	29.44	46.00	-16.56	QP		
6		381.1400	37.90	-9.94	27.96	46.00	-18.04	QP		

\*:Maximum data x:Over limit !:over margin

Operator: CSL

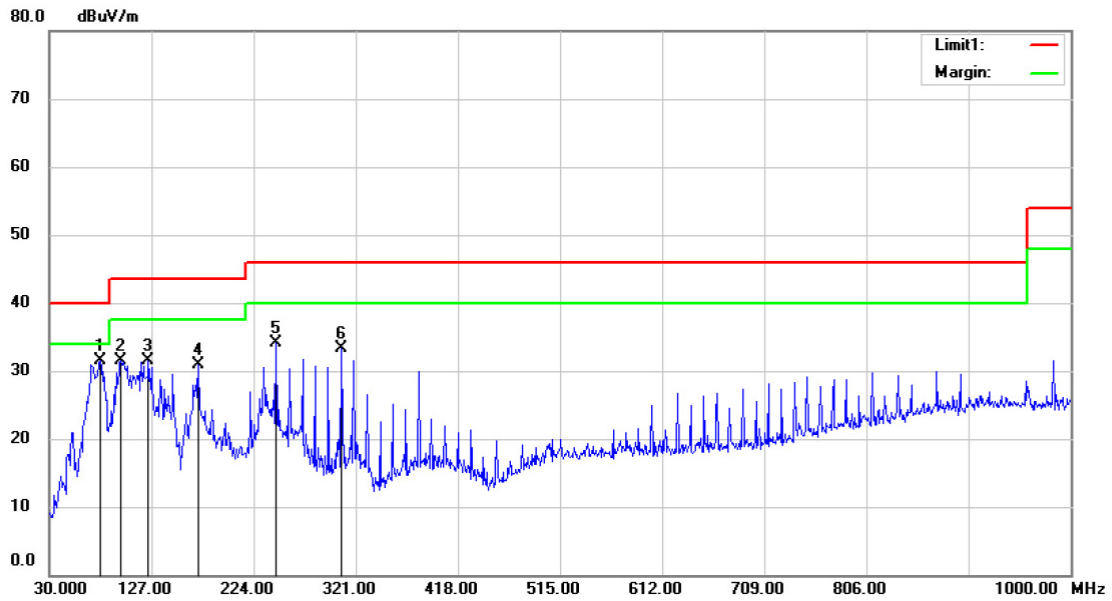

Site 3m Chamber #3 Polarization: *Horizontal* Temperature: 24 C  
 Limit: (RE)FCC PART 15 Class B Power: AC 120V/60Hz Humidity: 53 %  
 Mode:5G Wifi(5814MHz)  
 Note:

No.	Mk.	Freq.	Reading Level	Correct Factor	Measurement	Limit	Over	Antenna Height	Table Degree
		MHz	dBuV	dB	dBuV/m	dBuV/m	dB	cm	degree
1	*	78.5000	51.01	-19.44	31.57	40.00	-8.43	QP	
2		97.9000	45.87	-14.46	31.41	43.50	-12.09	QP	
3		124.0900	48.21	-16.72	31.49	43.50	-12.01	QP	
4		171.6200	50.27	-19.37	30.90	43.50	-12.60	QP	
5		245.3400	47.65	-13.56	34.09	46.00	-11.91	QP	
6		307.4200	46.97	-13.71	33.26	46.00	-12.74	QP	

\*:Maximum data x:Over limit !:over margin

Operator: CSL



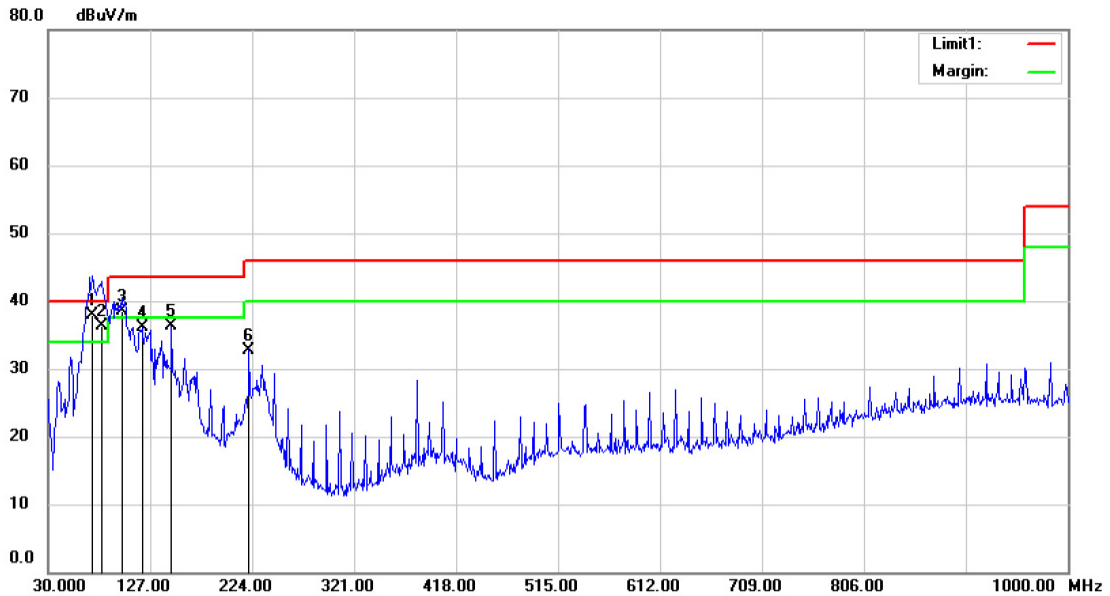

Site: 3m Chamber #3      Polarization: *Vertical*      Temperature: 24 C  
 Limit: (RE)FCC PART 15 Class B      Power: AC 120V/60Hz      Humidity: 53 %  
 Mode: 5G Wifi(5814MHz)  
 Note:

No.	Mk.	Freq. MHz	Reading Level dBuV	Correct Factor dB	Measure- ment dBuV/m	Limit dBuV/m	Over dB	Antenna Height cm	Table Degree degree	Comment
1	*	71.7100	56.75	-18.85	37.90	40.00	-2.10	QP		
2	!	80.4400	55.63	-19.33	36.30	40.00	-3.70	QP		
3	!	99.8400	52.45	-14.03	38.42	43.50	-5.08	QP		
4		119.2400	52.25	-16.18	36.07	43.50	-7.43	QP		
5		147.3700	54.26	-18.02	36.24	43.50	-7.26	QP		
6		221.0900	48.97	-16.22	32.75	46.00	-13.25	QP		

\*:Maximum data    x:Over limit    !:over margin

Operator: CSL

●  Undesirable radiated Spurious Emission Above 1GHz (1GHz to 40GHz)

Temperature:	24°C	Test Date:	September 17, 2015
Humidity:	53 %	Test By:	King Kong
Test mode:	5.8G Band	Frequency:	Channel 1: 5736MHz

Freq. (MHz)	Ant.Pol. H/V	Field Strength (dBuV/m)	E.I.R.P (dBm)	Limit (dBm)	Over(dB)
15314.00	V	50.64	-44.59	-27.00	-17.59
16130.00	V	51.34	-43.89	-27.00	-16.89
17303.00	V	52.13	-43.10	-27.00	-16.10
15059.00	H	50.87	-44.36	-27.00	-17.36
15977.00	H	51.95	-43.28	-27.00	-16.28
17150.00	H	52.02	-43.21	-27.00	-16.21

Temperature:	24°C	Test Date:	September 17, 2015
Humidity:	53 %	Test By:	King Kong
Test mode:	5.8G Band	Frequency:	Channel 2: 5762MHz

Freq. (MHz)	Ant.Pol. H/V	Field Strength (dBuV/m)	E.I.R.P (dBm)	Limit (dBm)	Over(dB)
15892.00	V	50.81	-44.42	-27.00	-17.42
16419.00	V	50.27	-44.96	-27.00	-17.96
17303.00	V	51.36	-43.87	-27.00	-16.87
15348.00	H	50.04	-45.19	-27.00	-18.19
16589.00	H	50.72	-44.51	-27.00	-17.51
17269.00	H	51.49	-43.74	-27.00	-16.74

Temperature:	24°C	Test Date:	September 17, 2015
Humidity:	53 %	Test By:	King Kong
Test mode:	5.8G Band	Frequency:	Channel 3: 5814MHz

Freq. (MHz)	Ant.Pol. H/V	Field Strength (dBuV/m)	E.I.R.P (dBm)	Limit (dBm)	Over(dB)
14957.00	V	50.13	-45.10	-27.00	-18.10
16436.00	V	50.16	-45.07	-27.00	-18.07
17694.00	V	50.63	-44.60	-27.00	-17.60
15382.00	H	50.40	-44.83	-27.00	-17.83
16657.00	H	51.20	-44.03	-27.00	-17.03
17745.00	H	50.96	-44.27	-27.00	-17.27

**Note:** (1) All Readings are Peak Value (VBW=3MHz) and Peak Value (VBW=10Hz).  
 (2) Emission Level= Reading Level+Probe Factor +Cable Loss.  
 (3)EIRP[dBm] = E[dBuV/m] + 20 log(d[meters]) - 104.77  
 d is the measurement distance in 3 meters

Undesirable radiated Spurious Emission in Restricted Band (4500-5100MHz)

Test Model	Frequency Band (5725-5875MHz)					
	Restricted Band (4500-5100MHz)					
	<input checked="" type="checkbox"/> 5.8G Band		<input type="checkbox"/> 802.11n(HT20)		<input type="checkbox"/> 802.11n(HT40)	
	<input checked="" type="checkbox"/> CH1	<input type="checkbox"/> CH2	<input type="checkbox"/> CH3	Ant.Pol	H	

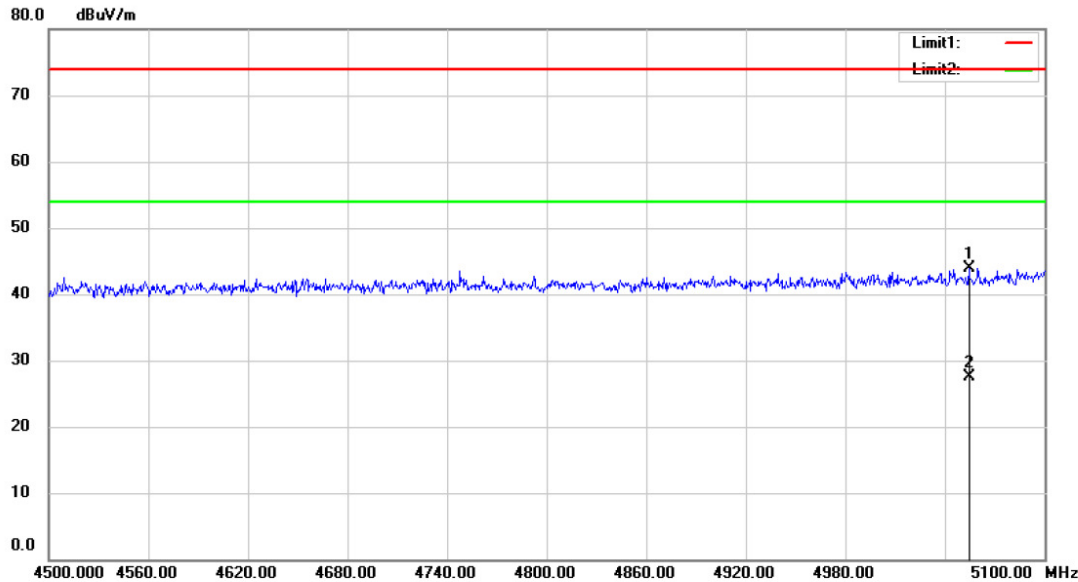

Site 3m Chamber #3      Polarization: *Horizontal*      Temperature: 24 C  
 Limit: (RE)FCC PART 15 Subpart E      Power: AC 120V/60Hz      Humidity: 53 %  
 Mode:TX Low Channel(5736MHz)  
 Note:

No.	Mk.	Freq.	Reading Level	Correct Factor	Measurement	Limit	Over	Antenna Height	Table Degree	
		MHz	dBuV	dB	dBuV/m	dBuV/m	dB	cm	degree	Comment
1		5054.400	58.21	-14.35	43.86	74.00	-30.14			peak
2	*	5054.400	41.78	-14.35	27.43	54.00	-26.57			AVG

\*:Maximum data    x:Over limit    !:over margin

Operator: KK

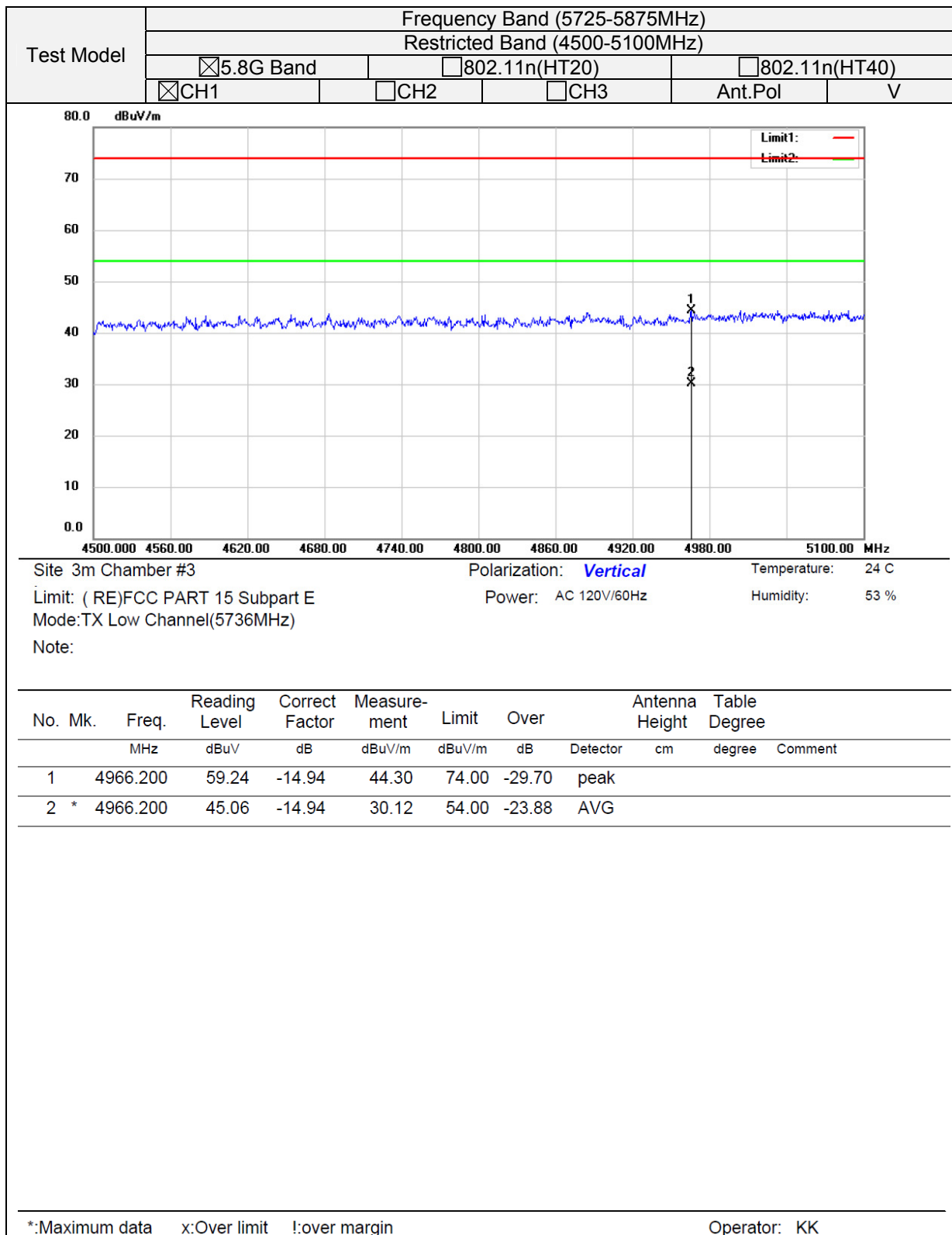

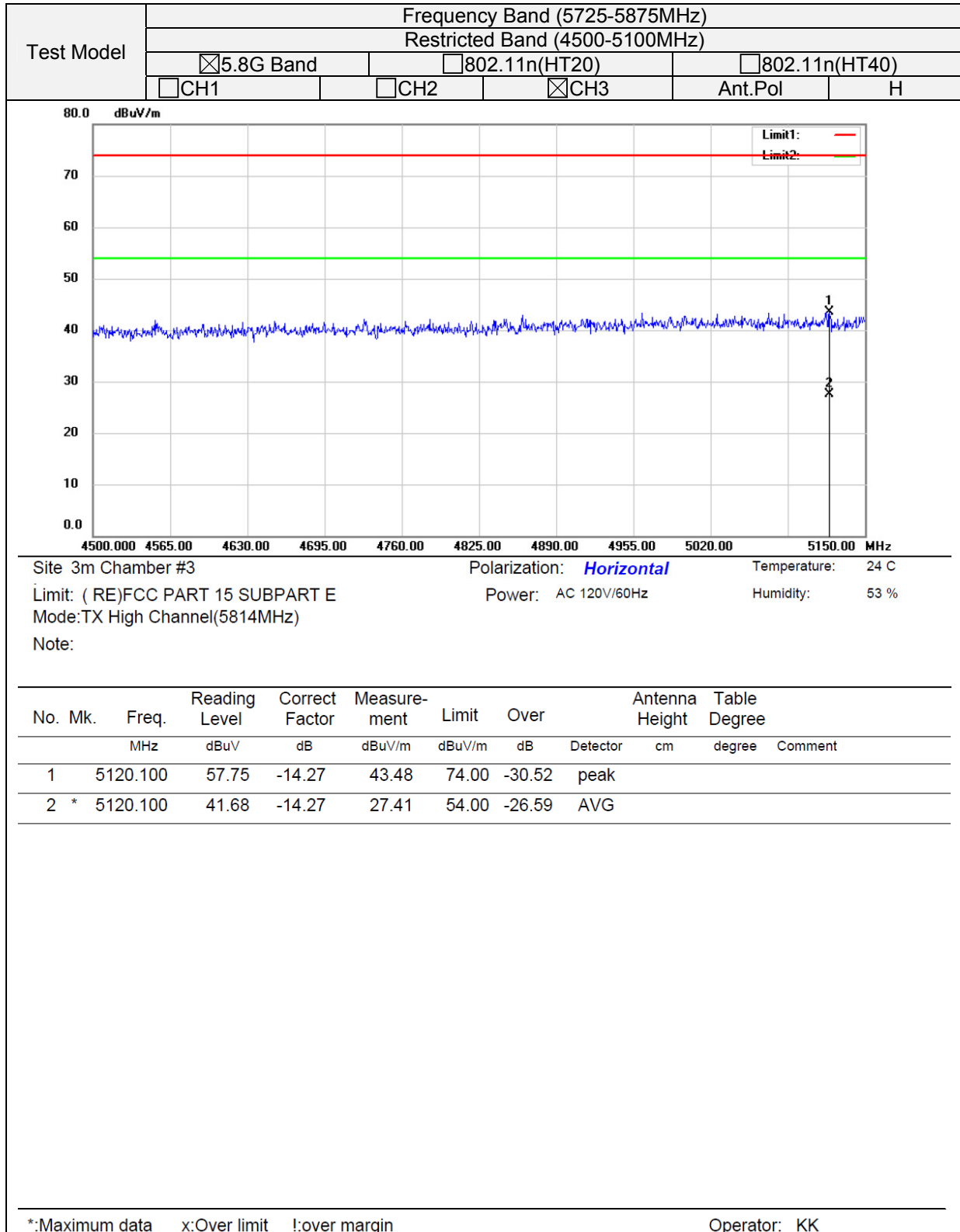

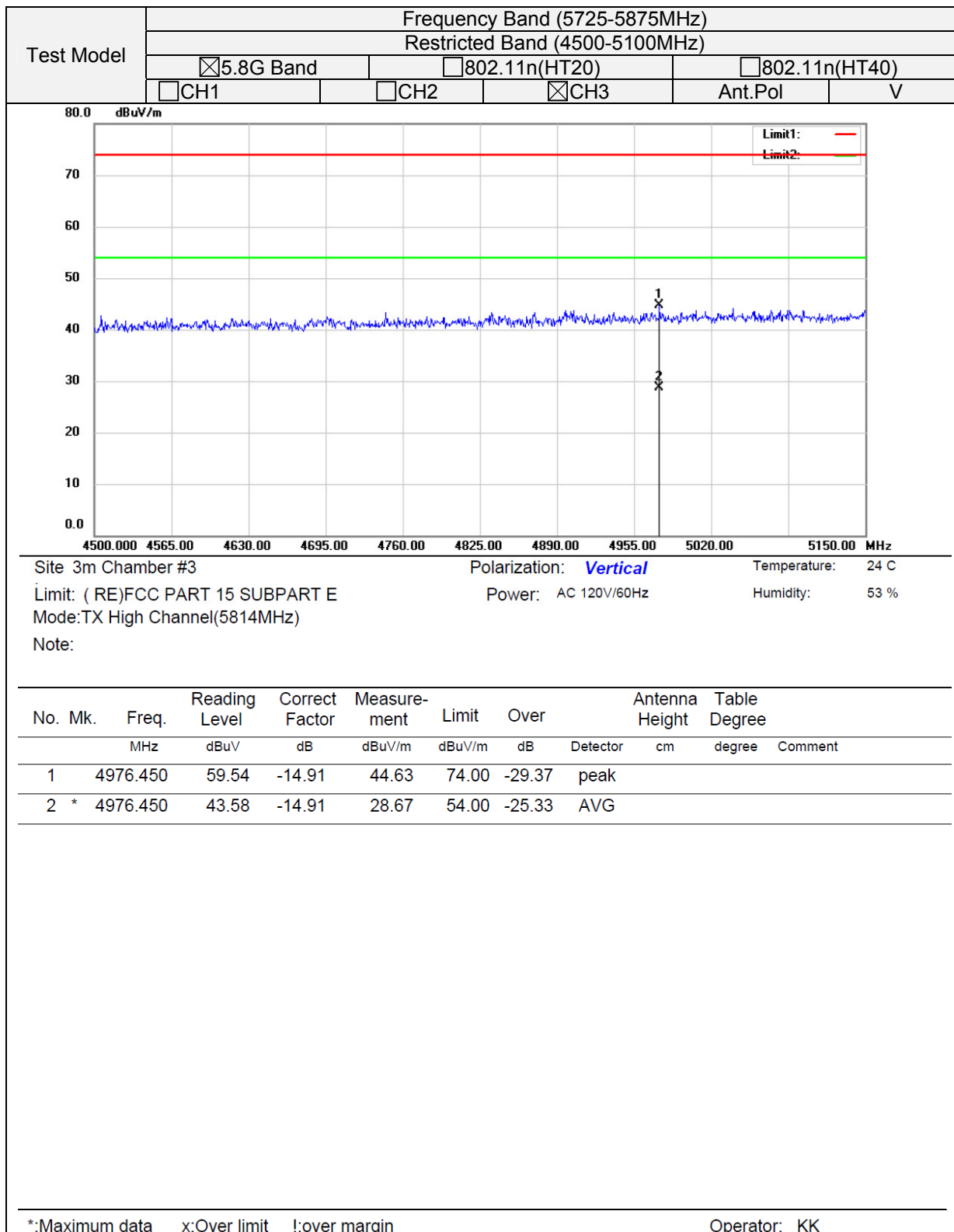

Undesirable radiated Spurious Emission in Restricted Band (5350-5460MHz)

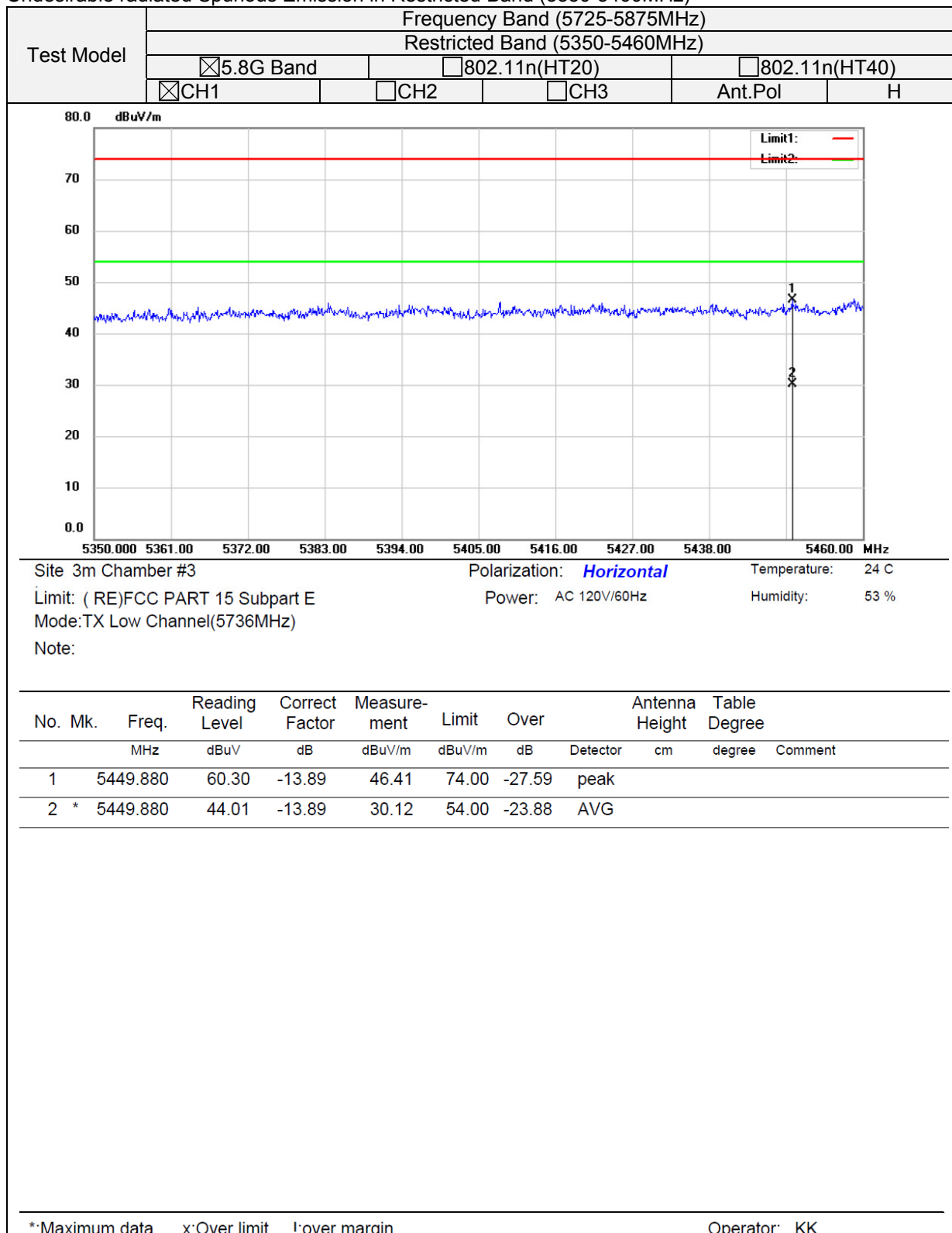

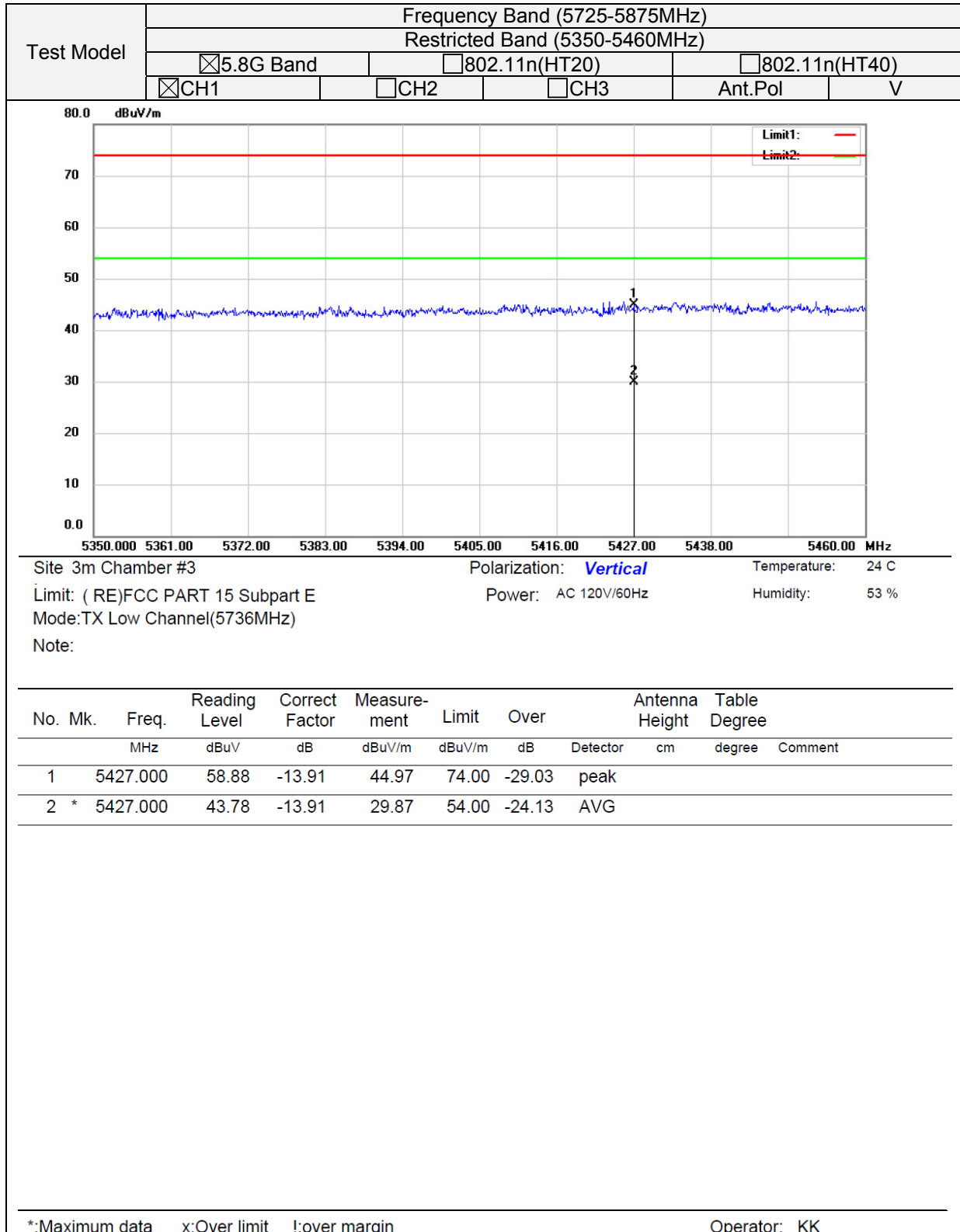



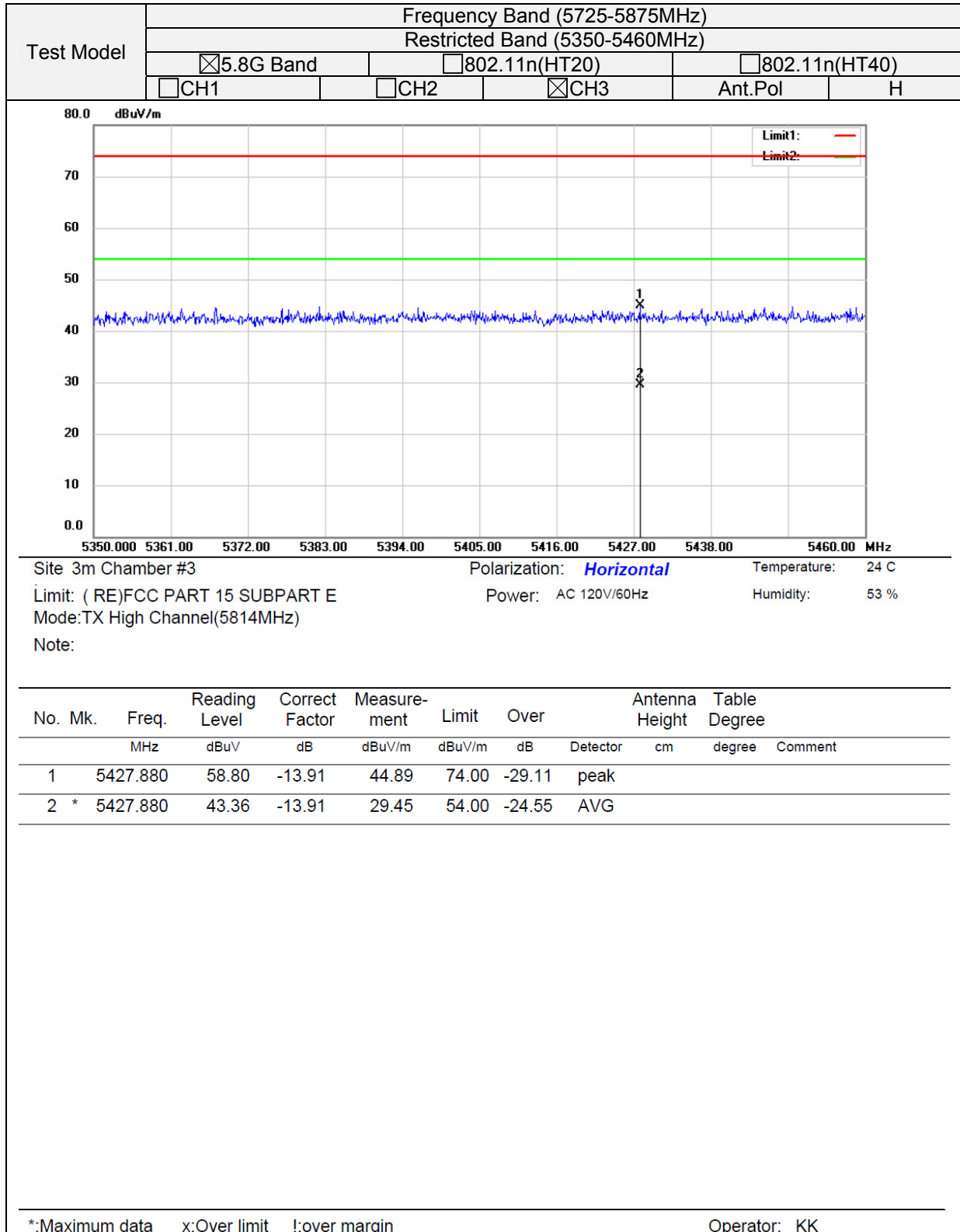

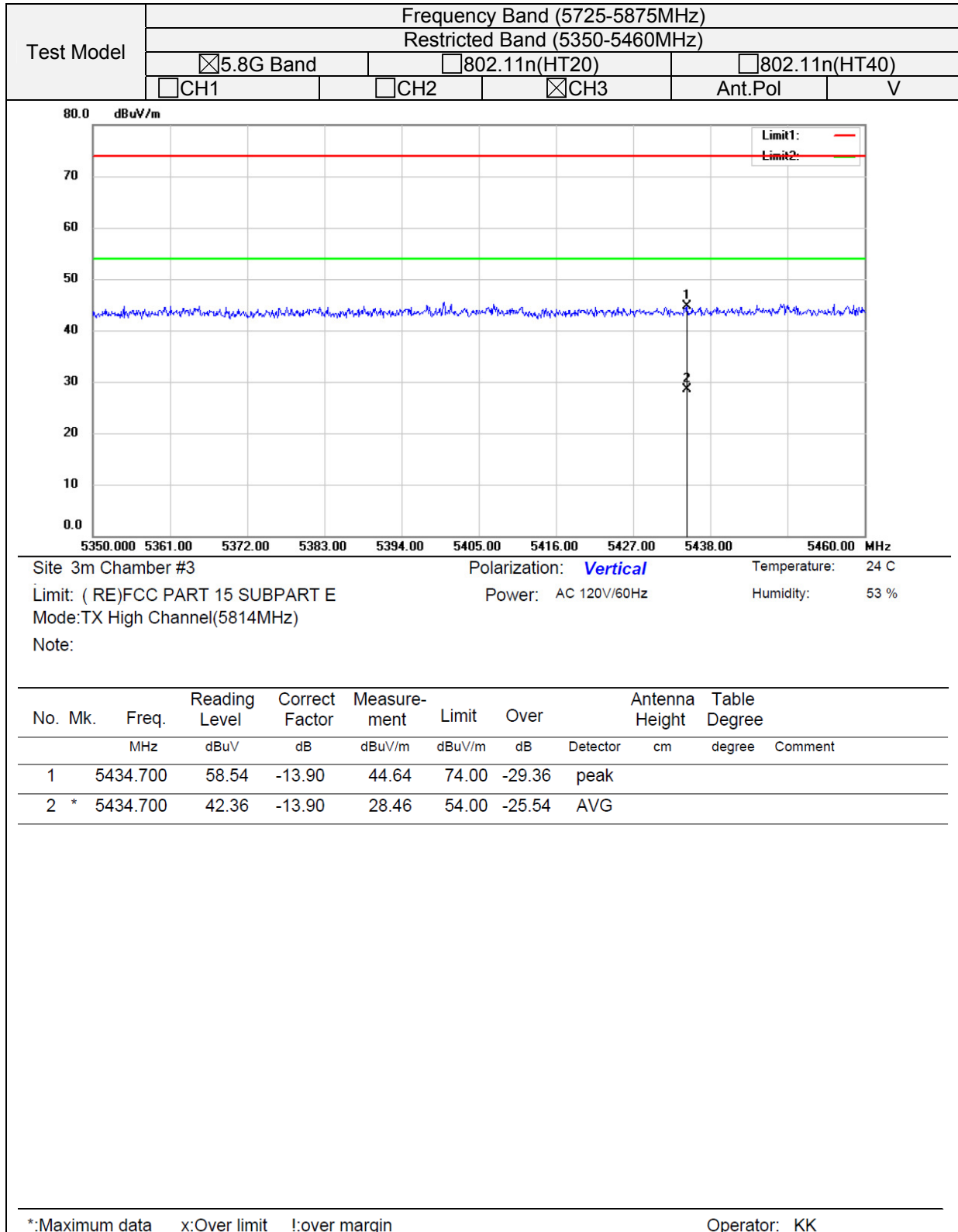

- Undesirable radiated Spurious Emission in band edge

Temperature:	24°C	Test Date:	September 17, 2015
Humidity:	53 %	Test By:	King Kong
Test mode:	5.8G Band	Frequency:	Channel 1: 5736MHz

Freq. (MHz)	Ant.Pol. H/V	Field Strength (RBW=100KHz) (dBuV/m)	E.I.R.P (dBm)	Limit (dBm)	Over Limit (dBm)	Verdict
5714.13	H	57.17	-38.06	-27	-11.06	PASS
5724.87	H	68.34	-26.89	-17	-9.89	PASS
5714.73	V	49.87	-45.36	-27	-18.36	PASS
5724.93	V	63.46	-31.77	-17	-14.77	PASS

Temperature:	24°C	Test Date:	September 17, 2015
Humidity:	53 %	Test By:	King Kong
Test mode:	5.8G Band	Frequency:	Channel 3: 5814MHz

Freq. (MHz)	Ant.Pol. H/V	Field Strength (RBW=100KHz) (dBuV/m)	E.I.R.P (dBm)	Limit (dBm)	Over Limit (dBm)	Verdict
5850.32	H	62.35	-32.88	-17	-5.88	PASS
5859.86	H	52.51	-42.72	-27	-25.72	PASS
5850.50	V	53.99	-41.24	-17	-14.24	PASS
5860.04	V	48.42	-46.81	-27	-29.81	PASS

**Note:** (1) All Readings are Peak Value (VBW=3MHz) and Peak Value (VBW=10Hz).

(2) Emission Level= Reading Level+Probe Factor +Cable Loss.

(3) EIRP[dBm] = E[dBuV/m] + 20 log(d[meters]) - 104.77

d is the measurement distance in 3 meters

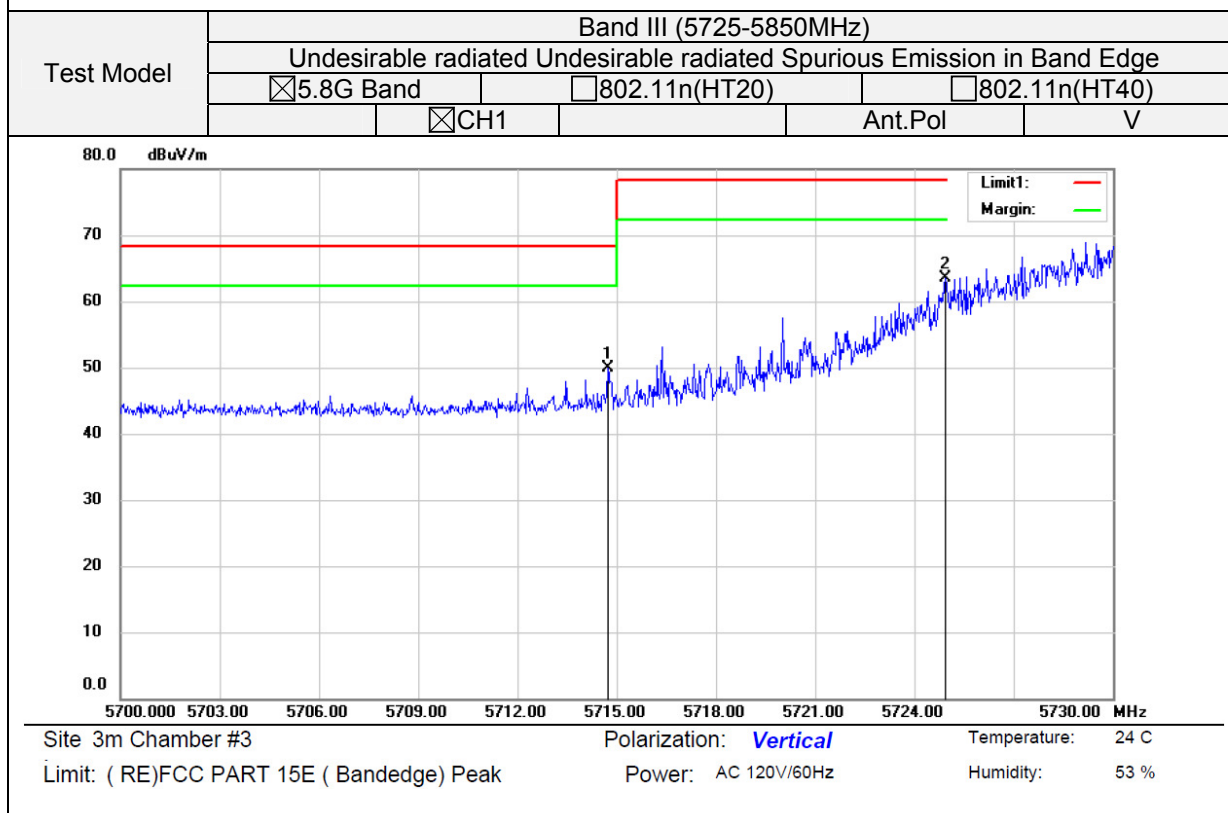
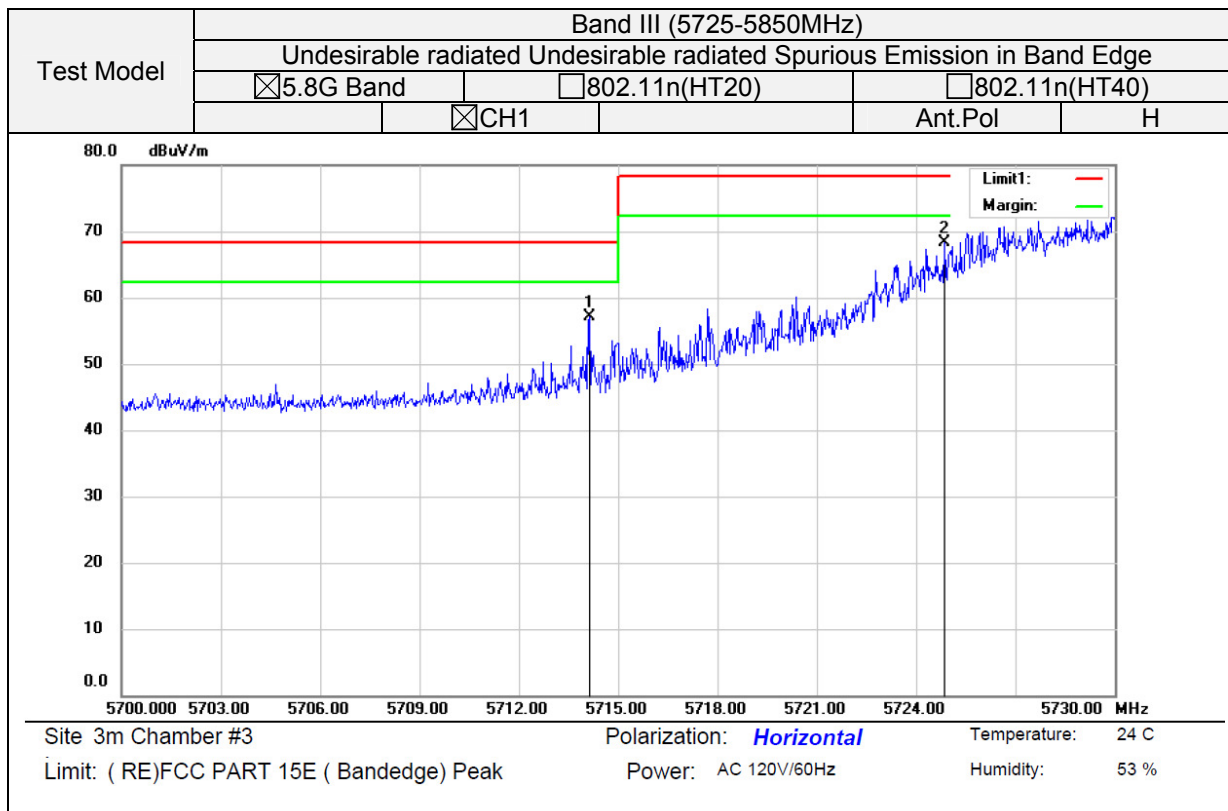

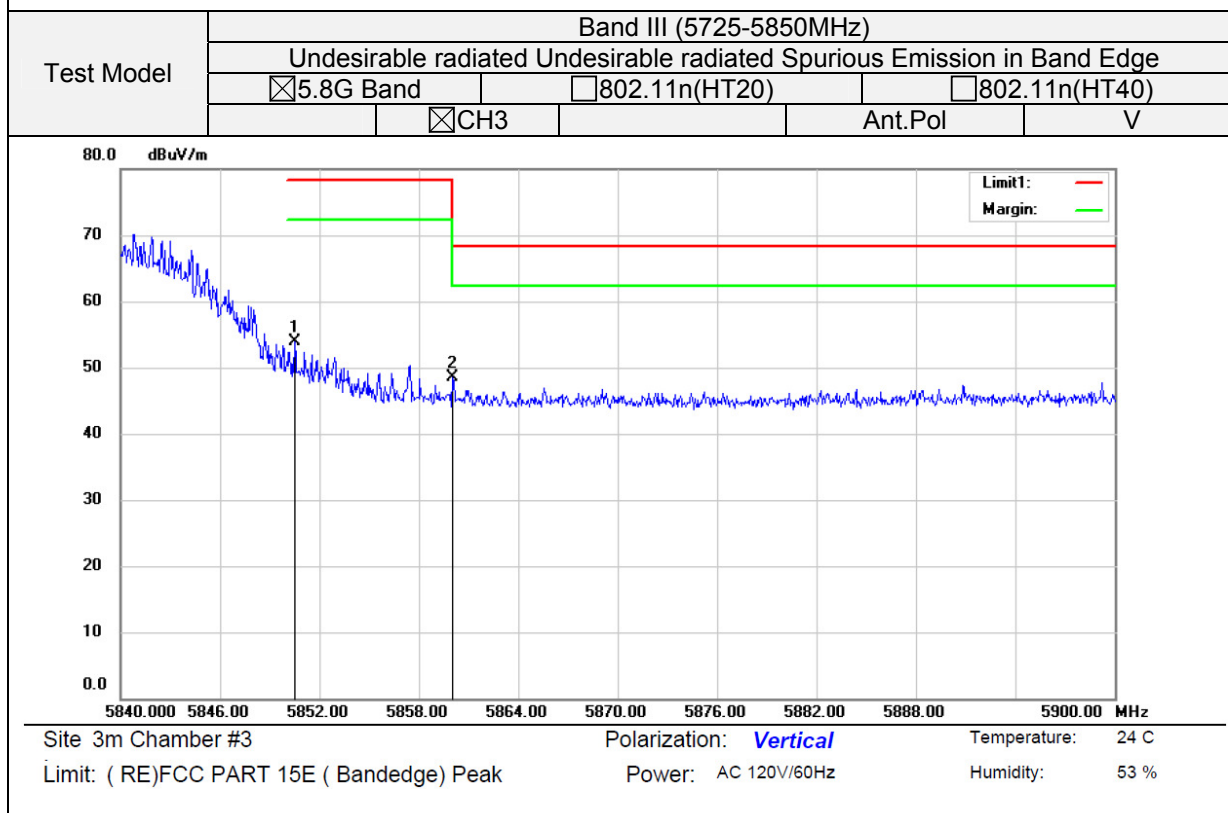
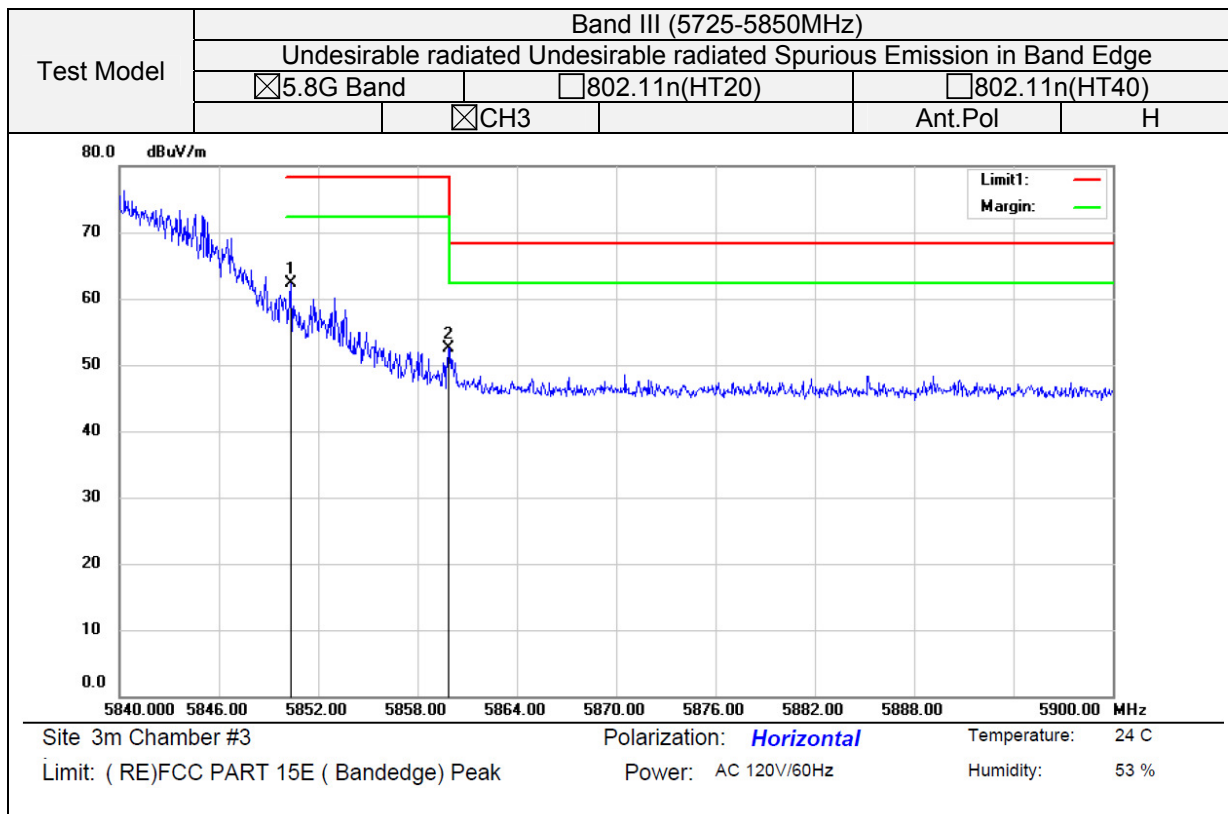

## 8.6 POWER LINE CONDUCTED EMISSIONS

### 8.6.1 Applicable Standard

According to FCC Part 15.207(a)

### 8.6.2 Conformance Limit

Conducted Emission Limit		
Frequency(MHz)	Quasi-peak	Average
0.15-0.5	66-56	56-46
0.5-5.0	56	46
5.0-30.0	60	50

Note: 1. The lower limit shall apply at the transition frequencies  
2. The limit decreases in line with the logarithm of the frequency in the range of 0.15 to 0.50MHz.

### 8.6.3 Test Configuration

Test according to clause 7.3 conducted emission test setup

### 8.6.4 Test Procedure

The EUT was placed on a table which is 0.8m above ground plane.  
Maximum procedure was performed on the highest emissions to ensure EUT compliance.  
Repeat above procedures until all frequency measured were complete.

### 8.6.5 Test Results

Pass

We test the EUT at 120V and 240V, and show the worst result as bellow.

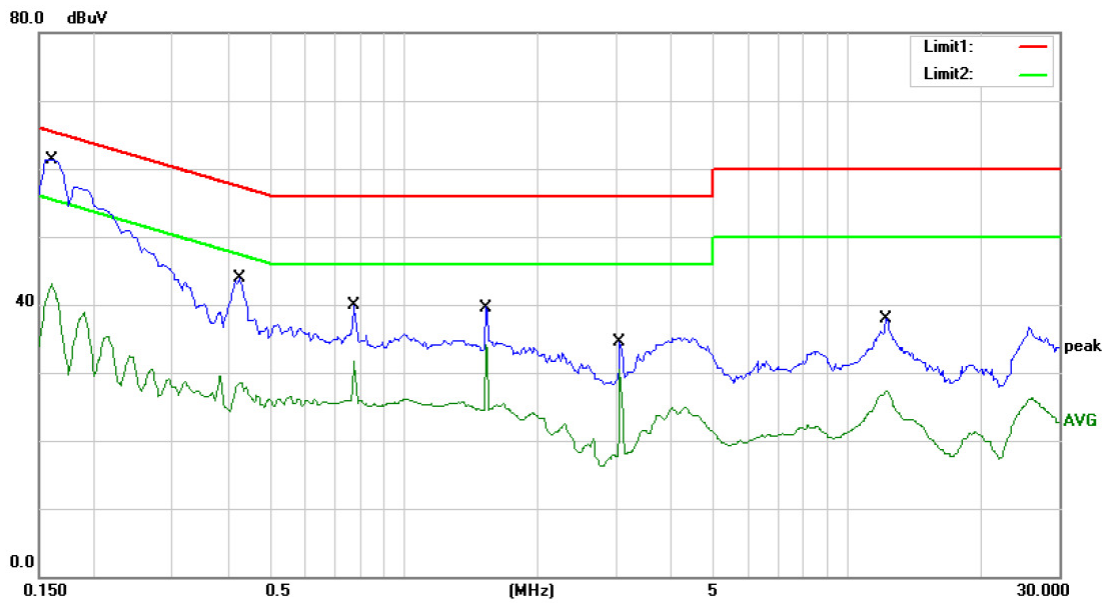

Site Conduction #2 Phase: **L1** Temperature: 26  
 Limit: (CE)FCC PART 15 class B\_QP Power: AC 120V/60Hz Humidity: 55 %  
 Mode: ON  
 Note:

No.	Mk.	Freq. MHz	Reading Level dBuV	Correct Factor dB	Measure- ment dBuV	Limit dBuV	Over dB	Detector	Comment
1	*	0.1600	57.50	0.00	57.50	65.46	-7.96	QP	
2		0.1600	42.46	0.00	42.46	55.46	-13.00	AVG	
3		0.4250	42.50	0.00	42.50	57.35	-14.85	QP	
4		0.4250	28.57	0.00	28.57	47.35	-18.78	AVG	
5		0.7700	37.80	0.00	37.80	56.00	-18.20	QP	
6		0.7700	31.67	0.00	31.67	46.00	-14.33	AVG	
7		1.5350	38.90	0.00	38.90	56.00	-17.10	QP	
8		1.5350	34.07	0.00	34.07	46.00	-11.93	AVG	
9		3.0700	34.54	0.00	34.54	56.00	-21.46	QP	
10		3.0700	30.46	0.00	30.46	46.00	-15.54	AVG	
11		12.2500	37.87	0.00	37.87	60.00	-22.13	QP	
12		12.2500	27.22	0.00	27.22	50.00	-22.78	AVG	

\*:Maximum data x:Over limit !:over margin Comment: Factor build in receiver. Operator: KK

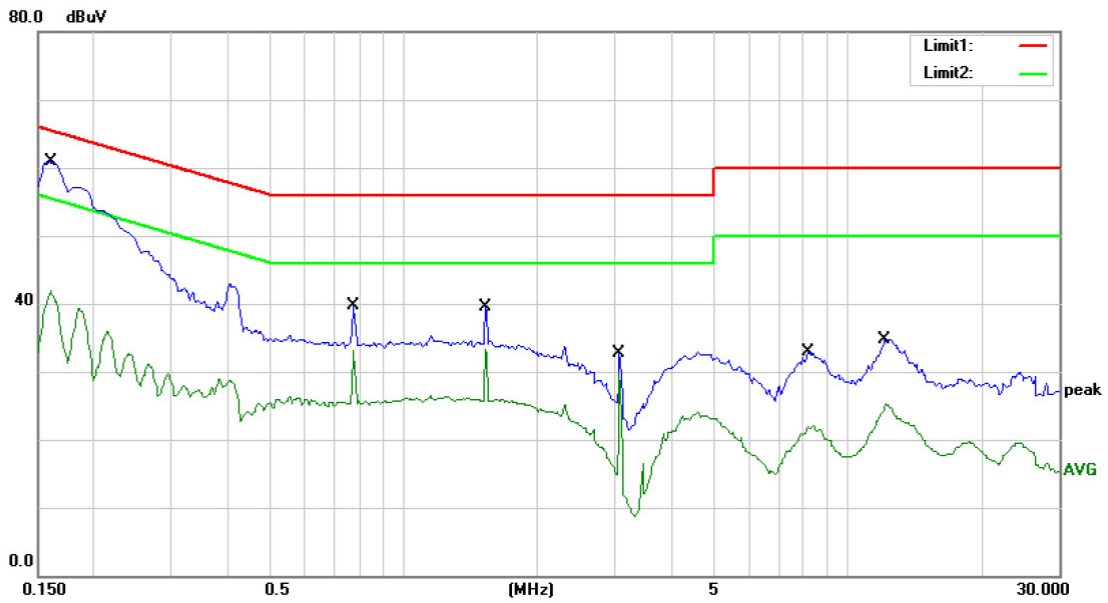

Site: Conduction #2  
 Limit: (CE)FCC PART 15 class B\_QP  
 Mode: ON  
 Note:

Phase: **N**  
 Power: AC 120V/60Hz

Temperature: 26  
 Humidity: 55 %

No.	Mk.	Freq. MHz	Reading Level dBuV	Correct Factor dB	Measure- ment dBuV	Limit dBuV	Over dB	Detector	Comment
1	*	0.1600	57.20	0.00	57.20	65.46	-8.26	QP	
2		0.1600	41.84	0.00	41.84	55.46	-13.62	AVG	
3		0.7700	37.20	0.00	37.20	56.00	-18.80	QP	
4		0.7700	33.18	0.00	33.18	46.00	-12.82	AVG	
5		1.5350	38.10	0.00	38.10	56.00	-17.90	QP	
6		1.5350	33.32	0.00	33.32	46.00	-12.68	AVG	
7		3.0700	32.80	0.00	32.80	56.00	-23.20	QP	
8		3.0700	29.99	0.00	29.99	46.00	-16.01	AVG	
9		8.1700	32.93	0.00	32.93	60.00	-27.07	QP	
10		8.1700	22.02	0.00	22.02	50.00	-27.98	AVG	
11		12.1750	34.76	0.00	34.76	60.00	-25.24	QP	
12		12.1750	25.22	0.00	25.22	50.00	-24.78	AVG	

\*:Maximum data    x:Over limit    !:over margin    Comment: Factor build in receiver.    Operator: KK



## 8.7 ANTENNA APPLICATION

### 8.7.1 Antenna Requirement

Standard	Requirement
FCC CRF Part 15.203	An intentional radiator shall be designed to ensure that no antenna other than that furnished by the responsible party shall be used with the device. The use of a permanently attached antenna or of an antenna that uses a unique coupling to the intentional radiator shall be considered sufficient to comply with the provisions of this section. The manufacturer may design the unit so that a broken antenna can be replaced by the user, but the use of a standard antenna jack or electrical connector is prohibited. This requirement does not apply to carrier current devices or to devices operated under the provisions of §15.211, §15.213, §15.217, §15.219, or §15.221. Further, this requirement does not apply to intentional radiators that must be professionally installed, such as perimeter protection systems and some field disturbance sensors, or to other intentional radiators which, in accordance with §15.31(d), must be measured at the installation site. However, the installer shall be responsible for ensuring that the proper antenna is employed so that the limits in this part are not exceeded.

For intentional device, according to FCC 47 CFR Section 15.203, an intentional radiator shall be designed to ensure that no antenna other than that furnished by the responsible party shall be used with the device. And according to FCC 47 CFR Section 15.407 (a), if transmitting antennas of directional gain greater than 6dBi are used, the power shall be reduced by the amount in dB that the directional gain of the antenna exceeds 6dBi.

### 8.7.2 Result

PASS.

The EUT has 2 antenna: two PCB Antenna for wifi 5.8G, the gain is 2 dBi;  
(This device does not support the MIMO mode. Two Antennas can't simultaneous transmission)

- Note:
- Antenna use a permanently attached antenna which is not replaceable.
  - Not using a standard antenna jack or electrical connector for antenna replacement
  - The antenna has to be professionally installed (please provide method of installation)

which in accordance to section 15.203, please refer to the internal photos.

END OF REPORT