

S

T

S

L

A

B



RADIO TEST REPORT

Report No.: STS2009164W04

Issued for

XTR S.A.C.

Av. Camino Real 1225 Of 201-A San Isidro Lima, Peru

Product Name:	Tablet
Brand Name:	EKS
Model Name:	X7
Series Model:	N/A
FCC ID:	2AGAK-X7
Test Standard:	47 CFR Part 2, 27

Any reproduction of this document must be done in full. No single part of this document may be reproduced without permission from STS, All Test Data Presented in this report is only applicable to presented Test sample.

Shenzhen STS Test Services Co., Ltd.
A 1/F, Building B, Zhuoke Science Park, No.190 Chongqing Road, HepingShequ,
Fuyong Sub-District, Bao'an District, Shenzhen, Guang Dong, China
TEL: +86-755 3688 6288 FAX: +86-755 3688 6277 E-mail: sts@stsapp.com





TEST RESULT CERTIFICATION

Applicant's Name: XTR S.A.C.

Address: Av. Camino Real 1225 Of 201-A San Isidro Lima, Peru

Manufacturer's Name: ENCORP LIMITED

Address: Room 411.4th floor, Yonghe high R&D building, NO.25 Langshan road, xili street, Nanshan district Shenzhen, China

Product Description

Product Name: Tablet

Brand Name: EKS

Model Name: X7

Series Model: N/A

Test Standards.....: 47 CFR Part 2, 27

Test Procedure: KDB 971168 D01 v03r01, ANSI C63.26 2015

This device described above has been tested by STS, the test results show that the equipment under test (EUT) is in compliance with the FCC requirements. And it is applicable only to the tested sample identified in the report.

This report shall not be reproduced except in full, without the written approval of STS, this document may be altered or revised by STS, personal only, and shall be noted in the revision of the document.

Date of Test.....:

Date of receipt of test item.....: 02 Sept. 2020

Date (s) of performance of tests.: 02 Sept. 2020 ~ 17 Sept. 2020

Date of Issue: 17 Sept. 2020

Test Result: Pass

Testing Engineer : 

 (Chris Chen)

Technical Manager : 

 (Sean she)

Authorized Signatory : 

 (Vita Li)





Table of Contents	Page
1. TEST FACTORY & MEASUREMENT UNCERTAINTY	5
2. GENERAL INFORMATION	6
3. CONDUCTED OUTPUT POWER	13
4. PEAK-TO-AVERAGE RATIO	17
5. RADIATED POWER AND EFFECTIVE ISOTROPIC RADIATED POWER	19
6. OCCUPIED BANDWIDTH	24
7. CONDUCTED BAND EDGE	26
8. CONDUCTED SPURIOUS EMISSION	28
9. RADIATED SPURIOUS EMISSION	29
10. FREQUENCY STABILITY	37
APPENDIX-PHOTOS OF TEST SETUP	39

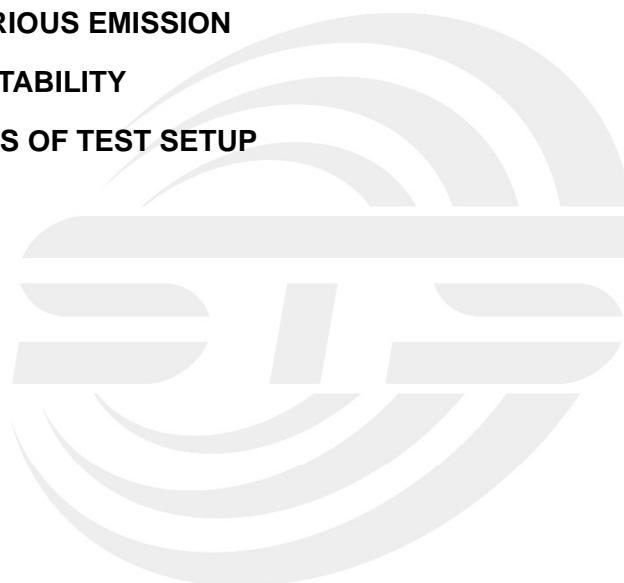



Revision History

Rev.	Issue Date	Report NO.	Effect Page	Contents
00	17 Sept. 2020	STS2009164W04	ALL	Initial Issue





1. TEST FACTORY & MEASUREMENT UNCERTAINTY

1.1 TEST FACTORY

SHENZHEN STS TEST SERVICES CO., LTD

Add. : A 1/F, Building B, Zhuoke Science Park, No.190 Chongqing Road, HepingShequ, Fuyong Sub-District, Bao'an District, Shenzhen, Guang Dong, China

FCC test Firm Registration Number: 625569

IC test Firm Registration Number: 12108A

A2LA Certificate No.: 4338.01

1.2 MEASUREMENT UNCERTAINTY

The reported uncertainty of measurement $y \pm U$, where expanded uncertainty U is based on a standard uncertainty multiplied by a coverage factor of $k=2$, providing a level of confidence of approximately 95 %.

No.	Item	Uncertainty
1	RF output power, conducted	$\pm 0.68\text{dB}$
2	Unwanted Emissions, conducted	$\pm 2.988\text{dB}$
3	All emissions, radiated 30-1GHz	$\pm 5.6\text{dB}$
4	All emissions, radiated 1G-6GHz	$\pm 5.5\text{dB}$
5	All emissions, radiated >6G	$\pm 5.8\text{dB}$
6	Conducted Emission (9KHz-150KHz)	$\pm 3.37\text{dB}$
7	Conducted Emission (150KHz-30MHz)	$\pm 3.83\text{dB}$



2. GENERAL INFORMATION

2.1 TECHNICAL SPECIFICATIONS AND REGULATIONS

2.1.1 PRODUCT DESCRIPTION

A major technical description of EUT is described as following:

Product Name	Tablet
Trade Name	EKS
Model Name	X7
Series Model	N/A
Model Difference	N/A
Frequency Bands	U.S. Bands: LTE FDD Band 4 LTE FDD Band 28
SIM Card	Only support single SIM Card.
Antenna	PIFA
Antenna gain	LTE Band 4: 2.35dBi
Battery parameter	Rated Voltage: 3.7V Charge Limit: 4.2V Capacity: 3200mAh
Adapter	Input: AC 100-240V 50/60HZ 0.3A Output: DC 5V,1.5A
Extreme Vol. Limits	4.07V to 3.33V (Nominal 3.7V)
Extreme Temp. Tolerance	-30°C to +50°C
Hardware version number	S706-9863A-V1.0-200723-C
Software version number	XTR_X7_PE_V01_20200916



2.1.2 PRODUCT SPECIFICATION SUBJECTIVE TO THIS STANDARD

Product Specification Subjective To This Standard	
Tx Frequency	LTE Band 4:1710~1755MHz LTE Band 28:703~824MHz
Rx Frequency	LTE Band 4:2110~2155MHz LTE Band 28:859~869MHz
Bandwidth	LTE Band 4: 1.4MHz / 3MHz / 5MHz / 10MHz / 15MHz /20MHz
Maximum Output Power	LTE Band 4: 24.81 dBm

RF Function	Band	UE Category UL	Modulation	Power Class	Ant Gain(dBi)	Ant Type	SIM Card
LTE	FDD:4	\	QPSK /16QAM	3	LTE B4:0.7	PIFA	2 SIM 1 is used to tested.

2.1.3 EMISSION DESIGNATOR

LTE Band 4 BW(MHz)	Emission Designator (99%OBW)QPSK	Emission Designator (99%OBW)16QAM
1.4	1M10G7D	1M10W7D
3	2M69G7D	2M69W7D
5	4M54G7D	4M55W7D
10	8M95G7D	8M70W7D
15	14M5G7D	13M5W7D
20	17M9G7D	18M0W7D



2.1.4 TEST CONFIGURATION OF EQUIPMENT UNDER TEST

Antenna port conducted and radiated test items listed below are performed according to KDB 971168 D01 v03r01 and ANSI C63.26 2015 Power Meas. License Digital Systems with maximum output power. Radiated measurements are performed by rotating the EUT in three different orthogonal test planes to find the maximum emission.

Remark:

1. The mark 'v' means that this configuration is chosen for testing
2. The mark '-' means that this bandwidth is not supported.
3. The device is investigated from 30MHz to 10 times of fundamental signal for radiated.

ITEMS	Band	Bandwidth (MHz)						Modulation		RB #			Test Channel		
		1.4	3	5	10	15	20	QPSK	16QAM	1	Half	Full	L	M	H
Max. Output Power	4	v	v	v	v	v	v	v	v	v	v	v	v	v	v
Peak&Avera Ratio	4						v	v	v	v		v	v	v	
26dB&99% Bandwidth	4	v	v	v	v	v	v	v	v			v	v	v	
Conducted Band Edge	4	v	v	v	v	v	v	v	v	v		v	v	v	
Conducted Spurious Emission	4	v	v	v	v	v	v	v	v	v			v	v	
Frequency Stability	4				v			v				v		v	
E.R.P.& E.I.R.P.	4	v	v	v	v	v	v	v	v	v			v	v	
Radiated Spurious Emission	4	v	v	v	v	v	v	v		v			v	v	



2.1.5 RELATED SUBMITTAL(S) / GRANT (S)

This submittal(s) (test report) is intended for filing to comply with the 47 CFR Part 2, 27.

2.1.6 SPECIAL ACCESSORIES

The battery and the charger, earphone supplied by the applicant were used as accessories and being tested with eut intended for fcc grant together.

2.1.7 EUT CONFIGURATION

The EUT configuration for testing is installed on RF field strength measurement to meet the Commission's requirement and operating in a manner which intends to maximize its emission characteristics in a continuous normal application.

2.1.8 EUT EXERCISE

The Transmitter was operated in the maximum output power mode through Communication Tester. The TX frequency was fixed which was for the purpose of the measurements.

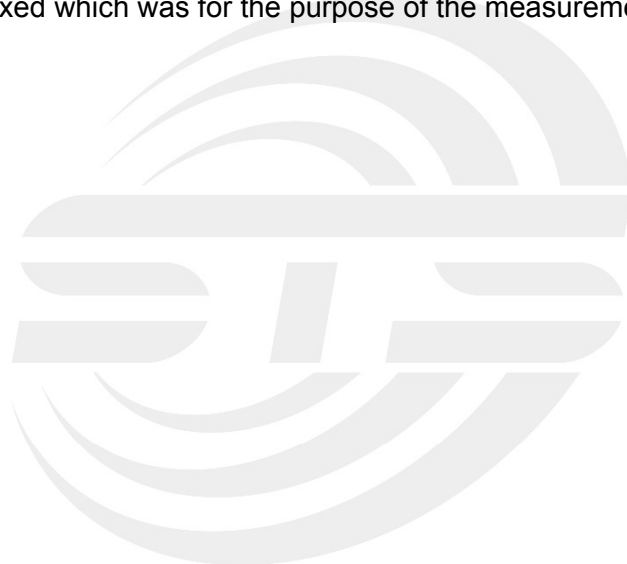



2.1.9 CONFIGURATION OF EUT SYSTEM

The EUT configuration for testing is installed on RF field strength measurement to meet the Commission's requirement and operating in a manner which intends to maximize its emission characteristics in a continuous normal application.

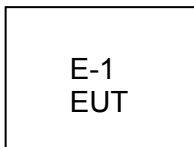

Table 2-1 Equipment Used in EUT System

Item	Equipment	Model No.	Length	Note
N/A	N/A	N/A	N/A	N/A

Note:

- (1) For detachable type I/O cable should be specified the length in cm in 『Length』 column.



2.1.10 MEASUREMENT INSTRUMENTS

The radiated emission testing was performed according to the procedures of ANSI C63.26 2015 and FCC CFR 47 rules of 2.1046, 2.1047, 2.1049, 2.1051, 2.1053, 2.1055, 2.1057.

Radiation Test equipment

Kind of Equipment	Manufacturer	Type No.	Serial No.	Last calibration	Calibrated until
Test Receiver	R&S	ESCI	101427	2019.10.09	2020.10.08
Signal Analyzer	Agilent	N9020A	MY51110105	2020.03.05	2021.03.04
Wireless Communications Test Set	R&S	CMW 500	133884	2020.03.05	2021.03.04
Bilog Antenna	TESEQ	CBL6111D	34678	2017.11.02	2020.11.01
Horn Antenna	SCHWARZBECK	BBHA 9120D(1201)	9120D-1343	2018.10.19	2021.10.18
Bilog Antenna	TESEQ	CBL6111D	45873	2018.10.26	2021.10.25
Horn Antenna	SCHWARZBECK	BBHA 9120D(1201)	9120D-2014	2019.10.15	2022.10.14
SHF-EHF Horn Antenna (18G-40GHz)	A-INFO	LB-180400-KF	J211020657	2018.03.11	2021.03.10
Pre-Amplifier (0.1M-3GHz)	EM	EM330	060665	2019.10.09	2020.10.08
Pre-Amplifier (1G-18GHz)	SKET	LNPA-01018G-45	SK2018080901	2019.10.12	2020.10.11
Pre-Amplifier (18G-40GHz)	SKET	LNPA-1840-50	SK2018101801	2019.10.12	2020.10.11
Turn table	EM	SC100_1	60531	N/A	N/A
Antenna mast	EM	SC100	N/A	N/A	N/A
Temperature & Humidity	HH660	Mieo	N/A	2019.10.17	2020.10.16
Test SW	BULUN	BL410-E/18.905			

RF Connected Test

Kind of Equipment	Manufacturer	Type No.	Serial No.	Last calibration	Calibrated until
Universal Radio communication tester	R&S	CMU200	119907	2020.10.11	2021.10.10
Wireless Communications Test Set	R&S	CMW 500	133884	2020.03.05	2021.03.04
Signal Analyzer	Agilent	N9020A	MY49100060	2019.10.09	2020.10.08
Temperature & Humidity	HH660	Mieo	N/A	2019.10.17	2020.10.16
Test SW	FARAD	LZ-RF /LzRf-3A3			



2.1.11 MEASUREMENT RESULTS EXPLANATION EXAMPLE

For all conducted test items:

The offset level is set in the spectrum analyzer to compensate the RF cable loss and attenuator factor between EUT conducted output port and spectrum analyzer. With the offset compensation, the spectrum analyzer reading level is exactly the EUT RF output level.

The spectrum analyzer offset is derived from RF cable loss and attenuator factor.

Offset = RF Cable Loss + Attenuator Factor.



3. CONDUCTED OUTPUT POWER

3.1 DESCRIPTION OF THE CONDUCTED OUTPUT POWER MEASUREMENT

3.1.1 MEASUREMENT METHOD

A system simulator was used to establish communication with the eut. Its parameters were set to force the eut transmitting at maximum output power. The measured power in the radio frequency on the transmitter output terminals shall be reported. Configuration follows KDB 971168 D01 v03r01.

3.1.2 TEST SETUP

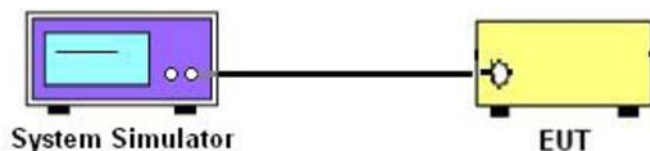

3.1.3 TEST PROCEDURES

1. The transmitter output port was connected to system simulator.
2. Set EUT at maximum power through the system simulator.
3. Select lowest/middle/highest channels for each band and different modulation.
4. Measure and record the power level from the system simulator.



3.1.4 TEST RESULTS

LTE Band 4 Maximum Average Power [dBm]						
BW [MHz]	RB Size	RB Offset	Mod	Lowest	Middle	Highest
1.4	1	0	QPSK	24.45	24.78	24.02
1.4	1	2		24.25	24.51	24.81
1.4	1	5		24.02	24.30	24.57
1.4	3	0		23.75	24.09	24.31
1.4	3	1		23.47	23.82	24.03
1.4	3	2		23.19	23.61	23.80
1.4	6	0		22.92	23.33	23.56
1.4	1	0	16-QAM	24.16	24.55	24.75
1.4	1	2		23.90	24.35	24.50
1.4	1	5		23.70	24.09	24.30
1.4	3	0		23.45	23.82	24.05
1.4	3	1		23.17	23.60	23.79
1.4	3	2		22.95	23.32	23.59
1.4	6	0		22.74	23.04	23.38
3	1	0	QPSK	23.65	23.47	24.12
3	1	7		23.39	23.22	23.85
3	1	14		23.11	22.97	23.61
3	8	0		22.89	22.72	23.38
3	8	4		22.59	22.48	23.17
3	8	7		22.38	22.23	22.95
3	15	0		22.13	22.01	22.71
3	1	0	16-QAM	23.38	23.23	23.84
3	1	7		23.11	23.01	23.57
3	1	14		22.88	22.72	23.37
3	8	0		22.63	22.46	23.16
3	8	4		22.37	22.20	22.86
3	8	7		22.14	21.97	22.63
3	15	0		21.88	21.77	22.41



LTE Band 4 Maximum Average Power [dBm]						
BW [MHz]	RB Size	RB Offset	Mod	Lowest	Middle	Highest
5	1	0	QPSK	23.44	23.81	22.96
5	1	12		23.22	23.59	22.72
5	1	24		22.95	23.34	22.51
5	12	0		22.71	23.07	22.22
5	12	6		22.42	22.79	21.99
5	12	11		22.16	22.56	21.70
5	25	0		21.92	22.34	21.47
5	1	0	16-QAM	23.21	23.56	22.71
5	1	12		23.01	23.27	22.47
5	1	24		22.81	23.04	22.19
5	12	0		22.54	22.75	21.99
5	12	6		22.30	22.47	21.77
5	12	11		22.03	22.26	21.50
5	25	0		21.73	22.02	21.24
10	1	0	QPSK	22.93	23.20	23.14
10	1	24		22.66	22.90	22.93
10	1	49		22.39	22.61	22.68
10	25	0		22.14	22.36	22.47
10	25	12		21.86	22.06	22.26
10	25	24		21.58	21.77	22.02
10	50	0		21.35	21.48	21.79
10	1	0	16-QAM	22.72	22.99	22.85
10	1	24		22.46	22.70	22.64
10	1	49		22.19	22.48	22.41
10	25	0		21.95	22.24	22.12
10	25	12		21.75	22.02	21.91
10	25	24		21.52	21.81	21.63
10	50	0		21.30	21.58	21.41



LTE Band 4 Maximum Average Power [dBm]						
BW [MHz]	RB Size	RB Offset	Mod	Lowest	Middle	Highest
15	1	0	QPSK	22.45	22.85	23.22
15	1	37		22.22	22.61	22.95
15	1	74		22.01	22.37	22.65
15	36	0		21.76	22.08	22.39
15	36	18		21.53	21.87	22.12
15	36	39		21.25	21.59	21.91
15	75	0		20.99	21.36	21.66
15	1	0	16-QAM	22.25	22.62	22.97
15	1	38		22.03	22.36	22.68
15	1	75		21.75	22.12	22.42
15	36	0		21.46	21.84	22.20
15	36	18		21.25	21.54	22.00
15	36	39		20.97	21.31	21.72
15	75	0		20.72	21.07	21.46
20	1	0	QPSK	21.97	22.34	23.24
20	1	49		21.74	22.09	22.98
20	1	99		21.51	21.87	22.72
20	50	0		21.22	21.61	22.46
20	50	24		20.99	21.32	22.20
20	50	49		20.77	21.06	21.99
20	100	0		20.57	20.83	21.76
20	1	0	16-QAM	21.71	22.04	23.02
20	1	49		21.46	21.82	22.75
20	1	99		21.21	21.61	22.45
20	50	0		20.92	21.38	22.23
20	50	24		20.65	21.08	22.02
20	50	49		20.43	20.81	21.76
20	100	0		20.22	20.59	21.47

4. PEAK-TO-AVERAGE RATIO

4.1 DESCRIPTION OF THE CONDUCTED OUTPUT POWER MEASUREMENT

4.1.1 MEASUREMENT METHOD

Use one of the procedures presented in 4.1.3 to measure the total peak power and record as PPK. Use one of the applicable procedures presented 4.1.3 to measure the total average power and record as PAVg. Both the peak and average power levels must be expressed in the same logarithmic units (e.g., dBm). Determine the PAPR from:
 $PAPR (dB) = PPK (dBm) - PAVg (dBm)$.

4.1.2 TEST SETUP

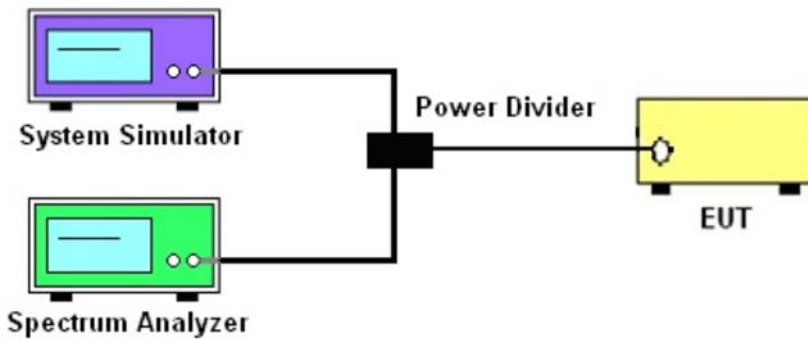

4.1.3 TEST PROCEDURES

1. The testing follows FCC KDB 971168 D01 v03r01 Section 5.7 and ANSI C63.26 2015 Section 5.2.6.
2. The EUT was connected to spectrum and system simulator via a power divider
3. Select lowest, middle, and highest channels for each band and different modulation.
4. Set the test probe and measure the peak and average power of the spectrum analyzer
5. Record the deviation as Peak to Average Ratio.

	LTE					
LTE BW	1.4M	3M	5M	10M	15M	20M
Span	3MHz	6MHz	10MHz	20MHz	30MHz	40MHz
RBW	30kHz	30kHz	100kHz	100kHz	300kHz	300kHz
VBW	100kHz	100kHz	300kHz	300kHz	1000kHz	1000kHz
Detector	PK/AVG	PK/AVG	PK/AVG	PK/AVG	PK/AVG	PK/AVG
Trace	Max	Max	Max	Max	Max	Max
Sweep Count	Auto	Auto	Auto	Auto	Auto	Auto



4.1.4 TEST RESULTS

LTE Band 4 PAR [dBm]					
BW [MHz]	RB Size	Modulation	Lowest	Middle	Highest
			P-A	P-A	P-A
20	1	QPSK	5.05	5.06	5.4
20	100		5.61	5.61	5.7
20	1	16-QAM	5.53	6.63	5.74
20	100		6.45	6.28	6.54
Limit			≤13dB		

Note: Test chart See Appendix D



5. RADIATED POWER AND EFFECTIVE ISOTROPIC RADIATED POWER

5.1 DESCRIPTION OF THE ERP/EIRP MEASUREMENT

5.1.1 MEASUREMENT METHOD

Effective radiated power output measurements by substitution method according to ANSI C63.26 2015, and the spectrum analyzer configuration follows KDB 971168 D01 Power Meas. License Digital Systems. Mobile and portable (hand-held) stations operating are limited to average ERP, Equivalent isotropic radiated power output measurements by substitution method according to ANSI C63.26 2015, and the spectrum analyzer configuration follows KDB 971168 D01 Power Meas, Mobile and portable (hand-held) stations operating are limited to average EIRP.

5.1.2 TEST SETUP

The procedure of radiated spurious emissions is as follows:

a) Pre-calibration With pre-calibration method, the Radiated Spurious Emissions(RSE) is calculated as, $RSE = R_x (dBuV) + CL (dB) + SA (dB) + Gain (dBi) - 107 (dBuV \text{ to } dBm)$ The SA is calibrated using following setup.

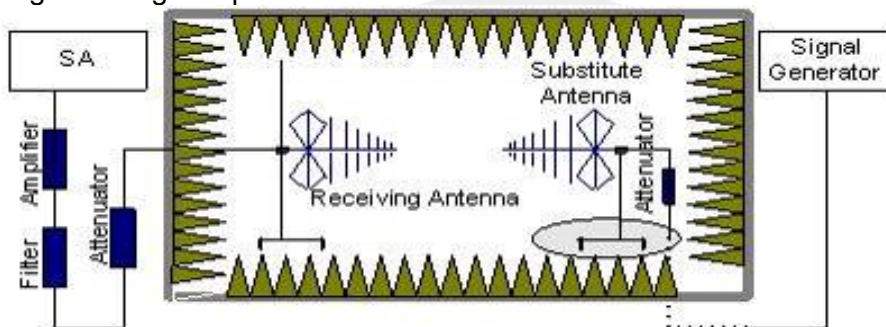

b) EUT was placed on a 1.5m non-conductive stand at a 3 m test distance from the receive antenna. A receiving antenna was placed on the antenna mast 3 m from the test item for emission measurements. The height of receiving antenna is 0.8m. The test setup refers to figure below. Detected emissions were maximized at each frequency by rotating the test item and adjusting the receiving antenna polarization. The radiated emission measurements of all non-harmonic and harmonics of the transmit frequency through the 10th harmonic measured with peak detector and 1MHz bandwidth.

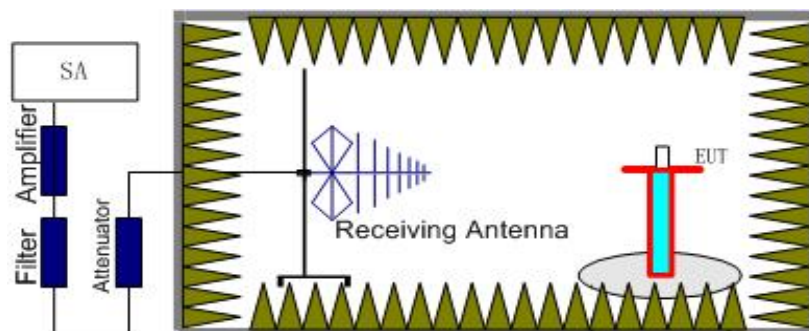

Radiated emissions measurements were made only at the upper, middle, and lower carrier frequencies. It was decided that measurements at these three carrier frequencies would be sufficient to demonstrate compliance with emissions limits because it was seen that all the significant spurs occur well outside the band and no radiation was seen from a carrier in one block of any band into any of the other blocks.

The substitution method is used. Substitution values at each frequency are measured before and saved to the test software. A "reference path loss" is established and the ARpl is the attenuation of "reference path loss", and including the gain of receive antenna, the gain of the preamplifier, the cable loss and the air loss. The measurement results are obtained as described below:

Power = P_{Mea} + ARpl



5.1.3 TEST PROCEDURES

1. The testing follows FCC KDB 971168 D01v03r01 Section 5.6 and ANSI C63.26 2015 Section 5.2.
2. The EUT was placed on a non-conductive rotating platform 1.5 meters high in a semi-anechoic chamber. The radiated emission at the fundamental frequency was measured at 3 m with a test antenna and a spectrum analyzer with Peak detector.
3. During the measurement, the system simulator parameters were set to force the EUT transmitting at maximum output power. The maximum emission was recorded from analyzer power level (LVL) from the 360 degrees rotation of the turntable and the test antenna raised and lowered over a range from 1 to 4 m in both horizontally and vertically polarized orientations.
4. Effective Isotropic Radiated Power (EIRP) was measured by substitution method according to ANSI C63.26 2015. The EUT was replaced by dipole antenna (substitution antenna) at same location and then a known power from S.G. was applied into the dipole antenna through a Tx cable, and then recorded the maximum Analyzer reading through raised and lowered the test antenna. $EIRP = S.G \text{ Level} + \text{Gain} - \text{Cable loss}$; $ERP = S.G \text{ Level} + \text{Gain} - \text{Cable loss} - 2.15$.
5. RB Set greater than bandwidth, VB Set spectrum analyzer Maximum support.





5.1.4 TEST RESULTS

Note: Test is divided into three directions, X/Y/Z. X pattern for the worst.

Radiated Power (EIRP) for LTE Band 4 / 1.4M									
Modulation	RB		Channel	Result					Conclusion
	Size	Offset		S G.Level (dBm)	Cable loss	Gain (dBi)	PMeas E.I.R.P.(dBm)	Polarization Of Max. EIRP	
QPSK	1	0	Lowest	13.87	2.35	10.13	21.65	Horizontal	Pass
	1	0	Middle	14.21	2.36	10.16	22.01	Horizontal	Pass
	1	0	Highest	13.4	2.37	10.22	21.25	Horizontal	Pass
	1	0	Lowest	15.28	2.35	10.13	23.06	Vertical	Pass
	1	0	Middle	15.62	2.36	10.16	23.42	Vertical	Pass
	1	0	Highest	14.87	2.37	10.22	22.72	Vertical	Pass
16QAM	1	0	Lowest	13.77	2.35	10.13	21.55	Horizontal	Pass
	1	0	Middle	14.08	2.36	10.16	21.88	Horizontal	Pass
	1	0	Highest	14.2	2.37	10.22	22.05	Horizontal	Pass
	1	0	Lowest	15.13	2.35	10.13	22.91	Vertical	Pass
	1	0	Middle	15.55	2.36	10.16	23.35	Vertical	Pass
	1	0	Highest	15.6	2.37	10.22	23.45	Vertical	Pass
Limit	EIRP<1W=30dBm								

Radiated Power (EIRP) for LTE Band 4 / 3M									
Modulation	RB		Channel	Result					Conclusion
	Size	Offset		S G.Level (dBm)	Cable loss	Gain (dBi)	PMeas E.I.R.P.(dBm)	Polarization Of Max. EIRP	
QPSK	1	0	Lowest	13.08	2.35	10.13	20.86	Horizontal	Pass
	1	0	Middle	13.09	2.36	10.16	20.89	Horizontal	Pass
	1	0	Highest	13.58	2.37	10.22	21.43	Horizontal	Pass
	1	0	Lowest	14.51	2.35	10.13	22.29	Vertical	Pass
	1	0	Middle	14.47	2.36	10.16	22.27	Vertical	Pass
	1	0	Highest	14.94	2.37	10.22	22.79	Vertical	Pass
16QAM	1	0	Lowest	12.83	2.35	10.13	20.61	Horizontal	Pass
	1	0	Middle	12.62	2.36	10.16	20.42	Horizontal	Pass
	1	0	Highest	13.46	2.37	10.22	21.31	Horizontal	Pass
	1	0	Lowest	14.29	2.35	10.13	22.07	Vertical	Pass
	1	0	Middle	14.12	2.36	10.16	21.92	Vertical	Pass
	1	0	Highest	14.77	2.37	10.22	22.62	Vertical	Pass
Limit	EIRP<1W=30dBm								



Radiated Power (EIRP) for LTE Band 4 / 5M									
Modulation	RB		Channel	Result					Conclusion
	Size	Offset		S G.Level (dBm)	Cable loss	Gain (dBi)	PMeas E.I.R.P.(dBm)	Polarization Of Max. EIRP	
QPSK	1	0	Lowest	12.93	2.35	10.13	20.71	Horizontal	Pass
	1	0	Middle	13.44	2.36	10.16	21.24	Horizontal	Pass
	1	0	Highest	12.41	2.37	10.22	20.26	Horizontal	Pass
	1	0	Lowest	14.27	2.35	10.13	22.05	Vertical	Pass
	1	0	Middle	14.78	2.36	10.16	22.58	Vertical	Pass
	1	0	Highest	13.81	2.37	10.22	21.66	Vertical	Pass
16QAM	1	0	Lowest	12.73	2.35	10.13	20.51	Horizontal	Pass
	1	0	Middle	13.09	2.36	10.16	20.89	Horizontal	Pass
	1	0	Highest	12.29	2.37	10.22	20.14	Horizontal	Pass
	1	0	Lowest	14.22	2.35	10.13	22.00	Vertical	Pass
	1	0	Middle	14.45	2.36	10.16	22.25	Vertical	Pass
	1	0	Highest	13.64	2.37	10.22	21.49	Vertical	Pass
Limit	EIRP<1W=30dBm								

Radiated Power (EIRP) for LTE Band 4 / 10M									
Modulation	RB		Channel	Result					Conclusion
	Size	Offset		S G.Level (dBm)	Cable loss	Gain (dBi)	PMeas E.I.R.P.(dBm)	Polarization Of Max. EIRP	
QPSK	1	0	Lowest	12.45	2.35	10.13	20.23	Horizontal	Pass
	1	0	Middle	12.7	2.36	10.16	20.50	Horizontal	Pass
	1	0	Highest	12.43	2.37	10.22	20.28	Horizontal	Pass
	1	0	Lowest	13.88	2.35	10.13	21.66	Vertical	Pass
	1	0	Middle	14.08	2.36	10.16	21.88	Vertical	Pass
	1	0	Highest	13.93	2.37	10.22	21.78	Vertical	Pass
16QAM	1	0	Lowest	12.16	2.35	10.13	19.94	Horizontal	Pass
	1	0	Middle	12.44	2.36	10.16	20.24	Horizontal	Pass
	1	0	Highest	12.36	2.37	10.22	20.21	Horizontal	Pass
	1	0	Lowest	13.56	2.35	10.13	21.34	Vertical	Pass
	1	0	Middle	13.86	2.36	10.16	21.66	Vertical	Pass
	1	0	Highest	13.76	2.37	10.22	21.61	Vertical	Pass
Limit	EIRP<1W=30dBm								



Radiated Power (EIRP) for LTE Band 4 / 15M									
Modulation	RB		Channel	Result					Conclusion
	Size	Offset		S G.Level (dBm)	Cable loss	Gain (dBi)	PMeas E.I.R.P.(dBm)	Polarization Of Max. EIRP	
QPSK	1	0	Lowest	12.03	2.35	10.13	19.81	Horizontal	Pass
	1	0	Middle	12.5	2.36	10.16	20.30	Horizontal	Pass
	1	0	Highest	12.68	2.37	10.22	20.53	Horizontal	Pass
	1	0	Lowest	13.38	2.35	10.13	21.16	Vertical	Pass
	1	0	Middle	13.81	2.36	10.16	21.61	Vertical	Pass
	1	0	Highest	14.05	2.37	10.22	21.90	Vertical	Pass
16QAM	1	0	Lowest	11.83	2.35	10.13	19.61	Horizontal	Pass
	1	0	Middle	12.05	2.36	10.16	19.85	Horizontal	Pass
	1	0	Highest	12.5	2.37	10.22	20.35	Horizontal	Pass
	1	0	Lowest	13.17	2.35	10.13	20.95	Vertical	Pass
	1	0	Middle	13.44	2.36	10.16	21.24	Vertical	Pass
	1	0	Highest	13.92	2.37	10.22	21.77	Vertical	Pass
Limit	EIRP<1W=30dBm								

Radiated Power (EIRP) for LTE Band 4 / 20M									
Modulation	RB		Channel	Result					Conclusion
	Size	Offset		S G.Level (dBm)	Cable loss	Gain (dBi)	PMeas E.I.R.P.(dBm)	Polarization Of Max. EIRP	
QPSK	1	0	Lowest	11.58	2.35	10.13	19.36	Horizontal	Pass
	1	0	Middle	11.88	2.36	10.16	19.68	Horizontal	Pass
	1	0	Highest	12.89	2.37	10.22	20.74	Horizontal	Pass
	1	0	Lowest	12.9	2.35	10.13	20.68	Vertical	Pass
	1	0	Middle	13.32	2.36	10.16	21.12	Vertical	Pass
	1	0	Highest	14.19	2.37	10.22	22.04	Vertical	Pass
16QAM	1	0	Lowest	11.35	2.35	10.13	19.13	Horizontal	Pass
	1	0	Middle	11.59	2.36	10.16	19.39	Horizontal	Pass
	1	0	Highest	12.39	2.37	10.22	20.24	Horizontal	Pass
	1	0	Lowest	12.7	2.35	10.13	20.48	Vertical	Pass
	1	0	Middle	12.89	2.36	10.16	20.69	Vertical	Pass
	1	0	Highest	13.79	2.37	10.22	21.64	Vertical	Pass
Limit	EIRP<1W=30dBm								

6. OCCUPIED BANDWIDTH

6.1 DESCRIPTION OF OCCUPIED BANDWIDTH MEASUREMENT

6.1.1 MEASUREMENT METHOD

1.The occupied bandwidth is the width of a frequency band such that, below the lower and above the upper frequency limits, the mean powers emitted are each equal to a specified percentage 0.5% of the total mean transmitted power.

2.The 26 db emission bandwidth is defined as the frequency range between two points, one above and one below the carrier frequency, at which the spectral density of the emission is attenuated 26 db below the maximum in-band spectral density of the modulated signal. spectral density (power per unit bandwidth) is to be measured with a detector of resolution bandwidth equal to approximately 1.0% of the emission bandwidth.

6.1.2 TEST SETUP

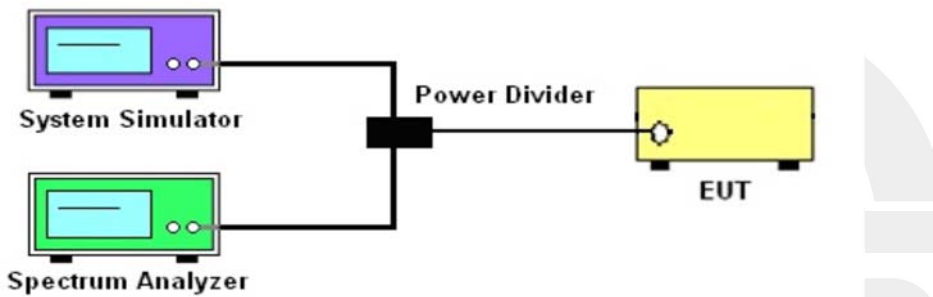

6.1.3 TEST PROCEDURES

1. The testing follows FCC KDB 971168 D01 v03r01 Section 4.2 and 4.3.
2. The EUT was connected to spectrum and system simulator via a power divider.
3. Select lowest, middle, and highest channels for each band and different modulation.
4. Set the test probe and measure the Occupied Bandwidth of the spectrum analyzer.
5. Measure and record the Occupied Bandwidth from the Spectrum Analyzer.

	LTE					
LTE BW	1.4M	3M	5M	10M	15M	20M
Span	3MHz	6MHz	10MHz	20MHz	30MHz	40MHz
RBW	30kHz	30kHz	100kHz	100kHz	300kHz	300kHz
VBW	100kHz	100kHz	300kHz	300kHz	1000kHz	1000kHz
Detector	PK	PK	PK	PK	PK	PK
Trace	Max	Max	Max	Max	Max	Max
Sweep Count	Auto	Auto	Auto	Auto	Auto	Auto



6.1.4 MEASUREMENT RESULT

LTE Band 4 Bandwidth [MHz]							
BW [MHz]	Mode	Lowest		Middle		Highest	
		99% BW	26dB BW	99% BW	26dB BW	99% BW	26dB BW
1.4	QPSK	1.1006	1.289	1.104	1.309	1.097	1.272
1.4	16-QAM	1.093	1.286	1.102	1.303	1.104	1.261
3	QPSK	2.687	2.99	2.69	2.998	2.6873	2.995
3	16-QAM	2.6873	3.051	2.69	3.021	2.657	3.003
5	QPSK	4.524	5.433	4.538	5.288	4.519	5.234
5	16-QAM	4.539	5.433	4.547	5.464	4.524	5.274
10	QPSK	8.937	9.797	8.939	9.819	8.952	9.835
10	16-QAM	8.936	9.832	8.944	9.852	8.951	10.04
15	QPSK	13.518	15.74	13.488	15.19	14.456	15.35
15	16-QAM	13.506	15.03	13.48	14.92	13.497	14.94
20	QPSK	17.979	19.86	17.922	19.52	17.932	19.62
20	16-QAM	17.931	19.66	17.917	19.8	18.002	20.06

Note: Test chart See Appendix A





7. CONDUCTED BAND EDGE

7.1 DESCRIPTION OF CONDUCTED BAND EDGE MEASUREMENT

7.1.1 MEASUREMENT METHOD

1. §22.917(a)

For operations in the 824 – 849 MHz band, the FCC limit is $43 + 10\log_{10}(P[\text{Watts}])$ dB below the transmitter power $P(\text{Watts})$ in a 100kHz bandwidth. However, in the 1MHz bands immediately outside and adjacent to the licensee's frequency block, a resolution bandwidth of at least one percent of the emission bandwidth of the fundamental emission of the transmitter may be employed.

2. §24.238 (a)

For operations in the 1850-1910 and 1930-1990 MHz band, the FCC limit is $43 + 10\log_{10}(P[\text{Watts}])$ dB below the transmitter power $P(\text{Watts})$ in a 1MHz bandwidth. However, in the 1 MHz bands immediately outside and adjacent to the frequency block a resolution bandwidth of at least one percent of the emission bandwidth of the fundamental emission of the transmitter may be employed

3. §27.53 (h)

For operations in the 1710 – 1755 MHz band, the FCC limit is $43 + 10\log_{10}(P[\text{Watts}])$ dB below the transmitter power $P(\text{Watts})$ in a 1 MHz bandwidth. However, in the 1MHz bands immediately outside and adjacent to the licensee's frequency block, a resolution bandwidth of at least one percent of the emission bandwidth of the fundamental emission of the transmitter may be employed.

4. §27.53(m)(4)

For operations in the 2500 MHz ~ 2570 MHz band this section, the attenuation factor shall be not less than $40 + 10 \log (P)$ dB on all frequencies between the channel edge and 5 megahertz from the channel edge, $43 + 10 \log (P)$ dB on all frequencies between 5 megahertz and X megahertz from the channel edge, and $55 + 10 \log (P)$ dB on all frequencies more than X megahertz from the channel edge, where X is the greater of 6 megahertz or the actual emission bandwidth as defined in paragraph (m)(6) of this section. In addition, the attenuation factor shall not be less that $43 + 10 \log (P)$ dB on all frequencies between 2490.5 MHz and 2496 MHz and $55 + 10 \log (P)$ dB at or below 2490.5 MHz. Mobile Satellite Service licensees operating on frequencies below 2495 MHz may also submit a documented interference complaint against BRS licensees operating on channel BRS Channel 1 on the same terms and conditions as adjacent channel BRS or EBS licensees.

5. §27.53 (g)

For operations in the 698 -746 MHz band, the FCC limit is $43 + 10\log_{10}(P[\text{Watts}])$ dB below the transmitter power $P(\text{Watts})$ in a 100 kHz bandwidth. However, in the 100 kilohertz bands immediately outside and adjacent to a licensee's frequency block, a resolution bandwidth of at least 30 kHz may be employed.

7.1.2 TEST SETUP

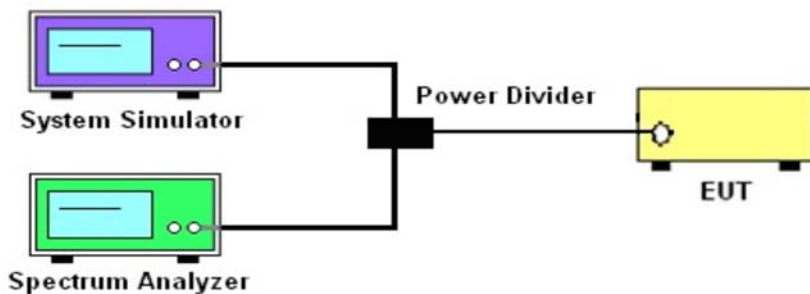

7.1.3 TEST PROCEDURES

1. The testing FCC KDB 971168 D01 v03r01 Section 6.0 and ANSI C63.26 2015 Section 5.7.
2. The EUT was connected to spectrum analyzer and system simulator via a power divider.
3. The band edges of low and high channels for the highest RF powers were measured. Set RBW $\geq 1\%$ EBW in the 1MHz band immediately outside and adjacent to the band edge.
4. Set spectrum analyzer with RMS/AVG detector.
5. The RF fundamental frequency should be excluded against the limit line in the operating frequency band.
6. The limit line is derived from $43 + 10\log(P)$ dB below the transmitter power P(Watts)

$$= P(W) - [43 + 10\log(P)] \text{ (dB)}$$

$$= [30 + 10\log(P)] \text{ (dBm)} - [43 + 10\log(P)] \text{ (dB)}$$

$$= -13\text{dBm}.$$

Band 7:

$$= P(W) - [55 + 10\log(P)] \text{ (dB)}$$

$$= [30 + 10\log(P)] \text{ (dBm)} - [55 + 10\log(P)] \text{ (dB)}$$

$$= -25\text{dBm}.$$

	LTE					
LTE BW	1.4M	3M	5M	10M	15M	20M
Span	12MHz	13MHz	15MHz	20MHz	25MHz	30MHz
RBW	30kHz	30kHz	100kHz	100kHz	300kHz	300kHz
VBW	100kHz	100kHz	300kHz	300kHz	1000kHz	1000kHz
Detector	RMS	RMS	RMS	RMS	RMS	RMS
Trace	Max	Max	Max	Max	Max	Max
Sweep Count	Auto	Auto	Auto	Auto	Auto	Auto

7.1.4 MEASUREMENT RESULT

Note: Test chart See Appendix B

8. CONDUCTED SPURIOUS EMISSION

8.1 DESCRIPTION OF CONDUCTED SPURIOUS EMISSION MEASUREMENT

8.1.1 MEASUREMENT METHOD

The power of any emission outside of the authorized operating frequency ranges must be lower than the transmitter power (P) by a factor of at least 43 + 10 log (P) dB.

For Band 7:

The power of any emission outside of the authorized operating frequency ranges must be lower than the transmitter power (P) by a factor of at least 55 + 10 log (P) dB.

It is measured by means of a calibrated spectrum analyzer and scanned from 30 MHz up to a frequency including its 10th harmonic.

8.1.2 TEST SETUP

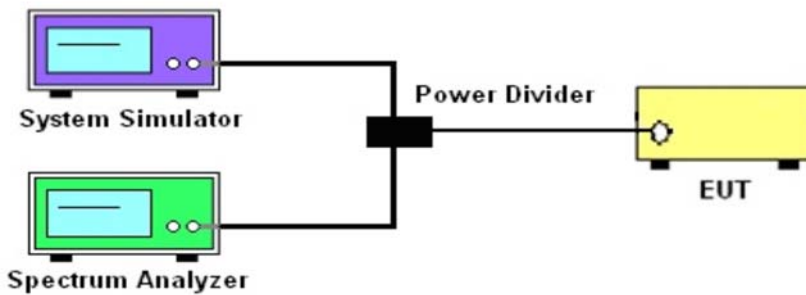

8.1.3 TEST PROCEDURES

1. The testing FCC KDB 971168 D01 v03r01 Section 6.0 and ANSI C63.26 2015 Section 5.7.
2. The EUT was connected to spectrum analyzer and system simulator via a power divider.
3. The RF output of EUT was connected to the spectrum analyzer by RF cable and attenuator. The path loss was compensated to the results for each measurement
4. Make the measurement with the spectrum analyzer's RBW = 1MHz, VBW = 3MHz, taking the record of maximum spurious emission.
5. The RF fundamental frequency should be excluded against the limit line in the operating frequency band.
6. The limit line is derived from $43 + 10\log(P)$ dB below the transmitter power P(Watts)
 $= P(W) - [43 + 10\log(P)] \text{ (dB)} = [30 + 10\log(P)] \text{ (dBm)} - [43 + 10\log(P)] \text{ (dB)}$
 $= -13\text{dBm}$.

For Band 7: $P(W) - [43 + 10\log(P)] \text{ (dB)} = -25\text{dBm}$

	LTE					
LTE BW	1.4M	3M	5M	10M	15M	20M
Span	Auto	Auto	Auto	Auto	Auto	Auto
RBW	1000kHz	1000kHz	1000kHz	1000kHz	1000kHz	1000kHz
VBW	3000kHz	3000kHz	3000kHz	3000kHz	3000kHz	3000kHz
Detector	PK	PK	PK	PK	PK	PK
Trace	Max	Max	Max	Max	Max	Max

8.1.4 TEST RESULTS

Note: Test chart See Appendix C

9. RADIATED SPURIOUS EMISSION

9.1 DESCRIPTION OF RADIATED SPURIOUS EMISSION

9.1.1 MEASUREMENT METHOD

The radiated spurious emission was measured by substitution method according to ANSI C63.26 2015. The power of any emission outside of the authorized operating frequency ranges must be attenuated below the transmitter power (P) by a factor of at least $43 + 10 \log (P)$ dB.

For Band 7 The power of any emission outside of the authorized operating frequency ranges must be attenuated below the transmitter power (P) by a factor of at least $55 + 10 \log (P)$ dB. The spectrum is scanned from 30 MHz up to a frequency including its 10th harmonic.

9.1.2 TEST SETUP

The procedure of radiated spurious emissions is as follows:

a) Pre-calibration With pre-calibration method, the Radiated Spurious Emissions(RSE) is calculated as, $RSE = Rx (dBuV) + CL (dB) + SA (dB) + Gain (dBi) - 107 (dBuV \text{ to } dBm)$ The SA is calibrated using following setup.

b) EUT was placed on 1.5 m non-conductive stand at a 3 m test distance from the receive antenna. A receiving antenna was placed on the antenna mast 3 m from the test item for emission measurements. The height of receiving antenna is 0.8m. The test setup refers to figure below. Detected emissions were maximized at each frequency by rotating the test item and adjusting the receiving antenna polarization. The radiated emission measurements of all non-harmonic and harmonics of the transmit frequency through the 10th harmonic measured with peak detector and 1MHz bandwidth.

Radiated emissions measurements were made only at the upper, middle, and lower carrier frequencies It was decided that measurements at these three carrier frequencies would be sufficient to demonstrate compliance with emissions limits because it was seen that all the significant spurs occur well outside the band and no radiation was seen from a carrier in one block of any band into any of the other blocks.

The substitution method is used. Substitution values at each frequency are measured before and saved to the test software. A "reference path loss" is established and the ARpl is the attenuation of "reference path loss", and including the gain of receive antenna, the gain of the preamplifier, the cable loss and the air loss. The measurement results are obtained as described below:

$$Power = P_{Mea} + AR_{pl}$$

For radiated test from 30MHz to 1GHz

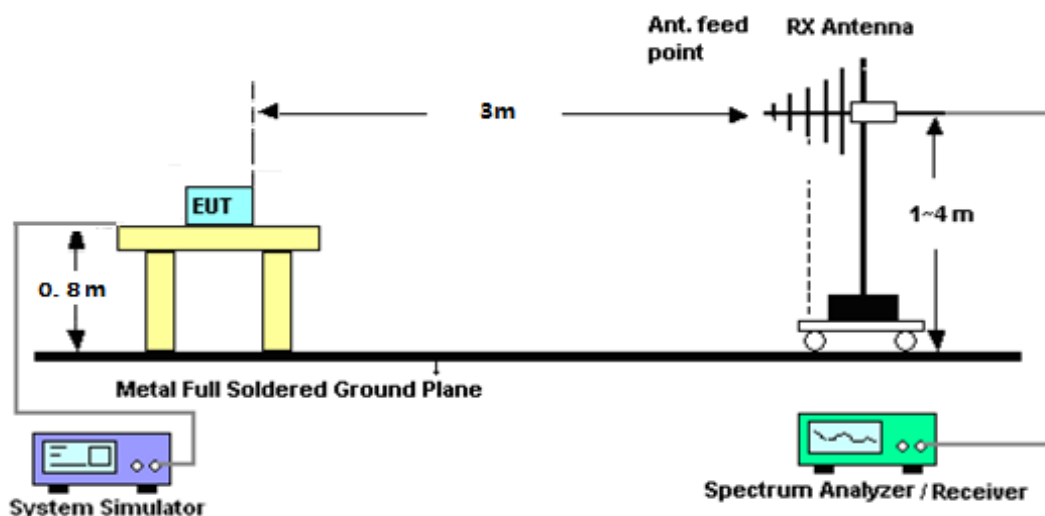

For radiated test from above 1GHz

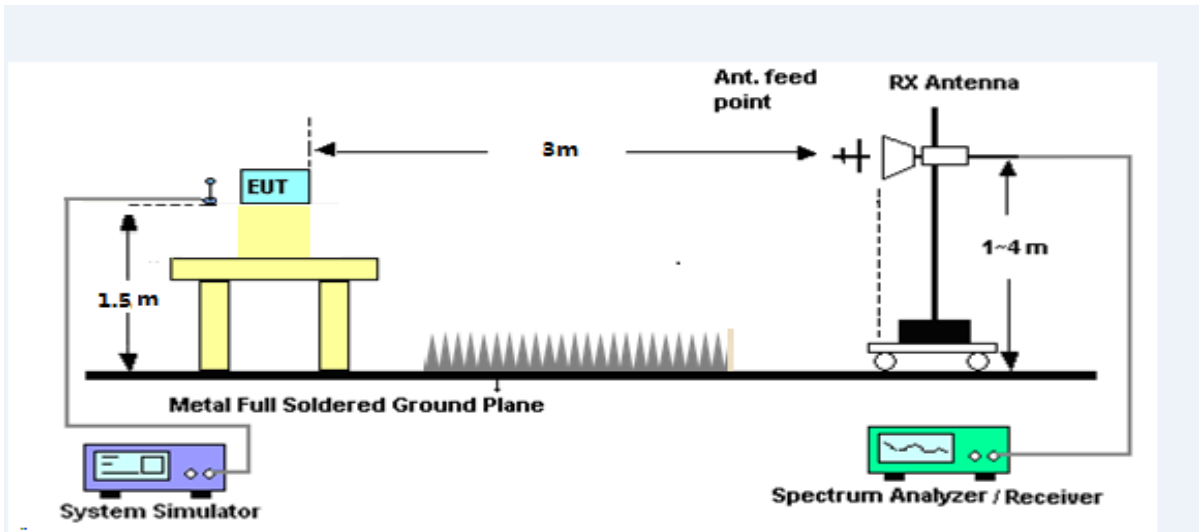

9.1.3 TEST PROCEDURES

1. The testing FCC KDB 971168 D01 Section 7 and ANSI C63.26 2015 Section 5.5.
2. The EUT was placed on a rotatable wooden table with 1.5 meter above ground.
3. The EUT was set 3 meters from the receiving antenna, which was mounted on the antenna tower.
4. The table was rotated 360 degrees to determine the position of the highest spurious emission.
5. The height of the receiving antenna is varied between one meter and four meters to search the maximum spurious emission for both horizontal and vertical polarizations
6. Make the measurement with the spectrum analyzer's RBW = 1MHz, VBW = 3MHz, taking the record of maximum spurious emission.
7. A horn antenna was substituted in place of the EUT and was driven by a signal generator.
8. Tune the output power of signal generator to the same emission level with EUT maximum spurious emission.
9. Taking the record of output power at antenna port.
10. Repeat step 7 to step 8 for another polarization.
11. The RF fundamental frequency should be excluded against the limit line in the operating frequency band.

The limit line is derived from $43 + 10\log(P)$ dB below the transmitter power P(Watts)
 $= P(W) - [43 + 10\log(P)]$ (dB)
 $= [30 + 10\log(P)]$ (dBm) - $[43 + 10\log(P)]$ (dB)
 $= -13$ dBm

For Band 7:

The limit line is derived from $55 + 10\log(P)$ dB below the transmitter power P(Watts)
 $= [30 + 10\log(P)]$ (dBm) - $[55 + 10\log(P)]$ (dB)
 $= -25$ dBm

$P_{Mea} = S.G \text{ Level} + \text{Ant-Cable loss}; \text{Margin} = P_{Mea} - \text{Limit.}$



9.1.4 TEST RESULTS

LTE Band 4 / 1.4MHz / QPSK / RB Size 1 Offset 0/ The Worst Test Results for Lowest							
Frequency(MHz)	S G.Lev (dBm)	Ant(dBi)	Loss	PMea (dBm)	Limit (dBm)	Margin (dBm)	Polarity
3421.02	-33.73	12.90	12.56	-33.39	-13.00	-20.39	H
5131.94	-34.79	13.10	16.32	-38.01	-13.00	-25.01	H
6842.34	-32.43	12.33	21.13	-41.23	-13.00	-28.23	H
3421.02	-35.24	12.90	12.56	-34.90	-13.00	-21.90	V
5131.94	-34.69	13.10	16.32	-37.91	-13.00	-24.91	V
6842.34	-32.81	12.33	21.13	-41.61	-13.00	-28.61	V
LTE Band 4 / 1.4MHz / QPSK / RB Size 1 Offset 0/ The Worst Test Results for Middle							
Frequency(MHz)	S G.Lev (dBm)	Ant(dBi)	Loss	PMea (dBm)	Limit (dBm)	Margin (dBm)	Polarity
3464.74	-33.97	12.90	12.56	-33.63	-13.00	-20.63	H
5196.88	-34.85	13.10	16.32	-38.07	-13.00	-25.07	H
6930.01	-32.89	12.33	21.13	-41.69	-13.00	-28.69	H
3464.74	-35.24	12.90	12.56	-34.90	-13.00	-21.90	V
5196.88	-34.95	13.10	16.32	-38.17	-13.00	-25.17	V
6930.01	-32.94	12.33	21.13	-41.74	-13.00	-28.74	V
LTE Band 4 / 1.4MHz / QPSK / RB Size 1 Offset 0/ The Worst Test Results for Highest							
Frequency(MHz)	S G.Lev (dBm)	Ant(dBi)	Loss	PMea (dBm)	Limit (dBm)	Margin (dBm)	Polarity
3508.23	-34.80	12.90	12.56	-34.46	-13.00	-21.46	H
5262.44	-34.79	13.10	16.32	-38.01	-13.00	-25.01	H
7015.68	-32.25	12.33	21.13	-41.05	-13.00	-28.05	H
3508.23	-35.91	12.90	12.56	-35.57	-13.00	-22.57	V
5262.44	-35.02	13.10	16.32	-38.24	-13.00	-25.24	V
7015.68	-33.20	12.33	21.13	-42.00	-13.00	-29.00	V



LTE Band 4 / 3MHz / QPSK / RB Size 1 Offset 0/ The Worst Test Results for Lowest							
Frequency(MHz)	S G.Lev (dBm)	Ant(dBi)	Loss	PMea	Limit	Margin	Polarity
				(dBm)	(dBm)	(dBm)	
3424.02	-33.60	12.90	12.56	-33.26	-13.00	-20.26	H
5136.18	-34.00	13.10	16.32	-37.22	-13.00	-24.22	H
6848.36	-32.85	12.33	21.13	-41.65	-13.00	-28.65	H
3424.02	-35.20	12.90	12.56	-34.86	-13.00	-21.86	V
5136.18	-34.27	13.10	16.32	-37.49	-13.00	-24.49	V
6848.36	-32.16	12.33	21.13	-40.96	-13.00	-27.96	V
LTE Band 4 / 3MHz / QPSK / RB Size 1 Offset 0/ The Worst Test Results for Middle							
Frequency(MHz)	S G.Lev (dBm)	Ant(dBi)	Loss	PMea	Limit	Margin	Polarity
				(dBm)	(dBm)	(dBm)	
3464.94	-34.79	12.90	12.56	-34.45	-13.00	-21.45	H
5196.85	-35.43	13.10	16.32	-38.65	-13.00	-25.65	H
6929.95	-33.49	12.33	21.13	-42.29	-13.00	-29.29	H
3464.94	-35.77	12.90	12.56	-35.43	-13.00	-22.43	V
5196.85	-34.30	13.10	16.32	-37.52	-13.00	-24.52	V
6929.95	-32.41	12.33	21.13	-41.21	-13.00	-28.21	V
LTE Band 4 / 3MHz / QPSK / RB Size 1 Offset 0/ The Worst Test Results for Highest							
Frequency(MHz)	S G.Lev (dBm)	Ant(dBi)	Loss	PMea	Limit	Margin	Polarity
				(dBm)	(dBm)	(dBm)	
3506.10	-34.06	12.90	12.56	-33.72	-13.00	-20.72	H
5261.70	-34.85	13.10	16.32	-38.07	-13.00	-25.07	H
7012.68	-33.50	12.33	21.13	-42.30	-13.00	-29.30	H
3506.10	-35.37	12.90	12.56	-35.03	-13.00	-22.03	V
5261.70	-34.01	13.10	16.32	-37.23	-13.00	-24.23	V
7012.68	-31.96	12.33	21.13	-40.76	-13.00	-27.76	V



LTE Band 4 / 5MHz / QPSK / RB Size 1 Offset 0/ The Worst Test Results for Lowest							
Frequency(MHz)	S G.Lev (dBm)	Ant(dBi)	Loss	PMea	Limit	Margin	Polarity
				(dBm)	(dBm)	(dBm)	
3424.69	-34.04	12.90	12.56	-33.70	-13.00	-20.70	H
5137.29	-34.33	13.10	16.32	-37.55	-13.00	-24.55	H
6849.78	-32.38	12.33	21.13	-41.18	-13.00	-28.18	H
3424.69	-35.79	12.90	12.56	-35.45	-13.00	-22.45	V
5137.29	-34.43	13.10	16.32	-37.65	-13.00	-24.65	V
6849.78	-32.52	12.33	21.13	-41.32	-13.00	-28.32	V
LTE Band 4 / 5MHz / QPSK / RB Size 1 Offset 0/ The Worst Test Results for Middle							
Frequency(MHz)	S G.Lev (dBm)	Ant(dBi)	Loss	PMea	Limit	Margin	Polarity
				(dBm)	(dBm)	(dBm)	
3464.72	-34.21	12.90	12.56	-33.87	-13.00	-20.87	H
5196.66	-34.91	13.10	16.32	-38.13	-13.00	-25.13	H
6929.58	-32.15	12.33	21.13	-40.95	-13.00	-27.95	H
3464.72	-34.53	12.90	12.56	-34.19	-13.00	-21.19	V
5196.66	-34.42	13.10	16.32	-37.64	-13.00	-24.64	V
6929.58	-31.98	12.33	21.13	-40.78	-13.00	-27.78	V
LTE Band 4 / 5MHz / QPSK / RB Size 1 Offset 0/ The Worst Test Results for Highest							
Frequency(MHz)	S G.Lev (dBm)	Ant(dBi)	Loss	PMea	Limit	Margin	Polarity
				(dBm)	(dBm)	(dBm)	
3505.25	-34.64	12.90	12.56	-34.30	-13.00	-21.30	H
5257.07	-34.54	13.10	16.32	-37.76	-13.00	-24.76	H
7010.04	-33.62	12.33	21.13	-42.42	-13.00	-29.42	H
3505.25	-35.14	12.90	12.56	-34.80	-13.00	-21.80	V
5257.07	-34.30	13.10	16.32	-37.52	-13.00	-24.52	V
7010.04	-32.00	12.33	21.13	-40.80	-13.00	-27.80	V



LTE Band 4 / 10MHz / QPSK / RB Size 1 Offset 0/ The Worst Test Results for Lowest							
Frequency(MHz)	S G.Lev (dBm)	Ant(dBi)	Loss	PMea	Limit	Margin	Polarity
				(dBm)	(dBm)	(dBm)	
3429.90	-34.46	12.90	12.56	-34.12	-13.00	-21.12	H
5145.12	-34.39	13.10	16.32	-37.61	-13.00	-24.61	H
6860.51	-32.63	12.33	21.13	-41.43	-13.00	-28.43	H
3429.90	-34.83	12.90	12.56	-34.49	-13.00	-21.49	V
5145.12	-35.18	13.10	16.32	-38.40	-13.00	-25.40	V
6860.51	-32.13	12.33	21.13	-40.93	-13.00	-27.93	V
LTE Band 4 / 10MHz / QPSK / RB Size 1 Offset 0/ The Worst Test Results for Middle							
Frequency(MHz)	S G.Lev (dBm)	Ant(dBi)	Loss	PMea	Limit	Margin	Polarity
				(dBm)	(dBm)	(dBm)	
3464.44	-34.73	12.90	12.56	-34.39	-13.00	-21.39	H
5196.39	-34.95	13.10	16.32	-38.17	-13.00	-25.17	H
6929.52	-32.51	12.33	21.13	-41.31	-13.00	-28.31	H
3464.44	-35.90	12.90	12.56	-35.56	-13.00	-22.56	V
5196.39	-33.90	13.10	16.32	-37.12	-13.00	-24.12	V
6929.52	-33.03	12.33	21.13	-41.83	-13.00	-28.83	V
LTE Band 4 / 10MHz / QPSK / RB Size 1 Offset 0/ The Worst Test Results for Highest							
Frequency(MHz)	S G.Lev (dBm)	Ant(dBi)	Loss	PMea	Limit	Margin	Polarity
				(dBm)	(dBm)	(dBm)	
3500.20	-34.59	12.90	12.56	-34.25	-13.00	-21.25	H
5250.24	-35.38	13.10	16.32	-38.60	-13.00	-25.60	H
7000.01	-33.39	12.33	21.13	-42.19	-13.00	-29.19	H
3500.20	-35.17	12.90	12.56	-34.83	-13.00	-21.83	V
5250.24	-34.57	13.10	16.32	-37.79	-13.00	-24.79	V
7000.01	-32.35	12.33	21.13	-41.15	-13.00	-28.15	V



LTE Band 4 / 15MHz / QPSK / RB Size 1 Offset 0/ The Worst Test Results for Lowest							
Frequency(MHz)	S G.Lev (dBm)	Ant(dBi)	Loss	PMea	Limit	Margin	Polarity
				(dBm)	(dBm)	(dBm)	
3435.08	-34.72	12.90	12.56	-34.38	-13.00	-21.38	H
5152.55	-35.36	13.10	16.32	-38.58	-13.00	-25.58	H
6870.36	-32.81	12.33	21.13	-41.61	-13.00	-28.61	H
3435.08	-34.90	12.90	12.56	-34.56	-13.00	-21.56	V
5152.55	-33.88	13.10	16.32	-37.10	-13.00	-24.10	V
6870.36	-31.72	12.33	21.13	-40.52	-13.00	-27.52	V
LTE Band 4 / 15MHz / QPSK / RB Size 1 Offset 0/ The Worst Test Results for Middle							
Frequency(MHz)	S G.Lev (dBm)	Ant(dBi)	Loss	PMea	Limit	Margin	Polarity
				(dBm)	(dBm)	(dBm)	
3464.93	-34.48	12.90	12.56	-34.14	-13.00	-21.14	H
5196.59	-35.22	13.10	16.32	-38.44	-13.00	-25.44	H
6929.79	-32.19	12.33	21.13	-40.99	-13.00	-27.99	H
3464.93	-35.84	12.90	12.56	-35.50	-13.00	-22.50	V
5196.59	-35.10	13.10	16.32	-38.32	-13.00	-25.32	V
6929.79	-33.17	12.33	21.13	-41.97	-13.00	-28.97	V
LTE Band 4 / 15MHz / QPSK / RB Size 1 Offset 0/ The Worst Test Results for Highest							
Frequency(MHz)	S G.Lev (dBm)	Ant(dBi)	Loss	PMea	Limit	Margin	Polarity
				(dBm)	(dBm)	(dBm)	
3495.46	-33.86	12.90	12.56	-33.52	-13.00	-20.52	H
5242.11	-34.63	13.10	16.32	-37.85	-13.00	-24.85	H
6990.35	-33.05	12.33	21.13	-41.85	-13.00	-28.85	H
3495.46	-34.70	12.90	12.56	-34.36	-13.00	-21.36	V
5242.11	-34.49	13.10	16.32	-37.71	-13.00	-24.71	V
6990.35	-32.23	12.33	21.13	-41.03	-13.00	-28.03	V



LTE Band 4 / 20MHz / QPSK / RB Size 1 Offset 0/ The Worst Test Results for Lowest							
Frequency(MHz)	S G.Lev (dBm)	Ant(dBi)	Loss	PMea	Limit	Margin	Polarity
				(dBm)	(dBm)	(dBm)	
3440.22	-34.35	12.90	12.56	-34.01	-13.00	-21.01	H
5160.12	-34.86	13.10	16.32	-38.08	-13.00	-25.08	H
6880.42	-32.25	12.33	21.13	-41.05	-13.00	-28.05	H
3440.22	-35.44	12.90	12.56	-35.10	-13.00	-22.10	V
5160.12	-33.78	13.10	16.32	-37.00	-13.00	-24.00	V
6880.42	-32.24	12.33	21.13	-41.04	-13.00	-28.04	V
LTE Band 4 / 20MHz / QPSK / RB Size 1 Offset 0/ The Worst Test Results for Middle							
Frequency(MHz)	S G.Lev (dBm)	Ant(dBi)	Loss	PMea	Limit	Margin	Polarity
				(dBm)	(dBm)	(dBm)	
3464.60	-34.93	12.90	12.56	-34.59	-13.00	-21.59	H
5196.79	-34.53	13.10	16.32	-37.75	-13.00	-24.75	H
6929.62	-33.43	12.33	21.13	-42.23	-13.00	-29.23	H
3464.60	-35.65	12.90	12.56	-35.31	-13.00	-22.31	V
5196.79	-34.32	13.10	16.32	-37.54	-13.00	-24.54	V
6929.62	-31.81	12.33	21.13	-40.61	-13.00	-27.61	V
LTE Band 4 / 20MHz / QPSK / RB Size 1 Offset 0/ The Worst Test Results for Highest							
Frequency(MHz)	S G.Lev (dBm)	Ant(dBi)	Loss	PMea	Limit	Margin	Polarity
				(dBm)	(dBm)	(dBm)	
3490.24	-34.15	12.90	12.56	-33.81	-13.00	-20.81	H
5235.25	-34.68	13.10	16.32	-37.90	-13.00	-24.90	H
6979.61	-33.01	12.33	21.13	-41.81	-13.00	-28.81	H
3490.24	-35.58	12.90	12.56	-35.24	-13.00	-22.24	V
5235.25	-33.92	13.10	16.32	-37.14	-13.00	-24.14	V
6979.61	-33.00	12.33	21.13	-41.80	-13.00	-28.80	V

10. FREQUENCY STABILITY

10.1 DESCRIPTION OF FREQUENCY STABILITY MEASUREMENT

10.1.1 MEASUREMENT METHOD

The frequency stability shall be measured by variation of ambient temperature and variation of primary supply voltage to ensure that the fundamental emission stays within the authorized frequency block. The frequency stability of the transmitter shall be maintained within $\pm 0.00025\%$ ($\pm 2.5\text{ppm}$) of the center frequency.

10.1.2 TEST SETUP

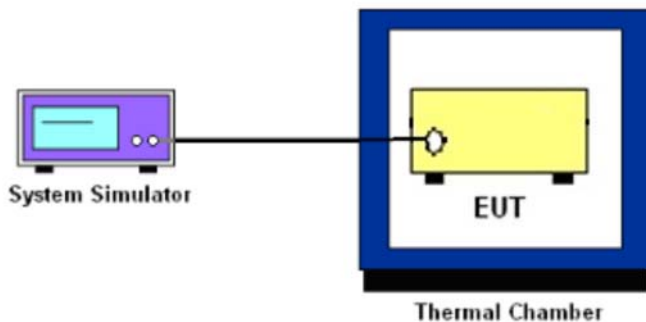

10.1.3 TEST PROCEDURES FOR TEMPERATURE VARIATION

1. The EUT was set up in the thermal chamber and connected with the system simulator.
2. With power OFF, the temperature was decreased to -30°C and the EUT was stabilized before testing. Power was applied and the maximum change in frequency was recorded within one minute.
3. With power OFF, the temperature was raised in 10°C step up to 50°C . The EUT was stabilized at each step for at least half an hour. Power was applied and the maximum frequency change was recorded within one minute.

10.1.4 TEST PROCEDURES FOR VOLTAGE VARIATION

1. The testing follows FCC KDB 971168 D01v01r03 Section 9.
2. The EUT was placed in a temperature chamber at $25\pm 5^{\circ}\text{C}$ and connected with the system simulator.
3. The power supply voltage to the EUT was varied from 85% to 115% of the nominal value measured at the input to the EUT.
4. The variation in frequency was measured for the worst case.



10.1.5 TEST RESULTS

LTE Band 4 (QPSK) / 1733MHz / BW10M					
Temperature (°C)	Voltage	Freq. Dev.	Freq. Dev.	Limit	Result
	(Volt)	(Hz)	(ppm)		
50	Normal Voltage	33.36	0.019	2.5ppm	PASS
40		31.12	0.018		
30		24.26	0.014		
20		13.29	0.008		
10		31.75	0.018		
0		18.43	0.011		
-10		35.65	0.021		
-20		23.31	0.013		
-30		36.02	0.021		
20		Maximum Voltage	17.50		
20	BEP	20.44	0.012		

LTE Band 4 (QPSK) / 1733MHz / BW20M					
Temperature (°C)	Voltage	Freq. Dev.	Freq. Dev.	Limit	Result
	(Volt)	(Hz)	(ppm)		
50	Normal Voltage	14.64	0.008	2.5ppm	PASS
40		27.15	0.016		
30		28.80	0.017		
20		34.66	0.020		
10		24.53	0.014		
0		12.45	0.007		
-10		20.24	0.012		
-20		24.50	0.014		
-30		24.93	0.014		
20		Maximum Voltage	21.46		
20	BEP	24.57	0.014		



APPENDIX-PHOTOS OF TEST SETUP

Note: See test photos in setup photo document for the actual connections between Product and support equipment.

*****END OF THE REPORT*****

