

S

T

S

L

A

B



RADIO TEST REPORT

Report No: STS1604060F04

Issued for

XTR S.A.C.

Av. Camino Real 1225 Of. 201 A - San Isidro, Lima - Perú

Product Name:	Smartphone
Brand Name:	EKS
Model Name:	X4
Series Model:	N/A
FCC ID:	2AGAK-X4
Test Standard:	FCC Part 15.247

Any reproduction of this document must be done in full. No single part of this document may be reproduced without permission from STS, All Test Data Presented in this report is only applicable to presented Test sample.

Shenzhen STS Test Services Co., Ltd.
1/F., Building B, Zhuoke Science Park, No.190,Chongqing Road,
Fuyong Street, Bao'an District, Shenzhen, Guangdong,China
TEL: +86-755 3688 6288 FAX: +86-755 3688 6277 E-mail:sts@stsapp.com





TEST RESULT CERTIFICATION

Applicant's name.....: XTR S.A.C.

Address: Av. Camino Real 1225 Of. 201 A - San Isidro, Lima - Perú

Manufacturer's Name: Shenzhen Richpad Communication Technology Co.,LTD

Address: Room 315, HKUST SZ IER Building, No. 9 Yuexing 1st RD, South Area, Hi-tech Park, Nanshan, Shenzhen, P.R.C

Product description

Product name: Smartphone

Model and/or type reference .: X4

Series Model.....: N/A

Standards.....: FCC Part15.247

Test procedure..... ANSI C63.10-2013

This device described above has been tested by STS, and the test results show that the equipment under test (EUT) is in compliance with the FCC requirements. And it is applicable only to the tested sample identified in the report.

This report shall not be reproduced except in full, without the written approval of STS, this document may be altered or revised by STS, personal only, and shall be noted in the revision of the document.

Date of Test.....

Date (s) of performance of tests..... 12 Apr. 2016 ~21 Apr. 2016

Date of Issue 22 Apr. 2016

Test Result **Pass**

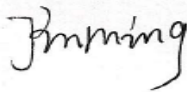
Testing Engineer : 

(Jin Ming)

Technical Manager : 

(Vita Li)

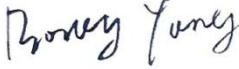
Authorized Signatory : 

(Bovey Yang)





Table of Contents	Page
1. SUMMARY OF TEST RESULTS	5
1.1 TEST FACTORY	5
1.2 MEASUREMENT UNCERTAINTY	6
2. GENERAL INFORMATION	7
2.1 GENERAL DESCRIPTION OF EUT	7
2.2 DESCRIPTION OF TEST MODES	9
2.3 BLOCK DIGRAM SHOWING THE CONFIGURATION OF SYSTEM TESTED	10
2.4 DESCRIPTION OF SUPPORT UNITS(CONDUCTED MODE)	11
2.5 EQUIPMENTS LIST FOR ALL TEST ITEMS	12
3. EMC EMISSION TEST	13
3.1 CONDUCTED EMISSION MEASUREMENT	13
3.2 TEST PROCEDURE	14
3.3 TEST SETUP	14
3.4 EUT OPERATING CONDITIONS	14
3.5 TEST RESULTS	15
4. RADIATED EMISSION MEASUREMENT	17
4.1 RADIATED EMISSION LIMITS	17
4.2 TEST PROCEDURE	18
4.3 TEST SETUP	19
4.4 EUT OPERATING CONDITIONS	19
4.5 TEST RESULTS	20
4.6 TEST RESULTS (RESTRICTED BANDS REQUIREMENTS)	29
5. CONDUCTED SPURIOUS & BAND EDGE EMISSION	30
5.1 REQUIREMENT	30
5.2 TEST PROCEDURE	30
5.3 TEST SETUP	30
5.4 EUT OPERATION CONDITIONS	30
5.5 TEST RESULTS	31
6. POWER SPECTRAL DENSITY TEST	34
6.1 APPLIED PROCEDURES / LIMIT	34
6.2 TEST PROCEDURE	34
6.3 TEST SETUP	34



Table of Contents	Page
6.4 EUT OPERATION CONDITIONS	34
6.5 TEST RESULTS	35
7. BANDWIDTH TEST	37
7.1 APPLIED PROCEDURES / LIMIT	37
7.2 TEST PROCEDURE	37
7.3 TEST SETUP	37
7.4 EUT OPERATION CONDITIONS	37
7.5 TEST RESULTS	38
8. PEAK OUTPUT POWER TEST	40
8.1 APPLIED PROCEDURES / LIMIT	40
8.2 TEST PROCEDURE	40
8.3 TEST SETUP	40
8.4 EUT OPERATION CONDITIONS	40
8.5 TEST RESULTS	41
9. ANTENNA REQUIREMENT	42
9.1 STANDARD REQUIREMENT	42
9.2 EUT ANTENNA	42
10. EUT TEST PHOTO	43



1. SUMMARY OF TEST RESULTS

Test procedures according to the technical standards:
KDB 558074 D01 DTS Meas Guidance v03r04

FCC Part15 (15.247) , Subpart C			
Standard Section	Test Item	Judgment	Remark
15.207	Conducted Emission	PASS	--
15.247 (a)(2)	6dB Bandwidth	PASS	--
15.247 (b)(3)	Output Power	PASS	--
15.247 (c)	Radiated Spurious Emission	PASS	--
15.247 (d)	Conducted Spurious & Band Edge Emission	PASS	--
15.247 (e)	Power Spectral Density	PASS	--
15.205	Band Edge Emission	PASS	--
15.203	Antenna Requirement	PASS	--

NOTE:

(1) "N/A" denotes test is not applicable in this Test Report

(2) all tests are according to ANSI C63.10-2013

1.1 TEST FACTORY

Shenzhen STS Test Services Co., Ltd.

Add. : 1/F., Building B, Zhuoke Science Park, No.190,Chongqing Road,
Fuyong Street, Bao'an District, Shenzhen, Guangdong,China

CNAS Registration No.: L7649;

FCC Registration No.: 842334; IC Registration No.: 12108A-1



1.2 MEASUREMENT UNCERTAINTY

The reported uncertainty of measurement $y \pm U$, where expanded uncertainty U is based on a standard uncertainty multiplied by a coverage factor of $k=2$, providing a level of confidence of approximately **95 %**.

No.	Item	Uncertainty
1	Conducted Emission (9KHz-150KHz)	$\pm 2.88\text{dB}$
2	Conducted Emission (150KHz-30MHz)	$\pm 2.67\text{dB}$
3	RF power,conducted	$\pm 0.70\text{dB}$
4	Spurious emissions,conducted	$\pm 1.19\text{dB}$
5	All emissions,radiated(<30M) (9KHz-30MHz)	$\pm 2.45\text{dB}$
6	All emissions,radiated(<1G) 30MHz-200MHz	$\pm 2.83\text{dB}$
7	All emissions,radiated(<1G) 200MHz-1000MHz	$\pm 2.94\text{dB}$
8	All emissions,radiated(>1G)	$\pm 3.03\text{dB}$
9	Temperature	$\pm 0.5^{\circ}\text{C}$
10	Humidity	$\pm 2\%$



2. GENERAL INFORMATION

2.1 GENERAL DESCRIPTION OF EUT

Equipment	Smartphone	
Trade Name	EKS	
Model Name	X4	
Series Model	N/A	
Model Difference	N/A	
Product Description	The EUT is a Smartphone	
	Operation Frequency:	2402~2480 MHz
	Modulation Type:	GFSK
	Radio Technology	BLE
	Number Of Channel	40
	Antenna Designation:	Please see Note 3.
	Antenna Gain (dBi)	3 dBi
	Duty Cycle	>98%
Channel List	Please refer to the Note 2.	
Adapter	Input: AC100-240V, 150mA, 50/60 Hz Output: DC 5V, 500mA	
Battery	Rated Voltage: 3.7V capacity :1350mAh	
Hardware version number	S8-MB-V0.3A	
Software version number	N/A	
Connecting I/O Port(s)	Please refer to the User's Manual	

Note:

1. For a more detailed features description, please refer to the manufacturer's specifications or the User's Manual.



2.

Channel List							
Channel	Frequency (MHz)	Channel	Frequency (MHz)	Channel	Frequency (MHz)	Channel	Frequency (MHz)
01	2402	11	2422	21	2442	31	2462
02	2404	12	2424	22	2444	32	2464
03	2406	13	2426	23	2446	33	2466
04	2408	14	2428	24	2448	34	2468
05	2410	15	2430	25	2450	35	2470
06	2412	16	2432	26	2452	36	2472
07	2414	17	2434	27	2454	37	2474
08	2416	18	2436	28	2456	38	2476
09	2418	19	2438	29	2458	39	2478
10	2420	20	2440	30	2460	40	2480

3.

Table for Filed Antenna

Ant.	Brand	Model Name	Antenna Type	Connector	Gain (dBi)	NOTE
A	EKS	X4	PIFA Antenna	N/A	3	BT 4.0 ANT



2.2 DESCRIPTION OF TEST MODES

For conducted test items and radiated spurious emissions
Each of these EUT operation mode(s) or test configuration mode(s) mentioned below was evaluated respectively..

Pretest Mode	Description	Data/Modulation
Mode 1	TX CH1(2402MHz)	1 MHz/GFSK
Mode 2	TX CH20(2440MHz)	1 MHz/GFSK
Mode 3	TX CH40(2480MHz)	1 MHz/GFSK

Note:

- (1) All above mode have been measurement, only worst data was reported.
- (2) We have be tested for all avaiable U.S. voltage and frequencies(For 120V,50/60Hz and 240V, 50/60Hz) for which the device is capable of operation.
- (3) The EUT was programmed to be in continuously transmitting mode and the transmit duty cycle is not less than 98%.

For AC Conducted Emission

Test Case	
AC Conducted Emission	Mode 4 : Keeping BT TX

2.3 BLOCK DIGRAM SHOWING THE CONFIGURATION OF SYSTEM TESTED

Radiated Spurious Emission Test

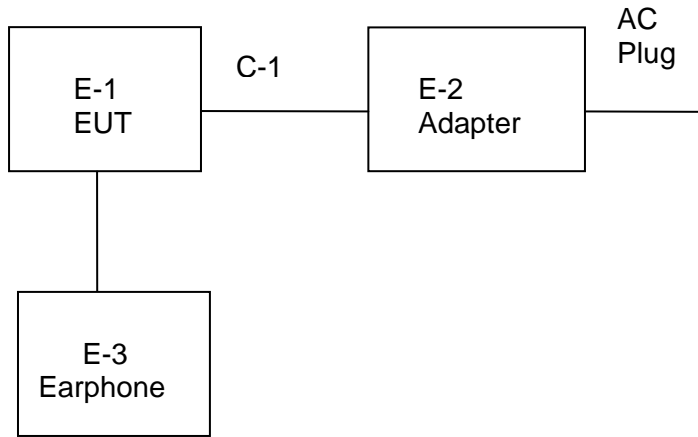

Conducted Emission Test

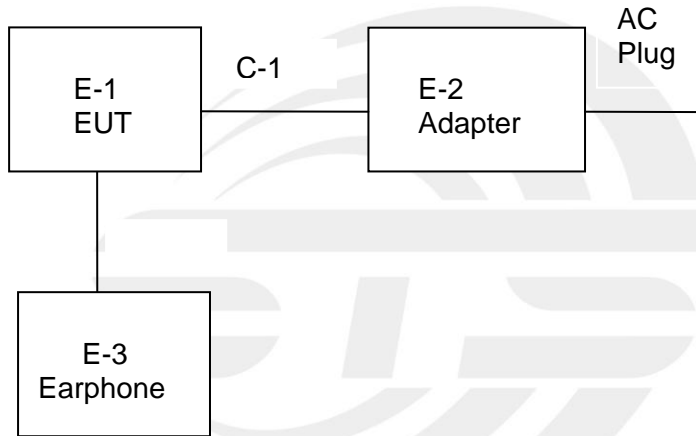



2.4 DESCRIPTION OF SUPPORT UNITS(CONDUCTED MODE)

The EUT has been tested as an independent unit together with other necessary accessories or support units. The following support units or accessories were used to form a representative test configuration during the tests.

Item	Equipment	Mfr/Brand	Model/Type No.	Serial No.	Note
E-1	Smartphone	EKS	X4	N/A	EUT
E-2	Adapter	EKS	X4	N/A	EUT
E-3	Earphone	N/A	N/A	N/A	EUT

Item	Shielded Type	Ferrite Core	Length	Note
C-1	USB Cable unshielded	NO	100cm	N/A

Note:

- (1) The support equipment was authorized by Declaration of Confirmation.
- (2) For detachable type I/O cable should be specified the length in cm in 『Length』 column.



2.5 EQUIPMENTS LIST FOR ALL TEST ITEMS

Radiation Test equipment

Kind of Equipment	Manufacturer	Type No.	Serial No.	Last calibration	Calibrated until
Spectrum Analyzer	Agilent	E4407B	MY50140340	2015.10.25	2016.10.24
Test Receiver	R&S	ESCI	101427	2015.10.25	2016.10.24
Bilog Antenna	TESEQ	CBL6111D	34678	2015.11.25	2016.11.24
Horn Antenna	Schwarzbeck	BBHA 9120D	9120D-1343	2016.03.06	2017.03.05
Horn Antenna	Schwarzbeck	BBHA 9170	9170-0741	2016.03.06	2017.03.05
50Ω Coaxial Switch	Anritsu	MP59B	6200264416	2015.06.06	2016.06.05
PreAmplifier	Agilent	8449B	60538	2015.10.25	2016.10.24
Loop Antenna	ARA	PLA-1030/B	1029	2015.06.08	2016.06.07
Preamplifier	Agilent	8449B	60538	2015.11.05	2016.11.05
Low frequency cable	EM	R01	N/A	N/A	N/A
High frequency cable	SCHWARZBECK	AK9515H	SN-96286/96287	N/A	N/A

Conduction Test equipment

Kind of Equipment	Manufacturer	Type No.	Serial No.	Last calibration	Calibrated until
EMI Test Receiver	R&S	ESPI	102086	2015.11.20	2016.11.19
LISN	R&S	ENV216	101242	2015.10.25	2016.10.24
LISN	EMCO	3810/2NM	000-23625	2015.10.25	2016.10.24
Conduction Cable	EM	C01	N/A	N/A	N/A

RF Connected Test

Kind of Equipment	Manufacturer	Type No.	Serial No.	Last calibration	Calibrated until
USB RF power sensor	DARE	RPR3006W	15I00041SNO03	2015.10.25	2016.10.24
Spectrum Analyzer	Agilent	E4407B	MY50140340	2015.10.25	2016.10.24
Signal Analyzer	Agilent	N9020A	MY49100060	2015.11.18	2016.11.17



3. EMC EMISSION TEST

3.1 CONDUCTED EMISSION MEASUREMENT

3.1.1 POWER LINE CONDUCTED EMISSION LIMITS

operating frequency band. In case the emission fall within the restricted band specified on Part 15.247&207(a) limit in the table below has to be followed.

FREQUENCY (MHz)	Conducted Emission limit (dBuV)	
	Quasi-peak	Average
0.15 -0.5	66 - 56 *	56 - 46 *
0.50 -5.0	56.00	46.00
5.0 -30.0	60.00	50.00

Note:

- (1) The tighter limit applies at the band edges.
- (2) The limit of " * " marked band means the limitation decreases linearly with the logarithm of the frequency in the range.

The following table is the setting of the receiver

Receiver Parameters	Setting
Attenuation	10 dB
Start Frequency	0.15 MHz
Stop Frequency	30 MHz
IF Bandwidth	9 kHz

3.2 TEST PROCEDURE

- a. The EUT was placed 0.4 meters from the horizontal ground plane with EUT being connected to the power mains through a line impedance stabilization network (LISN). All other support equipments powered from additional LISN(s). The LISN provide 50 Ohm/ 50uH of coupling impedance for the measuring instrument.
- b. Interconnecting cables that hang closer than 40 cm to the ground plane shall be folded back and forth in the center forming a bundle 30 to 40 cm long.
- c. I/O cables that are not connected to a peripheral shall be bundled in the center. The end of the cable may be terminated, if required, using the correct terminating impedance. The overall length shall not exceed 1 m.
- d. LISN at least 80 cm from nearest part of EUT chassis.
- e. For the actual test configuration, please refer to the related Item –EUT Test Photos.

3.3 TEST SETUP

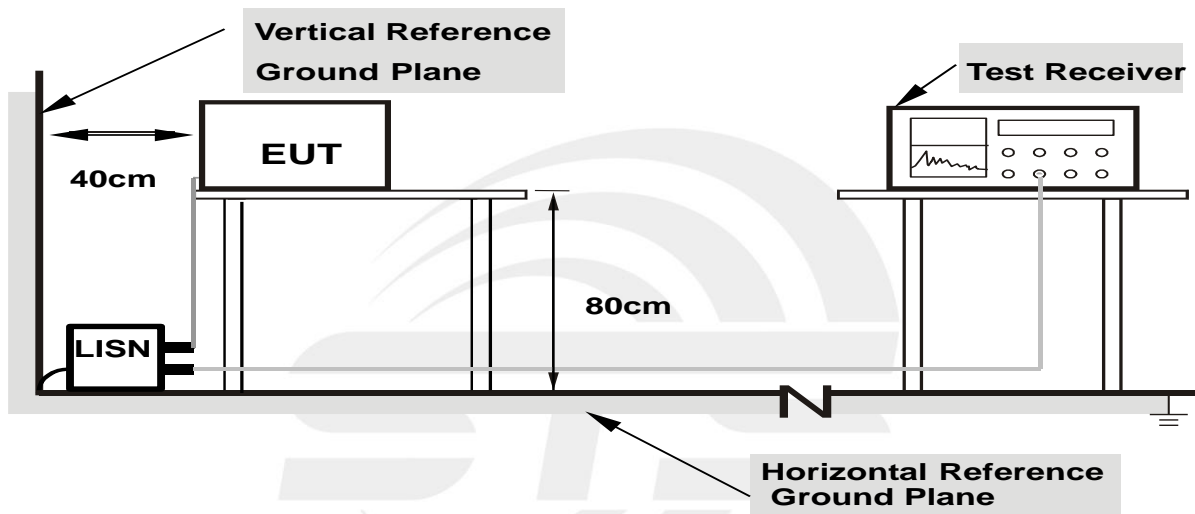

Note: 1.Support units were connected to second LISN.

2.Both of LISNs (AMN) are 80 cm from EUT and at least 80 from other units and other metal planes

3.4 EUT OPERATING CONDITIONS

The EUT was configured for testing in a typical fashion (as a customer would normally use it). The EUT has been programmed to continuously transmit during test. This operating condition was tested and used to collect the included data.



3.5 TEST RESULTS

Temperature :	26 °C	Relative Humidity :	54%
Pressure :	1010hPa	Phase :	L
Test Mode :	Mode 4		

Frequency (MHz)	Reading (dBUV)	Correct Factor(dB)	Result (dBUV)	Limit (dBUV)	Margin (dB)	Remark
0.1700	36.44	10.00	46.44	64.96	-18.52	QP
0.1700	16.63	10.00	26.63	54.96	-28.33	AVG
0.1940	33.91	10.00	43.91	63.86	-19.95	QP
0.1940	14.15	10.00	24.15	53.86	-29.71	AVG
0.2580	28.32	9.94	38.26	61.50	-23.24	QP
0.2580	9.56	9.94	19.50	51.50	-32.00	AVG
0.6940	30.77	10.00	40.77	56.00	-15.23	QP
0.6940	17.74	10.00	27.74	46.00	-18.26	AVG
11.4940	30.27	10.37	40.64	60.00	-19.36	QP
11.4940	15.26	10.37	25.63	50.00	-24.37	AVG
27.3420	28.60	10.52	39.12	60.00	-20.88	QP
27.3420	17.06	10.52	27.58	50.00	-22.42	AVG

Remark:

1. Factor = Antenna Factor + Cable Loss – Pre-amplifier.

100.0 dBUV

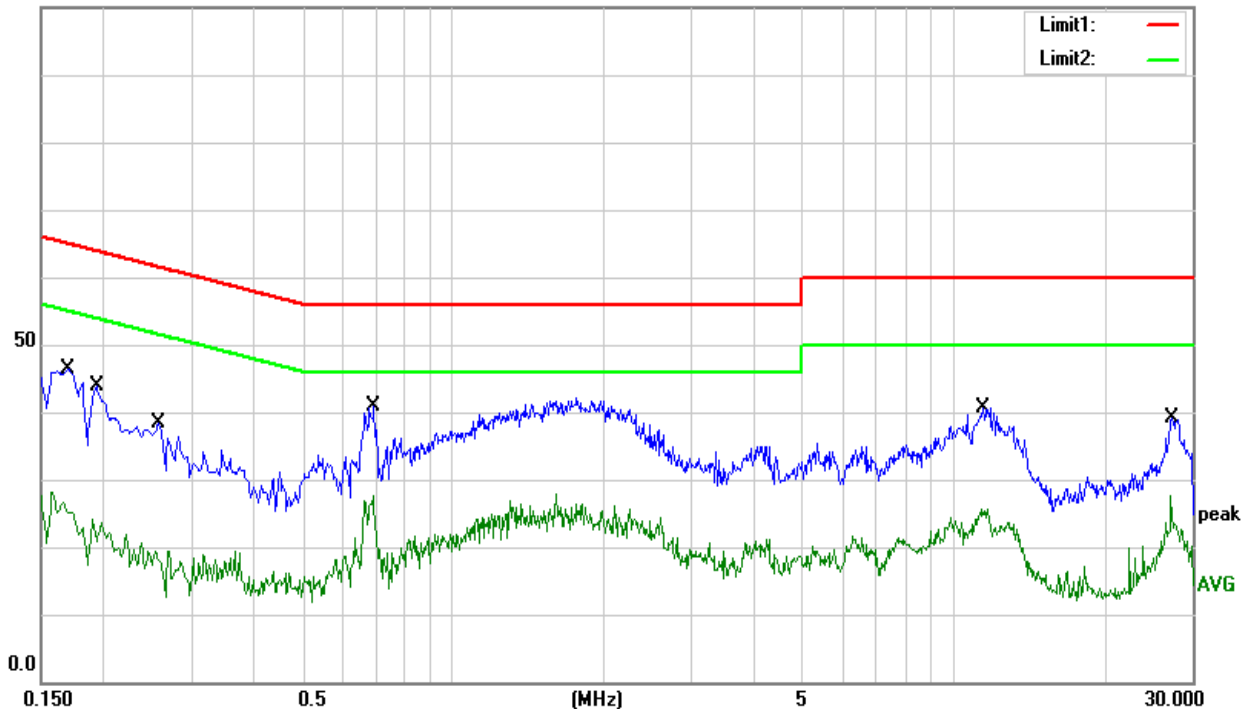



Temperature :	26 °C	Relative Humidity :	54%
Pressure :	1010hPa	Phase :	N
Test Mode :	Mode 4		

Frequency (MHz)	Reading (dBuV)	Correct Factor(dB)	Result (dBuV)	Limit (dBuV)	Margin (dB)	Remark
0.1540	33.76	10.72	44.48	65.78	-21.30	QP
0.1540	14.81	10.72	25.53	55.78	-30.25	AVG
0.2180	30.85	9.98	40.83	62.89	-22.06	QP
0.2180	10.38	9.98	20.36	52.89	-32.53	AVG
0.2500	30.54	9.95	40.49	61.76	-21.27	QP
0.2500	10.30	9.95	20.25	51.76	-31.51	AVG
0.6740	32.88	9.99	42.87	56.00	-13.13	QP
0.6740	19.48	9.99	29.47	46.00	-16.53	AVG
9.9740	28.54	10.21	38.75	60.00	-21.25	QP
9.9740	12.81	10.21	23.02	50.00	-26.98	AVG
27.7060	28.00	10.66	38.66	60.00	-21.34	QP
27.7060	14.22	10.66	24.88	50.00	-25.12	AVG

Remark:

1. Factor = Antenna Factor + Cable Loss – Pre-amplifier.

100.0 dBuV

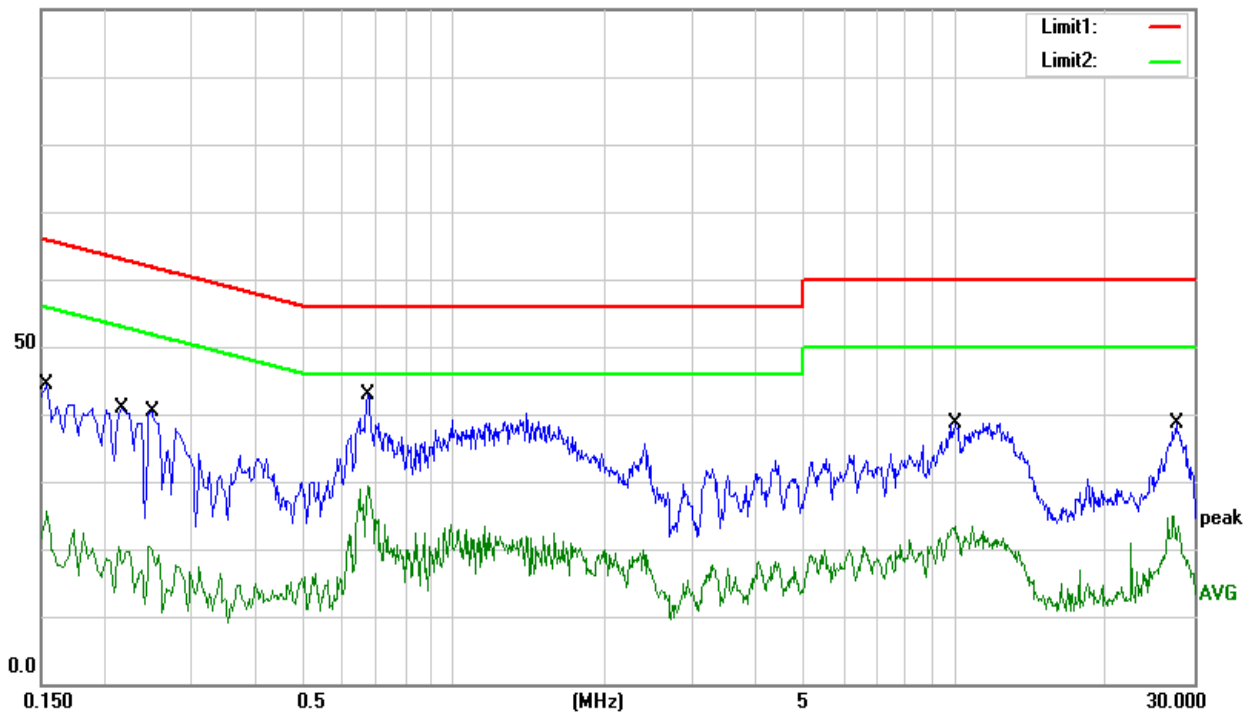



4. RADIATED EMISSION MEASUREMENT

4.1 RADIATED EMISSION LIMITS

in any 100 kHz bandwidth outside the operating frequency band. In case the emission fall within the restricted band specified on Part 15. 205(a)&209(a) limit in the table below has to be followed.

LIMITS OF RADIATED EMISSION MEASUREMENT (Frequency Range 9kHz-1000MHz)

Frequencies (MHz)	Field Strength (micorvolts/meter)	Measurement Distance (meters)
0.009~0.490	2400/F(KHz)	300
0.490~1.705	24000/F(KHz)	30
1.705~30.0	30	30
30~88	100	3
88~216	150	3
216~960	200	3
Above 960	500	3

LIMITS OF RADIATED EMISSION MEASUREMENT (Above 1000MHz)

FREQUENCY (MHz)	Class C (dBuV/m) (at 3M)	
	PEAK	AVERAGE
Above 1000	74	54

Notes:

- (1) The limit for radiated test was performed according to FCC PART 15C.
- (2) The tighter limit applies at the band edges.
- (3) Emission level (dBuV/m)=20log Emission level (uV/m).

For Radiated Emission

Spectrum Parameter	Setting
Attenuation	Auto
Detector	Peak
Start Frequency	1000 MHz(Peak/AV)
Stop Frequency	10 th carrier hamonic(Peak/AV)
RB / VB (emission in restricted band)	1 MHz / 1 MHz, AV=1 MHz /10 Hz

For Band edge

Spectrum Parameter	Setting
Detector	Peak
Start/Stop Frequency	Lower Band Edge: 2300 to 2430 MHz Upper Band Edge: 2450 to 2500 MHz
RB / VB (emission in restricted band)	1 MHz / 1 MHz, AV=1 MHz /10 Hz



Receiver Parameter	Setting
Attenuation	Auto
Start ~ Stop Frequency	9kHz~90kHz / RB 200Hz for PK & AV
Start ~ Stop Frequency	90kHz~110kHz / RB 200Hz for QP
Start ~ Stop Frequency	110kHz~490kHz / RB 200Hz for PK & AV
Start ~ Stop Frequency	490kHz~30MHz / RB 9kHz for QP
Start ~ Stop Frequency	30MHz~1000MHz / RB 120kHz for QP

4.2 TEST PROCEDURE

- a. The measuring distance of at 3 m shall be used for measurements at frequency 0.009MHz up to 1GHz. For frequencies above 1GHz, any suitable measuring distance may be used.
- b. The EUT was placed on the top of a rotating table 0.8 meters(above 1GHz is 1.5 m) above the ground at a 3 meter anechoic chamber. The table was rotated 360 degrees to determine the position of the highest radiation.
- c. The height of the equipment shall be 0.8 m(above 1GHz is 1.5 m); the height of the test antenna shall vary between 1 m to 4 m. Horizontal and vertical polarizations of the antenna are set to make the measurement
- d. The initial step in collecting conducted emission data is a spectrum analyzer peak detector mode pre-scanning the measurement frequency range. Significant peaks are then marked and then Quasi Peak detector mode re-measured.
- e. If the Peak Mode measured value compliance with and lower than Quasi Peak Mode Limit, the EUT shall be deemed to meet QP Limits and then no additional QP Mode measurement performed.
- f. For the actual test configuration, please refer to the related Item –EUT Test Photos.

Note:

Both horizontal and vertical antenna polarities were tested and performed pretest to three orthogonal axis. The worst case emissions were reported.

4.3 TEST SETUP

(A) Radiated Emission Test-Up Frequency Below 30MHz

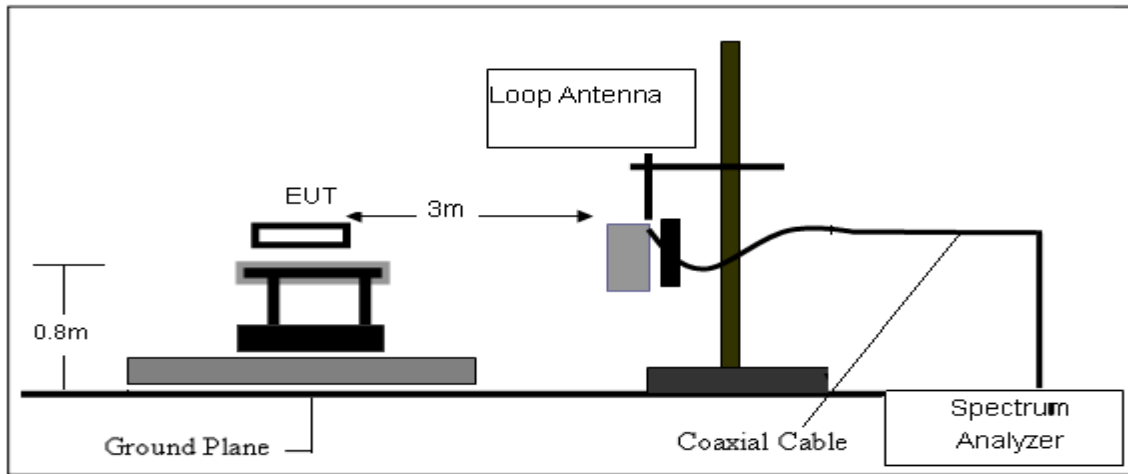

(B) Radiated Emission Test-Up Frequency 30MHz~1GHz

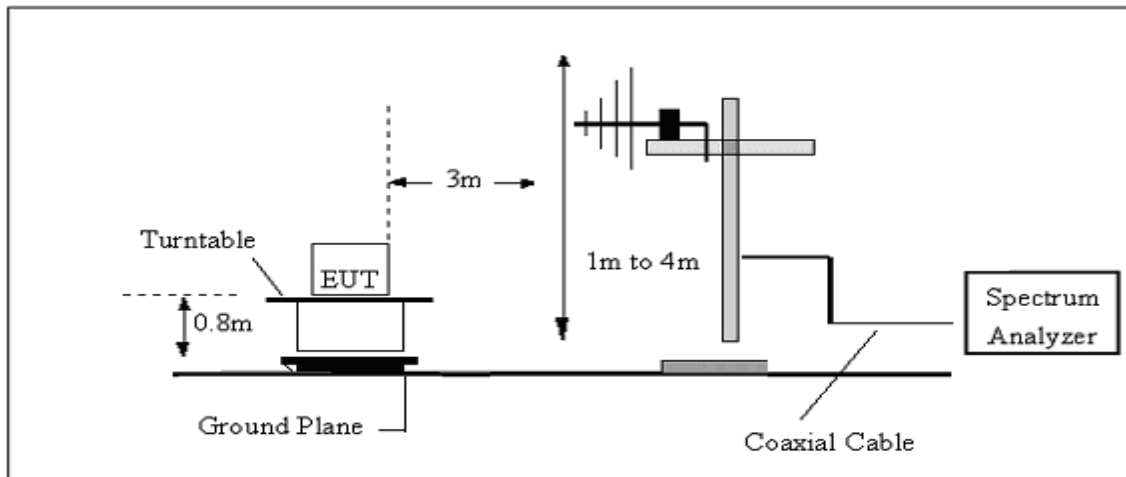

(C) Radiated Emission Test-Up Frequency Above 1GHz

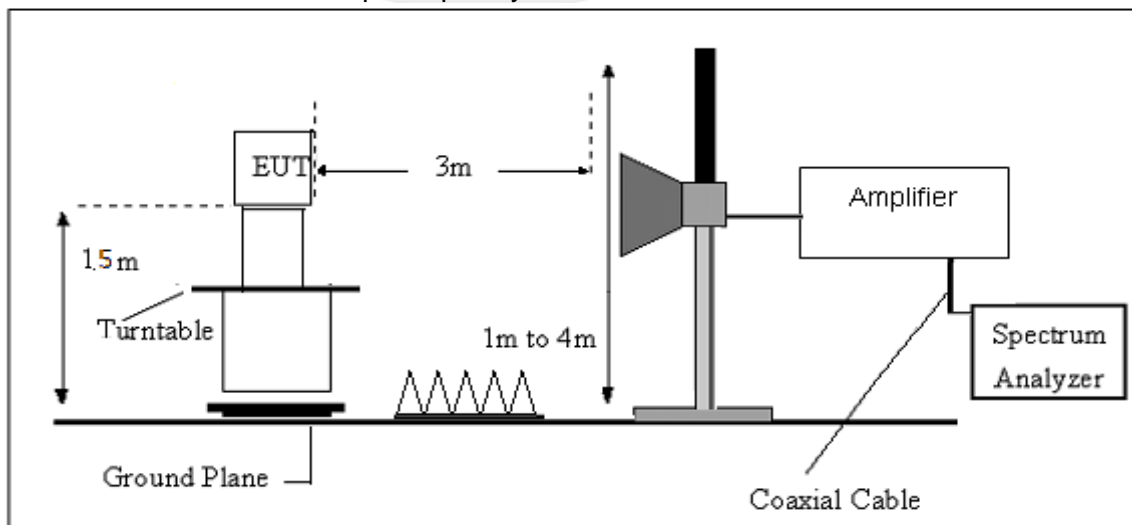

4.4 EUT OPERATING CONDITIONS

The EUT tested system was configured as the statements of 2.3 Unless otherwise a special operating condition is specified in the follows during the testing.



4.5 TEST RESULTS

(Between 9KHz – 30 MHz)

Temperature:	20 °C	Relative Humidity:	48%
Pressure:	1010 hPa	Test Voltage :	3.7V from Battery
Test Mode :	TX Mode	Polarization :	--

Freq. (MHz)	Reading (dBuV/m)	Limit (dBuV/m)	Margin (dB)	State P/F
--	--	--	--	PASS
--	--	--	--	PASS

NOTE:

The amplitude of spurious emissions which are attenuated by more than 20dB below the permissible value has no need to be reported.

Distance extrapolation factor = $40 \log(\text{specific distance}/\text{test distance})$ (dB);

Limit line = specific limits(dBuv) + distance extrapolation factor.



(30MHz -1000MHz)

Temperature :	26 °C	Relative Humidity :	54%
Pressure :	1010hPa	Phase :	Horizontal
Test Voltage :	3.7V from Battery	Test Mode :	Mode1/2/3 (Mode 1-1M worst mode)

Frequency (MHz)	Reading (dBuV)	Correct Factor(dB/m)	Result (dBuV/m)	Limit (dBuV/m)	Margin (dB)	Remark
30.5306	34.86	-11.47	23.39	40.00	-16.61	QP
48.1626	43.54	-20.53	23.01	40.00	-16.99	QP
312.1794	54.15	-14.42	39.73	46.00	-6.27	QP
696.8567	42.36	-5.42	36.94	46.00	-9.06	QP
801.7863	43.38	-3.49	39.89	46.00	-6.11	QP
890.7278	43.08	-2.38	40.70	46.00	-5.30	QP

Remark:

1. Factor = Antenna Factor + Cable Loss – Pre-amplifier.

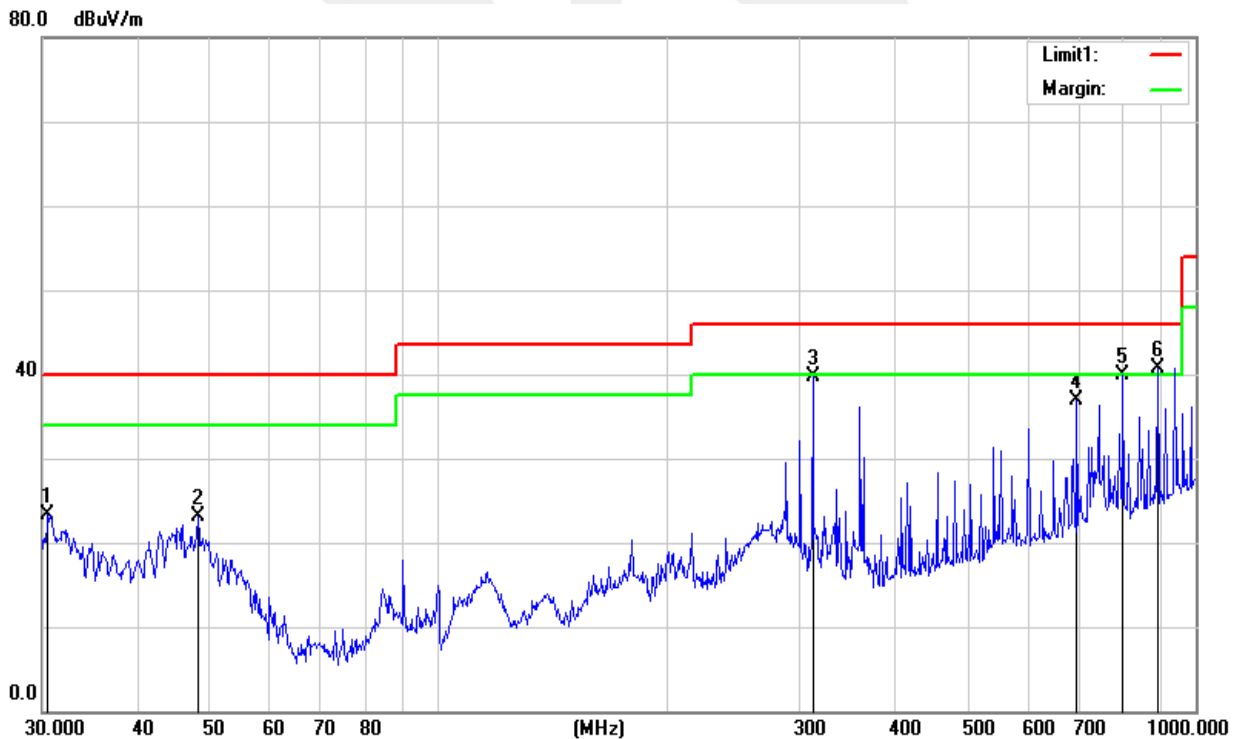



Temperature :	26 °C	Relative Humidity :	54%
Pressure :	1010hPa	Phase :	Vertical
Test Voltage :	3.7V from Battery	Test Mode :	Mode1/2/3 (Mode 1-1M worst mode)

Frequency (MHz)	Reading (dBuV)	Correct Factor(dB/m)	Result (dBuV/m)	Limit (dBuV/m)	Margin (dB)	Remark
42.6000	54.56	-17.67	36.89	40.00	-3.11	QP
89.9047	46.85	-20.22	26.63	43.50	-16.87	QP
216.0240	45.41	-19.37	26.04	46.00	-19.96	QP
312.1794	47.90	-14.42	33.48	46.00	-12.52	QP
890.7278	41.96	-2.38	39.58	46.00	-6.42	QP
30.5306	46.42	-11.47	34.95	40.00	-5.05	QP

Remark:

- Factor = Antenna Factor + Cable Loss – Pre-amplifier.

80.0 dBuV/m

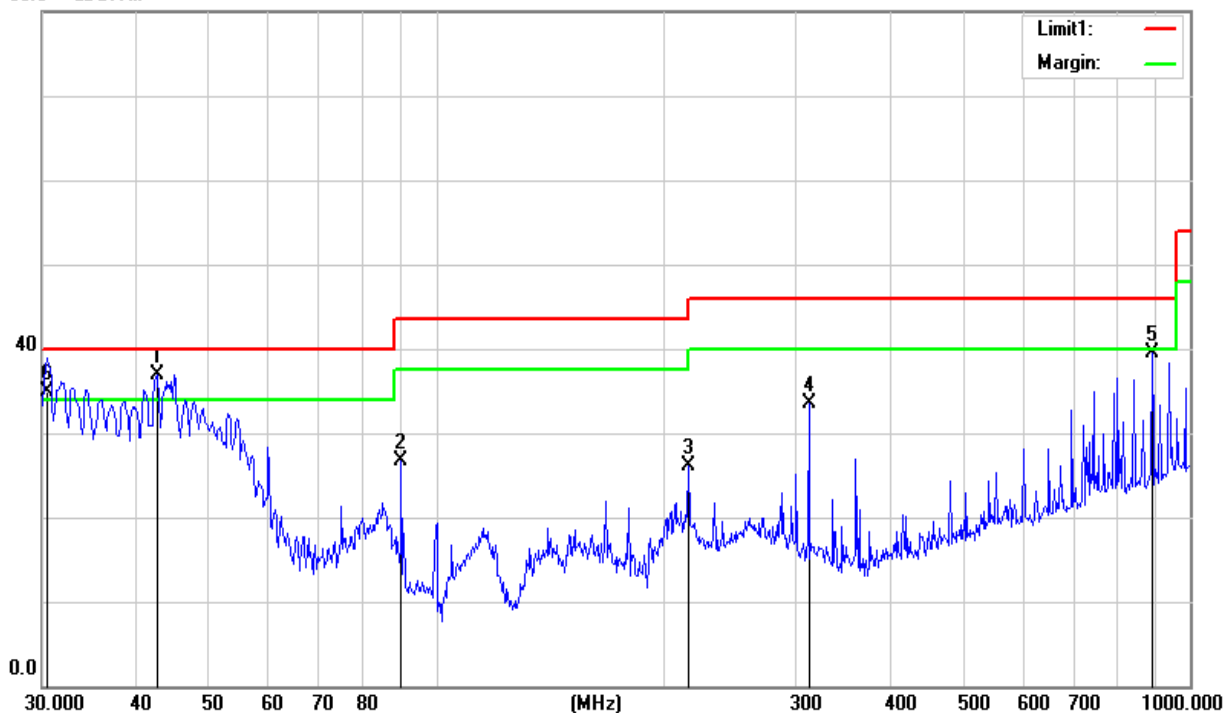



(1GHz-25GHz)

Temperature :	20 °C	Relative Humidity :	48%
Pressure :	1010 hPa	Test Voltage :	DC 3.7V

GFSK Low Channel

Frequency	Meter Reading	Factor	Emission Level	Limits	Margin	Detector	Comment
(MHz)	(dB μ V)	(dB)	(dB μ V/m)	(dB μ V/m)	(dB)	Type	
3265.19	45.09	-9.80	35.29	74.00	-38.71	Pk	Vertical
3265.12	40.11	-9.80	30.31	54.00	-23.69	AV	Vertical
3265.14	45.09	-9.80	35.29	74.00	-38.71	Pk	Horizontal
3265.18	40.11	-9.80	30.31	54.00	-23.69	AV	Horizontal
3334.77	42.84	-9.75	33.09	74.00	-40.91	Pk	Vertical
3334.99	37.88	-9.75	28.13	54.00	-25.87	AV	Vertical
3334.77	42.85	-9.75	33.10	74.00	-40.90	Pk	Horizontal
3334.95	37.85	-9.75	28.10	54.00	-25.90	AV	Horizontal
3349.80	42.58	-9.75	32.83	74.00	-41.17	Pk	Vertical
3349.92	37.62	-9.75	27.87	54.00	-26.13	AV	Vertical
3349.80	42.65	-9.75	32.90	74.00	-41.10	Pk	Horizontal
3349.86	37.63	-9.75	27.88	54.00	-26.12	AV	Horizontal
4000.15	39.98	-6.60	33.38	74.00	-40.62	Pk	Vertical
4000.01	34.99	-6.60	28.39	54.00	-25.61	AV	Vertical
4000.13	40.01	-6.60	33.41	74.00	-40.59	Pk	Horizontal
3999.97	34.97	-6.60	28.37	54.00	-25.63	AV	Horizontal
4803.84	39.38	-3.56	35.82	74.00	-38.18	Pk	Vertical
4803.85	34.41	-3.56	30.85	54.00	-23.15	AV	Vertical
4804.86	39.43	-3.56	35.87	74.00	-38.13	Pk	Horizontal
4803.87	34.38	-3.56	30.82	54.00	-23.18	AV	Horizontal
5360.12	38.32	-2.34	35.98	74.00	-38.02	Pk	Vertical
5360.04	33.30	-2.34	30.96	54.00	-23.04	AV	Vertical
5360.15	38.30	-2.34	35.96	74.00	-38.04	Pk	Horizontal
5360.02	33.31	-2.34	30.97	54.00	-23.03	AV	Horizontal
7206.22	37.80	3.40	41.20	74.00	-32.80	Pk	Vertical
7206.26	32.77	3.40	36.17	54.00	-17.83	AV	Vertical
7206.24	37.80	3.40	41.20	74.00	-32.80	Pk	Horizontal
7236.31	32.77	3.40	36.17	54.00	-17.83	AV	Horizontal
8124.36	36.26	4.80	41.06	74.00	-32.94	Pk	Vertical



8124.37	31.22	4.80	36.02	54.00	-17.98	AV	Vertical
8124.32	36.27	4.80	41.07	74.00	-32.93	Pk	Horizontal
8124.36	31.28	4.80	36.08	54.00	-17.92	AV	Horizontal
9105.02	35.09	5.00	40.09	74.00	-33.91	Pk	Vertical
9105.19	30.07	5.00	35.07	54.00	-18.93	AV	Vertical
9105.06	35.07	5.00	40.07	74.00	-33.93	Pk	Horizontal
9105.11	30.03	5.00	35.03	54.00	-18.97	AV	Horizontal
11036.31	34.08	10.20	44.28	74.00	-29.72	Pk	Vertical
11036.42	29.06	10.20	39.26	54.00	-14.74	AV	Vertical
11036.28	34.02	10.20	44.22	74.00	-29.78	Pk	Horizontal
11036.46	29.02	10.20	39.22	54.00	-14.78	AV	Horizontal
13299.81	32.84	12.20	45.04	74.00	-28.96	Pk	Vertical
13299.77	27.88	12.20	40.08	54.00	-13.92	AV	Vertical
13299.79	32.92	12.20	45.12	74.00	-28.88	Pk	Horizontal
13299.76	27.88	12.20	40.08	54.00	-13.92	AV	Horizontal
14480.11	31.78	13.40	45.18	74.00	-28.82	Pk	Vertical
14480.25	26.78	13.40	40.18	54.00	-13.82	AV	Vertical
14480.13	31.80	13.40	45.20	74.00	-28.80	Pk	Horizontal
14480.28	26.78	13.40	40.18	54.00	-13.82	AV	Horizontal
16000.13	30.96	12.40	43.36	74.00	-30.64	Pk	Vertical
16000.23	25.88	12.40	38.28	54.00	-15.72	AV	Vertical
16000.11	30.93	12.40	43.33	74.00	-30.67	Pk	Horizontal
16000.20	25.92	12.40	38.32	54.00	-15.68	AV	Horizontal
17998.23	28.05	23.10	51.15	74.00	-22.85	Pk	Vertical
17998.06	23.10	23.10	46.20	54.00	-7.80	AV	Vertical
17998.06	28.12	23.10	51.22	74.00	-22.78	Pk	Horizontal
17998.01	23.11	23.10	46.21	54.00	-7.79	AV	Horizontal



GFSK Mid Channel

Frequency	Meter Reading	Factor	Emission Level	Limits	Margin	Detector	Comment
(MHz)	(dB μ V)	(dB)	(dB μ V/m)	(dB μ V/m)	(dB)	Type	
3265.11	45.07	-9.80	35.27	74.00	-38.73	Pk	Vertical
3265.05	40.00	-9.80	30.20	54.00	-23.80	AV	Vertical
3265.09	45.03	-9.80	35.23	74.00	-38.77	Pk	Horizontal
3265.10	40.05	-9.80	30.25	54.00	-23.75	AV	Horizontal
3334.71	42.78	-9.75	33.03	74.00	-40.97	Pk	Vertical
3334.88	37.80	-9.75	28.05	54.00	-25.95	AV	Vertical
3334.69	42.77	-9.75	33.02	74.00	-40.98	Pk	Horizontal
3334.92	37.84	-9.75	28.09	54.00	-25.91	AV	Horizontal
3349.69	42.57	-9.75	32.82	74.00	-41.18	Pk	Vertical
3349.78	37.49	-9.75	27.74	54.00	-26.26	AV	Vertical
3349.71	42.57	-9.75	32.82	74.00	-41.18	Pk	Horizontal
3349.82	37.55	-9.75	27.80	54.00	-26.20	AV	Horizontal
4000.02	39.91	-6.60	33.31	74.00	-40.69	Pk	Vertical
3999.93	34.91	-6.60	28.31	54.00	-25.69	AV	Vertical
4000.03	39.91	-6.60	33.31	74.00	-40.69	Pk	Horizontal
3999.88	34.89	-6.60	28.29	54.00	-25.71	AV	Horizontal
4880.78	39.31	-3.56	35.75	74.00	-38.25	Pk	Vertical
4880.83	34.35	-3.56	30.79	54.00	-23.21	AV	Vertical
4880.70	39.38	-3.56	35.82	74.00	-38.18	Pk	Horizontal
4880.80	34.34	-3.56	30.78	54.00	-23.22	AV	Horizontal
5360.01	38.24	-2.34	35.90	74.00	-38.10	Pk	Vertical
5359.92	33.27	-2.34	30.93	54.00	-23.07	AV	Vertical
5360.03	38.22	-2.34	35.88	74.00	-38.12	Pk	Horizontal
5359.97	33.27	-2.34	30.93	54.00	-23.07	AV	Horizontal
7320.11	37.72	3.40	41.12	74.00	-32.88	Pk	Vertical
7320.11	32.68	3.40	36.08	54.00	-17.92	AV	Vertical
7320.11	37.72	3.40	41.12	74.00	-32.88	Pk	Horizontal
7320.17	32.70	3.40	36.10	54.00	-17.90	AV	Horizontal
8124.30	36.21	4.80	41.01	74.00	-32.99	Pk	Vertical
8124.29	31.20	4.80	36.00	54.00	-18.00	AV	Vertical
8124.25	36.15	4.80	40.95	74.00	-33.05	Pk	Horizontal
8124.28	31.19	4.80	35.99	54.00	-18.01	AV	Horizontal
9104.94	34.99	5.00	39.99	74.00	-34.01	Pk	Vertical
9105.07	29.93	5.00	34.93	54.00	-19.07	AV	Vertical



9104.97	35.05	5.00	40.05	74.00	-33.95	Pk	Horizontal
9105.06	29.99	5.00	34.99	54.00	-19.01	AV	Horizontal
11036.24	33.92	10.20	44.12	74.00	-29.88	Pk	Vertical
11036.39	28.96	10.20	39.16	54.00	-14.84	AV	Vertical
11036.25	33.97	10.20	44.17	74.00	-29.83	Pk	Horizontal
11036.42	28.93	10.20	39.13	54.00	-14.87	AV	Horizontal
13299.75	32.82	12.20	45.02	74.00	-28.98	Pk	Vertical
13299.72	27.83	12.20	40.03	54.00	-13.97	AV	Vertical
13299.70	32.82	12.20	45.02	74.00	-28.98	Pk	Horizontal
13299.80	27.84	12.20	40.04	54.00	-13.96	AV	Horizontal
14480.09	31.71	13.40	45.11	74.00	-28.89	Pk	Vertical
14480.21	26.72	13.40	40.12	54.00	-13.88	AV	Vertical
14480.04	31.72	13.40	45.12	74.00	-28.88	Pk	Horizontal
14480.27	26.70	13.40	40.10	54.00	-13.90	AV	Horizontal
16000.08	30.87	12.40	43.27	74.00	-30.73	Pk	Vertical
16000.14	25.87	12.40	38.27	54.00	-15.73	AV	Vertical
16000.03	30.80	12.40	43.20	74.00	-30.80	Pk	Horizontal
16000.14	25.79	12.40	38.19	54.00	-15.81	AV	Horizontal
17998.21	27.98	23.10	51.08	74.00	-22.92	Pk	Vertical
17998.12	22.99	23.10	46.09	54.00	-7.91	AV	Vertical
17998.08	27.99	23.10	51.09	74.00	-22.91	Pk	Horizontal
17997.97	23.03	23.10	46.13	54.00	-7.87	AV	Horizontal



GFSK High Channel

Frequency	Meter Reading	Factor	Emission Level	Limits	Margin	Detector	Comment
(MHz)	(dB μ V)	(dB)	(dB μ V/m)	(dB μ V/m)	(dB)	Type	
3265.10	45.03	-9.80	35.23	74.00	-38.77	Pk	Vertical
3265.05	40.03	-9.80	30.23	54.00	-23.77	AV	Vertical
3265.07	45.00	-9.80	35.20	74.00	-38.80	Pk	Horizontal
3265.13	40.03	-9.80	30.23	54.00	-23.77	AV	Horizontal
3334.72	42.80	-9.75	33.05	74.00	-40.95	Pk	Vertical
3334.88	37.74	-9.75	27.99	54.00	-26.01	AV	Vertical
3334.65	42.79	-9.75	33.04	74.00	-40.96	Pk	Horizontal
3334.91	37.79	-9.75	28.04	54.00	-25.96	AV	Horizontal
3349.73	42.60	-9.75	32.85	74.00	-41.15	Pk	Vertical
3349.84	37.51	-9.75	27.76	54.00	-26.24	AV	Vertical
3349.71	42.61	-9.75	32.86	74.00	-41.14	Pk	Horizontal
3349.78	37.56	-9.75	27.81	54.00	-26.19	AV	Horizontal
4000.09	39.92	-6.60	33.32	74.00	-40.68	Pk	Vertical
3999.96	34.92	-6.60	28.32	54.00	-25.68	AV	Vertical
4000.03	39.91	-6.60	33.31	74.00	-40.69	Pk	Horizontal
3999.91	34.87	-6.60	28.27	54.00	-25.73	AV	Horizontal
4960.75	39.36	-3.56	35.80	74.00	-38.20	Pk	Vertical
4960.82	34.30	-3.56	30.74	54.00	-23.26	AV	Vertical
4960.75	39.36	-3.56	35.80	74.00	-38.20	Pk	Horizontal
4960.83	34.32	-3.56	30.76	54.00	-23.24	AV	Horizontal
5360.06	38.26	-2.34	35.92	74.00	-38.08	Pk	Vertical
5359.94	33.26	-2.34	30.92	54.00	-23.08	AV	Vertical
5360.07	38.26	-2.34	35.92	74.00	-38.08	Pk	Horizontal
5359.94	33.26	-2.34	30.92	54.00	-23.08	AV	Horizontal
7440.09	37.70	3.40	41.10	74.00	-32.90	Pk	Vertical
7440.10	32.72	3.40	36.12	54.00	-17.88	AV	Vertical
7440.14	37.70	3.40	41.10	74.00	-32.90	Pk	Horizontal
7440.15	32.69	3.40	36.09	54.00	-17.91	AV	Horizontal
8124.31	36.16	4.80	40.96	74.00	-33.04	Pk	Vertical
8124.27	31.15	4.80	35.95	54.00	-18.05	AV	Vertical
8124.33	36.16	4.80	40.96	74.00	-33.04	Pk	Horizontal
8124.31	31.17	4.80	35.97	54.00	-18.03	AV	Horizontal
9104.93	34.99	5.00	39.99	74.00	-34.01	Pk	Vertical
9105.07	29.93	5.00	34.93	54.00	-19.07	AV	Vertical



9105.00	35.03	5.00	40.03	74.00	-33.97	Pk	Horizontal
9105.01	29.98	5.00	34.98	54.00	-19.02	AV	Horizontal
11036.18	33.94	10.20	44.14	74.00	-29.86	Pk	Vertical
11036.39	28.95	10.20	39.15	54.00	-14.85	AV	Vertical
11036.22	33.97	10.20	44.17	74.00	-29.83	Pk	Horizontal
11036.41	28.93	10.20	39.13	54.00	-14.87	AV	Horizontal
13299.68	32.84	12.20	45.04	74.00	-28.96	Pk	Vertical
13299.70	27.83	12.20	40.03	54.00	-13.97	AV	Vertical
13299.74	32.85	12.20	45.05	74.00	-28.95	Pk	Horizontal
13299.73	27.83	12.20	40.03	54.00	-13.97	AV	Horizontal
14480.08	31.71	13.40	45.11	74.00	-28.89	Pk	Vertical
14480.23	26.69	13.40	40.09	54.00	-13.91	AV	Vertical
14479.98	31.72	13.40	45.12	74.00	-28.88	Pk	Horizontal
14480.18	26.77	13.40	40.17	54.00	-13.83	AV	Horizontal
16000.05	30.86	12.40	43.26	74.00	-30.74	Pk	Vertical
16000.13	25.81	12.40	38.21	54.00	-15.79	AV	Vertical
16000.06	30.89	12.40	43.29	74.00	-30.71	Pk	Horizontal
16000.15	25.79	12.40	38.19	54.00	-15.81	AV	Horizontal
17998.23	28.03	23.10	51.13	74.00	-22.87	Pk	Vertical
17998.14	22.96	23.10	46.06	54.00	-7.94	AV	Vertical
17998.08	28.01	23.10	51.11	74.00	-22.89	Pk	Horizontal
17998.00	23.02	23.10	46.12	54.00	-7.88	AV	Horizontal

Note:

1) Factor = Antenna Factor + Cable Loss – Pre-amplifier.

Emission Level = Meter Reading + Factor

Margin = Limit - Emission Level

2) Above did not show the frequency of the emission peaks form is at least 20 decibel limits, transmitting frequency noise mainly comes from the environment.



4.6 TEST RESULTS (RESTRICTED BANDS REQUIREMENTS)

Frequency (MHz)	Reading (dBuV)	Factor (dB)	Emission Level (dB μ V/m)	Limit (dBuV/m)	Margin (dB)	Detector	Comment
GFSK							
2340.0	69.19	-12.99	56.20	74	-17.80	PK	Vertical
2340.0	54.96	-12.99	41.97	54	-12.03	AV	Vertical
2340.0	70.17	-12.99	57.18	74	-16.82	PK	Horizontal
2340.0	54.09	-12.99	41.10	54	-12.90	AV	Horizontal
2483.5	70.98	-12.78	58.20	74	-15.80	PK	Vertical
2483.5	53.97	-12.78	41.19	54	-12.81	AV	Vertical
2483.5	71.08	-12.78	58.30	74	-15.70	PK	Horizontal
2483.5	53.97	-12.78	41.19	54	-12.81	AV	Horizontal
Remark: 1. Factor = Antenna Factor + Cable Loss – Pre-amplifier.							
Low measurement frequencies is range from 2310 to 2400 MHz, high measurement frequencies is range from 2483.5 to 2500 MHz. Only show the worst point data of the emissions in the frequency 2310-2400 MHz and 2483.5-2500 MHz.							

5. CONDUCTED SPURIOUS & BAND EDGE EMISSION

5.1 REQUIREMENT

According to FCC section 15.247(d), in any 100kHz bandwidth outside the frequency band in which the spread spectrum or digitally modulated intentional radiator is operating, the radio frequency power that is produced by the intentional radiator shall be at least 20dB below that in the 100kHz bandwidth within the band that contains the highest level of the desired power, based on either an RF conducted or a radiated measurement.

5.2 TEST PROCEDURE

Spectrum Parameter	Setting
Detector	Peak
Start/Stop Frequency	30 MHz to 10th carrier harmonic
RB / VB (emission in restricted band)	100 KHz/300 KHz
Trace-Mode:	Max hold

For Band edge

Spectrum Parameter	Setting
Detector	Peak
Start/Stop Frequency	Lower Band Edge: 2310 – 2404 MHz Upper Band Edge: 2478 – 2500 MHz
RB / VB (emission in restricted band)	100 KHz/300 KHz
Trace-Mode:	Max hold

5.3 TEST SETUP

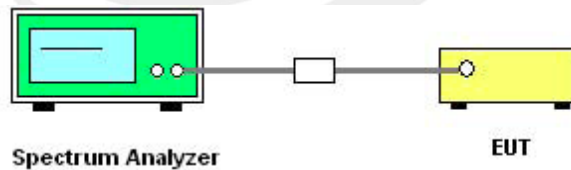

The EUT which is powered by the Battery, is coupled to the Spectrum Analyzer; the RF load attached to the EUT antenna terminal is 50 Ohm; the path loss as the factor is calibrated to correct the reading. Make the measurement with the spectrum analyzer's resolution bandwidth(RBW) = 100 kHz. In order to make an accurate measurement, set the span greater than RBW.

5.4 EUT OPERATION CONDITIONS

The EUT tested system was configured as the statements of 2.3 Unless otherwise a special operating condition is specified in the follows during the testing.



5.5 TEST RESULTS

Temperature :	25 °C	Relative Humidity :	50%
Pressure :	1012 hPa	Test Voltage :	DC 3.7V
Test Mode :	TX Mode /CH01, CH20, CH40		

01 CH

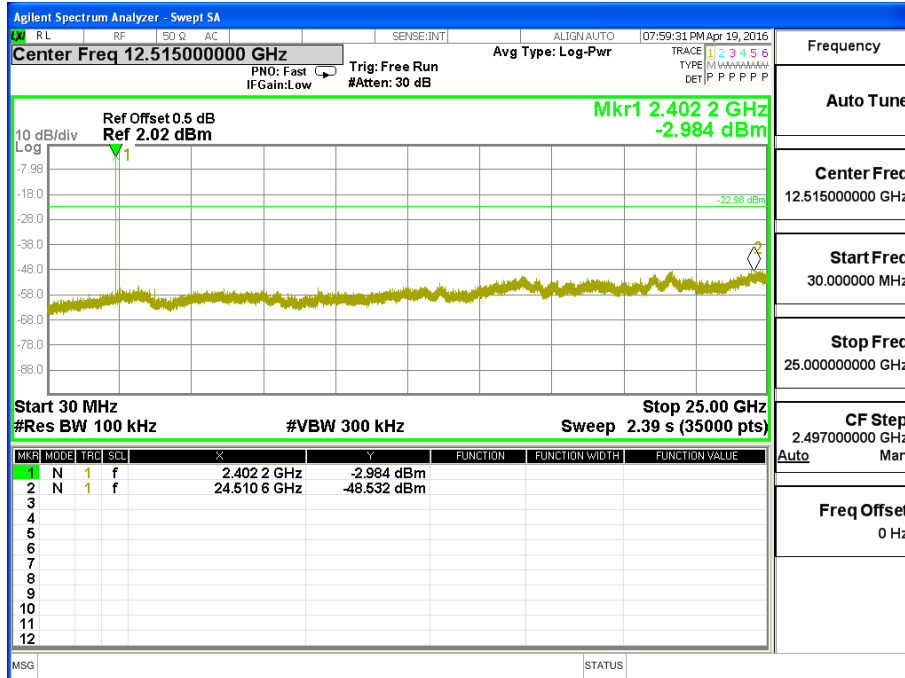



20 CH

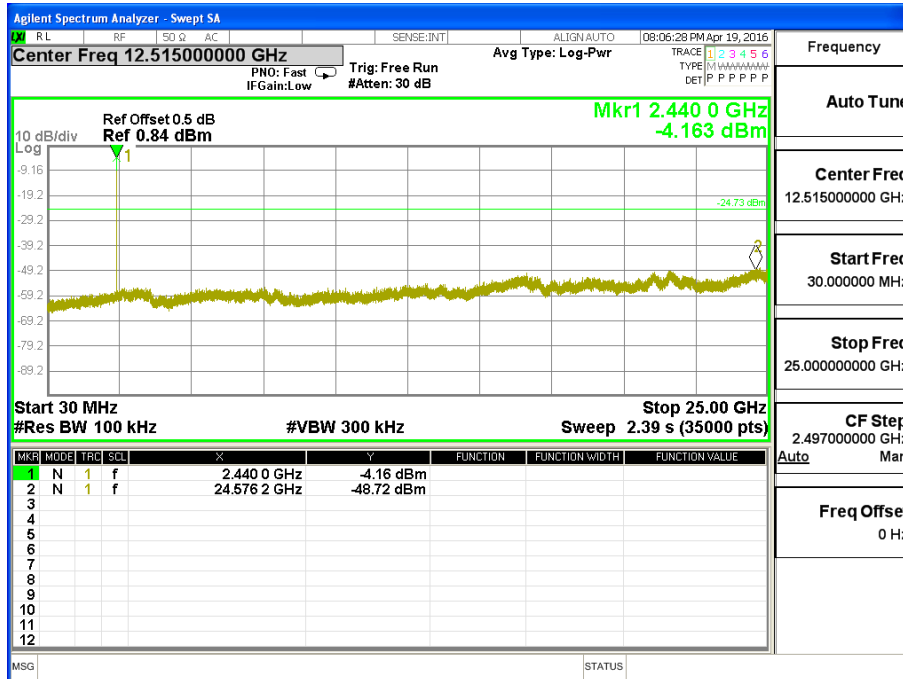

40 CH

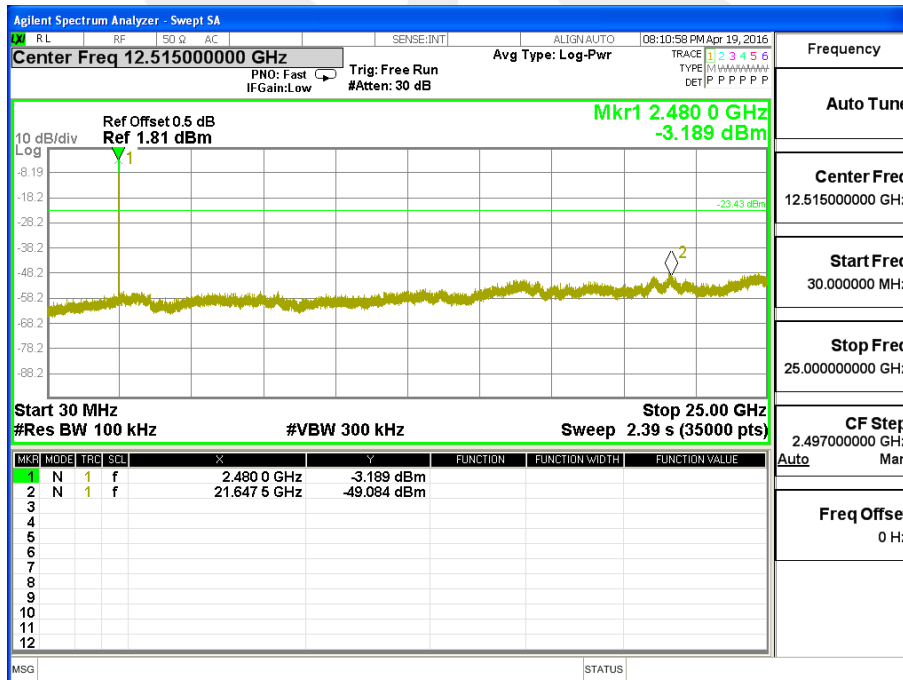



For Band edge

01 CH

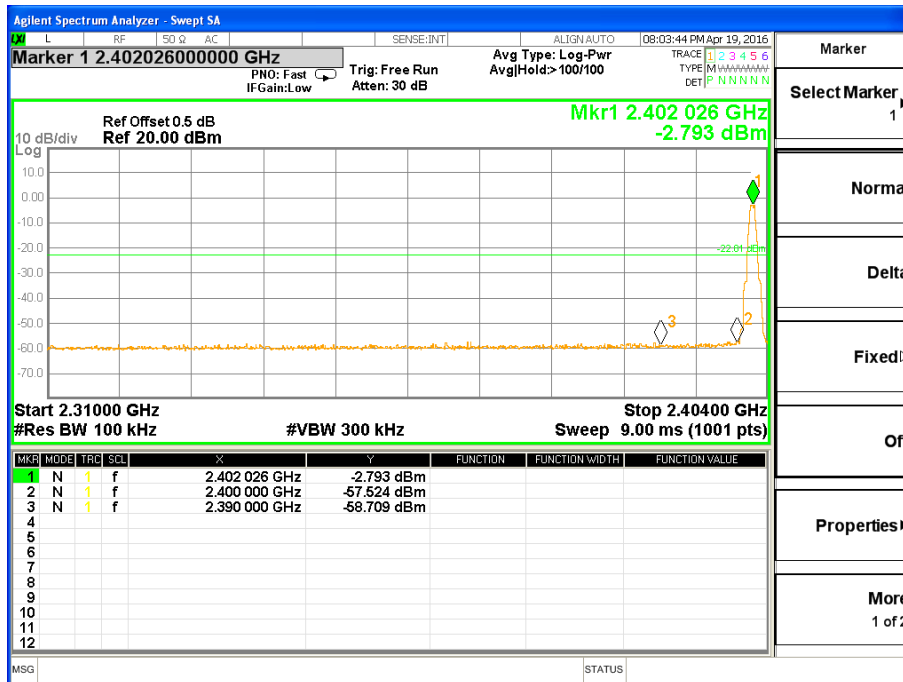

40 CH

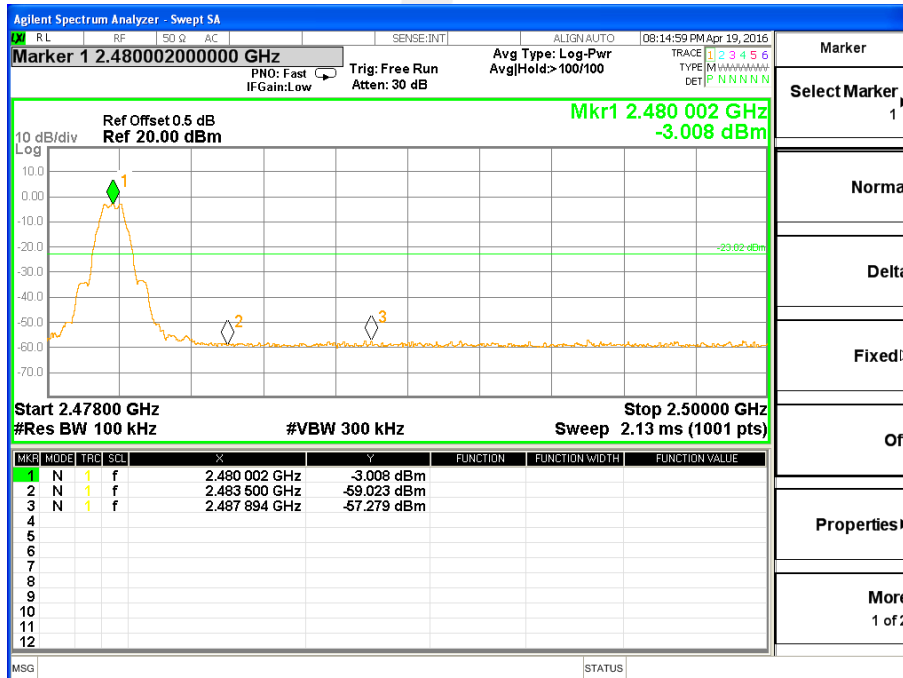



6. POWER SPECTRAL DENSITY TEST

6.1 APPLIED PROCEDURES / LIMIT

FCC Part15 (15.247) , Subpart C				
Section	Test Item	Limit	Frequency Range (MHz)	Result
15.247(e)	Power Spectral Density	≤ 8 dBm (RBW ≥ 3 KHz)	2400-2483.5	PASS

6.2 TEST PROCEDURE

1. Set analyzer center frequency to DTS channel center frequency.
2. Set the span to 1.5 times the DTS channel bandwidth.
3. Set the RBW to: $100 \text{ kHz} \geq \text{RBW} \geq 3 \text{ kHz}$.
4. Set the VBW $\geq 3 \times \text{RBW}$.
5. Detector = peak.
6. Sweep time = auto couple.
7. Trace mode = max hold.
8. Allow trace to fully stabilize.
9. Use the peak marker function to determine the maximum amplitude level.
10. If measured value exceeds limit, reduce RBW (no less than 3 kHz) and repeat.

6.3 TEST SETUP



6.4 EUT OPERATION CONDITIONS

The EUT tested system was configured as the statements of 2.3 Unless otherwise a special operating condition is specified in the follows during the testing.



6.5 TEST RESULTS

Temperature :	25 °C	Relative Humidity :	60%
Pressure :	1015 hPa	Test Voltage :	DC 3.7V
Test Mode :	TX Mode /CH01, CH20, CH40		

Frequency	Power Density (dBm/3kHz)	Limit (dBm)	Result
2402 MHz	-18.320	≤8	PASS
2440 MHz	-17.997	≤8	PASS
2480 MHz	-18.126	≤8	PASS

TX CH01

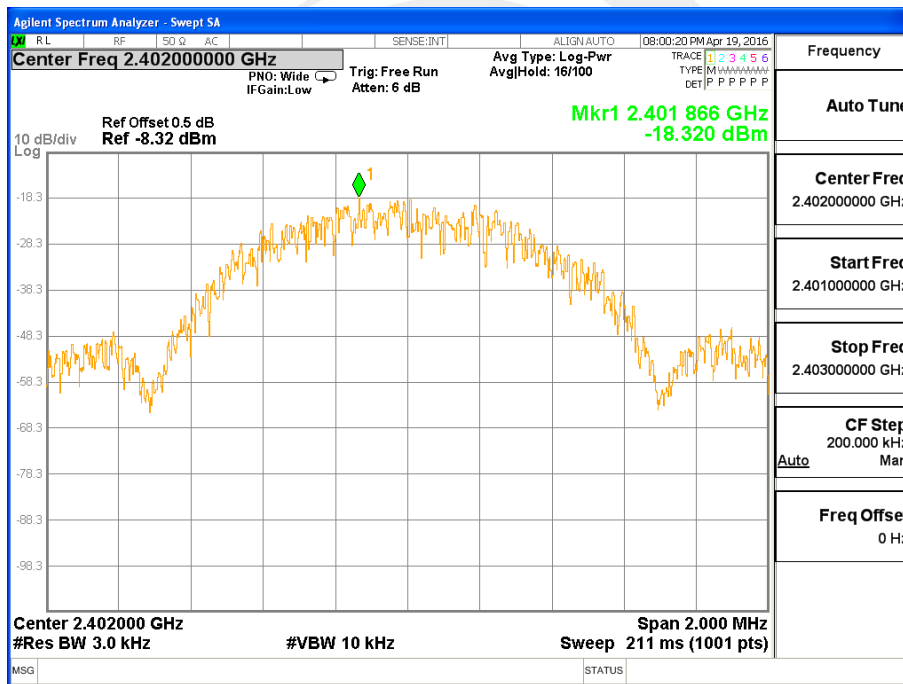



TX CH20

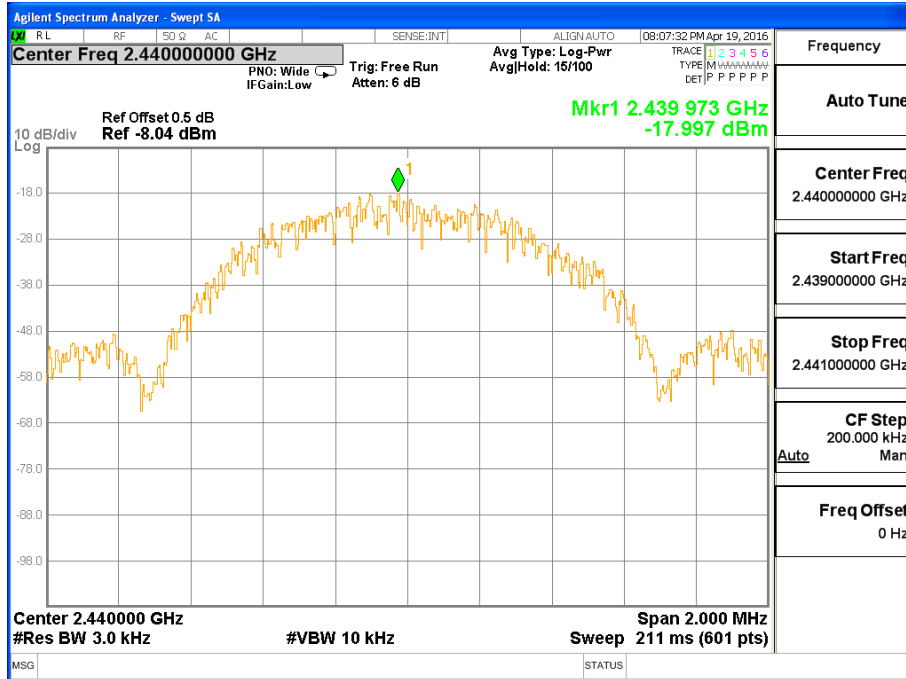

TX CH40

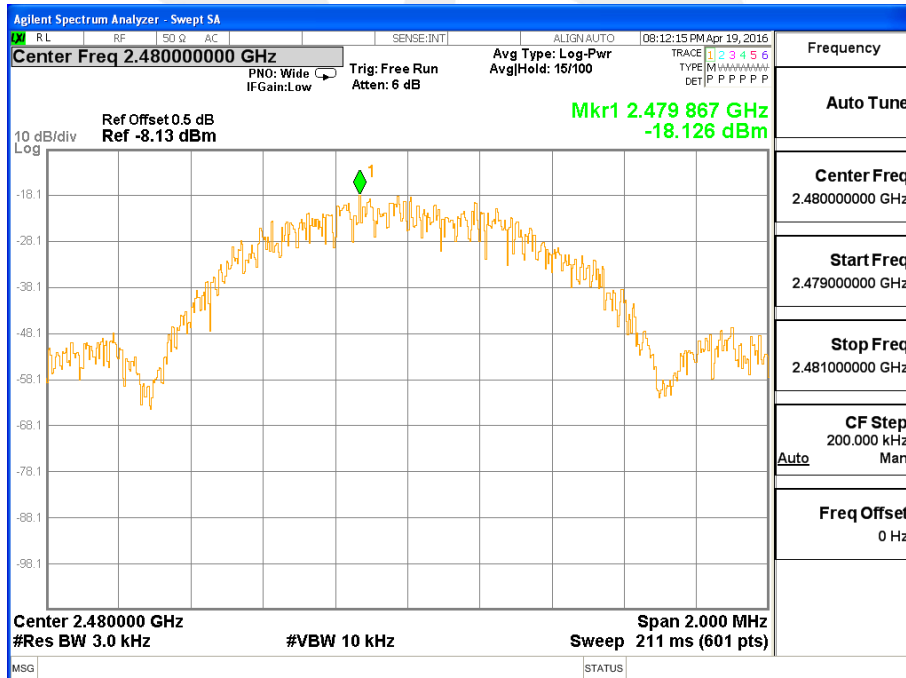



7. BANDWIDTH TEST

7.1 APPLIED PROCEDURES / LIMIT

FCC Part15 (15.247) , Subpart C				
Section	Test Item	Limit	Frequency Range (MHz)	Result
15.247(a)(2)	Bandwidth	$\geq 500\text{KHz}$ (6dB bandwidth)	2400-2483.5	PASS

7.2 TEST PROCEDURE

The automatic bandwidth measurement capability of an instrument may be employed using the X dB bandwidth mode with X set to 6 dB, if the functionality described above (i.e., RBW = 100 kHz, VBW $\geq 3\text{RBW}$, peak detector with maximum hold) is implemented by the instrumentation function. When using this capability, care shall be taken so that the bandwidth measurement is not influenced by any intermediate power nulls in the fundamental emission that might be ≥ 6 dB.

7.3 TEST SETUP



7.4 EUT OPERATION CONDITIONS

The EUT tested system was configured as the statements of 2.3 Unless otherwise a special operating condition is specified in the follows during the testing.



7.5 TEST RESULTS

Temperature :	25 °C	Relative Humidity :	60%
Pressure :	1012 hPa	Test Voltage :	DC 3.7V
Test Mode :	TX Mode /CH01, CH20, CH40		

Remark: PEAK DETECTOR IS USED

Frequency	6dB Bandwidth (MHz)	Channel Separation (MHz)	Result
2402 MHz	0.686	>=500KHz	PASS
2440 MHz	0.687	>=500KHz	PASS
2480 MHz	0.689	>=500KHz	PASS

TX CH 01

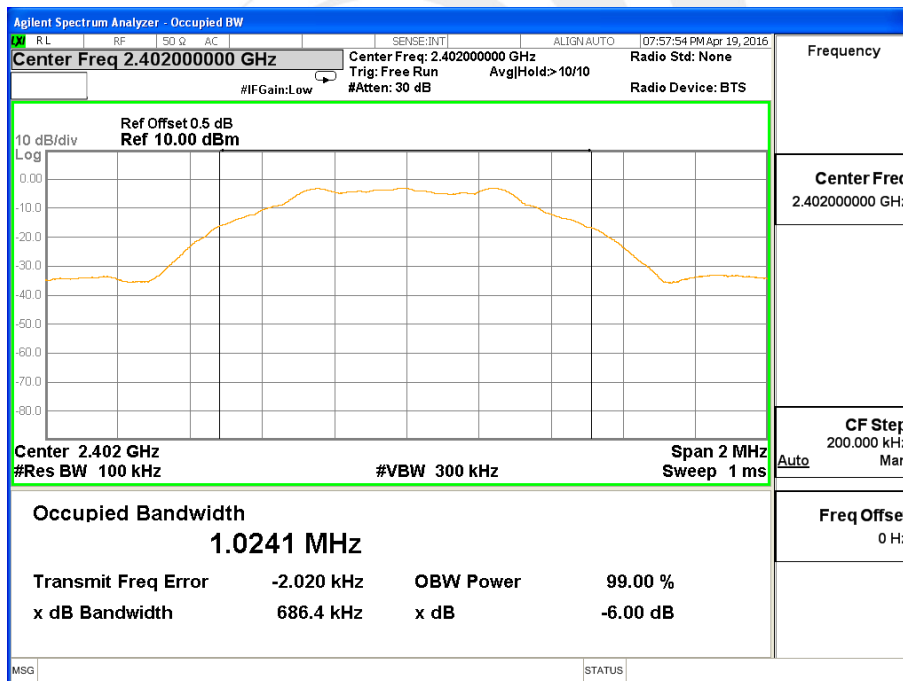



TX CH 20

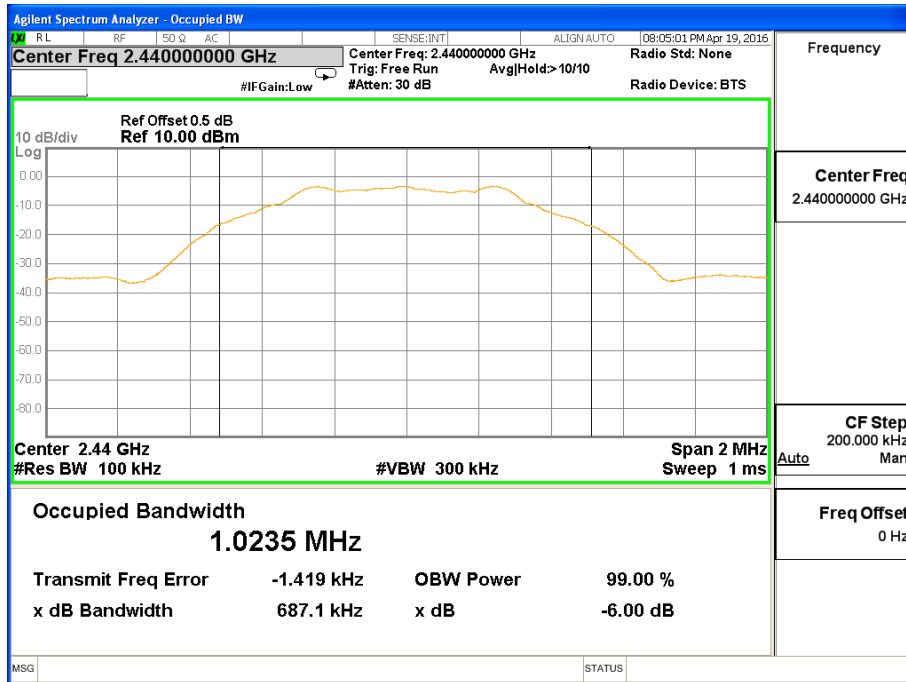

TX CH 40

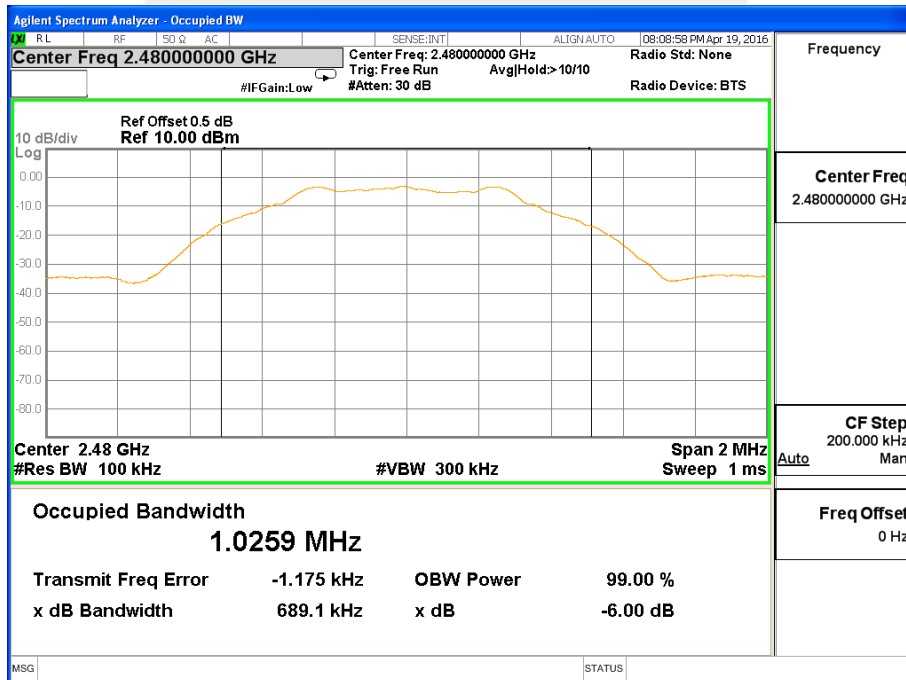



8. PEAK OUTPUT POWER TEST

8.1 APPLIED PROCEDURES / LIMIT

FCC Part15 (15.247) , Subpart C				
Section	Test Item	Limit	Frequency Range (MHz)	Result
15.247(b)(3)	Output Power	1 watt or 30dBm	2400-2483.5	PASS

8.2 TEST PROCEDURE

- a. The EUT was directly connected to the Power Sensor&Power meter

8.3 TEST SETUP



8.4 EUT OPERATION CONDITIONS

The EUT tested system was configured as the statements of 2.3 Unless otherwise a special operating condition is specified in the follows during the testing.



8.5 TEST RESULTS

Temperature :	25 °C	Relative Humidity :	60%
Pressure :	1012 hPa	Test Voltage :	DC 3.7V
Test Mode :	TX Mode /CH01, CH20, CH40		

TX Mode				
Test Channe	Frequency	Conducted Output Power		LIMIT
	(MHz)	Peak (dBm)	AVG (dBm)	dBm
CH01	2402	-3.200	-5.420	30
CH20	2440	-3.200	-5.420	30
CH40	2480	-3.800	-6.020	30



9. ANTENNA REQUIREMENT

9.1 STANDARD REQUIREMENT

15.203 requirement: For intentional device, according to 15.203: an intentional radiator shall be designed to ensure that no antenna other than that furnished by the responsible party shall be used with the device.

9.2 EUT ANTENNA

The EUT antenna is PIFA Antenna. It comply with the standard requirement.





10. EUT TEST PHOTO

Radiated Measurement Photos

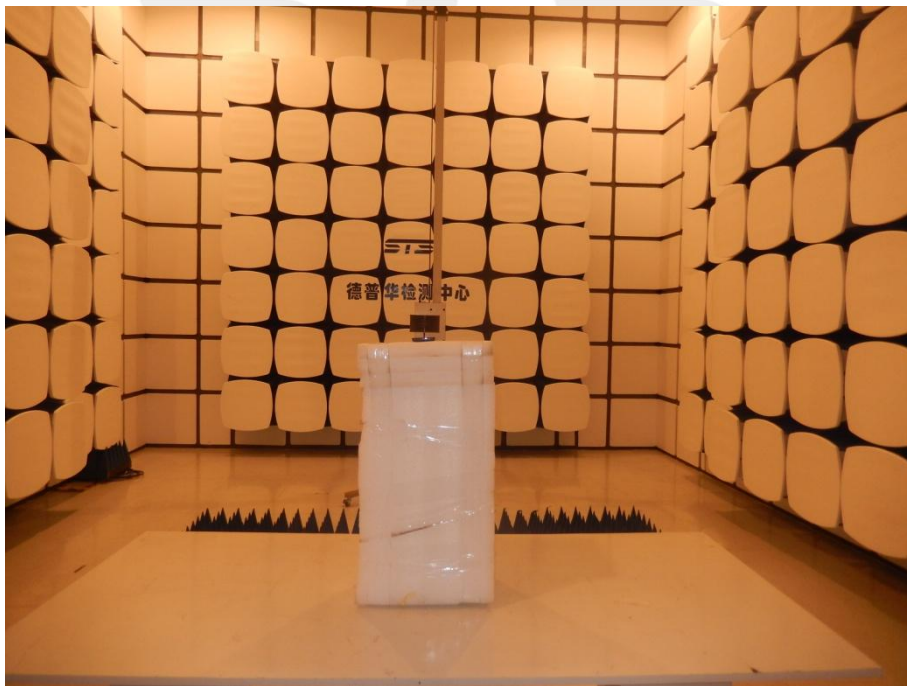
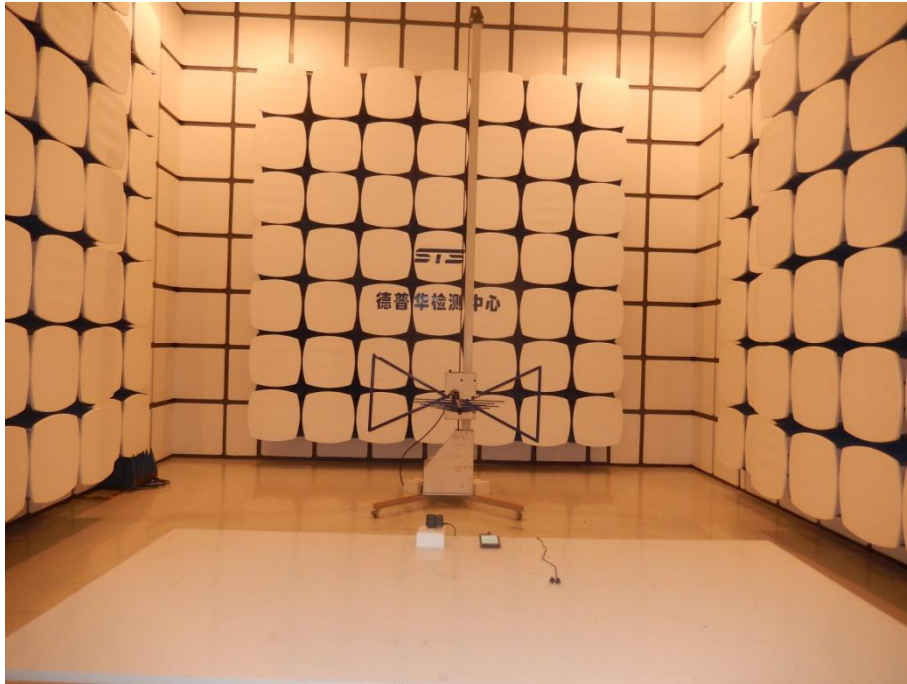



Conducted Measurement Photos



※※※※※END OF THE REPORT※※※※※