

S

T

S

L

A

B



# RADIO TEST REPORT

Report No: STS1511105F03

Issued for

XTR S.A.C.

Av. Camino Real 1225 Of 201-A San Isidro - Perú

Product Name:	3G Smartphone
Brand Name:	EKS
Model No.:	X3
Series Model:	N/A
FCC ID:	2AGAK-X3
Test Standard:	FCC Part 15.247

Any reproduction of this document must be done in full. No single part of this document may be reproduced without permission from STS, All Test Data Presented in this report is only applicable to presented Test sample.





TEST RESULT CERTIFICATION

Applicant's name..... XTR S.A.C.

Address..... Av. Camino Real 1225 Of 201-A San Isidro - Perú

Manufacture's Name ..... Shenzhen Richpad Communication Technology Co.,LTD

Address..... Room 315, HKUST SZ IER Building, No.9 Yuexing 1st RD, South Area, Hi-Tech Park, NanShan, ShenZhen P.R.C, China

Product description

Product name..... 3G Smartphone

Brand name..... EKS

Model and/or type reference X3

Standards ..... FCC Part 15.247

Test procedure ..... ANSI C63.10-2013

This device described above has been tested by STS, and the test results show that the equipment under test (EUT) is in compliance with the FCC requirements. And it is applicable only to the tested sample identified in the report.

This report shall not be reproduced except in full, without the written approval of STS, this document may be altered or revised by STS, personal only, and shall be noted in the revision of the document.

Date of Test.....

Date (s) of performance of tests . 17 Nov. 2015 ~23 Nov. 2015

Date of Issue ..... 24 Nov. 2015

Test Result ..... Pass

Testing Engineer :

Jin Ming

(Jin Ming)

Technical Manager :

Vita Li

(Vita Li)

Authorized Signatory :

Bovey Yang

(Bovey Yang)





Table of Contents	Page
<b>1. SUMMARY OF TEST RESULTS</b>	<b>6</b>
1.1 TEST FACTORY	7
1.2 MEASUREMENT UNCERTAINTY	7
<b>2. GENERAL INFORMATION</b>	<b>8</b>
2.1 GENERAL DESCRIPTION OF EUT	8
2.2 DESCRIPTION OF TEST MODES	10
2.3 TABLE OF PARAMETERS OF TEXT SOFTWARE SETTING	10
2.4 BLOCK DIGRAM SHOWING THE CONFIGURATION OF SYSTEM TESTED	11
2.5 DESCRIPTION OF SUPPORT UNITS	12
2.6 EQUIPMENTS LIST FOR ALL TEST ITEMS	13
<b>3. EMC EMISSION TEST</b>	<b>14</b>
3.1 CONDUCTED EMISSION MEASUREMENT	14
3.1.1 POWER LINE CONDUCTED EMISSION LIMITS	14
3.1.2 TEST PROCEDURE	15
3.1.3 TEST SETUP	15
3.1.4 EUT OPERATING CONDITIONS	15
3.1.5 TEST RESULTS	16
3.2 RADIATED EMISSION MEASUREMENT	18
3.2.1 RADIATED EMISSION LIMITS	18
3.2.2 TEST PROCEDURE	19
3.2.3 DEVIATION FROM TEST STANDARD	19
3.2.4 TEST SETUP	20
3.2.5 EUT OPERATING CONDITIONS	21
3.2.6 TEST RESULTS	22
<b>4. CONDUCTED SPURIOUS EMISSIONS</b>	<b>28</b>
4.1 REQUIREMENT	28
4.2 TEST PROCEDURE	28
4.3 TEST SETUP	28
4.4 EUT OPERATION CONDITIONS	28
4.5 TEST RESULTS	29
<b>5. NUMBER OF HOPPING CHANNEL</b>	<b>41</b>
5.1 APPLIED PROCEDURES / LIMIT	41
5.2 TEST PROCEDURE	41
5.3 TEST SETUP	41
5.4 EUT OPERATION CONDITIONS	41



<b>Table of Contents</b>	<b>Page</b>
<b>5.5 TEST RESULTS</b>	<b>42</b>
<b>6. AVERAGE TIME OF OCCUPANCY</b>	<b>43</b>
6.1 APPLIED PROCEDURES / LIMIT	43
6.2 TEST PROCEDURE	43
6.3 TEST SETUP	43
6.4 EUT OPERATION CONDITIONS	43
6.5 TEST RESULTS	44
<b>7. HOPPING CHANNEL SEPARATION MEASUREMENT</b>	<b>50</b>
7.1 APPLIED PROCEDURES / LIMIT	50
7.2 TEST PROCEDURE	50
7.3 TEST SETUP	50
7.4 EUT OPERATION CONDITIONS	50
7.5 TEST RESULTS	51
<b>8. BANDWIDTH TEST</b>	<b>57</b>
8.1 APPLIED PROCEDURES / LIMIT	57
8.2 TEST PROCEDURE	57
8.3 TEST SETUP	57
8.4 EUT OPERATION CONDITIONS	57
8.5 TEST RESULTS	58
<b>9. PEAK OUTPUT POWER TEST</b>	<b>64</b>
9.1 APPLIED PROCEDURES / LIMIT	64
9.2 TEST PROCEDURE	64
9.3 TEST SETUP	64
9.4 EUT OPERATION CONDITIONS	64
9.5 TEST RESULTS	65
<b>10. ANTENNA REQUIREMENT</b>	<b>71</b>
10.1 STANDARD REQUIREMENT	71
10.2 EUT ANTENNA	71



**Revision History**

Rev.	Issue Date	Report NO.	Effect Page	Contents
00	24 Nov. 2015	STS1511105F03	ALL	Initial Issue





## 1. SUMMARY OF TEST RESULTS

Test procedures according to the technical standards:

<b>FCC Part15 (15.247) , Subpart C</b>			
Standard Section	Test Item	Judgment	Remark
15.207	Conducted Emission	PASS	--
15.247(a)(1)	Hopping Channel Separation	PASS	--
15.247(b)(1)	Peak Output Power	PASS	--
15.247(c)	Radiated Spurious Emission	PASS	--
15.247(d)	Conducted Spurious Emission	PASS	--
15.247(a)(iii)	Number of Hopping Frequency	PASS	--
15.247(a)(iii)	Dwell Time	PASS	--
15.247(a)(1)	Bandwidth	PASS	--
15.205	Band Edge Emission	PASS	--
15.203	Antenna Requirement	PASS	--

**NOTE:**

(1) "N/A" denotes test is not applicable in this Test Report



## 1.1 TEST FACTORY

Shenzhen STS Test Services Co., Ltd.

Add. : 1/F., Building B, Zhuoke Science Park, No.190,Chongqing Road,  
Fuyong Street, Bao'an District, Shenzhen, Guangdong,China

CNAS Registration No.: L7649;

FCC Registration No.: 842334; IC Registration No.: 12108A-1

## 1.2 MEASUREMENT UNCERTAINTY

The reported uncertainty of measurement  $y \pm U$ , where expanded uncertainty  $U$  is based on a standard uncertainty multiplied by a coverage factor of  $k=2$ , providing a level of confidence of approximately **95 %**.

No.	Item	Uncertainty
1	Conducted Emission (9KHz-150KHz)	$\pm 2.88\text{dB}$
2	Conducted Emission (150KHz-30MHz)	$\pm 2.67\text{dB}$
3	RF power,conducted	$\pm 0.70\text{dB}$
4	Spurious emissions,conducted	$\pm 1.19\text{dB}$
5	All emissions,radiated(<1G) 30MHz-200MHz	$\pm 2.83\text{dB}$
6	All emissions,radiated(<1G) 200MHz-1000MHz	$\pm 2.94\text{dB}$
7	All emissions,radiated(>1G)	$\pm 3.03\text{dB}$
8	Temperature	$\pm 0.5^{\circ}\text{C}$
9	Humidity	$\pm 2\%$



## 2. GENERAL INFORMATION

### 2.1 GENERAL DESCRIPTION OF EUT

Equipment	3G Smartphone
Trade Name	EKS
Model Name	X3
Series Model	N/A
Model Difference	N/A
Channel List	Please refer to the Note 2.
Bluetooth	Frequency:2402 – 2480 MHz Modulation: GFSK(1Mbps), $\pi/4$ -DQPSK(2Mbps), 8-DPSK(3Mbps)
Adapter	Input: AC100-240V, 150mA, 50/60 Hz Output: DC 5V, 500mA
Battery	Rated Voltage: 3.7V capacity :1200mAh
Hardware version number	S8-MB-V0.3A
Software versioning number	S8_RQWP_M301E_XTR_MCP32_4_G4_W25_WV GA_T1_V0.6_151116
Connecting I/O Port(s)	Please refer to the User's Manual

Note:

1. For a more detailed features description, please refer to the manufacturer's specifications or the User's Manual.





2.

Channel List					
Channel	Frequency (MHz)	Channel	Frequency (MHz)	Channel	Frequency (MHz)
00	2402	27	2429	54	2456
01	2403	28	2430	55	2457
02	2404	29	2431	56	2458
03	2405	30	2432	57	2459
04	2406	31	2433	58	2460
05	2407	32	2434	59	2461
06	2408	33	2435	60	2462
07	2409	34	2436	61	2463
08	2410	35	2437	62	2464
09	2411	36	2438	63	2465
10	2412	37	2439	64	2466
11	2413	38	2440	65	2467
12	2414	39	2441	66	2468
13	2415	40	2442	67	2469
14	2416	41	2443	68	2470
15	2417	42	2444	69	2471
16	2418	43	2445	70	2472
17	2419	44	2446	71	2473
18	2420	45	2447	72	2474
19	2421	46	2448	73	2475
20	2422	47	2449	74	2476
21	2423	48	2450	75	2477
22	2424	49	2451	76	2478
23	2425	50	2452	77	2479
24	2426	51	2453	78	2480
25	2427	52	2454		
26	2428	53	2455		

3. Table for Filed Antenna

Ant	Brand	Model Name	Antenna Type	Connector	Gain (dBi)	NOTE
1	EKS	X3	PIFA Antenna	N/A	3	BT Antenna

The EUT antenna is PIFA Antenna. no antenna other than that furnished by the responsible party shall be used with the device.



## 2.2 DESCRIPTION OF TEST MODES

To investigate the maximum EMI emission characteristics generates from EUT, the test system was pre-scanning tested base on the consideration of following EUT operation mode or test configuration mode which possible have effect on EMI emission level. Each of these EUT operation mode(s) or test configuration mode(s) mentioned above was evaluated respectively.

Pretest Mode	Description
Mode 1	CH00
Mode 2	CH39
Mode 3	CH78
Mode 4	Charging + Keeping TX mode

For Conducted Emission	
Final Test Mode	Description
Mode 4	Charging + Keeping TX mode

For Radiated Emission	
Final Test Mode	Description
Mode 1	CH00
Mode 2	CH39
Mode 3	CH78
Mode 4	Charging + Keeping TX mode

Note:

- (1) The measurements are performed at the highest, middle, lowest available channels.
- (2) We have be tested for all avaiable U.S. voltage and frequencies(For 120V,50/60Hz and 240V, 50/60Hz) for which the device is capable of operation.

## 2.3 TABLE OF PARAMETERS OF TEXT SOFTWARE SETTING

During testing channel & power controlling software provided by the customer was used to control the operating channel as well as the output power level. The RF output power selection is for the setting of RF output power expected by the customer and is going to be fixed on the firmware of the final end product power parameters of FHSS

Test software Version	Test program: N/A		
Frequency	2402 MHz	2441 MHz	2480 MHz
Parameters(1Mbps)	DEF	DEF	DEF

## 2.4 BLOCK DIGRAM SHOWING THE CONFIGURATION OF SYSTEM TESTED

During testing channel & power controlling software provided by the customer was used to control the operating channel as well as the output power level. The RF output power selection is for the setting of RF output power expected by the customer and is going to be fixed on the firmware of the final end product power parameters of FHSS

### Radiated Spurious Emission Test

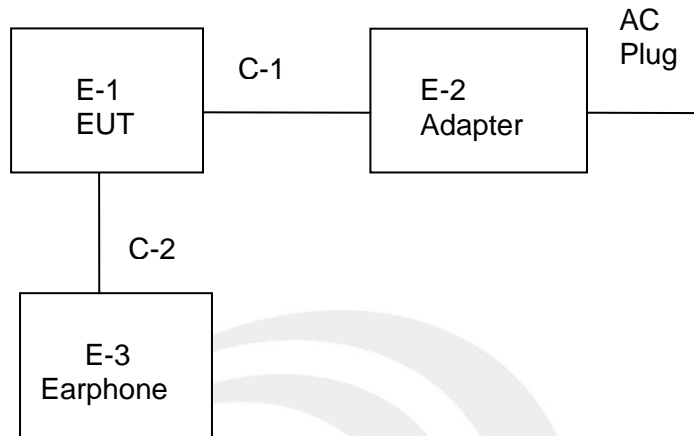

### Conducted Emission Test

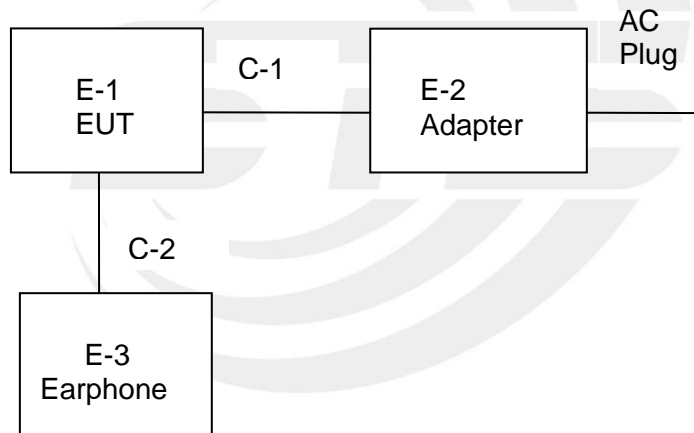



## 2.5 DESCRIPTION OF SUPPORT UNITS

The EUT has been tested as an independent unit together with other necessary accessories or support units. The following support units or accessories were used to form a representative test configuration during the tests.

Item	Equipment	Mfr/Brand	Model/Type No.	Serial No.	Note
E-1	3G Smartphone	EKS	X3	N/A	EUT
E-2	Adapter	XTR	m301e	N/A	EUT
E-3	Earphone	N/A	N/A	N/A	EUT

Item	Shielded Type	Ferrite Core	Length	Note
C-1	unshielded	NO	102cm	N/A
C-2	Unshielded	NO	121cm	N/A

Note:

- (1) The support equipment was authorized by Declaration of Confirmation.
- (2) For detachable type I/O cable should be specified the length in cm in 『Length』 column.
- (3) “YES” is means “shielded” “with core”; “NO” is means “unshielded” “without core”.



## 2.6 EQUIPMENTS LIST FOR ALL TEST ITEMS

## Radiation Test equipment

Kind of Equipment	Manufacturer	Type No.	Serial No.	Last calibration	Calibrated until
Spectrum Analyzer	Agilent	E4407B	MY50140340	2015.10.25	2016.10.24
Test Receiver	R&S	ESCI	101427	2015.10.25	2016.10.24
Bilog Antenna	TESEQ	CBL6111D	34678	2015.11.25	2016.11.24
Horn Antenna	Schwarzbeck	BBHA 9120D(1201)	9120D-1343	2015.03.06	2016.03.05
50Ω Coaxial Switch	Anritsu	MP59B	6200264416	2015.06.06	2016.06.05
PreAmplifier	Agilent	8449B	60538	2015.10.25	2016.10.24
Loop Antenna	ARA	PLA-1030/B	1029	2015.06.08	2016.06.07
USB RF power sensor	DARE	RPR3006W	15I00041SNO03	2015.10.25	2016.10.24
STS-E048	MXA SIGNAL Analyzer	Agilent	N9020A	2015.10.25	2016.10.24

## Conduction Test equipment

Kind of Equipment	Manufacturer	Type No.	Serial No.	Last calibration	Calibrated until
EMI Test Receiver	R&S	ESPI	102086	2015.11.20	2016.11.19
LISN	R&S	ENV216	101242	2015.10.25	2016.10.24
LISN	EMCO	3810/2NM	000-23625	2015.10.25	2016.10.24



### 3. EMC EMISSION TEST

#### 3.1 CONDUCTED EMISSION MEASUREMENT

##### 3.1.1 POWER LINE CONDUCTED EMISSION LIMITS

Operating frequency band. In case the emission fall within the restricted band specified on Part 15.247&207(a) limit in the table below has to be followed.

FREQUENCY (MHz)	Class B (dBuV)		Standard
	Quasi-peak	Average	
0.15 -0.5	66 - 56 *	56 - 46 *	CISPR
0.50 -5.0	56.00	46.00	CISPR
5.0 -30.0	60.00	50.00	CISPR

0.15 -0.5	66 - 56 *	56 - 46 *	FCC
0.50 -5.0	56.00	46.00	FCC
5.0 -30.0	60.00	50.00	FCC

Note:

- (1) The tighter limit applies at the band edges.
- (2) The limit of " \* " marked band means the limitation decreases linearly with the logarithm of the frequency in the range.

The following table is the setting of the receiver

Receiver Parameters	Setting
Attenuation	10 dB
Start Frequency	0.15 MHz
Stop Frequency	30 MHz
IF Bandwidth	9 kHz

### 3.1.2 TEST PROCEDURE

- a. The EUT was placed 0.4 meters from the horizontal ground plane with EUT being connected to the power mains through a line impedance stabilization network (LISN). All other support equipments powered from additional LISN(s). The LISN provide 50 Ohm/ 50uH of coupling impedance for the measuring instrument.
- b. Interconnecting cables that hang closer than 40 cm to the ground plane shall be folded back and forth in the center forming a bundle 30 to 40 cm long.
- c. I/O cables that are not connected to a peripheral shall be bundled in the center. The end of the cable may be terminated, if required, using the correct terminating impedance. The overall length shall not exceed 1 m.
- d. LISN at least 80 cm from nearest part of EUT chassis.
- e. For the actual test configuration, please refer to the related Item –EUT Test Photos.

### 3.1.3 TEST SETUP

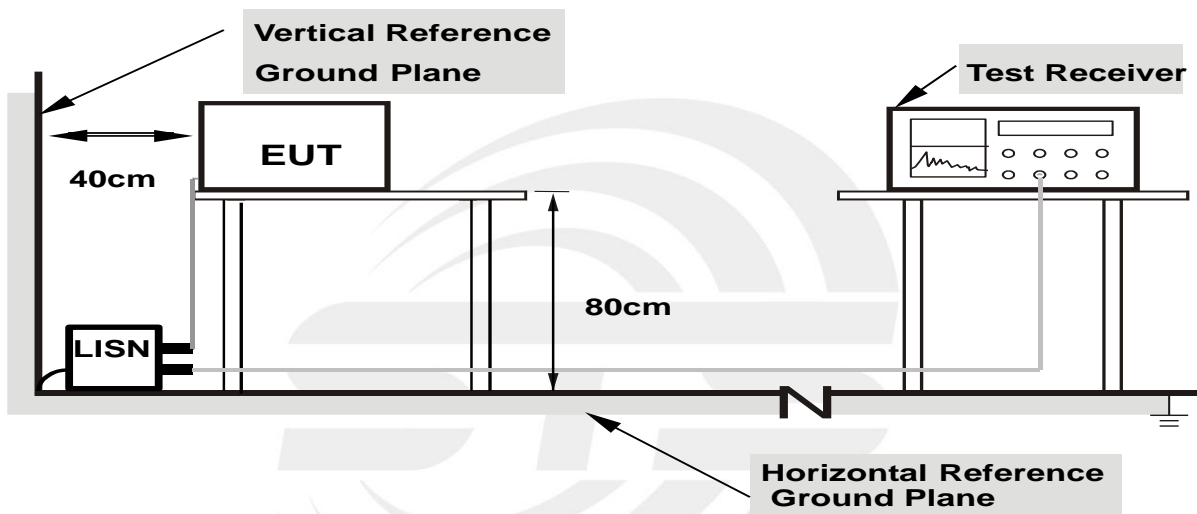

- Note: 1.Support units were connected to second LISN.**  
**2.Both of LISNs (AMN) are 80 cm from EUT and at least 80 cm from other units and other metal planes**

### 3.1.4 EUT OPERATING CONDITIONS

The EUT was configured for testing in a typical fashion (as a customer would normally use it). The EUT has been programmed to continuously transmit during test. This operating condition was tested and used to collect the included data.



3.1.5 TEST RESULTS

EUT:	3G Smartphone	Model Name.:	X3
Temperature:	26 °C	Relative Humidity:	54%
Pressure:	1010hPa	Phase:	L
Test Voltage:	DC 5V from Adapter AC120V/60Hz	Test Mode:	Mode 4

Frequency (MHz)	Reading (dBuV)	Correct Factor(dB)	Result (dBuV)	Limit (dBuV)	Margin (dB)	Remark
0.1860	46.92	10.00	56.92	64.21	-7.29	QP
0.1860	24.56	10.00	34.56	54.21	-19.65	AVG
0.2540	44.59	9.95	54.54	61.63	-7.09	QP
0.2540	22.57	9.95	32.52	51.63	-19.11	AVG
0.3260	42.61	9.98	52.59	59.55	-6.96	QP
0.3260	21.39	9.98	31.37	49.55	-18.18	AVG
1.0940	36.18	9.91	46.09	56.00	-9.91	QP
1.0940	10.46	9.91	20.37	46.00	-25.63	AVG
2.0820	36.81	10.00	46.81	56.00	-9.19	QP
2.0820	10.03	10.00	20.03	46.00	-25.97	AVG
16.7220	32.41	10.47	42.88	60.00	-17.12	QP
16.7220	20.27	10.47	30.74	50.00	-19.26	AVG

Remark:

- Factor = Antenna Factor + Cable Loss – Pre-amplifier.

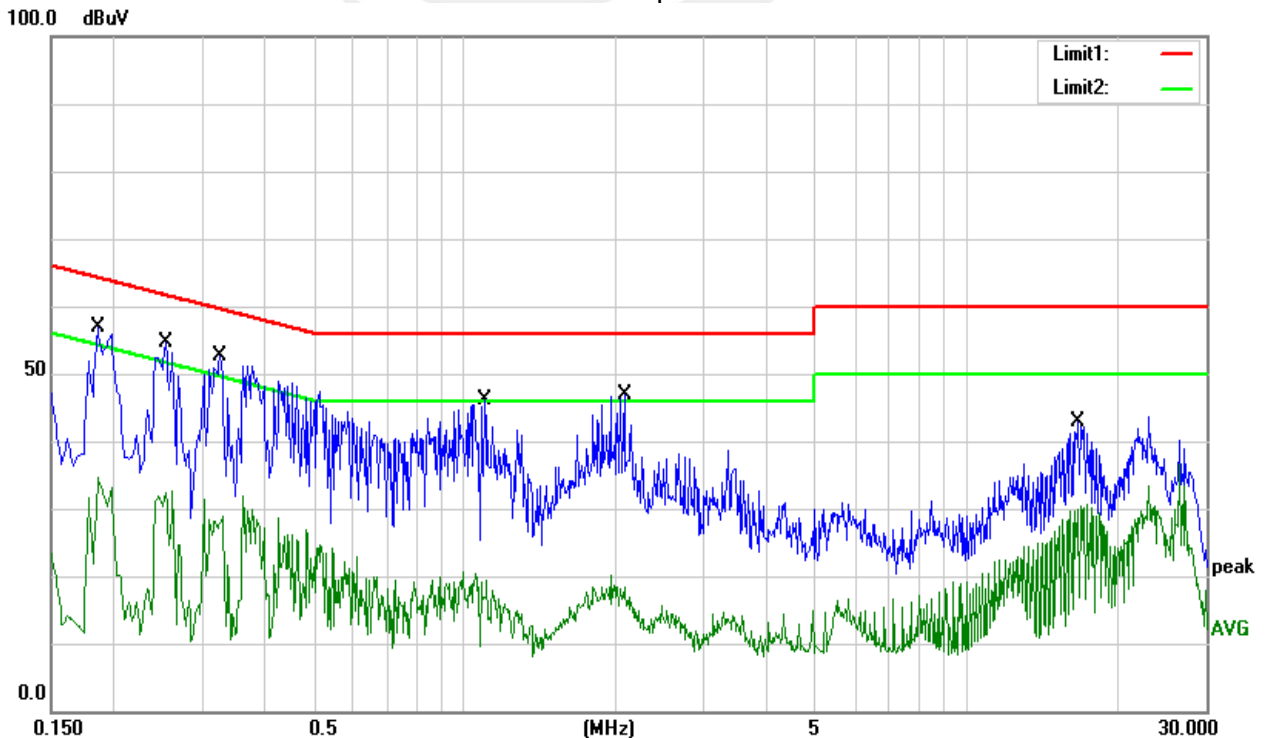





EUT:	3G Smartphone	Model Name.:	X3
Temperature:	26 °C	Relative Humidity:	54%
Pressure:	1010hPa	Phase:	N
Test Voltage:	DC 5V from Adapter AC120V/60Hz	Test Mode:	Mode 4

Frequency (MHz)	Reading (dBUV)	Correct Factor(dB)	Result (dBUV)	Limit (dBUV)	Margin (dB)	Remark
0.2020	42.66	10.00	52.66	63.53	-10.87	QP
0.2020	24.41	10.00	34.41	53.53	-19.12	AVG
0.3260	40.33	9.93	50.26	59.55	-9.29	QP
0.3260	20.07	9.93	30.00	49.55	-19.55	AVG
0.3780	39.49	9.98	49.47	58.32	-8.85	QP
0.3780	22.65	9.98	32.63	48.32	-15.69	AVG
1.0460	33.84	10.00	43.84	56.00	-12.16	QP
1.0460	17.17	10.00	27.17	46.00	-18.83	AVG
1.9060	34.71	10.00	44.71	56.00	-11.29	QP
1.9060	17.23	10.00	27.23	46.00	-18.77	AVG
16.7220	32.74	10.40	43.14	60.00	-16.86	QP
16.7220	21.34	10.40	31.74	50.00	-18.26	AVG

Remark:

1. Factor = Antenna Factor + Cable Loss – Pre-amplifier.

100.0 dBUV

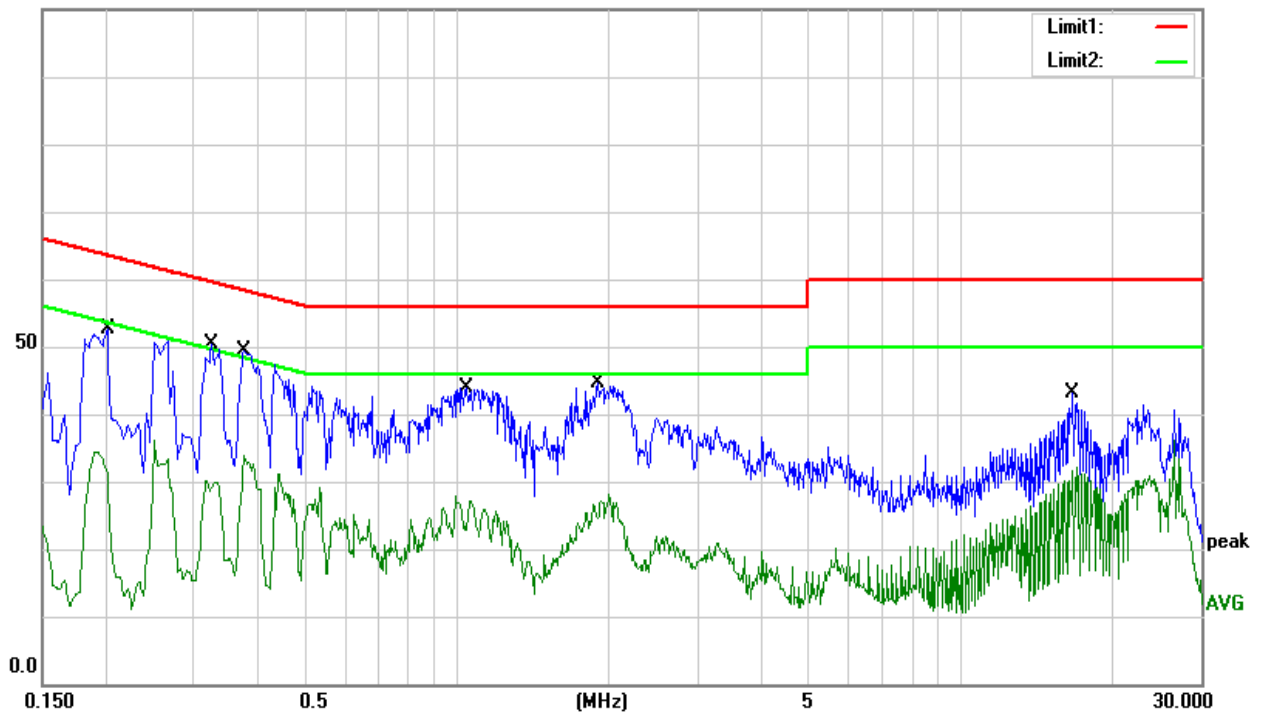



3.2 RADIATED EMISSION MEASUREMENT

3.2.1 RADIATED EMISSION LIMITS

20dBc in any 100 kHz bandwidth outside the operating frequency band. In case the emission fall within the restricted band specified on Part 15247&205(a), then the Part 15 247&209(a) limit in the table below has to be followed.

LIMITS OF RADIATED EMISSION MEASUREMENT (30MHz - 1000MHz)

Frequencies (MHz)	Field Strength (micorvolts/meter)	Measurement Distance (meters)
0.009~0.490	2400/F(KHz)	300
0.490~1.705	24000/F(KHz)	30
1.705~30.0	30	30
30~88	100	3
88~216	150	3
216~960	200	3
Above 960	500	3

LIMITS OF RADIATED EMISSION MEASUREMENT (Above 1000MHz)

FREQUENCY (MHz)	Class B (dBuV/m) (at 3M)	
	PEAK	AVERAGE
Above 1000	74	54

Notes:

- (1) The limit for radiated test was performed according to FCC PART 15C.
- (2) The tighter limit applies at the band edges.
- (3) Emission level (dBuV/m)=20log Emission level (uV/m).

FREQUENCY RANGE OF RADIATED MEASUREMENT (For unintentional radiators)

Highest frequency generated or Upper frequency of measurement used in the device or on which the device operates or tunes (MHz)	Range (MHz)
Below 1.705	30
1.705 – 108	1000
108 – 500	2000
500 – 1000	5000
Above 1000	5 <sup>th</sup> harmonic of the highest frequency or 40 GHz, whichever is lower



Spectrum Parameter	Setting
Attenuation	Auto
Detector	Peak
Start Frequency	1000 MHz(Peak/AV)
Stop Frequency	10th carrier harmonic(Peak/AV)
RB / VB (emission in restricted band)	1 MHz / 1 MHz, AV=10 Hz

Receiver Parameter	Setting
Attenuation	Auto
Start ~ Stop Frequency	9kHz~150kHz / RB 200Hz for QP
Start ~ Stop Frequency	150kHz~30MHz / RB 9kHz for QP
Start ~ Stop Frequency	30MHz~1000MHz / RB 120kHz for QP

### 3.2.2 TEST PROCEDURE

- The measuring distance of at 3 m shall be used for measurements at frequency up to 1GHz. For frequencies above 1GHz, any suitable measuring distance may be used.
- The EUT was placed on the top of a rotating table 0.8 meters(above 1GHz is 1.5 m) above the ground at a 3 meter open area test site. The table was rotated 360 degrees to determine the position of the highest radiation.
- The height of the equipment or of the substitution antenna shall be 0.8 m(above 1GHz is 1.5 m); the height of the test antenna shall vary between 1 m to 4 m. Both horizontal and vertical polarizations of the antenna are set to make the measurement.
- The initial step in collecting conducted emission data is a spectrum analyzer peak detector mode pre-scanning the measurement frequency range. Significant peaks are then marked and then Quasi Peak detector mode re-measured.
- If the Peak Mode measured value compliance with and lower than Quasi Peak Mode Limit, the EUT shall be deemed to meet QP Limits and then no additional QP Mode measurement performed.
- For the actual test configuration, please refer to the related Item –EUT Test Photos.

Note:

Both horizontal and vertical antenna polarities were tested and performed pretest to three orthogonal axis. The worst case emissions were reported

### 3.2.3 DEVIATION FROM TEST STANDARD

No deviation

### 3.2.4 TEST SETUP

(A) Radiated Emission Test-Up Frequency Below 30MHz

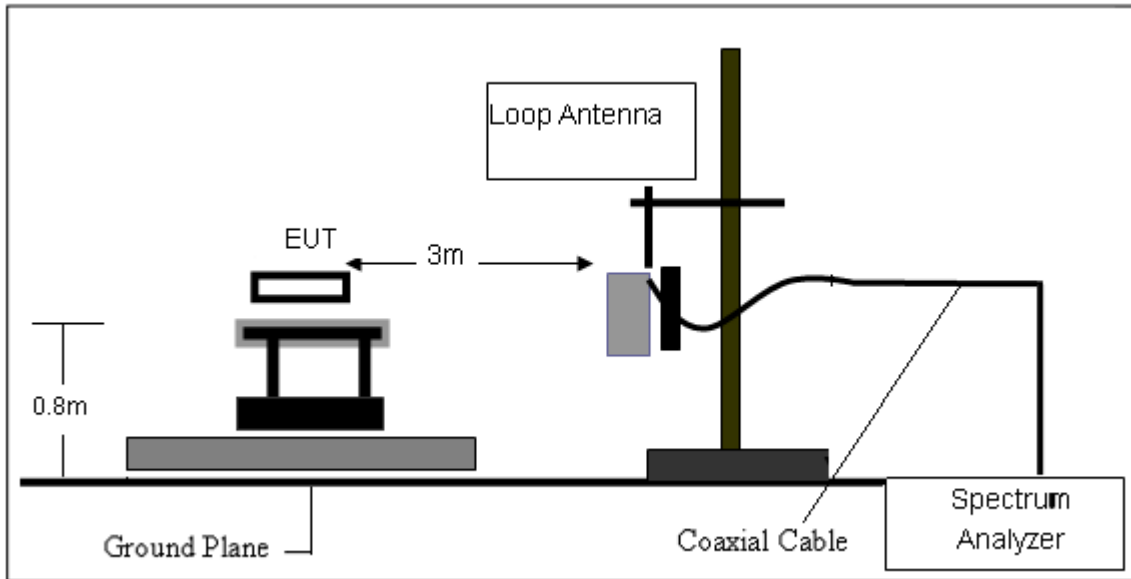

(B) Radiated Emission Test-Up Frequency 30MHz~1GHz

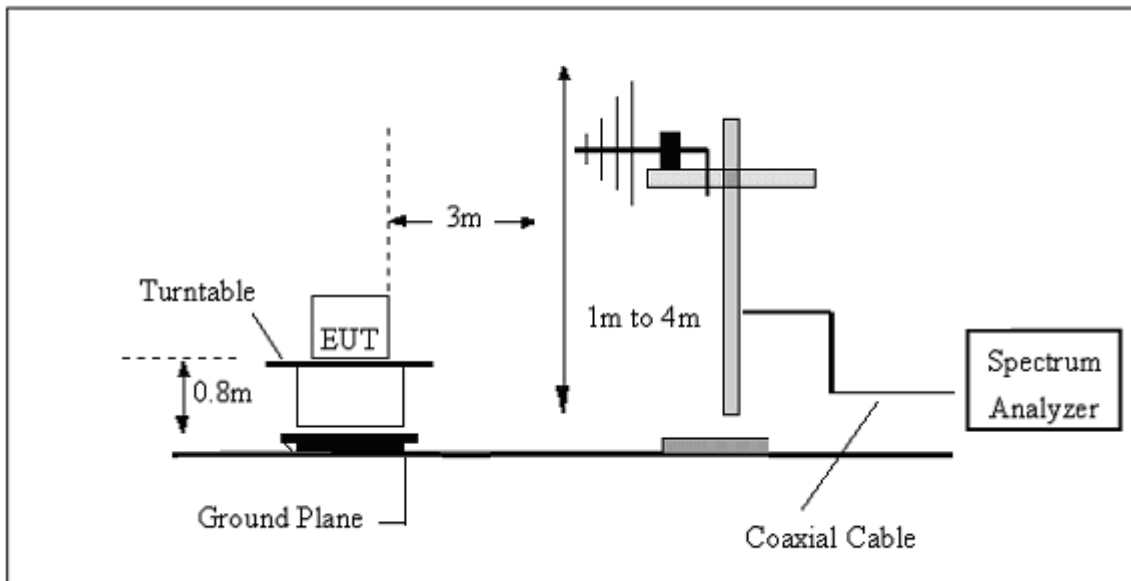

(C) Radiated Emission Test-Up Frequency Above 1GHz

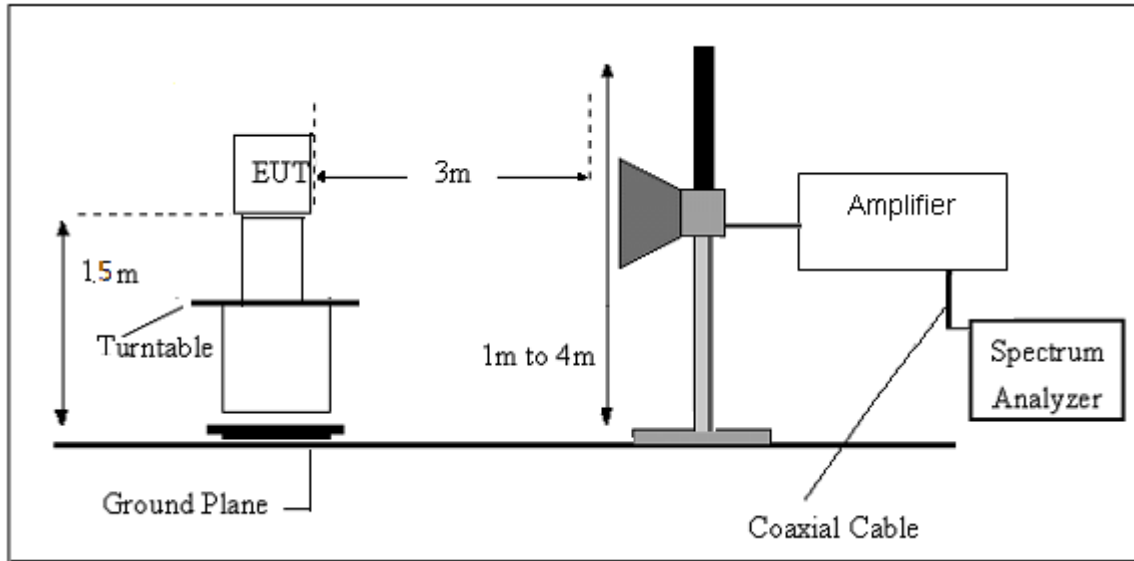

### 3.2.5 EUT OPERATING CONDITIONS

The EUT tested system was configured as the statements of 2.4 Unless otherwise a special operating condition is specified in the follows during the testing.



### 3.2.6 TEST RESULTS

Below 30MHz

EUT:	3G Smartphone	Model Name.:	X3
Temperature:	26 °C	Relative Humidity:	54%
Pressure:	1010hPa	Test Mode:	Mode 4
Test Voltage:	DC 5V from Adapter AC120V/60Hz		

Freq. (MHz)	Reading (dBuV/m)	Limit (dBuV/m)	Margin (dB)	State P/F	Test Result
--	--	--	--	--	--
--	--	--	--	--	--

**NOTE:**

The amplitude of spurious emissions which are attenuated by more than 20dB below the permissible value has no need to be reported.

Distance extrapolation factor =  $40 \log(\text{specific distance}/\text{test distance})$ (dB);

Limit line = specific limits(dBuV) + distance extrapolation factor.



Between 30-1000MHz

EUT:	3G Smartphone	Model Name.:	X3
Temperature:	26 °C	Relative Humidity:	54%
Pressure:	1010hPa	Phase:	Horizontal
Test Voltage:	DC 5V from Adapter AC120V/60Hz	Test Mode:	Mode 4

Frequency (MHz)	Reading (dBuV)	Correct Factor(dB/m)	Result (dBuV/m)	Limit (dBuV/m)	Margin (dB)	Remark
77.8654	11.24	7.63	18.87	40.00	-21.13	QP
94.0980	9.49	10.05	19.54	43.50	-23.96	QP
178.7584	13.07	10.23	23.30	43.50	-20.20	QP
260.1444	9.43	14.95	24.38	46.00	-21.62	QP
285.9778	10.53	14.26	24.79	46.00	-21.21	QP
689.5644	9.58	23.36	32.94	46.00	-13.06	QP

Remark:

1. Factor = Antenna Factor + Cable Loss – Pre-amplifier.

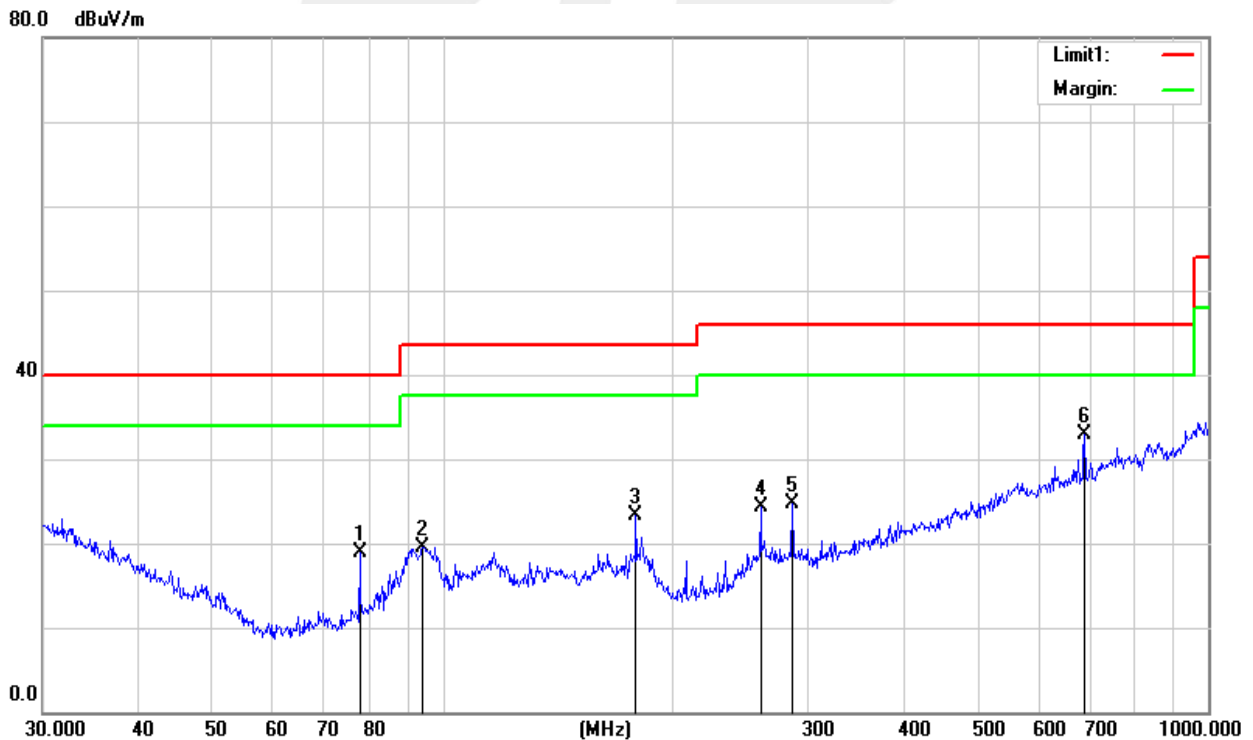



EUT:	3G Smartphone	Model Name.:	X3
Temperature:	26 °C	Relative Humidity:	54%
Pressure:	1010hPa	Phase:	Vertical
Test Voltage:	DC 5V from Adapter AC120V/60Hz	Test Mode:	Mode 4

Frequency (MHz)	Reading (dBuV)	Correct Factor(dB/m)	Result (dBuV/m)	Limit (dBuV/m)	Margin (dB)	Remark
30.1054	4.77	18.65	23.42	40.00	-16.58	QP
77.8654	15.13	7.63	22.76	40.00	-17.24	QP
91.8163	10.66	9.72	20.38	43.50	-23.12	QP
115.7256	8.16	12.23	20.39	43.50	-23.11	QP
158.1123	10.45	11.69	22.14	43.50	-21.36	QP
285.9778	6.51	14.26	20.77	46.00	-25.23	QP

Remark:

- Factor = Antenna Factor + Cable Loss – Pre-amplifier.

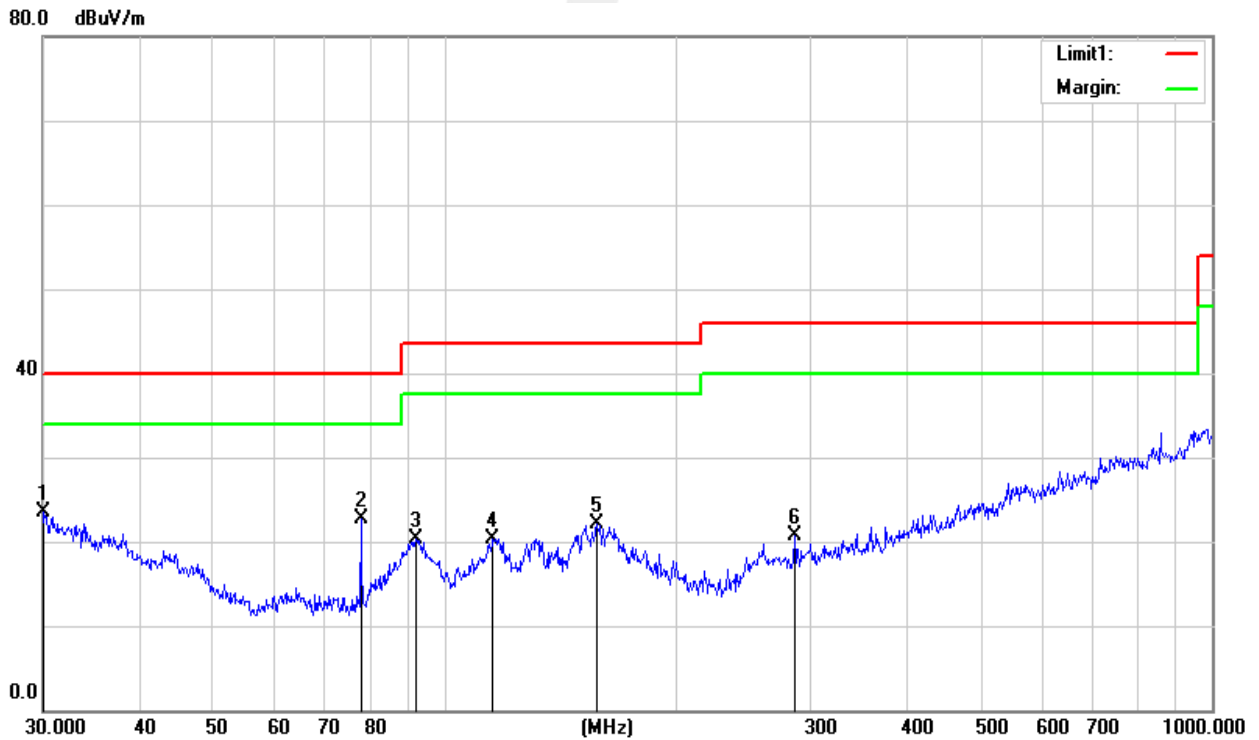





Above 1000 MHz

Frequency (MHz)	Meter Reading (dB $\mu$ V)	Factor (dB)	Emission Level (dB $\mu$ V/m)	Limits (dB $\mu$ V/m)	Margin (dB)	Detector Type	Comment
Low Channel (2402 MHz)							
4804.20	66.11	-3.62	62.49	74	-11.51	PK	Vertical
4804.21	46.15	-3.62	42.53	54	-11.47	AV	Vertical
7206.13	61.47	-0.9	60.57	74	-13.43	PK	Vertical
7206.12	40.81	-0.9	39.91	54	-14.09	AV	Vertical
4804.00	61.60	-3.65	57.95	74	-16.05	PK	Horizontal
4803.99	44.21	-3.65	40.56	54	-13.44	AV	Horizontal
Mid Channel (2441 MHz)							
4882.09	64.26	-3.65	60.61	74	-13.39	PK	Vertical
4882.07	49.16	-3.65	45.51	54	-8.49	AV	Vertical
7323.22	60.47	-0.84	59.63	74	-14.37	PK	Vertical
7323.21	44.04	-0.84	43.2	54	-10.8	AV	Vertical
4882.18	61.02	-3.68	57.34	74	-16.66	PK	Horizontal
4882.15	44.76	-3.68	41.08	54	-12.92	AV	Horizontal
High Channel (2480 MHz)							
4960.26	60.58	-3.59	56.99	74	-17.01	PK	Vertical
4960.30	45.11	-3.59	41.52	54	-12.48	AV	Vertical
7440.32	60.82	-0.83	59.99	74	-14.01	PK	Vertical
7440.31	45.12	-0.83	44.29	54	-9.71	AV	Vertical
4960.33	60.64	-3.59	57.05	74	-16.95	PK	Horizontal
4960.31	44.81	-3.59	41.22	54	-12.78	AV	Horizontal

Note:

- 1) 30MHz~25GHz:(Scan with GFSK,  $\pi/4$ -DQPSK,8DPSK, the worst case is GFSK Mode)
- 2) Factor = Antenna Factor + Cable Loss – Pre-amplifier.  
Emission Level = Meter Reading + Factor  
Margin = Limit - Emission Level



Band edge

Frequency (MHz)	Meter Reading (dBμV)	Factor (dB)	Emission Level (dBμV/m)	Limits (dBμV/m)	Margin (dB)	Detector Type	Comment
GFSK							
2390.0	67.29	-12.99	54.3	74	-19.7	PK	Vertical
2390.0	53.00	-12.99	40.01	54	-13.99	AV	Vertical
2390.0	67.94	-12.99	54.95	74	-19.05	PK	Horizontal
2390.0	51.88	-12.99	38.89	54	-15.11	AV	Horizontal
2483.6	68.61	-12.78	55.83	74	-18.17	PK	Vertical
2483.6	51.99	-12.78	39.21	54	-14.79	AV	Vertical
2483.6	68.89	-12.78	56.11	74	-17.89	PK	Horizontal
2483.6	51.58	-12.78	38.8	54	-15.2	AV	Horizontal
π/4-DQPSK							
2390.0	69.16	-12.99	56.17	74	-17.83	PK	Vertical
2390.0	52.02	-12.99	39.03	54	-14.97	AV	Vertical
2390.0	67.83	-12.99	54.84	74	-19.16	PK	Horizontal
2390.0	52.28	-12.99	39.29	54	-14.71	AV	Horizontal
2483.6	69.17	-12.78	56.39	74	-17.61	PK	Vertical
2483.6	53.75	-12.78	40.97	54	-13.03	AV	Vertical
2483.6	68.65	-12.78	55.87	74	-18.13	PK	Horizontal
2483.6	52.18	-12.78	39.4	54	-14.6	AV	Horizontal
8DPSK							
2390.0	69.19	-12.99	56.2	74	-17.8	PK	Vertical
2390.0	52.93	-12.99	39.94	54	-14.06	AV	Vertical
2390.0	68.10	-12.99	55.11	74	-18.89	PK	Horizontal
2390.0	54.20	-12.99	41.21	54	-12.79	AV	Horizontal
2483.6	69.03	-12.78	56.25	74	-17.75	PK	Vertical
2483.6	52.83	-12.78	40.05	54	-13.95	AV	Vertical
2483.6	69.14	-12.78	56.36	74	-17.64	PK	Horizontal
2483.6	52.20	-12.78	39.42	54	-14.58	AV	Horizontal

Low measurement frequencies is range from 2310 to 2400 MHz, high measurement frequencies is range from 2483.5 to 2500 MHz.

Only show the worst point data of the emissions in the frequency 2310-2400 MHz and 2483.5-2500 MHz.



## Hopping

Frequency (MHz)	Meter Reading (dB $\mu$ V)	Factor (dB)	Emission Level (dB $\mu$ V/m)	Limits (dB $\mu$ V/m)	Margin (dB)	Detector Type	Comment
GFSK							
2390.0	68.20	-12.99	55.21	74	-18.79	PK	Vertical
2390.0	53.84	-12.99	40.85	54	-13.15	AV	Vertical
2390.0	67.34	-12.99	54.35	74	-19.65	PK	Horizontal
2390.0	53.01	-12.99	40.02	54	-13.98	AV	Horizontal
2483.5	66.05	-12.78	53.27	74	-20.73	PK	Vertical
2483.5	53.92	-12.78	41.14	54	-12.86	AV	Vertical
2483.5	66.76	-12.78	53.98	74	-20.02	PK	Horizontal
2483.5	53.74	-12.78	40.96	54	-13.04	AV	Horizontal
$\pi/4$ -DQPSK							
2390.0	67.91	-12.99	54.92	74	-19.08	PK	Vertical
2390.0	54.87	-12.99	41.88	54	-12.12	AV	Vertical
2390.0	66.65	-12.99	53.66	74	-20.34	PK	Horizontal
2390.0	53.09	-12.99	40.1	54	-13.9	AV	Horizontal
2483.5	66.94	-12.78	54.16	74	-19.84	PK	Vertical
2483.5	52.74	-12.78	39.96	54	-14.04	AV	Vertical
2483.5	68.11	-12.78	55.33	74	-18.67	PK	Horizontal
2483.5	54.07	-12.78	41.29	54	-12.71	AV	Horizontal
8DPSK							
2390.0	67.83	-12.99	54.84	74	-19.16	PK	Vertical
2390.0	53.64	-12.99	40.65	54	-13.35	AV	Vertical
2390.0	66.94	-12.99	53.95	74	-20.05	PK	Horizontal
2390.0	53.95	-12.99	40.96	54	-13.04	AV	Horizontal
2483.5	67.99	-12.78	55.21	74	-18.79	PK	Vertical
2483.5	54.23	-12.78	41.45	54	-12.55	AV	Vertical
2483.5	66.90	-12.78	54.12	74	-19.88	PK	Horizontal
2483.5	53.74	-12.78	40.96	54	-13.04	AV	Horizontal

Low measurement frequencies is range from 2310 to 2400 MHz, high measurement frequencies is range from 2483.5 to 2500 MHz.

Only show the worst point data of the emissions in the frequency 2310-2400 MHz and 2483.5-2500 MHz.

#### 4. CONDUCTED SPURIOUS EMISSIONS

##### 4.1 REQUIREMENT

According to FCC section 15.247(d), in any 100kHz bandwidth outside the frequency band in which the spread spectrum or digitally modulated intentional radiator is operating, the radio frequency power that is produced by the intentional radiator shall be at least 20dB below that in the 100kHz bandwidth within the band that contains the highest level of the desired power, based on either an RF conducted or a radiated measurement.

##### 4.2 TEST PROCEDURE

According to FCC section 15.247(d), in any 100kHz bandwidth outside the frequency band in which the spread spectrum or digitally modulated intentional radiator is operating, the radio frequency power that is produced by the intentional radiator shall be at least 20dB below that in the 100kHz bandwidth within the band that contains the highest level of the desired power, based on either an RF conducted or a radiated measurement.

Spectrum Parameter	Setting
Detector	Peak
Start/Stop Frequency	30 MHz to 10th carrier harmonic
RB / VB (emission in restricted band)	100 KHz/300 KHz
Trace-Mode:	Max hold

For Band edge

Spectrum Parameter	Setting
Detector	Peak
Start/Stop Frequency	Lower Band Edge: 2310 – 2404 MHz Upper Band Edge: 2478 – 2500 MHz
RB / VB (emission in restricted band)	100 KHz/300 KHz
Trace-Mode:	Max hold

Remark : Hopping on and Hopping off mode all have been tested, only worst case hopping off is reported.

##### 4.3 TEST SETUP

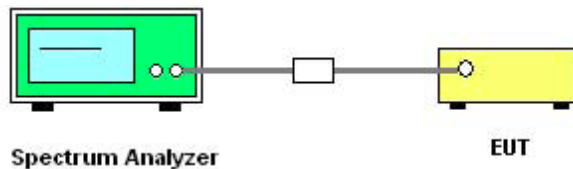

The EUT which is powered by the Battery, is coupled to the Spectrum Analyzer; the RF load attached to the EUT antenna terminal is 50Ohm; the path loss as the factor is calibrated to correct the reading. Make the measurement with the spectrum analyzer's resolution bandwidth(RBW) = 100 kHz. In order to make an accurate measurement, set the span greater than RBW.

##### 4.4 EUT OPERATION CONDITIONS

The EUT tested system was configured as the statements of 2.3 Unless otherwise a special operating condition is specified in the follows during the testing.



4.5 TEST RESULTS

EUT :	3G Smartphone	Model Name :	X3
Temperature :	25 °C	Relative Humidity :	50%
Pressure :	1012 hPa	Test Voltage :	DC 3.7V
Test Mode :	GFSK(1Mbps)-00/39/78 CH		

00 CH

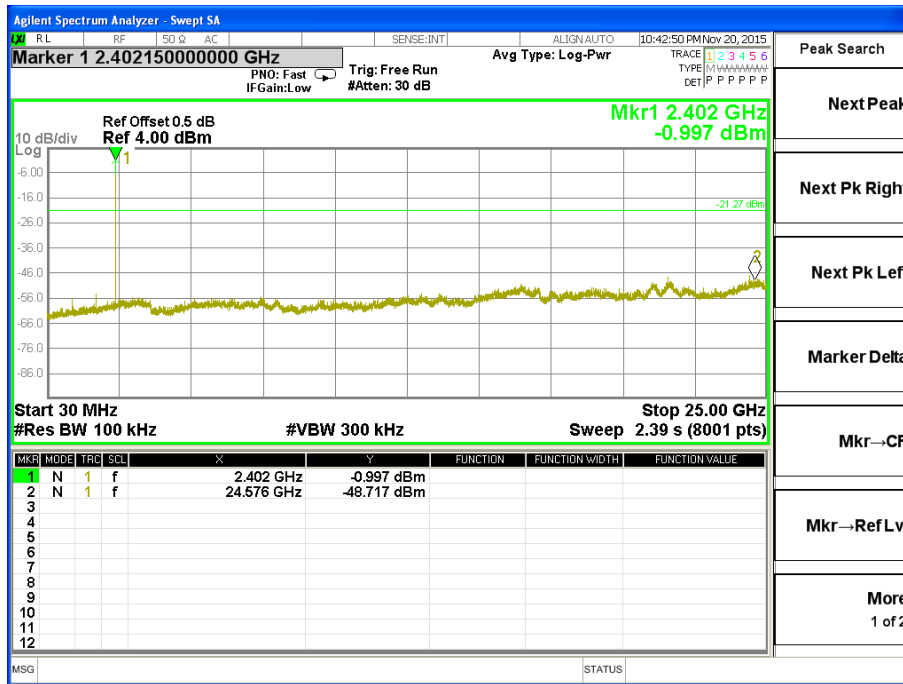

39 CH

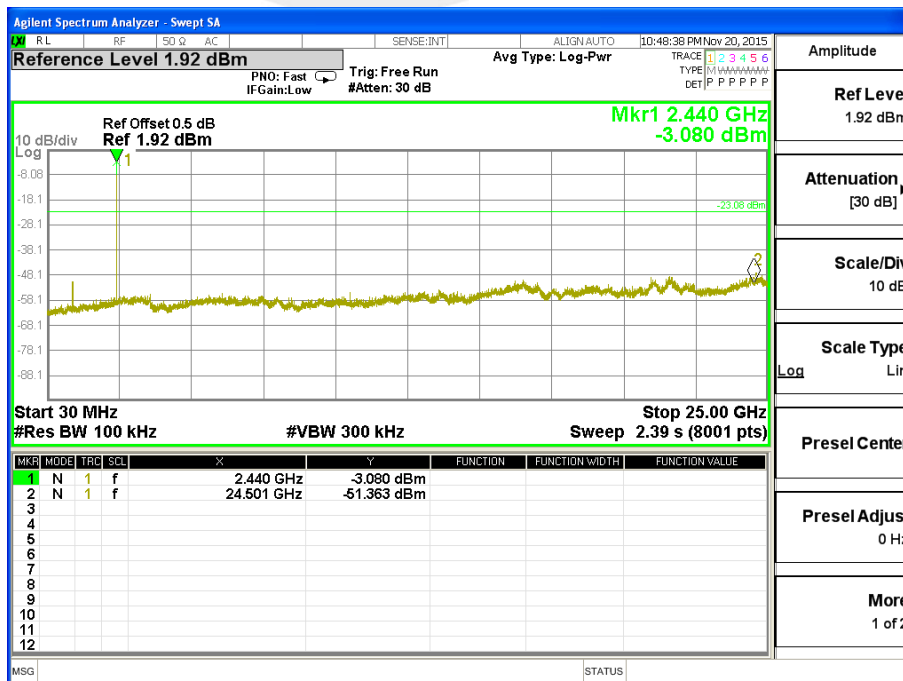



78 CH

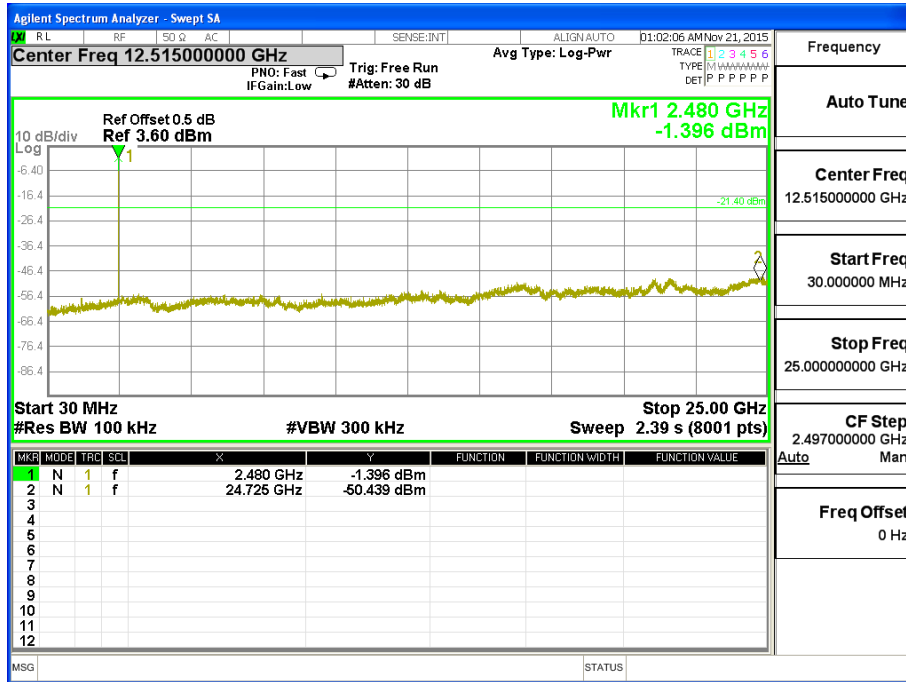



For Band edge

00 CH

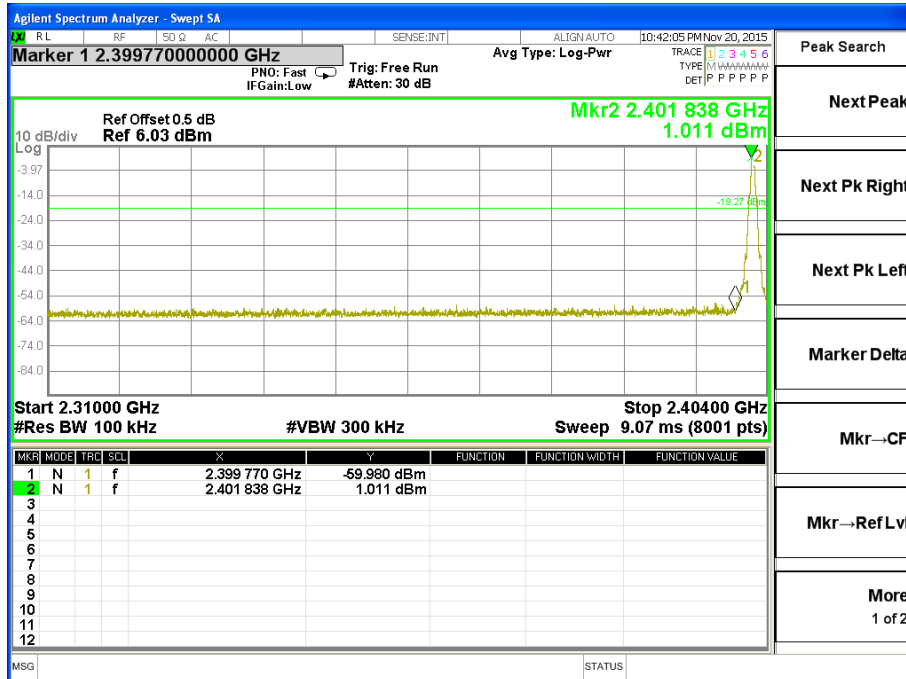

78 CH

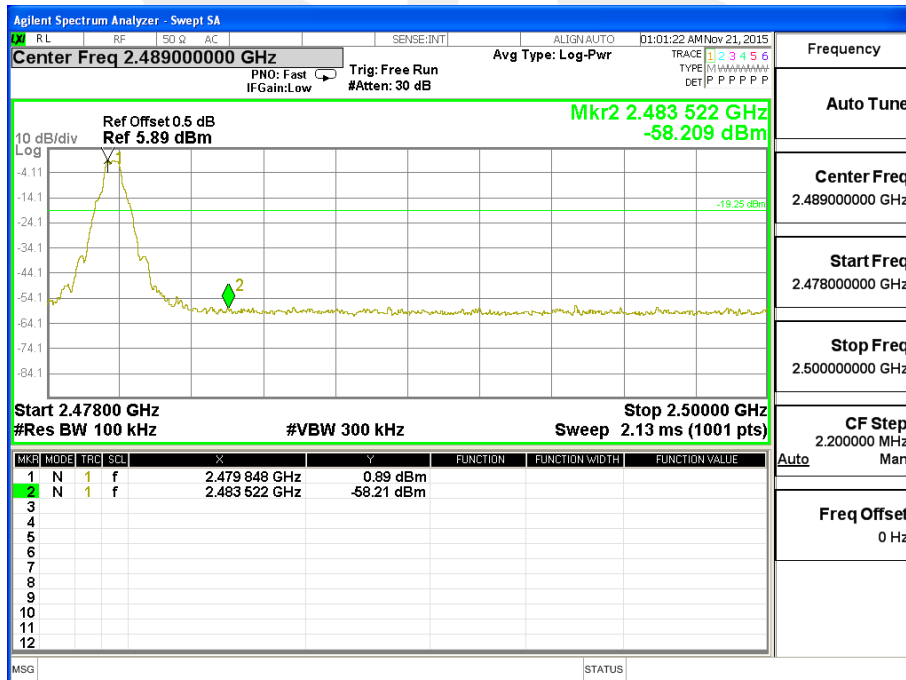



For Hopping Band edge

00 CH

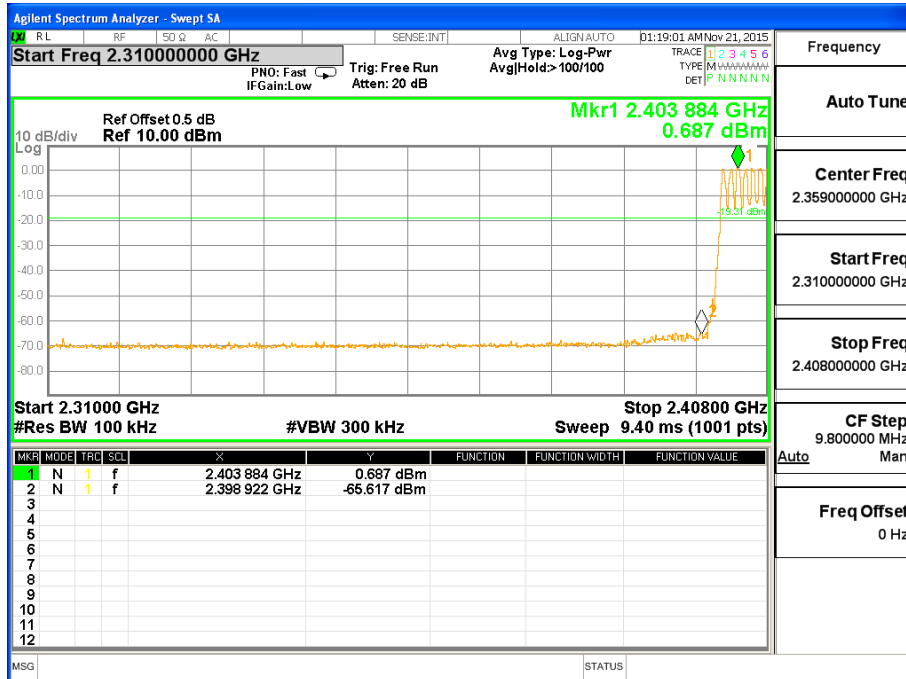

78 CH

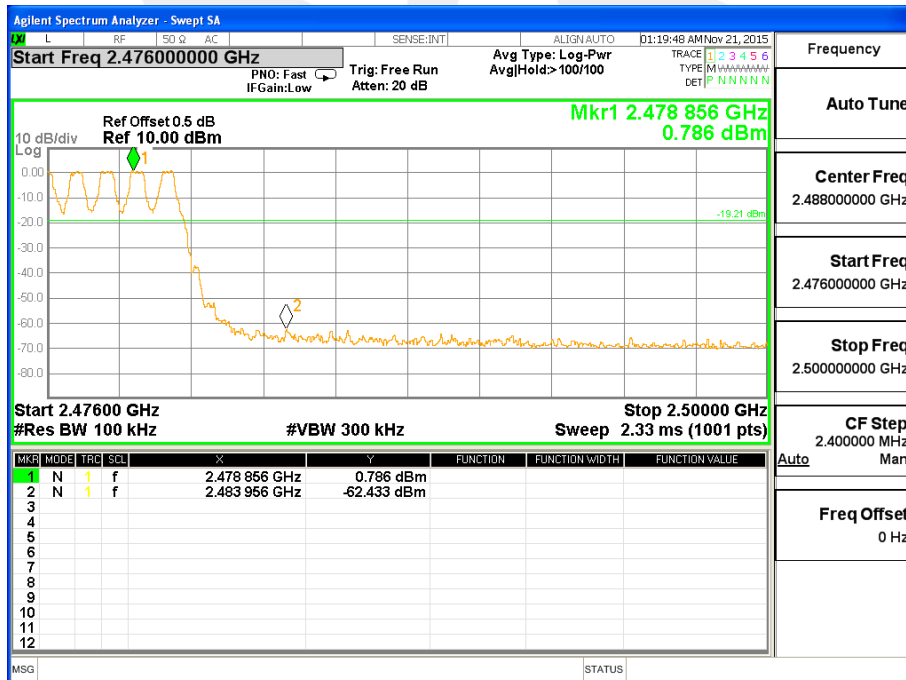





EUT :	3G Smartphone	Model Name :	X3
Temperature :	25 °C	Relative Humidity :	50%
Pressure :	1012 hPa	Test Voltage :	DC 3.7V
Test Mode :	$\pi/4$ -DQPSK(2Mbps) -00/39/78 CH		

00 CH

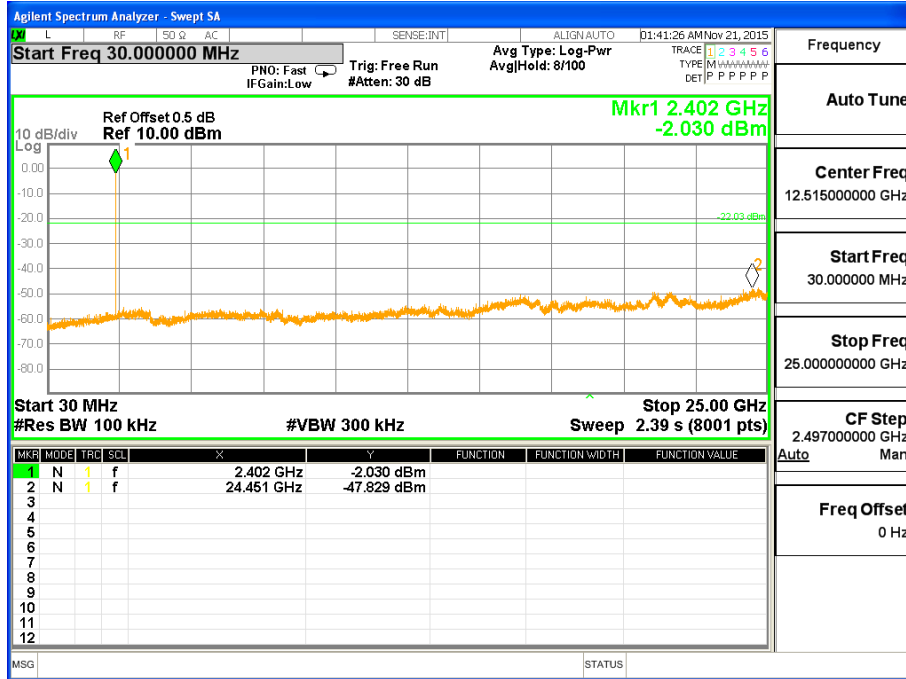

39 CH

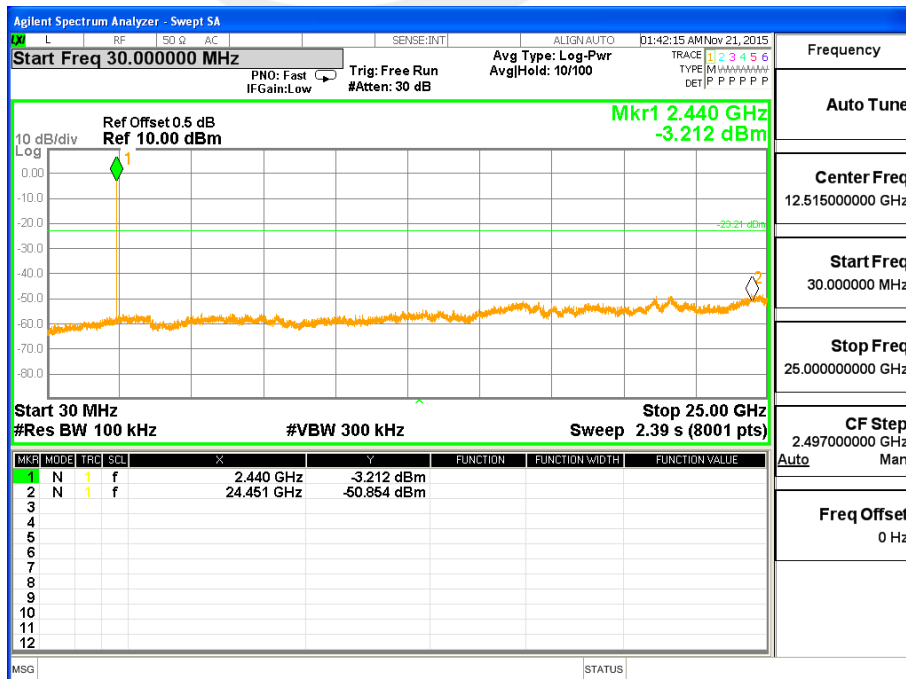



78 CH

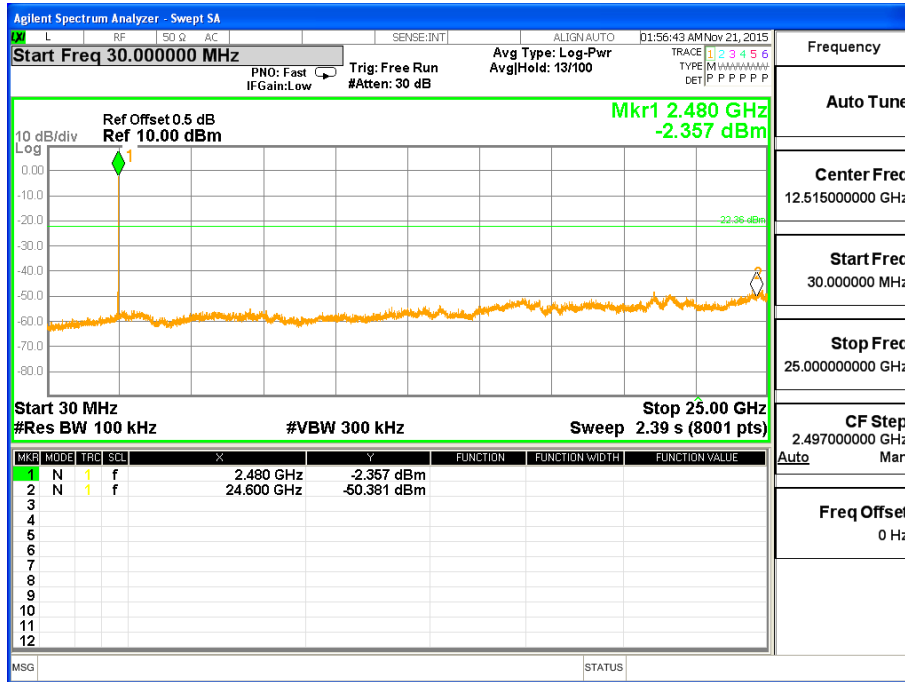



For Band edge

00 CH

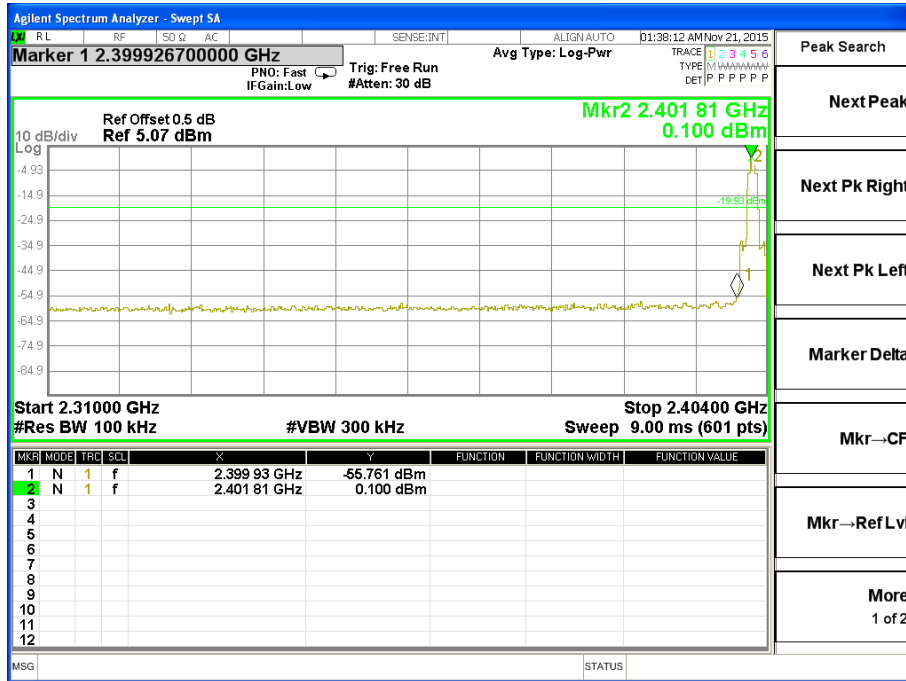

78 CH

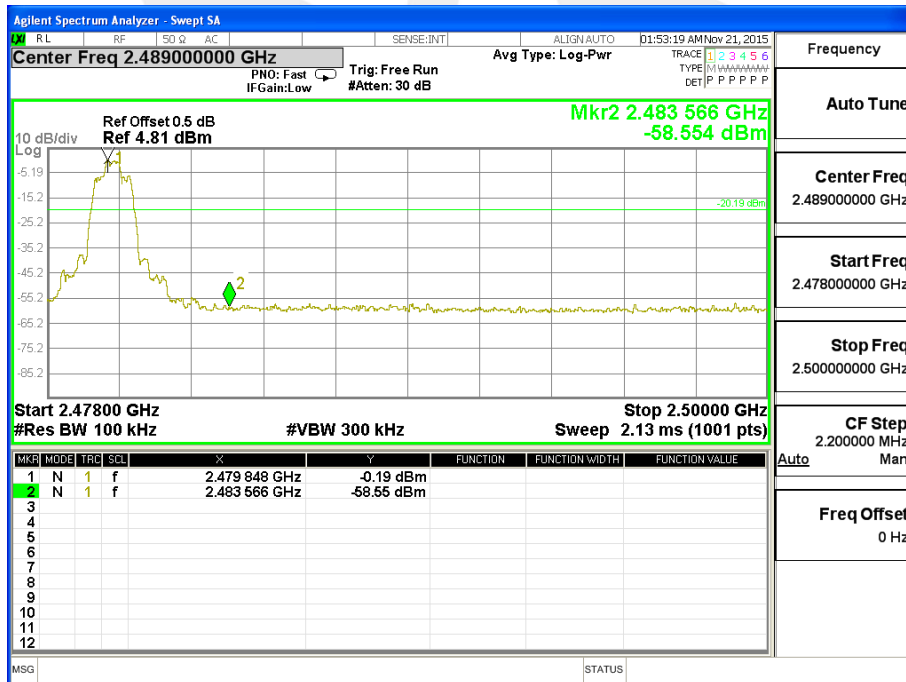



For Hopping Band edge

00 CH

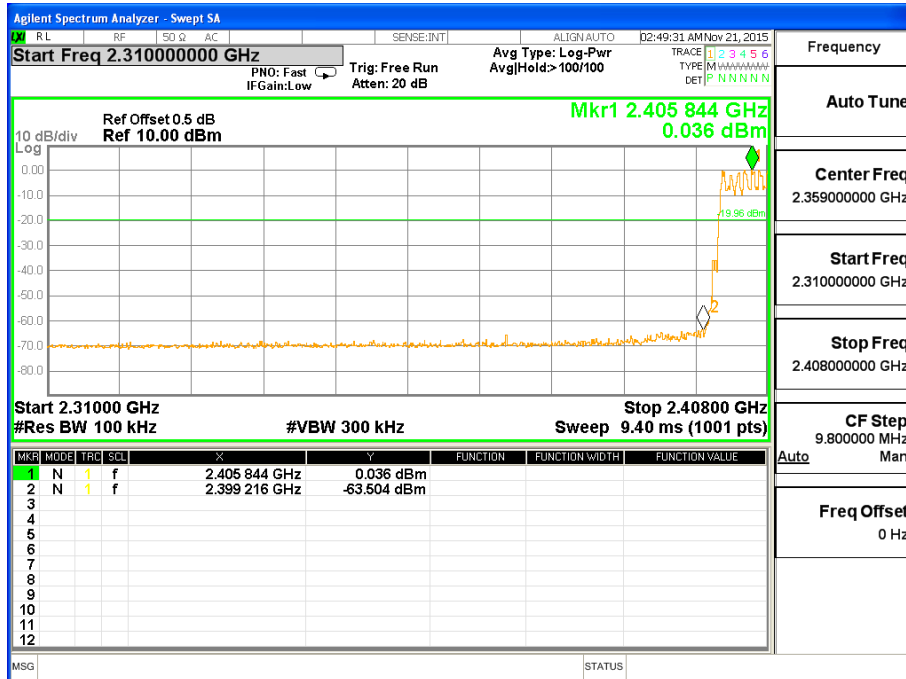

78 CH

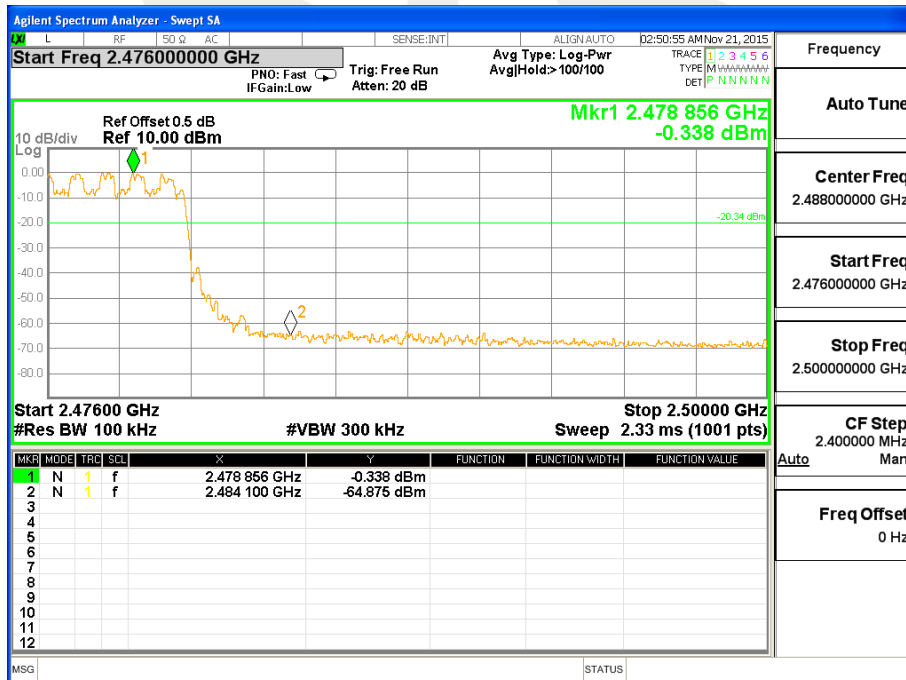



EUT :	3G Smartphone	Model Name :	X3
Temperature :	25 °C	Relative Humidity :	50%
Pressure :	1012 hPa	Test Voltage :	DC 3.7V
Test Mode :	8-DPSK(3Mbps) -00/39/78 CH		

00 CH

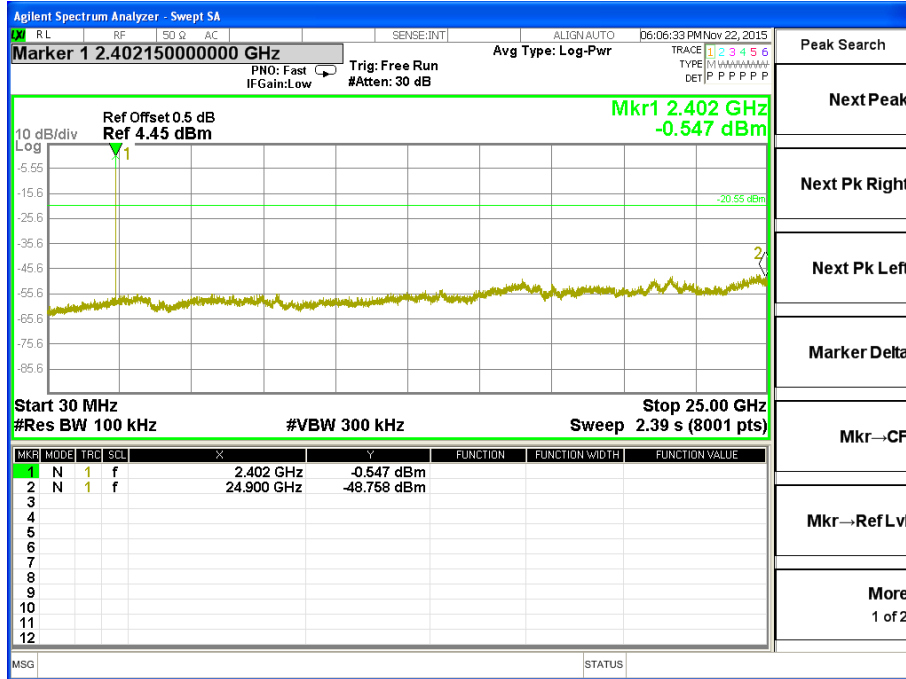

39 CH

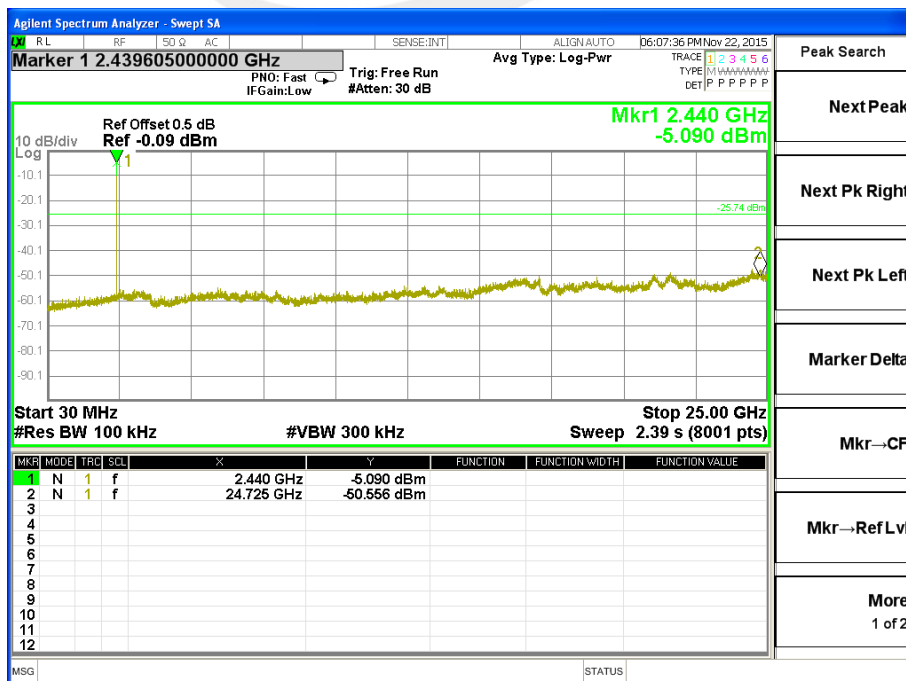



78 CH

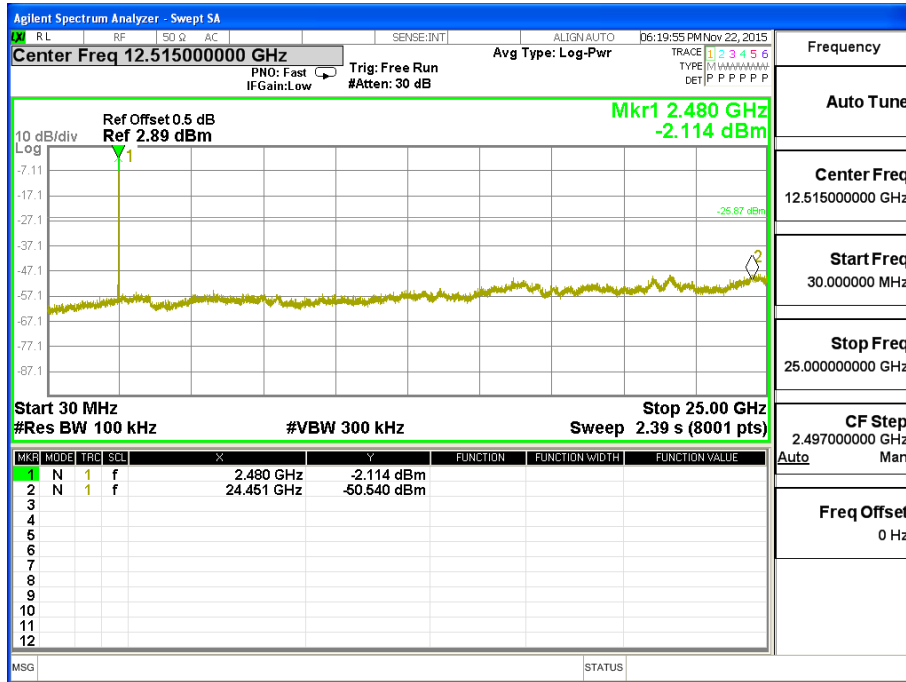



For Band edge

00 CH

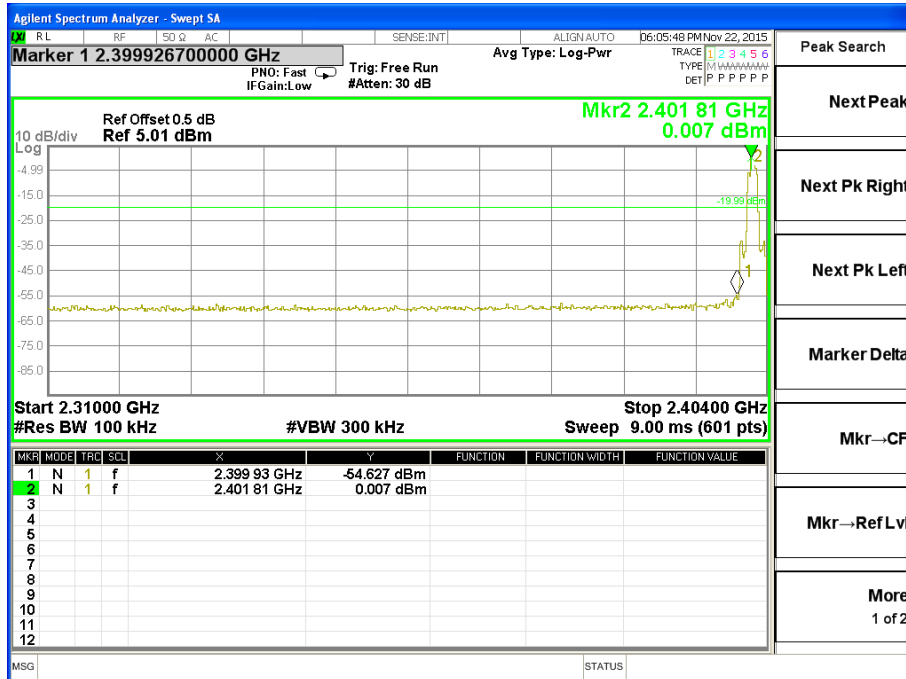

78 CH

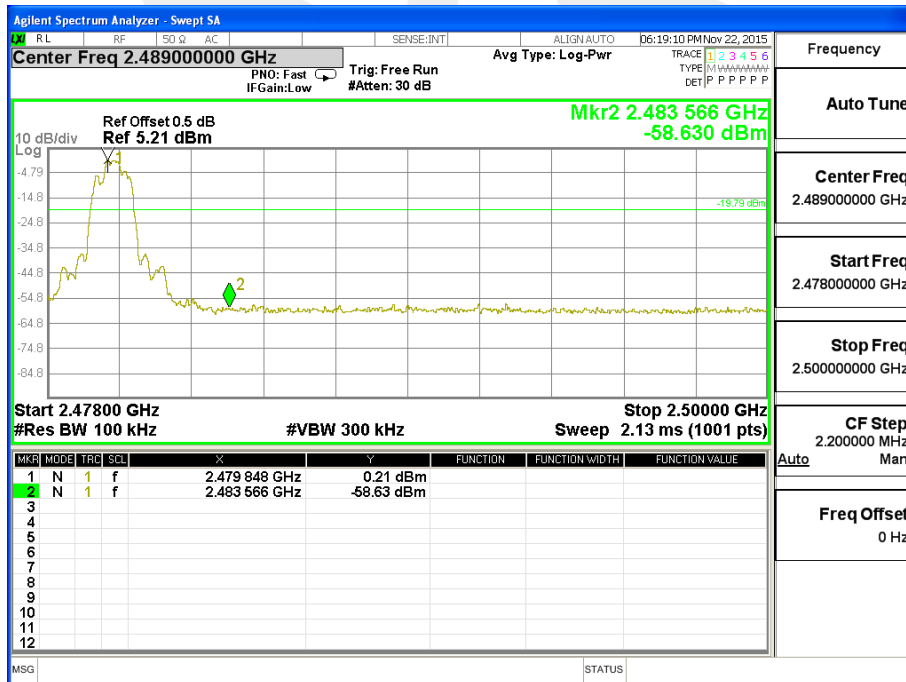



For Hopping Band edge

00 CH

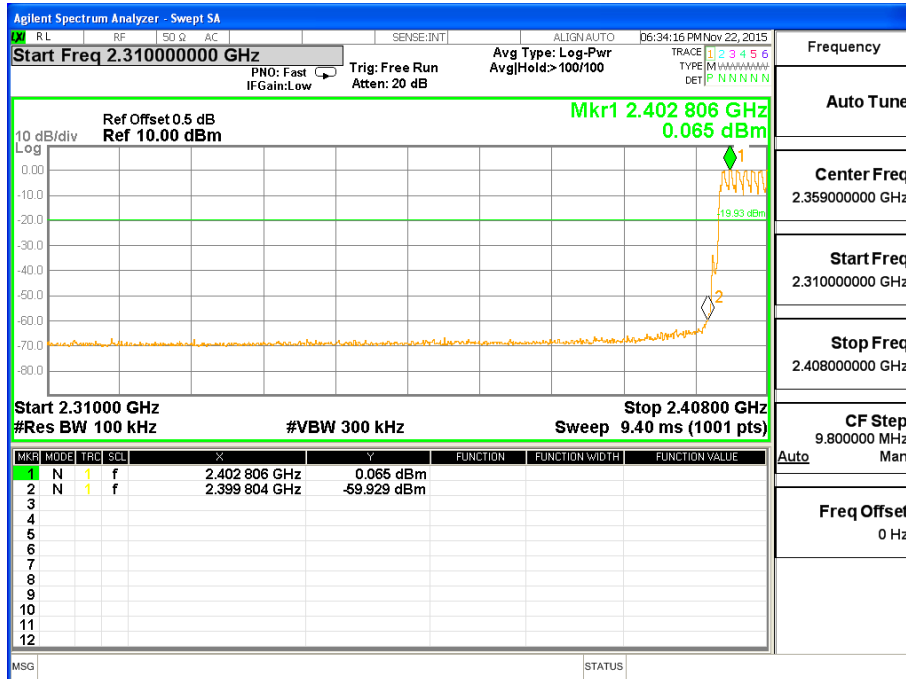

78 CH

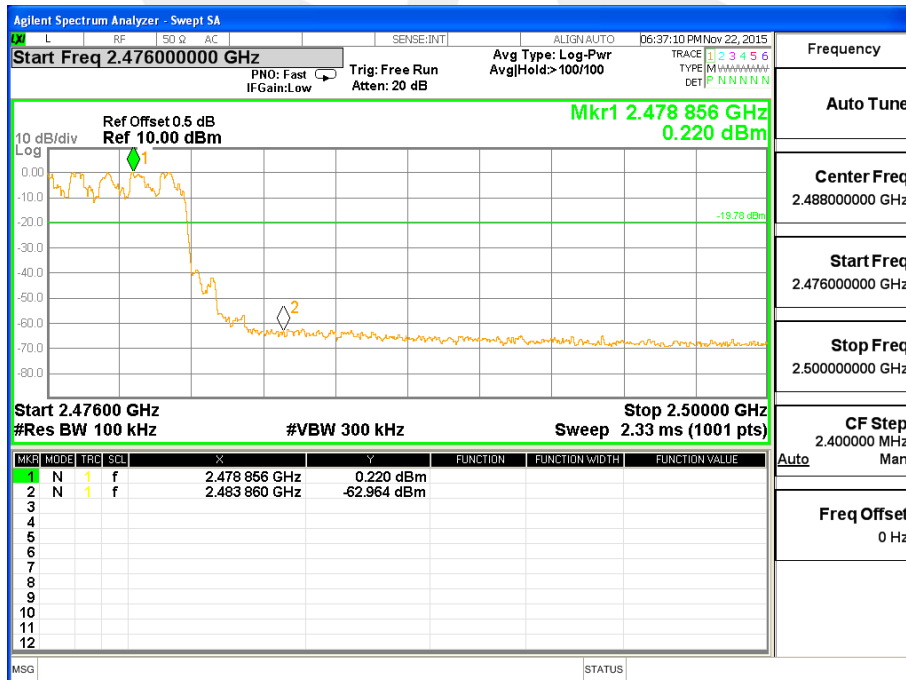





### 5. NUMBER OF HOPPING CHANNEL

#### 5.1 APPLIED PROCEDURES / LIMIT

FCC Part15 (15.247) , Subpart C				
Section	Test Item	Limit	Frequency Range (MHz)	Result
15.247 (a)(1)(iii)	Number of Hopping Channel	≥15	2400-2483.5	PASS

Spectrum Parameters	Setting
Attenuation	Auto
Span Frequency	> Operating Frequency Range
RB	100 KHz
VB	100 KHz
Detector	Peak
Trace	Max Hold
Sweep Time	Auto

#### 5.2 TEST PROCEDURE

- a. The EUT was directly connected to the spectrum analyzer and antenna output port as show in the block diagram below,
- b. Spectrum Setting : RBW= 100K, VBW=100K, Sweep time = Auto.

#### 5.3 TEST SETUP



#### 5.4 EUT OPERATION CONDITIONS

The EUT tested system was configured as the statements of 2.4 Unless otherwise a special operating condition is specified in the follows during the testing.



### 5.5 TEST RESULTS

EUT :	3G Smartphone	Model Name :	X3
Temperature :	25 °C	Relative Humidity :	60%
Pressure :	1015 hPa	Test Voltage :	DC 3.7V
Test Mode :	Hopping Mode		

Number of Hopping Channel

79

#### Hopping channel

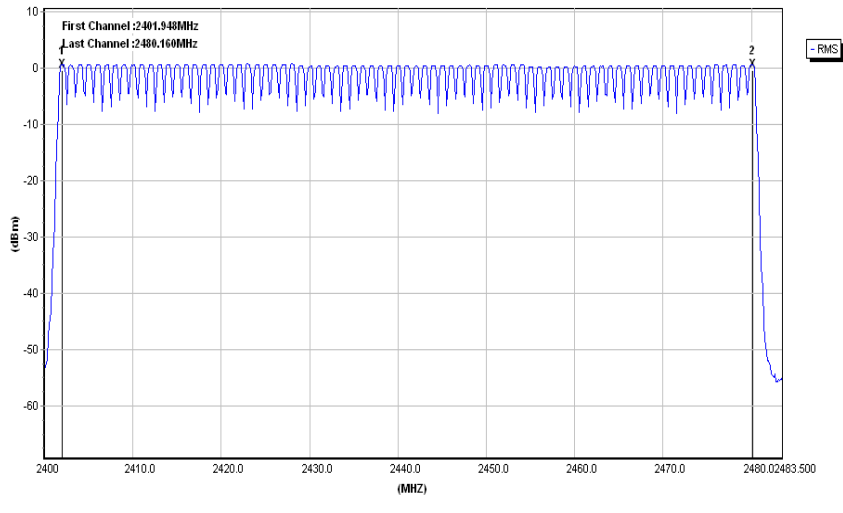



### 6. AVERAGE TIME OF OCCUPANCY

#### 6.1 APPLIED PROCEDURES / LIMIT

FCC Part15 (15.247) , Subpart C				
Section	Test Item	Limit	Frequency Range (MHz)	Result
15.247 (a)(1)(iii)	Average Time of Occupancy	0.4sec	2400-2483.5	PASS

#### 6.2 TEST PROCEDURE

- a. The transmitter output (antenna port) was connected to the spectrum analyzer
- b. Set RBW of spectrum analyzer to 1MHz and VBW to 3MHz.
- c. Use a video trigger with the trigger level set to enable triggering only on full pulses.
- d. Sweep Time is more than once pulse time.
- e. Set the center frequency on any frequency would be measure and set the frequency span to zero span.
- f. Measure the maximum time duration of one single pulse.
- g. Set the EUT for DH5, DH3 and DH1 packet transmitting.
- h. Measure the maximum time duration of one single pulse.
- i. DH5 Packet permit maximum  $1600 / 79 / 6 = 3.37$  hops per second in each channel (5 time slots RX, 1 time slot TX). So, the dwell time is the time duration of the pulse times  $3.37 \times 31.6 = 106.6$  within 31.6 seconds.
- j. DH3 Packet permit maximum  $1600 / 79 / 4 = 5.06$  hops per second in each channel (3 time slots RX, 1 time slot TX). So, the dwell time is the time duration of the pulse times  $5.06 \times 31.6 = 160$  within 31.6 seconds.
- k. DH1 Packet permit maximum  $1600 / 79 / 2 = 10.12$  hops per second in each channel (1 time slot RX, 1 time slot TX). So, the dwell time is the time duration of the pulse times  $10.12 \times 31.6 = 320$  within 31.6 seconds.

#### 6.3 TEST SETUP



#### 6.4 EUT OPERATION CONDITIONS

The EUT tested system was configured as the statements of 2.4 Unless otherwise a special operating condition is specified in the follows during the testing.



6.5 TEST RESULTS

EUT :	3G Smartphone	Model Name :	X3
Temperature :	25 °C	Relative Humidity :	50%
Pressure :	1012 hPa	Test Voltage :	DC 3.7V
Test Mode :	GFSK(1Mbps)-DH1/DH3/DH5		

Data Packet	Frequency	Pulse Duration (ms)	Dwell Time (s)	Limits(s)
DH1	2441 MHz	0.370	0.118	0.4
DH3	2441 MHz	1.630	0.261	0.4
DH5	2441 MHz	2.880	0.307	0.4

CH39-DH1

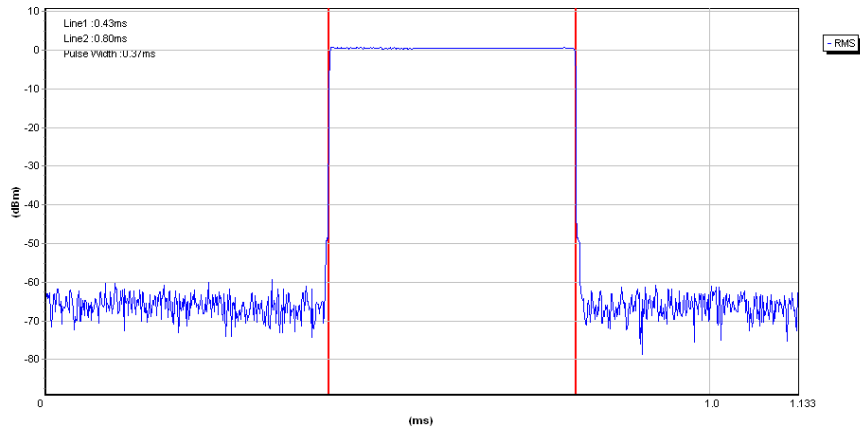



### CH39-DH3

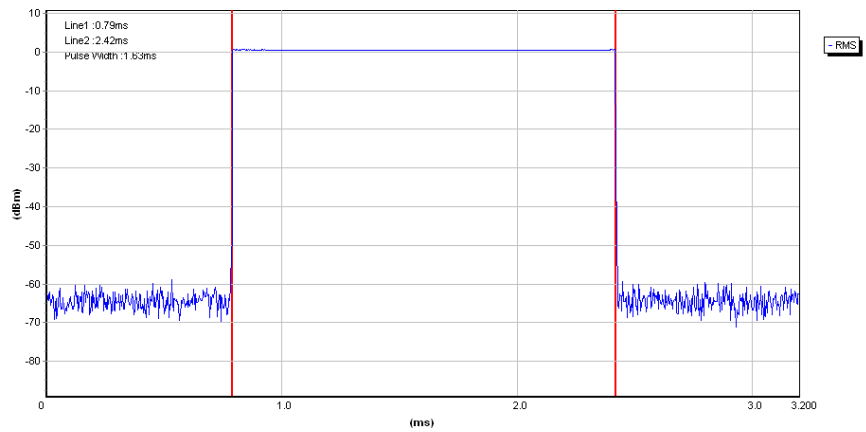

### CH39-DH5

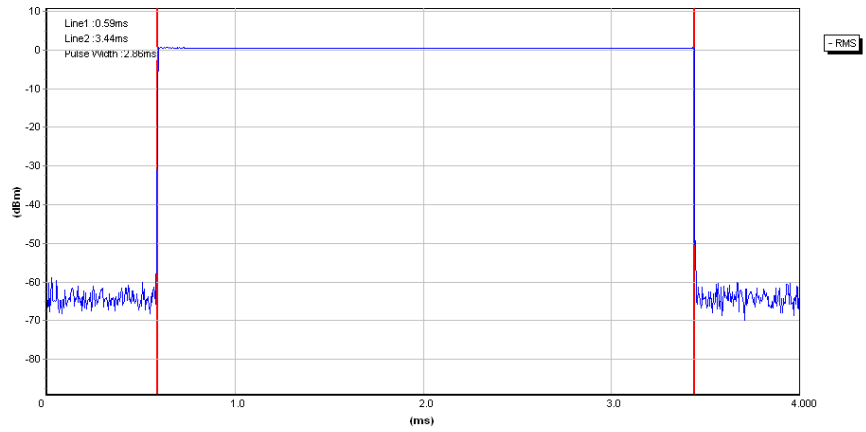



EUT :	3G Smartphone	Model Name :	X3
Temperature :	25 °C	Relative Humidity :	50%
Pressure :	1012 hPa	Test Voltage :	DC 3.7V
Test Mode :	$\pi/4$ -DQPSK(2Mbps) –2DH1/2DH3/2DH5		

Data Packet	Frequency	Pulse Duration (ms)	Dwell Time (s)	Limits(s)
2DH1	2441 MHz	0.380	0.122	0.4
2DH3	2441 MHz	1.640	0.262	0.4
2DH5	2441 MHz	2.880	0.307	0.4

CH39-2DH1

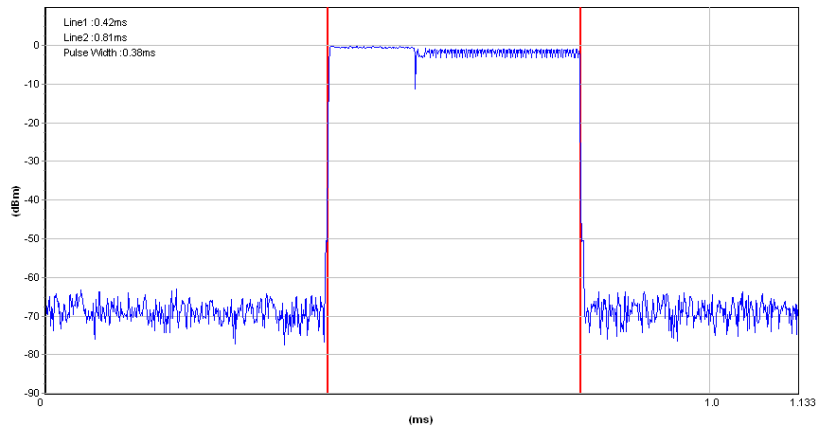



### CH39-2DH3

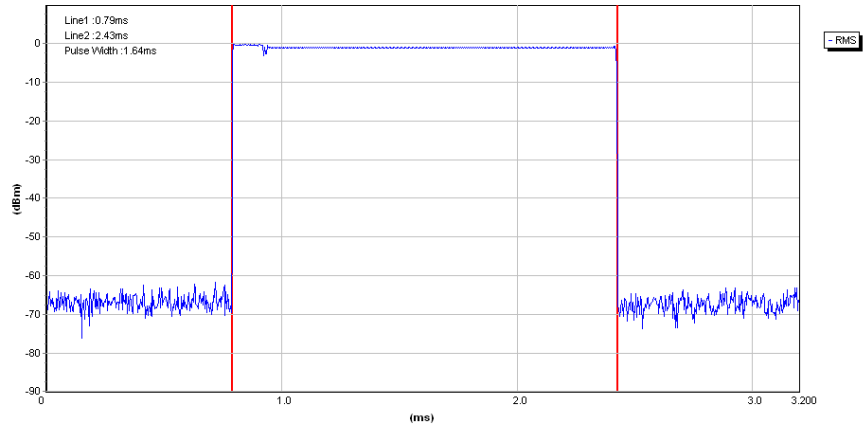

### CH39-2DH5

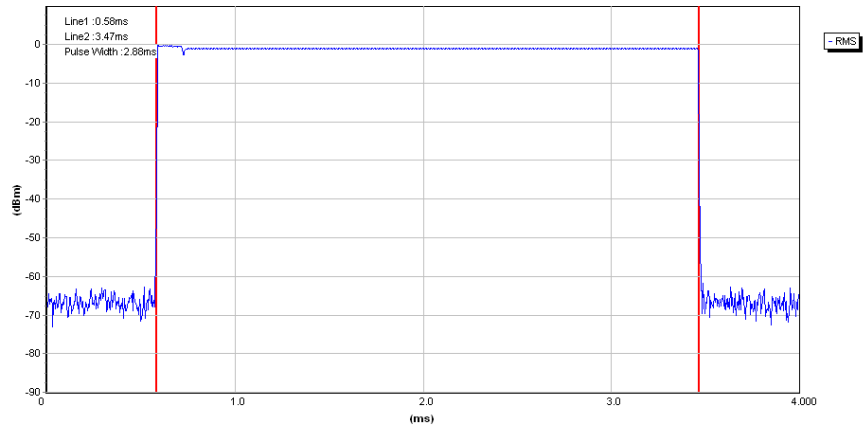



EUT :	3G Smartphone	Model Name :	X3
Temperature :	25 °C	Relative Humidity :	50%
Pressure :	1012 hPa	Test Voltage :	DC 3.7V
Test Mode :	8DPSK(3Mbps) –3DH1/3DH3/3DH5		

Data Packet	Frequency	Pulse Duration (ms)	Dwell Time (s)	Limits(s)
3DH1	2441 MHz	0.380	0.122	0.4
3DH3	2441 MHz	1.640	0.262	0.4
3DH5	2441 MHz	2.890	0.308	0.4

CH39-3DH1

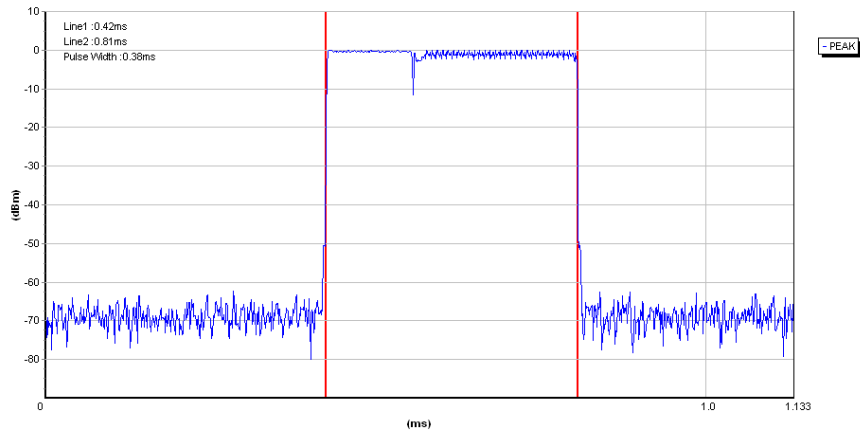





### CH39-3DH3

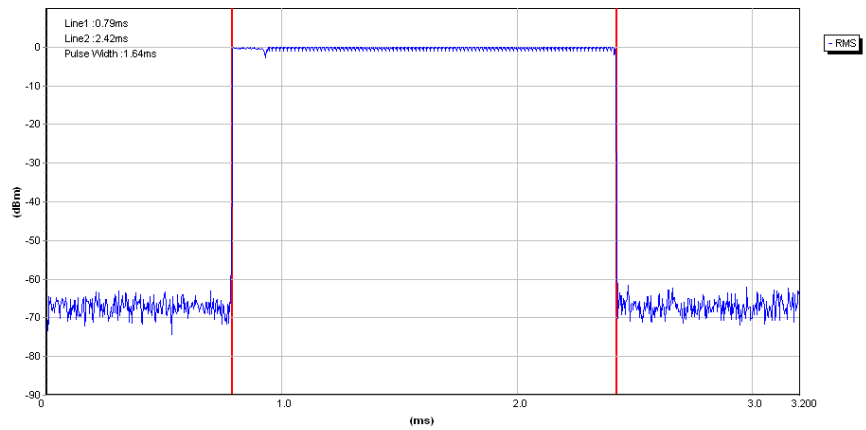

### CH39-3DH5

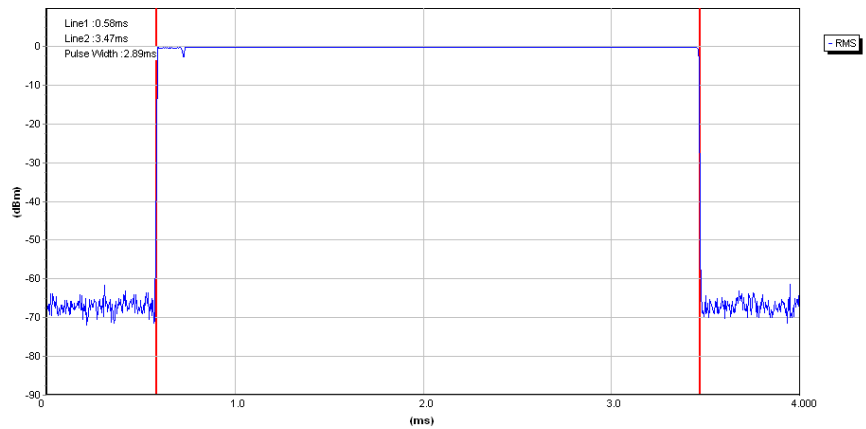

## 7. HOPPING CHANNEL SEPARATION MEASUREMENT

### 7.1 APPLIED PROCEDURES / LIMIT

Frequency hopping systems operating in the 2400-2483.5 MHz band may have hopping channel carrier frequencies that are separated by 20 dB bandwidth of the hopping channel, whichever is greater.

Spectrum Parameter	Setting
Attenuation	Auto
Span Frequency	> Measurement Bandwidth or Channel Separation
RB	30 kHz (20dB Bandwidth) / 30 kHz (Channel Separation)
VB	100 kHz (20dB Bandwidth) / 100 kHz (Channel Separation)
Detector	Peak
Trace	Max Hold
Sweep Time	Auto

### 7.2 TEST PROCEDURE

- a. The transmitter output (antenna port) was connected to the spectrum analyser in peak hold mode.
- b. The resolution bandwidth of 30 kHz and the video bandwidth of 100 kHz were utilised for 20 dB bandwidth measurement.
- c. The resolution bandwidth of 30 kHz and the video bandwidth of 100 kHz were utilised for channel separation measurement.

### 7.3 TEST SETUP

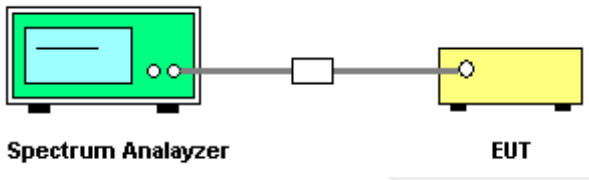

### 7.4 EUT OPERATION CONDITIONS

The EUT was programmed to be in continuously transmitting mode.



7.5 TEST RESULTS

EUT :	3G Smartphone	Model Name :	X3
Temperature :	25 °C	Relative Humidity :	50%
Pressure :	1012 hPa	Test Voltage :	DC 3.7V
Test Mode :	CH00 / CH39 /CH78 (GFSK(1Mbps) Mode)		

Frequency	Ch. Separation (MHz)	Limit	Result
2402 MHz	1.000	0.888	Complies
2441 MHz	1.000	0.889	Complies
2480 MHz	1.005	0.888	Complies

For GFSK: Ch. Separation Limits: >20dB bandwidth

CH00 -1Mbps

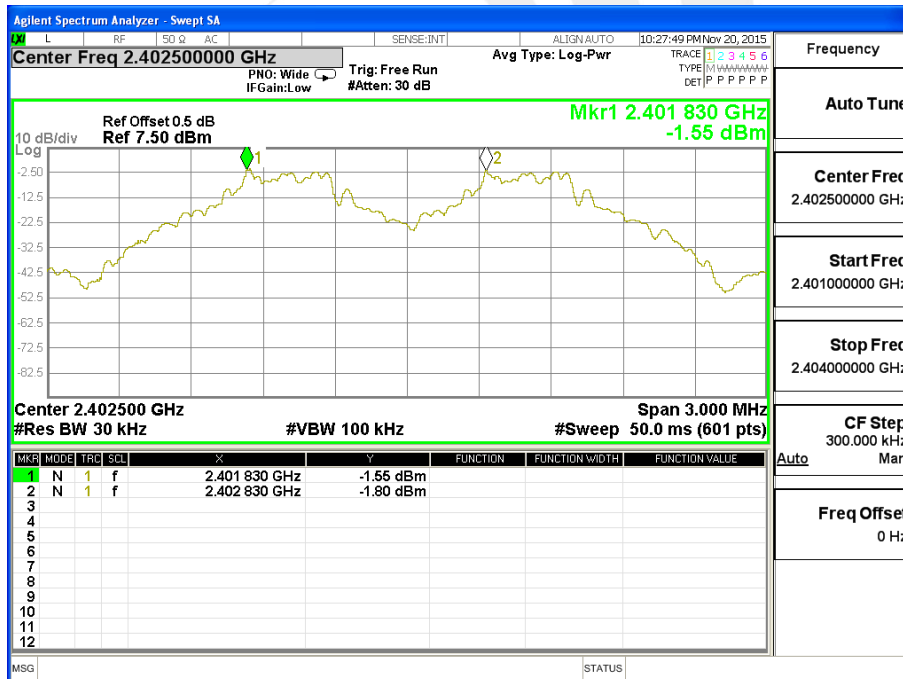



### CH39 -1Mbps

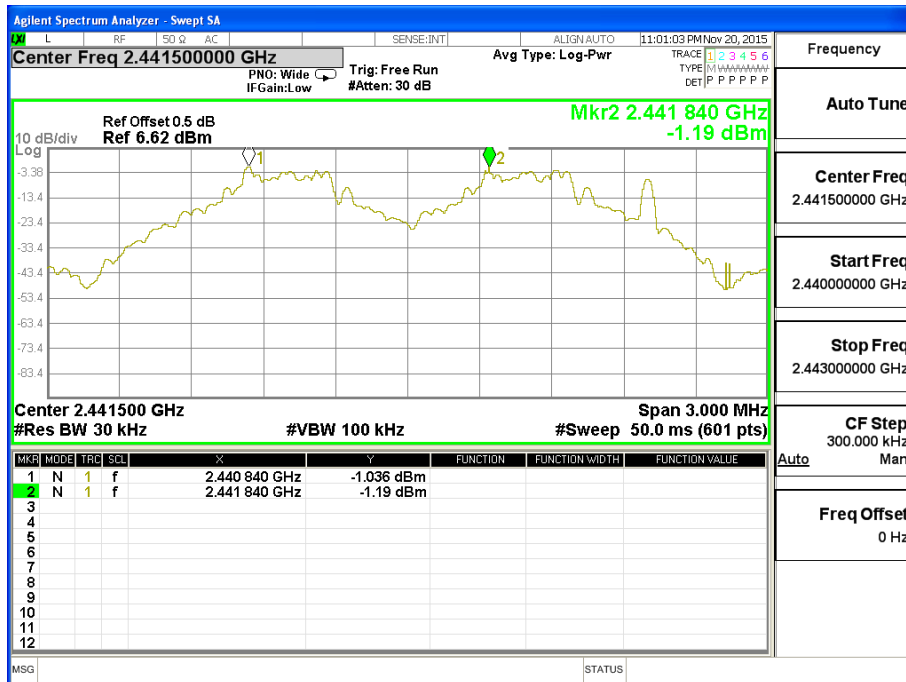

### CH78 -1Mbps

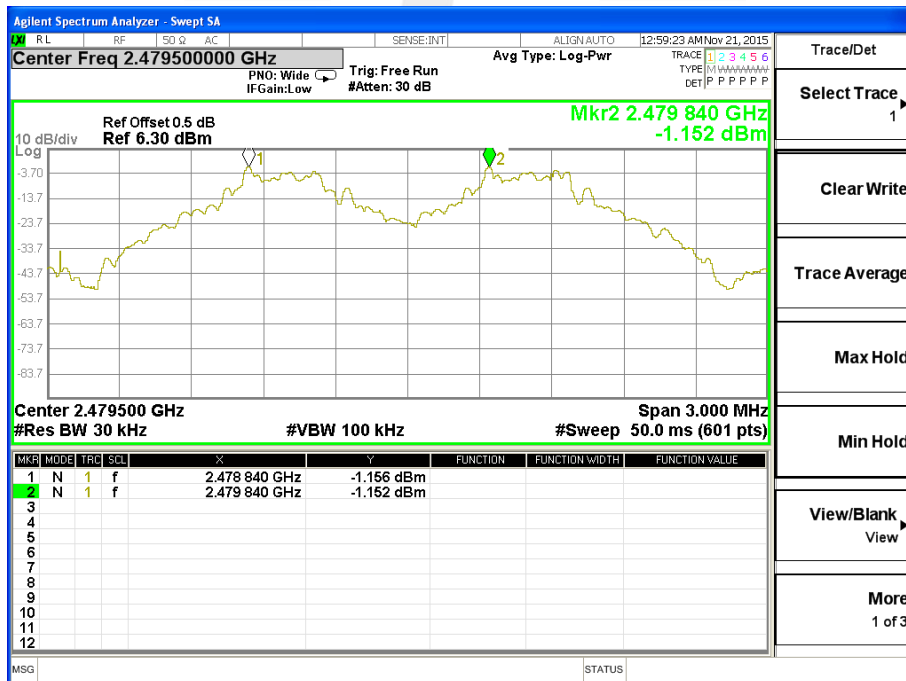



EUT :	3G Smartphone	Model Name :	X3
Temperature :	25 °C	Relative Humidity :	50%
Pressure :	1012 hPa	Test Voltage :	DC 3.7V
Test Mode :	CH00 / CH39 /CH78 ( $\pi/4$ -DQPSK(2Mbps) Mode)		

Frequency	Ch. Separation (MHz)	Limit	Result
2402 MHz	1.005	0.835	Complies
2441 MHz	1.000	0.858	Complies
2480 MHz	1.000	0.857	Complies

For  $\pi/4$ -DQPSK(2Mbps): Ch. Separation Limits: > two-thirds 20dB bandwidth

### CH00 -2Mbps

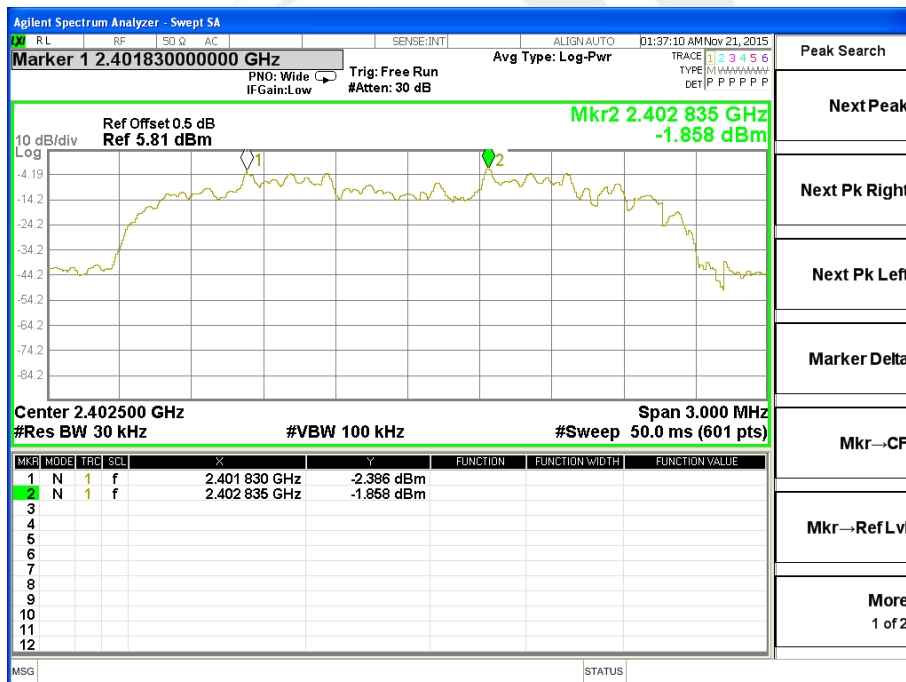



### CH39 -2Mbps

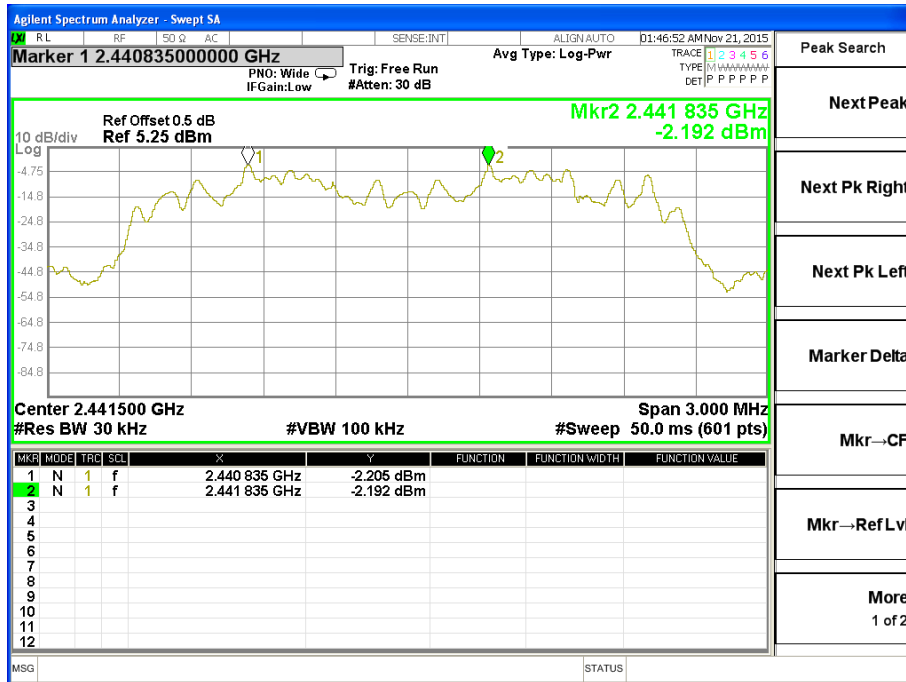

### CH78 -2Mbps

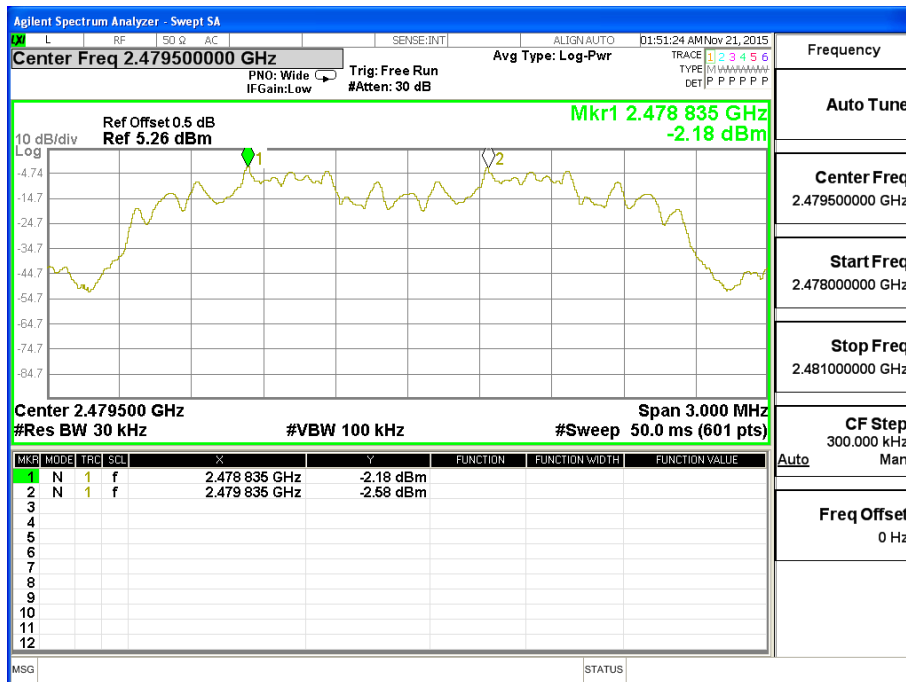



EUT :	3G Smartphone	Model Name :	X3
Temperature :	25 °C	Relative Humidity :	50%
Pressure :	1012 hPa	Test Voltage :	DC 3.7V
Test Mode :	CH00 / CH39 /CH78 (8-DPSK(3Mbps)Mode)		

Frequency	Ch. Separation (MHz)	Limit	Result
2402 MHz	1.005	0.853	Complies
2441 MHz	1.000	0.852	Complies
2480 MHz	1.000	0.851	Complies

For 8-DPSK(3Mbps):

**Ch. Separation Limits: > two-thirds 20dB bandwidth**

**CH00 -3Mbps**

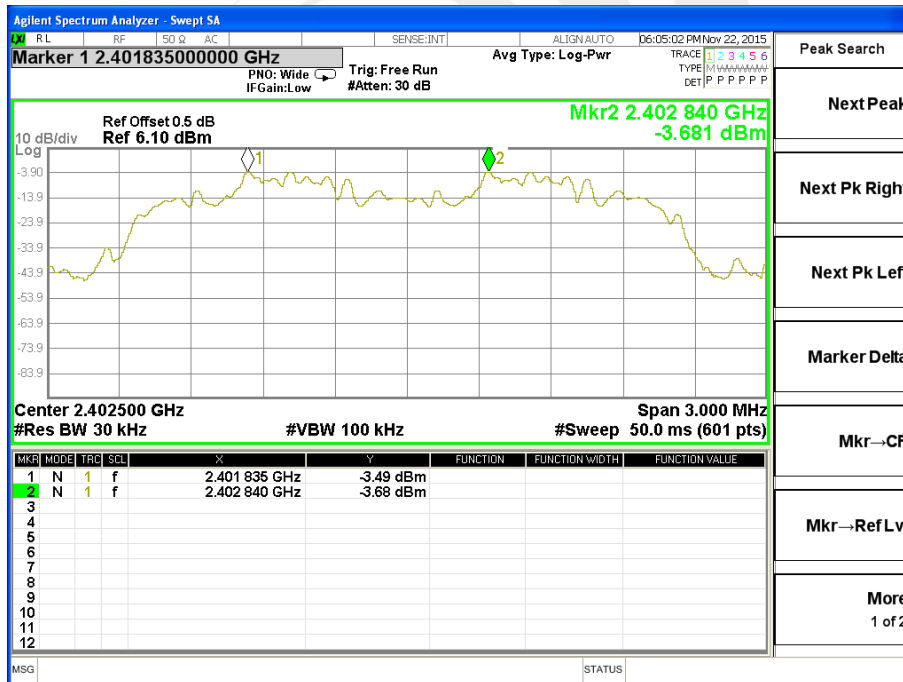



### CH39 -3Mbps

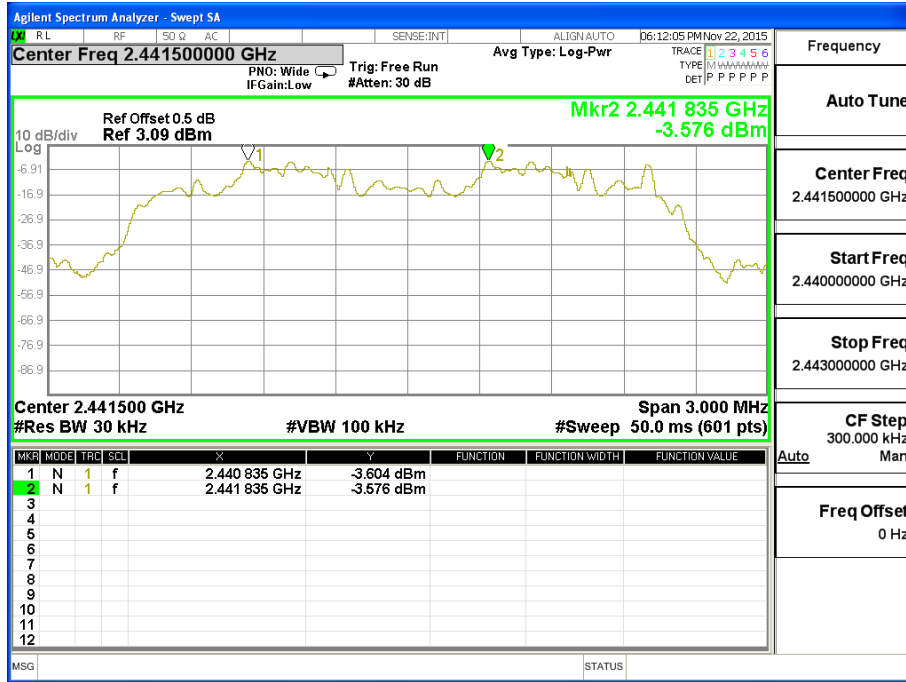

### CH78 -3Mbps

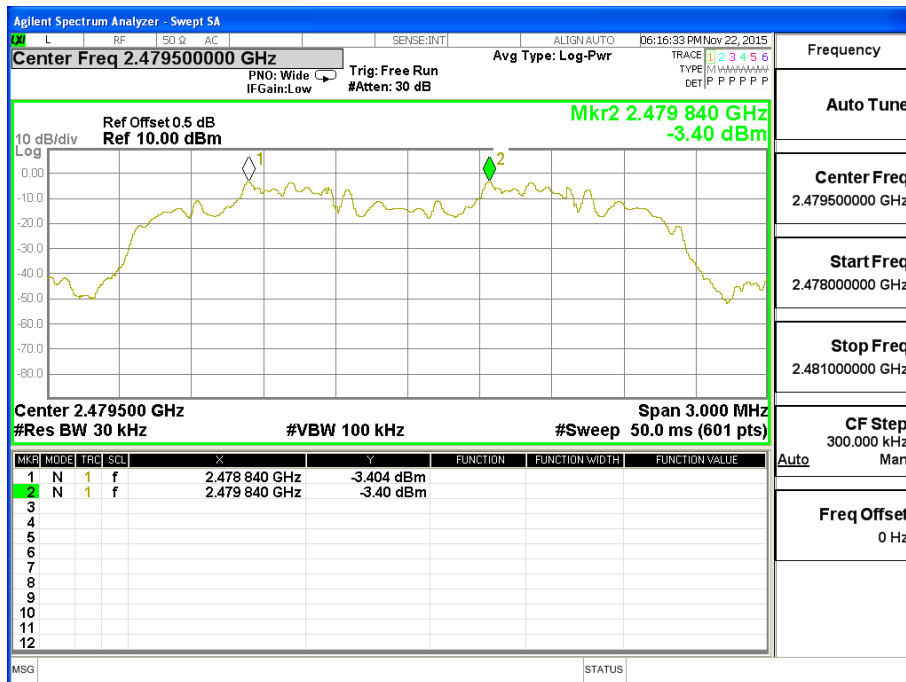





### 8. BANDWIDTH TEST

#### 8.1 APPLIED PROCEDURES / LIMIT

FCC Part15 (15.247) , Subpart C				
Section	Test Item	Limit	Frequency Range (MHz)	Result
15.247 (a)(1)	Bandwidth	(20dB bandwidth)	2400-2483.5	PASS

Spectrum Parameter	Setting
Attenuation	Auto
Span Frequency	> Measurement Bandwidth or Channel Separation
RB	30 kHz (20dB Bandwidth) / 30 kHz (Channel Separation)
VB	100 kHz (20dB Bandwidth) / 100 kHz (Channel Separation)
Detector	Peak
Trace	Max Hold
Sweep Time	Auto

#### 8.2 TEST PROCEDURE

- a. The EUT was directly connected to the spectrum analyzer and antenna output port as show in the block diagram below,
- b. Spectrum Setting : RBW= 30KHz, VBW=100KHz, Sweep time = Auto.

#### 8.3 TEST SETUP

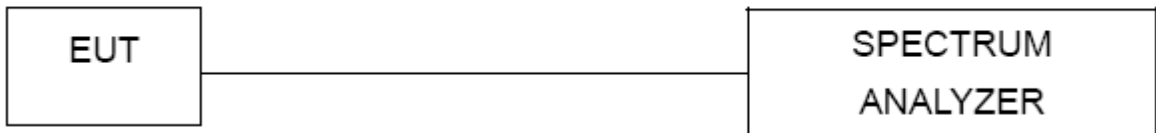

#### 8.4 EUT OPERATION CONDITIONS

The EUT tested system was configured as the statements of 2.4 Unless otherwise a special operating condition is specified in the follows during the testing.



8.5 TEST RESULTS

EUT :	3G Smartphone	Model Name :	X3
Temperature :	25 °C	Relative Humidity :	50%
Pressure :	1012 hPa	Test Voltage :	DC 3.7V
Test Mode :	GFSK(1Mbps)CH00 / CH39 /C78		

Frequency	20dB Bandwidth (MHz)	Result
2402 MHz	0.888	PASS
2441 MHz	0.889	PASS
2480 MHz	0.888	PASS

CH00 -1Mbps

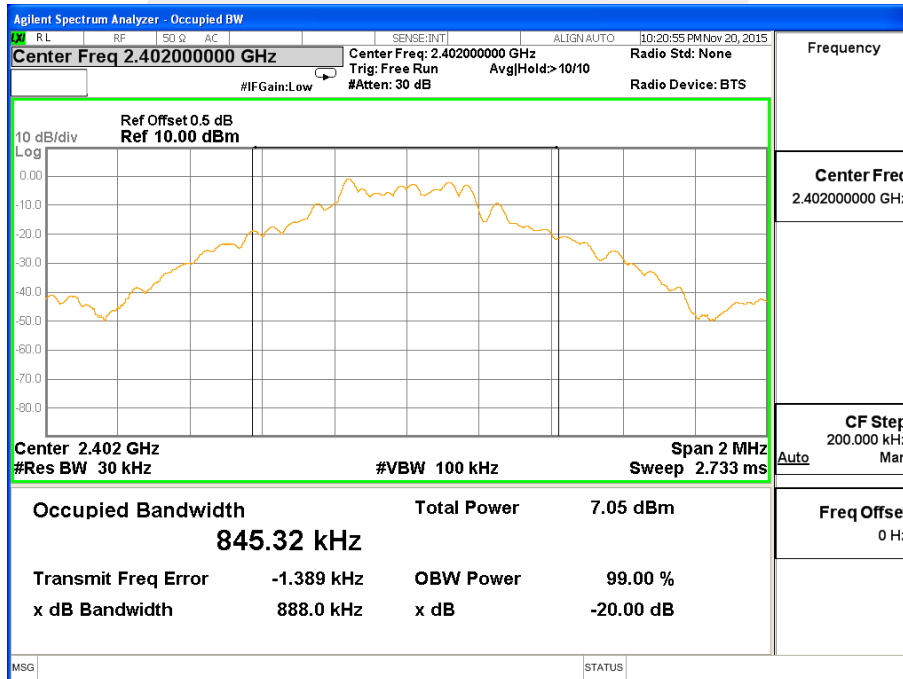



### CH39 -1Mbps

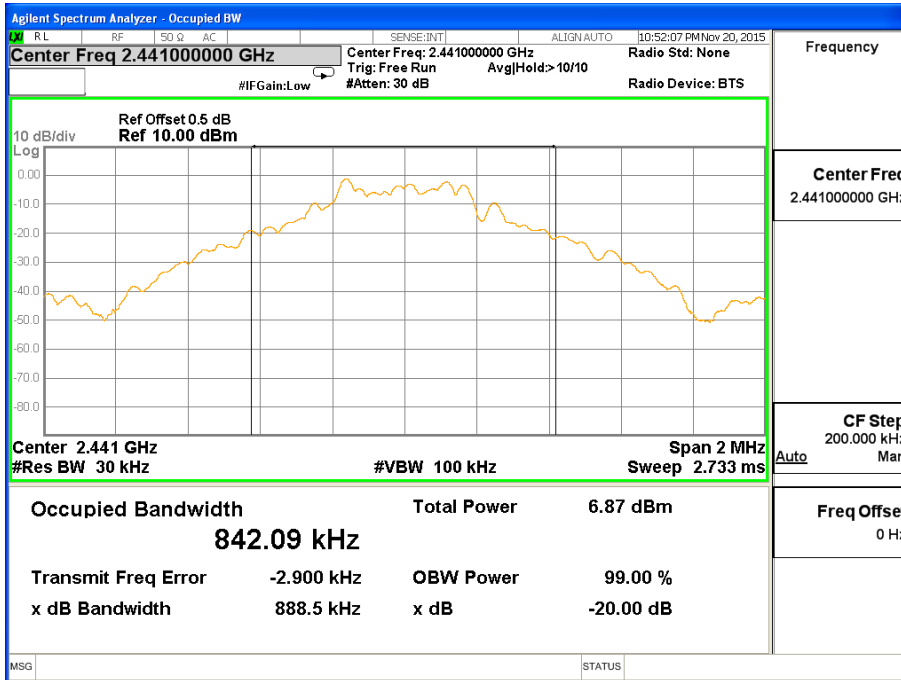

### CH78 -1Mbps

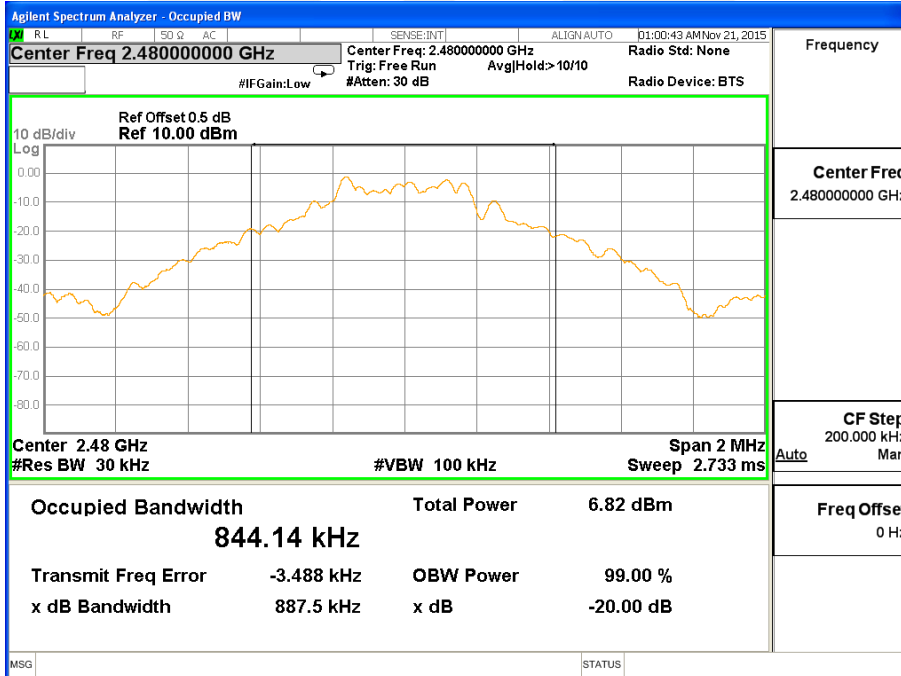



EUT :	3G Smartphone	Model Name :	X3
Temperature :	25 °C	Relative Humidity :	50%
Pressure :	1012 hPa	Test Voltage :	DC 3.7V
Test Mode :	π/4-DQPSK(2Mbps)CH00 / CH39 /C78		

Frequency	20dB Bandwidth(MHz)	Result
2402 MHz	1.252	PASS
2441 MHz	1.287	PASS
2480 MHz	1.286	PASS

CH00 -2Mbps

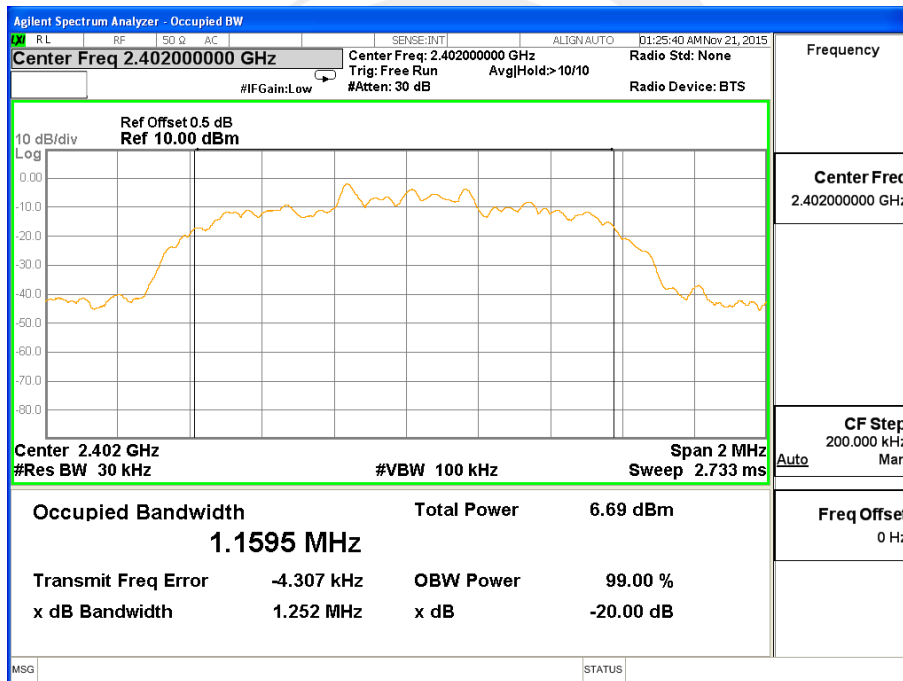



### CH39 -2Mbps

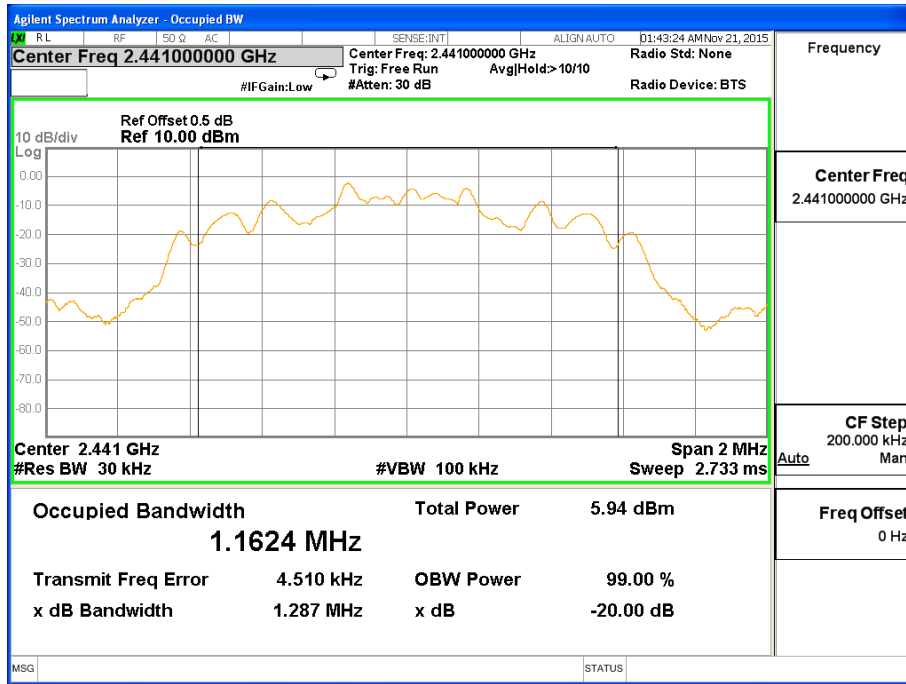

### CH78 -2Mbps

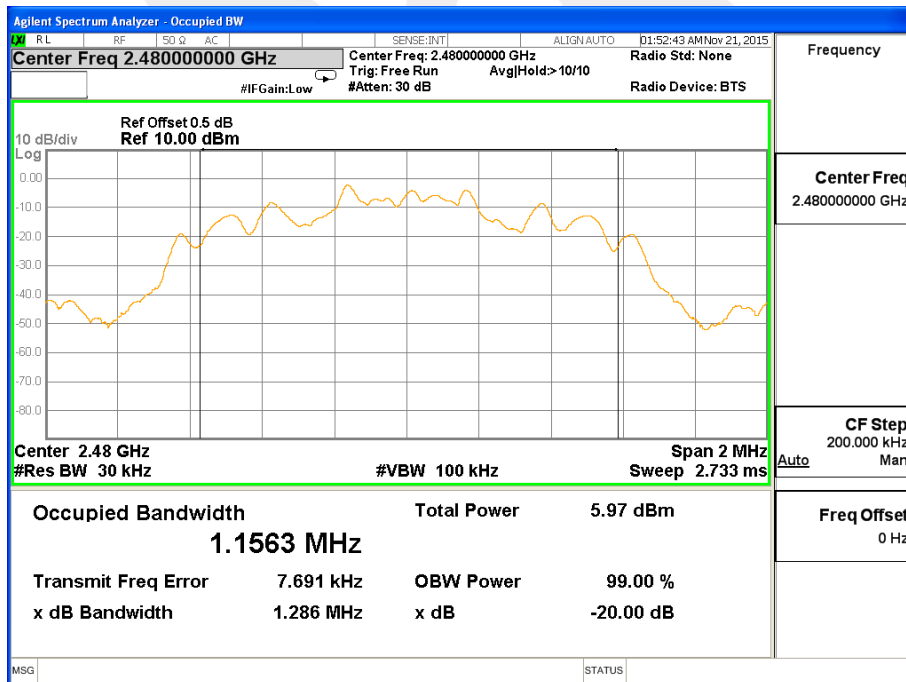



EUT :	3G Smartphone	Model Name :	X3
Temperature :	25 °C	Relative Humidity :	50%
Pressure :	1012 hPa	Test Voltage :	DC 3.7V
Test Mode :	8DPSK(3Mbps)CH00 / CH39 /C78		

Frequency	20dB Bandwidth (MHz)	Result
2402 MHz	1.280	PASS
2441 MHz	1.278	PASS
2480 MHz	1.277	PASS

CH00 -3Mbps

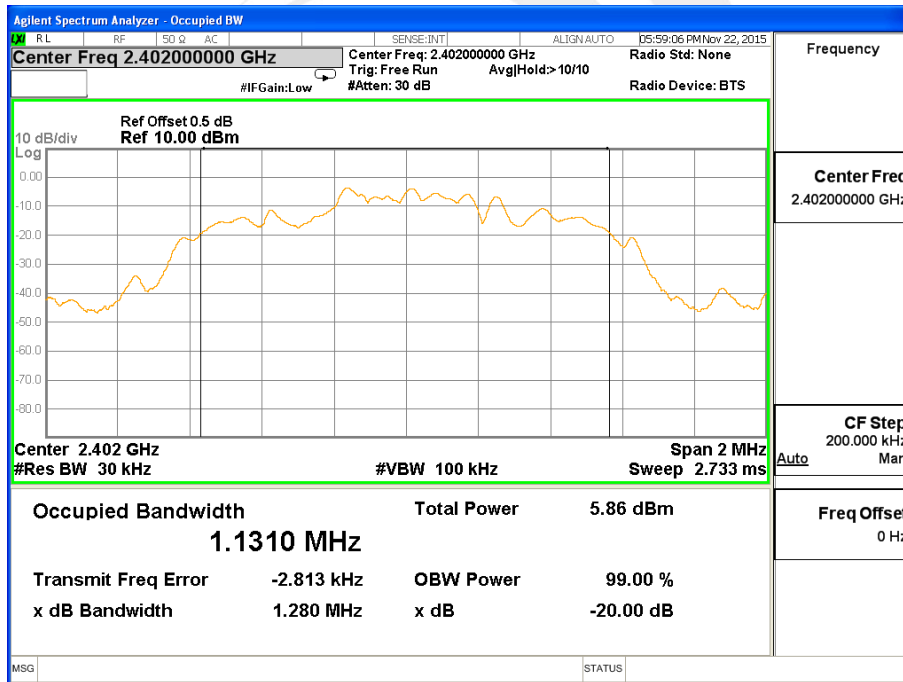



### CH39 -3Mbps

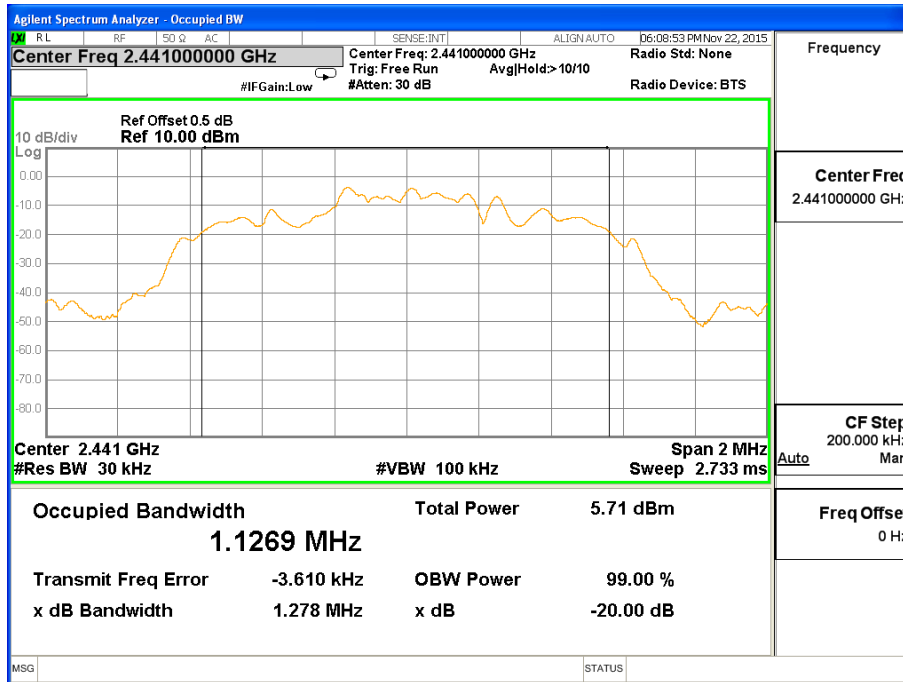

### CH78 -3Mbps

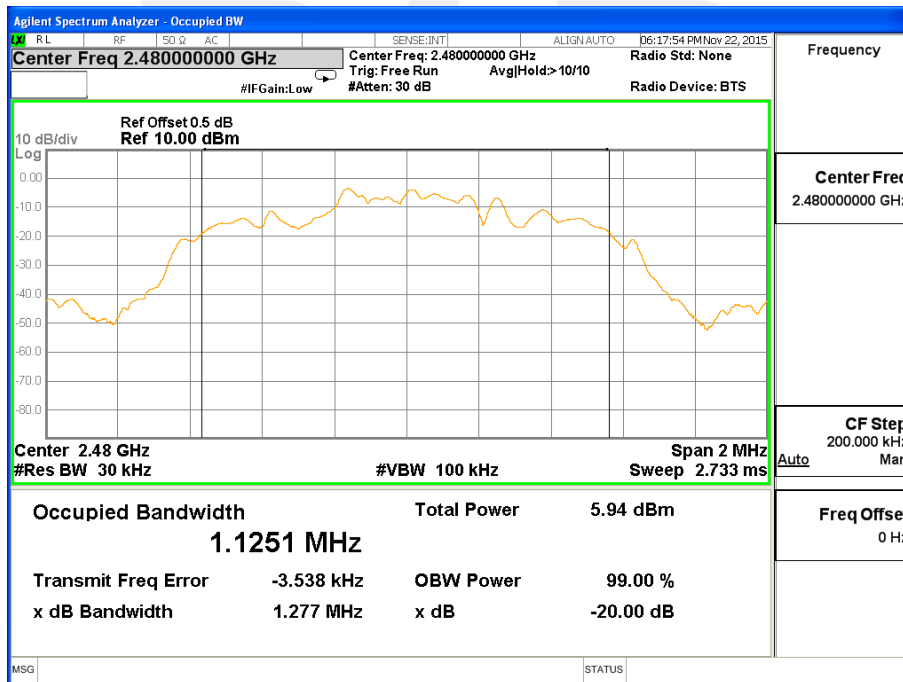



### 9. PEAK OUTPUT POWER TEST

#### 9.1 APPLIED PROCEDURES / LIMIT

FCC Part15 (15.247) , Subpart C				
Section	Test Item	Limit	Frequency Range (MHz)	Result
15.247 (b)(i)	Peak Output Power	1 W or 0.125W	2400-2483.5	PASS
		Or if channel separation > 2/3 bandwidth provided the systems operate with an output power no greater than 125 mW (20.96dBm)		

#### 9.2 TEST PROCEDURE

- a. The EUT was directly connected to the spectrum analyzer and antenna output port as show in the block diagram below,
- b. Spectrum Setting : GFSK(1Mbps):RBW= 1MHz, VBW= 3MHz, Sweep time = Auto.
- c. Spectrum Setting :  $\pi/4$ -DQPSK(2Mbps):RBW= 3MHz, VBW= 3MHz, Sweep time = Auto.
- d. Spectrum Setting : 8-DPSK(3Mbps):RBW= 3MHz, VBW= 3MHz, Sweep time = Auto.

#### 9.3 TEST SETUP

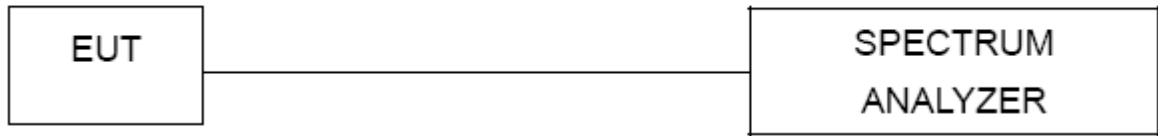

#### 9.4 EUT OPERATION CONDITIONS

The EUT tested system was configured as the statements of 2.4 Unless otherwise a special operating condition is specified in the follows during the testing.





9.5 TEST RESULTS

EUT :	3G Smartphone	Model Name :	X3
Temperature :	25 °C	Relative Humidity :	60%
Pressure :	1012 hPa	Test Voltage :	DC 3.7V
Test Mode :	CH00/ CH39 /CH78 GFSK(1Mbps)		

Test Channel	Frequency (MHz)	Peak Output Power (dBm)	LIMIT (dBm)
CH00	2402	1.250	30
CH39	2441	1.026	30
CH78	2480	0.907	30

Note : the channel separation > bandwidth

CH00 -1Mbps

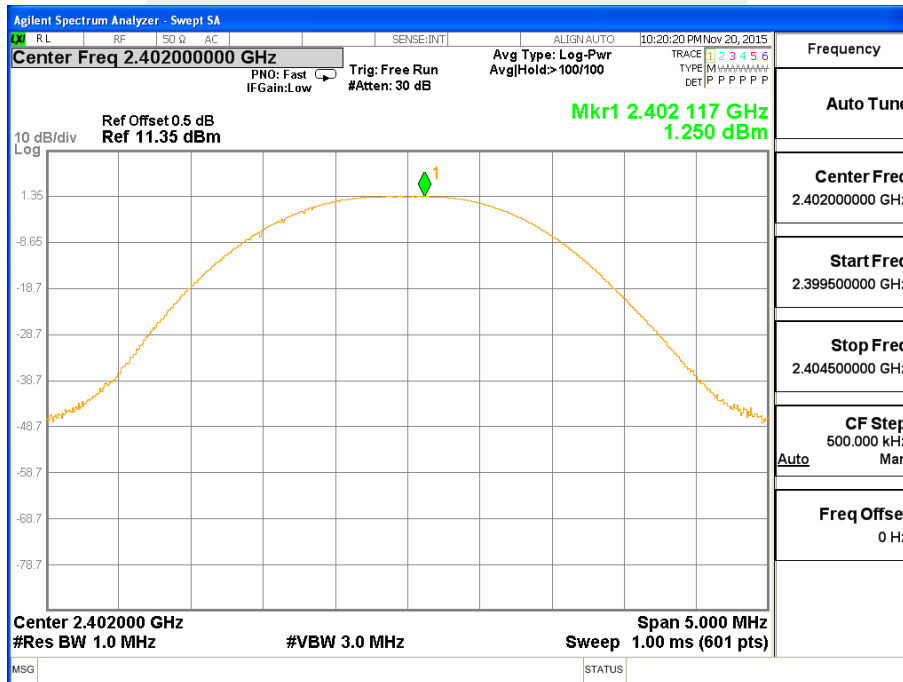



### CH39 -1Mbps

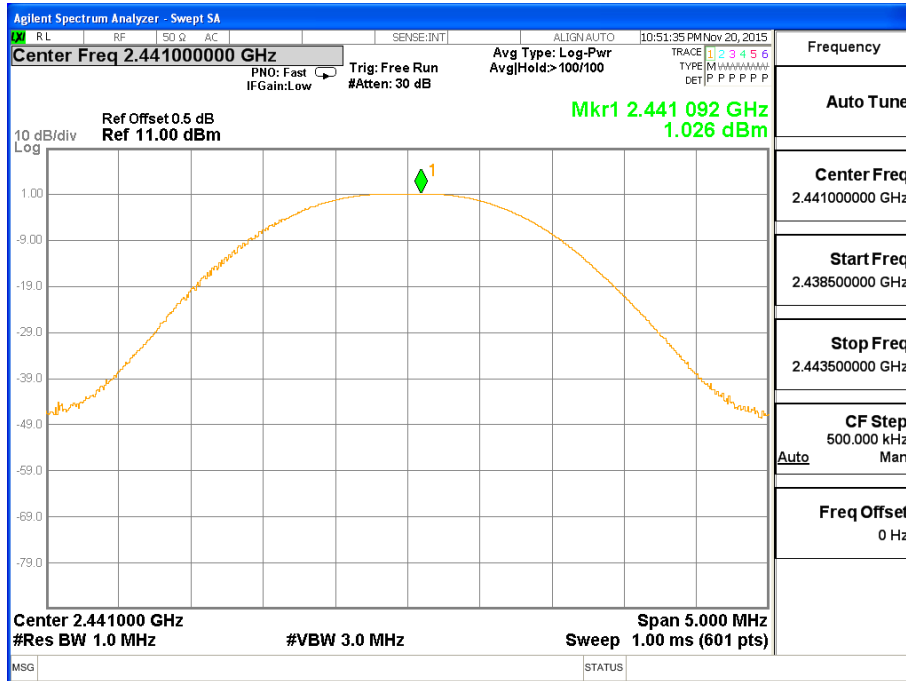

### CH78 -1Mbps

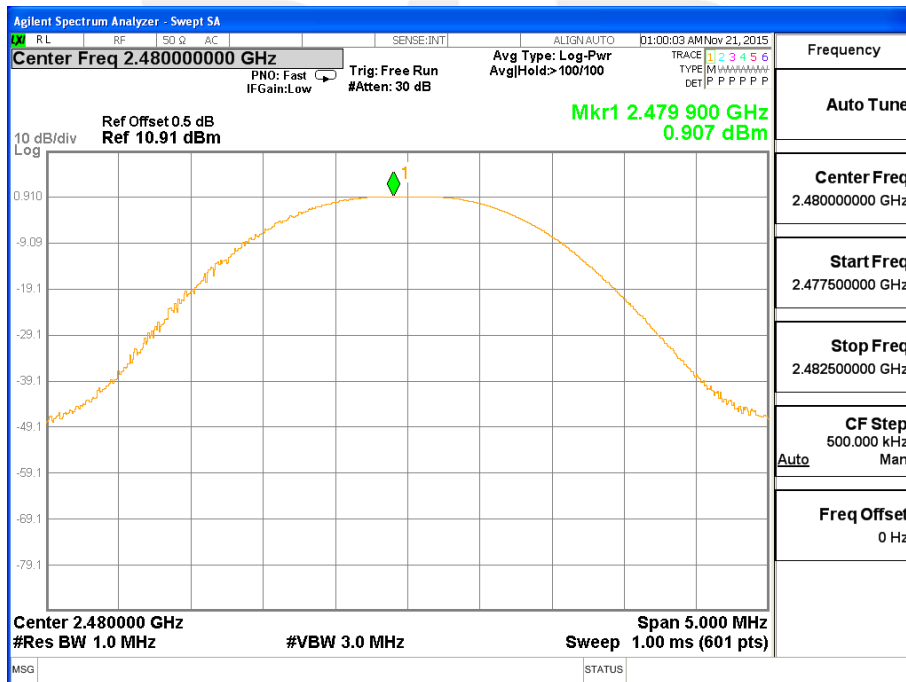



EUT :	3G Smartphone	Model Name :	X3
Temperature :	25 °C	Relative Humidity :	60%
Pressure :	1012 hPa	Test Voltage :	DC 3.7V
Test Mode :	CH00/ CH39 /CH78 π/4-DQPSK(2Mbps)		

Test Channel	Frequency (MHz)	Peak Output Power (dBm)	LIMIT (dBm)
CH00	2402	0.653	20.96
CH39	2441	0.309	20.96
CH78	2480	0.399	20.96

Note : the channel separation >2/3 bandwidth

### CH00 -2Mbps

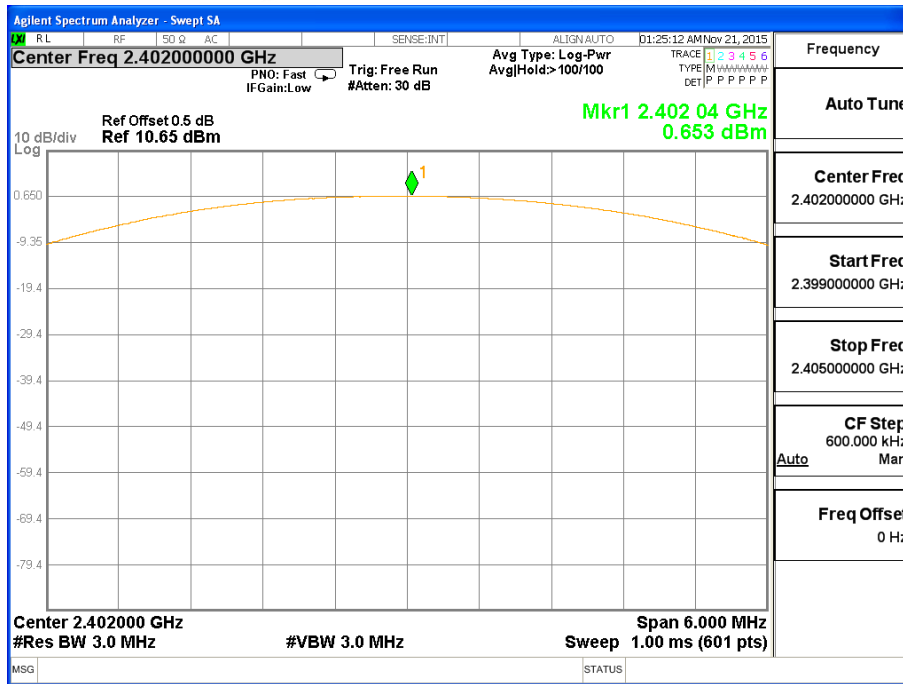



### CH39 -2Mbps

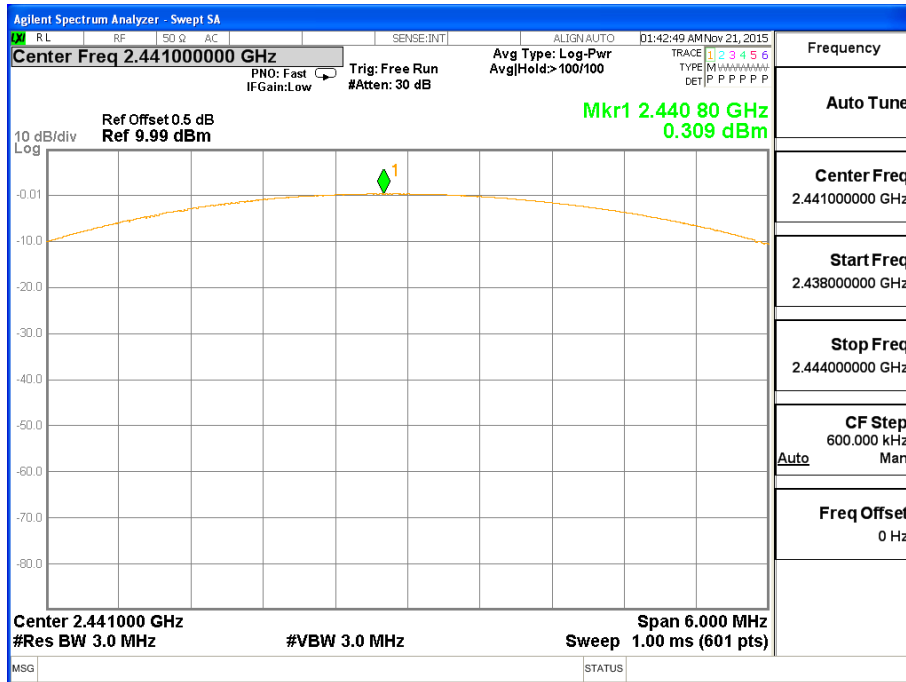

### CH78 -2Mbps

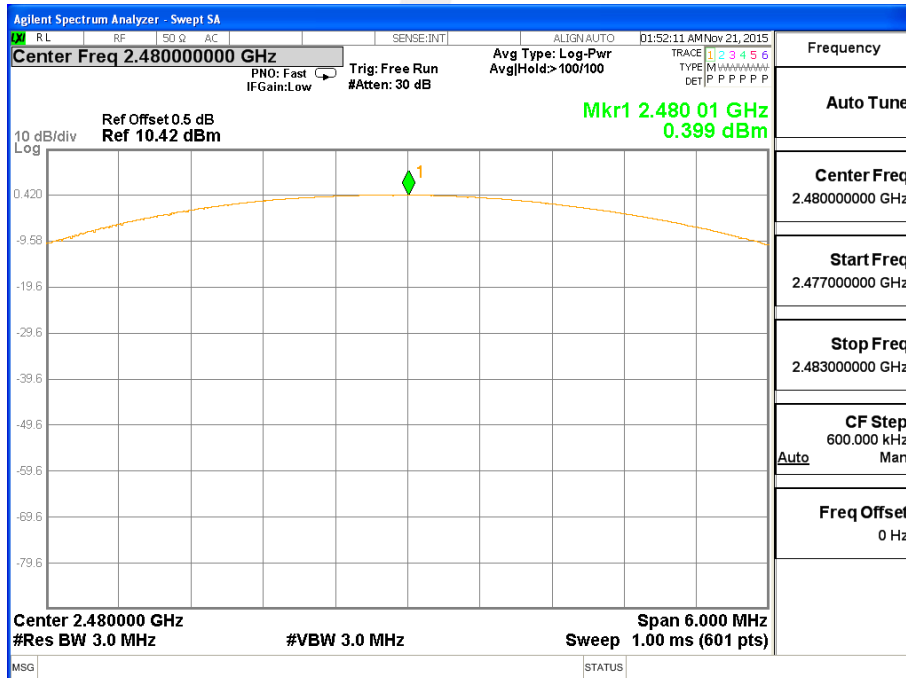



EUT :	3G Smartphone	Model Name :	X3
Temperature :	25 °C	Relative Humidity :	60%
Pressure :	1012 hPa	Test Voltage :	DC 3.7V
Test Mode :	CH00/ CH39 /CH78 8-DPSK(3Mbps)		

Test Channel	Frequency (MHz)	Peak Output Power (dBm)	LIMIT (dBm)
CH00	2402	0.853	20.96
CH39	2441	0.904	20.96
CH78	2480	1.204	20.96

Note : the channel separation >2/3 bandwidth

### CH00 -3Mbps

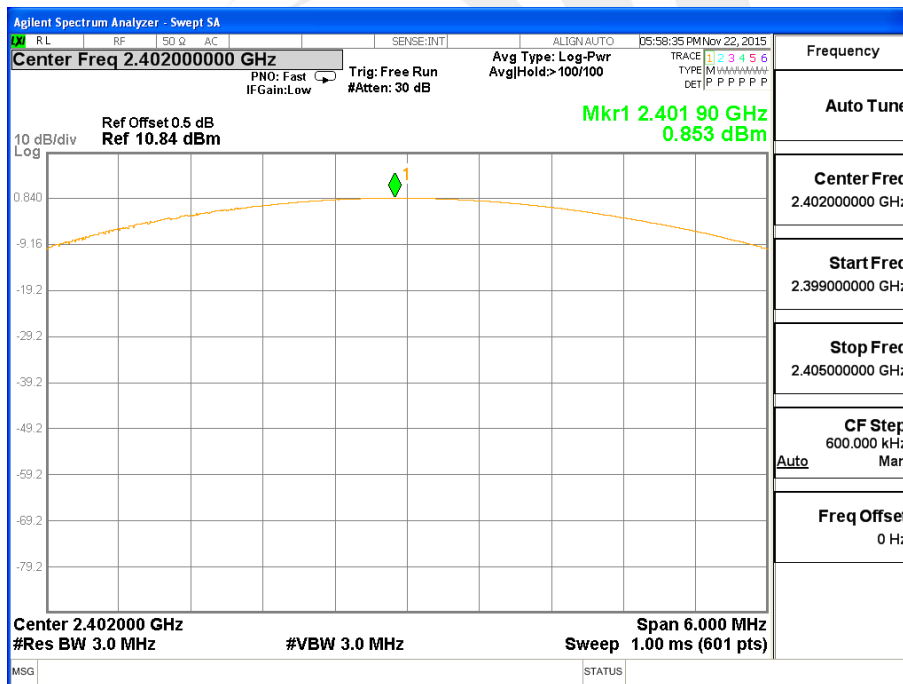



### CH39 -3Mbps

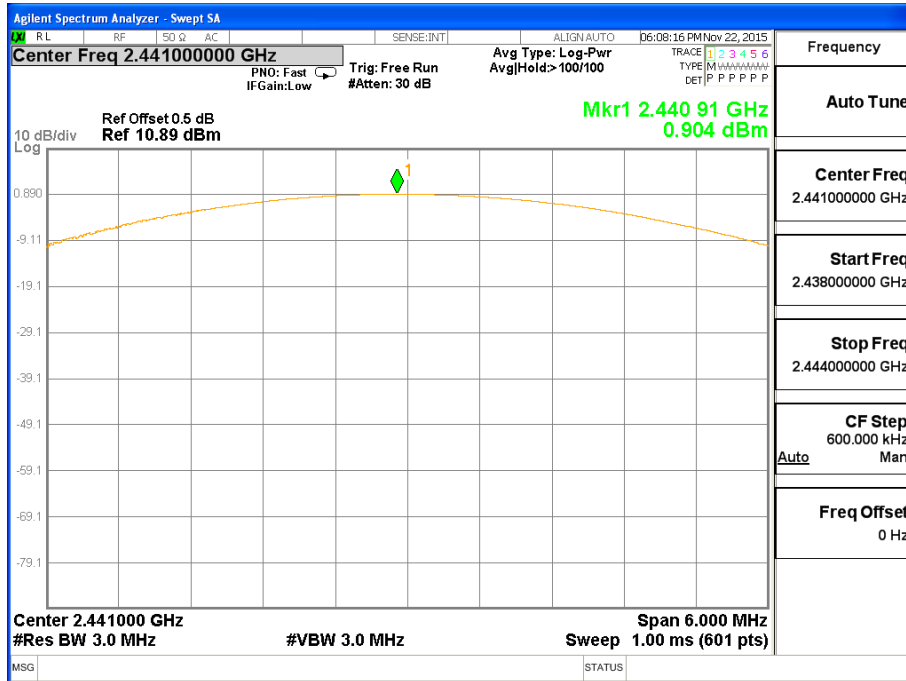

### CH78 -3Mbps

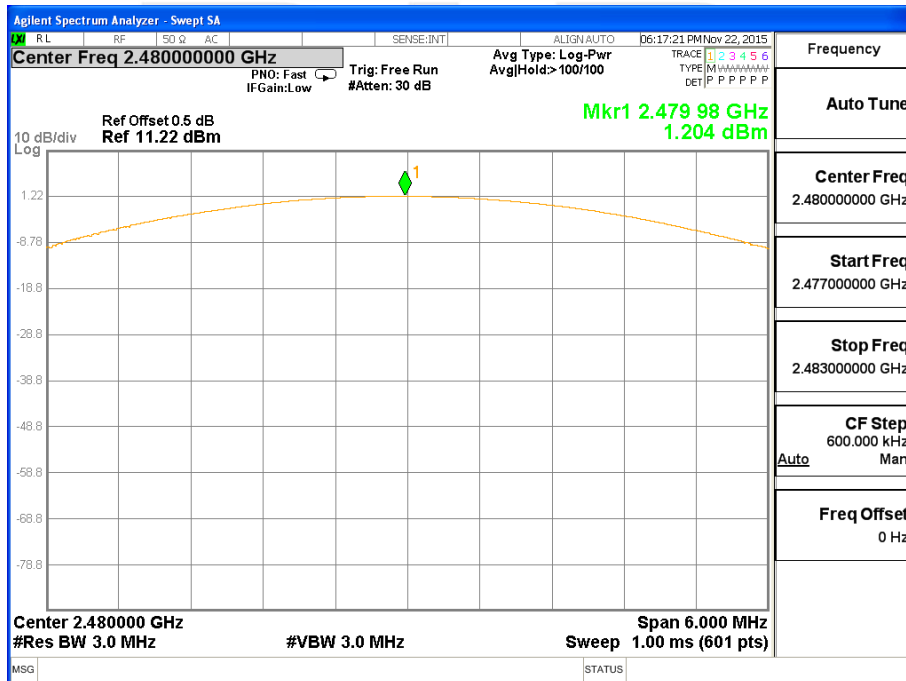



## 10. ANTENNA REQUIREMENT

### 10.1 STANDARD REQUIREMENT

15.203 requirement: For intentional device, according to 15.203: an intentional radiator shall be designed to ensure that no antenna other than that furnished by the responsible party shall be used with the device.

### 10.2 EUT ANTENNA

The EUT antenna is PIFA Antenna. It comply with the standard requirement.



## APPENDIX- PHOTOS OF TEST SETUP

### Radiated Measurement Photos

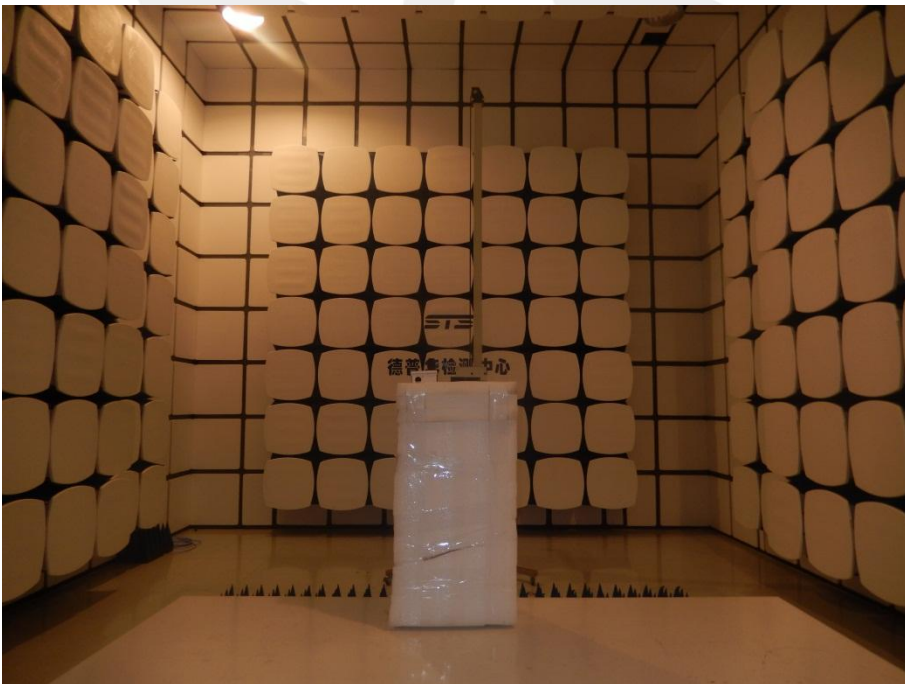
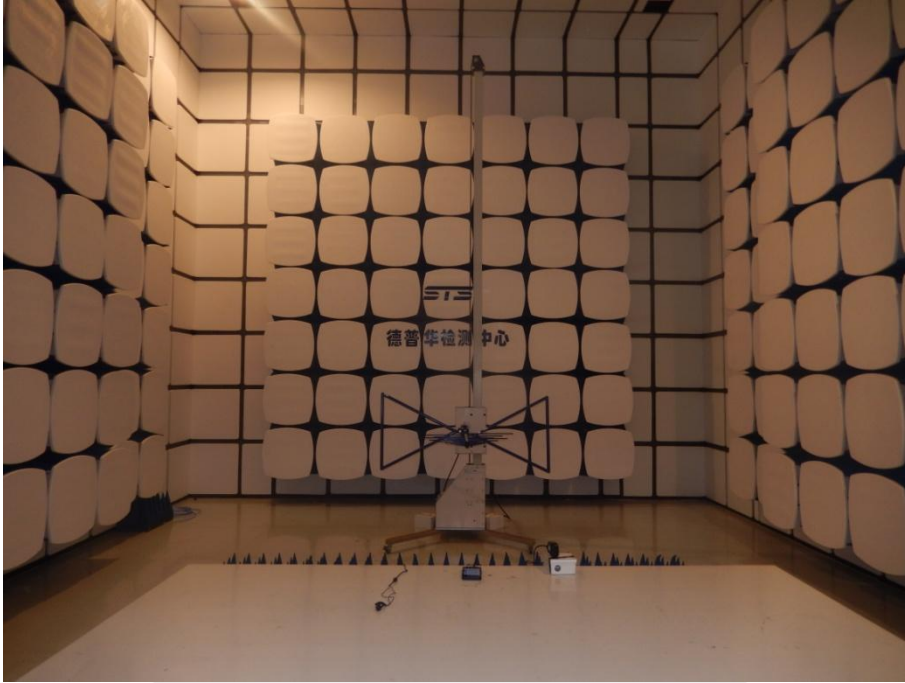





### Conducted Measurement Photos



\*\*\*\*\*END OF THE REPORT\*\*\*\*\*