



# RADIO TEST REPORT

Report No: STS1608150F01

Issued for

XTR S.A.C.

Av. Camino Real 1225 Of. 201 A - San Isidro, Lima - Perú

<b>Product Name:</b>	feature phone
<b>Brand Name:</b>	EKS
<b>Model Name:</b>	FX2.4TVU
<b>Series Model:</b>	N/A
<b>FCC ID:</b>	2AGAK-FX24TVU
<b>Test Standard:</b>	FCC Part 22H and 24E

Any reproduction of this document must be done in full. No single part of this document may be reproduced without permission from STS, All Test Data Presented in this report is only applicable to presented Test sample.





### TEST RESULT CERTIFICATION

**Applicant's name** ..... : XTR S.A.C.

Address..... : Av. Camino Real 1225 Of. 201 A - San Isidro, Lima - Perú

**Manufacture's Name** ..... : Encorp Limited

Address..... : Room 219, East Building, Jianda Mansion, No.1 Kewei Road, Tech Park, Nanshan District, Shenzhen, China

Product name..... : feature phone

Brand name ..... : EKS

Model and/or type reference .. : FX2.4TVU

**Standards** ..... : FCC Part 22H and 24E

Test procedure ..... ANSI/TIA 603-D (2010)

This device described above has been tested by STS and the test results show that the equipment under test (EUT) is in compliance with the FCC requirements. And it is applicable only to the tested sample identified in the report.

This report shall not be reproduced except in full, without the written approval of STS, this document may be altered or revised by STS, personal only, and shall be noted in the revision of the document.

**Date of Test** .....

Date of performance of tests ..... 18 Aug. 2016~29 Aug. 2016

Date of Issue ..... 30 Aug. 2016

Test Result ..... **Pass**

Testing Engineer :   
\_\_\_\_\_  
(Tony Liu)

Technical Manager :   
\_\_\_\_\_  
(Vita Li)

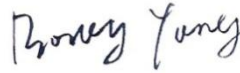
Authorized Signatory :   
\_\_\_\_\_  
(Bovey Yang)





<b>TABLE OF CONTENTS</b>	<b>Page</b>
<b>1 INTRODUCTION</b>	<b>6</b>
1.1 TEST FACTORY	6
1.2 MEASUREMENT UNCERTAINTY	6
<b>2 PRODUCT INFORMATION</b>	<b>7</b>
<b>3 TEST CONFIGURATION OF EQUIPMENT UNDER TEST</b>	<b>8</b>
<b>4 MEASUREMENT INSTRUMENTS</b>	<b>9</b>
<b>5 TEST ITEMS</b>	<b>10</b>
5.1 CONDUCTED OUTPUT POWER	10
5.2 PEAK TO AVERAGE RATIO	11
5.3 TRANSMITTER RADIATED POWER (EIRP/ERP)	12
5.4 OCCUPIED BANDWIDTH	13
5.5 FREQUENCY STABILITY	14
5.6 SPURIOUS EMISSIONS AT ANTENNA TERMINALS	15
5.7 BAND EDGE	16
5.8 FIELD STRENGTH OF SPURIOUS RADIATION MEASUREMENT	17
<b>APPENDIX A TEST RESULT</b>	<b>19</b>
A1 CONDUCTED OUTPUT POWER	19
A2 PEAK-TO-AVERAGE RATIO	21
A3 TRANSMITTER RADIATED POWER (EIRP/ERP)	22
A4 OCCUPIED BANDWIDTH(99% OCCUPIED BANDWIDTH/26DB BANDWIDTH)	25
A5 FREQUENCY STABILITY	33
A6 SPURIOUS EMISSIONS AT ANTENNA TERMINALS	36
A7 BAND EDGE	42
A8 FIELD STRENGTH OF SPURIOUS RADIATION MEASUREMENT	48
<b>APPENDIX B PHOTOS OF TEST SETUP</b>	<b>54</b>

**Revision History**

Rev.	Issue Date	Report NO.	Effect Page	Contents
00	30 Aug. 2016	STS1608150F01	ALL	Initial Issue





## SUMMARY OF TEST RESULTS

Test procedures according to the technical standards:

The radiated emission testing was performed according to the procedures of ANSI/TIA-603-D: 2010, KDB 971168 D01 v02r02 and KDB 648474 D03 v01r04

FCC Rules	Test Description	Test Limit	Test Result	Reference
2.1049	Conducted Output Power	Reporting Only	PASS	
2.0146 24.232	Peak-to-Average Ratio	< 13 dB	PASS	
2.1046 22.913 24.232	Effective Radiated Power/Equivalent Isotropic Radiated Power	< 7 Watts max. ERP(Part 22) < 2 Watts max. EIRP(Part 24)	PASS	
2.1049 22.917 24.238	Occupied Bandwidth	Reporting Only	PASS	
2.1055 22.355 24.235	Frequency Stability	< 2.5 ppm (Part 22) Emission must remain in band (Part 24)	PASS	
2.1051 22.917 24.238	Spurious Emission at Antenna Terminals	< $43+10\log_{10}(P[\text{Watts}])$	PASS	
2.1053 22.917 24.238	Field Strength of Spurious Radiation	< $43+10\log_{10}(P[\text{Watts}])$	PASS	
2.1051 22.917 24.238	Band Edge	< $43+10\log_{10}(P[\text{Watts}])$	PASS	



## 1 INTRODUCTION

### 1.1 TEST FACTORY

Shenzhen STS Test Services Co., Ltd.

Add. : 1/F., Building B, Zhuoke Science Park, No.190,Chongqing Road,  
Fuyong Street, Bao'an District, Shenzhen, Guangdong,China

CNAS Registration No.: L7649;

FCC Registration No.: 842334; IC Registration No.: 12108A-1

### 1.2 MEASUREMENT UNCERTAINTY

The measurement uncertainties shown below were calculated in accordance with the requirements of ANSI C63.4-2014. All measurement uncertainty values are shown with a coverage factor of  $k = 2$  to indicate a 95% level of confidence. The measurement data shown herein meets or exceeds the CISPR measurement uncertainty values specified in CISPR 16-4-2 and, thus, can be compared directly to specified limits to determine compliance.

No.	Item	Uncertainty
1	RF power,conducted	$\pm 0.70\text{dB}$
2	Spurious emissions,conducted	$\pm 1.19\text{dB}$
5	All emissions,radiated(<1G) 30MHz-200MHz	$\pm 2.83\text{dB}$
6	All emissions,radiated(<1G) 200MHz-1000MHz	$\pm 2.94\text{dB}$
7	All emissions,radiated(>1G)	$\pm 3.03\text{dB}$
8	Temperature	$\pm 0.5^{\circ}\text{C}$
9	Humidity	$\pm 2\%$



## 2 PRODUCT INFORMATION

Product Designation:	feature phone
Hardware version number:	N/A
Software version number:	N/A
FCC ID:	2AGAK-FX24TVU
Tx Frequency:	GSM/GPRS: 850: 824.2 MHz ~ 848.8 MHz 1900: 1850.2 MHz ~ 1909.8MHz WCDMA: Band V: 826.4 MHz ~ 846.6 MHz Band II: 1852.4 MHz ~ 1907.6 MHz
Rx Frequency	GSM/GPRS: 850: 869.2 MHz ~ 893.8 MHz 1900: 1930.2 MHz ~ 1989.8 MHz WCDMA: Band V: 871.4 MHz ~ 891.6 MHz Band II: 1932.4 MHz ~ 1987.6 MHz
Max RF Output Power:	GSM850:29.65dBm,PCS1900:25.30dBm GPRS850:29.32dBm,GPRS1900:24.88dBm WCDMABand V:22.24dBm,WCDMA Band II:16.44dBm
Type of Emission:	GSM(850):319KGXW: GSM(1900):322KGXW GPRS(850):318KGXW: GPRS(1900):321KGXW WCDMA850:4M69F9W WCDMA1900:4M74F9W
SIM Card	SIM 1 and SIM 2 is a chipset unit and tested as single chip-set,SIM 1 is used to tested
Antenna:	PIFA Antenna
Antenna gain:	GSM 850:0.4dBi ,PCS 1900:0.9dBi WCDMA 850:0.5dBi, WCDMA1900:0.8dBi
Power Supply:	DC 3.7V by battery
Battery parameter:	Capacitance: 750mAh, Rated Voltage: 3.7V
GPRS Class	Multi-Class12
Extreme Vol. Limits:	DC3.4 V to 4.2 V (Nominal DC3.7V )
Extreme Temp. Tolerance	-20°C to +45°C
<b>** Note: The High Voltage 4.2 V and Low Voltage 3.4 V was declared by manufacturer, The EUT couldn't be operate normally with higher or lower voltage.</b>	



### 3 TEST CONFIGURATION OF EQUIPMENT UNDER TEST

Antenna port conducted and radiated test items were performed according to KDB 971168 D01 Power Meas. License Digital Systems v02r02 with maximum output power.

Radiated measurements were performed with rotating EUT in different three orthogonal test planes to find the maximum emission.

Radiated emissions were investigated as following frequency range:

1. 30 MHz to 10th harmonic for GSM850 and WCDMA Band V.
2. 30 MHz to 10th harmonic for WCDMA Band IV.
3. 30 MHz to 10th harmonic for GSM1900 and WCDMA Band II.

All modes and data rates and positions were investigated.

Test modes are chosen to be reported as the worst case configuration below:

BAND	TEST MODES	
	RADIATED TCS	CONDUCTED TCS
GSM 850	GSM LINK GPRS CLASS 12 LINK	GSM LINK GPRS CLASS 12 LINK
GSM 1900	GSM LINK GPRS CLASS 12 LINK	GSM LINK GPRS CLASS 12 LINK
WCDMA BAND V	RMC 12.2KBPS LINK	RMC 12.2KBPS LINK
WCDMA BAND II	RMC 12.2KBPS LINK	RMC 12.2KBPS LINK





## 4 MEASUREMENT INSTRUMENTS

Kind of Equipment	Manufacturer	Type No.	Serial No.	Last Calibration	Calibrated Until
Spectrum Analyzer	Agilent	E4407B	MY50140340	2015.10.25	2016.10.24
Signal Analyzer	Agilent	N9020A	MY49100060	2015.11.18	2016.11.17
Test Receiver	R&S	ESCI	101427	2015.10.25	2016.10.24
Communication Tester	Agilent	8960	MY48360751	2015.11.20	2016.11.19
Communication Tester	R&S	CMU200	112012	2015.10.25	2016.10.24
Test Receiver	R&S	ESCI	102086	2015.10.25	2016.10.24
Bilog Antenna	TESEQ	CBL6111D	34678	2015.11.25	2016.11.24
Bilog Antenna (Calibration antenna)	TESEQ	CBL6111D	34678	2015.11.25	2016.11.24
Horn Antenna	Schwarzbeck	BBHA 9120D	9120D-1343	2016.03.06	2017.03.05
Horn Antenna (Calibration antenna)	Schwarzbeck	BBHA 9170D	9120D-1344	2016.03.06	2017.03.05
MXA SIGNAL Analyzer	Agilent	N9020A	MY49100060	2015.10.25	2016.10.24
Double Ridge Horn Antenna	COM-POWER CORPORATION	AH-840	AHA-840	2016.03.06	2017.03.05
Low frequency cable	N/A	R01	N/A	N/A	N/A
High frequency cable	SCHWARZBECK	AK9515H	SN-96286/96287	N/A	N/A
Vector signal generator	Agilent	E8257D-521	MY45141029	2015.10.16	2016.10.14
Power amplifier	DESAY	ZHL-42W	9638	2015.10.24	2016.10.23

Equipment with a calibration date of "N/A" shown in this list was not used to make direct calibrated measurements.

## 5 TEST ITEMS

### 5.1 CONDUCTED OUTPUT POWER

#### Test overview

A system simulator was used to establish communication with the EUT. Its parameters were set to enforce EUT transmitting at the maximum power. The measured power in the radio frequency on the transmitter output terminals shall be reported.

#### Test procedures

1. The transmitter output port was connected to the system simulator.
2. Set eut at maximum power through the system simulator.
3. Select lowest, middle, and highest channels for each band and different modulation.
4. Measure and record the power level from the system simulator.

#### Test setup

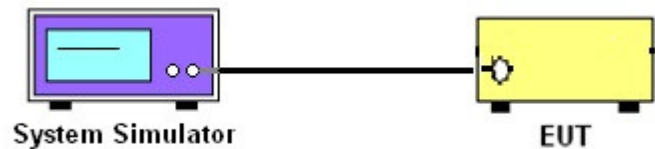

## 5.2 PEAK TO AVERAGE RATIO

### TEST OVERVIEW

According to §24.232(d), power measurements for transmissions by stations authorized under this section may be made either in accordance with a commission-approved average power technique or in compliance with paragraph (e) of this section. In both instances, equipment employed must be authorized in accordance with the provisions of §24.51. In measuring transmissions in this band using an average power technique, the peak-to-average ratio (PAR) of the transmission may not exceed 13 db.

### TEST PROCEDURES

1. The testing follows fcckdb 971168 v02r02 section
2. The eut was connected to the and peak and av system simulator& spectrum analysis reads
3. Select lowest, middle, and highest channels for each band and different modulation.
4. Set the test probe and measure average power of the spectrum analysis

### TEST SETUP

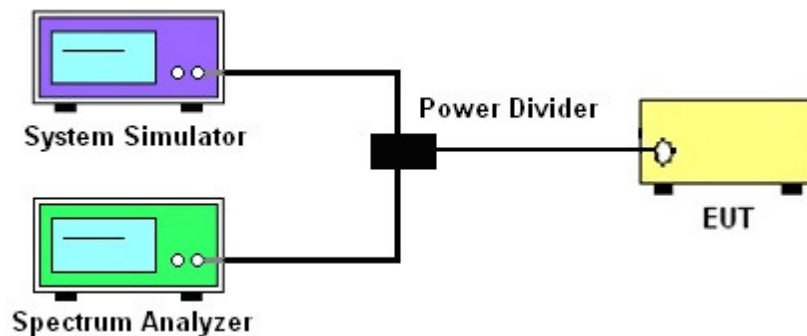



### 5.3 TRANSMITTER RADIATED POWER (EIRP/ERP)

#### TEST OVERVIEW

Effective Radiated Power (ERP) and Equivalent Isotropic Radiated Power (EIRP) measurements are performed using the substitution method described in ANSI/TIA-603-D-2010 with the EUT transmitting into an integral antenna. Measurements on signals operating below 1GHz are performed using vertically polarized tuned dipole antennas. Measurements on signals operating above 1GHz are performed using vertically polarized broadband horn antennas. All measurements are performed as RMS average measurements while the EUT is operating at maximum power, and at the appropriate frequencies.

#### TEST PROCEDURE

1. The testing follows FCC KDB 971168 D01 Section 5.2.1. (for CDMA/WCDMA), Section 5.2.2 (for GSM/GPRS) and ANSI / TIA-603-D-2010 Section 2.2.17.
2. The transmitter was placed on a wooden turntable, and it was transmitting into a non-radiating load which was also placed on the turntable.
3. The measurement antenna was placed at a distance of 3 meters from the EUT. During the tests, the antenna height and polarization as well as EUT azimuth were varied in order to identify the maximum level of emissions from the EUT. The test was performed by placing the EUT on 3-orthogonal axis.
4. The frequency range up to tenth harmonic of the fundamental frequency was investigated.
5. Remove the EUT and replace it with substitution antenna. A signal generator was connected to the substitution antenna by a nonradiating cable. The absolute levels of the spurious emissions were measured by the substitution.
6. Effective Isotropic Radiated Power (EIRP) was measured by substitution method according to TIA/EIA-603-D. The EUT was replaced by the substitution antenna at same location, and then a known power from S.G. was applied into the dipole antenna through a Tx cable, and then recorded the maximum Analyzer reading through raised and lowered the test antenna. The correction factor (in dB) = S.G. - Tx Cable loss + Substitution antenna gain - Analyzer reading. Then the EUT's EIRP/ERP was calculated with the correction factor,  
$$ERP/EIRP = P.SG + GT - LC$$
  
ERP/EIRP = effective or equivalent radiated power, respectively (expressed in the same units as P<sub>Meas</sub> as, typically dBW or dBm);  
P<sub>Meas</sub>(PK) = measured transmitter output power or PSD, in dBm or dBW;  
GT = gain of the transmitting antenna, in dBd (ERP) or dBi (EIRP);  
LC = signal attenuation in the connecting cable between the transmitter and antenna, in dB.

## 5.4 OCCUPIED BANDWIDTH

### TEST OVERVIEW

The occupied bandwidth, that is the frequency bandwidth such that, below its lower and above its upper frequency limits, the mean powers radiated are each equal to 0.5 percent of the total mean power radiated by a given emission shall be measured.

The 26 dB emission bandwidth is defined as the frequency range between two points, one above and one below the carrier frequency, at which the spectral density of the emission is attenuated 26 dB below the maximum in-band spectral density of the modulated signal. Spectral density (power per unit bandwidth) is to be measured with a detector of resolution bandwidth equal to approximately 1.0% of the emission bandwidth.

All modes of operation were investigated and the worst case configuration results are reported in this section.

### TEST PROCEDURE

1. The signal analyzer's automatic bandwidth measurement capability was used to perform the 99% occupied bandwidth and the 26dB bandwidth. The bandwidth measurement was not influenced by any intermediate power nulls in the fundamental emission.
2.  $RBW = 1 - 5\%$  of the expected OBW
3.  $VBW \geq 3 \times RBW$
4. Detector = Peak
5. Trace mode = max hold
6. Sweep = auto couple
7. The trace was allowed to stabilize
8. If necessary, steps 2 – 7 were repeated after changing the RBW such that it would be within 1 – 5% of the 99% occupied bandwidth observed in Step 7

### TEST SETUP

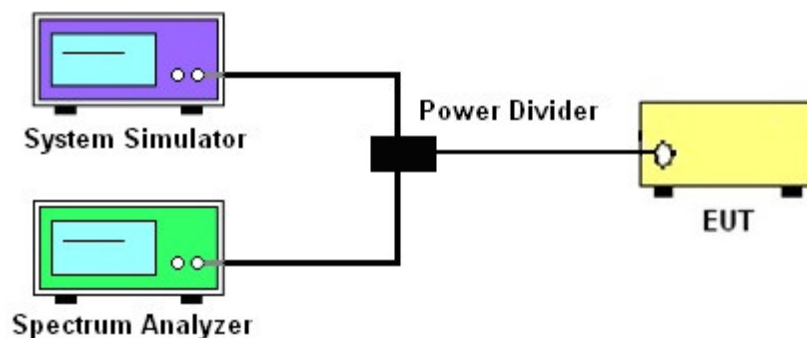

## 5.5 FREQUENCY STABILITY

### Test Overview

Frequency stability testing is performed in accordance with the guidelines of ANSI/TIA-603-D-2010. The frequency stability of the transmitter is measured by:

- a.) Temperature: The temperature is varied from -30°C to +50°C in 10°C increments using an environmental chamber.
- b.) Primary Supply Voltage: The primary supply voltage is varied from 85% to 115% of the nominal value for non hand-carried battery and AC powered equipment. For hand-carried, battery-powered equipment, primary supply voltage is reduced to the battery operating end point which shall be specified by the manufacturer.

For Part 22, the frequency stability of the transmitter shall be maintained within  $\pm 0.00025\%$  ( $\pm 2.5$  ppm) of the center frequency. For Part 24 the frequency stability shall be sufficient to ensure that the fundamental emission stays within the authorized frequency block.

### Test Procedure

#### Temperature Variation

1. The testing follows fccdb 971168 D01 section 9.0
2. The EUT was set up in the thermal chamber and connected with the system simulator.
3. With power OFF, the temperature was decreased to -30°C and the EUT was stabilized before testing. Power was applied and the maximum change in frequency was recorded within one minute.
4. With power OFF, the temperature was raised in 10°C steps up to 50°C. The EUT was stabilized at each step for at least half an hour. Power was applied and the maximum frequency change was recorded within one minute.

#### Voltage Variation

1. The testing follows FCC KDB 971168 D01 Section 9.0.
2. The EUT was placed in a temperature chamber at  $25\pm 5^\circ\text{C}$  and connected with the system simulator.
3. The power supply voltage to the EUT was varied from 85% to 115% of the nominal value measured at the input to the EUT.
4. The variation in frequency was measured for the worst case.

### TEST SETUP

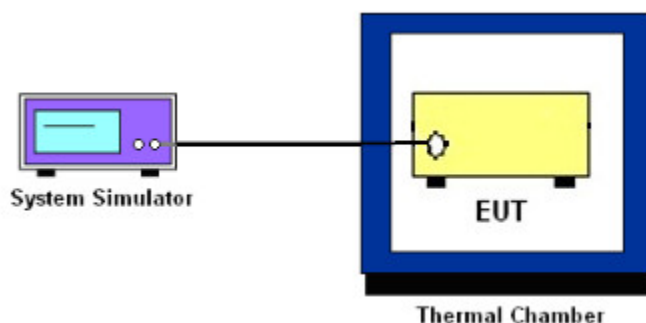

## 5.6 SPURIOUS EMISSIONS AT ANTENNA TERMINALS

### Test Overview

The power of any emission outside of the authorized operating frequency ranges must be lower than the transmitter power (P) by a factor of at least  $43 + 10 \log (P)$  dB.

It is measured by means of a calibrated spectrum analyzer and scanned from 30 MHz up to a frequency including its 10th harmonic.

### Test procedure

1. The testing follows FCC KDB 971168 D01 v02r02 Section 6.0.
2. The EUT was connected to the spectrum analyzer and system simulator via a power divider.
3. The RF output of EUT was connected to the spectrum analyzer by an RF cable and attenuator. The path loss was compensated to the results for each measurement.
4. The middle channel for the highest RF power within the transmitting frequency was measured.
5. The conducted spurious emission for the whole frequency range was taken.
6. The RF fundamental frequency should be excluded against the limit line in the operating frequency band.
7. The limit line is derived from  $43 + 10\log(P)$  dB below the transmitter power P(Watts)  
 $= P(W) - [43 + 10\log(P)]$  (dB)  
 $= [30 + 10\log(P)]$  (dBm) -  $[43 + 10\log(P)]$  (dB)  
 $= -13\text{dBm}$ .

### Test Setup

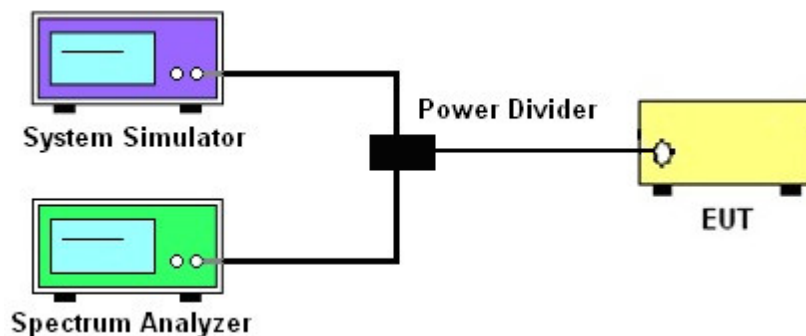



## 5.7 BAND EDGE

### OVERVIEW

All out of band emissions are measured with a spectrum analyzer connected to the antenna terminal of the EUT while the EUT is operating at maximum power, and at the appropriate frequencies. All data rates were investigated to determine the worst case configuration. All modes of operation were investigated and the worst case configuration results are reported in this section.

The minimum permissible attenuation level of any spurious emission is  $43 + \log_{10}(P[\text{Watts}])$ , where P is the transmitter power in Watts.

### TEST PROCEDURE

1. Start and stop frequency were set such that the band edge would be placed in the center of the Plot.
2. The EUT was connected to the spectrum analyzer and system simulator via a power divider.
3. The RF output of EUT was connected to the spectrum analyzer by an RF cable and attenuator. The path loss was compensated to the results for each measurement.
4. The band edges of low and high channels for the highest RF powers were measured.
5. The RF fundamental frequency should be excluded against the limit line in the operating frequency band.
6. The limit line is derived from  $43 + 10\log(P)$  dB below the transmitter power P(Watts)  
 $= P(\text{W}) - [43 + 10\log(P)] (\text{dB})$   
 $= [30 + 10\log(P)] (\text{dBm}) - [43 + 10\log(P)] (\text{dB})$   
 $= -13\text{dBm}.$

### TEST SETUP

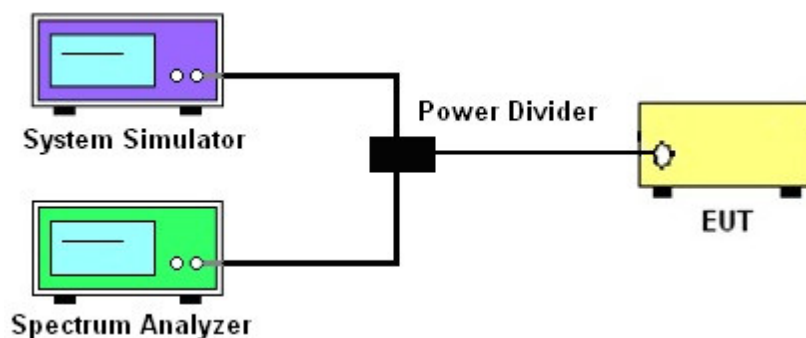





## 5.8 FIELD STRENGTH OF SPURIOUS RADIATION MEASUREMENT

### Test overview

Radiated spurious emissions measurements are performed using the substitution method described in ANSI/TIA-603-D-2010 with the EUT transmitting into an integral antenna. Measurements on signals operating below 1GHz are performed using horizontally and vertically polarized tuned dipole antennas. Measurements on signals operating above 1GHz are performed using vertically and horizontally polarized horn antennas. All measurements are performed as peak measurements while the EUT is operating at maximum power and at the appropriate frequencies.

It is measured by means of a calibrated spectrum analyzer and scanned from 30 MHz up to a frequency including its 10th harmonic.

### Test procedure

1. The testing follows FCC KDB 971168 D01 Section 5.8 and ANSI/TIA-603-D-2010 – Section 2.2.12
2. RBW = 100kHz for emissions below 1GHz and 1MHz for emissions above 1GHz
3. VBW  $\geq$  3 x RBW
4. Span = 1.5 times the OBW
5. No. of sweep points > 2 x span/RBW
6. Detector = Peak
7. Trace mode = max hold
8. The trace was allowed to stabilize

## TEST SETUP

For radiated test from 30MHz to 1GHz

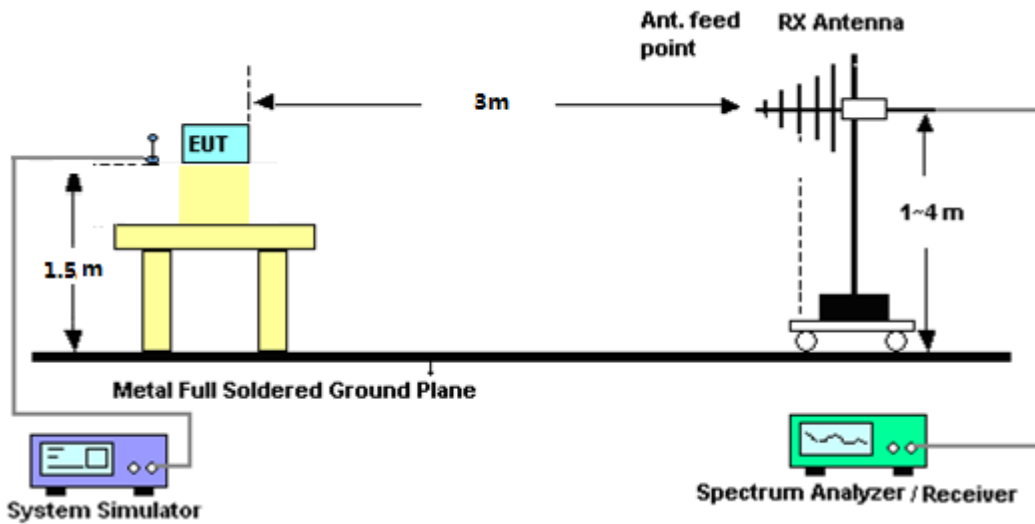

For radiated test from above 1GHz

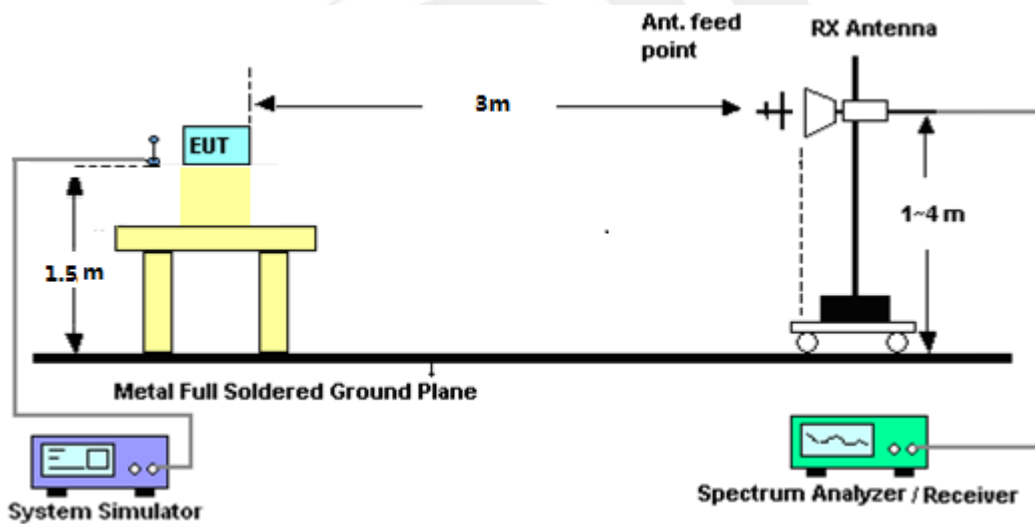

APPENDIX A TEST RESULT  
A1 CONDUCTED OUTPUT POWER

GSM 850:

Mode	Frequency (MHz)	AVG Power
GSM850	824.2	29.51
	836.6	29.53
	848.8	<b>29.65</b>
GPRS850	824.2	<b>29.32</b>
	836.6	29.25
	848.8	29.22

PCS 1900:

Mode	Frequency (MHz)	AVG Power
GSM1900	1850.2	24.96
	1880	<b>25.30</b>
	1909.8	24.58
GPRS1900	1850.2	24.12
	1880	<b>24.88</b>
	1909.8	24.11



## UMTS BAND V

Mode	Frequency(MHz)	AVG Power
WCDMA 850 RMC	826.4	<b>22.24</b>
	836.6	21.58
	846.6	21.78

## UMTS BAND II

Mode	Frequency(MHz)	AVG Power
WCDMA 1900 RMC	1852.4	16.23
	1880	16.37
	1907.6	<b>16.44</b>

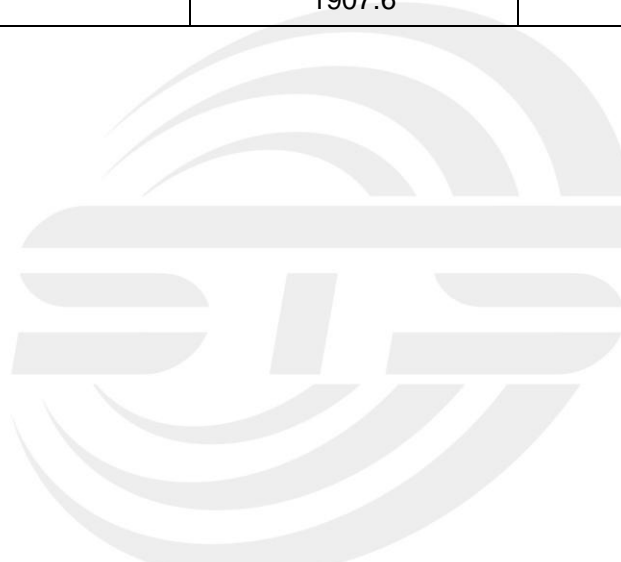



## A2 PEAK-TO-AVERAGE RADIO

PCS 1900:

Mode	Frequency (MHz)	PEAK Power	AVG Power	PAR
PCS1900	1850.2	25.91	24.96	0.95
	1880	<b>25.99</b>	<b>25.30</b>	0.69
	1909.8	25.14	24.58	0.56
GPRS1900	1850.2	24.73	24.12	0.61
	1880	25.88	24.88	1.00
	1909.8	25.06	24.11	0.95

UMTS BAND II:

Mode	Frequency (MHz)	PEAK Power	AVG Power	PAR
WCDMA 1900 RMC	1852.4	18.11	16.23	1.88
	1880	<b>18.17</b>	16.37	1.80
	1907.6	18.14	<b>16.44</b>	1.70



A3 TRANSMITTER RADIATED POWER (EIRP/ERP)

Radiated Power (ERP) for GSM 850 MHZ							
Mode	Frequency	Result					Conclusion
		S G.Level (dBm)	Cable loss	Gain (dBi)	PMeas E.R.P(dBm)	Polarization Of Max. ERP	
GSM850	824.2	21.48	0.44	6.5	27.54	Horizontal	Pass
	824.2	23.39	0.44	6.5	29.45	Vertical	Pass
	836.6	21.59	0.45	6.5	27.64	Horizontal	Pass
	836.6	23.38	0.45	6.5	29.43	Vertical	Pass
	848.8	21.69	0.46	6.5	27.73	Horizontal	Pass
	848.8	23.58	0.46	6.5	29.62	Vertical	Pass
GPRS850	824.2	21.58	0.44	6.5	27.64	Horizontal	Pass
	824.2	23.23	0.44	6.5	29.29	Vertical	Pass
	836.6	21.49	0.45	6.5	27.54	Horizontal	Pass
	836.6	23.13	0.45	6.5	29.18	Vertical	Pass
	848.8	21.85	0.46	6.5	27.89	Horizontal	Pass
	848.8	23.38	0.46	6.5	29.42	Vertical	Pass



Radiated Power (EIRP) for PCS 1900 MHZ							
Mode	Frequency	Result					Conclusion
		S G.Level (dBm)	Cable loss	Gain (dBi)	PMeas E.I.R.P.(dBm)	Polarization Of Max.EIRP.	
PCS1900	1850.2	14.77	2.41	10.35	22.71	Horizontal	Pass
	1850.2	16.51	2.41	10.35	24.45	Vertical	Pass
	1880.0	14.51	2.42	10.35	22.44	Horizontal	Pass
	1880.0	16.5	2.42	10.35	24.43	Vertical	Pass
	1909.8	14.84	2.43	10.35	22.76	Horizontal	Pass
	1909.8	16.7	2.43	10.35	24.62	Vertical	Pass
GPRS1900	1850.2	14.6	2.41	10.35	22.54	Horizontal	Pass
	1850.2	16.49	2.41	10.35	24.43	Vertical	Pass
	1880.0	14.64	2.42	10.35	22.57	Horizontal	Pass
	1880.0	16.36	2.42	10.35	24.29	Vertical	Pass
	1909.8	14.79	2.43	10.35	22.71	Horizontal	Pass
	1909.8	16.66	2.43	10.35	24.58	Vertical	Pass



Radiated Power (ERP) for WCDMA Band V							
Mode	Frequency	Result					Conclusion
		S G.Level (dBm)	Cable loss	Gain (dBi)	PMeas E.R.P (dBm)	Polarization Of Max.ERP	
Band V	826.4	13.36	0.44	6.5	19.42	Horizontal	Pass
	826.4	15.06	0.44	6.5	21.12	Vertical	Pass
	836.6	12.93	0.45	6.5	18.98	Horizontal	Pass
	836.6	14.78	0.45	6.5	20.83	Vertical	Pass
	846.6	12.98	0.46	6.5	19.02	Horizontal	Pass
	846.6	14.78	0.46	6.5	20.82	Vertical	Pass

Radiated Power (EIRP) for WCDMA Band II							
Mode	Frequency	Result					Conclusion
		S G.Level (dBm)	Cable loss	Gain (dBi)	PMeas E.I.R.P.(dBm)	Polarization Of Max.EIRP	
Band II	1852.4	6.45	2.41	10.35	14.39	Horizontal	Pass
	1852.4	8.38	2.41	10.35	16.32	Vertical	Pass
	1880.0	6.65	2.42	10.35	14.58	Horizontal	Pass
	1880.0	8.50	2.42	10.35	16.43	Vertical	Pass
	1907.6	6.35	2.43	10.35	14.27	Horizontal	Pass
	1907.6	8.20	2.43	10.35	16.12	Vertical	Pass





## A4 OCCUPIED BANDWIDTH(99% OCCUPIED BANDWIDTH/26DB BANDWIDTH)

<b>Occupied Bandwidth for GSM 850 band</b>			
Mode	Frequency(MHz)	Occupied Bandwidth (99%)( kHz)	Emission Bandwidth (-26dBc)( kHz)
Low Channel	824.2	248.72	319.1
Middle Channel	836.6	246.06	316.8
High Channel	848.8	248.69	317.9
<b>Occupied Bandwidth for GPRS 850 band</b>			
Mode	Frequency(MHz)	Occupied Bandwidth (99%)( kHz)	Emission Bandwidth (-26dBc)( kHz)
Low Channel	824.2	246.06	317.1
Middle Channel	836.6	241.87	314.4
High Channel	848.8	244.12	318.4



<b>Occupied Bandwidth for GSM1900 band</b>			
Mode	Frequency(MHz)	Occupied Bandwidth (99%)( kHz)	Emission Bandwidth (-26dBc)( kHz)
Low Channel	1850.2	244.31	319.7
Middle Channel	1880.0	249.83	314.5
High Channel	1909.8	243.86	321.8

<b>Occupied Bandwidth for GPRS 1900 band</b>			
Mode	Frequency(MHz)	Occupied Bandwidth (99%)( kHz)	Emission Bandwidth (-26dBc)( kHz)
Low Channel	1850.2	247.14	318.0
Middle Channel	1880.0	245.89	315.6
High Channel	1909.8	241.90	321.3

<b>Occupied Bandwidth for UMTS band V</b>			
Mode	Frequency(MHz)	Occupied Bandwidth (99%)( MHz)	Emission Bandwidth (-26dBc)( MHz)
Low Channel	826.4	4.0658	4.649
Middle Channel	836.6	4.1021	4.689
High Channel	846.6	4.1109	4.673

<b>Occupied Bandwidth for UMTS band II</b>			
Mode	Frequency(MHz)	Occupied Bandwidth (99%)( MHz)	Emission Bandwidth (-26dBc)( MHz)
Low Channel	1852.4	4.0941	4.676
Middle Channel	1880	4.1080	4.725
High Channel	1907.6	4.1198	4.740



GSM 850 CH 128

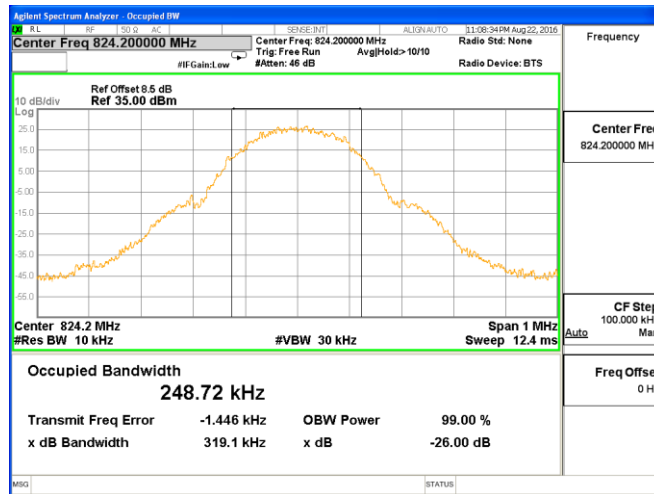

GSM 850 CH 190

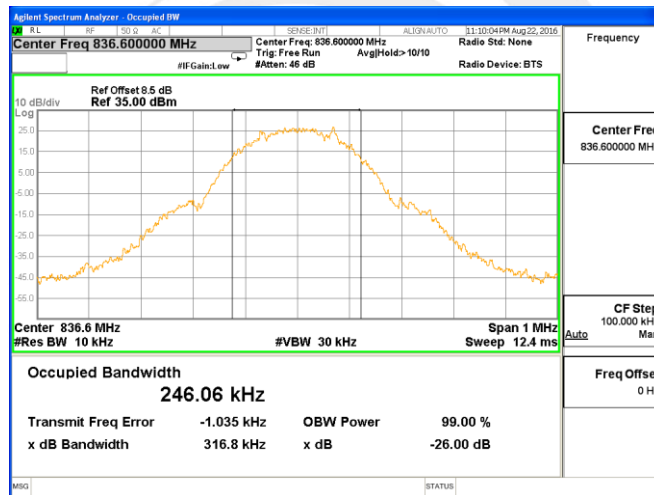

GSM 850 CH 251

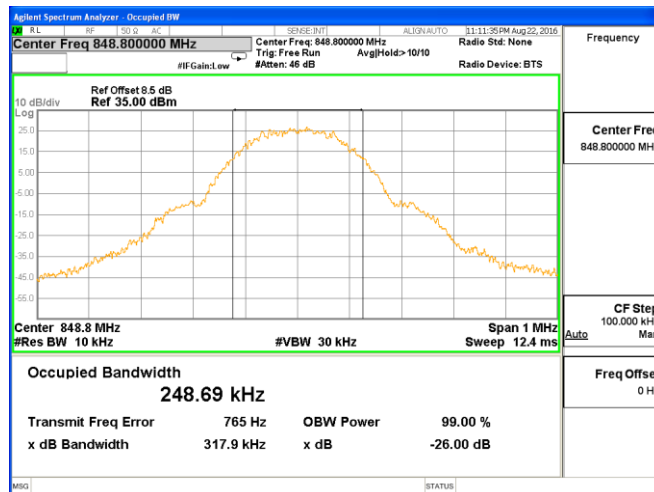



### GPRS 850 CH 128

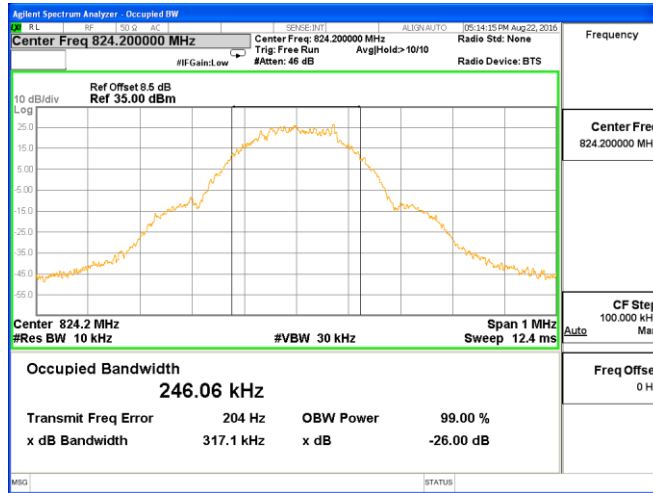

### GPRS 850 CH 190

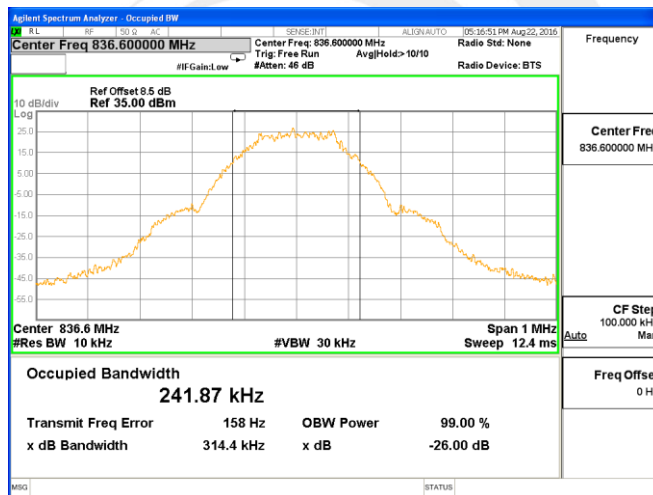

### GPRS 850 CH 251

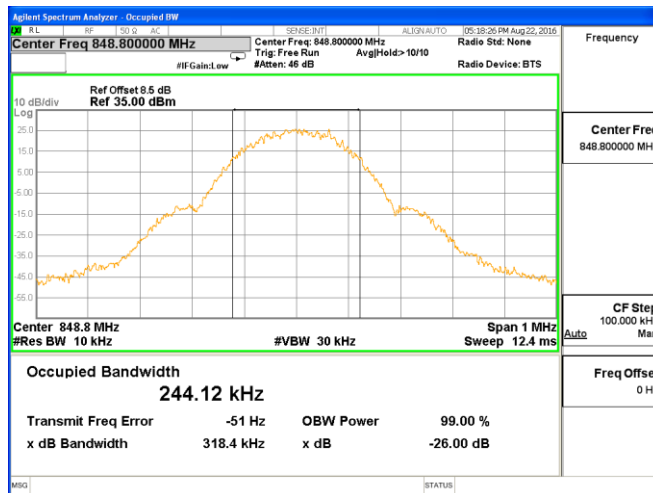



### PCS 1900 CH 512

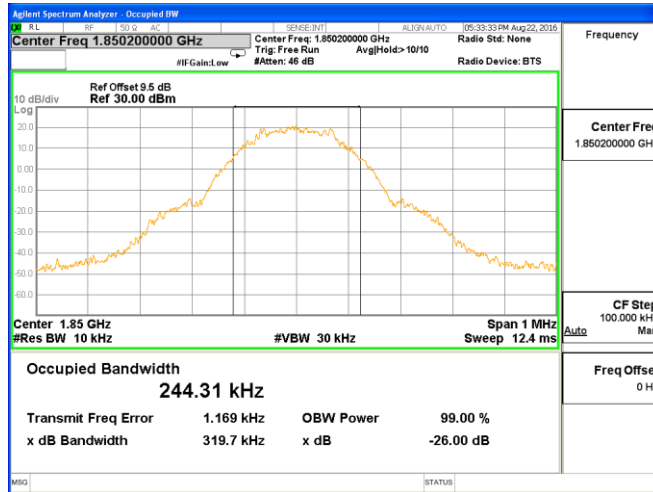

### PCS 1900 CH 661

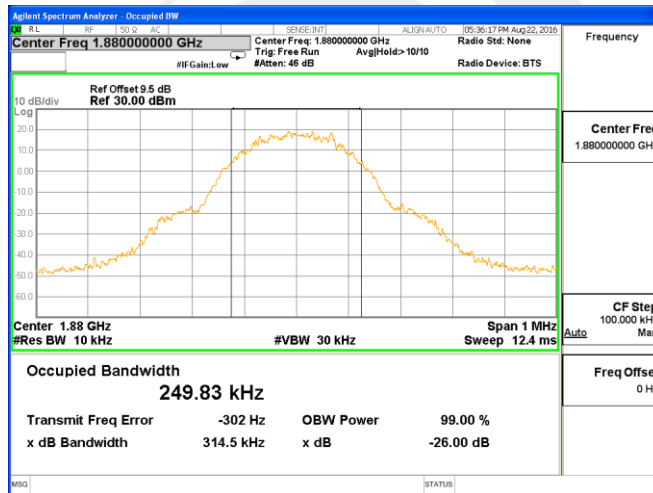

### PCS 1900 CH 810

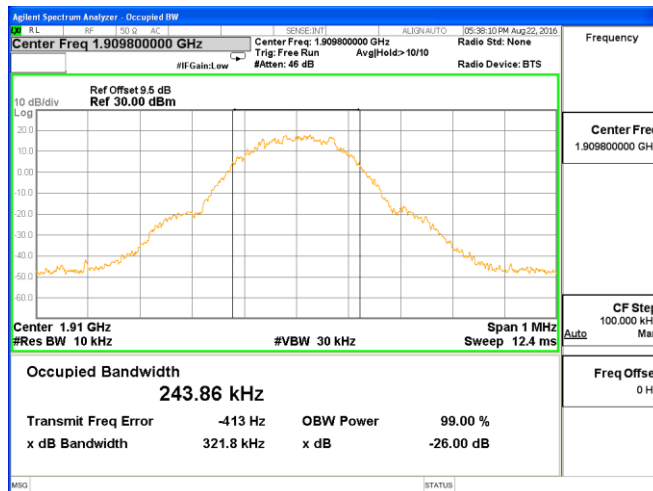



### GPRS 1900 CH 512

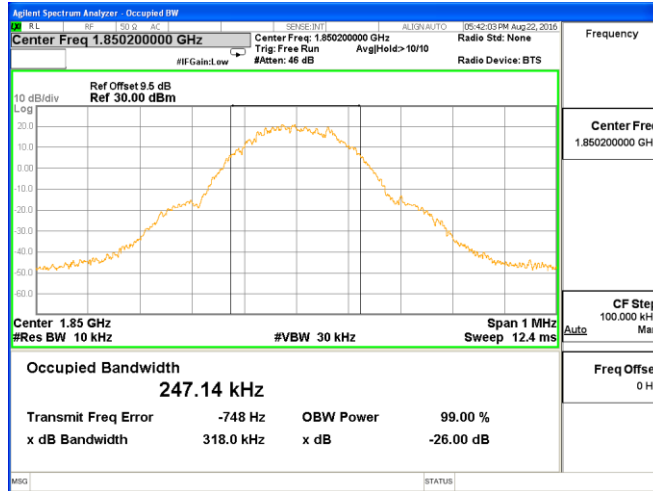

### GPRS 1900 CH 661

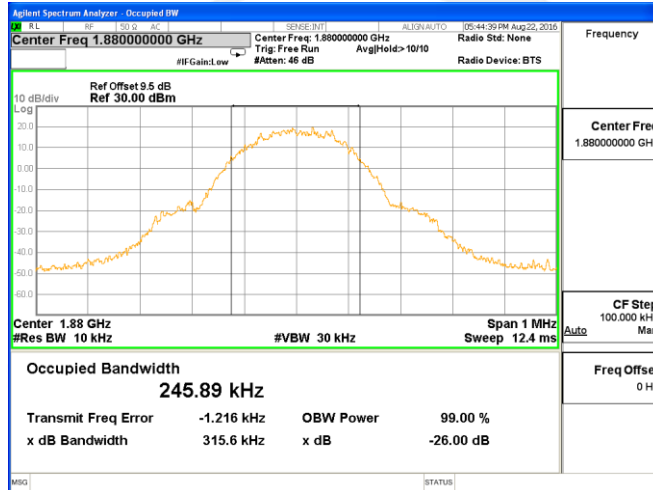

### GPRS 1900 CH 810

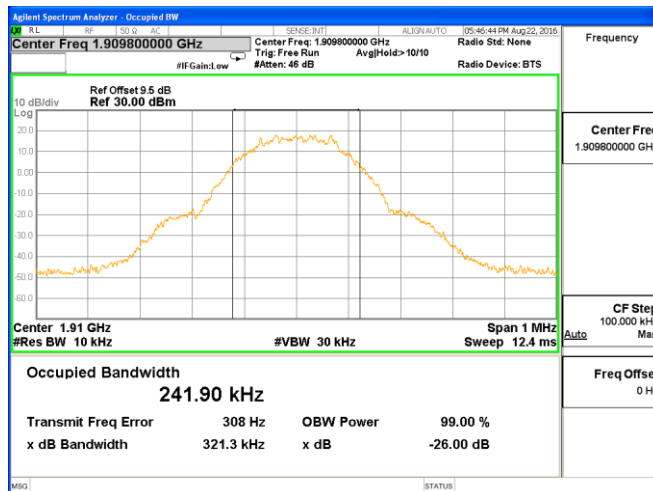



### UMTS BAND V CH 4132

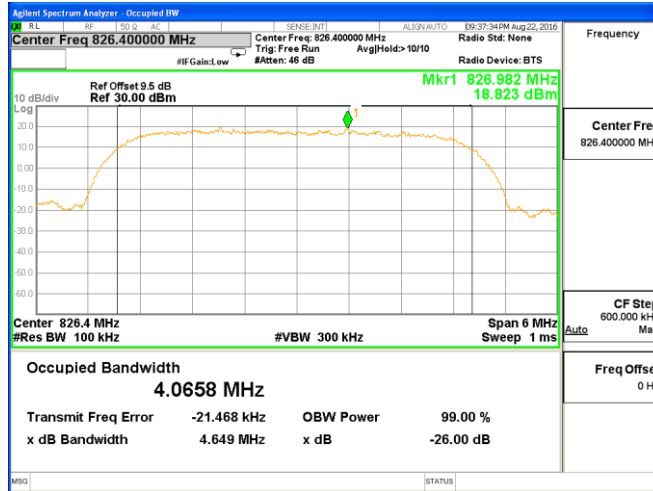

### UMTS BAND V CH 4183

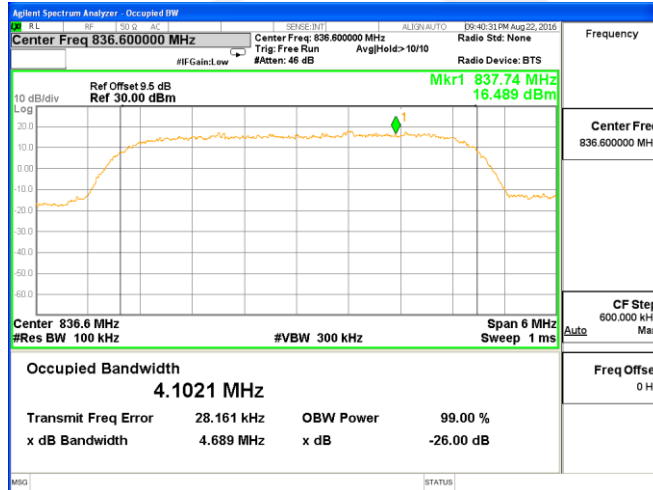

### UMTS BAND V CH 4233

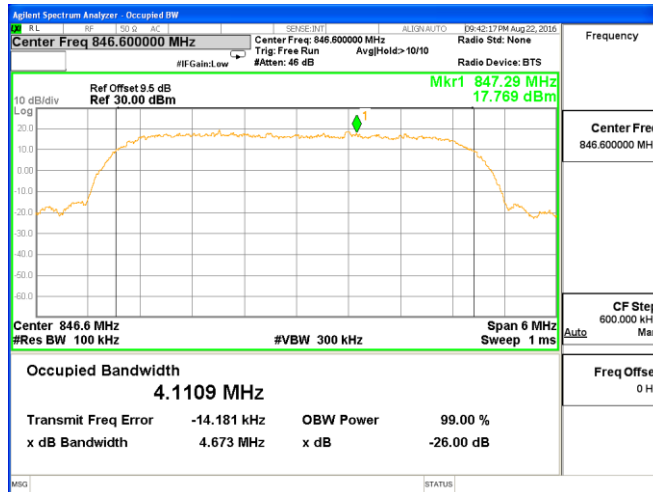



UMTS BAND II CH 9262

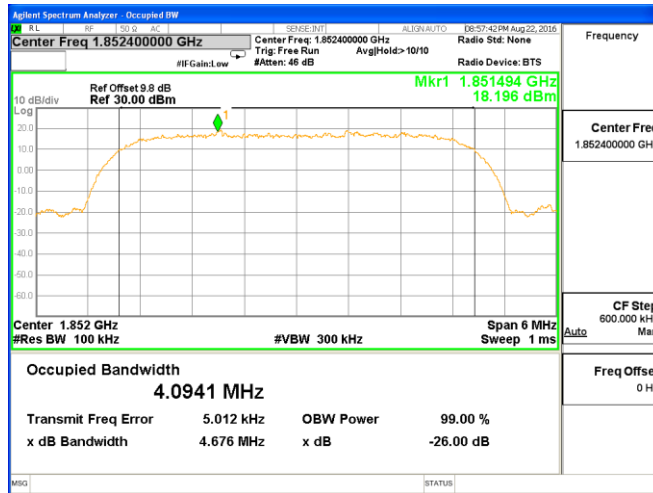

UMTS BAND II CH 9400

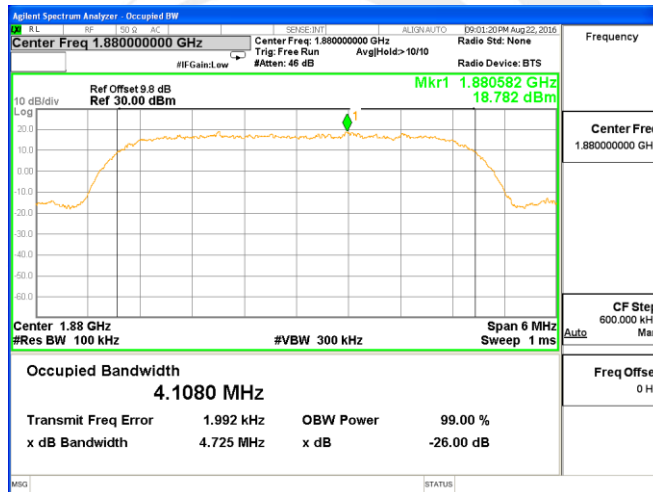

UMTS BAND II CH 9538

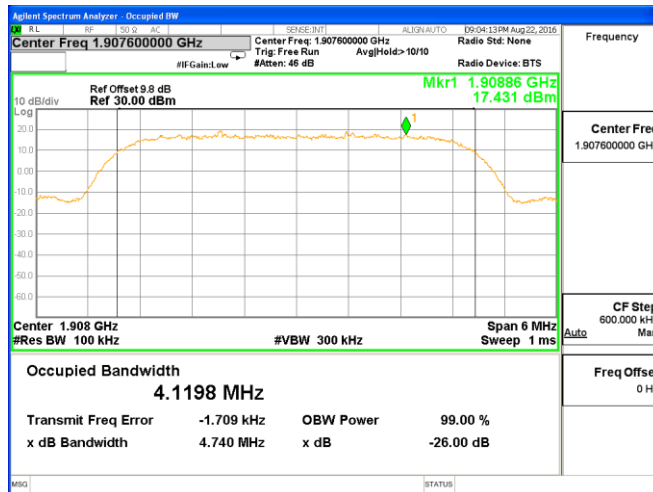





A5 FREQUENCY STABILITY

Normal Voltage = 3.7V. ; Battery End Point (BEP) = 3.4 V.; Maximum Voltage =4.2 V

GSM 850 Middle Channel					
Temperature (°C)	Voltage (Volt)	Freq. Dev. (Hz)	Freq. Dev. (ppm)	Limit	Result
50	Normal Voltage	13.40	0.160	2.5ppm	PASS
40		26.58	0.318		
30		20.77	0.248		
20		18.00	0.215		
10		13.91	0.166		
0		27.24	0.326		
-10		23.93	0.286		
-20		18.86	0.225		
-30		21.38	0.256		
25		Maximum Voltage	15.93		
25	BEP	23.51	0.281		

GPRS 850 Middle Channel					
Temperature (°C)	Voltage (Volt)	Freq. Dev. (Hz)	Freq. Dev. (ppm)	Limit	Result
50	Normal Voltage	16.05	0.192	2.5ppm	PASS
40		21.48	0.257		
30		20.98	0.251		
20		25.73	0.308		
10		24.30	0.290		
0		14.36	0.172		
-10		28.37	0.339		
-20		18.44	0.220		
-30		12.48	0.149		
25		Maximum Voltage	30.69		
25	BEP	12.32	0.014		



GSM 1900 Middle Channel					
Temperature (°C)	Voltage (Volt)	Freq. Dev. (Hz)	Freq. Dev. (ppm)	Limit	Result
50	Normal Voltage	12.28	0.007	Within Authorized Band	PASS
40		17.71	0.009		
30		33.37	0.018		
20		34.19	0.018		
10		27.43	0.015		
0		24.48	0.013		
-10		35.85	0.019		
-20		31.04	0.017		
-30		36.15	0.019		
25		Maximum Voltage	12.49		
25	BEP	23.57	0.013		

GPRS 1900 Middle Channel					
Temperature (°C)	Voltage (Volt)	Freq. Dev. (Hz)	Freq. Dev. (ppm)	Limit	Result
50	Normal Voltage	13.11	0.007	Within Authorized Band	PASS
40		25.49	0.014		
30		27.37	0.015		
20		36.27	0.019		
10		13.18	0.007		
0		24.65	0.013		
-10		17.63	0.009		
-20		35.08	0.019		
-30		30.84	0.016		
25		Maximum Voltage	12.18		
25	BEP	19.21	0.010		



WCDMA V Middle Channel					
Temperature (°C)	Voltage (Volt)	Freq. Dev. (Hz)	Freq. Dev. (ppm)	Limit	Result
50	Normal Voltage	18.63	0.223	2.5ppm	PASS
40		13.57	0.162		
30		30.01	0.359		
20		33.91	0.405		
10		29.24	0.350		
0		12.80	0.153		
-10		11.74	0.140		
-20		34.72	0.415		
-30		22.80	0.273		
25		Maximum Voltage	13.01		
25	BEP	32.60	0.390		

1. The frequency fundamental emissions stay within the authorized frequency block based on the frequency deviation measured is small.

WCDMA II Middle Channel					
Temperature (°C)	Voltage (Volt)	Freq. Dev. (Hz)	Freq. Dev. (ppm)	Limit	Result
50	Normal Voltage	19.60	0.010	Within Authorized Band	PASS
40		34.74	0.018		
30		26.18	0.014		
20		16.32	0.009		
10		28.01	0.015		
0		24.83	0.013		
-10		33.34	0.018		
-20		23.89	0.013		
-30		21.88	0.012		
25		Maximum Voltage	12.98		
25	BEP	11.60	0.006		

1. The frequency fundamental emissions stay within the authorized frequency block based on the frequency deviation measured is small.



A6 SPURIOUS EMISSIONS AT ANTENNA TERMINALS  
 GSM 850 BAND  
 Lowest Channel

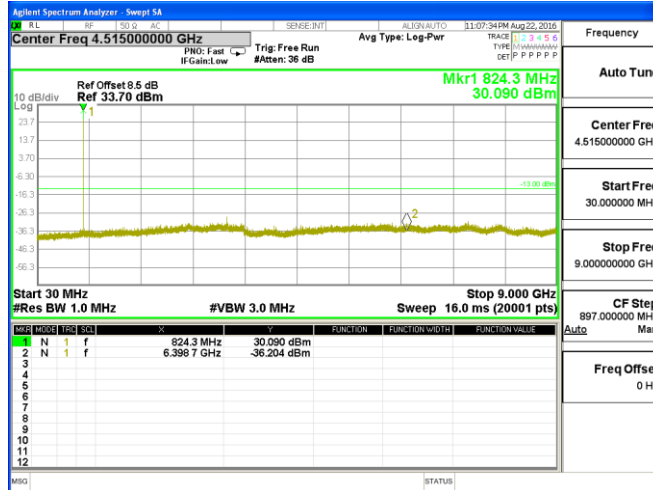

Middle Channel

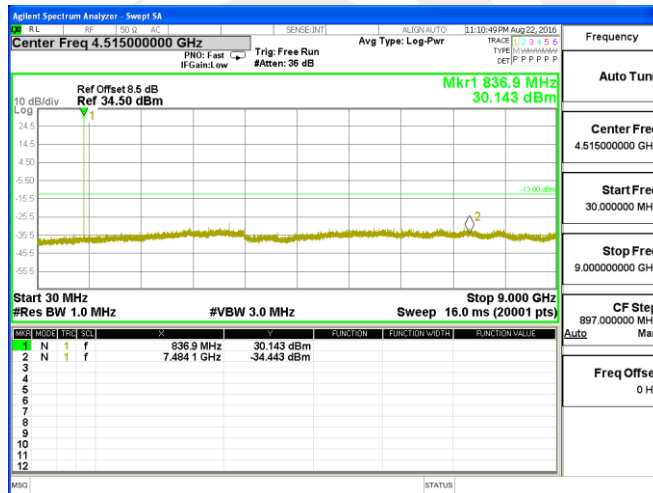

Highest Channel

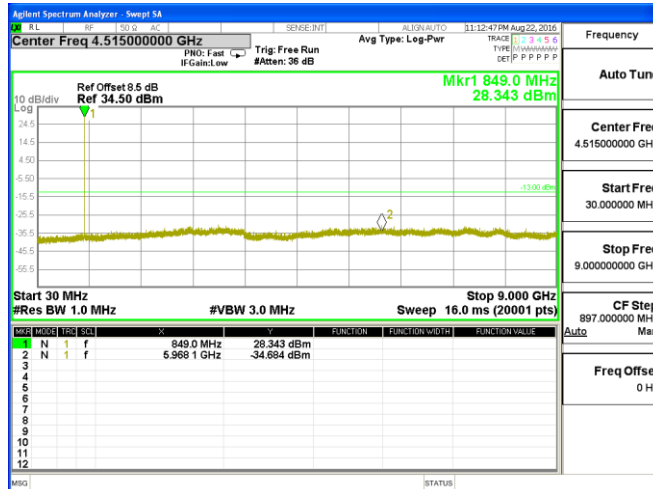



GPRS 850 BAND  
Lowest Channel

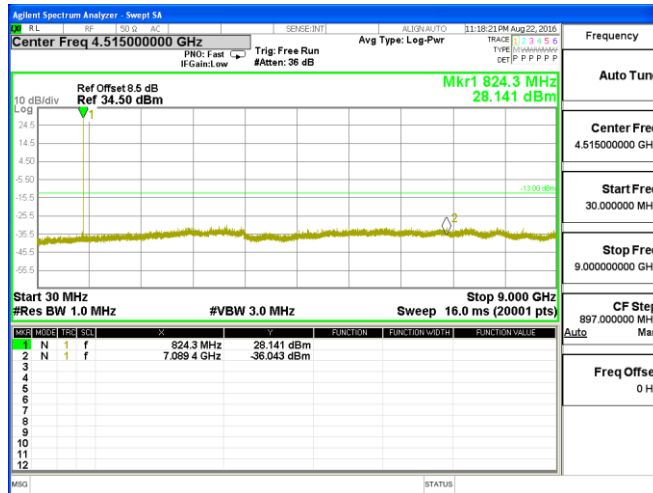

Middle Channel

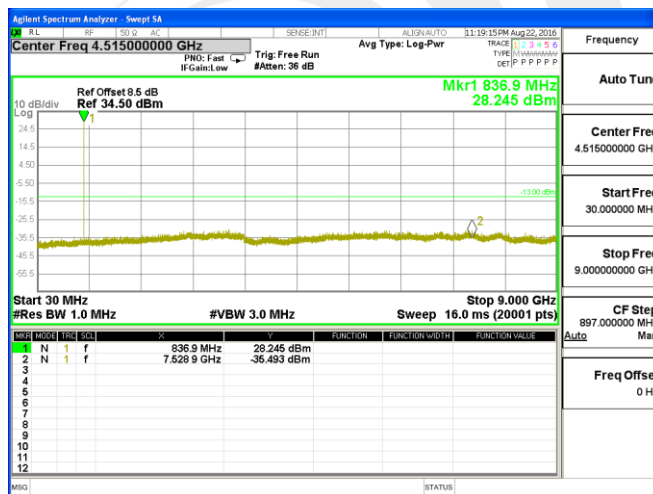

Highest Channel

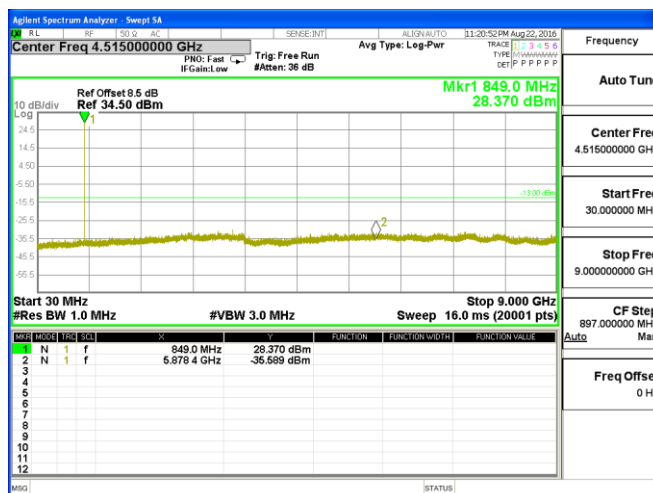



GSM1900 BAND(30M-20G)

Lowest Channel

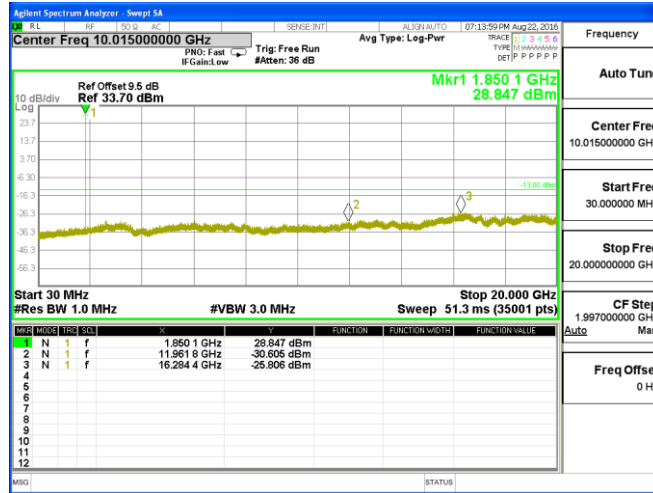

Middle Channel

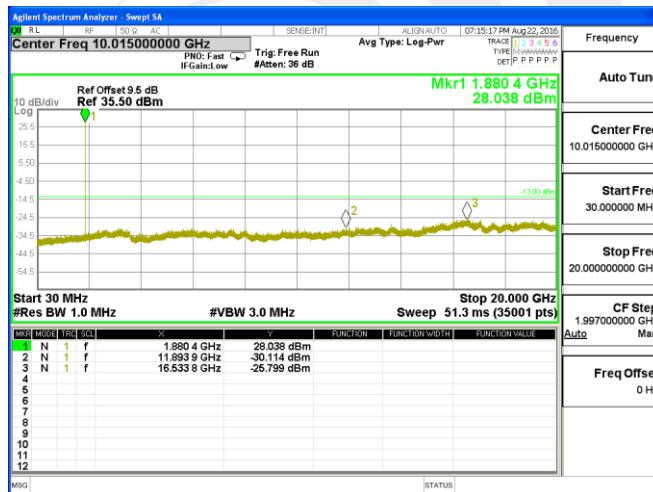

Highest Channel

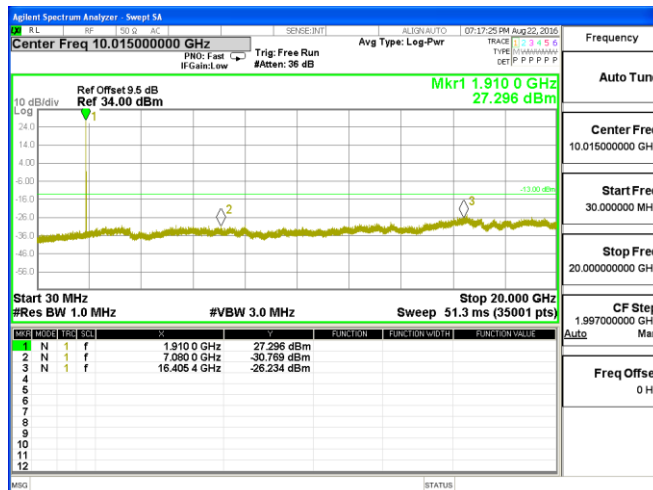



GPRS1900 BAND(30M-20G)

Lowest Channel

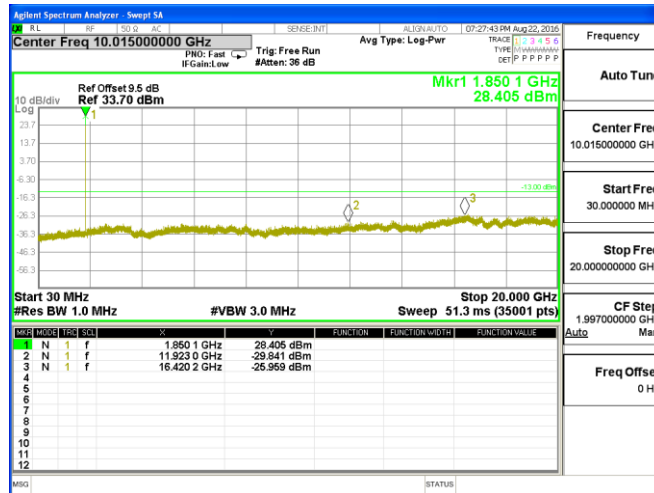

Middle Channel

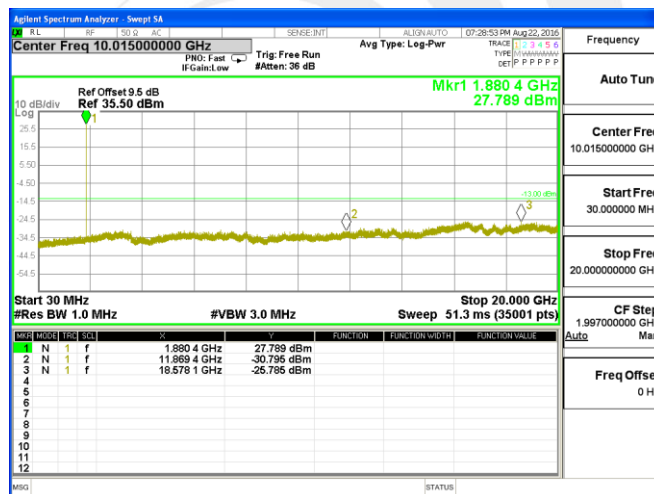

Highest Channel

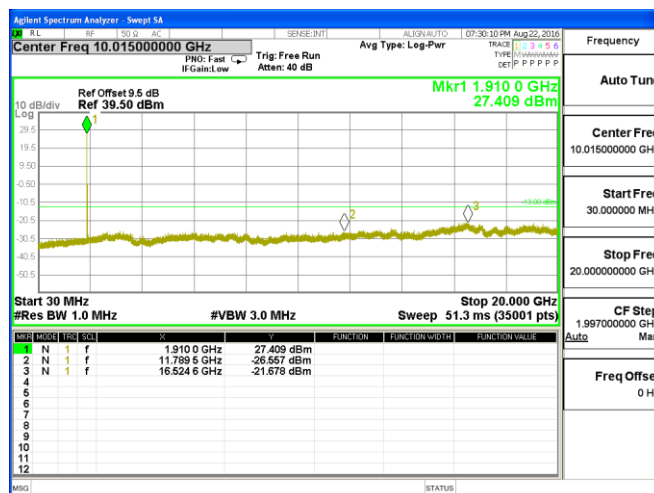



WCDMA Band V (RMC 12.2Kbps)  
Lowest Channel

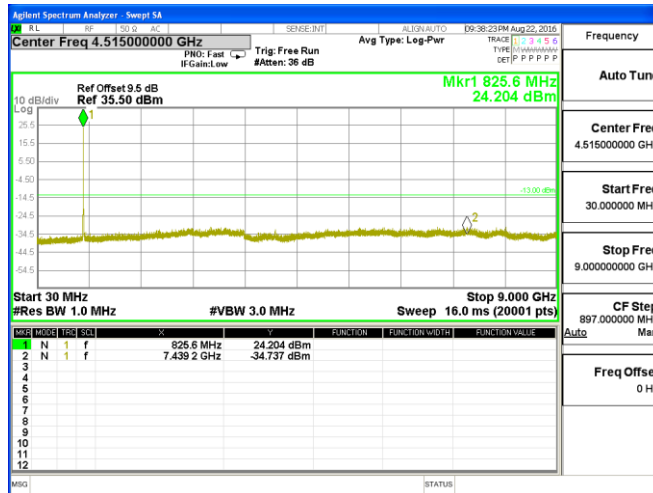

Middle Channel

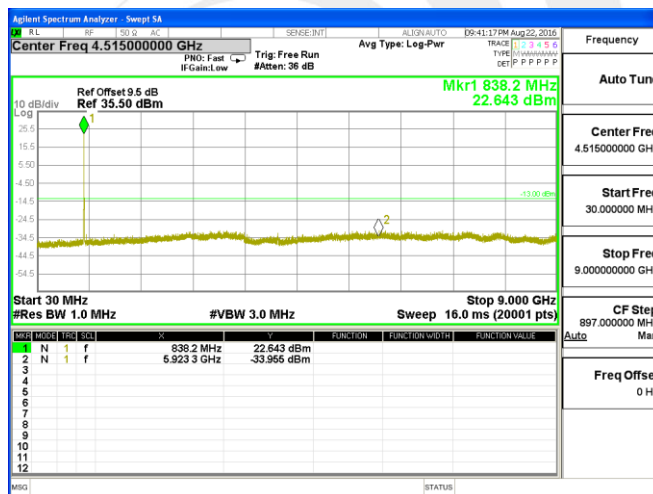

Highest Channel

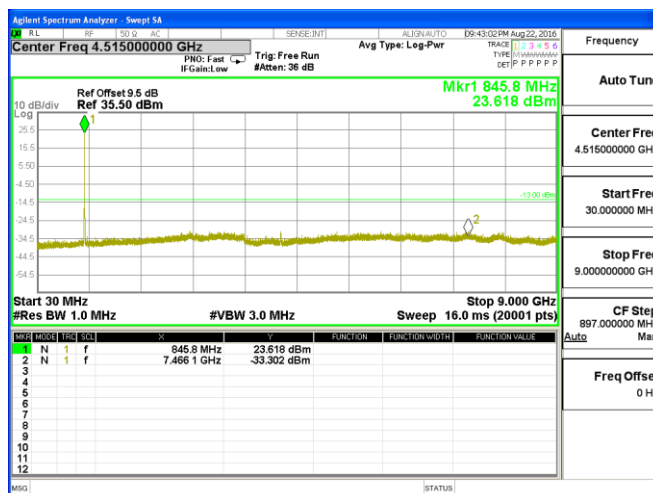





WCDMA Band II (RMC 12.2Kbps)(30M-20G)

Lowest Channel

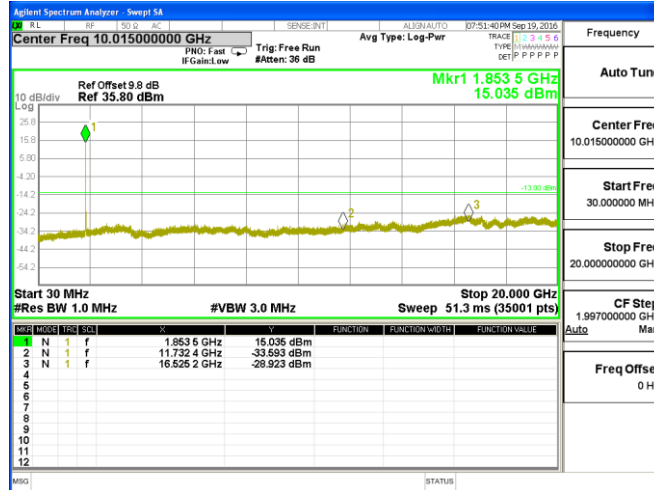

Middle Channel

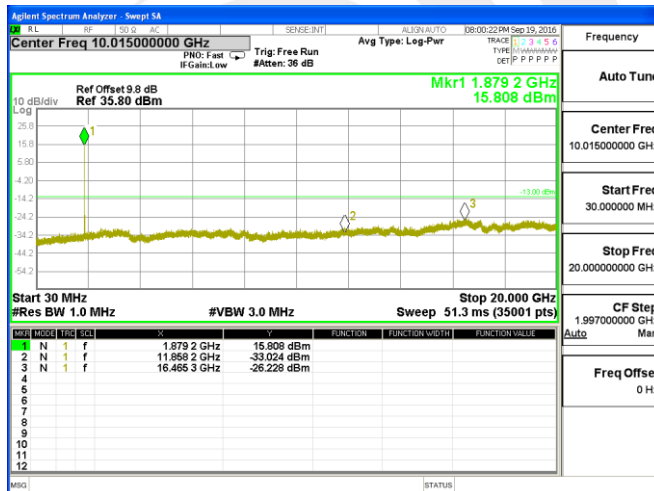

Highest Channel

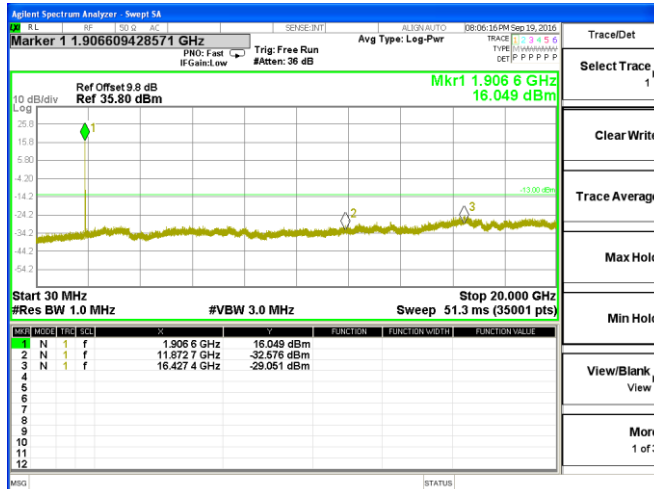



A7 BAND EDGE

GSM 850

Lowest Band Edge

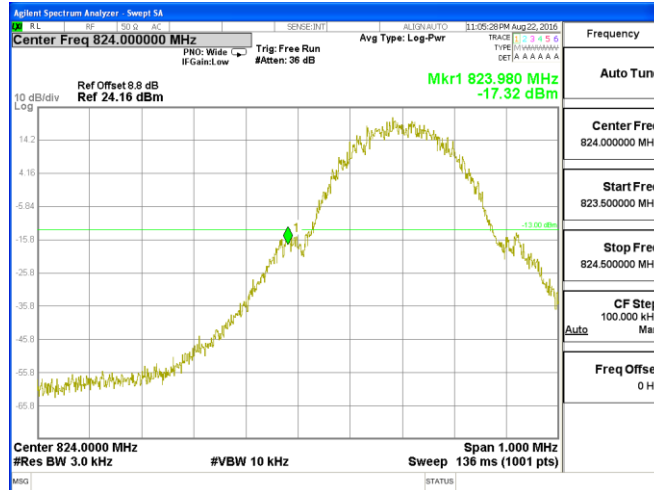

Note: Offset=Cable loss(8.5)+10log(3.2/3)=8.5+0.3=8.8 dB

Highest Band Edge

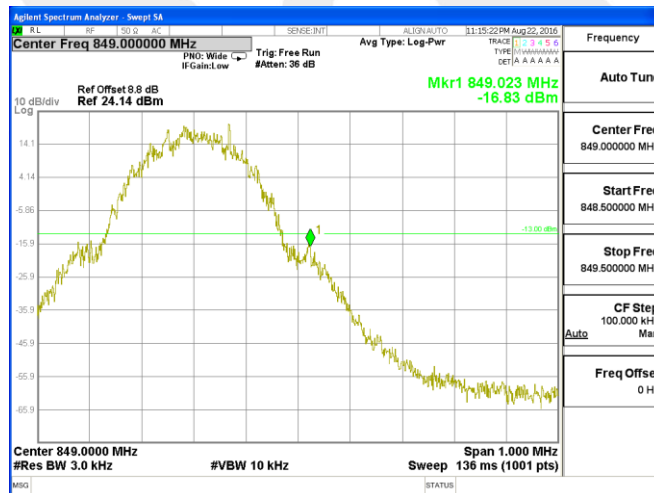

Note: Offset=Cable loss(8.5)+10log(3.2/3)=8.5+0.3=8.8 dB



GPRS 850

Lowest Band Edge

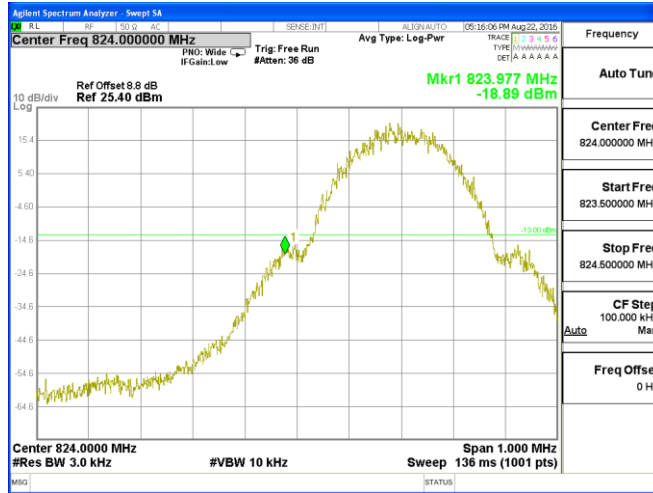

Note: Offset=Cable loss(8.5)+10log(3.2/3)=8.5+0.3=8.8 dB

Highest Band Edge

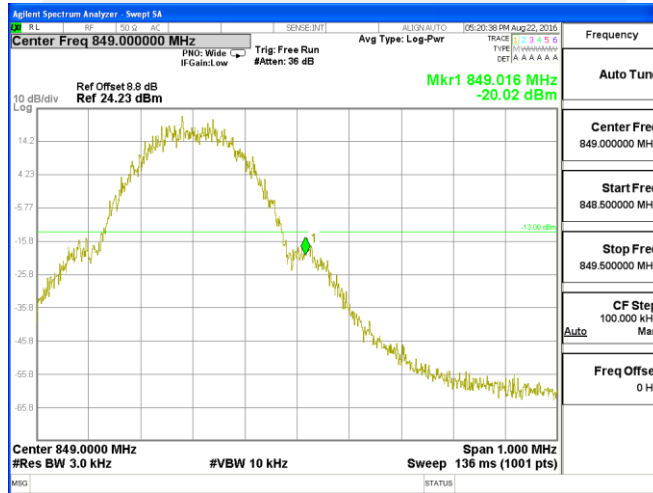

Note: Offset=Cable loss(8.5)+10log(3.2/3)=8.5+0.3=8.8 dB



### GSM 1900

#### Lowest Band Edge

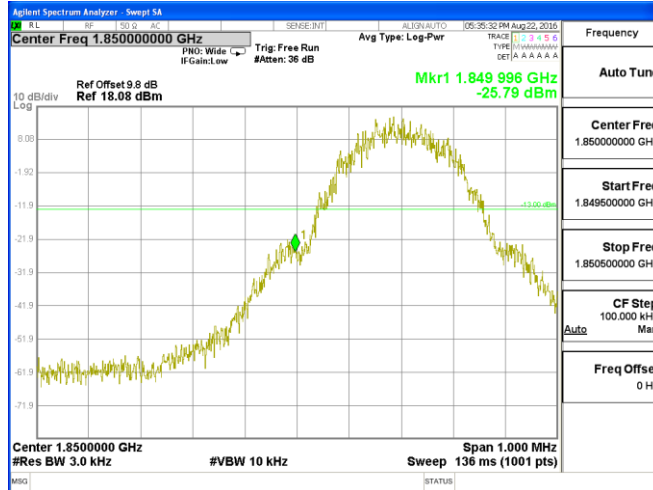

Note: Offset=Cable loss(9.5)+10log(3.2/3)=9.5+0.3=9.8 dB

#### Highest Band Edge

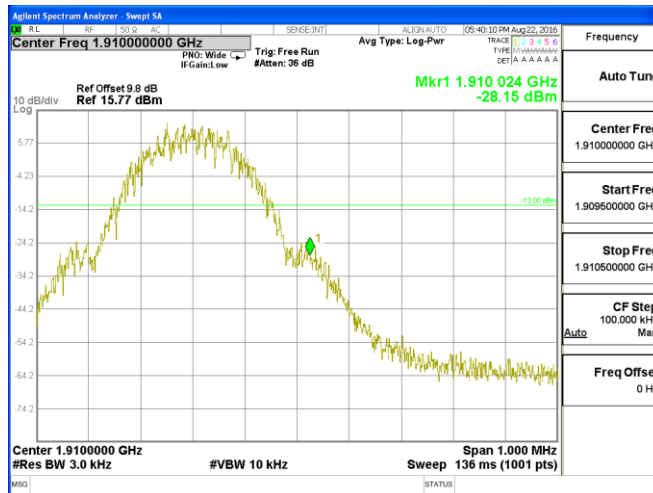

Note: Offset=Cable loss(9.5)+10log(3.2/3)=9.5+0.3=9.8 dB



### GPRS 1900 Lowest Band Edge

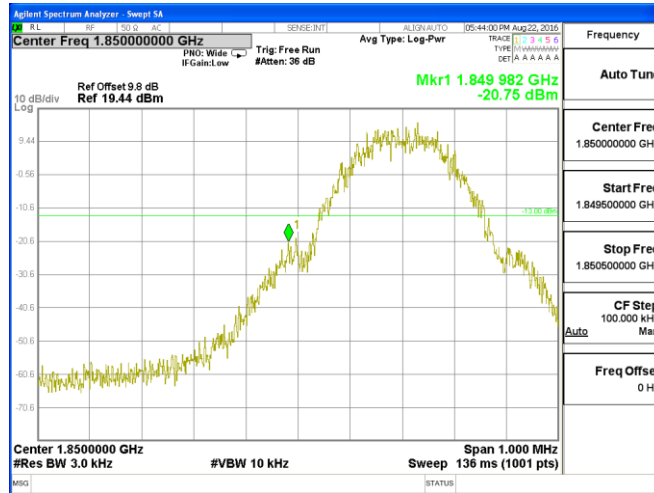

Note: Offset=Cable loss(9.5)+10log(3.2/3)=9.5+0.3=9.8 dB

### Highest Band Edge

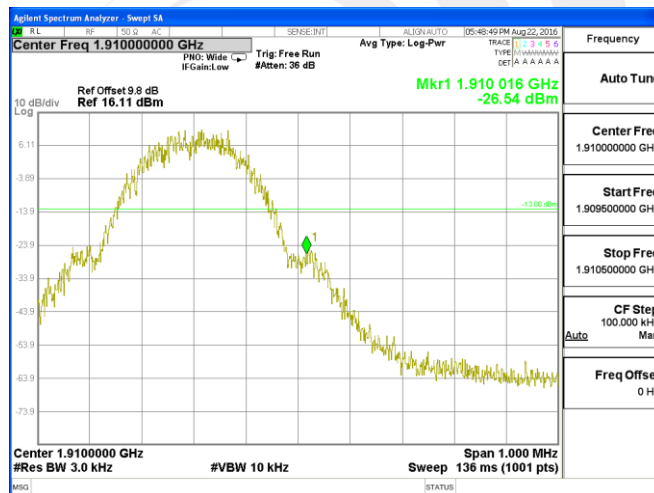

Note: Offset=Cable loss(9.5)+10log(3.2/3)=9.5+0.3=9.8 dB



### WCDMA Band VRMC 12.2Kbps

#### Lowest Band Edge

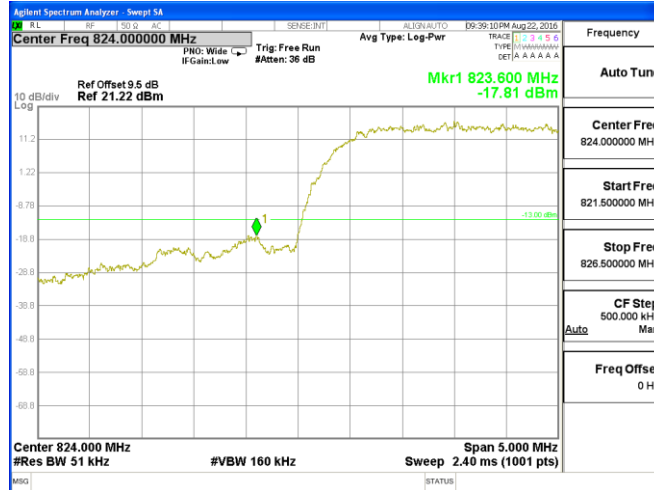

Note: Offset=Cable loss(9.405)+10log(51/41)=9.405+0.095=9.5 dB

#### Highest Band Edge

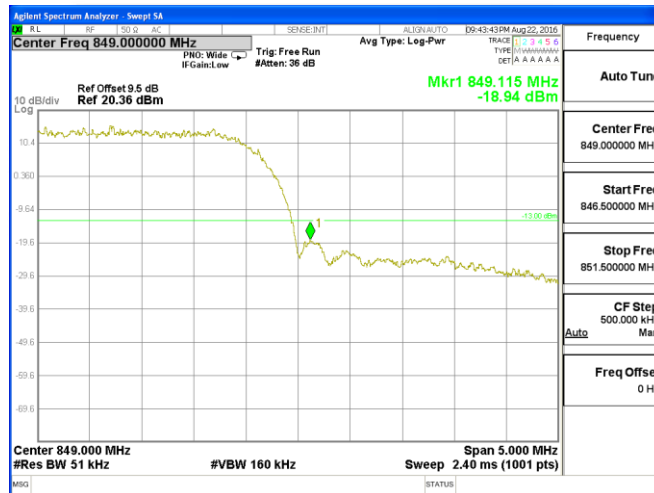

Note: Offset=Cable loss(9.405)+10log(51/41)=9.405+0.095=9.5 dB



### WCDMA Band IIRMC 12.2Kbps

#### Lowest Band Edge

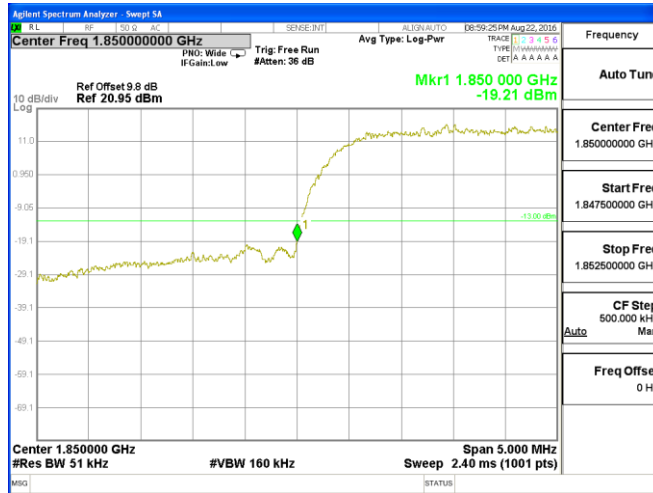

Note: Offset=Cable loss(9.705)+10log(51/41)=9.705+0.095=9.8 dB

#### Highest Band Edge

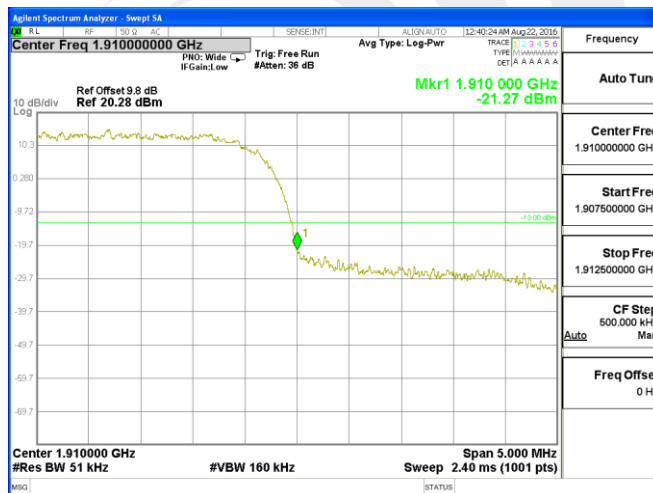

Note: Offset=Cable loss(9.705)+10log(51/41)=9.705+0.095=9.8 dB



A8 FIELD STRENGTH OF SPURIOUS RADIATION MEASUREMENT  
 GSM 850: (30-9000)MHz

GSM 850: (30-9000)MHz							
The Worst Test Results Channel 128/824.2 MHz							
Frequency(MHz)	S G.Lev (dBm)	Ant(dBi)	Loss	PMea	Limit	Margin	Polarity
				(dBm)	(dBm)	(dBm)	
1648.44	-40.99	9.40	4.75	-36.34	-13.00	-23.34	H
2472.29	-40.59	10.60	8.39	-38.38	-13.00	-25.38	H
3296.60	-30.93	12.00	11.79	-30.72	-13.00	-17.72	H
1648.42	-44.13	9.40	4.75	-39.48	-13.00	-26.48	V
2472.46	-45.09	10.60	8.39	-42.88	-13.00	-29.88	V
3296.91	-42.68	12.00	11.79	-42.47	-13.00	-29.47	V
The Worst Test Results Channel 190/836.6 MHz							
Frequency(MHz)	S G.Lev (dBm)	Ant(dBi)	Loss	PMea	Limit	Margin	Polarity
				(dBm)	(dBm)	(dBm)	
1673.17	-41.30	9.50	4.76	-36.56	-13.00	-23.56	H
2509.65	-40.05	10.70	8.40	-37.75	-13.00	-24.75	H
3346.34	-31.34	12.20	11.80	-30.94	-13.00	-17.94	H
1672.99	-43.21	9.40	4.75	-38.56	-13.00	-25.56	V
2509.64	-44.40	10.60	8.39	-42.19	-13.00	-29.19	V
3346.43	-43.06	12.20	11.82	-42.68	-13.00	-29.68	V
The Worst Test Results Channel 251/848.8 MHz							
Frequency(MHz)	S G.Lev (dBm)	Ant(dBi)	Loss	PMea	Limit	Margin	Polarity
				(dBm)	(dBm)	(dBm)	
1697.23	-40.19	9.60	4.77	-35.36	-13.00	-22.36	H
2546.52	-40.53	10.80	8.50	-38.23	-13.00	-25.23	H
3395.08	-32.26	12.50	11.90	-31.66	-13.00	-18.66	H
1697.64	-43.31	9.60	4.77	-38.48	-13.00	-25.48	V
2546.20	-45.15	10.80	8.50	-42.85	-13.00	-29.85	V
3394.86	-43.12	12.50	11.90	-42.52	-13.00	-29.52	V

**Note:** (1)Below 30MHz no Spurious found is the worst condition.  
 (2)Above 3.5GHz amplitude of spurious emissions which are attenuated by more than 20dB below the permissible value has.





GPRS 850: (30-9000)MHz

GPRS 850: (30-9000)MHz							
The Worst Test Results Channel 128/824.2 MHz							
Frequency(MHz)	S G.Lev (dBm)	Ant(dBi)	Loss	PMea	Limit	Margin	Polarity
				(dBm)	(dBm)	(dBm)	
1648.05	-40.21	9.40	4.75	-35.56	-13.00	-22.56	H
2472.54	-39.39	10.60	8.39	-37.18	-13.00	-24.18	H
3296.85	-31.99	12.00	11.79	-31.78	-13.00	-18.78	H
1648.24	-43.98	9.40	4.75	-39.33	-13.00	-26.33	V
2472.30	-45.27	10.60	8.39	-43.06	-13.00	-30.06	V
3296.63	-42.79	12.00	11.79	-42.58	-13.00	-29.58	V
The Worst Test Results Channel 190/836.6 MHz							
Frequency(MHz)	S G.Lev (dBm)	Ant(dBi)	Loss	PMea	Limit	Margin	Polarity
				(dBm)	(dBm)	(dBm)	
1672.86	-40.93	9.50	4.76	-36.19	-13.00	-23.19	H
2509.72	-40.50	10.70	8.40	-38.20	-13.00	-25.20	H
3346.34	-30.94	12.20	11.80	-30.54	-13.00	-17.54	H
1673.14	-44.15	9.40	4.75	-39.50	-13.00	-26.50	V
2509.87	-44.32	10.60	8.39	-42.11	-13.00	-29.11	V
3346.01	-42.54	12.20	11.82	-42.16	-13.00	-29.16	V
The Worst Test Results Channel 251/848.8 MHz							
Frequency(MHz)	S G.Lev (dBm)	Ant(dBi)	Loss	PMea	Limit	Margin	Polarity
				(dBm)	(dBm)	(dBm)	
1697.31	-41.39	9.60	4.77	-36.56	-13.00	-23.56	H
2546.17	-39.60	10.80	8.50	-37.30	-13.00	-24.30	H
3395.22	-32.08	12.50	11.90	-31.48	-13.00	-18.48	H
1697.19	-44.17	9.60	4.77	-39.34	-13.00	-26.34	V
2546.55	-43.96	10.80	8.50	-41.66	-13.00	-28.66	V
3395.03	-43.90	12.50	11.90	-43.30	-13.00	-30.30	V

**Note:** (1)Below 30MHz no Spurious found is the worst condition.  
 (2)Above 3.5GHz amplitude of spurious emissions which are attenuated by more than 20dB below the permissible value has.



PCS 1900: (30-20000)MHz

DCS 1900: (30-20000)MHz							
The Worst Test Results for Channel 512/1850.2MHz							
Frequency(MHz)	S G.Lev (dBm)	Ant(dBi)	Loss	PMea	Limit	Margin	Polarity
				(dBm)	(dBm)	(dBm)	
3700.48	-34.53	12.60	12.93	-34.86	-13.00	-21.86	H
5550.48	-35.05	13.10	17.11	-39.06	-13.00	-26.06	H
7400.75	-32.51	11.50	22.20	-43.21	-13.00	-30.21	H
3700.51	-35.81	12.60	12.93	-36.14	-13.00	-23.14	V
5550.42	-34.67	13.10	17.11	-38.68	-13.00	-25.68	V
7400.87	-32.41	11.50	22.20	-43.11	-13.00	-30.11	V
The Worst Test Results for Channel 661/1880.0MHz							
Frequency(MHz)	S G.Lev (dBm)	Ant(dBi)	Loss	PMea	Limit	Margin	Polarity
				(dBm)	(dBm)	(dBm)	
3760.21	-34.69	12.60	12.93	-35.02	-13.00	-22.02	H
5640.00	-34.89	13.10	17.11	-38.90	-13.00	-25.90	H
7519.85	-33.50	11.50	22.20	-44.20	-13.00	-31.20	H
3759.91	-35.44	12.60	12.93	-35.77	-13.00	-22.77	V
5640.06	-34.57	13.10	17.11	-38.58	-13.00	-25.58	V
7520.17	-32.21	11.50	22.20	-42.91	-13.00	-29.91	V
The Worst Test Results for Channel 810/1909.8MHz							
Frequency(MHz)	S G.Lev (dBm)	Ant(dBi)	Loss	PMea	Limit	Margin	Polarity
				(dBm)	(dBm)	(dBm)	
3819.44	-34.38	12.60	12.93	-34.71	-13.00	-21.71	H
5729.08	-35.44	13.10	17.11	-39.45	-13.00	-26.45	H
7639.05	-32.60	11.50	22.20	-43.30	-13.00	-30.30	H
3819.52	-35.30	12.60	12.93	-35.63	-13.00	-22.63	V
5729.33	-35.10	13.10	17.11	-39.11	-13.00	-26.11	V
7638.98	-33.00	11.50	22.20	-43.70	-13.00	-30.70	V

**Note:** (1)Below 30MHz no Spurious found is the worst condition.  
 (2)Above 8GHz amplitude of spurious emissions which are attenuated by more than 20dB below the permissible value has.



GPRS 1900: (30-20000)MHz

GPRS1900: (30-20000)MHz							
The Worst Test Results for Channel 512/1850.2MHz							
Frequency(MHz)	S G.Lev (dBm)	Ant(dBi)	Loss	PMea	Limit	Margin	Polarity
				(dBm)	(dBm)	(dBm)	
3700.23	-34.04	12.60	12.93	-34.37	-13.00	-21.37	H
5550.39	-34.72	13.10	17.11	-38.73	-13.00	-25.73	H
7400.68	-33.18	11.50	22.20	-43.88	-13.00	-30.88	H
3700.51	-35.70	12.60	12.93	-36.03	-13.00	-23.03	V
5550.37	-33.82	13.10	17.11	-37.83	-13.00	-24.83	V
7400.56	-33.16	11.50	22.20	-43.86	-13.00	-30.86	V
The Worst Test Results for Channel 661/1880.0MHz							
Frequency(MHz)	S G.Lev (dBm)	Ant(dBi)	Loss	PMea	Limit	Margin	Polarity
				(dBm)	(dBm)	(dBm)	
3760.17	-33.70	12.60	12.93	-34.03	-13.00	-21.03	H
5640.11	-35.41	13.10	17.11	-39.42	-13.00	-26.42	H
7520.13	-32.63	11.50	22.20	-43.33	-13.00	-30.33	H
3760.08	-35.91	12.60	12.93	-36.24	-13.00	-23.24	V
5640.17	-34.91	13.10	17.11	-38.92	-13.00	-25.92	V
7519.89	-33.08	11.50	22.20	-43.78	-13.00	-30.78	V
The Worst Test Results for Channel 810/1909.8MHz							
Frequency(MHz)	S G.Lev (dBm)	Ant(dBi)	Loss	PMea	Limit	Margin	Polarity
				(dBm)	(dBm)	(dBm)	
3819.67	-34.82	12.60	12.93	-35.15	-13.00	-22.15	H
5729.04	-34.63	13.10	17.11	-38.64	-13.00	-25.64	H
7638.85	-33.57	11.50	22.20	-44.27	-13.00	-31.27	H
3819.51	-34.68	12.60	12.93	-35.01	-13.00	-22.01	V
5729.14	-34.13	13.10	17.11	-38.14	-13.00	-25.14	V
7639.15	-32.43	11.50	22.20	-43.13	-13.00	-30.13	V

**Note:** (1)Below 30MHz no Spurious found is the worst condition.  
 (2)Above 8GHz amplitude of spurious emissions which are attenuated by more than 20dB below the permissible value has.



UMTS band V(30-9000)MHz

WCDMA Band V: (30-9000)MHz							
The most testresults channel 4132/826.4MHz							
Frequency(MHz)	S G.Lev (dBm)	Ant(dBi)	Loss	PMea	Limit	Margin	Polarity
				(dBm)	( dBm )	(dBm)	
1652.20	-41.55	9.40	4.75	-36.90	-13.00	-23.90	H
2479.35	-40.39	10.60	8.39	-38.18	-13.00	-25.18	H
3305.70	-32.17	12.00	11.79	-31.96	-13.00	-18.96	H
1652.48	-44.43	9.40	4.75	-39.78	-13.00	-26.78	V
2479.56	-45.24	10.60	8.39	-43.03	-13.00	-30.03	V
3305.56	-42.85	12.00	11.79	-42.64	-13.00	-29.64	V
The Worst Test Results Channel 4183/836.6MHz							
Frequency(MHz)	S G.Lev (dBm)	Ant(dBi)	Loss	PMea	Limit	Margin	Polarity
				(dBm)	( dBm )	(dBm)	
1673.13	-40.68	9.50	4.76	-35.94	-13.00	-22.94	H
2509.48	-40.07	10.70	8.40	-37.77	-13.00	-24.77	H
3346.39	-31.15	12.20	11.80	-30.75	-13.00	-17.75	H
1673.05	-43.84	9.40	4.75	-39.19	-13.00	-26.19	V
2509.53	-44.78	10.60	8.39	-42.57	-13.00	-29.57	V
3345.96	-43.95	12.20	11.82	-43.57	-13.00	-30.57	V
The Worst Test Results Channel 4233/846.6MHz							
Frequency(MHz)	S G.Lev (dBm)	Ant(dBi)	Loss	PMea	Limit	Margin	Polarity
				(dBm)	( dBm )	(dBm)	
1693.52	-41.53	9.60	4.77	-36.70	-13.00	-23.70	H
2539.19	-40.38	10.80	8.50	-38.08	-13.00	-25.08	H
3385.95	-31.64	12.50	11.90	-31.04	-13.00	-18.04	H
1693.66	-43.56	9.60	4.77	-38.73	-13.00	-25.73	V
2539.24	-45.19	10.80	8.50	-42.89	-13.00	-29.89	V
3385.87	-43.24	12.50	11.90	-42.64	-13.00	-29.64	V

**Note:** (1)Below 30MHz no Spurious found is the worst condition.  
 (2)Above 3GHz amplitude of spurious emissions which are attenuated by more than 20dB below the permissible value has.



UMTS band II(30-20000)MHz

WCDMA Band II: (30-20000)MHz							
The Worst Test Results for Channel 9262/1852.4MHz							
Frequency(MHz)	S G.Lev (dBm)	Ant(dBi)	Loss	PMea	Limit	Margin	Polarity
				(dBm)	( dBm )	(dBm)	
3704.34	-34.78	12.60	12.93	-35.11	-13.00	-22.11	H
5557.20	-34.57	13.10	17.11	-38.58	-13.00	-25.58	H
7409.58	-32.21	11.50	22.20	-42.91	-13.00	-29.91	H
3704.14	-35.07	12.60	12.93	-35.40	-13.00	-22.40	V
5557.51	-34.56	13.10	17.11	-38.57	-13.00	-25.57	V
7409.78	-32.53	11.50	22.20	-43.23	-13.00	-30.23	V
The Worst Test Results for Channel 9400/1880MHz							
Frequency(MHz)	S G.Lev (dBm)	Ant(dBi)	Loss	PMea	Limit	Margin	Polarity
				(dBm)	( dBm )	(dBm)	
3760.10	-34.91	12.60	12.93	-35.24	-13.00	-22.24	H
5639.93	-34.14	13.10	17.11	-38.15	-13.00	-25.15	H
7520.06	-32.55	11.50	22.20	-43.25	-13.00	-30.25	H
3760.02	-35.84	12.60	12.93	-36.17	-13.00	-23.17	V
5640.23	-33.89	13.10	17.11	-37.90	-13.00	-24.90	V
7519.88	-32.16	11.50	22.20	-42.86	-13.00	-29.86	V
The Worst Test Results for Channel 9538/1907.6MHz							
Frequency(MHz)	S G.Lev (dBm)	Ant(dBi)	Loss	PMea	Limit	Margin	Polarity
				(dBm)	( dBm )	(dBm)	
3815.47	-33.93	12.60	12.93	-34.26	-13.00	-21.26	H
5722.12	-34.93	13.10	17.11	-38.94	-13.00	-25.94	H
7630.15	-32.18	11.50	22.20	-42.88	-13.00	-29.88	H
3815.48	-35.12	12.60	12.93	-35.45	-13.00	-22.45	V
5722.41	-34.00	13.10	17.11	-38.01	-13.00	-25.01	V
7630.04	-32.68	11.50	22.20	-43.38	-13.00	-30.38	V

**Note:** (1)Below 30MHz no Spurious found is the worst condition.  
 (2)Above 6GHz amplitude of spurious emissions which are attenuated by more than 20dB below the permissible value has.

APPENDIX B PHOTOS OF TEST SETUP

RADIATED SPURIOUS EMISSION



※※※※END OF THE REPORT※※※※