



FCC PART 15B, CLASS B TEST REPORT

For

XTR S.A.C.

Av. Camino Real 1225 Of 201-A San Isidro, Lima, Peru

FCC ID: 2AGAK-FX182

Report Type: Original Report	Product Type: Mobile Phone
Report Number: RGMA190505001-00C	
Report Date: 2019-06-03	
Reviewed By: RF Engineer	Nancy Wang 
Prepared By: Bay Area Compliance Laboratories Corp. (Shenzhen) 6/F., West Wing, Third Phase of Wanli Industrial Building, Shihua Road, Futian Free Trade Zone, Shenzhen, Guangdong, China Tel: +86-755-33320018 Fax: +86-755-33320008 www.baclcorp.com.cn	

Note: This report must not be used by the customer to claim product certification, approval, or endorsement by A2LA* or any agency of the Federal Government. * This report may contain data that are not covered by the A2LA accreditation and are marked with an asterisk “*”.

The information marked # is provided by the applicant, the laboratory is not responsible for its authenticity.

TABLE OF CONTENTS

GENERAL INFORMATION	3
PRODUCT DESCRIPTION FOR EQUIPMENT UNDER TEST (EUT).....	3
OBJECTIVE	3
RELATED SUBMITTAL(S)/GRANT(S).....	3
TEST METHODOLOGY	3
MEASUREMENT UNCERTAINTY.....	4
TEST FACILITY	4
SYSTEM TEST CONFIGURATION	5
DESCRIPTION OF TEST CONFIGURATION	5
EUT EXERCISE SOFTWARE	5
SPECIAL ACCESSORIES.....	5
EQUIPMENT MODIFICATIONS	5
SUPPORT EQUIPMENT LIST AND DETAILS	5
EXTERNAL I/O CABLE.....	6
BLOCK DIAGRAM OF TEST SETUP	6
SUMMARY OF TEST RESULTS	7
TEST EQUIPMENT LIST	8
FCC §15.107 – AC LINE CONDUCTED EMISSIONS	9
APPLICABLE STANDARD	9
EUT SETUP	9
EMI TEST RECEIVER SETUP.....	9
TEST PROCEDURE	9
CORRECTED FACTOR & MARGIN CALCULATION	10
TEST RESULTS SUMMARY	10
TEST DATA	10
FCC §15.109 - RADIATED SPURIOUS EMISSIONS	13
APPLICABLE STANDARD	13
EUT SETUP	13
EMI TEST RECEIVER SETUP.....	14
TEST PROCEDURE	14
CORRECTED AMPLITUDE & MARGIN CALCULATION	14
TEST RESULTS SUMMARY	14
TEST DATA	15

GENERAL INFORMATION

Product Description for Equipment under Test (EUT)

Product	Mobile Phone
Model	FX182
Voltage Range	Powered: DC 3.7V by internal rechargeable Li-ion battery Recharged: DC 5.0V by adapter
Highest operating frequency	2480 MHz
Date of Test	2019/05/07~2019/05/21
Sample serial number	G21831905000001
Received date	2019/05/05
Sample/EUT Status	Good condition
Adapter information	Model: FX182 Input: AC 100-240V, 50/60Hz, 150mA Output: DC 5.0V, 350mA

Objective

This test report is prepared on behalf of *XTR S.A.C.* in accordance with Part 2-Subpart J, Part 15-Subparts A, B of the Federal Communication Commissions rules.

The objective of the manufacturer is to determine the compliance of the EUT with FCC Part 15 B.

Related Submittal(s)/Grant(s)

FCC Part 15.247 DSS and Part 22H&24E PCE submissions with FCC ID: 2AGAK-FX182.

Test Methodology

All measurements contained in this report were conducted with ANSI C63.4-2014, American National Standard for Methods of Measurement of Radio-Noise Emissions from Low-Voltage Electrical and Electronic Equipment in the range of 9 kHz to 40 GHz.

All emissions measurement was performed at Bay Area Compliance Laboratories Corp. (Shenzhen). The radiated testing was performed at an antenna-to-EUT distance of 3 meters.

Measurement Uncertainty

All measurements involve certain levels of uncertainties, especially in field of EMC. The factors contributing to uncertainties are spectrum analyzer, cable loss, antenna factor calibration, antenna directivity, antenna factor variation with height, antenna phase center variation, antenna factor frequency interpolation, measurement distance variation, site imperfections, mismatch (average), and system repeatability.

Based on CISPR 16-4-2:2011, the expanded combined standard uncertainty of test at Bay Area Compliance Laboratories Corp. (Shenzhen) is shown as below. And the uncertainty will be taken into consideration for the test data recorded in the report

Parameter		uncertainty
Conducted Emissions		±1.95dB
Radiated Emissions	Below 1GHz	±4.75dB
	Above 1GHz	±4.88dB

Note: Otherwise required by the applicant or Product Regulations, Decision Rule in this report did not consider the uncertainty.

Test Facility

The Test site used by Bay Area Compliance Laboratories Corp. (Shenzhen) to collect test data is located on the 6/F., West Wing, Third Phase of Wanli Industrial Building, Shihua Road, Futian Free Trade Zone, Shenzhen, Guangdong, China.

The test site has been approved by the FCC under the KDB 974614 D01 and is listed in the FCC Public Access Link (PAL) database, FCC Registration No.: 342867, the FCC Designation No.: CN1221.

The test site has been registered with ISED Canada under ISED Canada Registration Number 3062B.

SYSTEM TEST CONFIGURATION

Description of Test Configuration

The system was configured for testing in a manufacturer testing fashion.

EUT operation mode: Downloading (data transfer with computer)

EUT Exercise Software

“BurnIn test v5.3” exercise software was used.

Special Accessories

No special accessory.

Equipment Modifications

No modification was made to the EUT tested.

Support Equipment List and Details

Manufacturer	Description	Model	Serial Number
DELL	Host PC	DCSCSF	127BP2X
TCL	Monitor	TFT1560PS	ALA560806C160409
Microsoft	Keyboard	1406	0200706128743
DELL	Mouse	MOC5UO	G1900NKD
SAST	Modem	AEM-2100	0293
Kingston	Micro SD card	1 GB	201
LISTED	Modem Adapter	TYP60-1207000Z	326703

External I/O Cable

Cable Description	Length (m)	From/Port	To
Un-Shielding Detachable USB Cable	1.5	Host PC	Mouse
Shielding Detachable Serial Cable	1.2	Host PC	Modem
Shielding Detachable K/B Cable With Magnet Ring	1.5	Host PC	Keyboard
Shielding Detachable VGA Cable	1.5	Host PC	Monitor
Un-Shielding Detachable USB Cable With Ferrite Core	1.0	EUT	Host PC
Un-shielding Detachable Earphone Cable	1.2	EUT	Earphone

Block Diagram of Test Setup

For conducted emission:

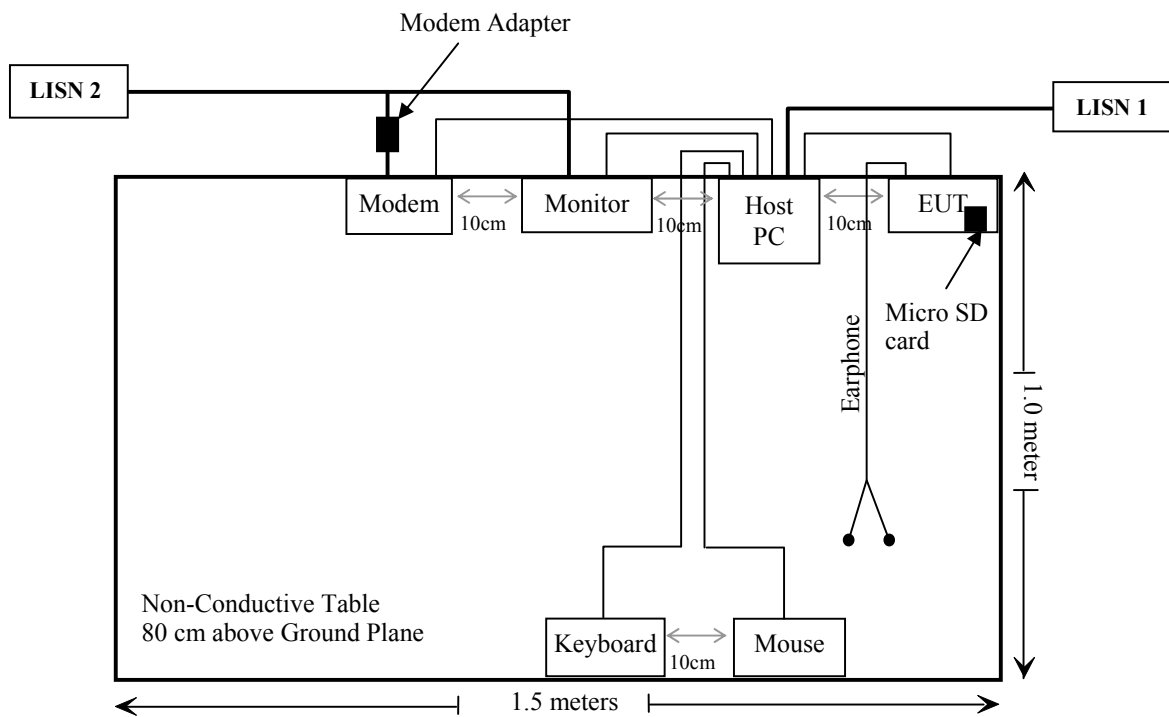

SUMMARY OF TEST RESULTS

FCC Rules	Description of Test	Results
§15.107	AC Line Conducted Emissions	Compliance
§15.109	Radiated Spurious Emissions	Compliance

TEST EQUIPMENT LIST

Manufacturer	Description	Model	Serial Number	Calibration Date	Calibration Due Date
AC Line Conducted Emission Test					
Rohde & Schwarz	EMI Test Receiver	ESCS30	100176	2018-07-11	2019-07-11
Rohde & Schwarz	LISN	ENV216	3560.6650.12-101613-Yb	2019-01-25	2020-01-25
Rohde & Schwarz	Transient Limiter	ESH3Z2	DE25985	2019-03-02	2020-03-02
Rohde & Schwarz	CE Test software	EMC 32	V8.53.0	NCR	NCR
Unknown	Conducted Emission Cable	78652	UF A210B-1-0720-504504	2018-11-12	2019-11-12
Radiated Emission Test					
A.H. System	Horn Antenna	SAS-200/571	135	2018-09-01	2021-08-31
Rohde & Schwarz	Signal Analyzer	FSEM	845987/005	2018-06-23	2019-06-23
Rohde & Schwarz	Signal Analyzer	FSV40	101473	2019-01-09	2020-01-08
Sunol Sciences	Broadband Antenna	JB1	A040904-1	2017-12-22	2020-12-21
COM-POWER	Pre-amplifier	PA-122	181919	2018-11-12	2019-11-12
Sonoma Instrument	Amplifier	310N	186238	2018-11-12	2019-11-12
Rohde & Schwarz	EMI Test Receiver	ESR	1316.3003K03-101746-zn	2018-07-11	2019-07-11
Ducommun technologies	RF Cable	UFA147A-2362-100100	MFR64639231029-003	2018-11-12	2019-11-12
Ducommun technologies	RF Cable	104PEA	218124002	2018-11-12	2019-11-12
Ducommun Technologies	RF Cable	RG-214	1	2018-11-12	2019-11-12
Ducommun Technologies	RF Cable	RG-214	2	2018-11-12	2019-11-12
Heatsink Required	Amplifier	QLW-18405536-J0	15964001002	2018-11-12	2019-11-12
Rohde & Schwarz	Auto test software	EMC 32	V9.10	NCR	NCR

* **Statement of Traceability:** Bay Area Compliance Laboratories Corp. (Shenzhen) attests that all calibrations have been performed in accordance to requirements that traceable to National Primary Standards and International System of Units (SI).

FCC §15.107 – AC LINE CONDUCTED EMISSIONS

Applicable Standard

According to FCC §15.107

EUT Setup

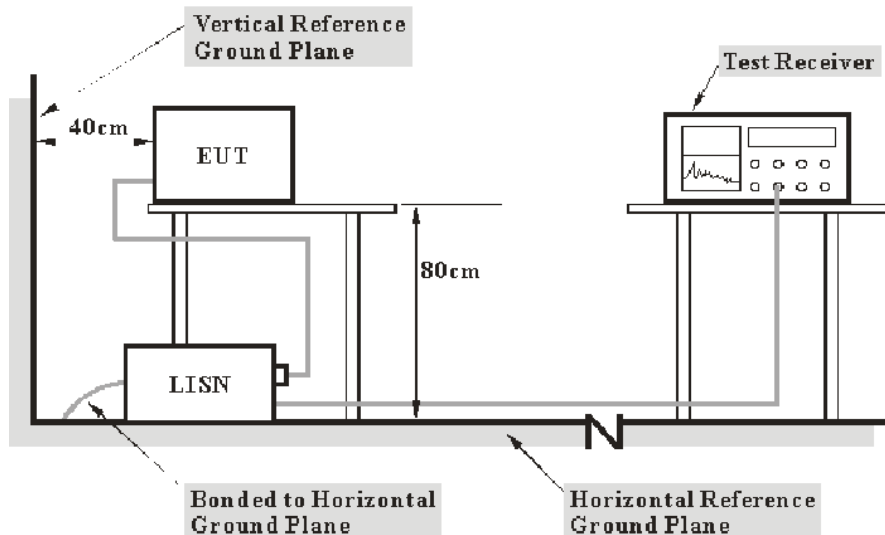

- Note: 1. Support units were connected to second LISN.
 2. Both of LISNs (AMN) 80 cm from EUT and at the least 80 cm from other units and other metal planes support units.

The measurement procedure of EUT setup is according with per ANSI C63.4-2014. The related limit was specified in FCC Part 15.107 Class B.

The spacing between the peripherals was 10 cm.

EMI Test Receiver Setup

The EMI test receiver was set to investigate the spectrum from 150 kHz to 30 MHz.

During the conducted emission test, the EMI test receiver was set with the following configurations:

Frequency Range	IF B/W
150 kHz – 30 MHz	9 kHz

Test Procedure

During the conducted emission test, the host PC was connected to the first LISN and the other relevant equipments were connected to the second LISN.

Maximizing procedure was performed on the six (6) highest emissions of the EUT.

All data was recorded in the Quasi-peak and average detection mode.

Corrected Factor & Margin Calculation

The Corrected factor is calculated by adding LISN/ISN VDF (Voltage Division Factor), Cable Loss and Transient Limiter Attenuation. The basic equation is as follows:

$$\text{Correction Factor} = \text{LISN VDF} + \text{Cable Loss} + \text{Transient Limiter Attenuation}$$

The “**Margin**” column of the following data tables indicates the degree of compliance with the applicable limit. For example, a margin of 7 dB means the emission is 7 dB below the limit. The equation for margin calculation is as follows:

$$\text{Margin} = \text{Limit} - \text{Corrected Amplitude}$$

Test Results Summary

According to the recorded data in following table, the EUT complied with the FCC Part 15.107,

Refer to CISPR16-4-2:2011 and CISPR 16-4-1:2009, the measured level is in compliance with the limit if

$$L_m + U_{(L_m)} \leq L_{\text{lim}} + U_{\text{cispr}}$$

In BA CL., $U_{(L_m)}$ is less than U_{cispr} , if L_m is less than L_{lim} , it implies that the EUT complies with the limit.

Test Data

Environmental Conditions

Temperature:	25 °C
Relative Humidity:	50 %
ATM Pressure:	101.0 kPa

The testing was performed by Haiguo Li on 2019-05-07.

EUT Operation Mode: Downloading

AC 120V/60 Hz, Line

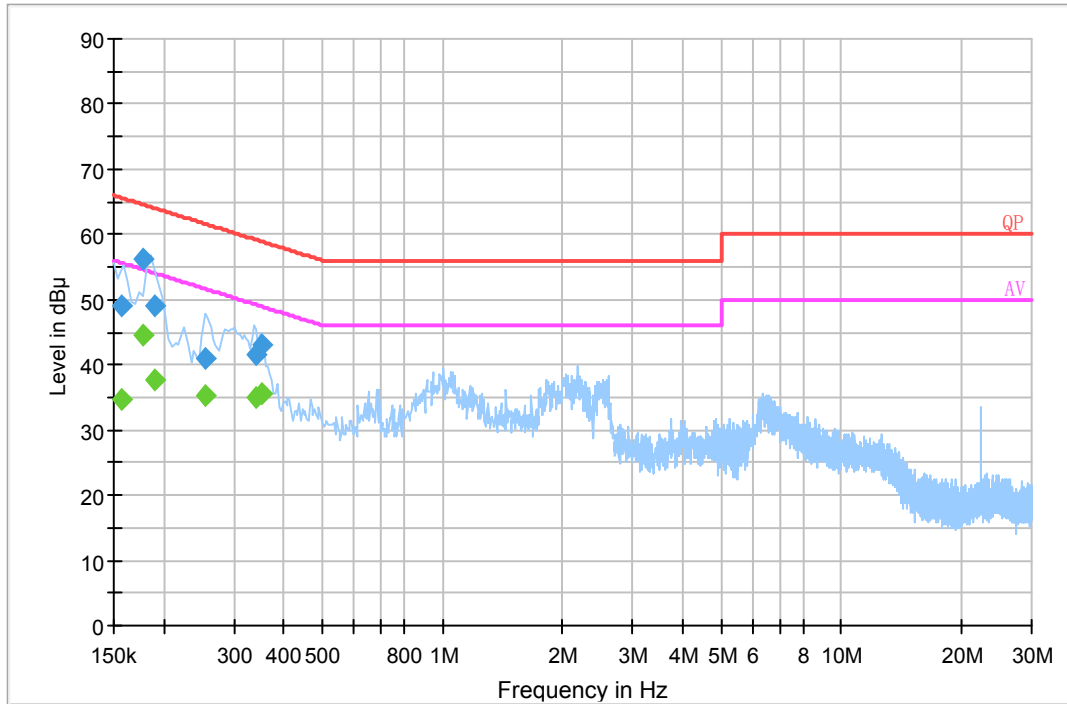

Frequency (MHz)	Corrected Amplitude (dBµV)	Correction Factor (dB)	Limit (dBµV)	Margin (dB)	Detector (PK/Ave./QP)
0.157500	49.0	19.8	65.6	16.6	QP
0.177500	56.2	19.9	64.6	8.4	QP
0.190501	49.1	19.8	64.0	14.9	QP
0.253500	41.0	19.8	61.6	20.6	QP
0.340930	41.6	19.9	59.2	17.6	QP
0.352690	43.0	19.9	58.9	15.9	QP
0.157500	34.6	19.8	55.6	21.0	Ave.
0.177500	44.6	19.9	54.6	10.0	Ave.
0.190501	37.7	19.8	54.0	16.3	Ave.
0.253500	35.3	19.8	51.6	16.3	Ave.
0.340930	34.9	19.9	49.2	14.3	Ave.
0.352690	35.6	19.9	48.9	13.3	Ave.

AC 120V/60 Hz, Neutral

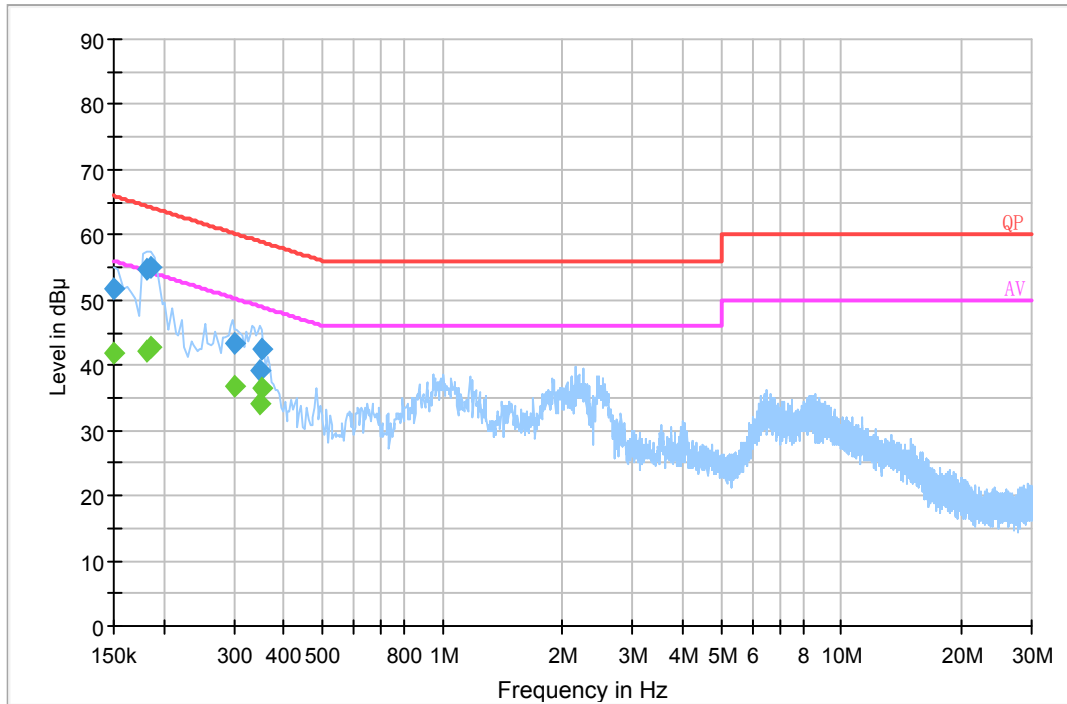

Frequency (MHz)	Corrected Amplitude (dBμV)	Correction Factor (dB)	Limit (dBμV)	Margin (dB)	Detector (PK/Ave./QP)
0.150000	51.7	19.8	66.0	14.3	QP
0.181500	54.7	19.8	64.4	9.7	QP
0.185500	55.0	19.8	64.2	9.2	QP
0.301500	43.4	19.7	60.2	16.8	QP
0.348690	39.1	19.9	59.0	19.9	QP
0.352750	42.5	19.9	58.9	16.4	QP
0.150000	41.8	19.8	56.0	14.2	Ave.
0.181500	42.2	19.8	54.4	12.2	Ave.
0.185500	42.7	19.8	54.2	11.5	Ave.
0.301500	36.8	19.7	50.2	13.4	Ave.
0.348690	34.0	19.9	49.0	15.0	Ave.
0.352750	36.4	19.9	48.9	12.5	Ave.

Note:

- 1) Correction Factor = LISN VDF (Voltage Division Factor) + Cable Loss + Transient Limiter Attenuation
- 2) Corrected Amplitude = Reading + Correction Factor
- 3) Margin = Limit - Corrected Amplitude

FCC §15.109 - RADIATED SPURIOUS EMISSIONS

Applicable Standard

FCC §15.109

EUT Setup

Below 1GHz:

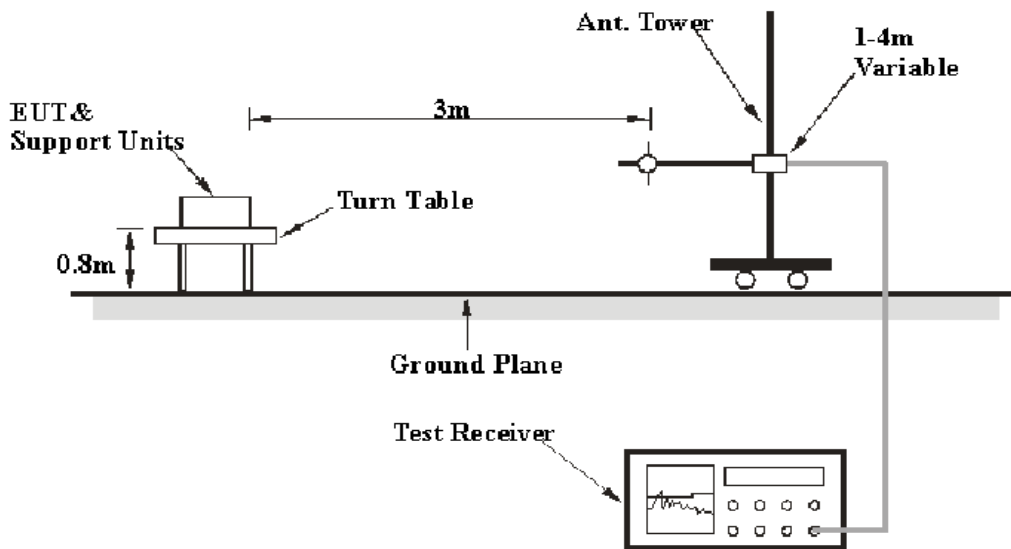

Above 1GHz:

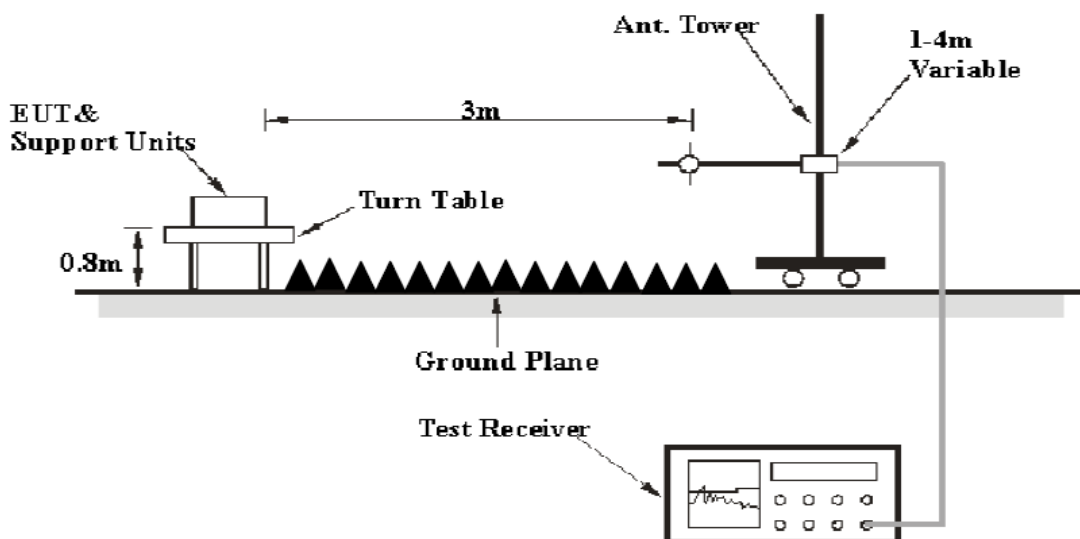

The radiated emission tests were performed in the 3 meters chamber test site, using the setup accordance with the ANSI C63.4-2014. The specification used was the FCC Part 15.109 Class B limits.

The external I/O cables were draped along the test table and formed a bundle 30 to 40 cm long in the middle.

The spacing between the peripherals was 10 cm.

EMI Test Receiver Setup

The system was investigated from 30 MHz to 12.5 GHz.

During the radiated emission test, the EMI test receiver was set with the following configurations:

Frequency Range	RBW	Video B/W	IF B/W	Measurement
30 MHz – 1000 MHz	100 kHz	300 kHz	120 kHz	QP
Above 1 GHz	1MHz	3 MHz	/	PK
	1MHz	10 Hz	/	Ave.

Test Procedure

Maximizing procedure was performed on the highest emissions to ensure that the EUT complied with all installation combinations.

All data was recorded in the Quasi-peak detector mode from 30 MHz to 1 GHz and PK and average detector modes for frequencies above 1 GHz.

Corrected Amplitude & Margin Calculation

The Corrected Amplitude is calculated by adding the Antenna Factor and Cable Loss, and subtracting the Amplifier Gain from the Meter Reading. The basic equation is as follows:

$$\text{Corrected Amplitude} = \text{Meter Reading} + \text{Antenna Factor} + \text{Cable Loss} - \text{Amplifier Gain}$$

The “**Margin**” column of the following data tables indicates the degree of compliance with the applicable limit. For example, a margin of 7 dB means the emission is 7 dB below the limit. The equation for margin calculation is as follows:

$$\text{Margin} = \text{Limit} - \text{Corrected Amplitude}$$

Test Results Summary

According to the data in the following table, the EUT complied with the FCC §15.109 Class B,

Refer to CISPR16-4-2:2011 and CISPR 16-4-1:2009, the measured level is in compliance with the limit if

$$L_m + U_{(L_m)} \leq L_{\text{lim}} + U_{\text{cispr}}$$

In BACL, $U_{(L_m)}$ is less than U_{cispr} , if L_m is less than L_{lim} , it implies that the EUT complies with the limit.

Test Data

Environmental Conditions

Temperature:	23~25 °C
Relative Humidity:	51~52 %
ATM Pressure:	101.0 kPa

The testing was performed by Andy Yu on 2019-05-21 and by Curry Xiang on 2019-05-18.

EUT Operation Mode: Downloading

30 MHz~1 GHz:

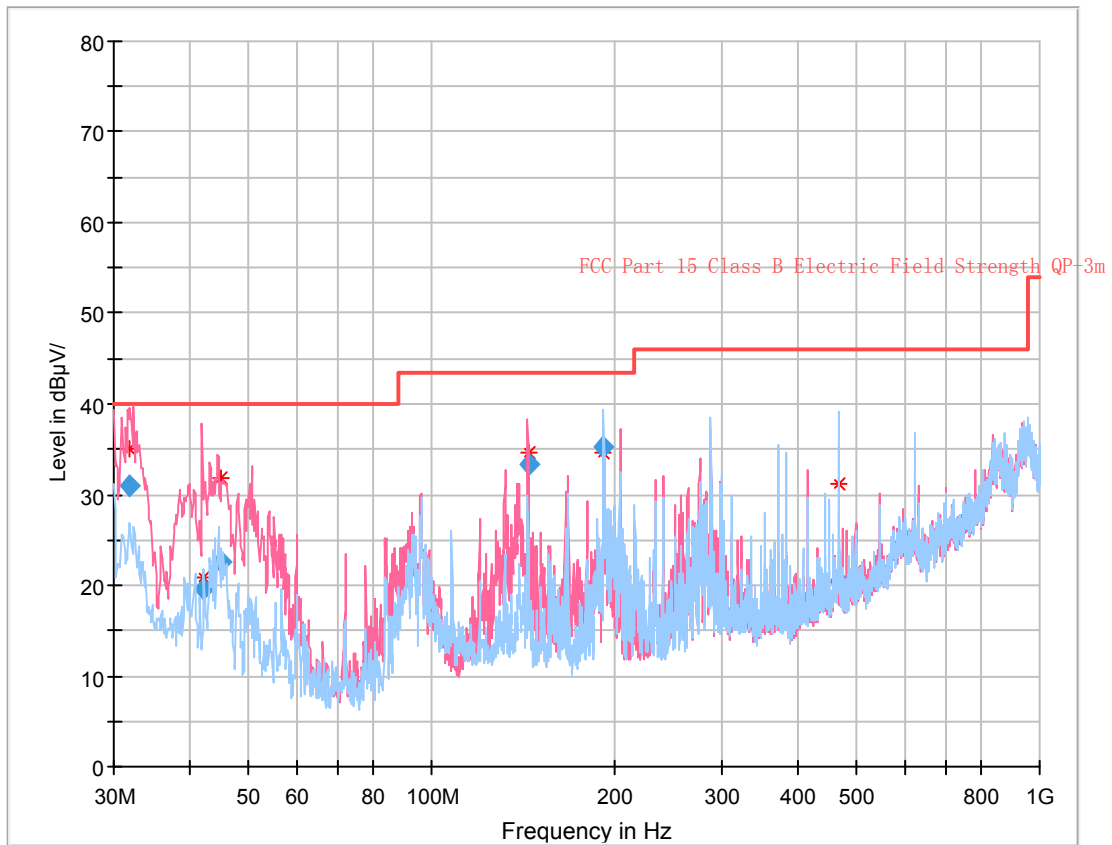

Frequency (MHz)	Corrected Amplitude (dBµV/m)	Antenna height (cm)	Antenna Polarity	Turntable position (degree)	Correction Factor (dB/m)	Limit (dBµV/m)	Margin (dB)
31.830125	30.98	105.0	V	311.0	-8.7	40.00	9.02
42.278250	19.67	128.0	V	310.0	-15.4	40.00	20.33
44.915875	22.65	108.0	V	96.0	-17.2	40.00	17.35
144.024125	33.37	101.0	V	208.0	-14.2	43.50	10.13
192.007250	35.19	184.0	H	257.0	-14.9	43.50	8.31
467.622000	20.48	137.0	H	13.0	-7.9	46.00	25.52

1 GHz – 12.5 GHz:

Frequency (MHz)	Receiver		Turntable Degree	Rx Antenna		Corrected Factor (dB/m)	Corrected Amplitude (dBuV/m)	FCC Part 15B	
	Reading (dBµV)	PK/QP/Ave.		Height (m)	Polar (H / V)			Limit (dBuV/m)	Margin (dB)
1905.23	44.73	PK	121	1.0	H	-1.50	43.23	74	30.77
1905.23	29.65	Ave.	121	1.0	H	-1.50	28.15	54	25.85
1905.23	44.35	PK	83	1.7	V	-1.50	42.85	74	31.15
1905.23	29.31	Ave.	83	1.7	V	-1.50	27.81	54	26.19
2567.13	45.13	PK	130	1.8	H	0.04	45.17	74	28.83
2567.13	30.07	Ave.	130	1.8	H	0.04	30.11	54	23.89
2567.13	45.02	PK	243	2.4	V	0.04	45.06	74	28.94
2567.13	29.99	Ave.	243	2.4	V	0.04	30.03	54	23.97

Note:

- 1) Correction Factor=Antenna factor (RX) + cable loss – amplifier factor
- 2) Corrected Amplitude = Correction Factor + Reading
- 3) Margin = Limit - Corrected Amplitude

Pre-scan for peak

Horizontal

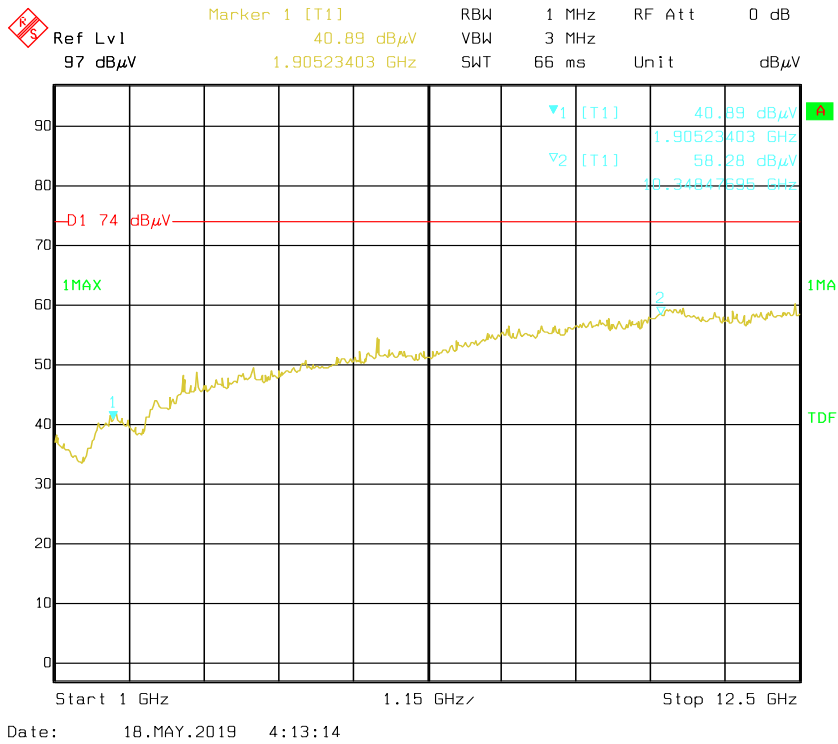

Vertical

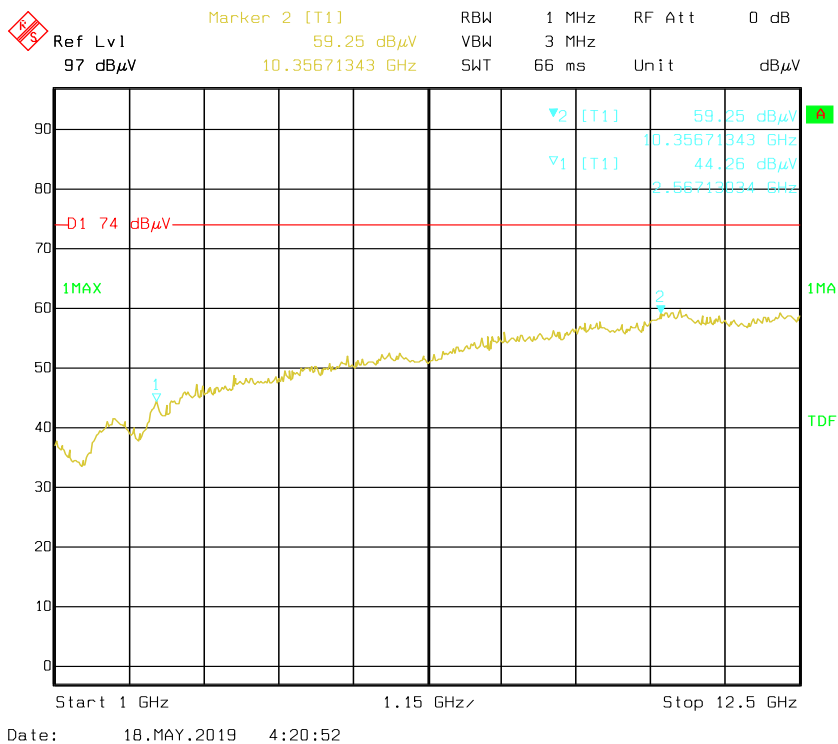

Pre-scan for Average Horizontal

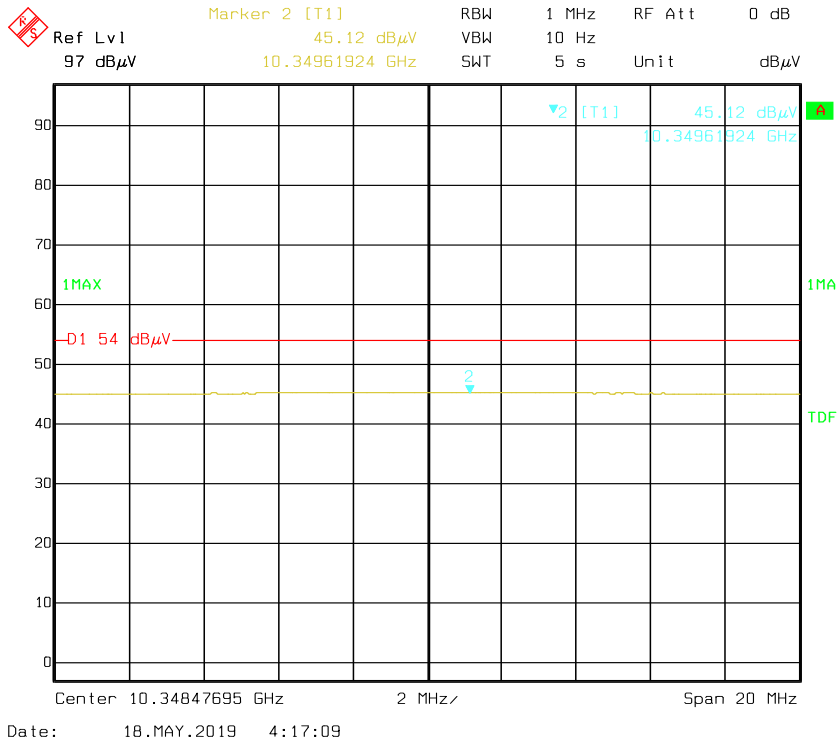

Vertical

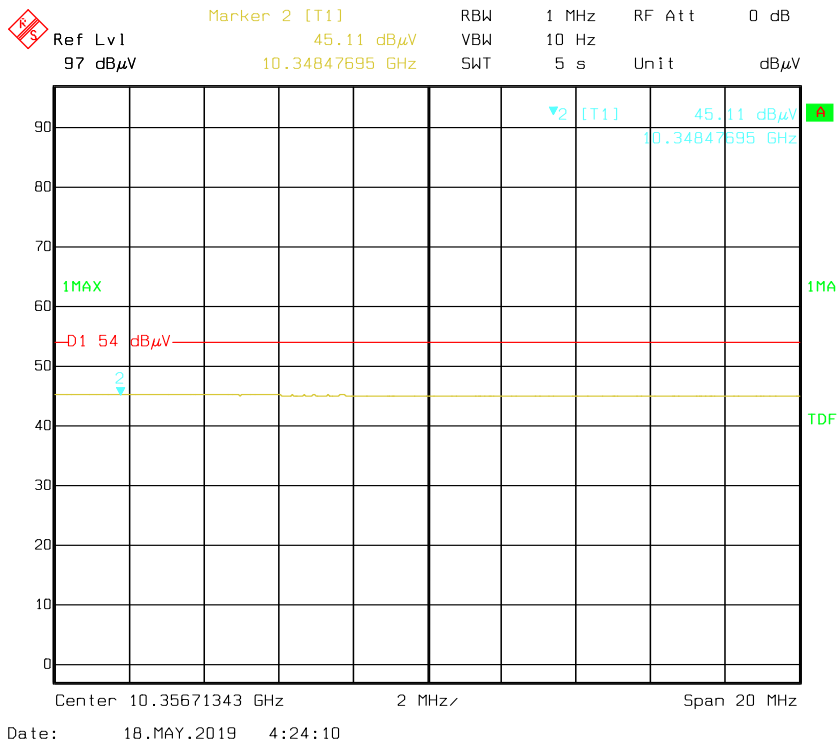

***** END OF REPORT *****