



FCC Part 15B TEST REPORT

Report No: STS1611144E01

Issued for

XTR S.A.C.

Av. Camino Real 1225 Of 201-A San Isidro, Lima, Perú

| | |
|-----------------------|---------------|
| Product Name: | Feature phone |
| Brand Name: | EKS |
| Model Name: | Cobra F2U |
| Series Model: | N/A |
| FCC ID: | 2AGAK-F2U |
| Test Standard: | FCC Part 15B |

Any reproduction of this document must be done in full. No single part of this document may be reproduced without permission from STS, All Test Data Presented in this report is only applicable to presented Test sample.





TEST RESULT CERTIFICATION

Applicant's name..... : XTR S.A.C.

Address..... : Av. Camino Real 1225 Of 201-A San Isidro, Lima, Perú

Manufacture's Name..... : Encorp Limited

Address..... : Room 219, East Building, Jianda Mansion, No.1 Kewei Road, Tech Park, Nanshan District, Shenzhen, China

Product description

Product name..... : Feature phone

Brand name..... : EKS

Model and/or type reference.. : Cobra F2U

Standards..... : FCC Part 15B

Test procedure..... ANSI C63.4-2014

This device described above has been tested by STS, and the test results show that the equipment under test (EUT) is in compliance with the FCC requirements. And it is applicable only to the tested sample identified in the report.

This report shall not be reproduced except in full, without the written approval of STS, this document may be altered or revised by STS, personal only, and shall be noted in the revision of the document.

Date of Test.....

Date of performance of tests 21 Nov. 2016~29 Nov. 2016

Date of Issue 30 Nov. 2016

Test Result Pass

Testing Engineer : tage
(tage)

Technical Manager : Alan
(alan)

Authorized Signatory : Bovey Yang
(Bovey Yang)





Table of Contents

| | |
|---|-----------|
| 1. SUMMARY OF TEST RESULTS | 5 |
| 1.1 TEST FACTORY | 5 |
| 1.2 MEASUREMENT UNCERTAINTY | 5 |
| 2. GENERAL INFORMATION | 6 |
| 2.1 GENERAL DESCRIPTION OF EUT | 6 |
| 2.2 DESCRIPTION OF TEST MODES | 7 |
| 2.3 BLOCK DIGRAM SHOWING THE CONFIGURATION OF SYSTEM TESTED | 7 |
| 2.4 DESCRIPTION OF SUPPORT UNITS | 8 |
| 2.5 EQUIPMENTS LIST FOR ALL TEST ITEMS | 9 |
| 3. EMC EMISSION TEST | 10 |
| 3.1 CONDUCTED EMISSION MEASUREMENT | 10 |
| 3.2 RADIATED EMISSION MEASUREMENT | 14 |
| 4. PHOTOS OF TEST SETUP | 20 |



Revision History

| Rev. | Issue Date | Report NO. | Effect Page | Contents |
|------|--------------|---------------|-------------|---------------|
| 00 | 30 Nov. 2016 | STS1611144E01 | ALL | Initial Issue |
| | | | | |





1. SUMMARY OF TEST RESULTS

Test procedures according to the technical standards:

| EMISSION | | | |
|---|--------------------|--------|--------------------|
| Standard | Item | Result | Remarks |
| FCC 47 CFR Part 15 Subpart B (10-1-05 Edition) | Conducted Emission | PASS | Meet Class B limit |
| | Radiated Emission | PASS | Meet Class B limit |

NOTE:

(1) "N/A" denotes test is not applicable in this Test Report

1.1 TEST FACTORY

Shenzhen STS Test Services Co., Ltd.

Add.: 1/F., Building B, Zhuoke Science Park, No.190, Chongqing Road,
Fuyong Street, Bao'an District, Shenzhen, Guangdong, China

FCC Registration No.: 842334; IC Registration No.: 12108A-1

1.2 MEASUREMENT UNCERTAINTY

The reported uncertainty of measurement $y \pm U$, where expanded uncertainty U is based on a standard uncertainty multiplied by a coverage factor of $k=2$, providing a level of confidence of approximately 95 %.

| No. | Item | Uncertainty |
|-----|--|---------------------------|
| 1 | Conducted Emission (9KHz-150KHz) | $\pm 2.88\text{dB}$ |
| 2 | Conducted Emission (150KHz-30MHz) | $\pm 2.67\text{dB}$ |
| 3 | RF power,conducted | $\pm 0.70\text{dB}$ |
| 4 | Spurious emissions,conducted | $\pm 1.19\text{dB}$ |
| 5 | All emissions,radiated(<30M) (9KHz-30MHz) | $\pm 2.45\text{dB}$ |
| 6 | All emissions,radiated(<1G) 30MHz-200MHz | $\pm 2.83\text{dB}$ |
| 7 | All emissions,radiated(<1G) 200MHz-1000MHz | $\pm 2.94\text{dB}$ |
| 8 | All emissions,radiated(>1G) | $\pm 3.03\text{dB}$ |
| 9 | Temperature | $\pm 0.5^{\circ}\text{C}$ |
| 10 | Humidity | $\pm 2\%$ |



2. GENERAL INFORMATION

2.1 GENERAL DESCRIPTION OF EUT

| | |
|-------------------------|---|
| Equipment | Feature phone |
| Trade Name | EKS |
| Model Name | Cobra F2U |
| Series Model | N/A |
| Model Difference | N/A |
| MCU Operating frequency | 1.2GHz |
| Adapter | Input: AC 100-240V, 150mA, 50/60 Hz Output: DC 5V, 500mA |
| Battery | Rated Voltage: 3.7V Capacity: 800mAh |
| Hardware version number | C733_MB_V1_2 |
| Software version number | N/A |
| Connecting I/O Port(s) | Please refer to the User's Manual |

Note: For a more detailed features description, please refer to the manufacturer's specifications or the User's Manual.

2.2 DESCRIPTION OF TEST MODES

To investigate the maximum EMI emission characteristics generates from EUT, the test system was pre-scanning tested base on the consideration of following EUT operation mode or test configuration mode which possible have effect on EMI emission level. Each of these EUT operation mode(s) or test configuration mode(s) mentioned above was evaluated respectively.

| Pretest Mode | Description |
|--------------|--------------------------------|
| Mode 1 | USB port communication with PC |

| For Conducted Test | |
|--------------------|--------------------------------|
| Final Test Mode | Description |
| Mode 1 | USB port communication with PC |

| For Radiated Test | |
|-------------------|--------------------------------|
| Final Test Mode | Description |
| Mode 1 | USB port communication with PC |

NOTE:

1. Due to the different configuration and test, in this list only some worse mode. The worst test data of the worse modeis reported by this report.
2. We have be tested for all avaiable U.S. voltage and frequencies(For 120V, 50/60Hz and 240V, 50/60Hz) for which the device is capable of operation.

2.3 BLOCK DIGRAM SHOWING THE CONFIGURATION OF SYSTEM TESTED

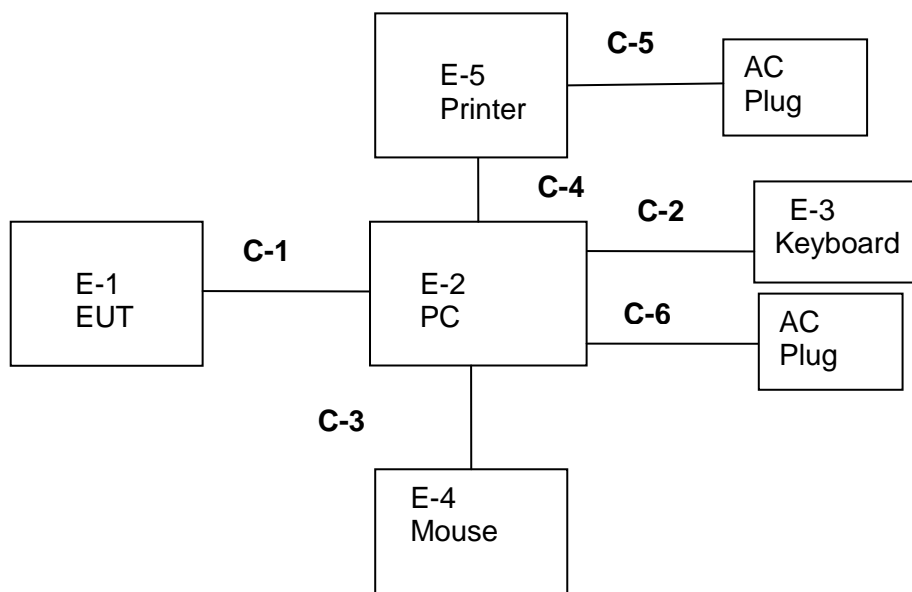



2.4 DESCRIPTION OF SUPPORT UNITS

The EUT has been tested as an independent unit together with other necessary accessories or support units. The following support units or accessories were used to form a representative test configuration during the tests.

| Item | Equipment | Mfr/Brand | Model/Type No. | Serial No. | Note |
|------|-----------------|------------|----------------|-----------------------|------|
| E-1 | Feature phone | EKS | Cobra F2U | N/A | EUT |
| E-2 | PC | 4CV428DQXR | 500-320cx | 4CV428DQYN | N/A |
| E-3 | Keyboard | HP | PR1101U | DKUSB1B06Q42209FBK800 | N/A |
| E-4 | Mouse | MOTOSPEED | F66 | 697738-001 | N/A |
| E-5 | Printer | HP | HP1020 | CNBB102765 | N/A |
| C-6 | AC (PC Adapter) | LITEON | PA-1650-86 | 3X06399004 | N/A |
| | | | | | |

| Item | Shielded Type | Ferrite Core | Length | Note |
|------|--------------------------|--------------|--------|------|
| C-1 | USB Cable (FTP) | NO | 90cm | N/A |
| C-2 | USB Cable (FTP) | NO | 100cm | N/A |
| C-3 | USB Cable (FTP) | NO | 100cm | N/A |
| C-4 | USB Cable (FTP) | NO | 110cm | N/A |
| C-5 | AC (Printer Cable) (FTP) | NO | 100cm | N/A |
| C-6 | AC (PC Cable) (FTP) | NO | 120cm | N/A |

Note:

- (1) The support equipment was authorized by Declaration of Confirmation.
- (2) For detachable type I/O cable should be specified the length in cm in 『Length』 column.
- (3) “YES” is means “shielded” “with core”; “NO” is means “unshielded” “without core”.
- (4) PC is the FCC DOC is approved.



2.5 EQUIPMENTS LIST FOR ALL TEST ITEMS

The EUT has been tested as an independent unit together with other necessary accessories or support units. The following support units or accessories were used to form a representative test configuration during the tests.

Radiation Test equipment

| Kind of Equipment | Manufacturer | Type No. | Serial No. | Last Calibration | Calibrated Until |
|-------------------------------------|--------------|---------------------|----------------|------------------|------------------|
| EMI Test Receiver | R&S | ESCI | 101427 | 2016.10.23 | 2017.10.22 |
| Loop Antenna | EMCO | 6502 | 9003-2485 | 2016.03.06 | 2019.03.03 |
| Bilog Antenna | TESEQ | CBL6111D | 34678 | 2014.11.24 | 2017.11.23 |
| Horn Antenna | Schwarzbeck | BBHA 9120D(1201) | 9120D-1343 | 2015.03.05 | 2018.03.04 |
| PreAmplifier | Agilent | 8449B | 60538 | 2016.10.23 | 2017.10.22 |
| Temperature & Humidity | Mieo | HH660 | N/A | 2016.10.23 | 2017.10.22 |
| Unversal radio communication tester | R&S | CMU200 | 111764 | 2016.10.23 | 2017.10.22 |
| Spectrum Analyzer | Agilent | E4407B | MY50140340 | 2016.10.23 | 2017.10.22 |
| Low frequency cable | EM | R01 | N/A | NCR | NCR |
| High frequency cable | SCHWARZBECK | AK9515H | SN-96286/96287 | NCR | NCR |
| Semi-anechoic chamber | Changling | 966 | N/A | 2016.10.23 | 2017.10.22 |

Conduction Test equipment

| Kind of Equipment | Manufacturer | Type No. | Serial No. | Last Calibration | Calibrated Until |
|-------------------|--------------|----------|------------|------------------|------------------|
| EMI Test Receiver | R&S | ESPI | 102086 | 2016.10.23 | 2017.10.22 |
| LISN | R&S | ENV216 | 101242 | 2016.10.23 | 2017.10.22 |
| LISN | EMCO | 3810/2NM | 000-23625 | 2016.10.23 | 2017.10.22 |
| Conduction Cable | EM | C01 | N/A | NCR | NCR |
| Shielding Room | Changling | 854 | N/A | 2016.10.23 | 2017.10.22 |



3. EMC EMISSION TEST

3.1 CONDUCTED EMISSION MEASUREMENT

3.1.1 POWER LINE CONDUCTED EMISSION Limits

| FREQUENCY (MHz) | Conducted Emission Limits (dBuV) | | | |
|-----------------|----------------------------------|---------|------------|-----------|
| | Class A | | Class B | |
| | Quasi-peak | Average | Quasi-peak | Average |
| 0.15 -0.5 | 79.00 | 66.00 | 66 - 56 * | 56 - 46 * |
| 0.50 -5.0 | 73.00 | 60.00 | 56.00 | 46.00 |
| 5.0 -30.0 | 73.00 | 60.00 | 60.00 | 50.00 |

Note:

- (1) The tighter limit applies at the band edges.
- (2) The limit of " * " marked band means the limitation decreases linearly with the logarithm of the frequency in the range.

The following table is the setting of the receiver

| Receiver Parameters | Setting |
|---------------------|----------|
| Attenuation | 10 dB |
| Start Frequency | 0.15 MHz |
| Stop Frequency | 30 MHz |
| IF Bandwidth | 9 kHz |

3.1.2 TEST PROCEDURE

- The EUT was 0.8 meters from the horizontal ground plane and 0.4 meters from the vertical ground plane with EUT being connected to the power mains through a line impedance stabilization network (LISN). All other support equipments powered from additional LISN(s). The LISN provide 50 Ohm/ 50uH of coupling impedance for the measuring instrument.
- Interconnecting cables that hang closer than 40 cm to the ground plane shall be folded back and forth in the center forming a bundle 30 to 40 cm long.
 - I/O cables that are not connected to a peripheral shall be bundled in the center. The end of the cable may be terminated, if required, using the correct terminating impedance. The overall length shall not exceed 1 m.
 - LISN at least 80 cm from nearest part of EUT chassis.
 - For the actual test configuration, please refer to the related Item –EUT Test Photos.

3.1.3 DEVIATION FROM TEST STANDARD

No deviation

3.1.4 TEST SETUP

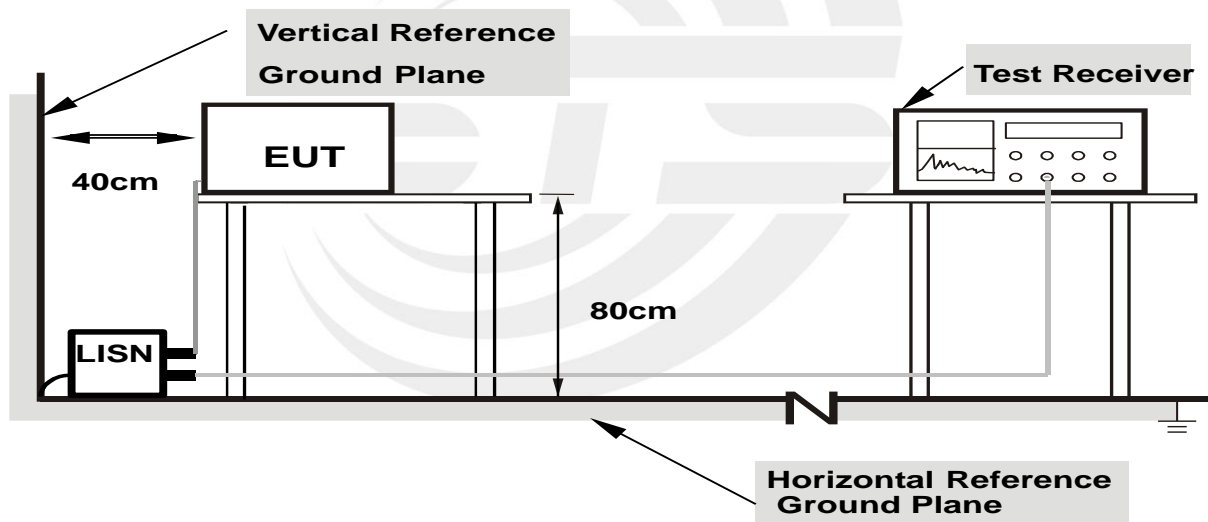

- Note: 1.Support units were connected to second LISN.
2.Both of LISNs (AMN) are 80 cm from EUT and at least 80 cm from other units and other metal planes**

3.1.5 EUT OPERATING CONDITIONS

The EUT was configured for testing in a typical fashion (as a customer would normally use it). The EUT has been programmed to continuously transmit during test. This operating condition was tested and used to collect the included data.



3.1.6 TEST RESULTS

| | | | |
|---------------|--------------|--------------------|--------|
| Temperature: | 26 °C | Relative Humidity: | 54% |
| Pressure: | 1010hPa | Phase: | L |
| Test Voltage: | AC 120V/60Hz | Test Mode: | Mode 1 |

| No. | Frequency (MHz) | Reading (dBuV) | Factor (dB) | Result (dBuV) | Limit (dBuV) | Margin (dB) | Detector |
|-----|-----------------|----------------|-------------|---------------|--------------|-------------|----------|
| 1 | 0.1780 | 45.50 | 9.23 | 54.73 | 64.58 | -9.85 | QP |
| 2 | 0.1780 | 28.59 | 9.23 | 37.82 | 54.58 | -16.76 | AVG |
| 3 | 0.2420 | 36.95 | 9.19 | 46.14 | 62.03 | -15.89 | QP |
| 4 | 0.2420 | 21.55 | 9.19 | 30.74 | 52.03 | -21.29 | AVG |
| 5 | 0.3100 | 33.60 | 9.16 | 42.76 | 59.97 | -17.21 | QP |
| 6 | 0.3100 | 15.69 | 9.16 | 24.85 | 49.97 | -25.12 | AVG |
| 7 | 4.1420 | 25.39 | 9.27 | 34.66 | 56.00 | -21.34 | QP |
| 8 | 4.1420 | 9.39 | 9.27 | 18.66 | 46.00 | -27.34 | AVG |
| 9 | 10.2420 | 28.01 | 9.50 | 37.51 | 60.00 | -22.49 | QP |
| 10 | 10.2420 | 15.92 | 9.50 | 25.42 | 50.00 | -24.58 | AVG |
| 11 | 21.5620 | 27.14 | 9.89 | 37.03 | 60.00 | -22.97 | QP |
| 12 | 21.5620 | 15.62 | 9.89 | 25.51 | 50.00 | -24.49 | AVG |

Remark:

1. All readings are Quasi-Peak and Average values.
2. Margin = Result (Result = Reading + Factor) – Limit

100.0 dBuV

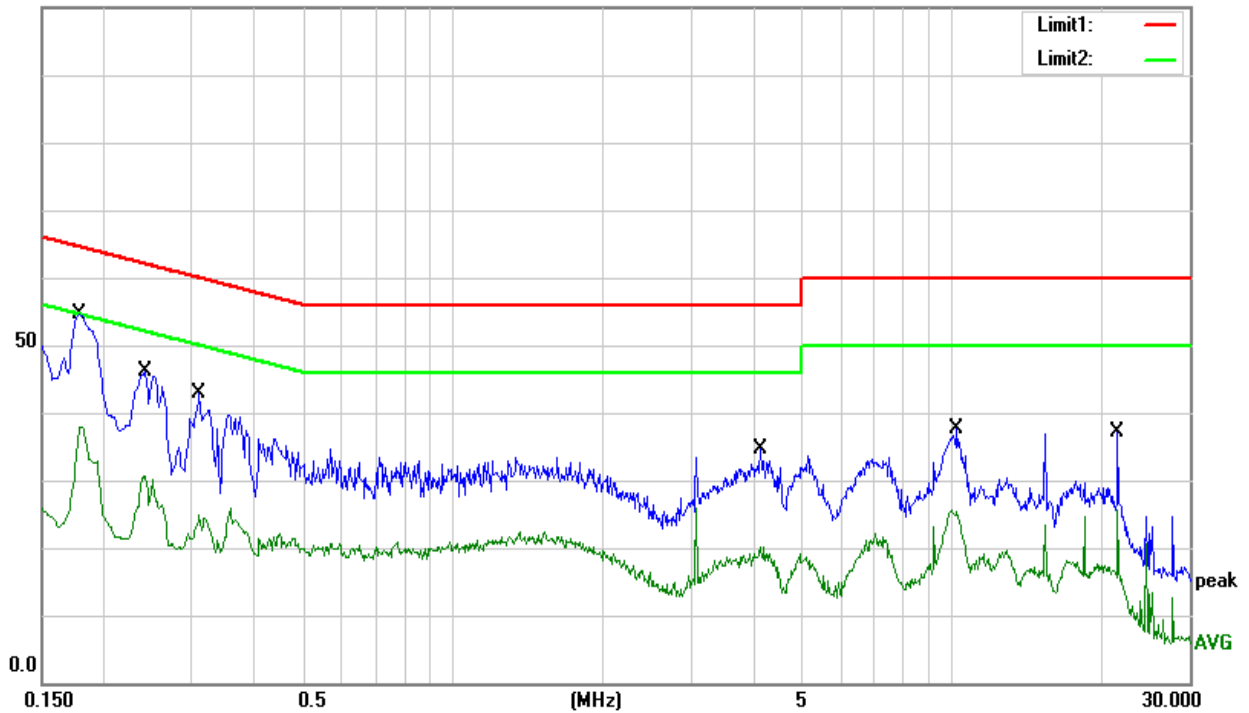



| | | | |
|---------------|--------------|--------------------|--------|
| Temperature: | 26 °C | Relative Humidity: | 54% |
| Pressure: | 1010hPa | Phase: | N |
| Test Voltage: | AC 120V/60Hz | Test Mode: | Mode 1 |

| No. | Frequency (MHz) | Reading (dBUV) | Factor (dB) | Result (dBUV) | Limit (dBUV) | Margin (dB) | Detector |
|-----|-----------------|----------------|-------------|---------------|--------------|-------------|----------|
| 1 | 0.1820 | 44.29 | 9.23 | 53.52 | 64.39 | -10.87 | QP |
| 2 | 0.1820 | 28.66 | 9.23 | 37.89 | 54.39 | -16.50 | AVG |
| 3 | 0.2980 | 32.77 | 9.13 | 41.90 | 60.30 | -18.40 | QP |
| 4 | 0.2980 | 17.68 | 9.13 | 26.81 | 50.30 | -23.49 | AVG |
| 5 | 4.1300 | 26.84 | 9.27 | 36.11 | 56.00 | -19.89 | QP |
| 6 | 4.1300 | 10.63 | 9.27 | 19.90 | 46.00 | -26.10 | AVG |
| 7 | 10.0860 | 29.51 | 9.40 | 38.91 | 60.00 | -21.09 | QP |
| 8 | 10.0860 | 17.87 | 9.40 | 27.27 | 50.00 | -22.73 | AVG |
| 9 | 15.4060 | 26.17 | 9.46 | 35.63 | 60.00 | -24.37 | QP |
| 10 | 15.4060 | 13.20 | 9.46 | 22.66 | 50.00 | -27.34 | AVG |
| 11 | 21.5700 | 26.68 | 9.81 | 36.49 | 60.00 | -23.51 | QP |
| 12 | 21.5700 | 15.69 | 9.81 | 25.50 | 50.00 | -24.50 | AVG |

Remark:

- All readings are Quasi-Peak and Average values.
- Margin = Result (Result = Reading + Factor) – Limit

100.0 dBUV

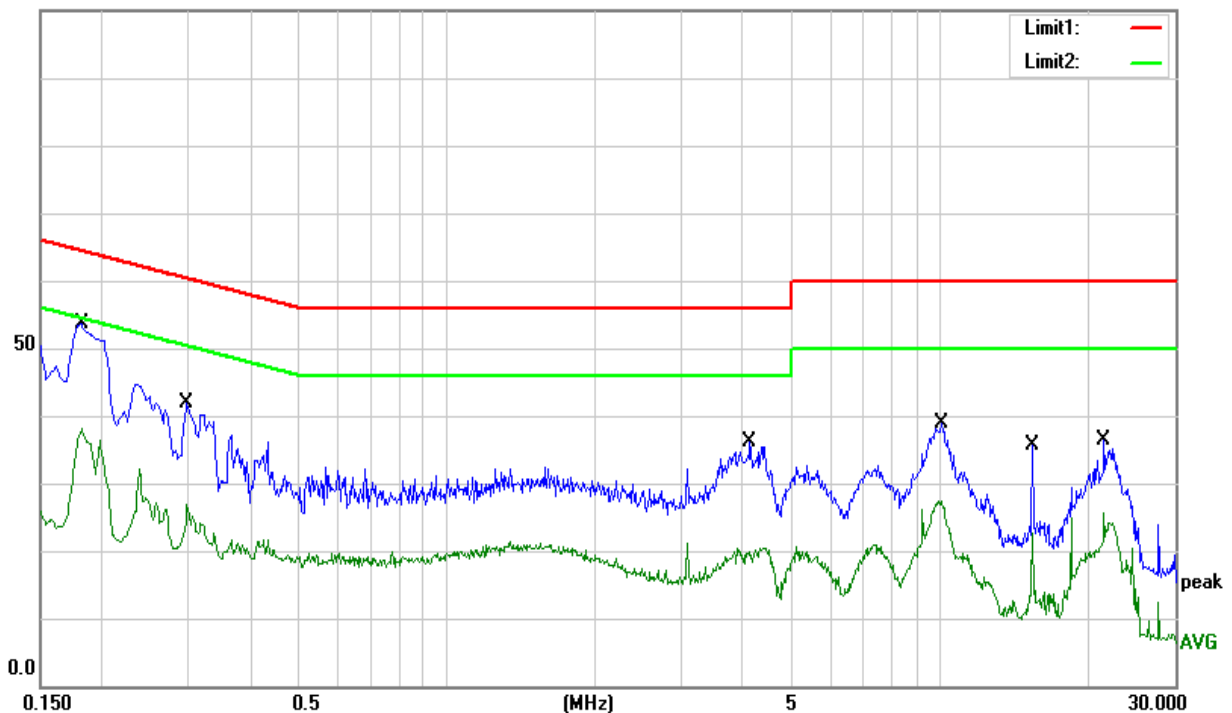



3.2 RADIATED EMISSION MEASUREMENT

3.2.1 Radiated Emission Limits

In case the emission fall within the restricted band specified on 15.105(a)&109(a) limit in the table below has to be followed.

| Frequencies (MHz) | Field Strength (micorvolts/meter) | Measurement Distance (meters) |
|-------------------|-----------------------------------|-------------------------------|
| 30~88 | 100 | 3 |
| 88~216 | 150 | 3 |
| 216~960 | 200 | 3 |
| Above 960 | 500 | 3 |

LIMITS OF RADIATED EMISSION MEASUREMENT

| FREQUENCY (MHz) | Class A (dBuV/m) (at 3M) | | Class B (dBuV/m) (at 3M) | |
|-----------------|--------------------------|---------|--------------------------|---------|
| | PEAK | AVERAGE | PEAK | AVERAGE |
| Above 1000 | 80 | 60 | 74 | 54 |

Note:

- (1) The limit for radiated test was performed according to FCC PART 15B.
- (2) The tighter limit applies at the band edges.
- (3) Emission level (dBuV/m)=20log Emission level (uV/m).

FREQUENCY RANGE OF RADIATED MEASUREMENT (For unintentional radiators)

| Highest frequency generated or Upper frequency of measurement used in the device or on which the device operates or tunes (MHz) | Range (MHz) |
|---|---|
| Below 1.705 | 30 |
| 1.705 – 108 | 1000 |
| 108 – 500 | 2000 |
| 500 – 1000 | 5000 |
| Above 1000 | 5th harmonic of the highest frequency or 40 GHz, whichever is lower |



| Spectrum Parameter | Setting |
|---------------------------------------|---|
| Attenuation | Auto |
| Detector | Peak |
| Start Frequency | 1000 MHz(Peak/AV) |
| Stop Frequency | 5th harmonic (Peak/AV) |
| RB / VB (emission in restricted band) | 30MHz to 1000MHz: 100 KHz / 300 KHz Above 1000MHz: 1 MHz / 3 MHz |

| Receiver Parameter | Setting |
|------------------------|---|
| Attenuation | Auto |
| Start ~ Stop Frequency | 30MHz to 1000MHz: 100 KHz / 300 KHz Above 1000MHz: 1 MHz / 3 MHz |

3.2.2 TEST PROCEDURE

- a. The measuring distance of at 3 m shall be used for measurements at frequency up to 1GHz and above 1GHz.

The EUT was placed on the top of a rotating table 0.8 meters above the ground at a 3 meter anechoic chamber. The table was rotated 360 degrees to determine the position of the highest radiation.

- c. the height of the antenna shall vary between 1m to 4 m. Both horizontal and vertical polarizations of the antenna are set to make the measurement.

The initial step in collecting conducted emission data is a spectrum analyzer peak detector mode pre-scanning the measurement frequency range. Significant peaks are then marked and then Quasi Peak detector mode re-measured.

If the Peak Mode measured value compliance with and lower than Quasi Peak Mode Limit, the EUT shall be deemed to meet QP Limits and then no additional QP Mode measurement performed.

- f. For the actual test configuration, please refer to the related Item –EUT Test Photos.

Note: Both horizontal and vertical antenna polarities were tested and performed pretest to three orthogonal axis. The worst case emissions were reported

3.2.3 DEVIATION FROM TEST STANDARD

No deviation

3.2.4 TEST SETUP

(A) Radiated Emission Test-Up Frequency 30MHz~1GHz

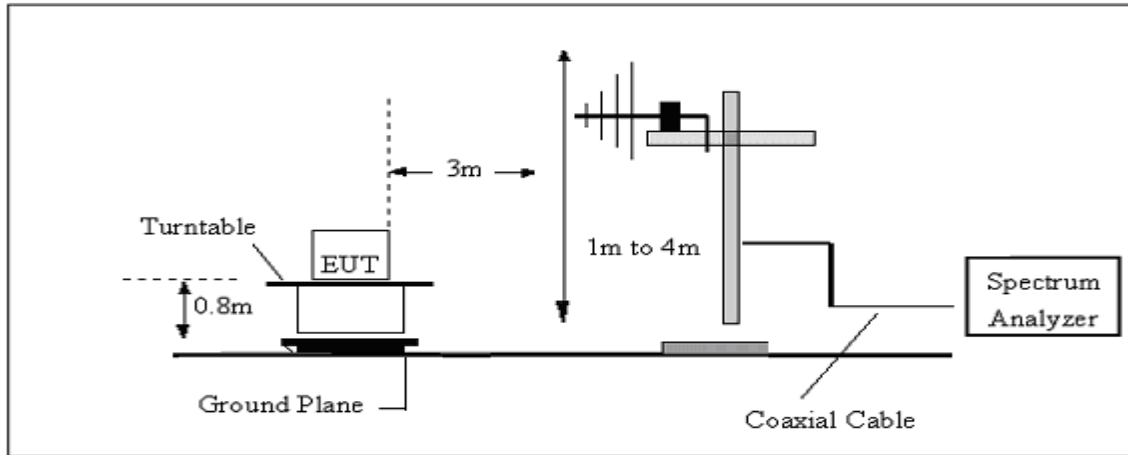

(B) Radiated Emission Test-Up Frequency Above 1GHz

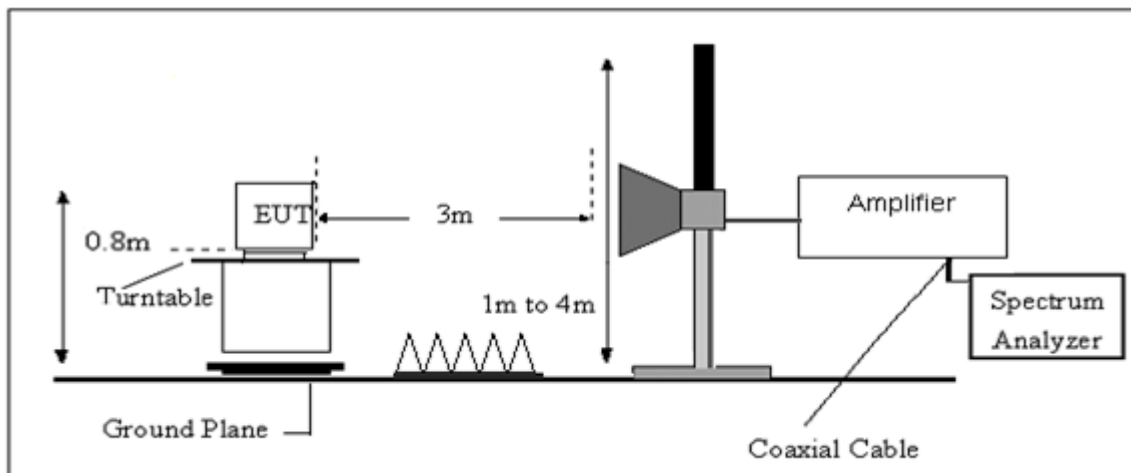

3.2.5 EUT OPERATING CONDITIONS

The EUT tested system was configured as the statements of 2.4 Unless otherwise a special operating condition is specified in the follows during the testing.



3.2.6 TEST RESULTS

30MHz -1000MHz

| | | | |
|---------------|--------------|--------------------|------------|
| Temperature: | 26 °C | Relative Humidity: | 54% |
| Pressure: | 1010hPa | Phase: | Horizontal |
| Test Voltage: | AC 120V/60Hz | Test Mode: | Mode 1 |

| No. | Frequency (MHz) | Reading (dBUV) | Factor (dB) | Results (dBUV/m) | Limit (dBUV/m) | Margin (dB) | Detector |
|-----|-----------------|----------------|-------------|------------------|----------------|-------------|----------|
| 1 | 49.1865 | 43.10 | -21.03 | 22.07 | 40.00 | -17.93 | QP |
| 2 | 98.8326 | 36.25 | -19.51 | 16.74 | 43.50 | -26.76 | QP |
| 3 | 239.9873 | 36.08 | -18.11 | 17.97 | 46.00 | -28.03 | QP |
| 4 | 383.9318 | 42.26 | -12.71 | 29.55 | 46.00 | -16.45 | QP |
| 5 | 689.5644 | 37.00 | -6.15 | 30.85 | 46.00 | -15.15 | QP |
| 6 | 768.7481 | 36.98 | -4.04 | 32.94 | 46.00 | -13.06 | QP |

Remark:

1. Margin = Result (Result =Reading + Factor)–Limit

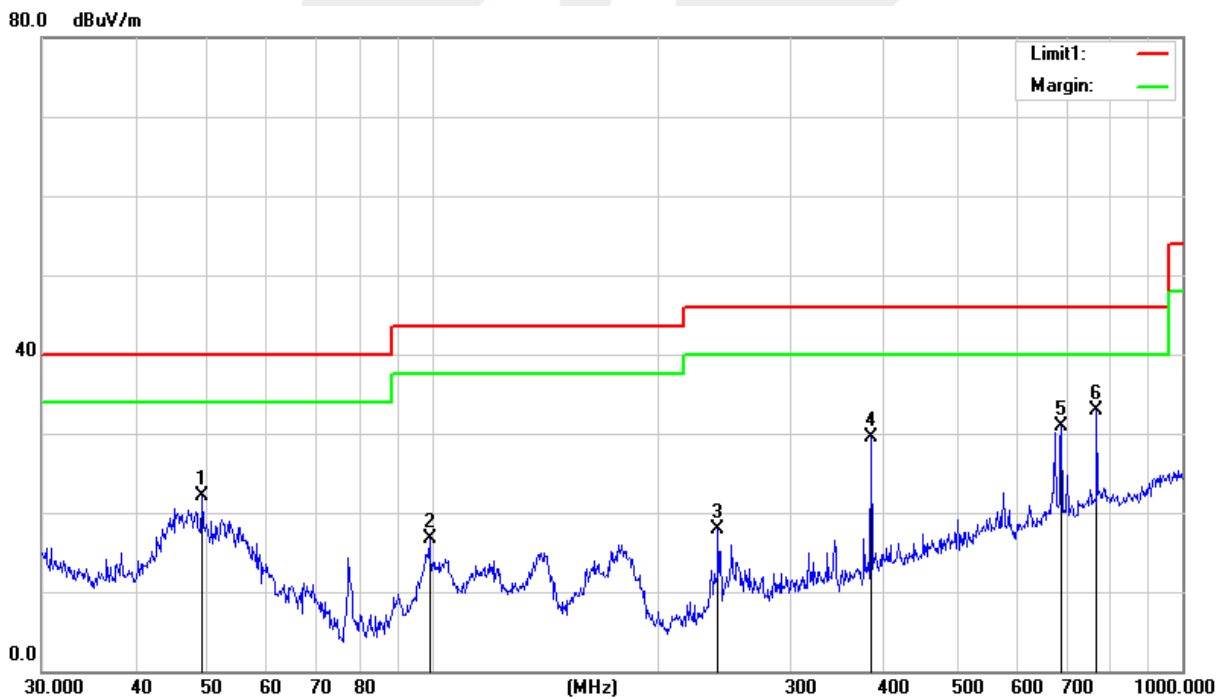



| | | | |
|---------------|--------------|--------------------|----------|
| Temperature: | 26 °C | Relative Humidity: | 54% |
| Pressure: | 1010hPa | Phase: | Vertical |
| Test Voltage: | AC 120V/60Hz | Test Mode: | Mode 1 |

| No. | Frequency (MHz) | Reading (dBuV) | Factor (dB) | Results (dBuV/m) | Limit (dBuV/m) | Margin (dB) | Detector |
|-----|-----------------|----------------|-------------|------------------|----------------|-------------|----------|
| 1 | 43.6584 | 47.79 | -18.18 | 29.61 | 40.00 | -10.39 | QP |
| 2 | 53.1313 | 51.87 | -22.36 | 29.51 | 40.00 | -10.49 | QP |
| 3 | 77.5928 | 49.06 | -23.13 | 25.93 | 40.00 | -14.07 | QP |
| 4 | 99.8777 | 43.56 | -19.40 | 24.16 | 43.50 | -19.34 | QP |
| 5 | 152.1297 | 35.49 | -18.26 | 17.23 | 43.50 | -26.27 | QP |
| 6 | 375.9385 | 31.31 | -13.09 | 18.22 | 46.00 | -27.78 | QP |

Remark:

1. Margin = Result (Result =Reading + Factor)–Limit

80.0 dBuV/m

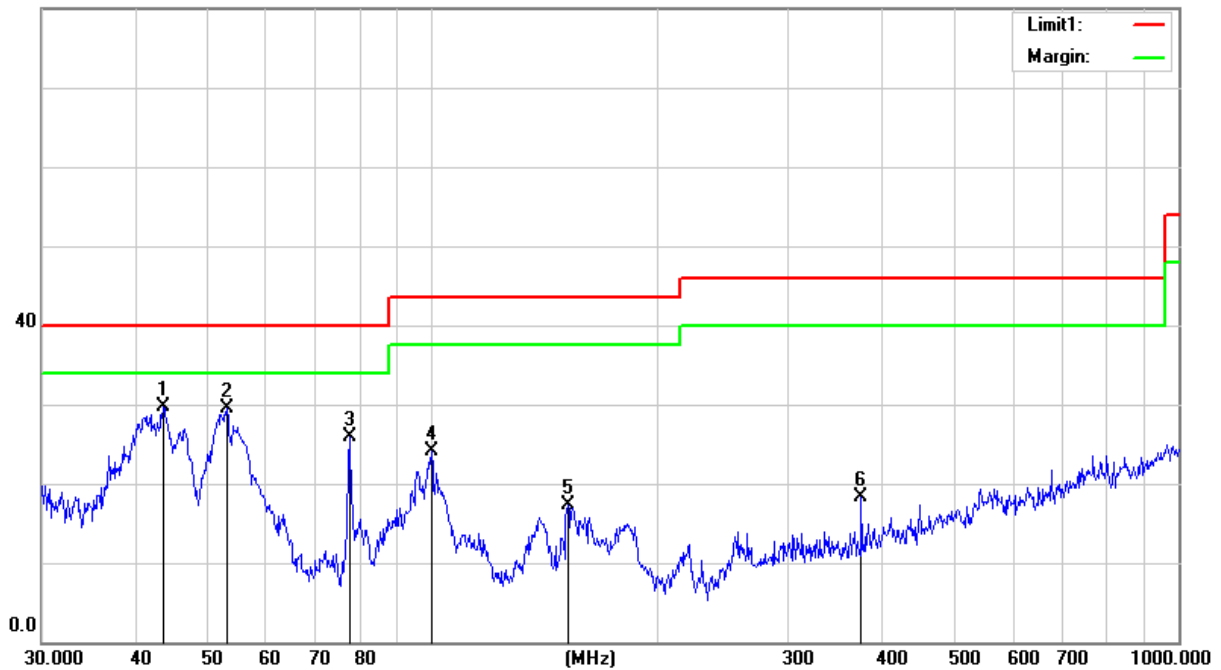



(1 GHz to 13GHz.)

| | | | |
|---------------|--------------|--------------------|---------------------|
| Temperature: | 26 °C | Relative Humidity: | 54% |
| Pressure: | 1010hPa | Phase: | Vertical/Horizontal |
| Test Voltage: | AC 120V/60Hz | Test Mode: | Mode 1 |

PK

| Freq. | Ant. Pol | Peak | Amplifier | Loss | Antenna Factor | Orrected Factor | Actual Fs | Peak | Peak |
|--------|----------|----------------|-----------|------|----------------|-----------------|---------------|----------------|-----------------|
| (MHz) | H/V | Reading (dBuV) | (dB) | (dB) | (dB/m) | (dB) | Peak (dBuV/m) | Limit (dBuV/m) | margin (dBuV/m) |
| 2058.9 | H | 57.87 | 43.8 | 5.4 | 25.9 | -12.5 | 45.37 | 74 | -28.63 |
| 2521.2 | H | 52.94 | 44.4 | 6.0 | 27.6 | -10.8 | 42.14 | 74 | -31.86 |
| 3028.6 | H | 63.54 | 44.7 | 6.7 | 28.2 | -9.8 | 53.74 | 74 | -20.26 |
| 3536.9 | H | 52.53 | 44.4 | 7.1 | 28.5 | -8.8 | 43.73 | 74 | -30.27 |
| N/A | | | | | | | | | |
| 2058.9 | V | 52.86 | 43.8 | 5.4 | 25.9 | -12.5 | 40.36 | 74 | -33.64 |
| 2521.2 | V | 49.98 | 44.4 | 6.0 | 27.6 | -10.8 | 39.18 | 74 | -34.82 |
| 3028.6 | V | 63.23 | 44.7 | 6.7 | 28.2 | -9.8 | 53.43 | 74 | -20.57 |
| 3536.9 | V | 49.68 | 44.4 | 7.1 | 28.5 | -8.8 | 40.88 | 74 | -33.12 |
| N/A | | | | | | | | | |

AV

| Freq. | Ant. Pol | AV | Amplifier | Loss | Antenna Factor | Orrected Factor | AV | AV | AV |
|--------|----------|----------------|-----------|------|----------------|-----------------|-------------|----------------|-----------------|
| (MHz) | H/V | Reading (dBuV) | (dB) | (dB) | (dB/m) | (dB) | AV (dBuV/m) | Limit (dBuV/m) | margin (dBuV/m) |
| 2058.9 | H | 41.97 | 43.8 | 5.4 | 25.9 | -12.5 | 29.47 | 54 | -24.53 |
| 2521.2 | H | 38.85 | 44.4 | 6.0 | 27.6 | -10.8 | 28.05 | 54 | -25.95 |
| 3028.6 | H | 42.32 | 44.7 | 6.7 | 28.2 | -9.8 | 32.52 | 54 | -21.48 |
| 3536.9 | H | 38.83 | 44.4 | 7.1 | 28.5 | -8.8 | 30.03 | 54 | -23.97 |
| N/A | | | | | | | | | |
| 2058.9 | V | 37.68 | 43.8 | 5.4 | 25.9 | -12.5 | 25.18 | 54 | -28.82 |
| 2521.2 | V | 33.75 | 44.4 | 6.0 | 27.6 | -10.8 | 22.95 | 54 | -31.05 |
| 3028.6 | V | 55.24 | 44.7 | 6.7 | 28.2 | -9.8 | 45.44 | 54 | -8.56 |
| 3536.9 | V | 34.51 | 44.4 | 7.1 | 28.5 | -8.8 | 25.71 | 54 | -28.29 |
| N/A | | | | | | | | | |

Notes:

1. Measuring frequencies from 1 GHz to 13GHz.
2. Radiated emissions measured in frequency above 1000MHz were made with an instrument using Peak detector mode of the emission shown in Actual FS column.
3. The frequency that above 3GHz is mainly from the environment noise.

4. PHOTOS OF TEST SETUP

Radiated Measurement Photos

30MHz- 1GHz

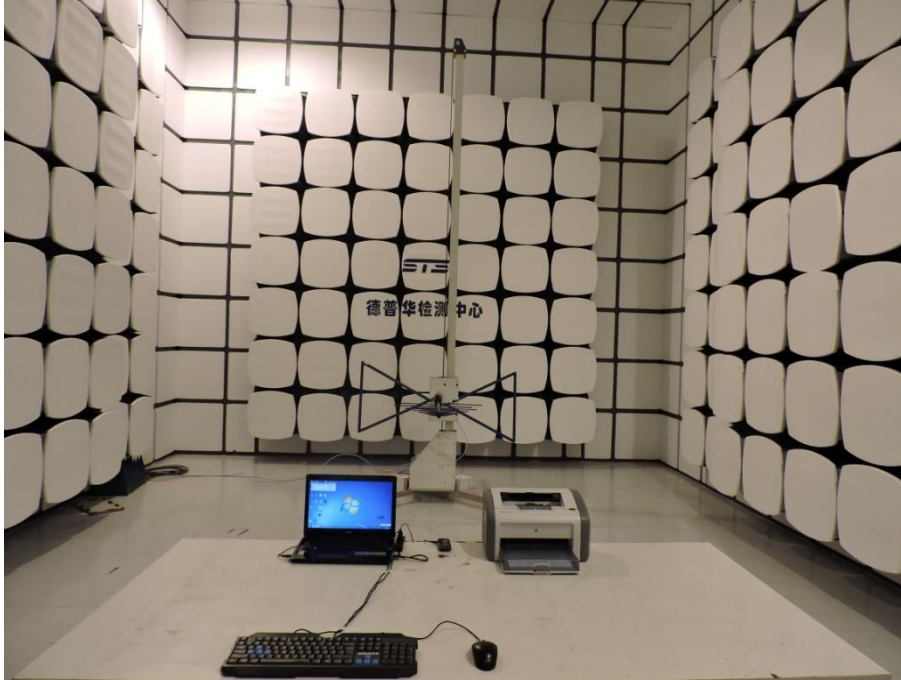

Above 1GHz

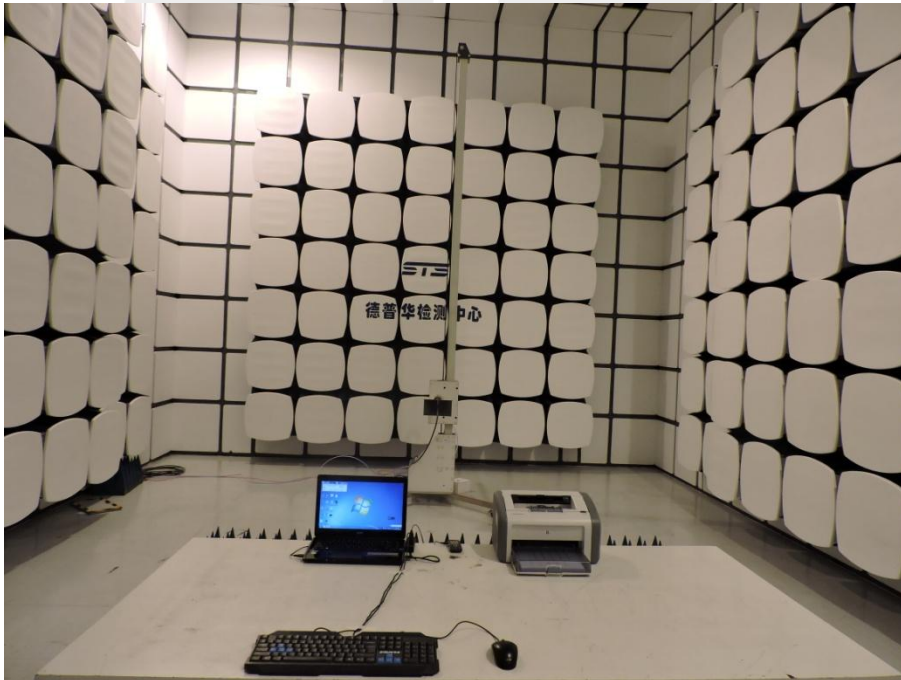

Conducted Measurement Photos



※※※※END OF THE REPORT※※※※