



FCC Part 15B TEST REPORT

Report No: STS1709300E01

Issued for

XTR S.A.C.

Av. Camino Real 1225 Of 201-A San Isidro Lima, Peru

Product Name:	Feature Phone
Brand Name:	EKS
Test Model Name:	C2U
Series Model:	N/A
FCC ID:	2AGAK-C2U
Test Standard:	FCC Part 15B

Any reproduction of this document must be done in full. No single part of this document may be reproduced without permission from STS, All Test Data Presented in this report is only applicable to presented Test sample.





TEST RESULT CERTIFICATION

Applicant's name..... : XTR S.A.C.

Address..... : Av. Camino Real 1225 Of 201-A San Isidro Lima, Peru

Manufacture's Name..... : ENCORP LIMITED

Address..... : 6th Floor, Fuhua Technology Mansion A, Beihuan Boulevard No. 9116, Nanshan District, Shenzhen, China.

Product description

Product name..... : Feature Phone

Brand name..... : EKS

Test Model Name : C2U

Series Model : N/A

Standards..... : FCC Part 15B

Test procedure..... ANSI C63.4-2014

This device described above has been tested by STS, and the test results show that the equipment under test (EUT) is in compliance with the FCC requirements. And it is applicable only to the tested sample identified in the report.

This report shall not be reproduced except in full, without the written approval of STS, this document may be altered or revised by STS, personal only, and shall be noted in the revision of the document.

Date of Test.....

Date of performance of tests 29 Sep. 2017~09 Oct. 2017

Date of Issue 10 Oct. 2017

Test Result Pass

Testing Engineer : 
(Kyle Rao)

Technical Manager : 
(Chopin Xiao)

Authorized Signatory : 
(Vita Li)





Table of Contents

1. SUMMARY OF TEST RESULTS	5
1.1 TEST FACTORY	5
1.2 MEASUREMENT UNCERTAINTY	5
2. GENERAL INFORMATION	6
2.1 GENERAL DESCRIPTION OF EUT	6
2.2 DESCRIPTION OF TEST MODES	7
2.3 BLOCK DIGRAM SHOWING THE CONFIGURATION OF SYSTEM TESTED	8
2.4 DESCRIPTION OF SUPPORT UNITS	9
2.5 EQUIPMENTS LIST FOR ALL TEST ITEMS	10
3. EMC EMISSION TEST	11
3.1 CONDUCTED EMISSION MEASUREMENT	11
3.2 RADIATED EMISSION MEASUREMENT	15
4. PHOTOS OF TEST SETUP	22



Revision History

Rev.	Issue Date	Report NO.	Effect Page	Contents
00	10 Oct. 2017	STS1709300E01	ALL	Initial Issue





1. SUMMARY OF TEST RESULTS

Test procedures according to the technical standards:

EMISSION			
Standard	Item	Result	Remarks
FCC 47 CFR Part 15 Subpart B (10-1-05 Edition)	Conducted Emission	PASS	Meet Class B limit
	Radiated Emission	PASS	Meet Class B limit

NOTE:

(1) "N/A" denotes test is not applicable in this Test Report

1.1 TEST FACTORY

Company Name:	Shenzhen STS Test Services Co. Ltd.
Address:	1/F., Building B, Zhuoke Science Park, No.190, Chongqing Road, Fuyong Street, Bao'an District, Shenzhen, Guangdong, China
Telephone:	+86-755 3688 6288
Fax:	+86-755 3688 6277
Registration No.:	CNAS Registration No.: L7649; FCC Registration No.: 625569 IC Registration No.: 12108A; A2LA Certificate No.: 4338.01;

1.2 MEASUREMENT UNCERTAINTY

The reported uncertainty of measurement $y \pm U$, where expanded uncertainty U is based on a standard uncertainty multiplied by a coverage factor of $k=2$, providing a level of confidence of approximately 95 %.

No.	Item	Uncertainty
1	Conducted Emission (9KHz-150KHz)	± 2.88 dB
2	Conducted Emission (150KHz-30MHz)	± 2.67 dB
3	All emissions,radiated(<30M) (9KHz-30MHz)	± 2.45 dB
4	All emissions,radiated(<1G) 30MHz-200MHz	± 3.80 dB
5	All emissions,radiated(<1G) 200MHz-1000MHz	± 3.97 dB
6	All emissions,radiated(>1G)	± 3.03 dB



2. GENERAL INFORMATION

2.1 GENERAL DESCRIPTION OF EUT

Equipment	Feature Phone
Trade Name	EKS
Model Name	C2U
Series Model	N/A
Model Difference	N/A
Frequency Bands	GSM 850: 824.2~848.8MHz PCS1900: 1850.2~1909.8MHz WCDMA Band II: 1852.4~1907.6MHz WCDMA Band V: 826.4~846.6MHz WLAN802 11b/g/n(HT20):2412~2462MHz Bluetooth: 2402~2480MHz
Modulation Mode	GSM: GMSK for GPRS; GMSK and 8PSK for EDGE; WCDMA: QPSK; HSDPA:QPSK/16QAM; HSUPA:BPSK; WLAN: CCK/OFDM/DBPSK/DAPSK; Bluetooth: GFSK(1Mbps), $\pi/4$ -DQPSK(2Mbps), 8DPSK(3Mbps)
Adapter	Input: AC180-240V, 150mA,50/60Hz Output: DC 5V,320mA
Battery	Rated Voltage: 3.7V Capacity: 1000mAh Charge Limit: 4.2V
Hardware version number	C801_1.2
Software version number	XTR_S45U_PE_20170812

Note: For a more detailed features description, please refer to the manufacturer's specifications or the User's Manual.



2.2 DESCRIPTION OF TEST MODES

To investigate the maximum EMI emission characteristics generates from EUT, the test system was pre-scanning tested base on the consideration of following EUT operation mode or test configuration mode which possible have effect on EMI emission level. Each of these EUT operation mode(s) or test configuration mode(s) mentioned above was evaluated respectively.

Pretest Mode	Description
Mode 1	USB port communication with PC

For Conducted Test	
Final Test Mode	Description
Mode 1	USB port communication with PC

For Radiated Test	
Final Test Mode	Description
Mode 1	USB port communication with PC

NOTE:

1. The test modes were carried out for all operation modes. Only worst case will be show in this report.
2. We have be tested for all avaiable U.S. voltage and frequencies(For 120V, 50/60Hz) for which the device is capable of operation.

2.3 BLOCK DIGRAM SHOWING THE CONFIGURATION OF SYSTEM TESTED

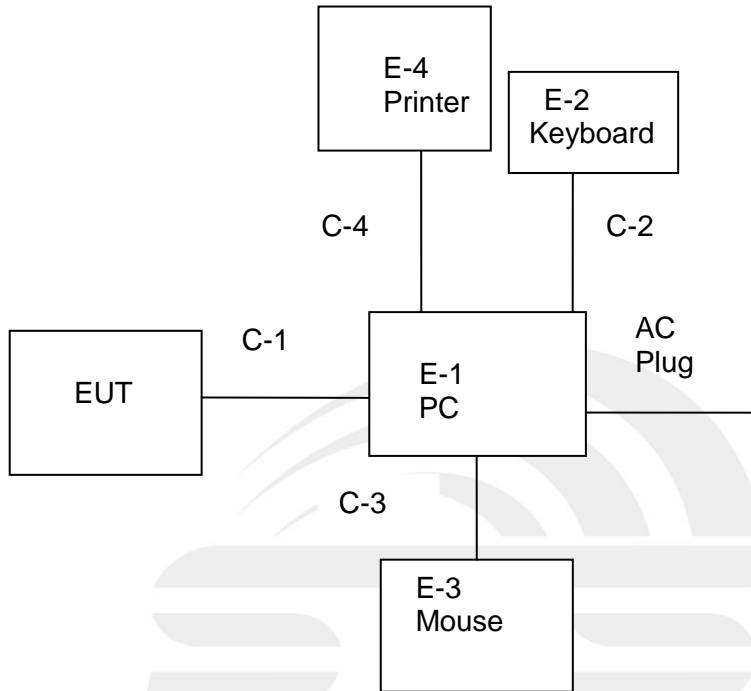



2.4 DESCRIPTION OF SUPPORT UNITS

The EUT has been tested as an independent unit together with other necessary accessories or support units. The following support units or accessories were used to form a representative test configuration during the tests.

Item	Equipment	Mfr/Brand	Model/Type No.	Note
E-1	PC	4CV428DQXR	500-320cx	N/A
E-2	Keyboard	HP	PR1101U	N/A
E-3	Mouse	MOTOSPEED	F66	N/A
E-4	Printer	HP	HP1020	N/A

Item	Shielded Type	Ferrite Core	Length	Note
C-1	USB Cable (FTP)	NO	95cm	N/A
C-2	USB Cable (FTP)	NO	110cm	N/A
C-3	USB Cable (FTP)	NO	115cm	N/A
C-4	USB Cable (FTP)	NO	120cm	N/A

Note:

- (1) The support equipment was authorized by Declaration of Confirmation.
- (2) For detachable type I/O cable should be specified the length in cm in 『Length』 column.
- (3) “YES” is means “shielded” “with core”; “NO” is means “unshielded” “without core”.
- (4) PC is the FCC DOC is approved.



2.5 EQUIPMENTS LIST FOR ALL TEST ITEMS

The EUT has been tested as an independent unit together with other necessary accessories or support units. The following support units or accessories were used to form a representative test configuration during the tests.

Radiation Test equipment

Kind of Equipment	Manufacturer	Type No.	Serial No.	Last Calibration	Calibrated Until
EMI Test Receiver	R&S	ESCI	101427	2016.10.23	2017.10.22
Bilog Antenna	TESEQ	CBL6111D	34678	2017.03.24	2018.03.23
Horn Antenna	SCHWARZBECK	BBHA 9120D(1201)	9120D-1343	2017.03.06	2018.03.05
Power Amplifier	Agilent	8449B	60538	2016.10.23	2017.10.22
Spectrum Analyzer	Agilent	E4407B	MY50140340	2016.10.25	2017.10.24
Pre-mpplier(0.1M-3 GHz)	EM	EM330	60538	2017.03.12	2018.03.11
Spectrum Analyzer	Agilent	N9020A	MY49100060	2017.03.11	2018.03.10
EMI Test Receiver	ESW	R&S	101535	2017.06.01	2018.05.31

Conduction Test equipment

Kind of Equipment	Manufacturer	Type No.	Serial No.	Last Calibration	Calibrated Until
EMI Test Receiver	R&S	ESPI	102086	2016.10.23	2017.10.22
LISN	R&S	ENV216	101242	2016.10.26	2017.10.25
LISN	EMCO	3810/2NM	000-23625	2016.10.26	2017.10.25
Absorbing clamp	R&S	MDS-21	100668	2016.10.23	2017.10.22



3. EMC EMISSION TEST

3.1 CONDUCTED EMISSION MEASUREMENT

3.1.1 POWER LINE CONDUCTED EMISSION Limits

FREQUENCY (MHz)	Conducted Emission Limits (dBuV)			
	Class A		Class B	
	Quasi-peak	Average	Quasi-peak	Average
0.15 -0.5	79.00	66.00	66 - 56 *	56 - 46 *
0.50 -5.0	73.00	60.00	56.00	46.00
5.0 -30.0	73.00	60.00	60.00	50.00

Note:

- (1) The tighter limit applies at the band edges.
- (2) The limit of " * " marked band means the limitation decreases linearly with the logarithm of the frequency in the range.

The following table is the setting of the receiver

Receiver Parameters	Setting
Attenuation	10 dB
Start Frequency	0.15 MHz
Stop Frequency	30 MHz
IF Bandwidth	9 kHz

3.1.2 TEST PROCEDURE

- The EUT was 0.8 meters from the horizontal ground plane and 0.4 meters from the vertical ground plane with EUT being connected to the power mains through a line impedance stabilization network (LISN). All other support equipments powered from additional LISN(s). The LISN provide 50 Ohm/ 50uH of coupling impedance for the measuring instrument.
- Interconnecting cables that hang closer than 40 cm to the ground plane shall be folded back and forth in the center forming a bundle 30 to 40 cm long.
 - I/O cables that are not connected to a peripheral shall be bundled in the center. The end of the cable may be terminated, if required, using the correct terminating impedance. The overall length shall not exceed 1 m.
 - LISN at least 80 cm from nearest part of EUT chassis.
 - For the actual test configuration, please refer to the related Item –EUT Test Photos.

3.1.3 DEVIATION FROM TEST STANDARD

No deviation

3.1.4 TEST SETUP

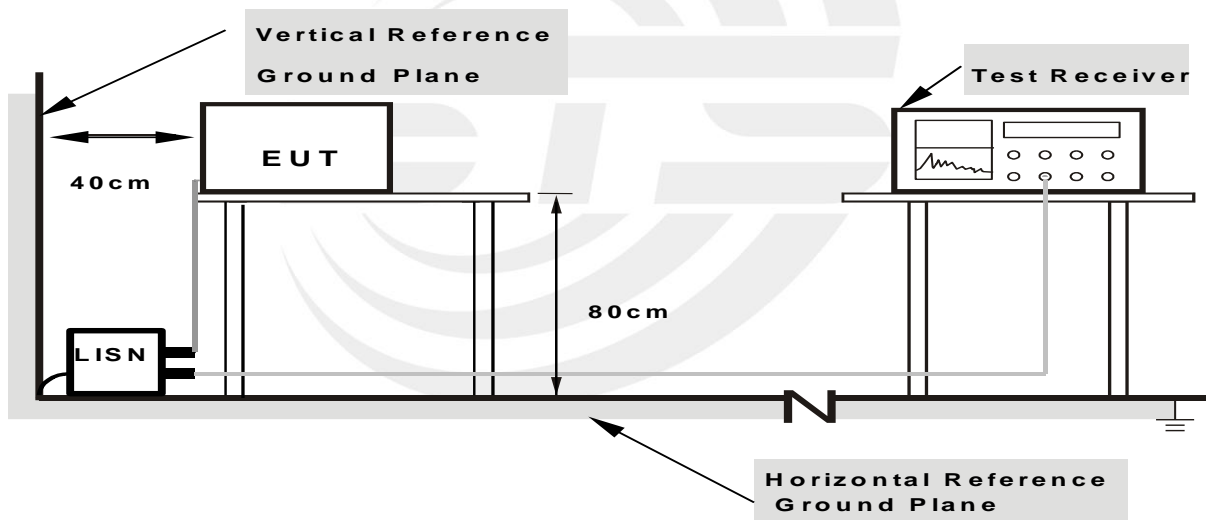

- Note: 1.Support units were connected to second LISN.**
2.Both of LISNs (AMN) are 80 cm from EUT and at least 80 from other units and other metal planes

3.1.5 EUT OPERATING CONDITIONS

The EUT was configured for testing in a typical fashion (as a customer would normally use it). The EUT has been programmed to continuously transmit during test. This operating condition was tested and used to collect the included data.



3.1.6 TEST RESULTS

Temperature:	25.4 °C	Relative Humidity:	60%
Pressure:	1010hPa	Phase:	L
Test Voltage:	AC 120V/60Hz	Test Mode:	Mode 1

No.	Frequency (MHz)	Reading (dBuV)	Factor (dB)	Result (dBuV)	Limit (dBuV)	Margin (dB)	Detector
1	0.1540	45.80	9.79	55.59	65.78	-10.19	QP
2	0.1540	21.40	9.79	31.19	55.78	-24.59	AVG
3	0.5140	25.24	10.02	35.26	56.00	-20.74	QP
4	0.5140	11.64	10.02	21.66	46.00	-24.34	AVG
5	0.9780	26.52	9.80	36.32	56.00	-19.68	QP
6	0.9780	11.65	9.80	21.45	46.00	-24.55	AVG
7	1.6860	39.01	9.79	48.80	56.00	-7.20	QP
8	1.6860	21.09	9.79	30.88	46.00	-15.12	AVG
9	6.3660	32.64	9.87	42.51	60.00	-17.49	QP
10	6.3660	17.36	9.87	27.23	50.00	-22.77	AVG
11	9.0340	30.58	10.10	40.68	60.00	-19.32	QP
12	9.0340	19.71	10.10	29.81	50.00	-20.19	AVG

Remark:

1. All readings are Quasi-Peak and Average values.
2. Margin = Result (Result = Reading + Factor) – Limit

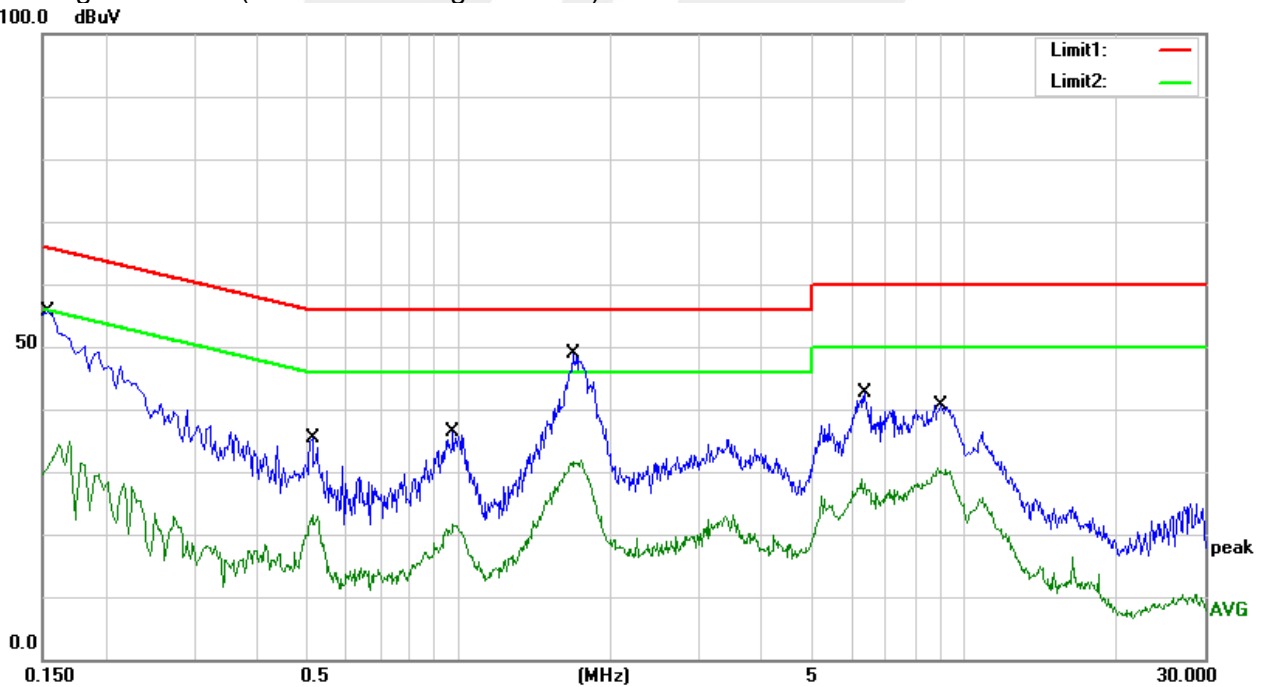



Temperature:	25.4 °C	Relative Humidity:	60%
Pressure:	1010hPa	Phase:	N
Test Voltage:	AC 120V/60Hz	Test Mode:	Mode 1

No.	Frequency (MHz)	Reading (dBUV)	Factor (dB)	Result (dBUV)	Limit (dBUV)	Margin (dB)	Detector
1	0.1500	45.02	9.75	54.77	66.00	-11.23	QP
2	0.1500	16.60	9.75	26.35	56.00	-29.65	AVG
3	0.4060	25.47	10.06	35.53	57.73	-22.20	QP
4	0.4060	5.72	10.06	15.78	47.73	-31.95	AVG
5	0.9900	27.63	9.80	37.43	56.00	-18.57	QP
6	0.9900	9.50	9.80	19.30	46.00	-26.70	AVG
7	1.7740	39.54	9.85	49.39	56.00	-6.61	QP
8	1.7740	19.60	9.85	29.45	46.00	-16.55	AVG
9	3.4300	25.14	9.92	35.06	56.00	-20.94	QP
10	3.4300	10.56	9.92	20.48	46.00	-25.52	AVG
11	6.2820	31.31	9.90	41.21	60.00	-18.79	QP
12	6.2820	17.46	9.90	27.36	50.00	-22.64	AVG

Remark:

1. All readings are Quasi-Peak and Average values.
2. Margin = Result (Result =Reading + Factor)–Limit

100.0 dBUV

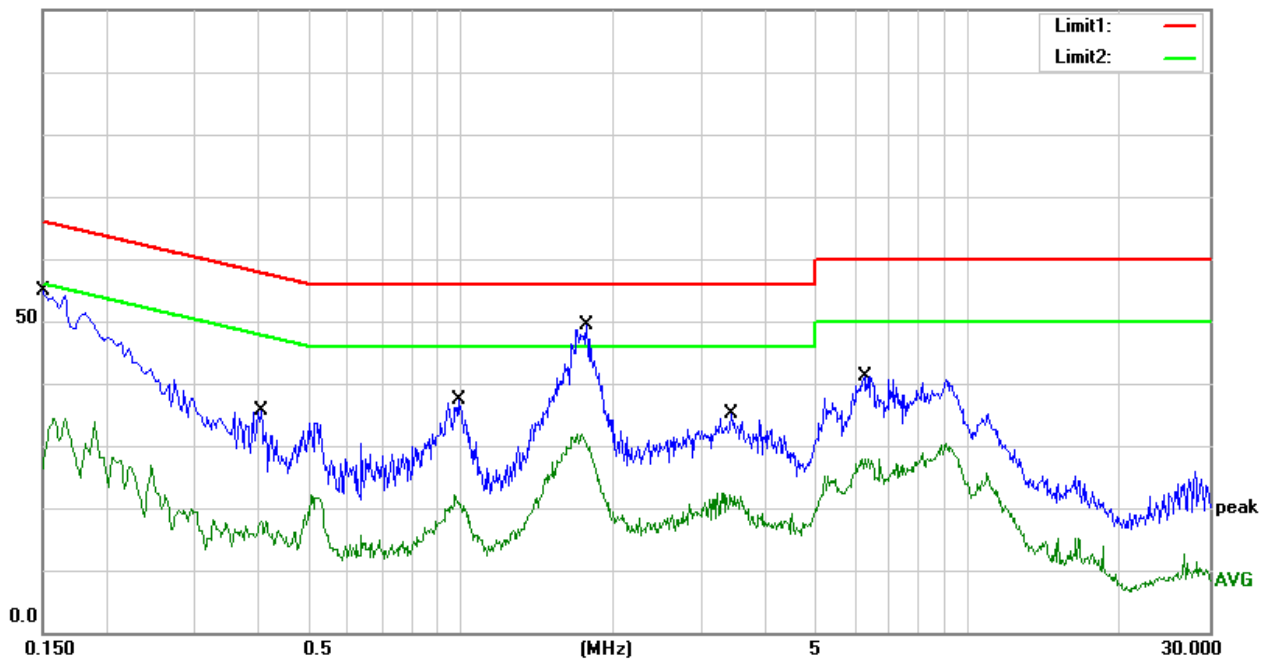

Note: The test voltage is 100-240V, both of which have assessment tests, and the worst test data is in the report.



3.2 RADIATED EMISSION MEASUREMENT

3.2.1 Radiated Emission Limits

In case the emission fall within the restricted band specified on 15.105(a)&109(a) limit in the table below has to be followed.

Frequencies (MHz)	Field Strength (micorvolts/meter)	Measurement Distance (meters)
30~88	100	3
88~216	150	3
216~960	200	3
Above 960	500	3

LIMITS OF RADIATED EMISSION MEASUREMENT

FREQUENCY (MHz)	Class A (dBuV/m) (at 3M)		Class B (dBuV/m) (at 3M)	
	PEAK	AVERAGE	PEAK	AVERAGE
Above 1000	80	60	74	54

Note:

- (1) The limit for radiated test was performed according to FCC PART 15B.
- (2) The tighter limit applies at the band edges.
- (3) Emission level (dBuV/m)=20log Emission level (uV/m).

FREQUENCY RANGE OF RADIATED MEASUREMENT (For unintentional radiators)

Highest frequency generated or Upper frequency of measurement used in the device or on which the device operates or tunes (MHz)	Range (MHz)
Below 1.705	30
1.705 – 108	1000
108 – 500	2000
500 – 1000	5000
Above 1000	5th harmonic of the highest frequency or 40 GHz, whichever is lower



Spectrum Parameter	Setting
Attenuation	Auto
Detector	Peak
Start Frequency	1000 MHz(Peak/AV)
Stop Frequency	5th harmonic (Peak/AV)
RB / VB (emission in restricted band)	30MHz to 1000MHz: 100 KHz / 300 KHz Above 1000MHz: 1 MHz / 3 MHz

Receiver Parameter	Setting
Attenuation	Auto
Start ~ Stop Frequency	30MHz to 1000MHz: 100 KHz / 300 KHz Above 1000MHz: 1 MHz / 3 MHz

3.2.2 TEST PROCEDURE

- a. The measuring distance of at 3 m shall be used for measurements at frequency up to 1GHz and above 1GHz.

The EUT was placed on the top of a rotating table 0.8 meters above the ground at a 3 meter anechoic chamber. The table was rotated 360 degrees to determine the position of the highest radiation.

- c. the height of the antenna shall vary between 1m to 4 m. Both horizontal and vertical polarizations of the antenna are set to make the measurement.

The initial step in collecting conducted emission data is a spectrum analyzer peak detector mode pre-scanning the measurement frequency range. Significant peaks are then marked and then Quasi Peak detector mode re-measured.

If the Peak Mode measured value compliance with and lower than Quasi Peak Mode Limit, the EUT shall be deemed to meet QP Limits and then no additional QP Mode measurement performed.

- f. For the actual test configuration, please refer to the related Item –EUT Test Photos.

Note: Both horizontal and vertical antenna polarities were tested and performed pretest to three orthogonal axis. The worst case emissions were reported

3.2.3 DEVIATION FROM TEST STANDARD

No deviation

3.2.4 TEST SETUP

(A) Radiated Emission Test-Up Frequency 30MHz~1GHz

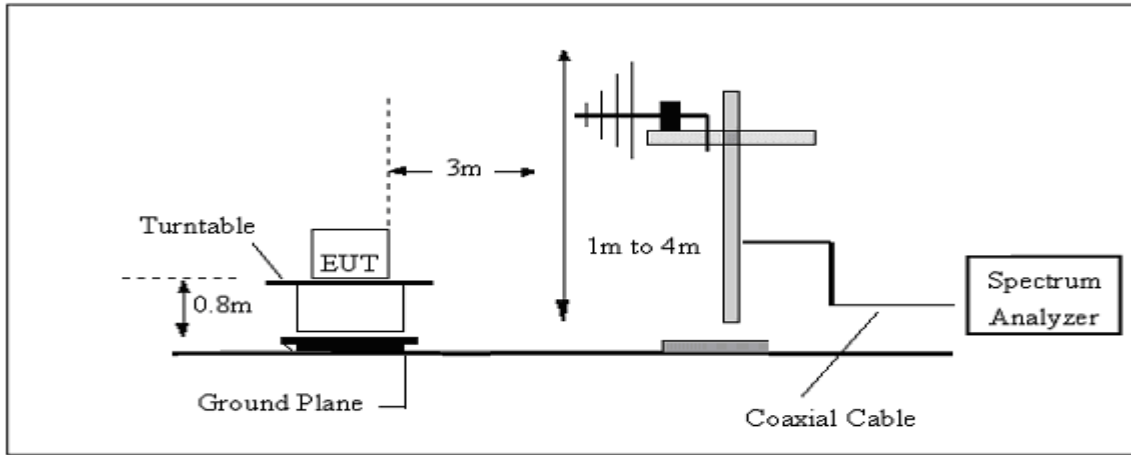

(B) Radiated Emission Test-Up Frequency Above 1GHz

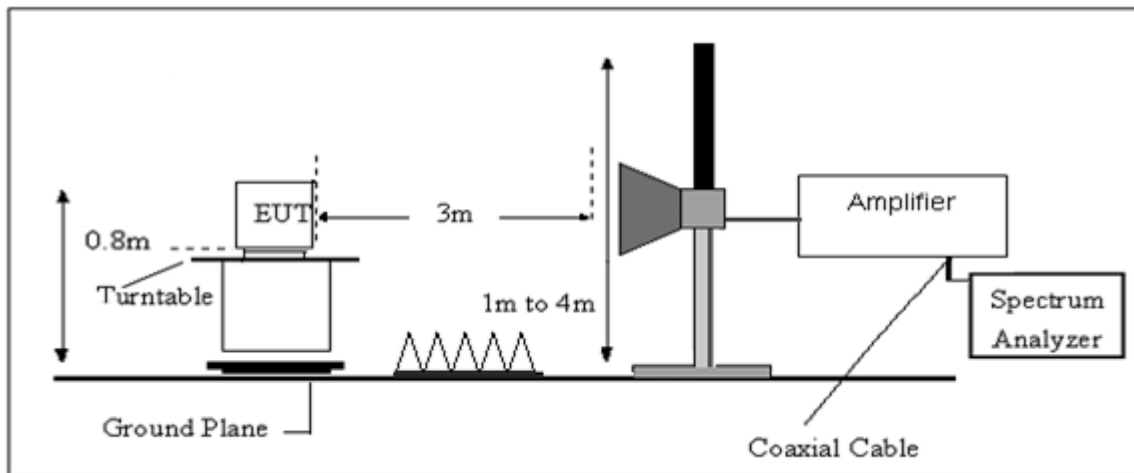

3.2.5 EUT OPERATING CONDITIONS

The EUT tested system was configured as the statements of 2.4 Unless otherwise a special operating condition is specified in the follows during the testing.



3.2.6 TEST RESULTS

30MHz -1000MHz

Temperature:	24.9 °C	Relative Humidity:	56%
Pressure:	1010hPa	Phase:	Horizontal
Test Voltage:	AC 120V/60Hz	Test Mode:	Mode 1

No.	Frequency (MHz)	Reading (dBuV)	Factor (dB)	Results (dBuV/m)	Limit (dBuV/m)	Margin (dB)	Detector
1	75.1822	47.17	-23.37	23.80	40.00	-16.20	QP
2	135.0320	44.96	-17.52	27.44	43.50	-16.06	QP
3	196.5098	51.41	-20.20	31.21	43.50	-12.29	QP
4	239.9873	52.07	-17.76	34.31	46.00	-11.69	QP
5	336.0352	49.72	-14.05	35.67	46.00	-10.33	QP
6	528.2458	43.39	-8.09	35.30	46.00	-10.70	QP

Remark:

1. Margin = Result (Result =Reading + Factor)–Limit

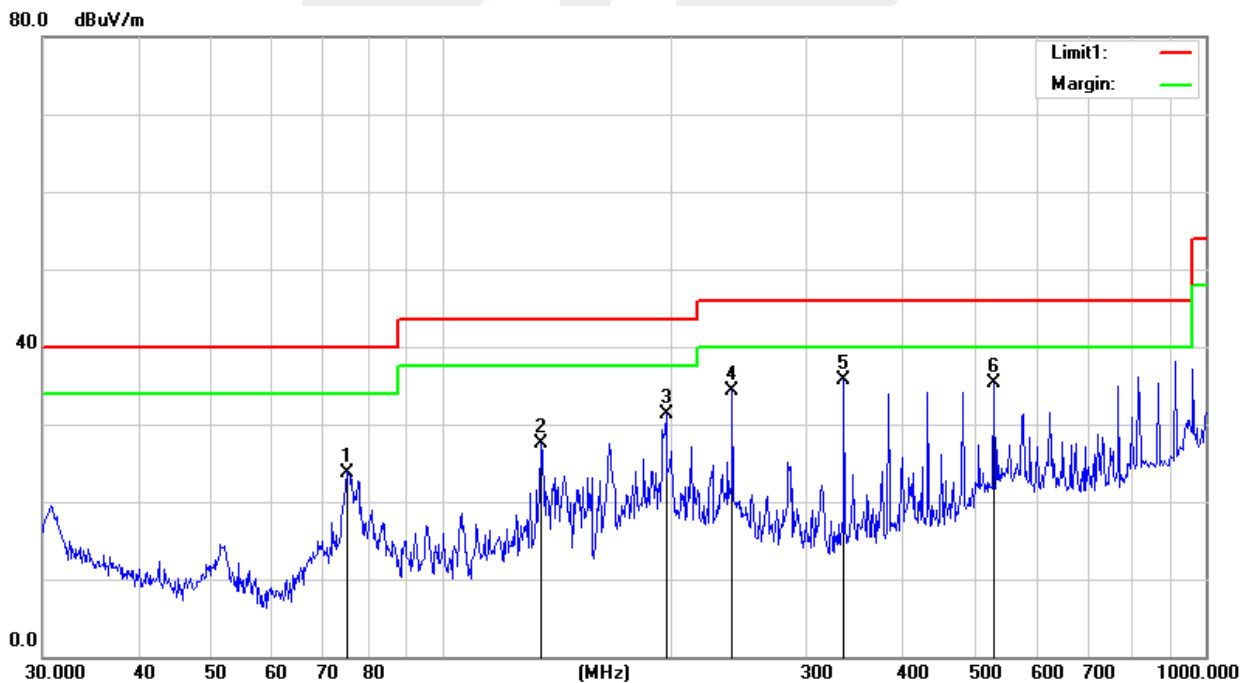



Temperature:	24.9 °C	Relative Humidity:	56%
Pressure:	1010hPa	Phase:	Vertical
Test Voltage:	AC 120V/60Hz	Test Mode:	Mode 1

No.	Frequency (MHz)	Reading (dBuV)	Factor (dB)	Results (dBuV/m)	Limit (dBuV/m)	Margin (dB)	Detector
1	75.1822	41.77	-23.37	18.40	40.00	-21.60	QP
2	199.2855	42.63	-20.17	22.46	43.50	-21.04	QP
3	336.0352	44.62	-14.05	30.57	46.00	-15.43	QP
4	432.5457	43.86	-10.89	32.97	46.00	-13.03	QP
5	528.2458	44.97	-8.09	36.88	46.00	-9.12	QP
6	815.9678	42.14	-3.51	38.63	46.00	-7.37	QP

Remark:

1. Margin = Result (Result = Reading + Factor) - Limit

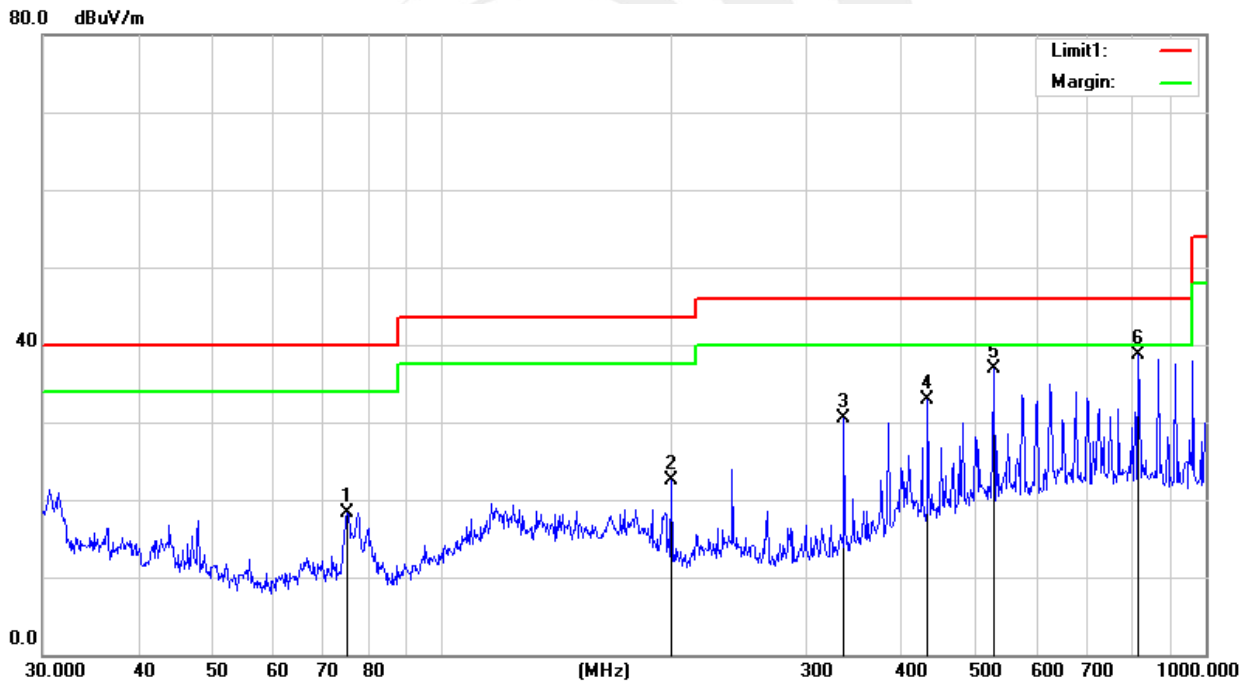



(1 GHz to 25GHz.)

Temperature:	26 °C	Relative Humidity:	54%
Pressure:	1010hPa	Phase:	Vertical/Horizontal
Test Voltage:	AC 120V/60Hz	Test Mode:	Mode 1

PK

Freq.	Ant. Pol	Peak	Amplifier	Loss	Antenna Factor	Orrected Factor	Actual Fs	Peak	Peak
(MHz)	H/V	Reading (dBuV)	(dB)	(dB)	(dB/m)	(dB)	Peak (dBuV/m)	Limit (dBuV/m)	margin (dB)
2005.3	H	58.45	43.8	5.4	25.9	-12.5	45.95	74	-28.05
2508.6	H	50.36	44.4	6	27.6	-10.8	39.56	74	-34.44
3000.4	H	51.26	44.7	6.7	28.2	-9.8	41.46	74	-32.54
4400.8	H	53.69	44.3	8.42	30.4	-5.48	48.21	74	-25.79
2005.3	V	52.56	43.8	5.4	25.9	-12.5	40.06	74	-33.94
2508.6	V	47.44	44.4	6	27.6	-10.8	36.64	74	-37.36
3000.4	V	50.02	44.7	6.7	28.2	-9.8	40.22	74	-33.78
4400.8	V	47.16	44.3	8.42	30.4	-5.48	41.68	74	-32.32
5506.84	V	37.46	44.2	9.7	32	-2.5	34.96	74	-39.04

AV

Freq.	Ant. Pol	AV	Amplifier	Loss	Antenna Factor	Orrected Factor	AV	AV	AV
(MHz)	H/V	Reading (dBuV)	(dB)	(dB)	(dB/m)	(dB)	AV (dBuV/m)	Limit (dBuV/m)	margin (dB)
1403.35	H	46.35	45.1	4	25.1	-16	30.35	54	-23.65
3000.76	H	48.54	44.7	6.7	28.2	-9.8	38.74	54	-15.26
4002.47	H	51.65	44.2	7.9	29.7	-6.6	45.05	54	-8.95
5506.84	H	49.26	44.2	9.7	32	-2.5	46.76	54	-7.24
N/A									
1403.35	V	37.15	45.1	4	25.1	-16	21.15	54	-32.85
3000.76	V	43.65	44.7	6.7	28.2	-9.8	33.85	54	-22.21
4002.47	V	36.21	44.2	7.9	29.7	-6.6	26.97	54	-27.03
5506.84	V	35.26	44.2	9.7	32	-2.5	32.76	54	-21.24



Notes:

1. Measuring frequencies from 1 GHz to 25GHz.
2. Radiated emissions measured in frequency above 1000MHz were made with an instrument using Peak detector mode of the emission shown in Actual FS column.
3. The frequency that above 5.5GHz is mainly from the environment noise.



4. PHOTOS OF TEST SETUP

Radiated Measurement Photos

30MHz- 1GHz

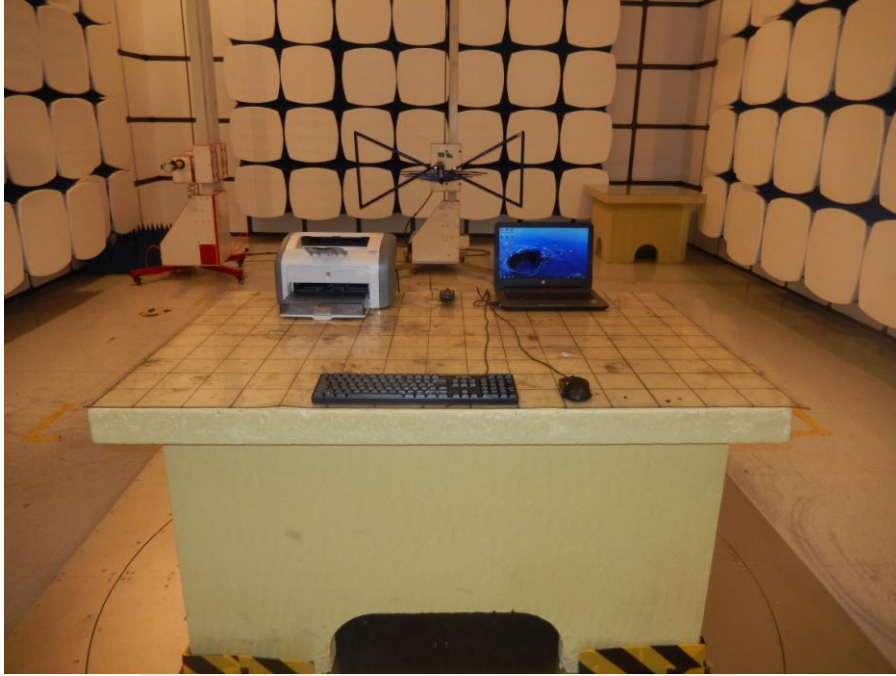

Above 1GHz



Conducted Measurement Photos

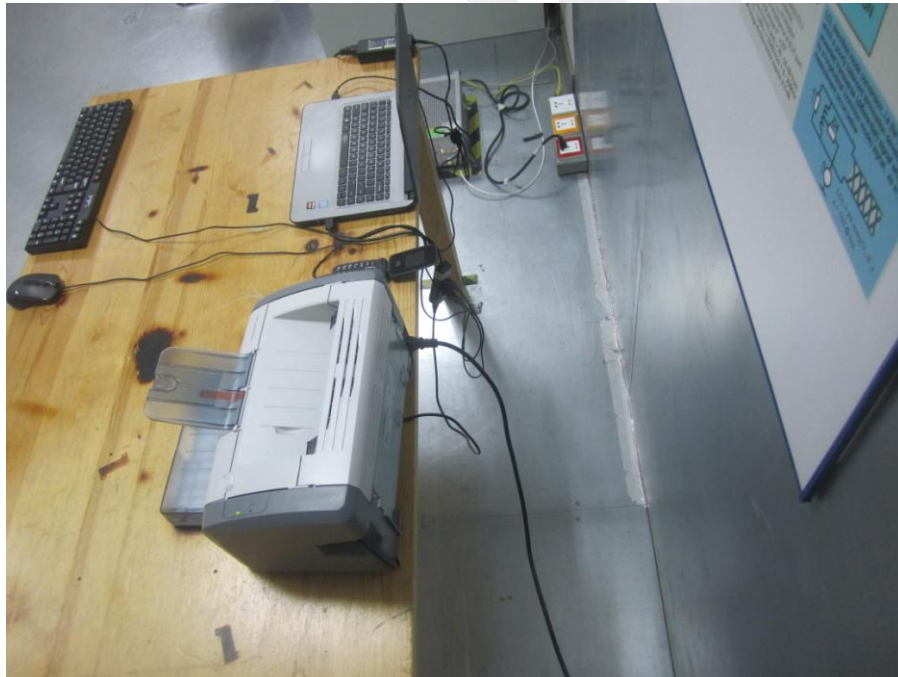

*****END OF THE REPORT*****