

## 6.10. Conducted Spurious Emission Measurement

### 6.10.1. Test Specification

<b>Test Requirement:</b>	FCC Part15 C Section 15.247 (d)
<b>Test Method:</b>	ANSI C63.10:2013
<b>Limit:</b>	In any 100 kHz bandwidth outside the intentional radiation frequency band, the radio frequency power shall be at least 20 dB below the highest level of the radiated power. In addition, radiated emissions which fall in the restricted bands must also comply with the radiated emission limits.
<b>Test Setup:</b>	 <p style="text-align: center;">Spectrum Analyzer                      EUT</p>
<b>Test Mode:</b>	Transmitting mode with modulation
<b>Test Procedure:</b>	<ol style="list-style-type: none"> <li>1. The testing follows the guidelines in Spurious RF Conducted Emissions of ANSI C63.10:2013 Measurement Guidelines</li> <li>2. The RF output of EUT was connected to the spectrum analyzer by RF cable and attenuator. The path loss was compensated to the results for each measurement.</li> <li>3. Set to the maximum power setting and enable the EUT transmit continuously.</li> <li>4. Set RBW = 100 kHz, VBW = 300kHz, scan up through 10th harmonic. All harmonics / spurs must be at least 20 dB down from the highest emission level within the authorized band as measured with a 100 kHz RBW.</li> <li>5. Measure and record the results in the test report.</li> <li>6. The RF fundamental frequency should be excluded against the limit line in the operating frequency band.</li> </ol>
<b>Test Result:</b>	PASS

### 6.10.2. Test Instruments

Equipment	Manufacturer	Model	Serial Number	Calibration Due
Spectrum Analyzer	Agilent	N9020A	MY49100060	Sep. 27, 2018
Spectrum Analyzer	ROHDE&SCHWARZ	FSQ	200061	Sep. 27, 2018
RF Cable (9KHz-26.5GHz)	TCT	RE-06	N/A	Sep. 27, 2018
Antenna Connector	TCT	RFC-01	N/A	Sep. 27, 2018

**Note:** The calibration interval of the above test instruments is 12 months and the calibrations are traceable to international system unit (SI).

6.10.3. Test Data

GFSK mode

Lowest Channel

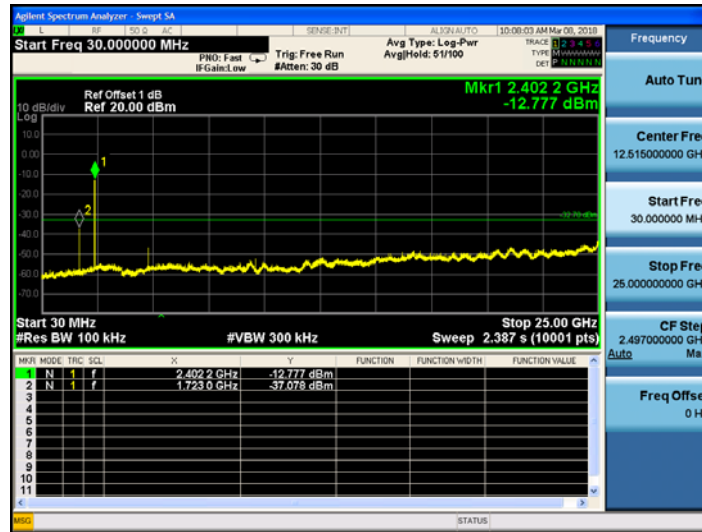

Middle Channel

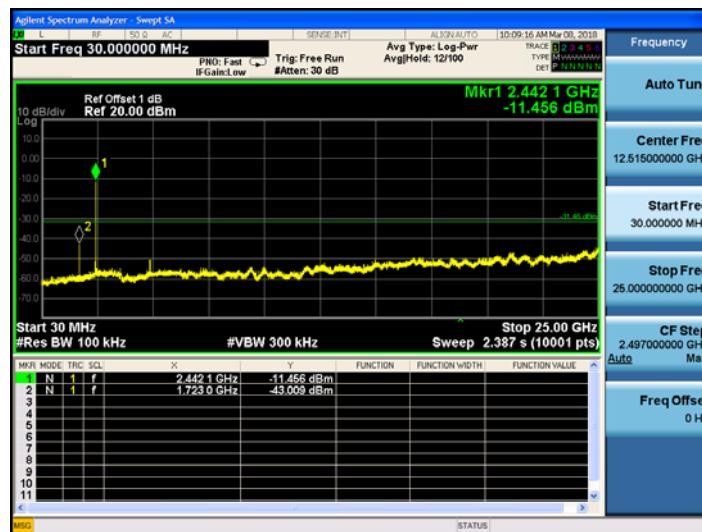

Highest Channel



Pi/4DQPSK mode

Lowest Channel

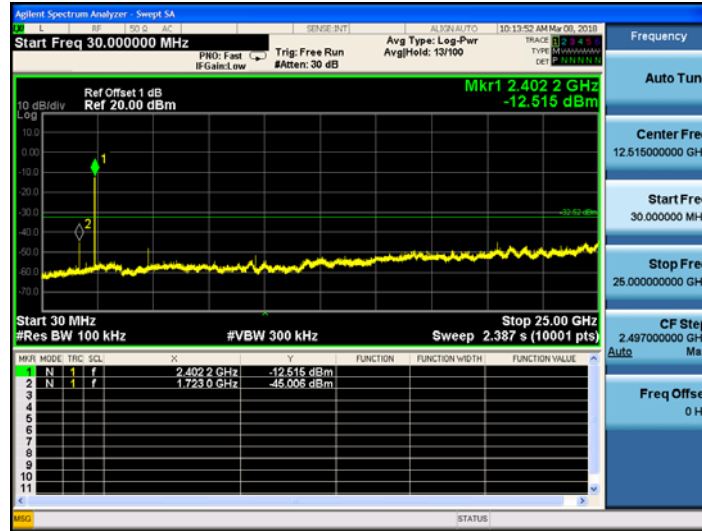

Middle Channel

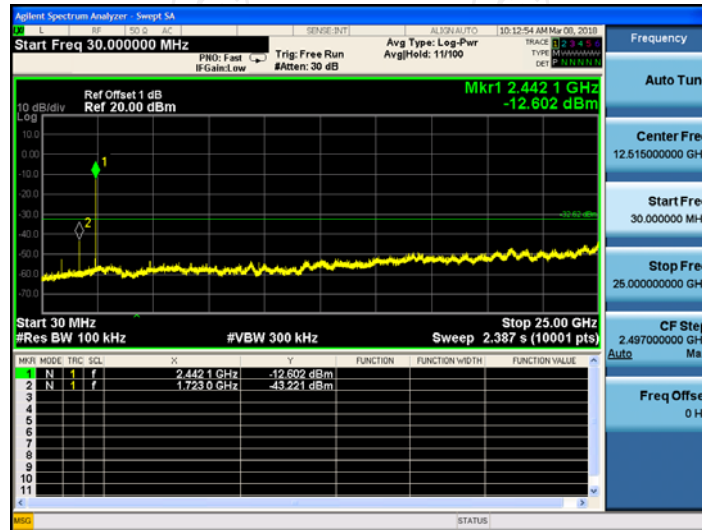

Highest Channel

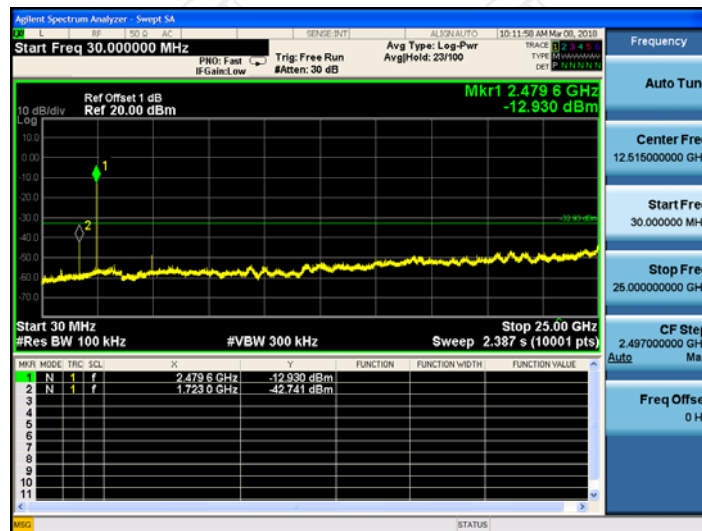

## 6.11. Radiated Spurious Emission Measurement

### 6.11.1. Test Specification

<b>Test Requirement:</b>	FCC Part15 C Section 15.209				
<b>Test Method:</b>	ANSI C63.10:2013				
<b>Frequency Range:</b>	9 kHz to 25 GHz				
<b>Measurement Distance:</b>	3 m				
<b>Antenna Polarization:</b>	Horizontal & Vertical				
<b>Receiver Setup:</b>	Frequency	Detector	RBW	VBW	Remark
	9kHz- 150kHz	Quasi-peak	200Hz	1kHz	Quasi-peak Value
	150kHz- 30MHz	Quasi-peak	9kHz	30kHz	Quasi-peak Value
	30MHz-1GHz	Quasi-peak	100KHz	300KHz	Quasi-peak Value
	Above 1GHz	Peak	1MHz	3MHz	Peak Value
		Peak	1MHz	10Hz	Average Value
<b>Limit:</b>	Frequency	Field Strength (microvolts/meter)	Measurement Distance (meters)		
	0.009-0.490	2400/F(KHz)	300		
	0.490-1.705	24000/F(KHz)	30		
	1.705-30	30	30		
	30-88	100	3		
	88-216	150	3		
	216-960	200	3		
	Above 960	500	3		
	Frequency	Field Strength (microvolts/meter)	Measurement Distance (meters)	Detector	
	Above 1GHz	500	3	Average	
		5000	3	Peak	
<b>Test setup:</b>	For radiated emissions below 30MHz				
	<p>Distance = 3m</p> <p>EUT</p> <p>Turn table</p> <p>Ground Plane</p> <p>Computer</p> <p>Pre -Amplifier</p> <p>Receiver</p>				
	30MHz to 1GHz				

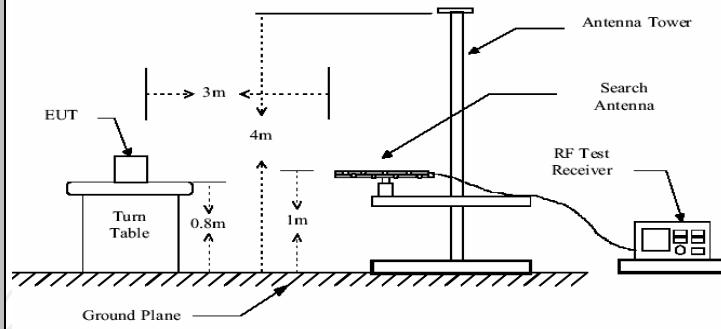

Above 1GHz

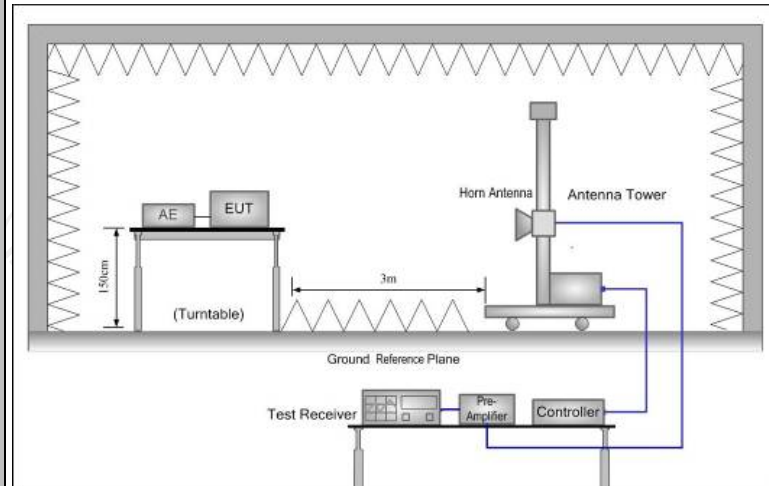

**Test Mode:**

Transmitting mode with modulation

**Test Procedure:**

1. The testing follows the guidelines in Spurious Radiated Emissions of ANSI C63.10:2013 Measurement Guidelines.
2. For the radiated emission test below 1GHz:  
The EUT was placed on a turntable with 0.8 meter above ground. The EUT was set 3 meters from the interference receiving antenna, which was mounted on the top of a variable height antenna tower. The EUT was arranged to its worst case and then tune the antenna tower (from 1 m to 4 m) and turntable (from 0 degree to 360 degrees) to find the maximum reading. A pre-amp and a high PASS filter are used for the test in order to get better signal level.
- For the radiated emission test above 1GHz:  
Place the measurement antenna on a turntable with 1.5 meter above ground, which is away from each area of the EUT determined to be a source of emissions at the specified measurement distance, while keeping the measurement antenna aimed at the source of emissions at each frequency of significant emissions, with polarization oriented for maximum response. The measurement antenna may have to be higher or lower than the EUT,

	<p>depending on the radiation pattern of the emission and staying aimed at the emission source for receiving the maximum signal. The final measurement antenna elevation shall be that which maximizes the emissions. The measurement antenna elevation for maximum emissions shall be restricted to a range of heights of from 1 m to 4 m above the ground or reference ground plane.</p> <p>3. Set to the maximum power setting and enable the EUT transmit continuously.</p> <p>4. Use the following spectrum analyzer settings:</p> <p>(1) Span shall wide enough to fully capture the emission being measured;</p> <p>(2) Set RBW=100 kHz for <math>f &lt; 1</math> GHz, RBW=1MHz for <math>f &gt; 1</math>GHz ; VBW<math>\geq</math>RBW; Sweep = auto; Detector function = peak; Trace = max hold for peak</p> <p>(3) For average measurement: use duty cycle correction factor method per 15.35(c). Duty cycle = On time/100 milliseconds On time = <math>N_1 * L_1 + N_2 * L_2 + \dots + N_{n-1} * L_{n-1} + N_n * L_n</math> Where <math>N_1</math> is number of type 1 pulses, <math>L_1</math> is length of type 1 pulses, etc. Average Emission Level = Peak Emission Level + <math>20 * \log(\text{Duty cycle})</math></p> <p>Corrected Reading: Antenna Factor + Cable Loss + Read Level - Preamp Factor = Level</p>
<b>Test results:</b>	PASS

6.11.2. Test Instruments

Radiated Emission Test Site (966)				
Name of Equipment	Manufacturer	Model	Serial Number	Calibration Due
Test Receiver	ROHDE&SCHW ARZ	ESVD	100008	Sep. 27, 2018
Spectrum Analyzer	ROHDE&SCHW ARZ	FSQ	200061	Sep. 27, 2018
Pre-amplifier	EM Electronics Corporation CO.,LTD	EM30265	07032613	Sep. 27, 2018
Pre-amplifier	HP	8447D	2727A05017	Sep. 27, 2018
Loop antenna	ZHINAN	ZN30900A	12024	Sep. 27, 2018
Broadband Antenna	Schwarzbeck	VULB9163	340	Sep. 27, 2018
Horn Antenna	Schwarzbeck	BBHA 9120D	631	Sep. 27, 2018
Horn Antenna	Schwarzbeck	BBH 9170	582	Jun. 07, 2018
Antenna Mast	Keleto	CC-A-4M	N/A	N/A
Coax cable (9KHz-1GHz)	TCT	RE-low-01	N/A	Sep. 27, 2018
Coax cable (9KHz-40GHz)	TCT	RE-high-02	N/A	Sep. 27, 2018
Coax cable (9KHz-1GHz)	TCT	RE-low-03	N/A	Sep. 27, 2018
Coax cable (9KHz-40GHz)	TCT	RE-high-04	N/A	Sep. 27, 2018
EMI Test Software	Shurple Technology	EZ-EMC	N/A	N/A

**Note:** The calibration interval of the above test instruments is 12 months and the calibrations are traceable to international system unit (SI).

6.11.3. Test Data

Duty cycle correction factor for average measurement

2DH5 on time (One Pulse) Plot on Channel 00

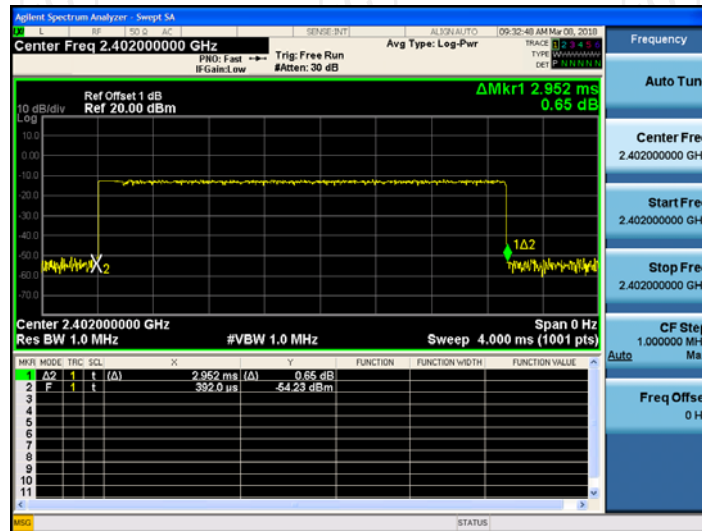

2DH5 on time (Count Pulses) Plot on Channel 00

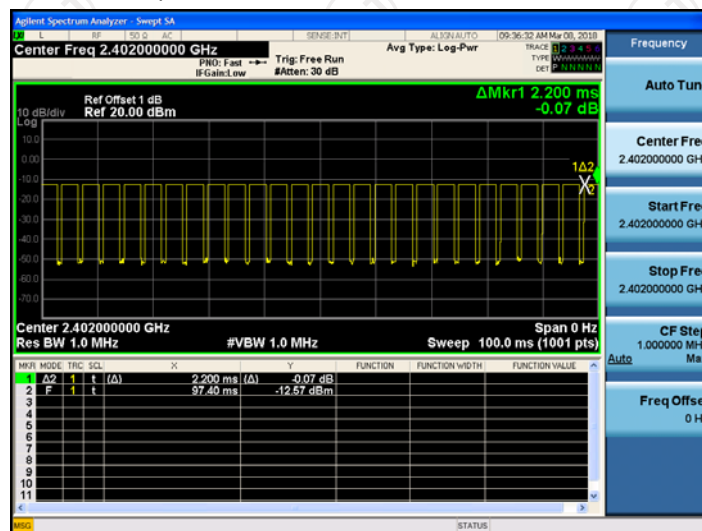

**Note:**

1. Worst case Duty cycle = on time/100 milliseconds = (2.952\*26+2.200)/100= 0.7895
2. Worst case Duty cycle correction factor = 20\*log (Duty cycle) = -2.05dB
3. 2DH5 has the highest duty cycle worst case and is reported.
4. The average levels were calculated from the peak level corrected with duty cycle correction factor (-2.05dB) derived from 20log (dwell time/100ms). This correction is only for signals that hop with the fundamental signal, such as band-edge and harmonic. Other spurious signals that are independent of the hopping signal would not use this correction.



Please refer to following diagram for individual

Below 1GHz

Horizontal:

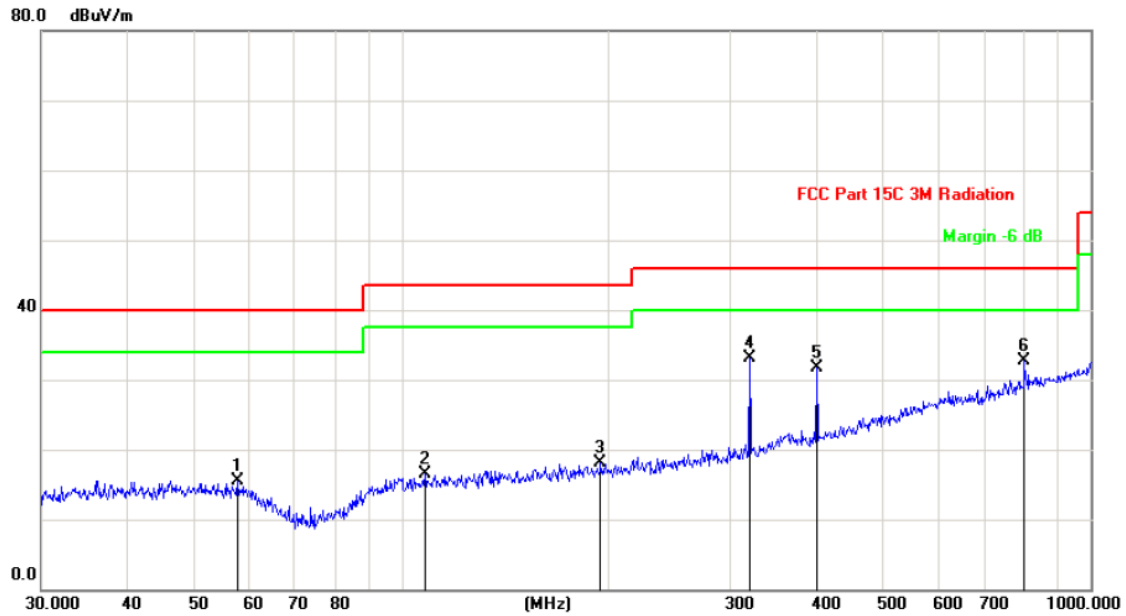

Site: Polarization: *Horizontal* Temperature: 25  
 Limit: FCC Part 15C 3M Radiation Power: DC 3.7V Humidity: 55 %

No.	Mk.	Freq.	Reading Level	Correct Factor	Measurement	Limit	Over	Antenna Height	Table Degree	
		MHz	dBuV	dB	dBuV/m	dB/m	dB	cm	degree	Comment
1		57.7962	28.79	-13.26	15.53	40.00	-24.47	peak		
2		108.2667	28.93	-12.38	16.55	43.50	-26.95	peak		
3		194.4534	31.15	-13.08	18.07	43.50	-25.43	peak		
4	*	319.9370	41.22	-8.11	33.11	46.00	-12.89	peak		
5		400.4319	37.46	-5.78	31.68	46.00	-14.32	peak		
6		801.7863	30.75	1.94	32.69	46.00	-13.31	peak		

Vertical:

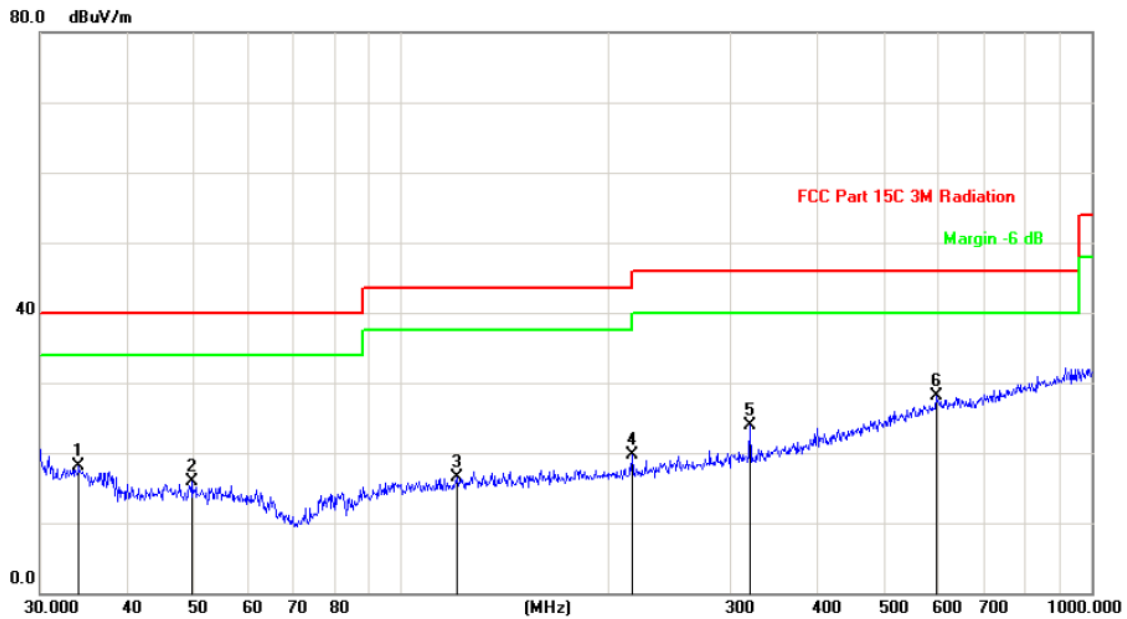

Site: Polarization: **Vertical** Temperature: 25  
 Limit: FCC Part 15C 3M Radiation Power: DC 3.7V Humidity: 55 %

No.	Mk.	Freq. MHz	Reading Level dBuV	Correct Factor dB	Measure- ment dBuV/m	Limit dB/m	Over dB	Antenna Height cm	Table Degree	Comment
1		34.1561	31.45	-13.40	18.05	40.00	-21.95	peak		
2		49.7068	28.49	-12.63	15.86	40.00	-24.14	peak		
3		120.2766	30.65	-14.23	16.42	43.50	-27.08	peak		
4		216.0240	31.82	-12.12	19.70	46.00	-26.30	peak		
5		319.9370	31.94	-8.11	23.83	46.00	-22.17	peak		
6	*	595.1329	28.90	-0.88	28.02	46.00	-17.98	peak		

**Note:** 1. The low frequency, which started from 9KHz~30MHz, was pre-scanned and the result which was 20dB lower than the limit line per 15.31(o) was not reported

2. Measurements were conducted in all three channels (high, middle, low) and two modulation (GFSK, Pi/4 DQPSK) and the worst case Mode (Middle channel and Pi/4DQPSK) was submitted only.

## Above 1GHz

Modulation Type: Pi/4DQPSK									
Low channel: 2402 MHz									
Frequency (MHz)	Ant. Pol. H/V	Peak reading (dB $\mu$ V)	AV reading (dB $\mu$ V)	Correction Factor (dB/m)	Emission Level		Peak limit (dB $\mu$ V/m)	AV limit (dB $\mu$ V/m)	Margin (dB)
					Peak (dB $\mu$ V/m)	AV (dB $\mu$ V/m)			
2390	H	46.32	---	-8.27	38.05	---	74	54	-15.95
4804	H	49.51	---	0.66	50.17	---	74	54	-3.83
7206	H	39.32	---	9.50	48.82	---	74	54	-5.18
---	H	---	---	---	---	---	---	---	---
2390	V	43.85	---	-8.27	35.58	---	74	54	-18.42
4804	V	48.46	---	0.66	49.12	---	74	54	-4.88
7206	V	37.81	---	9.50	47.31	---	74	54	-6.69
---	V	---	---	---	---	---	---	---	---

Middle channel: 2441 MHz									
Frequency (MHz)	Ant. Pol. H/V	Peak reading (dB $\mu$ V)	AV reading (dB $\mu$ V)	Correction Factor (dB/m)	Emission Level		Peak limit (dB $\mu$ V/m)	AV limit (dB $\mu$ V/m)	Margin (dB)
					Peak (dB $\mu$ V/m)	AV (dB $\mu$ V/m)			
4882	H	41.48	---	0.99	42.47	---	74	54	-11.53
7323	H	38.81	---	9.87	48.68	---	74	54	-5.32
---	H	---	---	---	---	---	---	---	---
4882	V	42.72	---	0.99	43.71	---	74	54	-10.29
7323	V	39.29	---	9.87	49.16	---	74	54	-4.84
---	V	---	---	---	---	---	---	---	---

High channel: 2480 MHz									
Frequency (MHz)	Ant. Pol. H/V	Peak reading (dB $\mu$ V)	AV reading (dB $\mu$ V)	Correction Factor (dB/m)	Emission Level		Peak limit (dB $\mu$ V/m)	AV limit (dB $\mu$ V/m)	Margin (dB)
					Peak (dB $\mu$ V/m)	AV (dB $\mu$ V/m)			
2483.5	H	45.73	---	-7.83	37.90	---	74	54	-16.10
4960	H	48.75	---	1.33	50.08	---	74	54	-3.92
7440	H	38.41	---	10.22	48.63	---	74	54	-5.37
---	H	---	---	---	---	---	---	---	---
2483.5	V	48.03	---	-7.83	40.20	---	74	54	-13.80
4960	V	49.23	---	1.33	50.56	---	74	54	-3.44
7440	V	38.17	---	10.22	48.39	---	74	54	-5.61
---	V	---	---	---	---	---	---	---	---

**Note:**

1. Emission Level=Peak Reading + Correction Factor; Correction Factor= Antenna Factor + Cable loss – Pre-amplifier
2. Margin (dB) = Emission Level (Peak) (dB $\mu$ V/m)-Average limit (dB $\mu$ V/m)
3. The emission levels of other frequencies are very lower than the limit and not show in test report.
4. Measurements were conducted from 1 GHz to the 10th harmonic of highest fundamental frequency.
5. Data of measurement shown "----" in the above table mean that the reading of emissions is attenuated more than 20 dB below the limits or the field strength is too small to be measured.
6. Measurements were conducted in all two modulation (GFSK, Pi/4 DQPSK), and the worst case Mode (Pi/4DQPSK) was submitted only.

## Appendix A: Photographs of Test Setup

Product: Bluetooth Receiver

Model: WBA9-1007

Radiated Emission

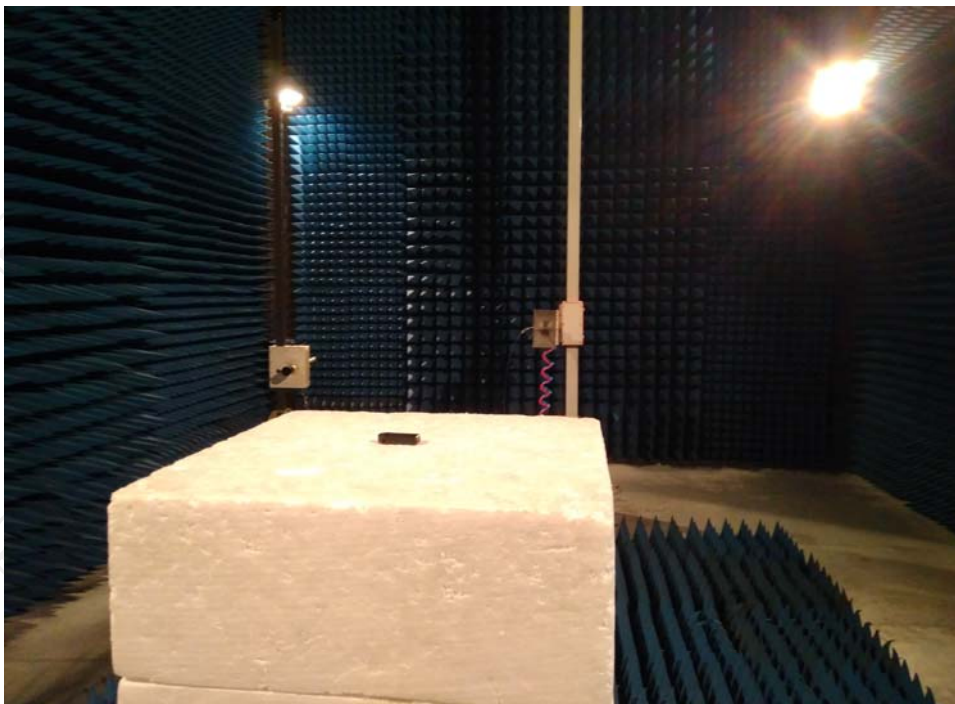
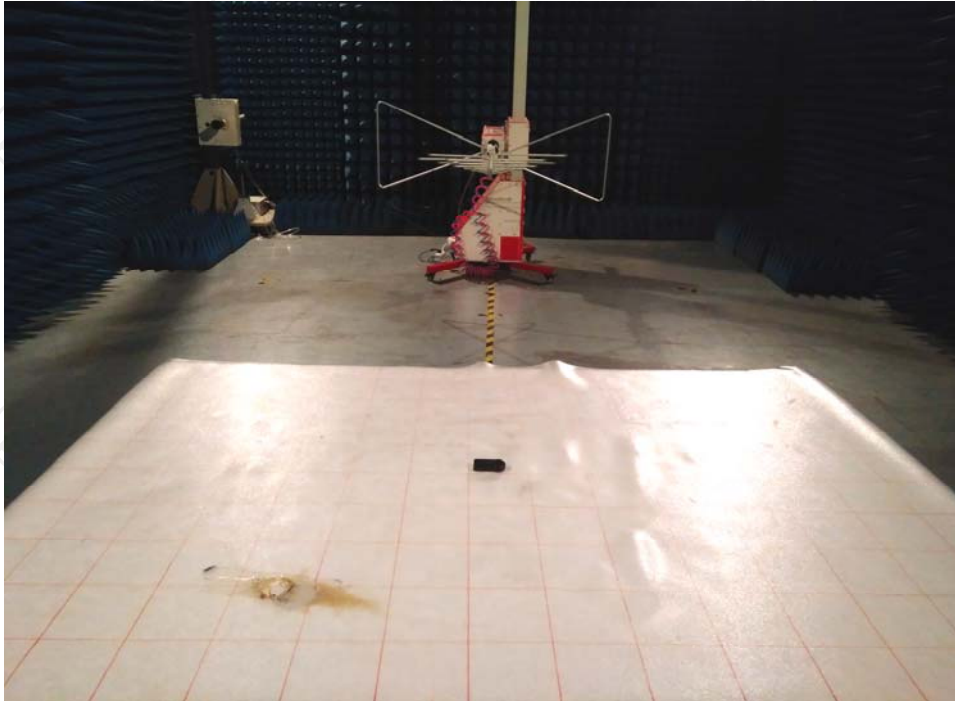

Conducted Emission

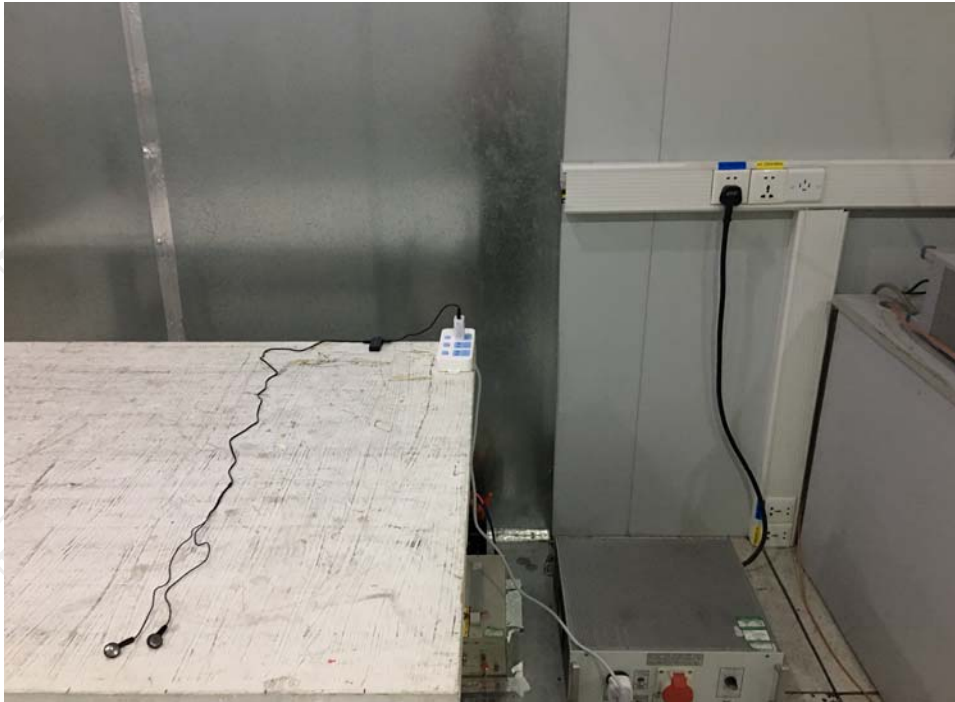

**Appendix B: Photographs of EUT**  
**Product: Bluetooth Receiver**  
**Model: WBA9-1007**  
**External Photos**











**Product: Bluetooth Receiver**  
**Model: WBA9-1007**  
**Internal Photos**

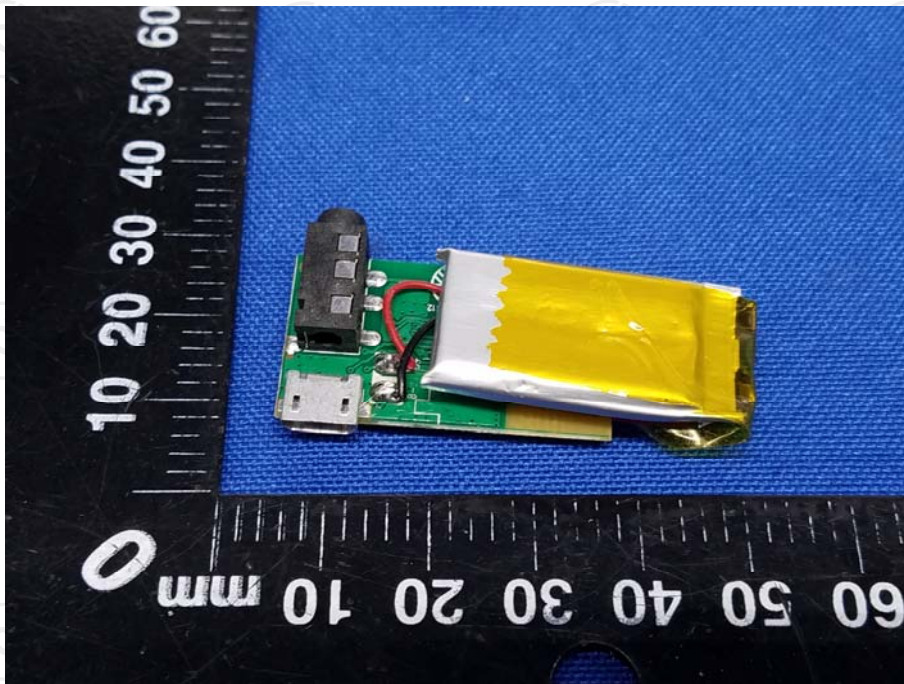

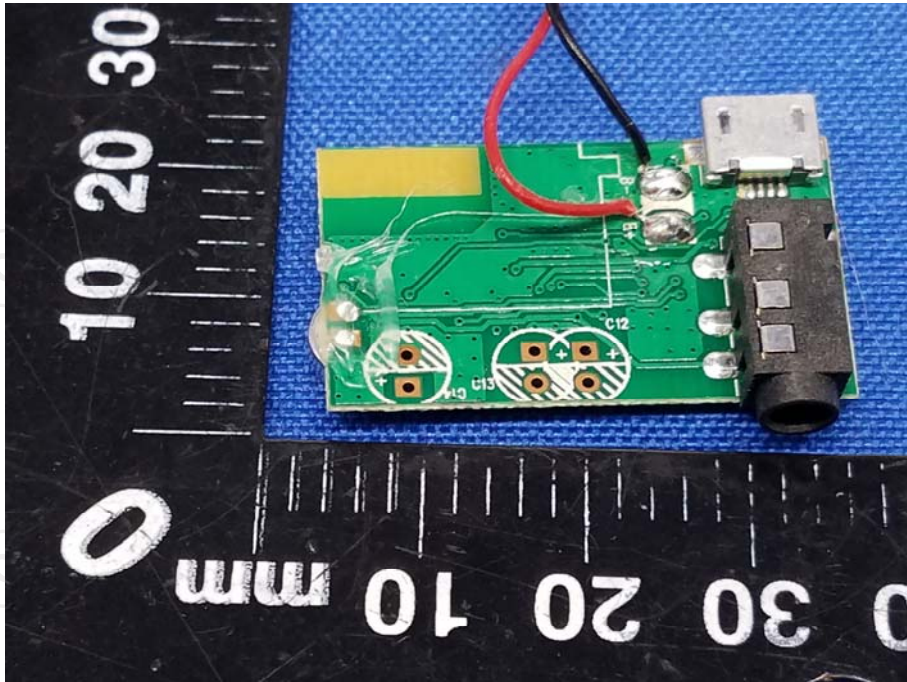

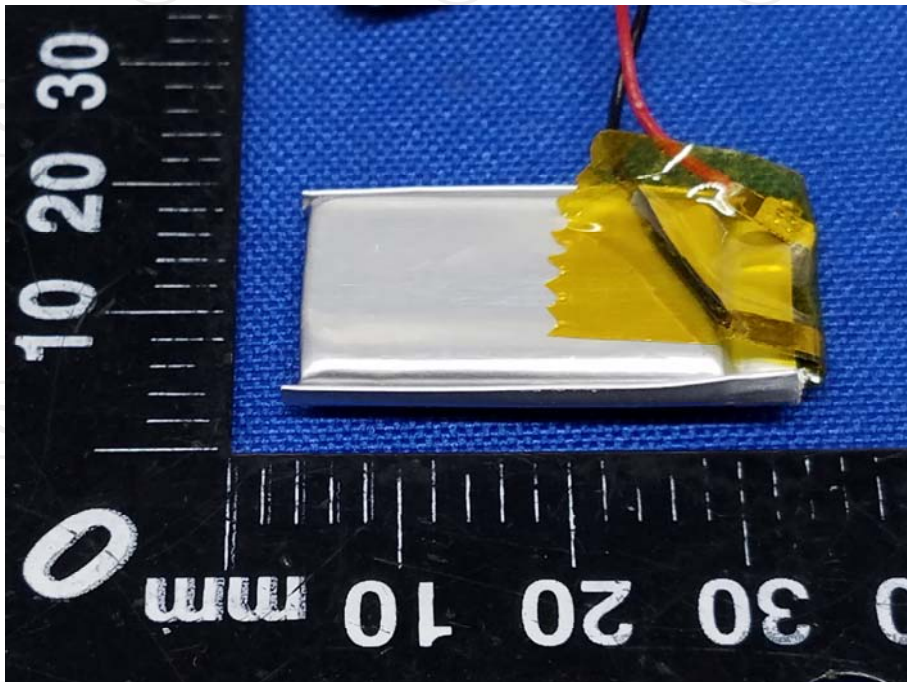
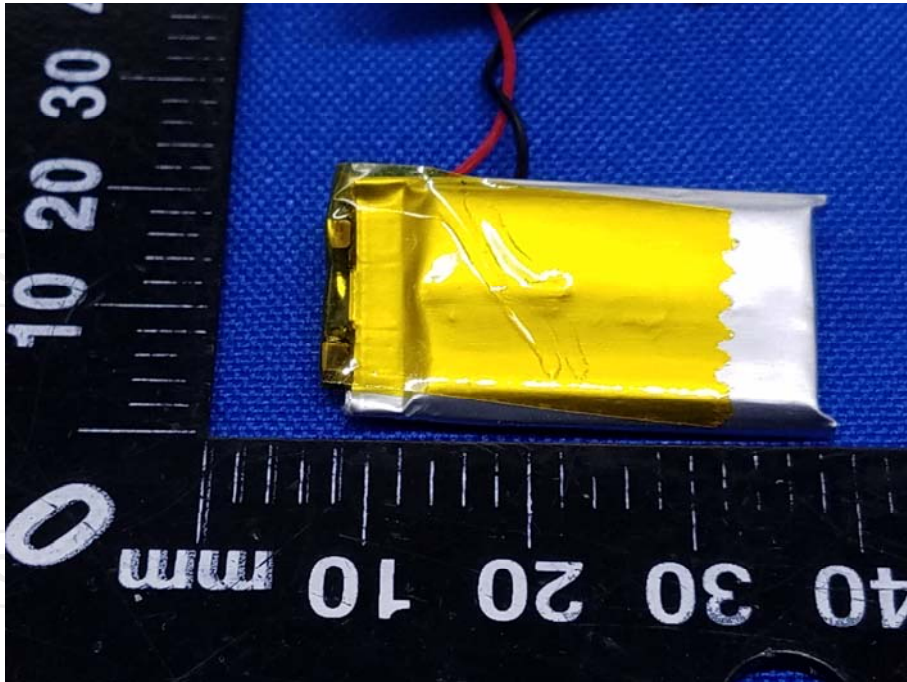

**\*\*\*\*\*END OF REPORT\*\*\*\*\***