



FCC TEST REPORT

**Test report
On Behalf of
Shenzhen Tilv Technology Co., Ltd
For
Lamp wireless charger
Model No.: TYV-1764
FCC ID: 2AGAJTYV-1764**

Prepared for : Shenzhen Tilv Technology Co., Ltd
4/F Dongshan No.8 factory, Difu Rd., Gushu Community, Xixiang St., Baoan District, Shenzhen, Shenzhen, China

Prepared By : Shenzhen HUAKE Testing Technology Co., Ltd.
1F, B2 Building, Junfeng Zhongcheng Zhizao Innovation Park, Fuhai Street, Bao'an District, Shenzhen City, China

Date of Test: July 04, 2019 ~ July 16, 2019

Date of Report: July 16, 2019

Report Number: HK1907041553-1E



TEST RESULT CERTIFICATION

Applicant's name : Shenzhen Tilv Technology Co., Ltd
Address : 4/F Dongshan No.8 Factory, Difu Rd, Gushu Community, Xixiang St, Bao'an District, Shenzhen, China
Manufacture's Name..... : Shenzhen Tilv Technology Co., Ltd
Address : 4/F Dongshan No.8 Factory, Difu Rd, Gushu Community, Xixiang St, Bao'an District, Shenzhen, China

Product description

Trade Mark: N/A
Product name : Lamp wireless charger
Model and/or type reference : TYV-1764

Standards : FCC Rules and Regulations Part 15 Subpart C (Section 15.209), ANSI C63.10: 2013

This publication may be reproduced in whole or in part for non-commercial purposes as long as the Shenzhen HUAKE Testing Technology Co., Ltd. is acknowledged as copyright owner and source of the material. Shenzhen HUAKE Testing Technology Co., Ltd. takes no responsibility for and will not assume liability for damages resulting from the reader's interpretation of the reproduced material due to its placement and context.

Date of Test :
Date (s) of performance of tests : July 04, 2019 ~ July 16, 2019
Date of Issue..... : July 16, 2019
Test Result..... : Pass

Testing Engineer : Gary Qian
 (Gary Qian)

Technical Manager : Eden Hu
 (Eden Hu)

Authorized Signatory : Jason Zhou
 (Jason Zhou)



Table of Contents	Page
1 . TEST SUMMARY	4
1.1 TEST PROCEDURES AND RESULTS	4
1.2 TEST FACILITY	4
1.3 MEASUREMENT UNCERTAINTY	4
2. GENERAL INFORMATION	5
2.1 General Description of EUT	5
2.2. Carrier Frequency of Channels	6
2.3 Operation of EUT during testing	6
2.4 Description of Test Setup	6
2.5 Measurement Instruments List	7
3. CONDUCTED EMISSION TEST	8
3.1 Block Diagram of Test Setup	8
3.2 Conducted Power Line Emission Limit	8
3.3 Test Procedure	8
3.4 Test Result	8
4. Occupied Bandwidth	12
4.1 Block Diagram of Test Setup	12
4.2 Rules and specifications	12
4.3 Test Procedure	12
4.4 Test Result	12
5. RADIA TED EMISSIONS	14
5.1 Block Diagram of Test Setup	14
5.2 Rules and specifications	15
5.3 Test Procedure	16
5.4 Test Result	16
6 ANTENNA REQUIREMENT	19
7. PHOTOGRAPH OF TEST	20
7.1 Radiated Emission	20
7.2 Conducted Emission	21
8. PHOTOGRAPH OF TEST	21



1. TEST SUMMARY

1.1 TEST PROCEDURES AND RESULTS

DESCRIPTION OF TEST	RESULT
CONDUCTED EMISSIONS TEST	COMPLIANT
RADIATED EMISSION TEST	COMPLIANT
OCCUPIED BANDWIDTH MEASUREMENT	COMPLIANT
ANTENNA REQUIREMENT	COMPLIANT

1.2 TEST FACILITY

Test Firm : Shenzhen HUAKE Testing Technology Co., Ltd.

Address 1F, B2 Building, Junfeng Zhongcheng Zhizao Innovation Park, Fuhai Street, Bao'an District, Shenzhen City, China

1.3 MEASUREMENT UNCERTAINTY

Measurement Uncertainty	
Conducted Emission Expanded Uncertainty	= 2.23dB, k=2
Radiated emission expanded uncertainty(9kHz-30MHz)	= 3.08dB, k=2
Radiated emission expanded uncertainty(30MHz-1000MHz)	= 4.42dB, k=2
Radiated emission expanded uncertainty(Above 1GHz)	= 4.06dB, k=2



2. GENERAL INFORMATION

2.1 General Description of EUT

Equipment	Lamp wireless charger
Model Name	TYV-1764
Serial No.	N/A
Model Difference	N/A
Trade Mark	N/A
FCC ID	2AGAJTYV-1764
Antenna Type	Coil Antenna
Antenna Gain	1dBi
BT Operation frequency	125KHz
Number of Channels	1
Modulation Type	ASK
Power Source	DC voltage
Power Rating	Input voltage: DC 5V/3A Output voltage: DC5V/1A (Wireless Charging) or DC5V/0.5A (Wired Charging)



2.2. Carrier Frequency of Channels

Operation Frequency each of channel	
Channel	Frequency
1	125KHz

2.3 Operation of EUT during testing

Operating Mode

The mode is used: Transmitting mode

2.4 Description of Test Setup

Operation of EUT during testing

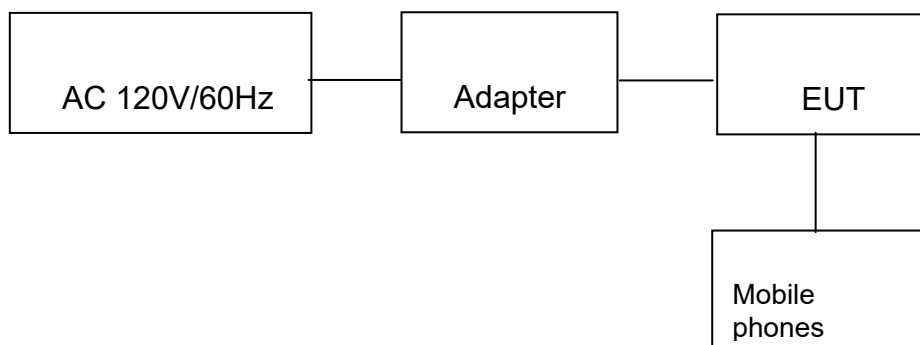

Setup: Transmission mode

- Adapter information
Model: HW-059300CH
Input: 100-240V~, 50/60Hz, 0.5A
Output: 5VDC, 3A
- Mobile phones information
Model: S6
Input: 5VDC



2.5 Measurement Instruments List

Item	Equipment	Manufacturer	Model No.	Serial No.	Last Cal.	Cal. Interval
1.	L.I.S.N. Artificial Mains Network	R&S	ENV216	HKE-002	Dec. 27, 2018	1 Year
2.	Receiver	R&S	ESCI 7	HKE-010	Dec. 27, 2018	1 Year
3.	RF automatic control unit	Tonscend	JS0806-2	HKE-060	Dec. 27, 2018	1 Year
4.	Spectrum analyzer	R&S	FSP40	HKE-025	Dec. 27, 2018	1 Year
5.	Spectrum analyzer	Agilent	N9020A	HKE-048	Dec. 27, 2018	1 Year
6.	Preamplifier	Schwarzbeck	BBV 9743	HKE-006	Dec. 27, 2018	1 Year
7.	EMI Test Receiver	Rohde & Schwarz	ESCI 7	HKE-010	Dec. 27, 2018	1 Year
8.	Bilog Broadband Antenna	Schwarzbeck	VULB9163	HKE-012	Dec. 27, 2018	1 Year
9.	Loop Antenna	Schwarzbeck	FMZB 1519 B	HKE-014	Dec. 27, 2018	1 Year
10.	Horn Antenna	Schwarzbeck	9120D	HKE-013	Dec. 27, 2018	1 Year
11.	Pre-amplifier	EMCI	EMC051845 SE	HKE-015	Dec. 27, 2018	1 Year
12.	Pre-amplifier	Agilent	83051A	HKE-016	Dec. 27, 2018	1 Year
13.	EMI Test Software EZ-EMC	Tonscend	JS1120-B Version	HKE-083	Dec. 27, 2018	N/A
14.	Power Sensor	Agilent	E9300A	HKE-086	Dec. 27, 2018	1 Year
15.	Spectrum analyzer	Agilent	N9020A	HKE-048	Dec. 27, 2018	1 Year
16.	Signal generator	Agilent	N5182A	HKE-029	Dec. 27, 2018	1 Year
17.	Signal Generator	Agilent	83630A	HKE-028	Dec. 27, 2018	1 Year
18.	Shielded room	Shiel Hong	4*3*3	HKE-039	Dec. 27, 2017	3 Year

3. CONDUCTED EMISSION TEST

3.1 Block Diagram of Test Setup

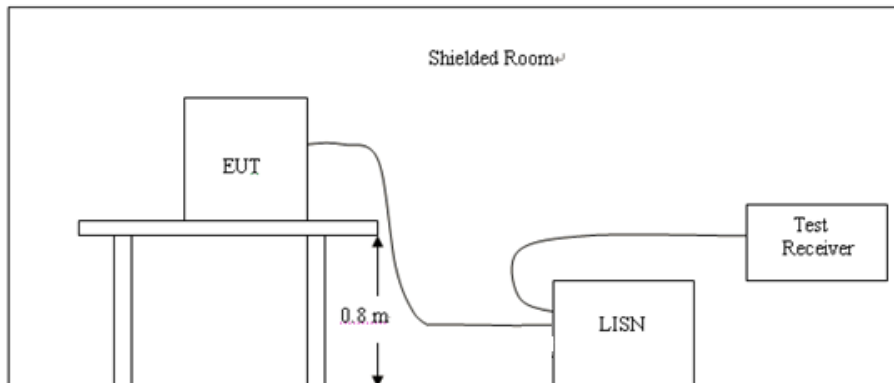

3.2 Conducted Power Line Emission Limit

According to FCC Part 15.207(a)

Frequency (MHz)	Maximum RF Line Voltage (dBμV)			
	CLASS A		CLASS B	
	Q.P.	Ave.	Q.P.	Ave.
0.15 - 0.50	79	66	66-56*	56-46*
0.50 - 5.00	73	60	56	46
5.00 - 30.0	73	60	60	50

* Decreasing linearly with the logarithm of the frequency

For intentional device, according to §15.207 Line Conducted Emission Limit is same as above table.

3.3 Test Procedure

- 1, The equipment was set up as per the test configuration to simulate typical actual usage per the user's manual. The EUT is a tabletop system, a wooden table with a height of 0.8 meters is used and is placed on the ground plane as per ANSI C63.10.
- 2, Support equipment, if needed, was placed as per ANSI C63.10.
- 3, All I/O cables were positioned to simulate typical actual usage as per ANSI C63.10.
- 4, If a EUT received DC power from the USB Port of Notebook PC, the PC's adapter received AC120V/60Hz power through a Line Impedance Stabilization Network (LISN) which supplied power source and was grounded to the ground plane.
- 5, All support equipments received AC power from a second LISN, if any.
- 6, The EUT test program was started. Emissions were measured on each current carrying line of the EUT using a spectrum Analyzer / Receiver connected to the LISN powering the EUT. The LISN has two monitoring points: Line 1 (Hot Side) and Line 2 (Neutral Side). Two scans were taken: one with Line 1 connected to Analyzer / Receiver and Line 2 connected to a 50 ohm load; the second scan had Line 1 connected to a 50 ohm load and Line 2 connected to the Analyzer / Receiver.
- 7, Analyzer / Receiver scanned from 150 KHz to 30MHz for emissions in each of the test modes

3.4 Test Result

PASS



**Remark: We tested all mode, the worst case(Wireless Charging) was recorded.
Please refer to following diagram for individual**

Test Specification: Line

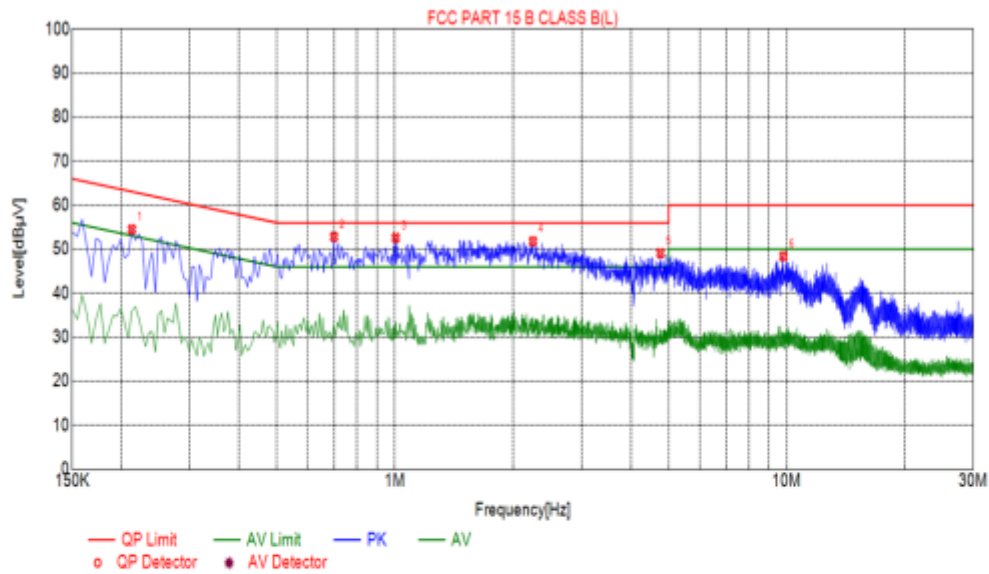

Suspected List						
NO.	Freq. [MHz]	Level [dBµV]	Factor [dB]	Limit [dBµV]	Margin [dB]	Detector
1	0.2130	54.51	10.05	63.09	8.58	PK
2	0.6990	52.81	10.05	56.00	3.19	PK
3	1.0050	52.57	10.06	56.00	3.43	PK
4	2.2515	51.80	10.18	56.00	4.20	PK
5	4.7625	49.07	10.26	56.00	6.93	PK
6	9.8160	48.38	10.07	60.00	11.62	PK

Remark:
 $Margin = Limit - Level$
 $Level = Test\ receiver\ reading + factor$
 $Factor = Antenna\ factor + cable\ loss - Amp\ factor$





Test Specification: Neutral

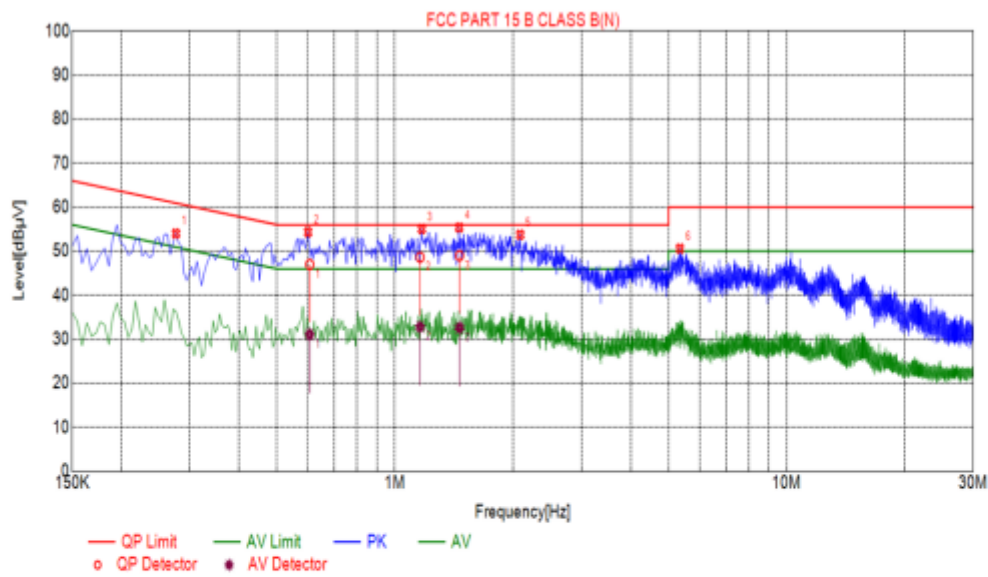

Suspected List						
NO.	Freq. [MHz]	Level [dBµV]	Factor [dB]	Limit [dBµV]	Margin [dB]	Detector
1	0.2760	54.03	10.04	60.94	6.91	PK
2	0.6000	54.34	10.05	56.00	1.66	PK
3	1.1715	55.05	10.09	56.00	0.95	PK
4	1.4595	55.39	10.10	56.00	0.61	PK
5	2.0895	53.76	10.15	56.00	2.24	PK
6	5.3430	50.59	10.26	60.00	9.41	PK

Remark:
 Margin = Limit – Level
 Level=Test receiver reading + factor
 Factor= Antenna factor + cable loss- Amp factor

4. Occupied Bandwidth

4.1 Block Diagram of Test Setup

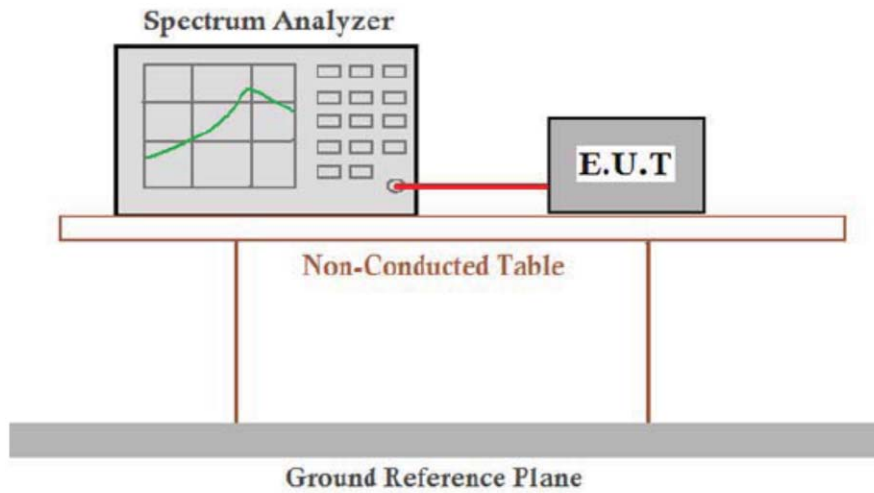

4.2 Rules and specifications

CFR 47 Part 15.215(c)

ANSI C63.10-2013

4.3 Test Procedure

Intentional radiators operating under the alternative provisions to the general emission limits, as contained in §§15.217 through 15.257 and in subpart E of this part, must be designed to ensure that 20dB bandwidth of the emission, or whatever bandwidth may otherwise be specified in the specific rule section under which the equip compliance with the 20dB attenuation specification may base on measurement at the intentional radiator’s antenna output terminal unless the intentional radiator uses a permanently attached antenna, in which case compliance shall be demonstrated by measuring the radiated emissions.

4.4 Test Result

PASS

Mode	Freq (KHz)	20dB Bandwidth (KHz)	Limit (kHz)	Conclusion
Tx Mode	125	2.696	/	PASS

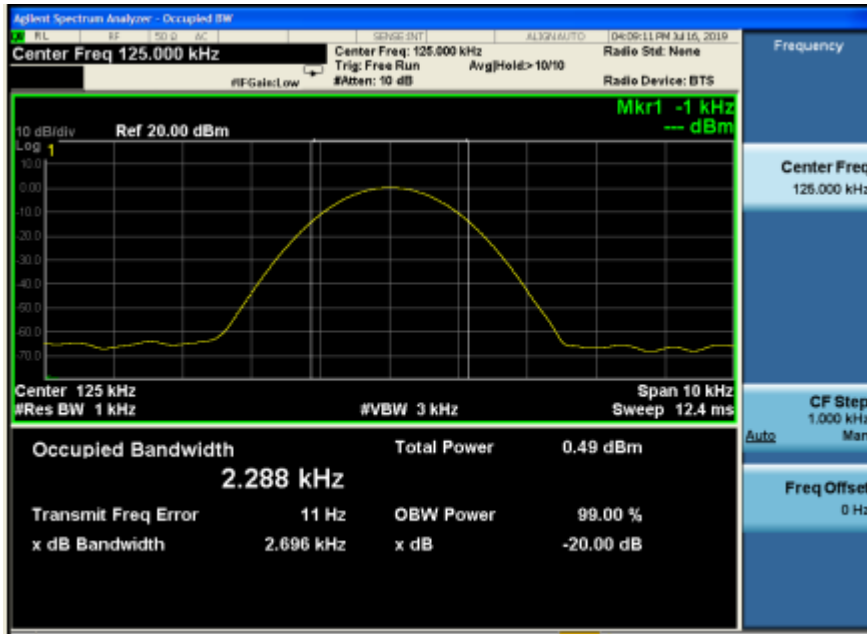

5. RADIA TED EMISSIONS

5.1 Block Diagram of Test Setup

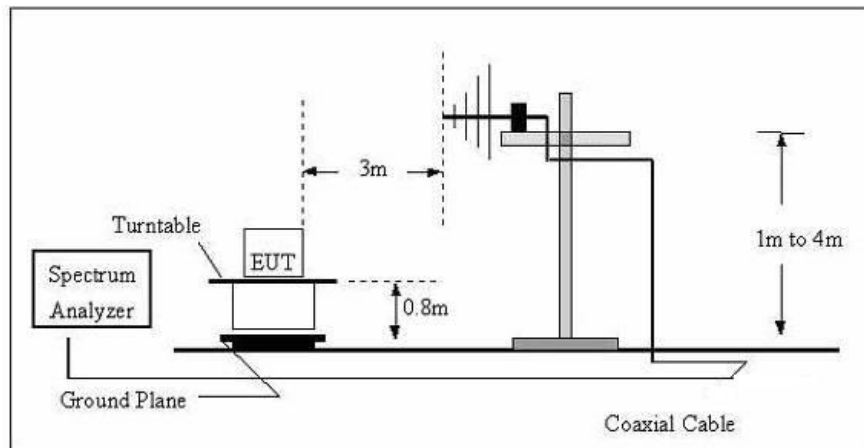
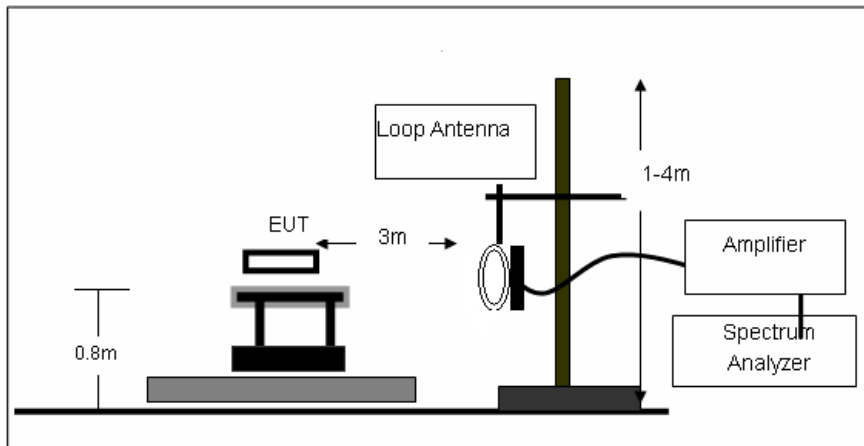



5.2 Rules and specifications

CFR 47 Part 15, section 15.205

Only spurious emissions are permitted in any of the frequency bands listed the tables in these sections.

MHz	MHz	MHz	GHz
0.090-0.110	16.42-16.423	399.9-410	4.5-5.15
1\ 0.495-0.505	16.69475-16.69525	608-614	5.35-5.46
2.1735-2.1905	16.80425-16.80475	960-1240	7.25-7.75
4.125-4.128	25.5-25.67	1300-1427	8.025-8.5
4.17725-4.17775	37.5-38.25	1435-1626.5	9.0-9.2
4.20725-4.20775	73-74.6	1645.5-1646.5	9.3-9.5
6.215-6.218	74.8-75.2	1660-1710	10.6-12.7
6.26775-6.26825	108-121.94	1718.8-1722.2	13.25-13.4
6.31175-6.31225	123-138	2200-2300	14.47-14.5
8.291-8.294	149.9-150.05	2310-2390	15.35-16.2
8.362-8.366	156.52475-156.52525	2483.5-2500	17.7-21.4
8.37625-8.38675	156.7-156.9	2690-2900	22.01-23.12
8.41425-8.41475	162.0125-167.17	3260-3267	23.6-24.0
12.29-12.293	167.72-173.2	3332-3339	31.2-31.8
12.51975-12.52025	240-285	3345.8-3358	36.43-36.5
12.57675-12.57725	322-335.4	3600-4400	(2)
13.36-13.41			

CFR 47 Part 15, section 15.209

The emissions from an intentional radiator shall not exceed the limits in the tables in these sections using an average detector

Frequency (MHz)	Field strength (microvolts/meter)	Measurement distance (meters)
0.009–0.490	2400/F (kHz)	300
0.490–1.705	24000/F (kHz)	30
1.705–30.0	30	30
30–88	100**	3
88–216	150**	3
216–960	200**	3
Above 960	500	3

Limit calculation and transfer to 3m distance as showed in the following table:

Frequency (MHz)	Limit (dBuV/m)	Distance (m)
0.009-0.490	$20\log(2400/F(KHz))+40\log(300/3)$	3
0.490-1.705	$20\log(24000/F(KHz))+40\log(300/3)$	3
1.705-30.0	69.5	3
30-88	40.0	3
88-216	43.5	3
216-960	46.0	3
Above 960	54.0	3

CFR 47 Part 15, section 15.35

When average radiated emission measurements are specified, the limit on the peak level of the radio Frequency emission is 20dB above the maximum permitted average emission limit.

Transmitter Spurious Emissions 9KHz-30MHz			
	9-150KHz	150-490KHz	490KHz-30MHz
Resolution Bandwidth	200Hz	9KHz	9KHz
Video Bandwidth	2KHz	100KHz	100KHz
Detector	Peak	Peak	Peak
Trace Mode	Max Hold	Max Hold	Max Hold
Sweep Time	Auto	Auto	Auto



5.3 Test Procedure

Measurement distance 3m

For the measurement range up to 30MHz in the following plots the field strength result from 3m Distance measurement are extrapolated to 300m and 30m distance respectively, by 40dB/decade, According to part 15.31(f)(2), per antenna factor scaling.

Measurements below 1000MHz are performed with a peak detector and compared to average limits, Measurements with an average detector are not required.

Note:

For battery operated equipment, the equipment tests shall be performed using a new battery.

5.4 Test Result

PASS

For 9KHz-30MHz

Freq. (MHz)	Detector Mode (PK/QP)	Reading (dBuV)	Factor (dB)	Actual FS (dBuV/m)	Limits 3m (dBuV/m)	Margin (dBuV/m)
0.110	Peak	22.85	24.8	47.65	126.77	79.12
0.125	Peak	46.47	24.8	71.27	125.67	54.4
0.486	Peak	26.58	25.03	51.61	113.71	62.1
0.500	Peak	25.62	25.03	50.65	113.62	62.97



For 30MHz-1GHz

Remark: We tested all mode, the worst case(Wireless Charging) was recorded.
Please refer to following diagram for individual

Antenna polarity: H

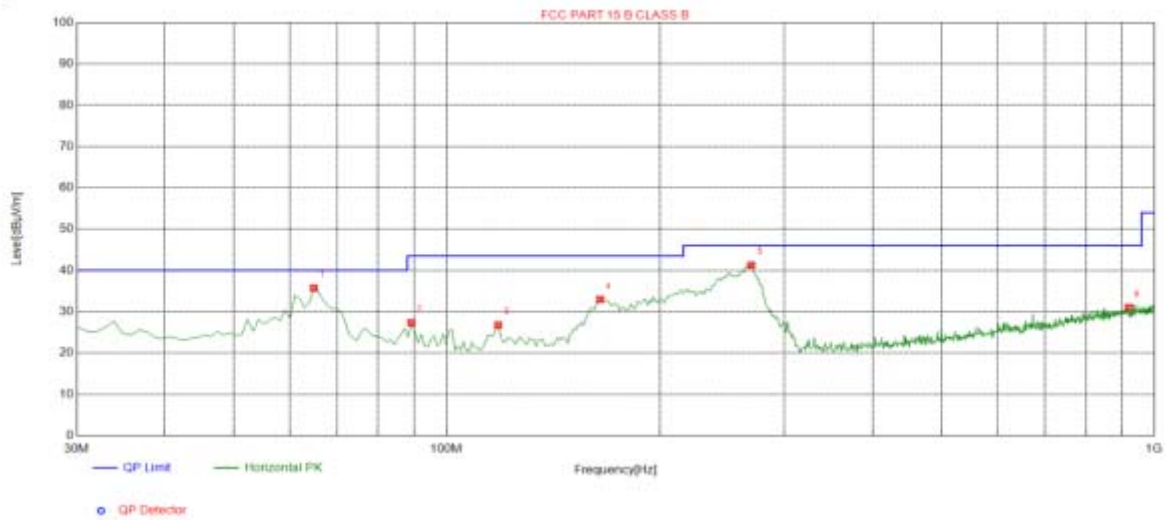

Suspected List								
NO.	Freq. [MHz]	Level [dBµV/m]	Factor [dB]	Limit [dBµV/m]	Margin [dB]	Height [cm]	Angle [°]	Polarity
1	64.9200	35.73	-16.39	40.00	4.27	100	120	Horizontal
2	89.1700	27.33	-17.27	43.50	16.17	100	130	Horizontal
3	118.270	26.76	-16.81	43.50	16.74	100	11	Horizontal
4	164.830	32.99	-17.78	43.50	10.51	100	309	Horizontal
5	269.590	41.29	-13.65	46.00	4.71	100	227	Horizontal
6	920.460	31.04	-1.79	46.00	14.96	100	156	Horizontal

Remark:
 Margin = Limit – Level
 Level=Test receiver reading + factor
 Factor= Antenna factor + cable loss- Amp factor



Antenna polarity: V

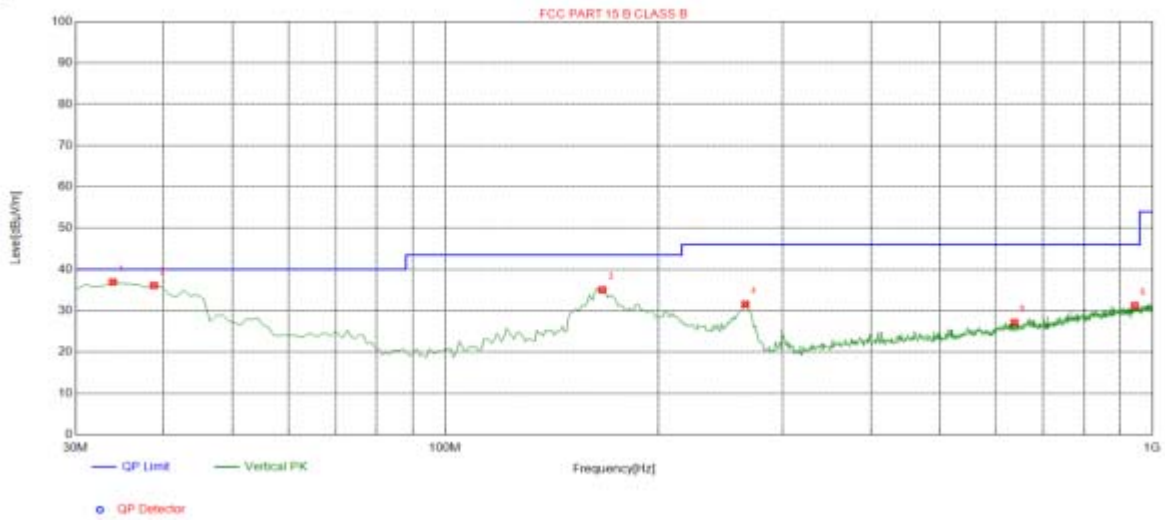

Suspected List								
NO.	Freq. [MHz]	Level [dBµV/m]	Factor [dB]	Limit [dBµV/m]	Margin [dB]	Height [cm]	Angle [°]	Polarity
1	33.8800	36.95	-16.19	40.00	3.05	100	36	Vertical
2	38.7300	36.12	-14.95	40.00	3.88	100	208	Vertical
3	166.770	35.04	-17.60	43.50	8.46	100	160	Vertical
4	265.710	31.58	-13.60	46.00	14.42	100	9	Vertical
5	638.190	27.15	-5.62	46.00	18.85	100	110	Vertical
6	944.710	31.23	-1.39	46.00	14.77	100	68	Vertical

Remark:
 Margin = Limit – Level
 Level=Test receiver reading + factor
 Factor= Antenna factor + cable loss- Amp factor

6 ANTENNA REQUIREMENT

Standard Applicable

For intentional device, according to FCC 47 CFR Section 15.203, an intentional radiator shall be designed to ensure that no antenna other than that furnished by the responsible party shall be used with the device.

Refer to statement below for compliance.

The manufacturer may design the unit so that the user can replace a broken antenna, but the use of a standard antenna jack or electrical connector is prohibited. Further, this requirement does not apply to intentional radiators that must be professionally installed.

Antenna Connected Construction

The antenna used in this product is a Coil Antenna, The directional gains of antenna used for transmitting is 1dBi.

ANTENNA

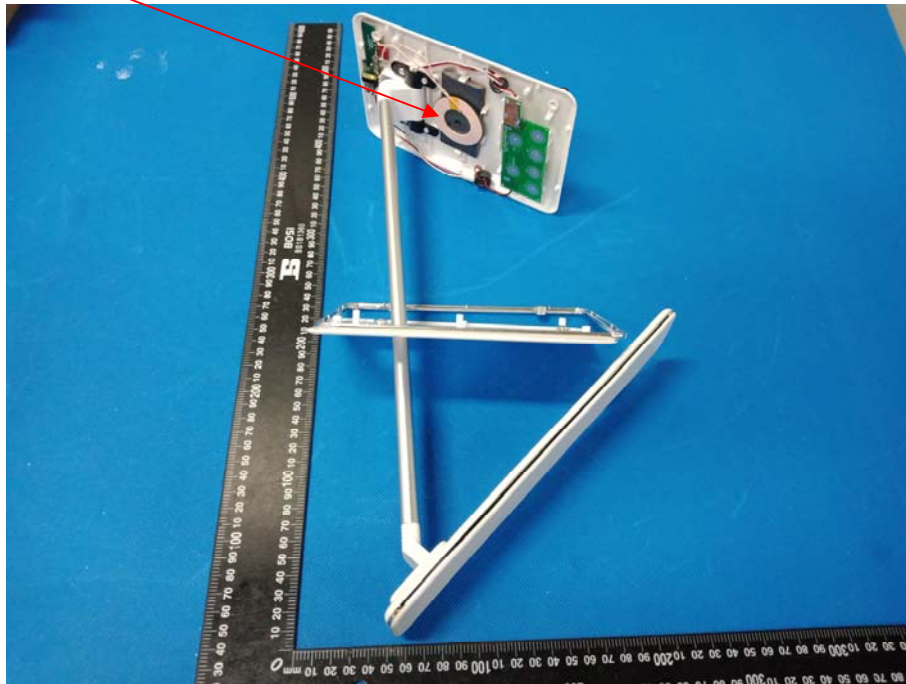

7. PHOTOGRAPH OF TEST

7.1 Radiated Emission

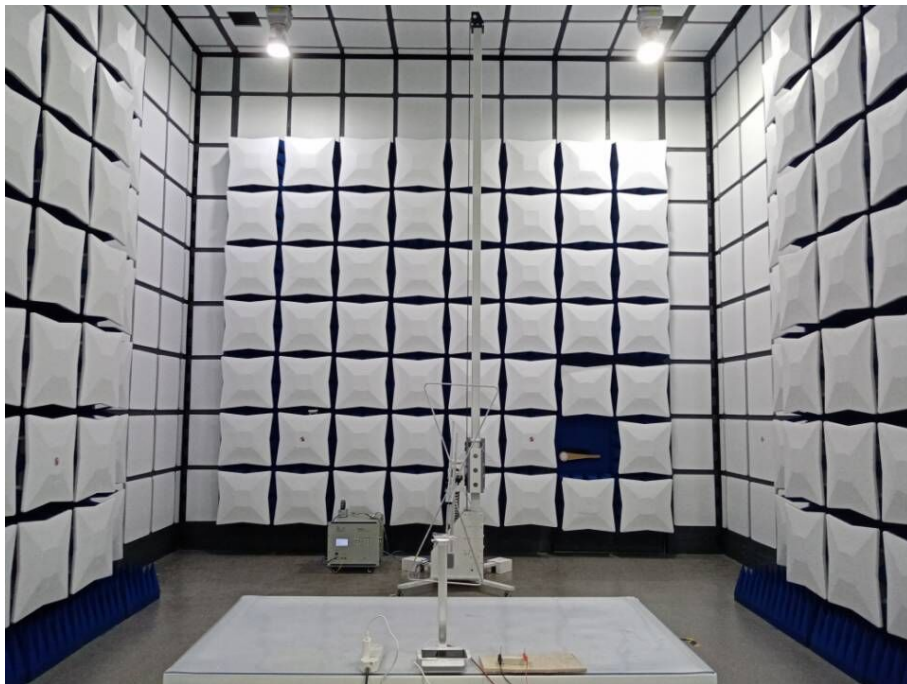
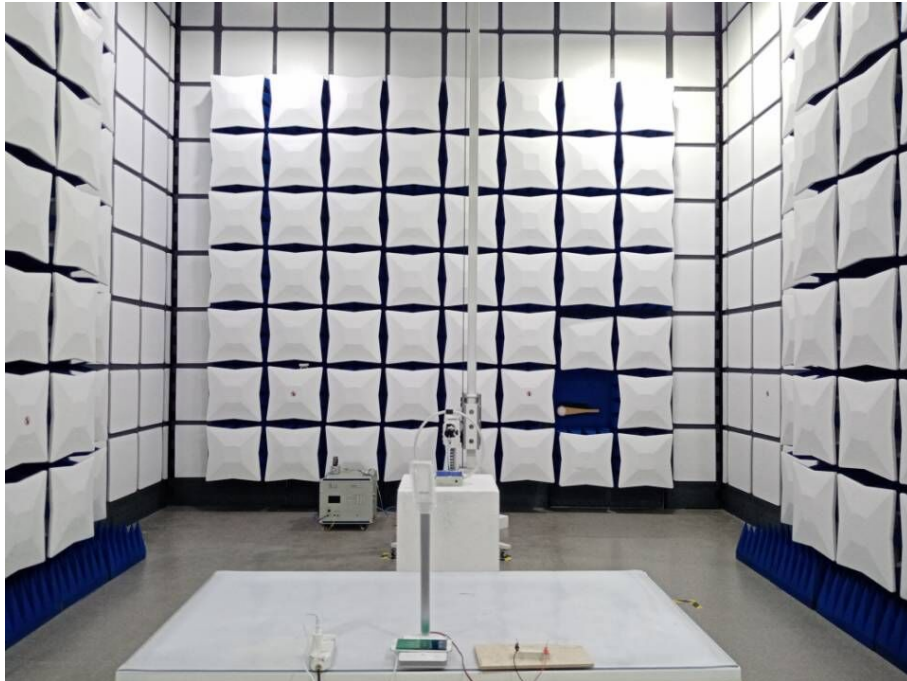



7.2 Conducted Emission

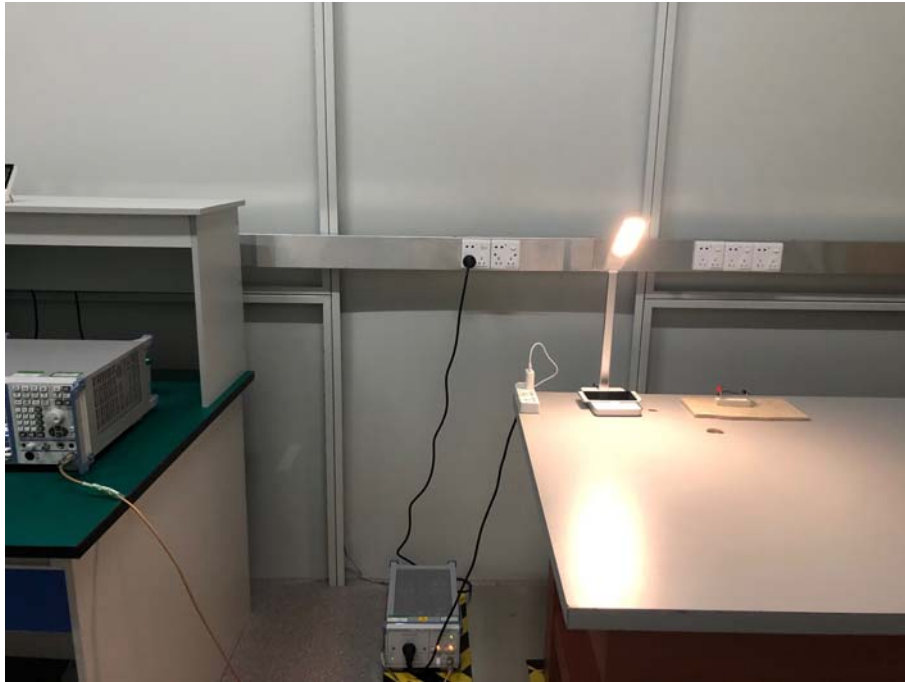

8. PHOTOGRAPH OF TEST

Reference to the reporter : ANNEX A of external photos and ANNEX B of internal photos

-----End of test report-----