

Quick Start Guide

OontZ

Angle solo

Portable Mini
Bluetooth Speaker

Designed and Engineered By
CAMBRIDGE SOUNDWORKS.

TheOontZ.com

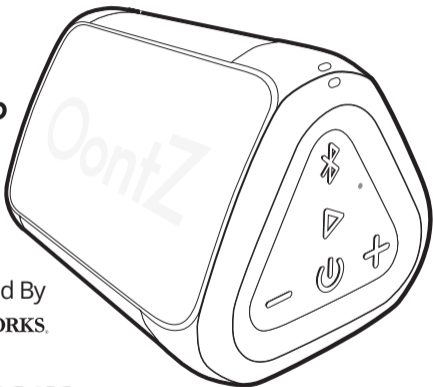

In the Package

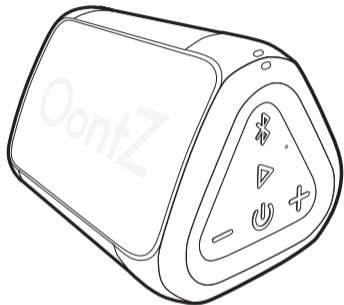

OontZ
Angle solo



Quick-Start Guide



Micro USB Charging Cable



Lanyard

Note: The cable and lanyard are packed below the cardboard insert in the box. Slide out the insert to locate them.

Table of Contents	Pages
Buttons, Lights and Connectors	1 - 3
Attaching the Lanyard	4
Battery Features and Charging the Battery.....	5 - 7
Turning On and Off.....	8
Pair & Connect with Your Device	9 - 12
To Play with Non-Bluetooth Devices use a 3.5mm Audio Cable	13
IPX5 Water Resistance	14
Wireless Hands Free Personal Speakerphone	15
Reset Function	16
Contacting Customer Support	17
Safety and Precautions	18 - 19

Buttons

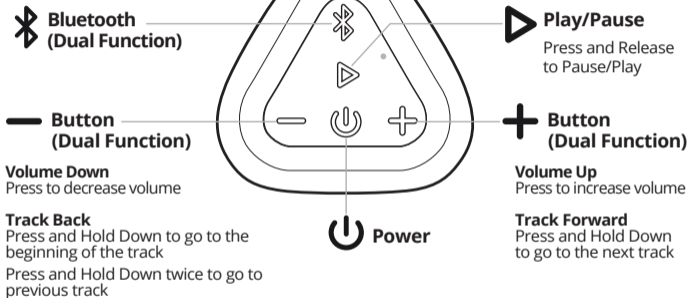

Important - The volume control on your device and the speaker work independently of each other. To play the speaker at the loudest volume, set the volume on your device to maximum and raise the volume on the speaker to maximum.

Important - Some apps may not support track back, track forward, or play/pause

Lights

Blue Light lit when speaker is on:

- **Flashing Blue**
speaker is in pairing mode
- **Solid Blue**
speaker is connected
- **Blue Light will turn to Solid Green**
when the 3.5mm audio cable is plugged into the AUX IN Jack

Red Light lit when charging:

- **Slowly flashing Red**
battery is charging
- **Solid Red**
battery is fully charged

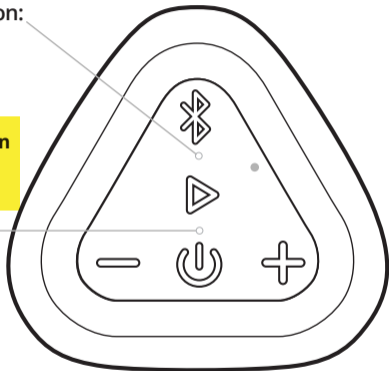

Connectors

**Built-in Mic for
Speakerphone**

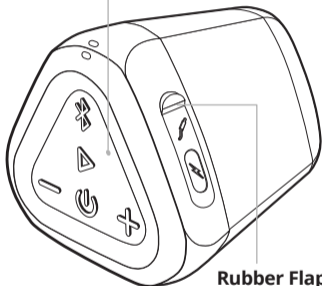

Rubber Flap

- covers connectors
- pull gently from the top to access connectors, it is a snug fit to provide water resistance

AUX IN Jack

**Micro USB
Charging Connector**

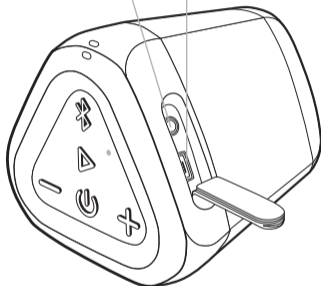

Note: The rubber flap needs to be closed to keep the speaker water resistant

Attaching the Lanyard

Use the lanyard as a wrist strap for carrying your speaker in hand or attaching to other objects

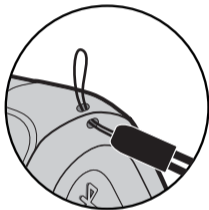

- Slide the smaller lanyard loop through one of the lanyard attachment holes at the top of the speaker



- Slide the larger lanyard loop through the smaller lanyard loop that has passed through the other attachment hole

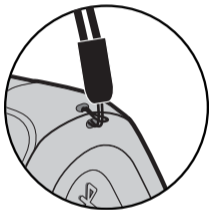

- Pull the larger lanyard loop completely through the smaller lanyard loop to fasten the lanyard to the speaker

Battery Features

- The rechargeable battery comes with a partial charge and the speaker is ready to play.
- For maximum playtime, fully charge the battery.
- You can play while charging.

Low Charge Remaining

- When the battery charge has less than 15% remaining the Red Light will begin flashing rapidly.
- The volume will decrease to preserve the remaining battery charge.

Music Play Time

Up to 10 hours on a full charge, at 2/3 volume. Louder volumes will reduce the battery play time.

Power Saving Feature

- When playing from battery power the OontZ Angle Solo will turn off after 30 minutes of not playing audio to conserve the battery charge. *
- When plugged into a charging source the OontZ Angle Solo will remain on until you turn the power off.
- You can continue to keep the speaker plugged into a charging source even when it is fully charged, keeping the speaker turned on and available

*Exception: when connected to certain devices, including the Amazon Echo Dot or Amazon Echo, the Power Saving Feature is disabled and the speaker will remain on until you turn the power off.

Charging the Battery

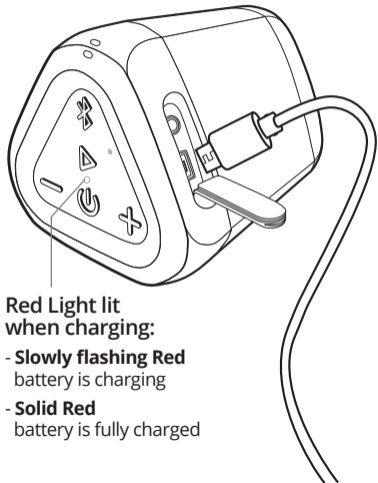

Red Light lit
when charging:

- **Slowly flashing Red**
battery is charging
- **Solid Red**
battery is fully charged

- Insert the small end of the Micro USB Charging Cable into the Micro USB Charging Connector as shown.

- Insert the large end of the Micro USB Charging cable into either a USB wall charger for a Smartphone or iPhone, or a USB port on your laptop/computer to charge the battery (see illustrations on page 7).

Charging Time:

- Up to 7 hours to fully charge a low battery.

Charging the Battery (continued)

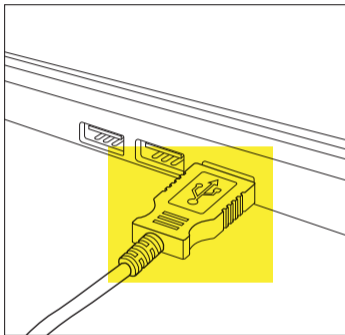
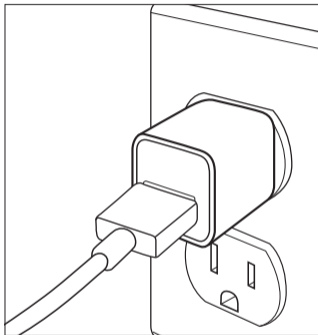

Insert the large end of the Micro USB charging cable into either a USB wall charger for a Smartphone or iPhone (a USB wall charger that is 5V $\overline{\text{---}}$ 1.0A up to 5V $\overline{\text{---}}$ 2.4A maximum) or a USB port on your laptop/computer to charge the OontZ Angle Solo rechargeable battery.

Turning On and Off

Turn ON

Press and Release
the Power Button 

Red Light will
turn on for 3
seconds

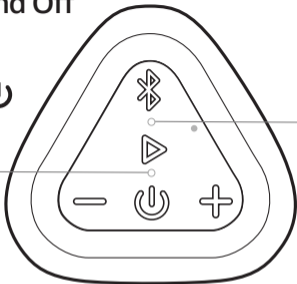

Blue Light will turn
on after Red Light
turns off

- **Flashing Blue**
The speaker is in
pairing mode
- **Solid Blue**
Your device has
connected with the
OontZ Angle Solo
and is ready to play

Turn OFF

Press and Hold Down the Power Button for 2 Seconds 

Blue Light will turn off

Pair & Connect with Your Device -- Step 1

Turn ON your OontZ Angle Solo

Flashing Blue Light

- The OontZ Angle Solo is ready to pair and connect.

Solid Blue Light

- Your device has connected to the OontZ Angle Solo and is ready to play.

- The OontZ Angle Solo allows the last device it was connected with to automatically reconnect with the speaker, each time you turn the speaker on and that device is within range.*



The OontZ Angle Solo can be connected to one device at a time.

- To pair and connect to a different device, you need to first disconnect the currently paired device.

- To disconnect the current device, press and hold down the **Bluetooth button**  for 5 seconds.

- The **Blue Light** will begin **flashing** and the OontZ Angle Solo is ready for the next device to pair and connect.

*Exception: certain devices may not automatically reconnect. Amazon Echo devices will not automatically reconnect. You will need to say "Alexa, connect my speaker"

- Your device needs to be within 100 unobstructed feet of the OontZ Angle Solo to pair and connect. If there is an issue when connecting please move your device closer to the speaker, then pair and connect.

- When the charge is too low indicated by a flashing red light on the speaker, your device will not be able to connect with the speaker.

Pair & Connect with Your Device -- Step 2 --

-- With Your iPhone, iPad, or iPod

- Go to Settings > Bluetooth, check Bluetooth is on
- Select 'OontZ Angle Solo xxx' when it appears under DEVICES (xxx: 3 characters which are unique to your speaker)
- Your device will connect in a few seconds
- The **Blue Light** will turn solid blue and there will be a quiet chime
- You can now play your audio wirelessly to your OontZ Angle Solo

-- With Your Smartphone, Tablet & Mobile Devices

- Go to Settings > Bluetooth, check Bluetooth is on
- Scan or Search and select 'OontZ Angle Solo xxx' when it appears under AVAILABLE DEVICES (xxx: 3 characters which are unique to your speaker)
- Your device will connect in a few seconds
- The **Blue Light** will turn solid blue and there will be a quiet chime
- You can now play your audio wirelessly to your OontZ Angle Solo

Note: Your Smartphone or Tablet instructions may vary

Important - The volume control on your device and the speaker work independently of each other. To play the speaker at the loudest volume, set the volume on your device to maximum and raise the volume on the speaker to maximum.

Pair & Connect with Your Device -- Step 2 --

-- With Your Apple Mac or Windows Laptop/Computer

For the pairing and connecting guide for your Apple Mac or Windows laptop/computer, please visit: TheOontZ.com/pairing

-- With Your Amazon Echo or Amazon Echo Dot

To pair and connect with the Amazon Echo or Amazon Echo Dot the first time use the Alexa app. For other Amazon Alexa devices please refer to their pairing and connecting instructions.

- Open the Alexa app
- Go to the 'Home' menu by pressing the 3 horizontal lines in the upper left corner next to 'Home'
- Press 'Settings'
- Select your Amazon Echo device under 'Devices' by pressing it
- Press 'Bluetooth'
- Select the 'OontZ Angle Solo xxx' (xxx: 3 characters unique to your speaker) when it appears in the list of 'Available Speakers'
- Alexa will announce: "Connected to OontZ Angle Solo"

To connect the next time, turn on the OontZ Angle 3 Solo and say "Alexa, connect my speaker" or "Alexa, pair"

Pair & Connect with Your Device -- Step 2 --

-- With Your Amazon Echo or Amazon Echo Dot (continued)

Important Note: When the OontZ Angle Solo is playing from battery power and connected to the Amazon Echo device, the speaker will remain on and it will not automatically turn off after 30 minutes of not playing audio. This will use up the battery charge.

We recommend to:

- 1) Keep the OontZ Angle Solo plugged into a USB wall charger and it will remain on and available to play from the Amazon Echo device until you manually turn the speaker power off.
- Or -
- 2) Turn off the OontZ Angle Solo when you are done listening.
 - Either turn off the speaker by pressing and holding down the power button  for 2 seconds,
 - or say "Alexa, disconnect my speaker" and the OontZ Angle Solo will automatically turn off after 30 minutes.
 - When you want to connect and play to the speaker again turn on the OontZ Angle Solo and say "Alexa, connect my speaker" or "Alexa, pair".

For assistance with the Alexa app, contact Amazon's Customer Service.
Open the Alexa app and select Help & Feedback > Email Customer Service

To Play with Non-Bluetooth Devices use a 3.5mm Audio Cable

Turn ON your OontZ Angle Solo 

- Plug one end of a 3.5mm audio cable into the **AUX IN Jack** on the speaker.
- The Blue Light will turn solid Green.
- Plug the other end of the 3.5mm audio cable into the headphone jack on your device.
- Make sure both ends of the cable are fully inserted
- You are now ready to play.

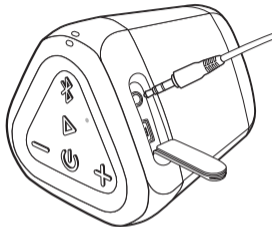

Important: The Bluetooth on the OontZ Angle Solo is disabled when the 3.5mm audio cable is connected to the speaker. You need to remove the 3.5mm audio cable from the speaker in order to connect to a Bluetooth device.

- Note: When the rubber flap is open to allow the 3.5mm audio cable to be connected, the speaker is not water resistant. The rubber flap needs to be closed to keep the speaker water resistant.
- Note: The volume control on your device and the speaker work independently of each other. To play the speaker at the loudest volume, set the volume on your device to maximum and raise the volume on the speaker to maximum.

IPX5 Water Resistant

The rubber flap needs to be closed to keep the speaker water resistant and dustproof



Gentle Water Spray
or Splash is okay



DO NOT allow speaker
to sit in water



DO NOT allow speaker
to submerge fully or
partially in water

Safety Precaution: When the OontZ Angle Solo speaker is plugged in to a charging source with the Micro USB charging cable, never use the speaker in the shower, bath, or near water, to prevent risk of electric shock.

IPX5 rating - The OontZ Angle Solo can resist water spray & splash but cannot be partially or fully submerged or left in a wet environment for an extended period of time, any of which could cause unreparable damage to the speaker.

When charging or using the 3.5mm audio cable, please keep the speaker away from water as it can be damaged by water entering the connectors.

Wireless Hands Free Personal Speakerphone

The **Wireless Hands Free Personal Speakerphone** feature works over Bluetooth with Smartphones and iPhones only; this feature is not supported when connected to other types of devices.

To answer an Incoming Call / To End a Call

- Press and Release the Bluetooth Button 

To Reject an Incoming Call

- Press and Hold Down the Bluetooth Button  for 2 Seconds
- Please keep the speaker close in front of you so you may be heard clearly by the listener.
- You can use your Smartphone or iPhone to switch between using Hands Free Speakerphone and your phone.

Reset Function

Step 1: Remove the Micro USB charging cable and 3.5mm Audio cable, if connected.

Step 2: Press and hold down the **Power button**  for approximately 15 seconds until the red and green lights come on together and then turn off together, then release the Power button.

Step 3: The speaker has now been reset and you can turn it on.

Customer Support

If you have a question about your OontZ Angle Solo or experience an issue with the speaker, our Customer Support Team wants to assist you.

For online troubleshooting tips please visit:

TheOontZ.com/troubleshooting

and select the OontZ Angle Solo

Contact us at:

TheOontZ.com/support

and fill in our customer support form

Safety and Precautions

- 1. When the OontZ Angle Solo speaker is plugged in to a charging source with the Micro USB charging cable, never use the speaker in the shower, bath, or near water, to prevent risk of electric shock.**
2. Read and follow all instructions – All operating and use instructions should be followed.
3. Protect the Micro USB charging cable from being pinched, particularly at the connectors.
4. Unplug the Micro USB charging cable during lightning storms or when unused for long periods of time.
5. Do not place speaker near any heat sources such as radiators, heat registers, stoves, or other apparatus (including amplifiers) that produce heat.
6. Refer all servicing to qualified personnel. Servicing is required when the speaker has been damaged in any way.
7. Do NOT make unauthorized alterations to this speaker.
8. Use this speaker only with an agency approved power supply which meets local regulatory requirements (e.g., UL, CSA, VDE, CCC) in accordance with the manufacturer's specifications.
9. Do NOT place naked flame sources, such as lighted candles, on or near the speaker.
10. Do not expose products containing batteries to excessive heat (e.g. from storage in direct sunlight, fire or the like)
11. If the battery leaks, do not allow the liquid to come in contact with the skin or eyes. If contact is made, seek medical advice.

Apple, iPhone, iPad, iPod, Mac and Siri are registered trademarks of Apple Inc.
Amazon, Alexa, Amazon Echo and Amazon Echo Dot are registered trademarks of Amazon.com, Inc.
Windows is a registered trademark of Microsoft Corporation
Bluetooth is a registered trademark of Bluetooth SIG, Inc.

Safety and Precautions (continued)

This device complies with Part 15 of the FCC Rules. Operation is subject to the following two conditions:

(1) This device may not cause harmful interference, and (2) this device must accept any interference received, including interference that may cause undesired operation.

NOTE 1: This equipment has been tested and found to comply with the limits for a Class B digital device, pursuant to part 15 of the FCC Rules. These limits are designed to provide reasonable protection against harmful interference in a residential installation. This equipment generates, uses and can radiate radio frequency energy and, if not installed and used in accordance with the instructions, may cause harmful interference to radio communications. However, there is no guarantee that interference will not occur in a particular installation. If this equipment does cause harmful interference to radio or television reception, which can be determined by turning the equipment off and on, the user is encouraged to try to correct the interference by one or more of the following measures:

- Reorient or relocate the receiving antenna.
- Increase the separation between the equipment and receiver.
- Connect the equipment into an outlet on a circuit different from that to which the receiver is connected.
- Consult the dealer or an experienced radio/TV technician for help.

NOTE 2: Any changes or modifications to this unit not expressly approved by the party responsible for compliance could void the user's authority to operate the equipment.