

Latest version of
Quick Start Guide available
online at www.theoontz.com/support

Quick Start Guide

OontZ

Angle 3

Portable Bluetooth Speaker
OontZ Dual Speaker Model

Designed and Engineered By
CAMBRIDGE SOUNDWORKS.

TheOontZ.com

Table of Contents

	Pages
In the Package.....	1
Buttons.....	2
Lights.....	3
Connectors.....	4
Play Horizontally or Vertically.....	5
Battery Features.....	6
Charging the Battery.....	7 - 8
Turning On and Off.....	9
Pair & Connect - Step 1.....	10
Pair & Connect - Step 2	
-- From Your iPhone, iPad, Smartphone, Tablet and Mobile Devices.....	11
-- From Your Apple Mac or Windows Laptop/Computer.....	11
-- From Your Amazon Echo Device.....	12 - 13
To Play with Non-Bluetooth Audio Source Devices Use the 3.5mm Audio Cable.....	14
IPX5 Water Resistance.....	15
Wireless Hands Free Personal Speakerphone.....	16
OontZ Dual Speaker - Connect Two OontZ Angle 3 Speakers Together.....	17 - 21
Resetting Your OontZ Angle 3.....	22
Troubleshooting & Customer Support.....	23
Safety and Precautions.....	24 - 25

In the Package

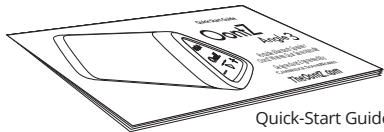
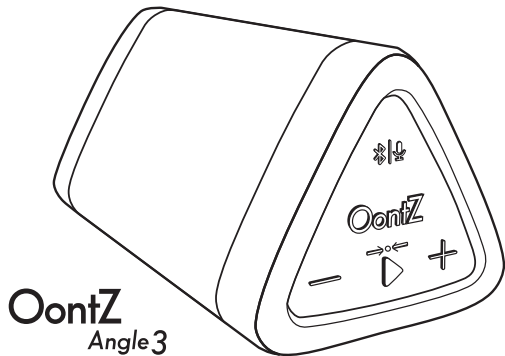

Note: The USB Type C Charging Cable is packed below the cardboard insert at the end of the triangle box. Slide out the insert to locate the cable.

Buttons

 Bluetooth/Speakerphone Button

— Button (Dual Function)

Volume Down

- Press and Release — to decrease volume one level; repeat until volume lowers to desired level
- Holding the button down will result in track back

Track Back

- Press and Hold — Down for 2 Seconds

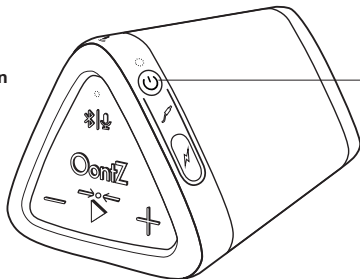

 Power Button

+ Button (Dual Function)

Volume Up

- Press and Release + to increase volume one level; repeat until volume raises to desired level
- Holding the button down will result in track advance

Track Advance

- Press and Hold + Down for 2 Seconds

 **Play/Pause Button**
Press and Release to Pause/Play

Important - Make sure the volume level is set high on your audio source device. The volume on the OontZ Angle 3 and your audio source device both need to be set to the highest level for the loudest volume. The volume controls on your audio source device and the speaker work independently of each other.

Important - The track back feature is application-dependent. Some apps may not support track back, track forward, or play/pause

Lights

Lit Blue when speaker is on:

- **Flashing Blue**
speaker is in pairing mode
- **Solid Blue**
speaker is connected
- **Blue Light will turn to Solid Blue**
when a 3.5mm audio cable is plugged into the AUX IN Jack

Lit White/Orange when the speaker is the second speaker connected in OontZ Dual Speaker

- With a second OontZ Angle 3 speaker (sold separately) you can wirelessly connect both speakers together to play with OontZ Dual Speaker.
- For OontZ Dual Speaker instructions please see page 18.

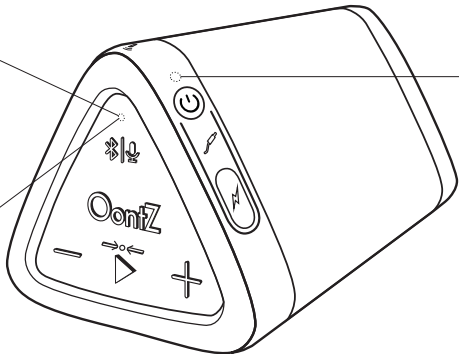

Lit Red when charging:

- **Slowly flashing Red**
battery is charging
- **Solid Red**
battery is fully charged

Connectors

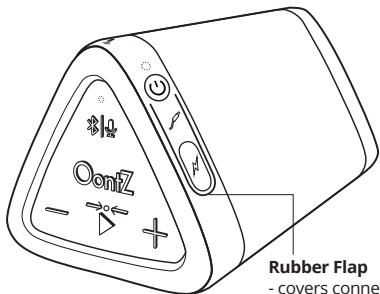

Rubber Flap

- covers connectors
- pull gently from the bottom to access connectors, it is a snug fit to provide water resistance

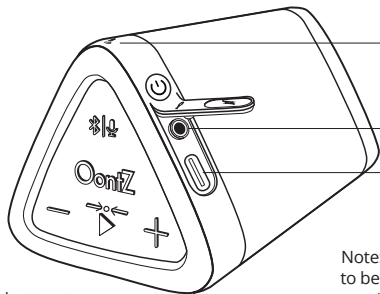

Built-in Mic for
Speakerphone

AUX IN Jack

USB Type C
Charging Connector

Note: The rubber flap needs to be closed to keep the speaker water resistant

Play Horizontally or Vertically

Play Horizontally

Controls on side

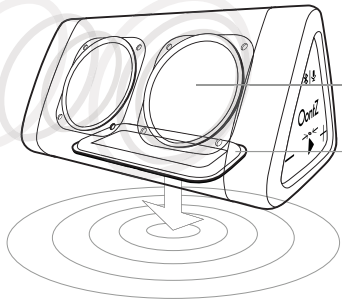

Play Vertically

Controls on top

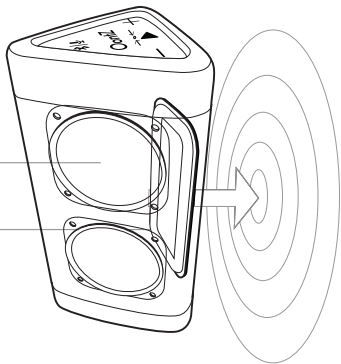

Dual Precision Stereo Drivers

Passive Bass Radiator

- Has its own grille
- Faces bass away from Dual Precision Stereo Drivers
- Rich bass does not interfere with Mids and Highs

Battery Features

- The rechargeable battery comes with a partial charge and the speaker is ready to play.
- For maximum playtime, fully charge the battery.
- You can play while charging.

Low Charge Remaining

- When the battery charge has less than 15% remaining the Red Light will begin flashing rapidly.
- The volume will decrease to preserve the remaining battery charge.

Music Play Time

Up to 14 hours on a full charge, at 2/3 volume.
Louder volumes will reduce the battery play time.

Power Saving Feature

- When playing from battery power the OontZ Angle 3 will turn off after 15 minutes of not playing audio to conserve the battery charge. *
- When plugged into a charging source the OontZ Angle 3 will remain on until you turn the power off.
- You can continue to keep the speaker plugged into a charging source even when it is fully charged.

*Exception: when connected to certain devices, including the Amazon Echo Dot or Amazon Echo, the **Power Saving Feature** is disabled and the speaker will remain on until you turn the power off.

Charging the Battery

Lit Red when charging:

- **Slowly flashing Red**
battery is charging
- **Solid Red**
battery is fully charged

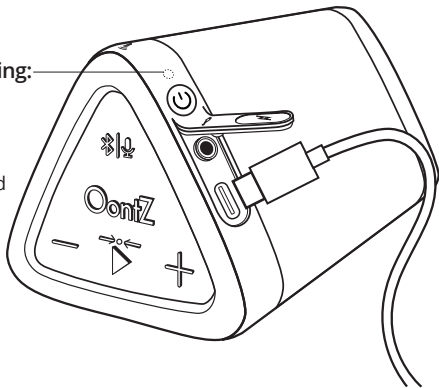

- Insert the small end of the USB Type C Charging Cable into the USB Type C Charging Connector as shown.
- Insert the larger end of the USB Type C Charging cable into a USB wall charger for a Smartphone or iPhone, or a USB port on your laptop/computer to charge the battery (see illustrations on page 8).

Charging Time:

- Up to 6 hours to fully charge a low battery.

Charging the Battery (continued)

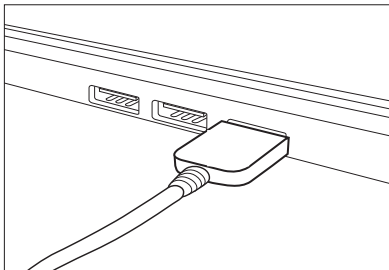
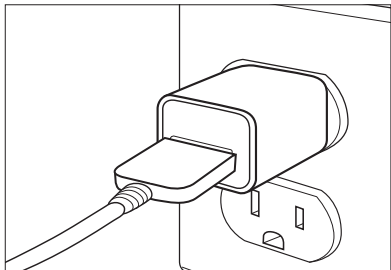

Insert the larger end of the USB Type C Charging Cable into a USB wall charger for a Smartphone or iPhone (USB wall charger* that is 5V $\overline{\text{---}}$ 3.0A maximum), or a USB port on your laptop/computer to charge the OontZ Angle 3 battery.

* Only use a USB wall charger that is UL listed. A USB wall charger will have the logo  printed on it.

Turning On and Off

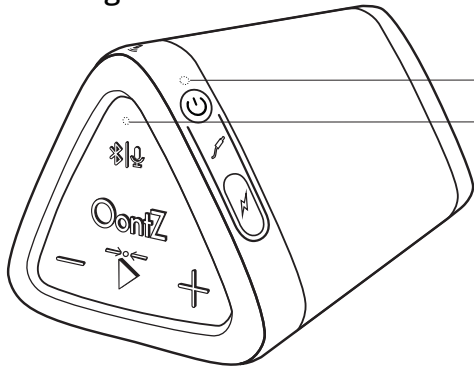

Turn ON

Press and Release the Power Button 

Red Light turns on

- will turn off after 3 seconds if playing from battery power

Blue Light turns on

- Flashing Blue

The speaker is turned on and is in pairing mode

- Solid Blue

The speaker is turned on and has connected to an audio source device and is ready to play

Turn OFF

Press and Hold Down the Power Button  for 2 Seconds

Blue Light will turn off

Pair & Connect -- Step 1

- Make sure your OontZ Angle 3 battery has a sufficient charge, it is not able to connect when the charge is too low.
- Your device needs to be within 100 unobstructed feet of the OontZ Angle 3 to pair and connect. If there is an issue when connecting please move your device closer to the speaker, then pair and connect.

Turn ON your OontZ Angle 3

Flashing Blue Light

- The OontZ Angle 3 is ready to pair and connect.

Solid Blue Light

- The OontZ Angle 3 has automatically reconnected to the last device it was connected to and is ready to play.
- The OontZ Angle 3 will automatically try to connect to the last device it was connected to each time it is turned on and that device is within range.*

The OontZ Angle 3 can be connected to one device at a time.

- To pair and connect to a different device, you need to first disconnect the currently paired device.
- To disconnect the current device, press and hold down the **Bluetooth button**  for 3 seconds.
- The **Blue Light** will begin **flashing** and the OontZ Angle 3 is ready to pair and connect to your device.

*Exception: certain devices may not automatically reconnect.

Amazon Echo devices will not automatically reconnect. You will need to say "Alexa, connect my speaker"

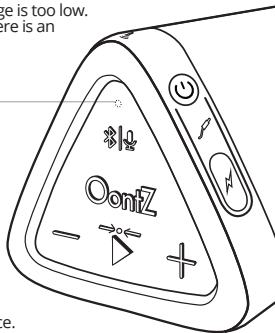

Pair & Connect with Your Device -- Step 2 --

-- With Your iPhone, iPad, iPod, Smartphone, Tablet & Mobile Devices

- Go to Settings > Bluetooth, check Bluetooth is on
- Select 'OontZ Angle 3 TWS xxx' when it appears under DEVICES (xxx: 3 characters which are unique to your speaker)
- Your device will connect in a few seconds
- The **Blue Light** will turn solid blue and there will be a quiet chime
- You can now play your audio wirelessly to your OontZ Angle 3

Note: Your Smartphone or Tablet instructions may vary

Important - The volume control on your device and the speaker work independently of each other. To play the speaker at the loudest volume, set the volume on your device to maximum and raise the volume on the speaker to maximum.

-- With Your Apple Mac or Windows Laptop/Computer

For the pairing and connecting guide for your Apple Mac or Windows laptop/computer, please visit: TheOontZ.com/pairing.

Pair & Connect -- Step 2 --

-- From Your Amazon Echo device

To pair and connect the first time with an Amazon Echo device use the Alexa app on your device.

- Open the Alexa app
- Press 'Devices' by pressing the 'Devices' button in the bottom right corner
- Press 'Echo & Alexa'
- Select your Amazon Echo device under list of devices displayed by pressing it
- Press 'Bluetooth Devices'
- Press 'Pair A New Device'
- Select the 'OontZ Angle 3 TWS xxx' (xxx: 3 characters unique to your speaker) when it appears
- The OontZ Angle 3 will make a 'ding' sound when connected

To connect the next time, turn on the OontZ Angle 3 and say "Alexa, connect my speaker" or "Alexa, pair"

Pair & Connect -- Step 2 --

-- From Your Amazon Echo device (continued)

Important Note: When the OontZ Angle 3 is playing from battery power and connected to the Amazon Echo device, the speaker will remain on and it will not automatically turn off after 15 minutes of not playing audio. This will use up the battery charge.

We recommend to:

- 1) Keep the OontZ Angle 3 plugged into a USB wall charger.
It can remain on and available to play from the Amazon Echo device.
- Or -
- 2) Turn off the OontZ Angle 3 when you are done listening.
 - Either turn off the speaker by pressing and holding down the power button  for 2 seconds,
 - or say "Alexa, disconnect my speaker" and the OontZ Angle 3 will automatically turn off after 15 minutes.
 - When you want to connect and play to the speaker again turn on the OontZ Angle 3 and say "Alexa, connect my speaker" or "Alexa, pair".

For assistance with the Alexa app, contact Amazon's Customer Service.
Open the Alexa app and select Help & Feedback > Email Customer Service

To Play with Non-Bluetooth Audio Source Devices Use a 3.5mm Audio Cable

- Make sure your OontZ Angle 3 battery has a sufficient charge

Turn ON your OontZ Angle 3 

- Plug one end of a 3.5mm audio cable into the **AUX IN Jack** on the back of your speaker.
- Plug the other end of the 3.5mm audio cable into the headphone jack on your laptop/computer or non-Bluetooth audio device.
- Make sure both ends of the cable are fully inserted
- You are now ready to play.

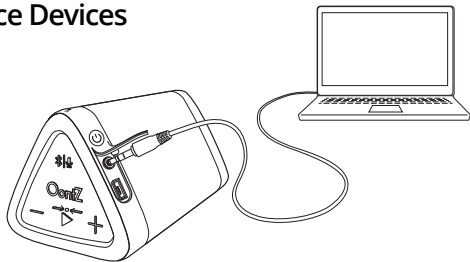

Important: The Bluetooth on the OontZ Angle 3 is disabled when a 3.5mm audio cable is connected to the speaker. You need to remove the 3.5mm audio cable from the speaker in order to connect to a Bluetooth device.

- Note: When the rubber flap is open to allow a 3.5mm audio cable to be connected, the speaker is not water resistant. The rubber flap needs to be closed to keep the speaker water resistant.
- Note: The volume control on your device and the speaker work independently of each other. To play the speaker at the loudest volume, set the volume on your device to maximum and raise the volume on the speaker to maximum.

IPX5 Water Resistance

No more worries about the rain or getting splashed

Listen to music in the shower

Perfect for taking to the beach or by the pool

The rubber flap needs to be closed to keep the speaker water resistant and dustproof

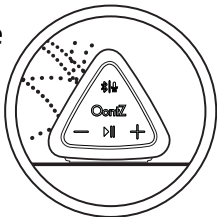

Gentle Water Spray or Splash is okay



DO NOT allow speaker to sit in water

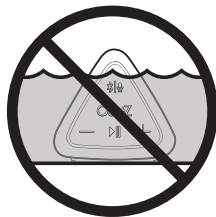

DO NOT allow speaker to submerge fully or partially in water

Safety Precaution: When the OontZ Angle 3 speaker is plugged in to a charging source with the USB Type C Charging Cable, never use the speaker in the shower, bath, or near water, to prevent risk of electric shock.

IPX5 rating - The OontZ Angle 3 can resist gentle water spray & splash but cannot be partially or fully submerged or left in a wet environment for an extended period of time, any of which could cause unreparable damage to the speaker.

When charging or using a 3.5mm audio cable, please keep the speaker away from water as it can be damaged by water entering the connectors.

Wireless Hands Free Personal Speakerphone

- The Wireless Hands Free Personal Speakerphone feature works over Bluetooth with Smartphones and iPhones only
- This feature is not supported when connected to PCs, laptops, Apple Mac or other types of devices.

To answer an Incoming Call / To End a Call

- Press and Release the Bluetooth Button 

To Reject an Incoming Call

- Press and Hold Down the Bluetooth Button  for 3 Seconds.
- Please keep the speaker close in front of you so you may be heard clearly by the listener.
- You can use your Smartphone or iPhone to switch between using Hands Free Speakerphone and your phone.

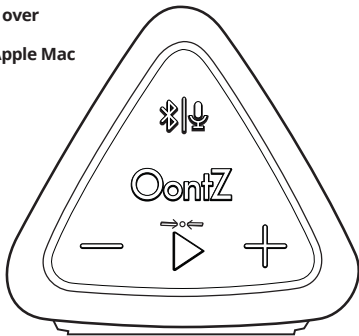

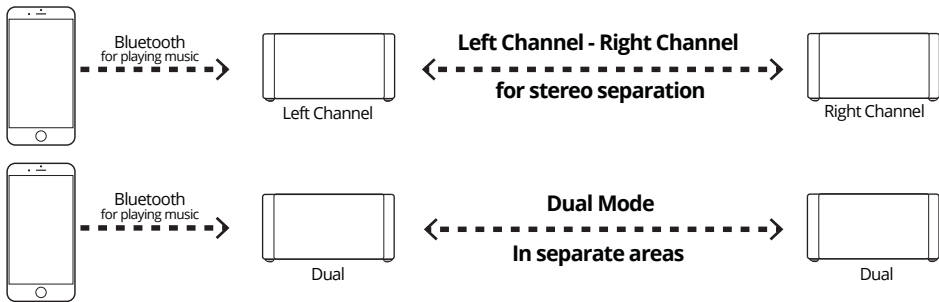

OontZ Dual Speaker - Connect two OontZ Angle 3 Speakers Together

Play your music wirelessly through both speakers up to 100 feet apart*



*Placing the speakers on the ground or having walls or obstructions between the speakers will significantly reduce the distance apart the two speakers can play together

Connecting two OontZ Angle 3 speakers together for Left Channel - Right Channel

- Turn on both OontZ Angle 3 speakers. 
- Pair and Connect one of the speakers with your device. When connected the Blue Light will be lit Solid Blue. This speaker will serve as the **Play Control Speaker**.
- The second speaker must not be connected to any device, its Blue Light needs to be flashing. If the second speaker has a solid Blue Light it is connected to a device and you need to disconnect it by pressing and holding down the **Bluetooth Button**  for 3 seconds until the Blue Light begins flashing.
- On the **Play Control Speaker** (speaker with solid Blue Light) press and hold down the **Play/Pause button**  for 3 seconds until the **Play Control Speaker** says "Dual Pairing".
- After a few seconds the **Play Control Speaker** will say "Left Channel" and the second speaker will say "Right Channel". The **Play Control Speaker** speaker light will remain solid Blue and the second speaker light will be solid White. The OontZ Angle 3 speakers will be connected together for Left Channel - Right Channel and you are ready to play.

Two OontZ Angle 3 Speakers connected for Left Channel - Right Channel

Play Control Speaker

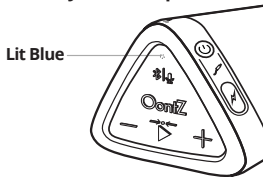

Second Speaker

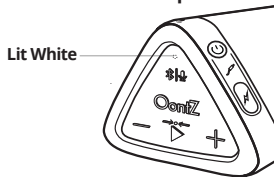

- Use the buttons on the **Play Control Speaker** for play/pause, track back, track forward, answer and end phone calls. These controls are disabled on the second speaker when paired together.
- Use the **Play Control Speaker** for connecting to different audio devices via Bluetooth or AUX IN. The Bluetooth and AUX IN are disabled on the second speaker when paired together.
- Speakerphone call audio will only play through the **Play Control Speaker**

Changing to Dual Mode from Left Channel - Right Channel

Use Dual Mode when placing the two speakers in different areas, and the same music to both speakers.

- To set both speakers for Dual Mode they must first be connected together for Left Channel - Right Channel (see page 18).
- With the speakers connected together for **Left Channel - Right Channel**, you can change the speakers to **Dual Mode**.
- To change to Dual Mode, quickly press the **Bluetooth button**  twice on the **Play Control Speaker**. The second speaker light will turn from solid White to solid Orange.
- Both speakers will say "Dual Mode" and you are ready to play.

Changing back to Left Channel - Right Channel from Dual Mode

- To change back to Left Channel - Right Channel, quickly press the **Bluetooth button**  twice on the **Play Control Speaker**. The second speaker light will turn from solid Orange to solid White.
- The **Play Control Speaker** will say "Left Channel" and the second speaker will say "Right Channel" and you are ready to play.

OontZ Dual Speaker - Important Notes

Turning the speakers off

- Turning the **Play Control Speaker** off will turn both speakers off.
- Turning the second speaker off first will only turn that speaker off and the **Play Control Speaker** will play as a single speaker.

Turning the speakers back on

- Turn both speakers on and they will automatically try to connect to each other again.
- Turn one of the speakers on and a device can connect with it, and play as a single speaker.

Disconnecting the two speakers from each other

- Both speakers need to be turned on.
- On the **Play Control Speaker** press and hold down the **Play/Pause button**  for 3 seconds. The White Light on the second speaker will turn off and the speakers will be disconnected from each other.

Not Recommended to play the audio from a video in OontZ Dual Speaker

- It is not recommended to play the audio from a video with two OontZ Angle 3 speakers connected in OontZ Dual Speaker. Playing the audio from a video or TV in OontZ Dual Speaker will have a delay in the audio playback from a video and will cause the audio and video to play out of sync with each other.

Resetting Your OontZ Angle 3

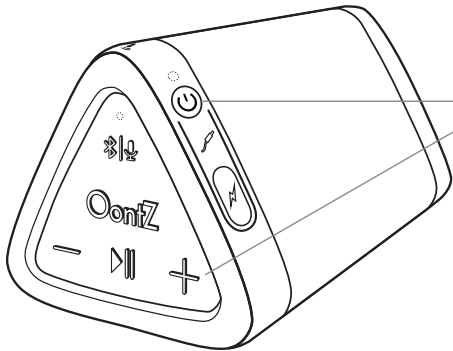

Step 1: Remove the Micro USB charging cable and 3.5mm Audio cable, if connected.

Step 2: Press and hold down the **Power button**  and **+ button** together for 1 second, then release.

Step 3: The speaker has now been reset and you can turn it on.

Troubleshooting

For issues with your OontZ Angle 3, please view our troubleshooting tips at:

TheOontZ.com/troubleshooting

and select the OontZ Angle 3 Dual Speaker

Customer Support

If you have any issues with your OontZ Angle 3, our Customer Support Team wants to assist you.

Please contact us at: **TheOontZ.com/support** and fill in our customer support form.

Safety and Precautions

- 1. When the OontZ Angle 3 speaker is plugged in to a charging source with the USB Type C Charging Cable, never use the speaker in the shower, bath, or near water, to prevent risk of electric shock.**
2. Read and follow all instructions – All operating and use instructions should be followed.
3. Protect the USB Type C Charging Cable from being pinched, particularly at the connectors.
4. Unplug the USB Type C Charging Cable during lightning storms or when unused for long periods of time.
5. Do not place speaker near any heat sources such as radiators, heat registers, stoves, or other apparatus (including amplifiers) that produce heat.
6. Refer all servicing to qualified personnel. Servicing is required when the speaker has been damaged in any way.
7. Do not make alterations to this speaker.
8. The battery in the speaker is not replaceable. Do not attempt to change it.
9. Use this speaker only with an agency approved power supply which meets local regulatory requirements (e.g., UL, CSA, VDE, CCC) in accordance with the manufacturer's specifications.
10. Do not place near naked flame sources, such as lighted candles, on or near the speaker.
11. Do not expose this speaker to excessive heat (e.g. from storage in direct sunlight, fire or the like)
12. If the battery leaks, do not allow the liquid to come in contact with the skin or eyes. If contact is made, seek medical advice.

Safety and Precautions (continued)

This device complies with Part 15 of the FCC Rules. Operation is subject to the following two conditions:

(1) This device may not cause harmful interference, and (2) this device must accept any interference received, including interference that may cause undesired operation.

NOTE 1: This equipment has been tested and found to comply with the limits for a Class B digital device, pursuant to part 15 of the FCC Rules. These limits are designed to provide reasonable protection against harmful interference in a residential installation. This equipment generates, uses and can radiate radio frequency energy and, if not installed and used in accordance with the instructions, may cause harmful interference to radio communications. However, there is no guarantee that interference will not occur in a particular installation. If this equipment does cause harmful interference to radio or television reception, which can be determined by turning the equipment off and on, the user is encouraged to try to correct the interference by one or more of the following measures:

- Reorient or relocate the receiving antenna.
- Increase the separation between the equipment and receiver.
- Connect the equipment into an outlet on a circuit different from that to which the receiver is connected.
- Consult the dealer or an experienced radio/TV technician for help.

NOTE 2: Any changes or modifications to this unit not expressly approved by the party responsible for compliance could void the user's authority to operate the equipment.

Apple, iPhone, iPad, iPod, and Mac are registered trademarks of Apple Inc.

Amazon, Alexa, Amazon Echo and Amazon Echo Dot are registered trademarks of Amazon.com, Inc.

Windows is a registered trademark of Microsoft Corporation

Bluetooth is a registered trademark of Bluetooth SIG, Inc

UL is a registered trademark of UL.

OontZ Angle 3 Carry Case

Sold separately

- Lightweight neoprene rubber with reinforced zipper
- Includes a durable aluminum carabiner for easily attaching to backpacks, luggage, laptop bags, coolers, camera bags, purses, belts, and other clippable items



OontZ Angle 3 BudZ

Sold separately

- Superior Sound and Deep Bass
- Waterproof and Sweatproof
- Ultra-Comfortable and Secure Fit
- Noise Cancellation of Background Noise
- Listen All Day with Playtime up to 8 hours



OontZ True Wireless BudZ

Sold separately

- Amazing Sound and Rich Bass
- Ultra Small, Comfortable and Secure Fit
- Sweatproof, Weaterproof, Splashproof
- Quick and Easy Connection
- Noise Cancellation of Background Noise
- Playtime up to 3 Hours with 9 Extra Hours from Small Compact Charging Case



Available at TheOontZ.com