

Quick Start Guide

OontZ

Angle 3 Pro

The Waterproof Bluetooth Speaker
Incredible Sound, Powerful Volume, 100 Foot Wireless Bluetooth Range

Designed and Engineered By
CAMBRIDGE SOUNDWORKS

TheOontZ.com

In the Package

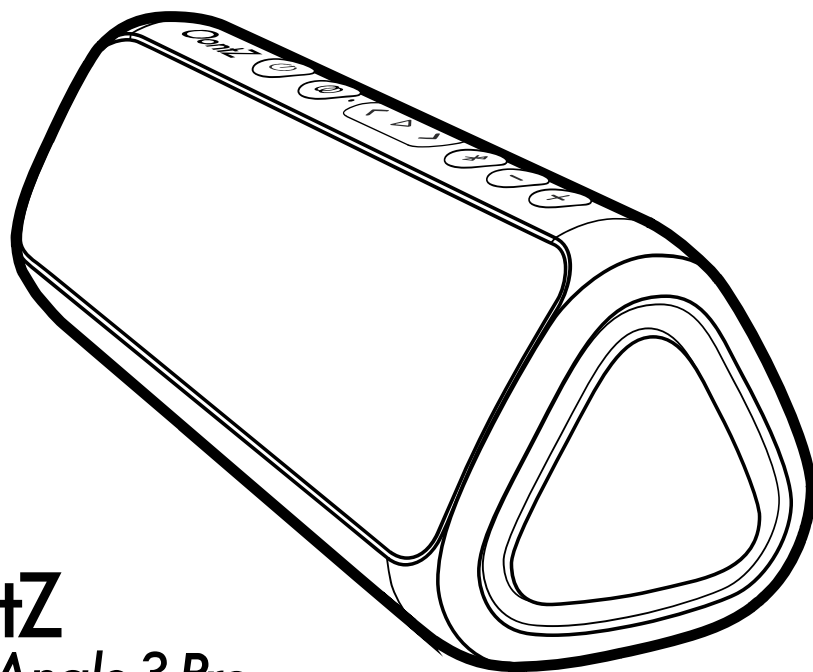

OontZ
Angle 3 Pro

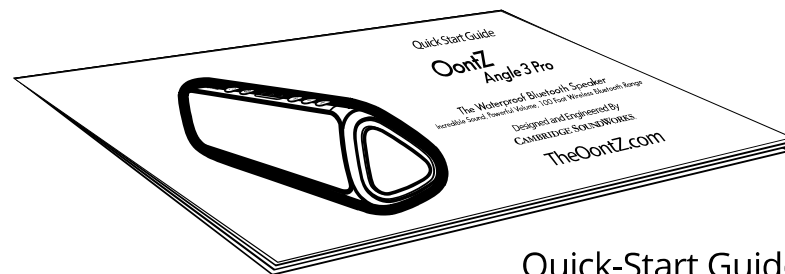

Quick-Start Guide

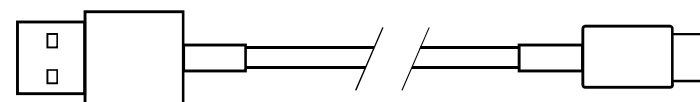

USB Type C Charging Cable



3.5mm Audio Cable

Table of Contents

	Pages
Buttons, Built-in Mic, Lights, and Connectors.....	1 - 4
Battery Features and Charging the Battery	5 - 7
Turning On and Off	8
Pair & Connect with Your Device	9 - 12
OontZ Wireless Dual Stereo - Connect Two OontZ Angle 3 Pro Speakers Together.....	13-19
IPX7 Water Resistance.....	20
Talk to Siri Wireless Hands Free Personal Speakerphone	21
To Play with Non-Bluetooth Devices Use a 3.5mm Stereo Audio Cable.....	22
Reset Function	23
Using the OontZ App.....	24 - 31
Contacting Customer Support	32
Safety and Precautions	33 - 34

Buttons & Built-in Mic

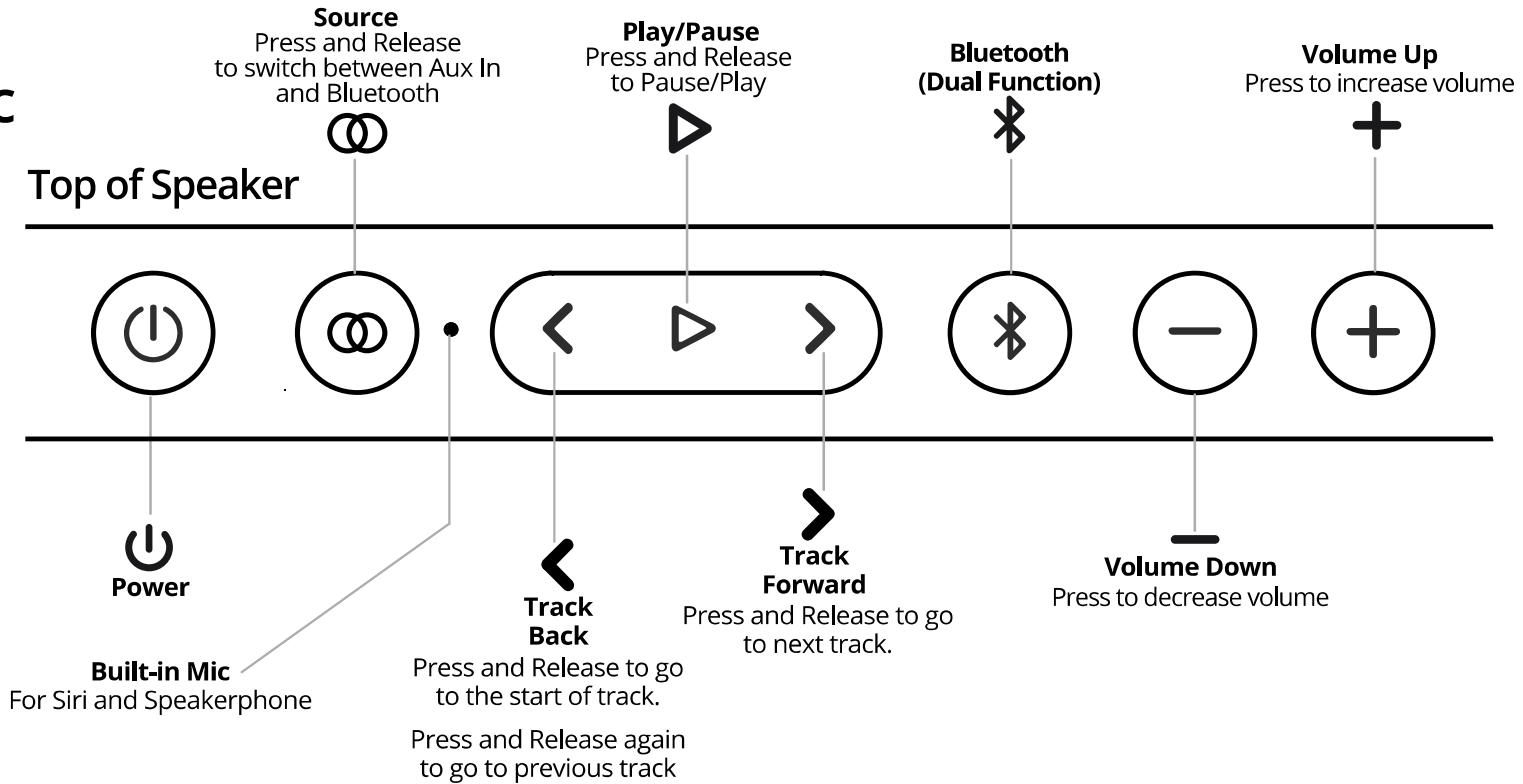

Important - The volume control on your device and the speaker work independently of each other.

To play the speaker at the loudest volume, set the volume on your device to maximum and raise the volume on the speaker to maximum.

Important - Some apps may not support track back, track forward, or play/pause

Lights

Green Light lit when Aux In is selected audio source

No Light lit when Bluetooth is selected audio source

Green Light lit when connected to OontZ app on iPhone or Smartphone running the Android operating system.

White/Orange Light Lit when speaker is in OontZ Wireless Dual Stereo

- With a second OontZ Angle 3 Pro speaker (**sold separately**) you can wirelessly connect both speakers together to play with OontZ Wireless Dual Stereo.
- Using without the OontZ app both speakers will be lit solid White (Left Channel - Right Channel) or solid Orange (Dual Stereo)
- Using with the OontZ app the Play Control Speaker will be lit solid Green and the second speaker will be lit solid White (Left Channel - Right Channel) or solid Orange (Dual Stereo)
- For OontZ Wireless Dual Stereo instructions please see page 13.

Top of Speaker

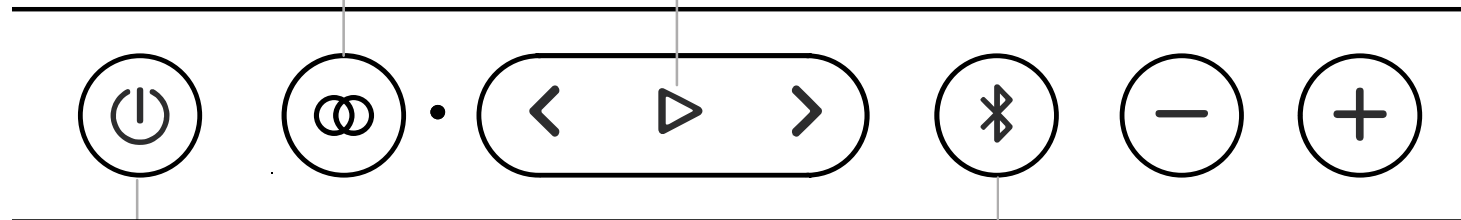

Red Light lit when charging:

- **Slowly flashing Red**
battery is charging
- **Solid Red**
battery is fully charged
- **Rapidly flashing Red when playing**
indicates battery charge is low

Blue Light lit when speaker is on:

- **Flashing Blue**
speaker is in Bluetooth pairing mode
- **Solid Blue**
speaker is connected to Bluetooth Device

Rubber Flap

Opening Rubber Flap

- covers connectors
- pull the tab from the top to access connectors, it is a snug fit as part of the waterproofing

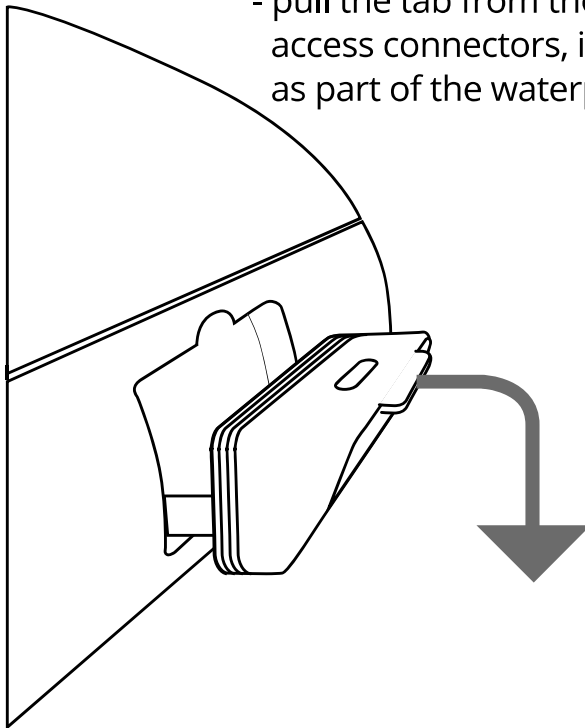

Closing Rubber Flap

- Align the Rubber Flap directly over the connector bay. Push the Rubber Flap straight in until the edges are even with the edges of the connector bay.

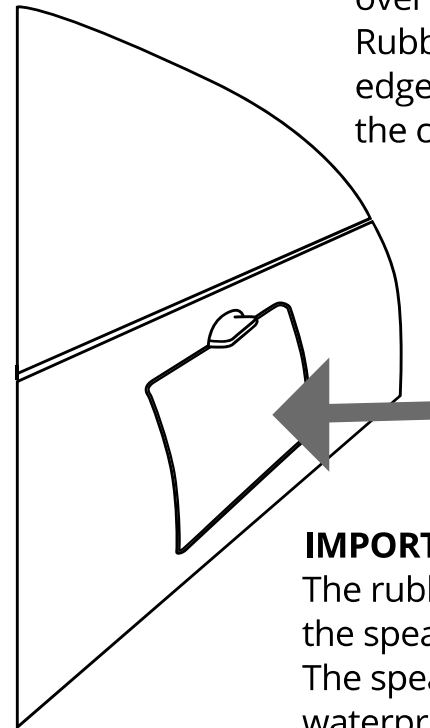

IMPORTANT:

The rubber flap needs to be closed before the speaker is exposed to water.

The speaker is not water-resistant or waterproof when the flap is open.

Connectors

USB Type C
Charging Connector

AUX IN Jack

Back of Speaker

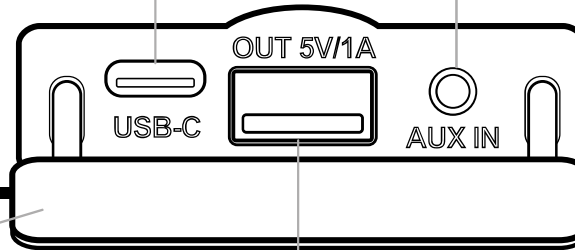

IMPORTANT:

The rubber flap needs to be closed before the speaker is exposed to water. The speaker is not water-resistant or waterproof when the flap is open.

USB Power Bank

- Use for keeping your Smartphone or iPhone charged while playing.
- Use to power your Echo Input.
- Output 5V - 1A

Battery Features

- The rechargeable battery comes with a partial charge and the speaker is ready to play.
- For maximum playtime, fully charge the battery.
- You can play while charging.

Low Charge Remaining

- When the battery charge has less than 20% remaining the Red Light will begin flashing rapidly.
- The volume will decrease to preserve the remaining battery charge.

Music Play Time

Up to 15 hours on a full charge, at 2/3 volume.
Louder volumes will reduce the battery play time.

Power Saving Feature

- When playing from battery power the OontZ Angle 3 Pro will turn off after 30 minutes of not playing audio to conserve the battery charge. *
- When plugged into a charging source the OontZ Angle 3 Pro will remain on until you turn the power off.
- You can continue to keep the speaker plugged into a charging source even when it is fully charged, keeping the speaker turned on and available

* Exception: certain devices, including the Amazon Echo Dot and Amazon Echo, disable the Power Saving Feature and the speaker will remain on until you turn the power off.

Charging the Battery

Red Light lit when charging:

- **Slowly flashing Red** battery is charging
- **Solid Red** battery is fully charged

Insert the small end of the USB Type C Charging Cable into the Charging Connector as shown.

Insert the larger end of the USB Type C Charging cable into a USB wall charger for a Smartphone or iPhone, or a USB port on your laptop/computer to charge the battery (see illustrations on page 7).

Charging Time - Up to 3 hours to fully charge a low battery.

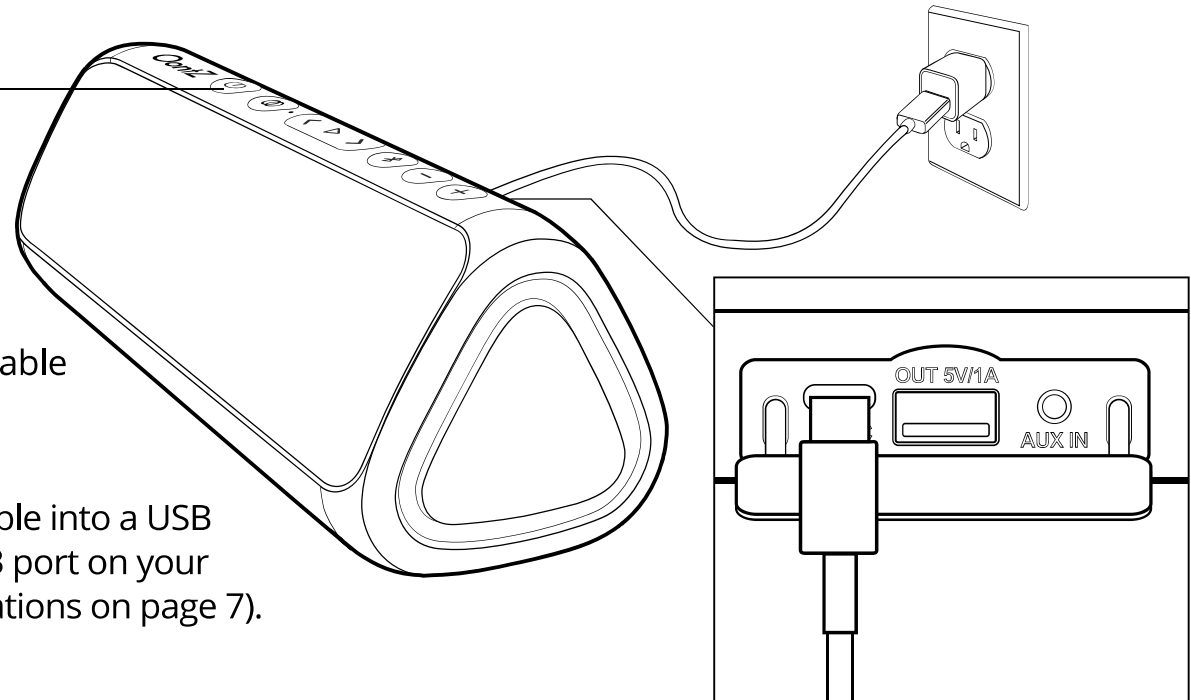

Important: When the OontZ Angle 3 Shower Pro is plugged in to a charging source with the USB Type C Charging Cable, never use the speaker in the shower, bath, or near water, to prevent risk of electric shock.

Charging the Battery (continued)

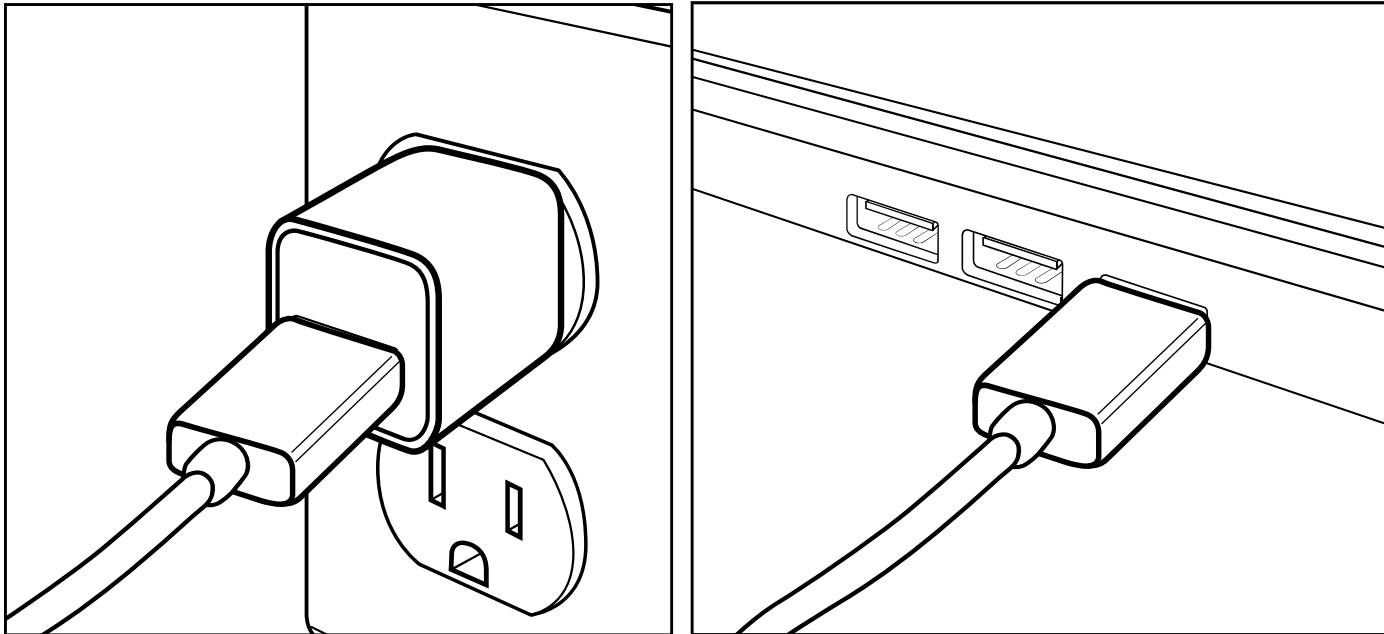

Insert the larger end of the USB Type C Charging Cable into a USB wall charger for a Smartphone or iPhone (USB wall charger* that is 5V \equiv 2.4A maximum), or a USB port on your laptop/computer to charge the OontZ Angle 3 Pro battery.

* Only use a USB wall charger that is UL listed. A UL listed USB wall charger will have the logo  printed on it.

Turning On and Off

Top of Speaker

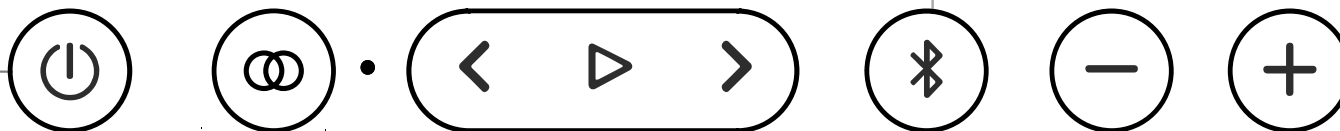

Blue Light will turn on after Red Light turns

- **Flashing Blue**
The speaker is in pairing mode
- **Solid Blue**
Your device has connected with the OontZ Angle 3 Pro and is ready to play

Turn ON

- Press and Release the Power Button 
- **Red Light** will turn on for 3 seconds and then turn off

Turn OFF

- Press and Hold Down the Power Button  for 2 Seconds
- **Blue Light** will turn off

Pair & Connect with Your Device -- Step 1

Turn ON your OontZ Angle 3 Pro

Flashing Blue Light

- The OontZ Angle 3 Pro is ready to pair and connect.

Solid Blue Light

- Your device has connected to the OontZ Angle 3 Pro and is ready to play.
- The OontZ Angle 3 Pro allows the last device it was connected with to automatically reconnect with the speaker each time the speaker is turned on and that device is within range.*

The OontZ Angle 3 Pro can be connected to one device at a time.

- To pair and connect to a different device, you need to first disconnect the currently paired device.
- To disconnect the current device, press and hold down the **Bluetooth button**  for 5 seconds.
- The **Blue Light** will begin **flashing** and the OontZ Angle 3 Pro is ready for the next device to pair and connect.

*Exception: certain devices may not automatically reconnect.

When connected to an Amazon Echo device it will not automatically reconnect. You will need to say to your Amazon Echo device, "Alexa, connect my speaker".

- Your device needs to be within 100 unobstructed feet of the OontZ Angle 3 Pro to pair and connect.
If there is an issue when connecting please move your device closer to the speaker, then pair and connect.
- When the charge is too low indicated by a flashing red light on the speaker, your device will not be able to connect with the speaker.

Top of Speaker

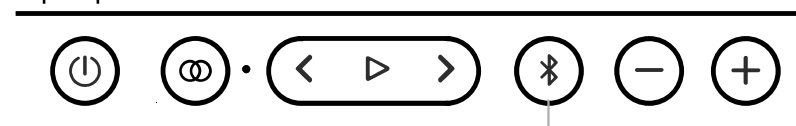

Pair & Connect with Your Device -- Step 2 --

-- With Your iPhone, iPad, or iPod

- Go to Settings > Bluetooth, check Bluetooth is on
- Select 'OontZ_Angle 3 Pro xxx' when it appears under DEVICES (xxx: 3 characters which are unique to your speaker)
- Your device will connect in a few seconds
- The **Blue Light** will turn solid blue and there will be a quiet chime
- You can now play your audio wirelessly to your OontZ Angle 3 Pro

-- With Your Smartphone, Tablet & Mobile Devices

- Go to Settings > Bluetooth, check Bluetooth is on
 - Scan or Search and select 'OontZ_Angle 3 Pro xxx' when it appears under AVAILABLE DEVICES (xxx: 3 characters which are unique to your speaker)
 - Your device will connect in a few seconds
 - The **Blue Light** will turn solid blue and there will be a quiet chime
 - You can now play your audio wirelessly to your OontZ Angle 3 Pro
- Note: Your Smartphone or Tablet instructions may vary

Important - The volume control on your device and the speaker work independently of each other. To play the speaker at the loudest volume, set the volume on your device to maximum and raise the volume on the speaker to maximum.

-- With Your Apple Mac or Windows Laptop/Computer

For the pairing and connecting guide for your Apple Mac or Windows laptop/computer, please visit: TheOontZ.com/pairing.

Note: The Alexa function is only available on your iPhone or Smartphone running the Android operating system.

Pair & Connect with Your Device -- Step 2 --

-- With Your Amazon Echo or Amazon Echo Dot

To pair and connect with the Amazon Echo or Amazon Echo Dot the first time use the Alexa app. For other Amazon Alexa devices please refer to their pairing and connecting instructions.

- Open the Alexa app
- Select your Amazon Echo device under 'Devices' by pressing it in lower left corner of the screen.
- Press 'Echo & Alexa'
- Select your Amazon Echo device by pressing it
- Press 'Bluetooth Devices'
- Press 'Pair a New Device'
- Select the 'OontZ_Angle 3 Pro xxx' (xxx: 3 characters unique to your speaker) when it appears in the list of 'Available Speakers'
- Alexa will announce: "Connected to OontZ_Angle 3 Pro xxx"

To connect the next time, turn on the OontZ Angle 3 Pro and say "Alexa, connect my speaker" or "Alexa, pair"

Pair & Connect with Your Device -- Step 2 --

-- With Your Amazon Echo or Amazon Echo Dot (continued)

Important Note: When the OontZ Angle 3 Pro is playing from battery power and connected to the Amazon Echo device, the speaker will remain on and it will not automatically turn off after 30 minutes of not playing audio. This will use up the battery charge.

We recommend to:

- 1) Keep the OontZ Angle 3 Pro plugged into a USB wall charger.
It can remain on and available to play from the Amazon Echo device.
- Or -
- 2) Turn off the OontZ Angle 3 Pro when you are done listening.
 - Either turn off the speaker by pressing and holding down the power button  for 2 seconds,
 - or say "Alexa, disconnect my speaker" and the OontZ Angle 3 Pro will automatically turn off after 30 minutes.
 - When you want to connect and play to the speaker again turn on the OontZ Angle 3 Pro and say "Alexa, connect my speaker" or "Alexa, pair".

For assistance with the Alexa app, contact Amazon's Customer Service.
Open the Alexa app and select Help & Feedback > Email Customer Service

OontZ Wireless Dual Stereo - Connect two OontZ Angle 3 Pro speakers together

Play your music wirelessly through both speakers up to 100 feet apart*

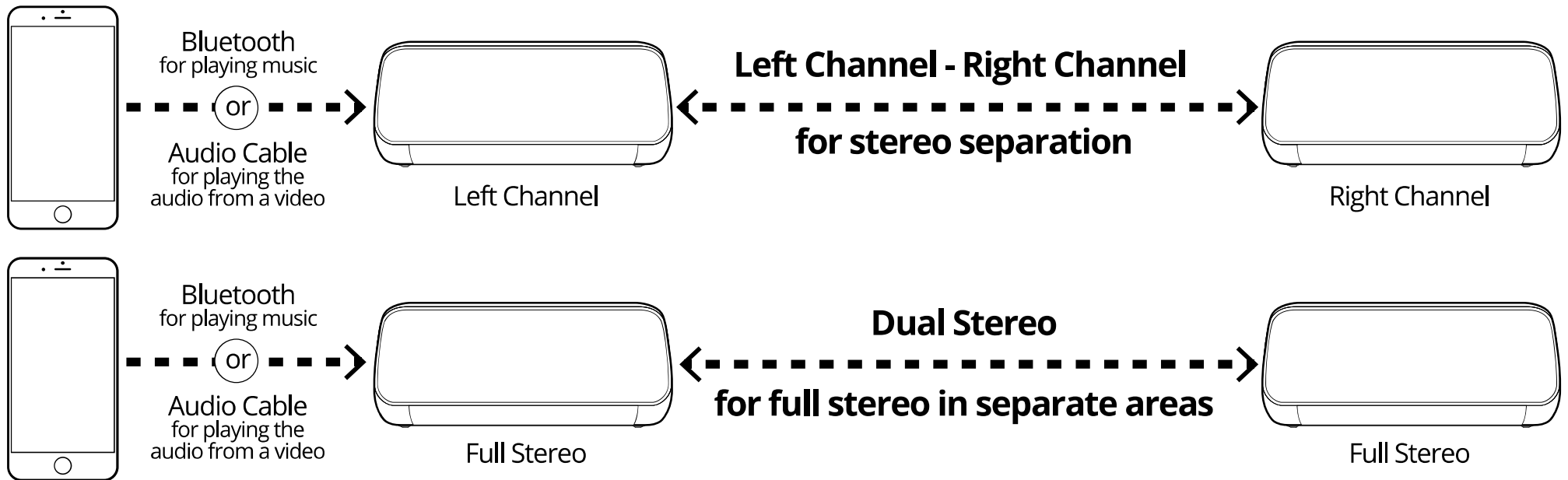

*Placing the speakers on the ground or having walls or obstructions between the speakers will significantly reduce the distance apart the two speakers can play together

Connecting two OontZ Angle 3 Pro speakers together for Left Channel - Right Channel (Without using OontZ app)

- Turn on both OontZ Angle 3 Pro speakers. 
- Pair and Connect one of the speakers with your device. When connected the Bluetooth Button light will be lit Solid Blue. This speaker will serve as the **Play Control Speaker**.
- The second speaker must not be connected to any device, its Bluetooth Button light needs to be flashing. If the second speaker has a solid Blue Light it is connected to a device and you need to disconnect it, by pressing and holding down the **Bluetooth Button**  for 5 seconds until the Bluetooth Button light begins flashing.
- On the **Play Control Speaker** (speaker with solid Blue Light) press and hold down the **Play/Pause button**  for 5 seconds until the Play/Pause Button is flashing with a White Light and the speaker says "Dual Pairing".
- On the **Second Speaker** (speaker with flashing Blue Light) press and release the **Play/Pause button**  twice.
- After a few seconds both speakers Play/Pause Button will be lit with a solid White light. The **Play Control Speaker** will say "Left Channel" and the second speaker will say "Right Channel" and the speakers will be connected together for Left Channel - Right Channel and you are ready to play.

Two OontZ Angle 3 Pro Speakers connected for Left Channel - Right Channel (Without using OontZ app)

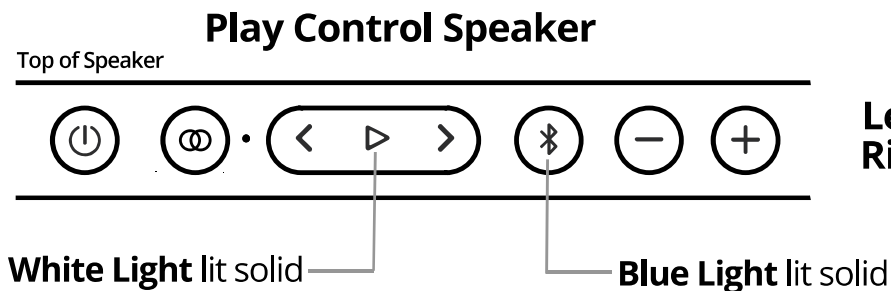



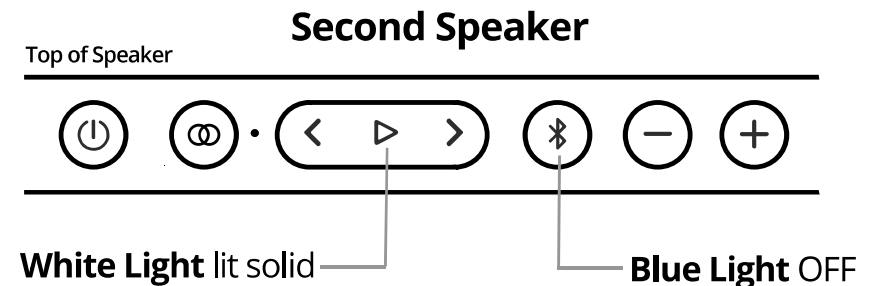

**Left Channel -
Right Channel**



- Use the buttons on the **Play Control Speaker** for play/pause, track back, track forward, answer and end phone calls. These controls are disabled on the second speaker when paired together.
- Use the **Play Control Speaker** for connecting to different audio devices via Bluetooth or AUX IN. The Bluetooth and AUX IN are disabled on the second speaker when paired together.
- Speakerphone call audio will only play through the **Play Control Speaker**

Connecting two OontZ Angle 3 Pro speakers together for Left Channel - Right Channel (Using OontZ app)

- Turn on both OontZ Angle 3 Pro speakers. 
- Open the OontZ app and connect with one of the OontZ Angle 3 Pro speakers. (See page 24 for instructions on using the OontZ app)
- Pair and Connect the speaker with your device that is connected with the OontZ app as indicated by the Play/Pause Button being lit solid Green. When connected to your device the Bluetooth Button light will be lit solid Blue. This speaker will serve as the **Play Control Speaker**.
- The second speaker must not be connected to any device, its Bluetooth Button light needs to be flashing. If the second speaker has a solid Blue Light it is connected to a device and you need to disconnect it, by pressing and holding down the **Bluetooth Button**  for 5 seconds until the Bluetooth Button light begins flashing.
- On the **Play Control Speaker** (speaker with solid Blue Light) press and hold down the **Play/Pause button**  for 5 seconds until the Play/Pause Button is flashing with an alternating Green and White Light and the speaker says "Dual Pairing".
- On the **Second Speaker** (speaker with flashing Blue Light) press and release the **Play/Pause button**  twice.
- After a few seconds The **Play Control Speaker** Play/Pause Button will be lit with a solid Green light and will say "Left Channel". The second speaker Play/Pause Button will be lit with a solid White light and will say "Right Channel" and the speakers will be connected together for Left Channel - Right Channel and you are ready to play.

Two OontZ Angle 3 Pro Speakers connected for Left Channel - Right Channel (Using OontZ app)

The OontZ app allows changing to Dual Stereo from Left Channel - Right Channel and back to Left Channel - Right Channel from Dual Stereo. Refer to Page 29 for instructions on using the OontZ app for OontZ Wireless Dual Stereo.

The second speaker will indicate whether the mode is Left Channel - Right Channel (Play/Pause Button lit solid White) or Dual Stereo (Play/Pause Button lit solid Orange).



- Use the buttons on the **Play Control Speaker** for play/pause, track back, track forward, answer and end phone calls. These controls are disabled on the second speaker when paired together.
- Use the **Play Control Speaker** for connecting to different audio devices via Bluetooth or AUX IN. The Bluetooth and AUX IN are disabled on the second speaker when paired together.
- Speakerphone call audio will only play through the **Play Control Speaker**

Changing to Dual Stereo from Left Channel - Right Channel

Use Dual Stereo when placing the two speakers in different areas, and both speakers will play in full stereo.

- To set both speakers for Dual Stereo they must first be connected together for Left Channel - Right Channel (see page 14 or page 16 if using the OontZ app).
- With the speakers connected together for **Left Channel - Right Channel**, you can change the speakers to **Dual Stereo**.
- To change to Dual Stereo, press and hold down the **Track Forward button** > on the **Play Control Speaker** for 5 seconds until the White Lights turn solid Orange on both speakers.
 - When using the OontZ app the **Play Control Speaker** will remain solid Green and the second speaker solid White light turns solid Orange.
- Both speakers will say "Dual Stereo" and you are ready to play.
- The OontZ app can also be used to change Dual Stereo from Left Channel - Right Channel. Refer to Page 29 for instructions on using the OontZ app for OontZ Wireless Dual Stereo.

Changing back to Left Channel - Right Channel from Dual Stereo

- To change back to Left Channel - Right Channel, press and hold down the **Track Forward button** > on the **Play Control Speaker** for 5 seconds until the Orange Lights turn solid White on both speakers.
 - When using the OontZ app the **Play Control Speaker** will remain solid Green and the second speaker solid Orange light turns solid White.
- The **Play Control Speaker** will say "Left Channel" and the second speaker will say "Right Channel" and you are ready to play.
- The OontZ app can also be used to change back to Left Channel - Right Channel from Dual Stereo. Refer to Page 29 for instructions on using the OontZ app for OontZ Wireless Dual Stereo.

OontZ Wireless Dual Stereo - Important Notes

Turning the speakers off

- Turning the **Play Control Speaker** off will turn both speakers off.
- Turning the second speaker off first will only turn that speaker off and the **Play Control Speaker** will play as a single speaker.

Turning the speakers back on

- Turn both speakers on and they will automatically try to connect to each other again.
- Turn one of the speakers on and a device can connect with it, and play as a single speaker.

Disconnecting the two speakers from each other

- Both speakers need to be turned on.
- On the **Play Control Speaker** press and hold down the **Play/Pause button**  for 5 seconds. The White Lights will turn off and the speakers will be disconnected from each other.
- The OontZ app can also be used to disconnect the two speakers from each other. Refer to Page 29 for instructions on using the OontZ app for OontZ Wireless Dual Stereo.

Playing the audio from a video in OontZ Wireless Dual Stereo

- To play the audio from a video or TV in OontZ Wireless Dual Stereo you will need to connect the **Play Control Speaker** to your device or TV using a 3.5mm audio cable, allowing the audio and video to play in sync with each other. If the **Play Control Speaker** is connected over Bluetooth to your device or TV there will be a delay in the audio playback from a video.

IPX7 Waterproof

The OontZ Angle 3 Pro is Waterproof and it is IPX7 certified

The perfect speaker for listening to your favorite music in any environment
Perfect for taking to the beach and listening by the pool

IPX7 means the OontZ Angle 3 Pro is Waterproof and can handle water spray or being splashed and can handle being partially or fully submerged in water up to a maximum of 3 feet deep, for up to a maximum of 30 minutes

The rubber flap needs to be closed for the speaker to be waterproof and dustproof.

Important Safety Precaution: When the OontZ Angle 3 Pro speaker is plugged in to a charging source with the USB Type C charging cable, never use the speaker in the shower, bath, or near water, to prevent risk of electric shock.

Talk to Siri on your iPhone or iPad through the OontZ Angle 3 Pro

This feature works when connected to an iPhone or an iPad over Bluetooth.

To talk to Siri through the OontZ Angle 3 Pro

- Press and Release the Bluetooth Button  on the OontZ Angle 3 Shower
- The blue light will turn to green and flash 3 times
- Wait for about two seconds until you hear a "chime"
- After the "chime" talk to Siri through the mic on the OontZ Angle 3 Pro
- The response from Siri will then play through the OontZ Angle 3 Pro, and may display information on your iPhone or iPad

Your iPhone or iPad needs to be on the latest version of iOS

Wireless Hands Free Personal Speakerphone

The Wireless Hands Free Personal Speakerphone feature works over Bluetooth with Smartphones and iPhones only; this feature is not supported when connected to other types of devices.

To answer an Incoming Call / To End a Call

- Press and Release the Bluetooth Button 

To Reject an Incoming Call

- Press and Hold Down the Bluetooth Button  for 3 Seconds
- Please keep the speaker close in front of you so you may be heard clearly by the listener.
- You can use your Smartphone or iPhone to switch between using Hands Free Speakerphone and your phone.

To Play with Non-Bluetooth Devices Use a 3.5mm Stereo Audio Cable

Turn ON your OontZ Angle 3 Pro 

- Plug one end of the included 3.5mm stereo audio cable into the **AUX IN** jack on the speaker.
- Press the Source Button and the Source Button light will turn solid Green.
- Plug the other end of that 3.5mm stereo audio cable into the headphone jack on your device.
- Make sure both ends of the cable are fully inserted
- You are now ready to play.

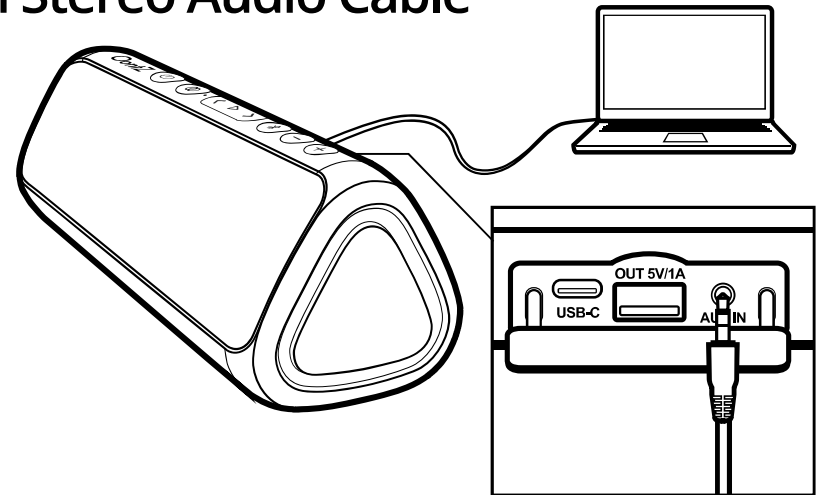

Important: The Bluetooth on the OontZ Angle 3 Pro is disabled when the Source Button is pressed. To switch back to Bluetooth press the Source Button and the OontZ Angle 3 Pro allows the last device it was connected to automatically reconnect with the speaker and that device is within range.

Important Notes:

- Note: The rubber flap needs to be closed before the speaker is exposed to water. The speaker is not water-resistant or waterproof when the flap is open.
- The volume control on your device and the speaker work independently of each other. To play the speaker at the loudest volume, set the volume on your device to maximum and raise the volume on the speaker to maximum.

Reset Function

Top of Speaker

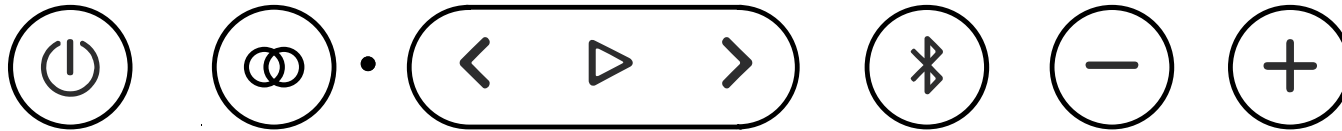

Step 1: Remove the USB Type C Charging cable and 3.5mm Audio cable, if connected.

Step 2: With the OontZ Angle 3 Pro on, press the **Power button**  and **Volume +** together and release. The speaker will then turn off.

Step 3: The speaker has now been reset and you can turn it on.

Using the OontZ App

Control the different functions of your OontZ Angle 3 Pro from your iPhone or Smartphone running the Android operation system - Download the OontZ app from the Apple App Store® or Google Play™ Store

- - 1) Open the Apple App Store® or Google Play™ Store on your iPhone or Smartphone running the Android operating system.
 - 2) Search for the “Oontz” app and install.
 - 3) After the app has been installed the “Oontz” app will appear on your iPhone or smartphone.



Using the OontZ App (Continued)

To pair and connect your OontZ Angle 3 Pro with the OontZ app

- Turn on your OontZ Angle 3 Pro speaker
- Launch the OontZ app and the Home screen will appear
- Select the Menu ☰ in the upper left hand corner of the OontZ app and the Menu screen will appear
- Select 'Speakers' from the Menu and the Speaker screen will appear
- Continue to the next page for instructions pairing and connecting to the OontZ Angle 3 Pro speaker.

Select the Home Button 🏠 in the upper right hand corner of the OontZ app at any time to return the Home screen.



Home screen

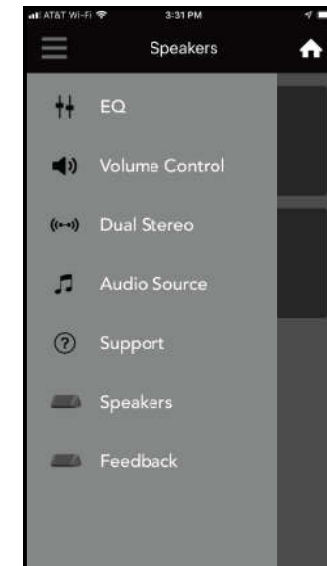

Menu screen

Using the OontZ App (Continued)

Pairing and connecting the OontZ app and OontZ Angle 3 Pro

Angle 3 Pro icon is Grey

- Press the Grey speaker icon on the app to pair and connect the app with the OontZ Angle 3 Pro
- Your OontZ Angle 3 Pro will connect in a few seconds
- The Grey speaker icon will turn Blue and the Play/Pause Button ▶ on the OontZ Angle 3 Pro will turn solid Green
- Your device is connected to the OontZ Speaker app and the app is ready to use.

If the Angle 3 Pro icon is Blue and Play/Pause Button on the OontZ Angle 3 Pro is solid Green

- Your OontZ Angle 3 Pro is already connected to the OontZ Speaker app and the app is ready to use.



Speaker screen

Note:

- When using two OontZ Angle 3 Pro speaker in OontZ Wireless Dual Stereo mode the app will connect with the Play Control Speaker only.
- When the OontZ app is paired with the Play Control Speaker the Play/Pause Button will be lit solid Green indicating connection to the OontZ app.
- The second speaker Play/Pause Button will be lit solid White for Left Channel - Right Channel or lit solid Orange for Dual Stereo.

Using the OontZ App (Continued)

The OontZ app allows you to control different speakers.

To utilize the app for a different OontZ Angle 3 Pro speaker.

- Select the Menu ☰ in the upper left hand corner of the app and select 'Speakers' from the menu
- Select the desired speaker from the available speakers icons shown
 - Speaker icon is Blue - this speaker is already connected to the OontZ app
 - Speaker icon is Grey - press and the app will pair and connect to this OontZ speaker.

The Play/Pause Button on the OontZ Angle 3 Pro will be lit solid Green to indicate it is connected to the OontZ Speaker app.

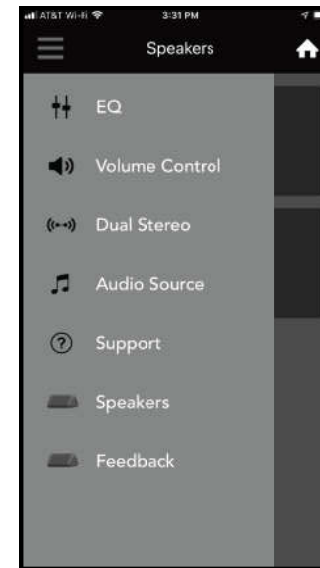

Menu screen



Speaker screen

Using the OontZ App (Continued)

Select the Menu ☰ in the upper left hand corner of the app and select 'EQ' from the menu to access the Speaker Equalizer screen or press 'Volume Control' to from the menu to access the Volume Control screen.

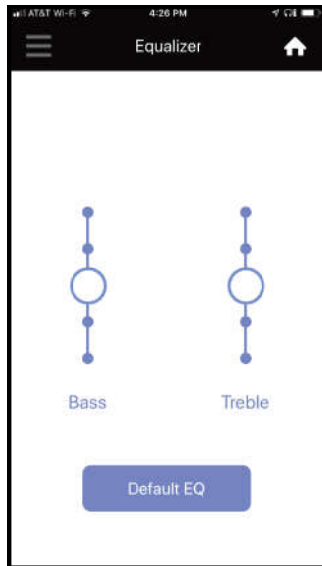

Speaker Equalizer screen

The Left slider adjusts the Bass and the Right slider the Treble.

Press "Default EQ" to set the EQ to the default setting for the OontZ Angle 3 Pro. The center position on each slider is the default EQ setting.

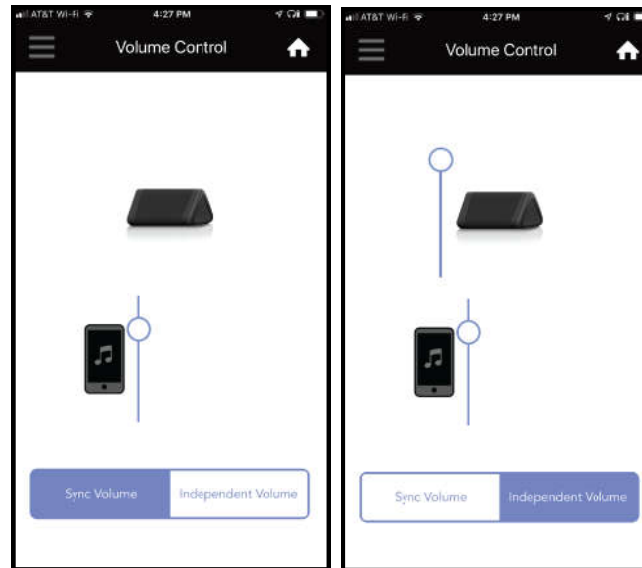

Volume Control screens

Press 'Sync Volume' to have the volume on the connected device control the volume of the OontZ Angle 3 Pro.

Press "Independent Volume" to have the volume controlled separately for the connected device control and for the OontZ Angle 3 Pro.

Using the OontZ App (Continued)

Select the Menu ☰ in the upper left hand corner of the app and select 'Dual Stereo' from the menu.

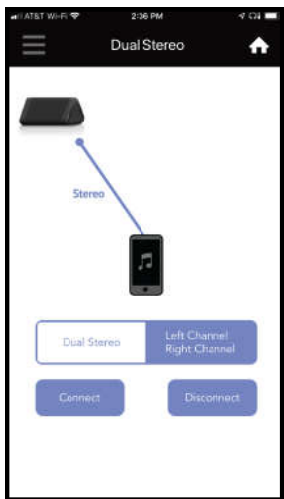

Press 'Connect' to reconnect* two OontZ Angle 3 Pro speakers in OontZ Wireless Dual Stereo mode or 'Disconnect' to disconnect two OontZ Angle 3 Pro

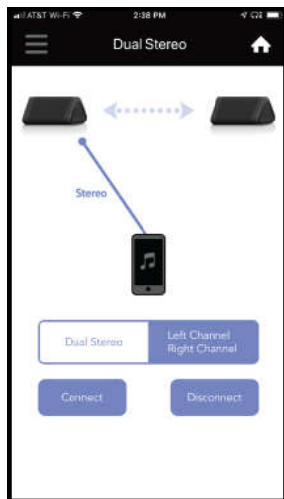

Press "Left Channel - Right Channel" to change two OontZ Angle 3 Pro connected speakers to Left Channel - Right Channel for stereo separation.

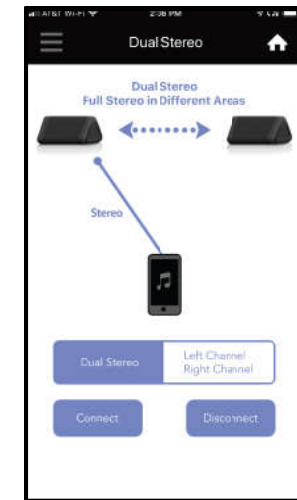
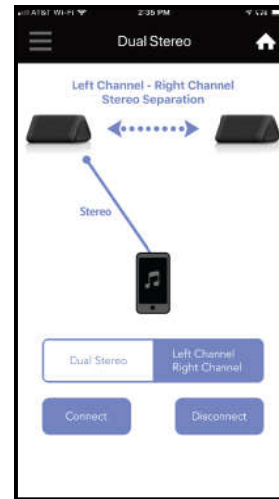

Press 'Dual Stereo' to change the two OontZ Angle 3 Pro connected speakers to Dual Stereo full stereo in separate areas.

* **Note:** Refer to page 16 for instructions on connecting two OontZ Angle 3 Pro speakers for the first time

Using the OontZ App (Continued)

Select the Menu ☰ in the upper left hand corner of the app and select 'Audio Source' from the menu.

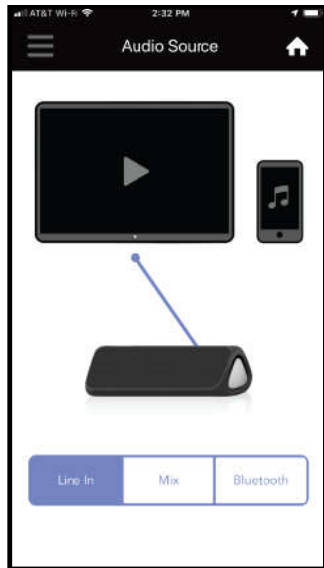

Press "Aux In" to change the audio source for the OontZ Angle 3 Pro to the device connected to the OontZ Angle 3 Pro Aux In jack. The Source Button on the OontZ Angle 3 Pro will be lit solid Green.

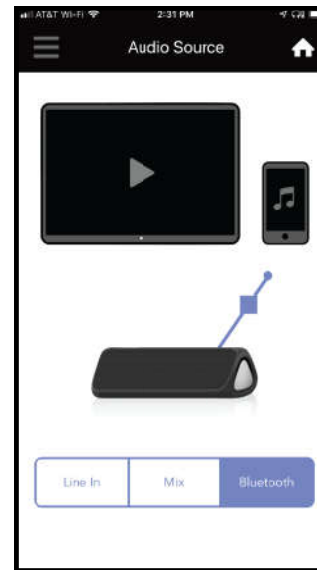

Press "Bluetooth" to change the audio source for the OontZ Angle 3 Pro to Bluetooth. The last device connected to the OontZ Angle 3 Pro will automatically reconnect. The Bluetooth Button on the OontZ Angle 3 Pro will flash Blue until reconnected to your device. After connected the Bluetooth Button will be lit Solid Blue.

Using the OontZ App (Continued)

Select the Menu ☰ in the upper left hand corner of the app and select 'Support' from the menu to access the Support screen or press 'Feedback' to from the menu to access the Feedback screen.

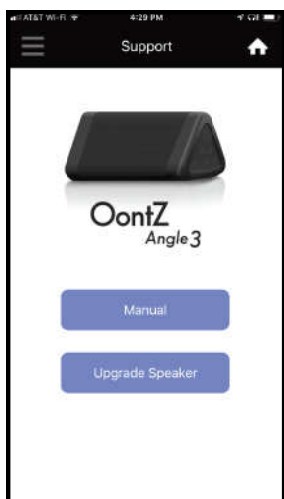

Press "Manual" to display the latest version of the online manual for the OontZ Angle 3 Pro.

Press "Update Speaker" to check the version of current firmware version on the OontZ Angle 3 Pro and whether there is a new version available.

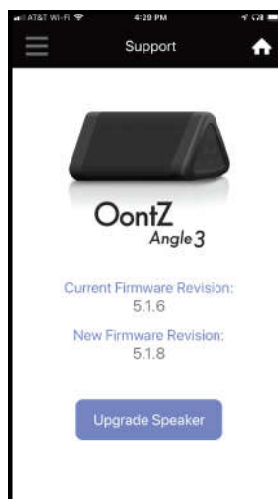

If there is a new version of firmware for the OontZ Angle 3 Pro it will be displayed under 'New Firmware Version' including the new version number of the update.

To update the OontZ Angle 3 Pro with the New Firmware Version press 'Update Speaker' and following the instructions in the OontZ app.

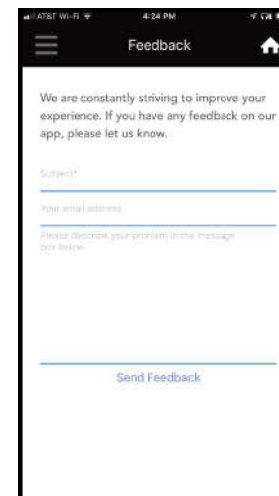

To provide feedback on the OontZ App please complete the form on the app and send to us. We appreciate your feedback in order to constantly improve the experience of the OontZ app.

Customer Support

If you have a question about your OontZ Angle 3 Pro or experience an issue with the speaker, our Customer Support Team wants to assist you.

For online troubleshooting tips please visit:

TheOontZ.com/troubleshooting

and select the OontZ Angle 3 Pro

For latest version of this manual please visit:

TheOontZ.com/pages/manuals

and select the OontZ Angle 3 Pro

Contact us at:

TheOontZ.com/support

and fill in our customer support form

Safety and Precautions

- 1. When the OontZ Angle 3 Pro speaker is plugged in to a charging source with the USB Type C Charging Cable, never use the speaker in the shower, bath, or near water, to prevent risk of electric shock.**
2. Read and follow all instructions – All operating and use instructions should be followed.
3. Protect the USB Type C Charging Cable from being pinched, particularly at the connectors.
4. Unplug the USB Type C Charging Cable during lightning storms or when unused for long periods of time.
5. Do not place speaker near any heat sources such as radiators, heat registers, stoves, or other apparatus (including amplifiers) that produce heat.
6. Refer all servicing to qualified personnel. Servicing is required when the speaker has been damaged in any way.
7. Do not make alterations to this speaker.
8. The battery in the speaker is not replaceable. Do not attempt to change it.
9. Use this speaker only with an agency approved power supply which meets local regulatory requirements (e.g., UL, CSA, VDE, CCC) in accordance with the manufacturer's specifications.
10. Do not place near naked flame sources, such as lighted candles, on or near the speaker.
11. Do not expose this speaker to excessive heat (e.g. from storage in direct sunlight, fire or the like)
12. If the battery leaks, do not allow the liquid to come in contact with the skin or eyes. If contact is made, seek medical advice.

Safety and Precautions (continued)

This device complies with Part 15 of the FCC Rules. Operation is subject to the following two conditions:

(1) This device may not cause harmful interference, and (2) this device must accept any interference received, including interference that may cause undesired operation.

NOTE 1: This equipment has been tested and found to comply with the limits for a Class B digital device, pursuant to part 15 of the FCC Rules. These limits are designed to provide reasonable protection against harmful interference in a residential installation. This equipment generates, uses and can radiate radio frequency energy and, if not installed and used in accordance with the instructions, may cause harmful interference to radio communications. However, there is no guarantee that interference will not occur in a particular installation. If this equipment does cause harmful interference to radio or television reception, which can be determined by turning the equipment off and on, the user is encouraged to try to correct the interference by one or more of the following measures:

- Reorient or relocate the receiving antenna.
- Increase the separation between the equipment and receiver.
- Connect the equipment into an outlet on a circuit different from that to which the receiver is connected.
- Consult the dealer or an experienced radio/TV technician for help.

NOTE 2: Any changes or modifications to this unit not expressly approved by the party responsible for compliance could void the user's authority to operate the equipment.

Apple, iPhone, iPad, iPod, Mac and Siri are registered trademarks of Apple Inc.

Amazon, Amazon Echo and Amazon Echo Dot are registered trademarks of Amazon.com, Inc.

Windows is a registered trademark of Microsoft Corporation

Bluetooth is a registered trademark of Bluetooth SIG, Inc

UL is a registered trademark of UL.

OontZ Bluetooth Adapter

Sold separately

- Transmit Low Latency wireless audio from your TV and Video device to your OontZ Angle 3 Pro.
- Pairs with a single button to one or two OontZ Angle 3 Pro speakers



OontZ Bluetooth Speaker Official Mounting Strap

Sold separately

- Securely strap your OontZ speaker quickly to take with you
- Perfect for strapping an OontZ Portable Bluetooth Speaker to bicycles, scooters, golf carts, boats, and other mountable object
- Made of stretchable durable rubberized material for a secure fit



OontZ Angle 3 BudZ

Sold separately

- Totally Waterproof & Sweatproof
- Ultra-Comfortable and Secure Fit
- Superior Sound with Deep Bass
- Noise Cancellation of Background Noise
- Listen All Day with Playtime up to 8 hours
- Perfect For Any Activity



Available at TheOontZ.com