



# TEST REPORT

## FCC PART 15 SUBPART C 15.247 & RSS 247

Report Reference No. ....: CTL1603070590-WF-03

Compiled by: Jacky Chen  
( position+printed name+signature) (File administrators) \_\_\_\_\_

Tested by: Allen Wang  
( position+printed name+signature) (Test Engineer) \_\_\_\_\_

Approved by: Tracy Qi  
( position+printed name+signature) (Manager) \_\_\_\_\_

Product Name.....: Smart home gateway

Model/Type reference .....: FCL5320V02

List Model(s).....: N/A

Trade Mark .....: N/A

FCC ID .....: 2AG9G-FCL5320A

IC .....: 5248W-FCL5320A

Applicant's name .....: Flextronics America LLC

Address of applicant .....: 3300 Holcomb Bridge Rd.Suite #290, Norcross GA 30092 USA

Test Firm .....: Shenzhen CTL Testing Technology Co., Ltd.

Address of Test Firm .....: Floor 1-A, Baisha Technology Park, No.3011, Shahehexi Road, Nanshan District, Shenzhen, China 518055

Test specification .....: 47 CFR FCC Part 15 Subpart C 15.247 & RSS 247 Issue 1, May 2015

Standard.....: Shenzhen CTL Testing Technology Co., Ltd.

TRF Originator .....: Dated 2011-01

Master TRF .....: Dec.22, 2015

Date of Receipt.....: Dec.23, 2015–Jan. 06, 2016

Date of Test Date.....: Mar.16, 2016

Data of Issue.....: Positive

Result.....: Positive

**Shenzhen CTL Testing Technology Co., Ltd. All rights reserved.**  
This publication may be reproduced in whole or in part for non-commercial purposes as long as the Shenzhen CTL Testing Technology Co., Ltd. is acknowledged as copyright owner and source of the material. Shenzhen CTL Testing Technology Co., Ltd. takes no responsibility for and will not assume liability for damages resulting from the reader's interpretation of the reproduced material due to its placement and context.

# TEST REPORT

<b>Test Report No. :</b>	<b>CTL1603070590-WF-03</b>	Mar.16, 2016
		Date of issue

Equipment under Test : Smart home gateway

Model /Type : FCL5320V02

Listed Models : /

**Applicant** : **Flextronics America LLC**

Address : 3300 Holcomb Bridge Rd.Suite #290, Norcross GA 30092 USA

**Manufacturer** : **Flextronics Manufacturing (Zhuhai) Co., Ltd.**

Address : Xin Qing Science & Technology industrial Park, Jing An Town,  
Zhuhai, PR China

<b>Test result</b>	<b>Pass *</b>
--------------------	---------------

\* In the configuration tested, the EUT complied with the standards specified page 5.

The test report merely corresponds to the test sample.

It is not permitted to copy extracts of these test result without the written permission of the test laboratory.

**\*\* Modified History \*\***

Revisions	Description	Issued Data	Report No.	Remark
Version 1.0	Initial Test Report Release	2016-03-16	CTL1603070590-WF-03	Tracy Qi



## Table of Contents

Page

<b>1. SUMMARY</b> .....	<b>5</b>
1.1. TEST STANDARDS.....	5
1.2. TEST DESCRIPTION.....	5
1.3. TEST FACILITY.....	6
1.4. STATEMENT OF THE MEASUREMENT UNCERTAINTY.....	6
<b>2. GENERAL INFORMATION</b> .....	<b>7</b>
2.1. ENVIRONMENTAL CONDITIONS.....	7
2.2. GENERAL DESCRIPTION OF EUT.....	7
2.3. DESCRIPTION OF TEST MODES AND TEST FREQUENCY.....	7
2.4. EQUIPMENTS USED DURING THE TEST.....	8
2.5. RELATED SUBMITTAL(S) / GRANT (S).....	8
2.6. MODIFICATIONS.....	8
<b>3. TEST CONDITIONS AND RESULTS</b> .....	<b>9</b>
3.1. CONDUCTED EMISSIONS TEST.....	9
3.2. RADIATED EMISSIONS AND BAND EDGE.....	12
3.3. MAXIMUM CONDUCTED OUTPUT POWER.....	18
3.4. POWER SPECTRAL DENSITY.....	19
3.5. 6dB BANDWIDTH.....	21
3.6. OUT-OF-BAND EMISSIONS.....	23
<b>4. TEST SETUP PHOTOS OF THE EUT</b> .....	<b>26</b>
<b>5. EXTERNAL AND INTERNAL PHOTOS OF THE EUT</b> .....	<b>28</b>

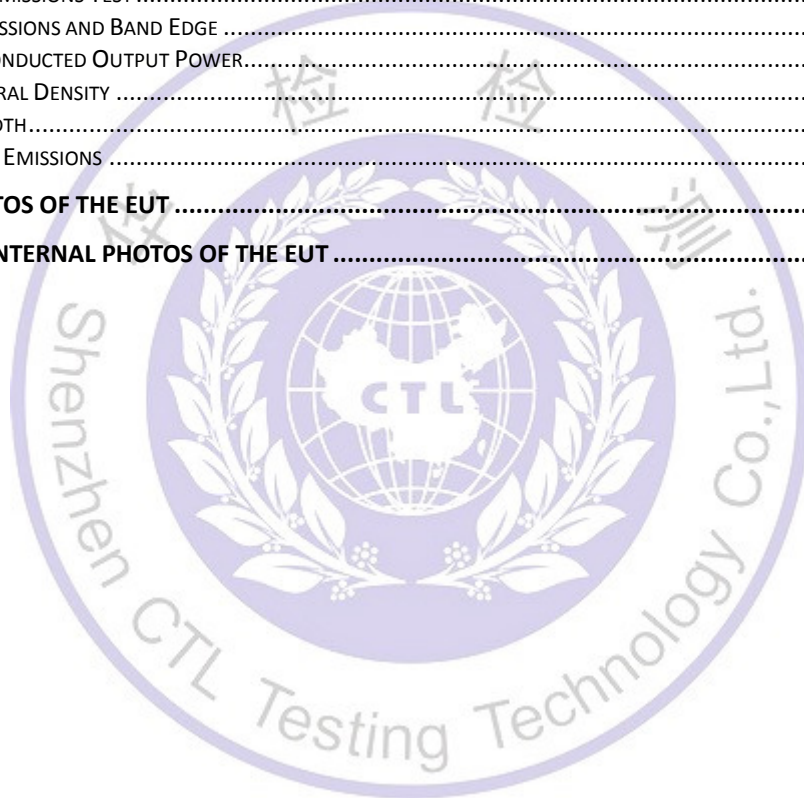

# 1. SUMMARY

## 1.1. TEST STANDARDS

The tests were performed according to following standards:

**FCC Rules Part 15.247:** Frequency Hopping, Direct Spread Spectrum and Hybrid Systems that are in operation within the bands of 902-928 MHz, 2400-2483.5 MHz, and 5725-5850 MHz

**RSS-247-Issue 1:** Digital Transmission Systems (DTSSs), Frequency Hopping Systems (FHSs) and Licence-Exempt Local Area Network (LE-LAN) Devices.

**RSS-Gen Issue 4:** — General Requirements for Compliance of Radio Apparatus

**ANSI C63.10:2013 :** American National Standard for Testing Unlicensed Wireless Devices

**ANSI C63.4: 2014:** –American National Standard for Methods of Measurement of Radio-Noise Emissions from Low-Voltage Electrical and Electronic Equipment in the Range of 9 kHz to 40GHz

## 1.2. Test Description

FCC and IC Requirements		
FCC Part 15.207 RSS-Gen 8.8	AC Power Conducted Emission	PASS
FCC Part 15.247(a)(2) RSS 247 5.2 (1)	6dB Bandwidth	PASS
FCC Part 15.247(d) RSS 247 5.5	Spurious RF Conducted Emission	PASS
FCC Part 15.247(b) RSS 247 5.4 (4)	Maximum Conducted Output Power	PASS
FCC Part 15.247(e) RSS 247 5.2 (2)	Power Spectral Density	PASS
FCC Part 15.205/ 15.209 RSS-Gen 8.9	Radiated Emissions	PASS
FCC Part 15.247(d) RSS-Gen 8.10	Band Edge	PASS

## 1.3. Test Facility

### 1.3.1 Address of the test laboratory

Shenzhen CTL Testing Technology Co., Ltd.

Floor 1-A, Baisha Technology Park, No. 3011, Shahexi Road, Nanshan, Shenzhen 518055 China

There is one 3m semi-anechoic chamber and two line conducted labs for final test. The Test Sites meet the requirements in documents ANSI C63.4 and CISPR 22/EN 55022 requirements.

### 1.3.2 Laboratory accreditation

The test facility is recognized, certified, or accredited by the following organizations:

#### IC Registration No.: 9618B

The 3m alternate test site of Shenzhen CTL Testing Technology Co., Ltd. EMC Laboratory has been registered by Certification and Engineer Bureau of Industry Canada for the performance of with Registration No.: 9618B on November 13, 2013.

#### FCC-Registration No.: 970318

Shenzhen CTL Testing Technology Co., Ltd. EMC Laboratory has been registered and fully described in a report filed with the (FCC) Federal Communications Commission. The acceptance letter from the FCC is maintained in our files. Registration 970318, December 19, 2013.

## 1.4. Statement of the measurement uncertainty

The data and results referenced in this document are true and accurate. The reader is cautioned that there may be errors within the calibration limits of the equipment and facilities. The measurement uncertainty was calculated for all measurements listed in this test report acc. to CISPR 16 - 4 "Specification for radio disturbance and immunity measuring apparatus and methods – Part 4: Uncertainty in EMC Measurements" and is documented in the Shenzhen CTL Testing Technology Co., Ltd. quality system acc. to DIN EN ISO/IEC 17025. Furthermore, component and process variability of devices similar to that tested may result in additional deviation. The manufacturer has the sole responsibility of continued compliance of the device.

Hereafter the best measurement capability for CTL laboratory is reported:

Test	Measurement Uncertainty	Notes
Transmitter power conducted	±0.57 dB	(1)
Transmitter power Radiated	±2.20 dB	(1)
Conducted spurious emission 9KHz-40 GHz	±2.20 dB	(1)
Occupied Bandwidth	±0.01ppm	(1)
Radiated Emission 30~1000MHz	±4.10dB	(1)
Radiated Emission Above 1GHz	±4.32dB	(1)
Conducted Disturbance0.15~30MHz	±3.20dB	(1)

- (1) This uncertainty represents an expanded uncertainty expressed at approximately the 95% confidence level using a coverage factor of k=2.

## 2. GENERAL INFORMATION

### 2.1. Environmental conditions

During the measurement the environmental conditions were within the listed ranges:

Normal Temperature:	25°C
Relative Humidity:	55 %
Air Pressure:	101 kPa

### 2.2. General Description of EUT

Product Name:	Smart home gateway
Model/Type reference:	FCL5320V02
Power supply:	AC 120V/60Hz
HVIN:	FCL5320v02
PMN:	FCL5320
FVIN:	v1.0
<b>Bluetooth BLE</b>	
Supported type:	Version 4.0 for low Energy
Modulation:	GFSK
Operation frequency:	2402MHz to 2480MHz
Channel separation:	2 MHz
Channel Number	40
Antenna type:	PIFA Antenna
Antenna gain:	2.50dBi

Note: For more details, refer to the user's manual of the EUT.

### 2.3. Description of Test Modes and Test Frequency

The Applicant provides communication tools software to control the EUT for staying in continuous transmitting (Duty Cycle more than 98%) and receiving mode for testing.

There are 39 channels provided to the EUT and Channel 00/19/39 were selected for BT4.0 test.

#### Operation Frequency List BT4.0 :

Channel	Frequency (MHz)
<b>00</b>	<b>2402</b>
02	2404
03	2406
⋮	⋮
<b>19</b>	<b>2440</b>
⋮	⋮
37	2476
38	2478
<b>39</b>	<b>2480</b>

Note: The line display in grey were the channel selected for testing

## 2.4. Equipments Used during the Test

Test Equipment	Manufacturer	Model No.	Serial No.	Calibration Date	Calibration Due Date
LISN	R&S	ENV216	3560.6550.1 2	2015/06/02	2016/06/01
LISN	R&S	ESH2-Z5	860014/010	2015/06/02	2016/06/01
Power Meter	Anritsu	ML2487B	110553	2015/06/02	2016/06/01
Power Sensor	Anritsu	MA2411B	100345	2015/05/21	2016/05/20
Bilog Antenna	Sunol Sciences Corp.	JB1	A061713	2015/06/02	2016/06/01
EMI Test Receiver	R&S	ESCI	103710	2015/06/02	2016/06/01
Spectrum Analyzer	Agilent	E4407B	MY41440676	2015/05/21	2016/05/20
Controller	EM Electronics	Controller EM 1000	N/A	2015/05/21	2016/05/20
Horn Antenna	Sunol Sciences Corp.	DRH-118	A062013	2015/05/19	2016/05/18
Active Loop Antenna	SCHWARZBECK	FMZB1519	1519-037	2015/05/19	2016/05/18
Amplifier	Agilent	8349B	3008A02306	2015/05/19	2016/05/18
Amplifier	Agilent	8447D	2944A10176	2015/05/19	2016/05/18
Temperature/Humidity Meter	Gangxing	CTH-608	02	2015/05/20	2016/05/19
High-Pass Filter	K&L	9SH10-2700/X1 2750-O/O	N/A	2015/05/20	2016/05/19
High-Pass Filter	K&L	41H10-1375/U1 2750-O/O	N/A	2015/05/20	2016/05/19
Coaxial Cables	HUBER+SUHNER	SUCOFLEX 104PEA-10M	10m	2015/06/02	2016/06/01
Coaxial Cables	HUBER+SUHNER	SUCOFLEX 104PEA-3M	3m	2015/06/02	2016/06/01
Coaxial Cables	HUBER+SUHNER	SUCOFLEX 104PEA-3M	3m	2015/06/02	2016/06/01
RF Cable	Megalon	RF-A303	N/A	2015/06/02	2016/06/01

The calibration interval was one year

## 2.5. Related Submittal(s) / Grant (s)

This submittal(s) (test report) is intended for FCC ID: 2AG9G-FCL5320A & IC:5248W-FCL5320A filing to comply with Section 15.247 of the FCC Part 15, Subpart C Rules & RSS 247.

## 2.6. Modifications

No modifications were implemented to meet testing criteria.



### 3. TEST CONDITIONS AND RESULTS

#### 3.1. Conducted Emissions Test

##### LIMIT

FCC CFR Title 47 Part 15 Subpart C Section 15.207 and RSS–Gen 8.8

Frequency range (MHz)	Limit (dBuV)	
	Quasi-peak	Average
0.15-0.5	66 to 56*	56 to 46*
0.5-5	56	46
5-30	60	50

\* Decreases with the logarithm of the frequency.

##### TEST CONFIGURATION

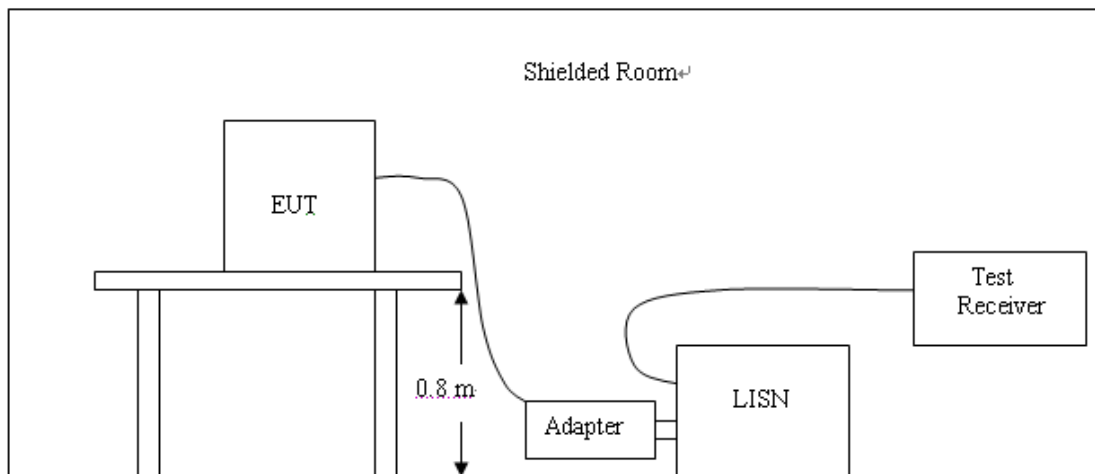

##### TEST PROCEDURE

1. The equipment was set up as per the test configuration to simulate typical actual usage per the user's manual. The EUT is a tabletop system; a wooden table with a height of 0.8 meters is used and is placed on the ground plane as per ANSI C63.10:2013.
2. Support equipment, if needed, was placed as per ANSI C63.10:2013
3. All I/O cables were positioned to simulate typical actual usage as per ANSI C63.10:2013.
4. The adapter received AC120V/60Hz power through a Line Impedance Stabilization Network (LISN) which supplied power source and was grounded to the ground plane.
5. All support equipments received AC power from a second LISN, if any.
6. The EUT test program was started. Emissions were measured on each current carrying line of the EUT using a spectrum Analyzer / Receiver connected to the LISN powering the EUT. The LISN has two monitoring points: Line 1 (Hot Side) and Line 2 (Neutral Side). Two scans were taken: one with Line 1 connected to Analyzer / Receiver and Line 2 connected to a 50 ohm load; the second scan had Line 1 connected to a 50 ohm load and Line 2 connected to the Analyzer / Receiver.
7. Analyzer / Receiver scanned from 150 KHz to 30MHz for emissions in each of the test modes.
8. During the above scans, the emissions were maximized by cable manipulation.

**TEST RESULTS**

Line:

L

**SCAN TABLE: "Voltage (9K-30M) FIN"**

Short Description: 150K-30M Voltage

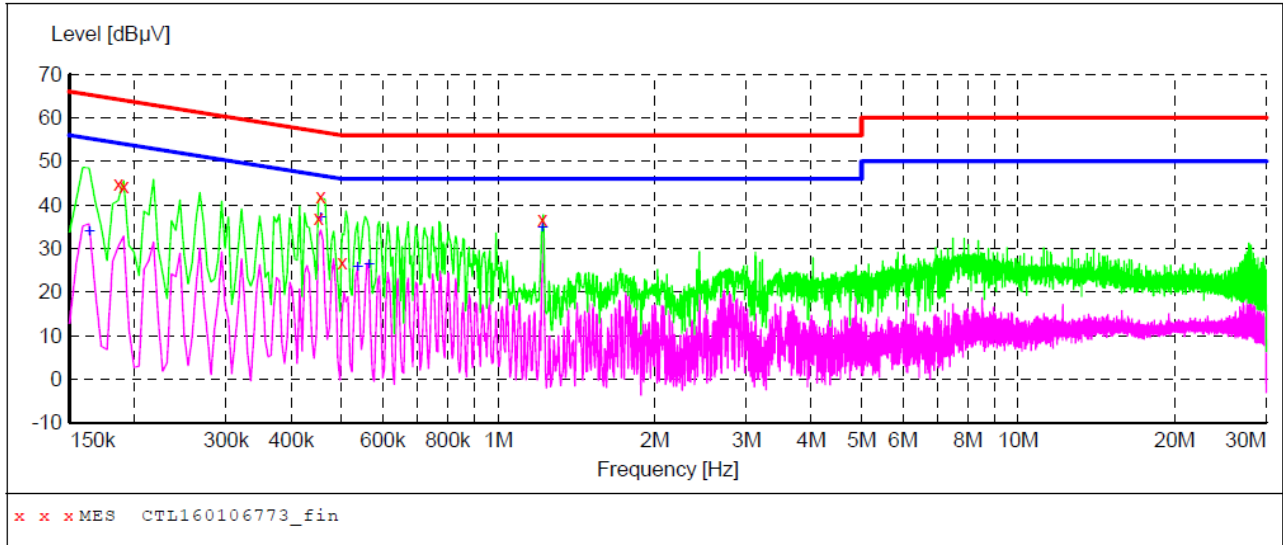

**MEASUREMENT RESULT: "CTL160106773\_fin"**

1/7/2016 10:08AM

Frequency MHz	Level dBµV	Transd dB	Limit dBµV	Margin dB	Detector	Line	PE
0.186001	44.90	10.2	64	19.3	QP	L1	GND
0.190501	44.40	10.2	64	19.6	QP	L1	GND
0.451501	36.90	10.2	57	19.9	QP	L1	GND
0.456001	41.90	10.2	57	14.9	QP	L1	GND
0.501001	26.80	10.2	56	29.2	QP	L1	GND
1.216501	36.70	10.3	56	19.3	QP	L1	GND

**MEASUREMENT RESULT: "CTL160106773\_fin2"**

1/7/2016 10:08AM

Frequency MHz	Level dBµV	Transd dB	Limit dBµV	Margin dB	Detector	Line	PE
0.163501	33.80	10.2	55	21.5	AV	L1	GND
0.456001	37.00	10.2	47	9.8	AV	L1	GND
0.537001	25.60	10.2	46	20.4	AV	L1	GND
0.564001	26.10	10.2	46	19.9	AV	L1	GND
1.216501	34.60	10.3	46	11.4	AV	L1	GND

Line:

N

**SCAN TABLE: "Voltage (9K-30M)FIN"**

Short Description: 150K-30M Voltage

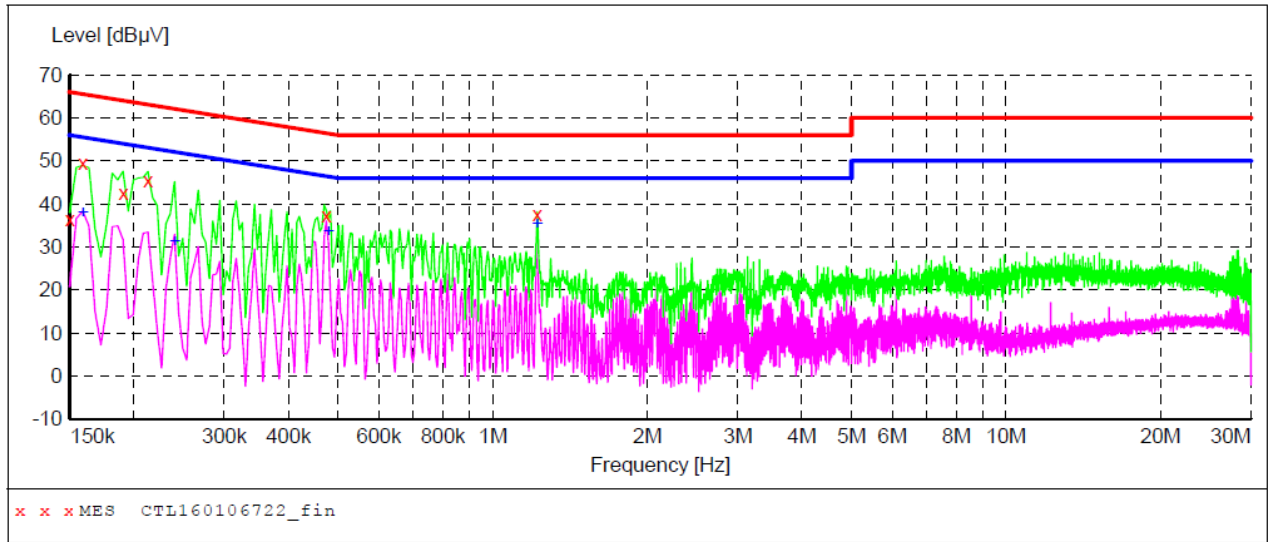

**MEASUREMENT RESULT: "CTL160106722\_fin"**

1/7/2016 10:04AM

Frequency MHz	Level dBµV	Transd dB	Limit dBµV	Margin dB	Detector	Line	PE
0.150001	36.40	10.2	66	29.6	QP	N	GND
0.159001	49.50	10.2	66	16.0	QP	N	GND
0.190501	42.40	10.2	64	21.6	QP	N	GND
0.213001	45.30	10.2	63	17.8	QP	N	GND
0.474001	37.20	10.2	56	19.2	QP	N	GND
1.221001	37.70	10.3	56	18.3	QP	N	GND

**MEASUREMENT RESULT: "CTL160106722\_fin2"**

1/7/2016 10:04AM

Frequency MHz	Level dBµV	Transd dB	Limit dBµV	Margin dB	Detector	Line	PE
0.159001	37.80	10.2	56	17.7	AV	N	GND
0.240001	31.10	10.2	52	21.0	AV	N	GND
0.478501	33.60	10.2	46	12.8	AV	N	GND
1.221001	35.20	10.3	46	10.8	AV	N	GND

## 3.2. Radiated Emissions and Band Edge

### Limit

For intentional device, according to § 15.209(a), the general requirement of field strength of radiated emission out of authorized band shall not exceed the following table at a 3 meters measurement distance.

In addition, radiated emissions which fall in the restricted bands, as defined in §15.205(a), must also comply with the radiated emission limits specified in §15.209(a)

Except when the requirements applicable to a given device state otherwise, emissions from licence-exempt transmitters shall comply with the field strength limits shown in table below. Additionally, the level of any transmitter emission shall not exceed the level of the transmitter's fundamental emission

Unwanted emissions that fall into restricted bands shall comply with the limits specified in RSS-Gen; and Unwanted emissions that do not fall within the restricted frequency bands shall comply either with the limits specified in the applicable RSS or with those specified in this RSS-Gen.

Radiated emission limits

Frequency (MHz)	Distance (Meters)	Radiated (dB $\mu$ V/m)	Radiated ( $\mu$ V/m)
0.009-0.49	3	$20\log(2400/F(\text{KHz}))+40\log(300/3)$	$2400/F(\text{KHz})$
0.49-1.705	3	$20\log(24000/F(\text{KHz}))+40\log(30/3)$	$24000/F(\text{KHz})$
1.705-30	3	$20\log(30)+40\log(30/3)$	30
30-88	3	40.0	100
88-216	3	43.5	150
216-960	3	46.0	200
Above 960	3	54.0	500

### TEST CONFIGURATION

(A) Radiated Emission Test Set-Up, Frequency Below 30MHz

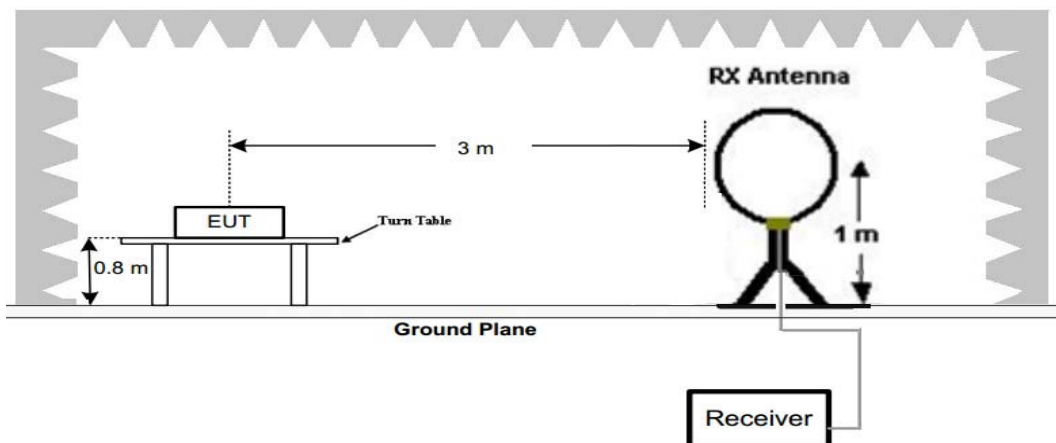

(B) Radiated Emission Test Set-Up, Frequency below 1000MHz

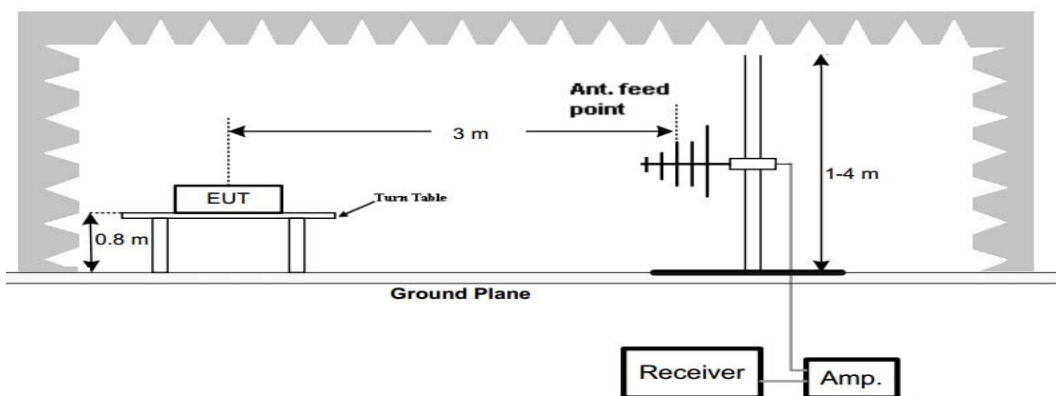

## (C) Radiated Emission Test Set-Up, Frequency above 1000MHz

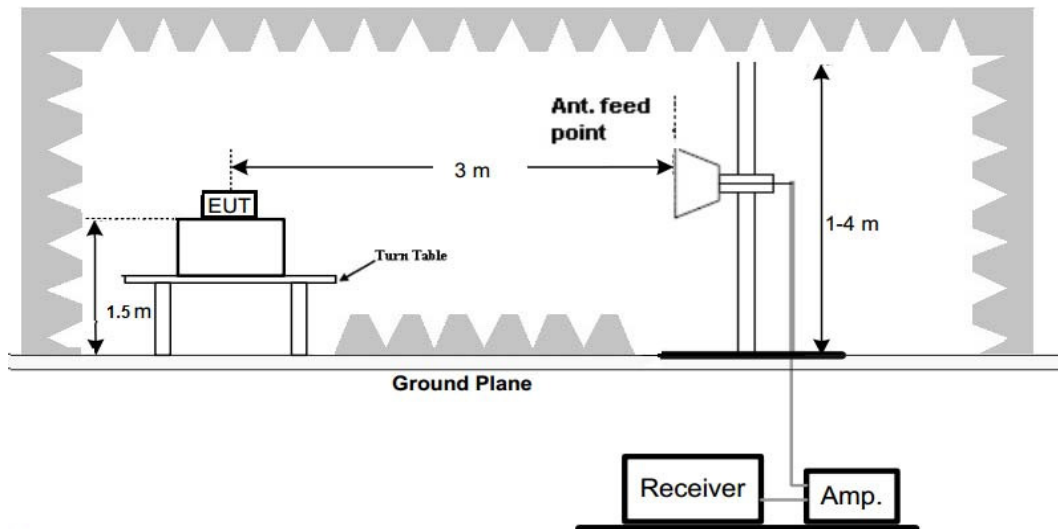
**Test Procedure**

1. The EUT was placed on turn table which is 0.8m above ground plane for below 1GHz test, and on a low permittivity and low loss tangent turn table which is 1.5m above ground plane for above 1GHz test.
2. Maximum procedure was performed by raising the receiving antenna from 1m to 4m and rotating the turn table from 0° to 360° to acquire the highest emissions from EUT
3. And also, each emission was to be maximized by changing the polarization of receiving antenna both horizontal and vertical.
4. Repeat above procedures until all frequency measurements have been completed.

**TEST RESULTS****For 9 KHz-30MHz**

Frequency (MHz)	Corrected Reading (dBuV/m)@3m	FCC Limit (dBuV/m) @3m	Margin (dB)	Detector	Result
0.17	55.88	103.00	47.12	PK	PASS
1.58	43.75	63.63	19.88	QP	PASS
15.68	52.26	69.54	17.28	QP	PASS
25.68	51.45	69.54	18.09	QP	PASS

For 30MHz-1GHz

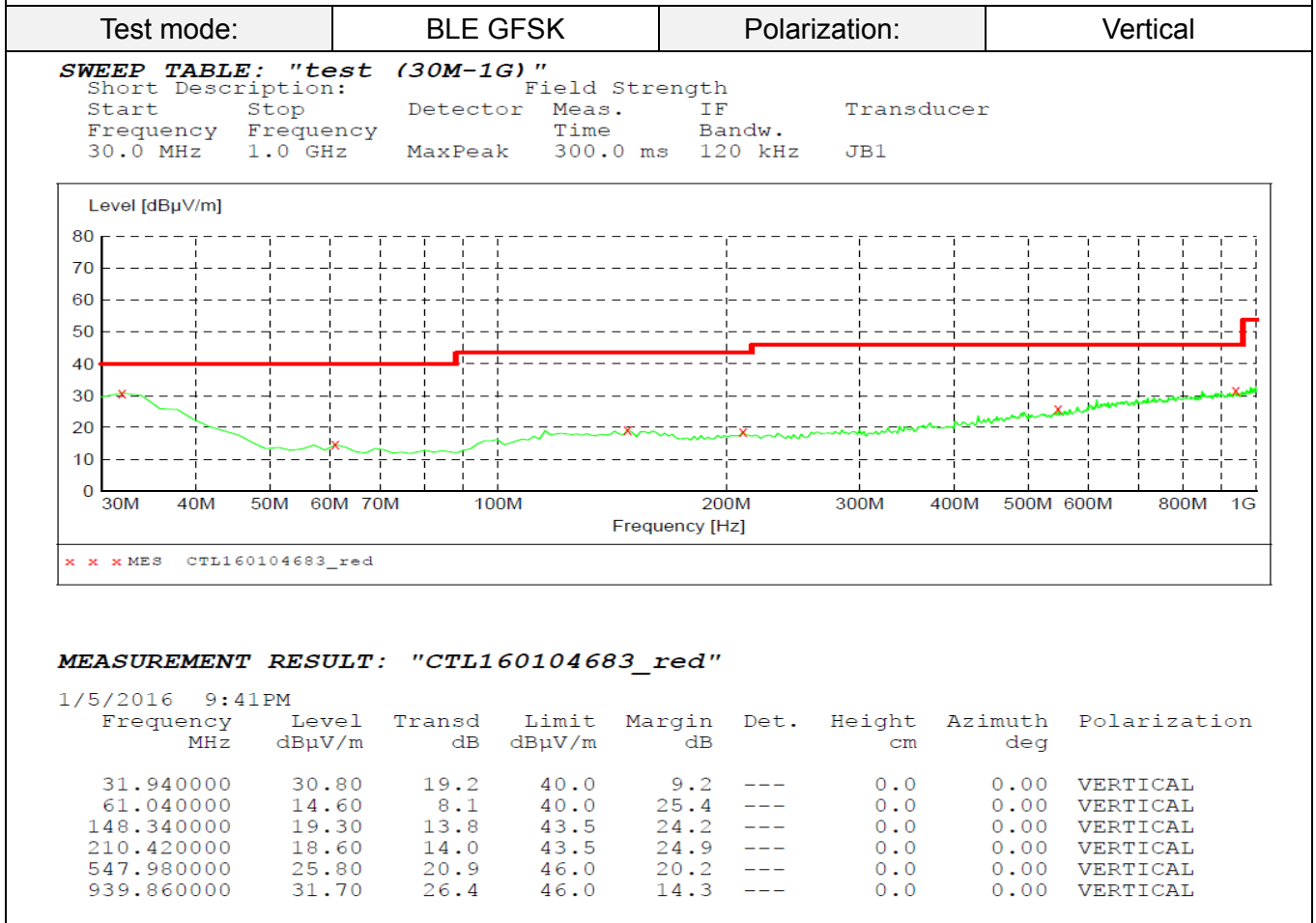
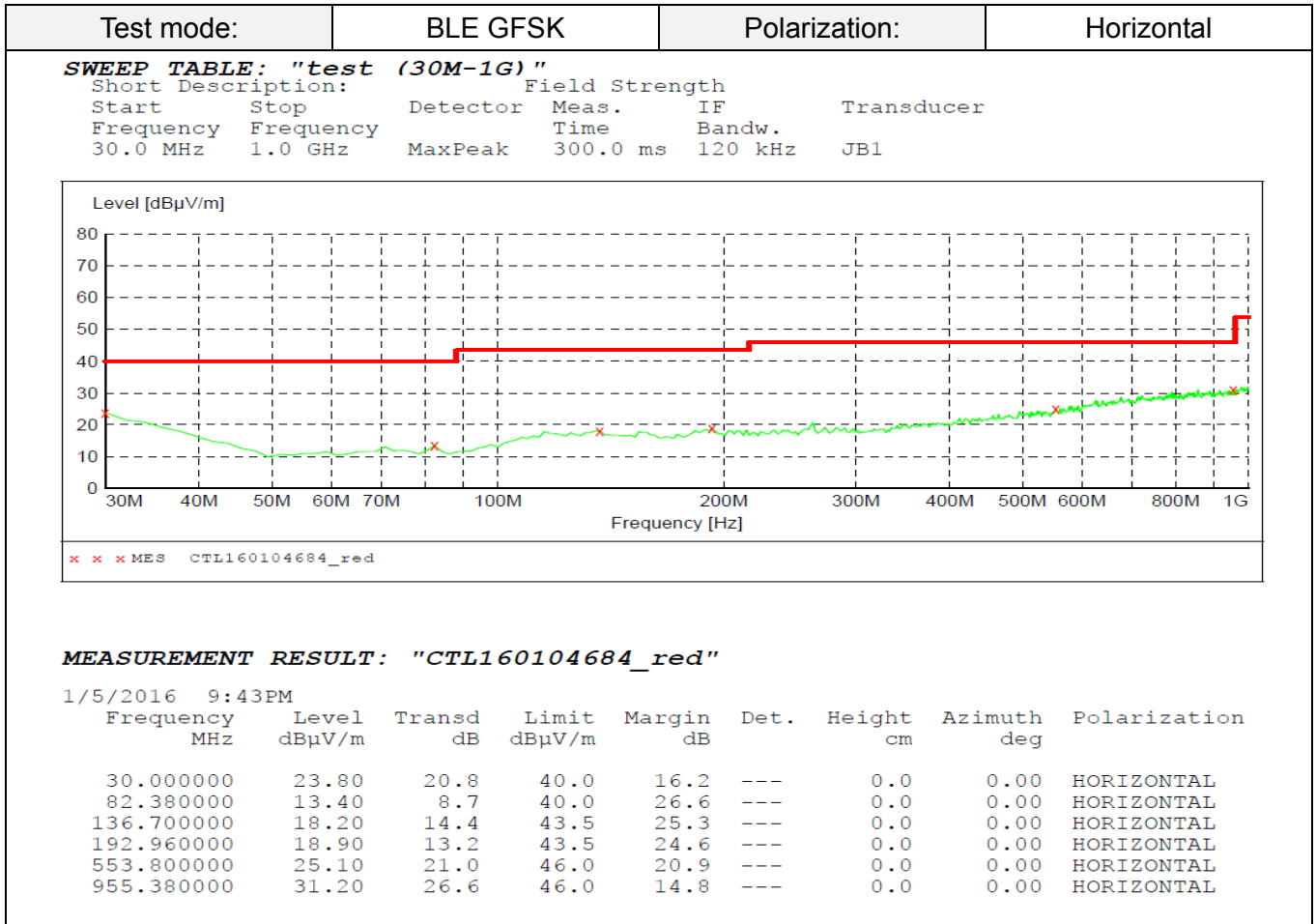

**For 1GHz to 25GHz**

Frequency(MHz):				2402		Polarity:			HORIZONTAL	
No.	Frequency (MHz)	Emission Level (dBuV/m)		Limit (dBuV/m)	Margin (dB)	Raw Value (dBuV)	Antenna Factor (dB/m)	Cable Factor (dB)	Pre-amplifier (dB)	Correction Factor (dB/m)
1	2402.00	80.58	PK	--	--	47.18	28.78	4.61	0.00	33.40
1	2402.00	72.41	AV	--	--	39.01	28.78	4.61	0.00	33.40
2	2390.00	36.85	PK	74	37.15	3.53	28.72	4.60	0.00	33.32
2	2390.00	--	AV	54	--	--	--	--	--	--
3	2400.00	38.78	PK	74	35.22	5.39	28.78	4.61	0.00	33.39
3	2400.00	--	AV	54	--	--	--	--	--	--
4	4804.00	47.56	PK	74	26.44	43.05	33.49	6.91	35.89	4.51
4	4804.00	--	AV	54	--	--	--	--	--	--
5	5115.75	44.78	PK	74	29.22	37.59	34.36	7.10	34.27	7.19
5	5115.75	--	AV	54	--	--	--	--	--	--
6	7206.00	46.21	PK	74	27.79	35.10	36.95	9.18	35.03	11.11
6	7206.00	--	AV	54	--	--	--	--	--	--

Frequency(MHz):				2402		Polarity:			VERTICAL	
No.	Frequency (MHz)	Emission Level (dBuV/m)		Limit (dBuV/m)	Margin (dB)	Raw Value (dBuV)	Antenna Factor (dB/m)	Cable Factor (dB)	Pre-amplifier (dB)	Correction Factor (dB/m)
1	2402.00	80.18	PK	--	--	46.78	28.78	4.61	0.00	33.40
1	2402.00	72.56	AV	--	--	39.16	28.78	4.61	0.00	33.40
2	2390.00	36.80	PK	74	37.2	3.48	28.72	4.60	0.00	33.32
2	2390.00	--	AV	54	--	--	--	--	--	--
3	2400.00	38.88	PK	74	35.12	5.49	28.78	4.61	0.00	33.39
3	2400.00	--	AV	54	--	--	--	--	--	--
4	4804.00	48.22	PK	74	25.78	43.71	33.49	6.91	35.89	4.51
4	4804.00	--	AV	54	--	--	--	--	--	--
5	5325.50	45.65	PK	74	28.35	38.12	34.67	7.22	34.35	7.53
5	5325.50	--	AV	54	--	--	--	--	--	--
6	7206.00	46.74	PK	74	27.26	35.63	36.95	9.18	35.03	11.11
6	7206.00	--	AV	54	--	--	--	--	--	--

**REMARKS:**

1. Emission level (dBuV/m) =Raw Value (dBuV)+Correction Factor (dB/m)
2. Correction Factor (dB/m) = Antenna Factor (dB/m)+Cable Factor (dB)-Pre-amplifier Factor
3. Margin value = Limit value- Emission level.
4. -- Mean the PK detector measured value is below average limit.
5. The other emission levels were very low against the limit.
6. RBW1MHz VBW3MHz Peak detector is for PK value; RBW 1MHz VBW10Hz Peak detector is for AV value.

Frequency(MHz):				2440		Polarity:			HORIZONTAL	
No.	Frequency (MHz)	Emission Level (dBuV/m)		Limit (dBuV/m)	Margin (dB)	Raw Value (dBuV)	Antenna Factor (dB/m)	Cable Factor (dB)	Pre-amplifier (dB)	Correction Factor (dB/m)
1	2440.00	81.55	PK	--	--	48.04	28.85	4.65	0.00	33.51
1	2440.00	73.41	AV	--	--	39.90	28.85	4.65	0.00	33.51
2	4052.25	40.65	PK	74	33.35	36.04	32.96	6.43	34.77	4.61
2	4052.25	--	AV	54	--	--	--	--	--	--
3	4880.00	48.87	PK	74	25.13	42.62	33.60	6.95	34.30	6.25
3	4880.00	--	AV	54	--	--	--	--	--	--
4	5175.50	45.66	PK	74	28.34	38.17	34.49	7.13	34.13	7.49
4	5175.50	--	AV	54	--	--	--	--	--	--
5	7320.00	46.11	PK	74	27.89	34.42	37.46	9.23	35.00	11.69
5	7320.00	--	AV	54	--	--	--	--	--	--

Frequency(MHz):				2440		Polarity:			VERTICAL	
No.	Frequency (MHz)	Emission Level (dBuV/m)		Limit (dBuV/m)	Margin (dB)	Raw Value (dBuV)	Antenna Factor (dB/m)	Cable Factor (dB)	Pre-amplifier (dB)	Correction Factor (dB/m)
1	2440.00	81.69	PK	--	--	48.18	28.85	4.65	0.00	33.51
1	2440.00	73.58	AV	--	--	40.07	28.85	4.65	0.00	33.51
2	4330.50	40.32	PK	74	33.68	35.49	32.84	6.61	34.61	4.83
2	4330.50	--	AV	54	--	--	--	--	--	--
3	4880.00	47.63	PK	74	26.37	41.38	33.60	6.95	34.30	6.25
3	4880.00	--	AV	54	--	--	--	--	--	--
4	5175.50	45.73	PK	74	28.27	38.24	34.49	7.13	34.13	7.49
4	5175.50	--	AV	54	--	--	--	--	--	--
5	7320.00	45.47	PK	74	28.53	33.78	37.46	9.23	35.00	11.69
5	7320.00	--	AV	54	--	--	--	--	--	--

## REMARKS:

1. Emission level (dBuV/m) =Raw Value (dBuV)+Correction Factor (dB/m)
2. Correction Factor (dB/m) = Antenna Factor (dB/m)+Cable Factor (dB)-Pre-amplifier Factor
3. Margin value = Limit value- Emission level.
4. -- Mean the PK detector measured value is below average limit.
5. The other emission levels were very low against the limit.
6. RBW1MHz VBW3MHz Peak detector is for PK value; RBW 1MHz VBW10Hz Peak detector is for AV value.



Frequency(MHz):				2480		Polarity:			HORIZONTAL	
No.	Frequency (MHz)	Emission Level (dBuV/m)		Limit (dBuV/m)	Margin (dB)	Raw Value (dBuV)	Antenna Factor (dB/m)	Cable Factor (dB)	Pre-amplifier (dB)	Correction Factor (dB/m)
1	2480.00	80.32	PK	--	--	46.70	28.92	4.70	0.00	33.62
1	2480.00	72.74	AV	--	--	39.12	28.92	4.70	0.00	33.62
2	2483.50	38.98	PK	74	35.02	5.35	28.93	4.70	0.00	33.63
2	2483.50	--	AV	54	--	--	--	--	--	--
3	2500.00	36.47	PK	74	37.53	2.79	28.96	4.72	0.00	33.68
3	2500.00	--	AV	54	--	--	--	--	--	--
4	4960.00	48.69	PK	74	25.31	43.77	33.84	7.00	35.92	4.92
4	4960.00	--	AV	54	--	--	--	--	--	--
5	5025.50	43.51	PK	74	30.49	36.63	34.07	7.05	34.24	6.88
5	5025.50	--	AV	54	--	--	--	--	--	--
6	7440.00	41.78	PK	74	32.22	29.83	37.64	9.28	34.97	11.95
6	7440.00	--	AV	54	--	--	--	--	--	--

Frequency(MHz):				2480		Polarity:			VERTICAL	
No.	Frequency (MHz)	Emission Level (dBuV/m)		Limit (dBuV/m)	Margin (dB)	Raw Value (dBuV)	Antenna Factor (dB/m)	Cable Factor (dB)	Pre-amplifier (dB)	Correction Factor (dB/m)
1	2480.00	80.48	PK	--	--	46.86	28.92	4.70	0.00	33.62
1	2480.00	72.23	AV	--	--	38.61	28.92	4.70	0.00	33.62
2	2483.50	38.84	PK	74	35.16	5.21	28.93	4.70	0.00	33.63
2	2483.50	--	AV	54	--	--	--	--	--	--
3	2500.00	36.21	PK	74	37.79	2.53	28.96	4.72	0.00	33.68
3	2500.00	--	AV	54	--	--	--	--	--	--
4	4960.00	48.55	PK	74	25.45	43.63	33.84	7.00	35.92	4.92
4	4960.00	--	AV	54	--	--	--	--	--	--
5	5415.25	43.47	PK	74	30.53	35.84	34.74	7.27	34.38	7.63
5	5415.25	--	AV	54	--	--	--	--	--	--
6	7440.00	42.31	PK	74	31.69	30.36	37.64	9.28	34.97	11.95
6	7440.00	--	AV	54	--	--	--	--	--	--

## REMARKS:

1. Emission level (dBuV/m) =Raw Value (dBuV)+Correction Factor (dB/m)
2. Correction Factor (dB/m) = Antenna Factor (dB/m)+Cable Factor (dB)-Pre-amplifier Factor
3. Margin value = Limit value- Emission level.
4. -- Mean the PK detector measured value is below average limit.
5. The other emission levels were very low against the limit.
6. RBW1MHz VBW3MHz Peak detector is for PK value; RBW 1MHz VBW10Hz Peak detector is for AV value.

### 3.3. Maximum Conducted Output Power

#### Limit

The Maximum Peak Output Power Measurement is 30dBm.

#### Test Procedure

Remove the antenna from the EUT and then connect a low loss RF cable from the antenna port to the power sensor.

#### Test Configuration

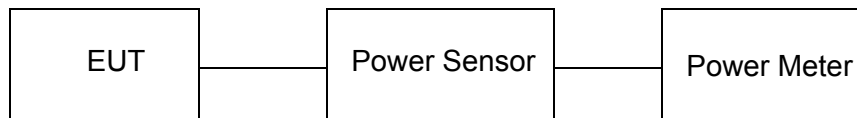

#### Test Results

BLE				
Type	Channel	Output power (dBm)	Limit (dBm)	Result
GFSK	00	-4.54	30.00	Pass
	19	-5.32		
	39	-5.47		

Note: 1.The test results including the cable lose.

### 3.4. Power Spectral Density

#### Limit

For digitally modulated systems, the power spectral density conducted from the intentional radiator to the antenna shall not be greater than 8 dBm in any 3 kHz band during any time interval of continuous transmission.

#### Test Procedure

1. Use this procedure when the maximum peak conducted output power in the fundamental emission is used to demonstrate compliance.
2. Set the RBW  $\geq$  3 kHz.
3. Set the VBW  $\geq$  3 $\times$  RBW.
4. Set the span to 1.5 times the DTS channel bandwidth.
5. Detector = peak.
6. Sweep time = auto couple.
7. Trace mode = max hold.
8. Allow trace to fully stabilize.
9. Use the peak marker function to determine the maximum power level.
10. If measured value exceeds limit, reduce RBW (no less than 3 kHz) and repeat.
11. The resulting peak PSD level must be 8dBm.

#### Test Configuration



#### Test Results

<b>BLE</b>				
Type	Channel	Power Spectral Density (dBm/3KHz)	Limit (dBm/3KHz)	Result
GFSK	00	-16.802	8.00	Pass
	19	-18.941		
	39	-20.316		

Test plot as follows:

BLE GFSK

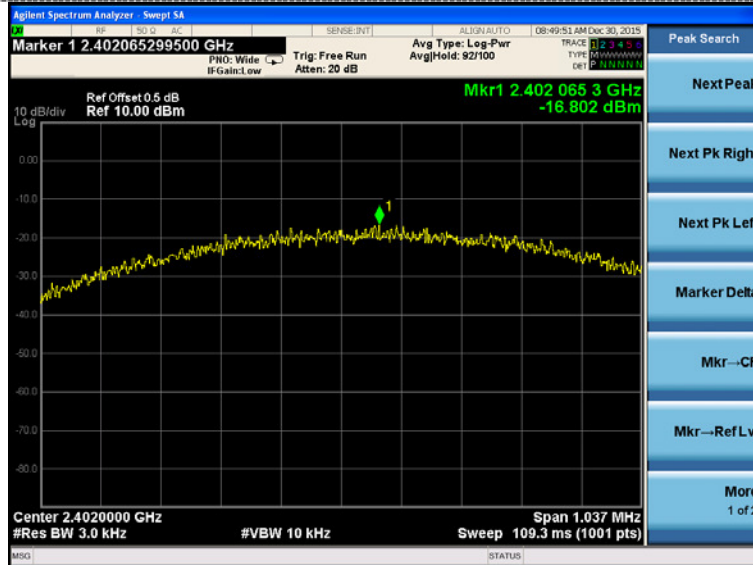

CH00

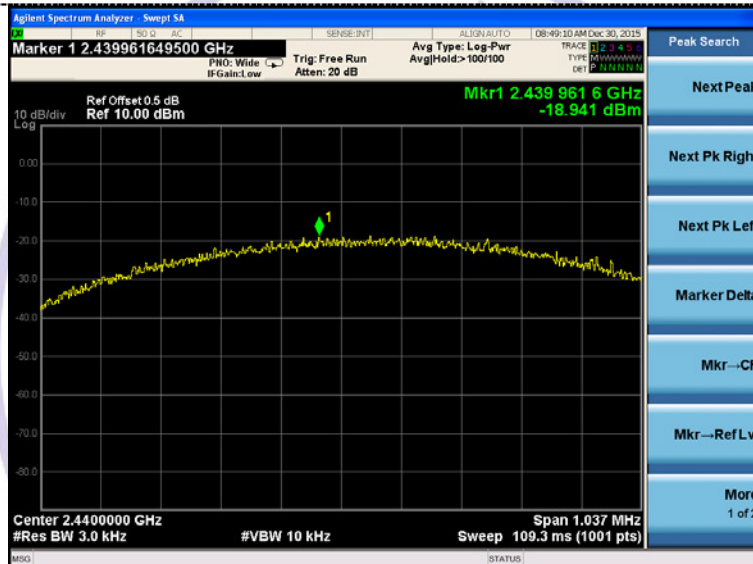

CH19

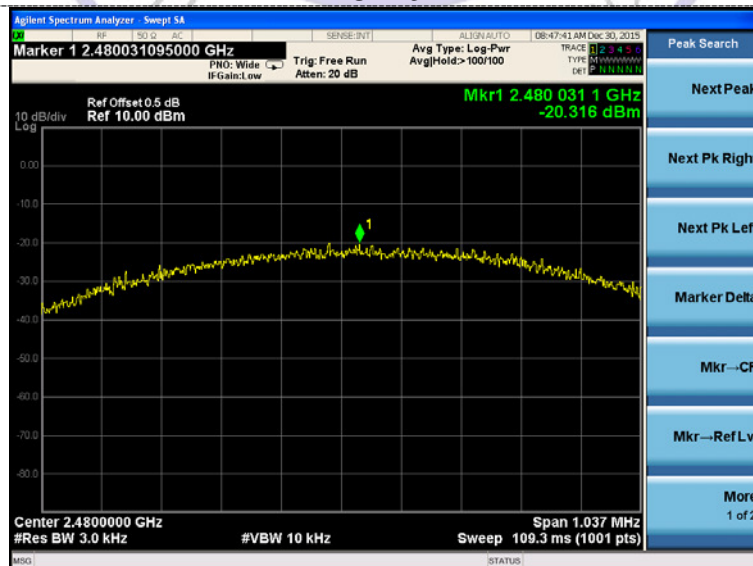

CH39

### 3.5. 6dB Bandwidth

#### Limit

For digital modulation systems, the minimum 6 dB bandwidth shall be at least 500 kHz

#### Test Procedure

The transmitter output was connected to the spectrum analyzer through an attenuator. The bandwidth of the fundamental frequency was measured by spectrum analyzer with 100 KHz RBW and 300 KHz VBW. The 6dB bandwidth is defined as the total spectrum the power of which is higher than peak power minus 6dB.

#### Test Configuration



#### Test Results

BLE					
Type	Channel	6dB Bandwidth (MHz)	99% OBW (MHz)	Limit (KHz)	Result
GFSK	00	0.6786	1.0898	≥500	Pass
	19	0.6793	1.0879		
	39	0.6907	1.0918		

Test plot as follows:

BLE GFSK

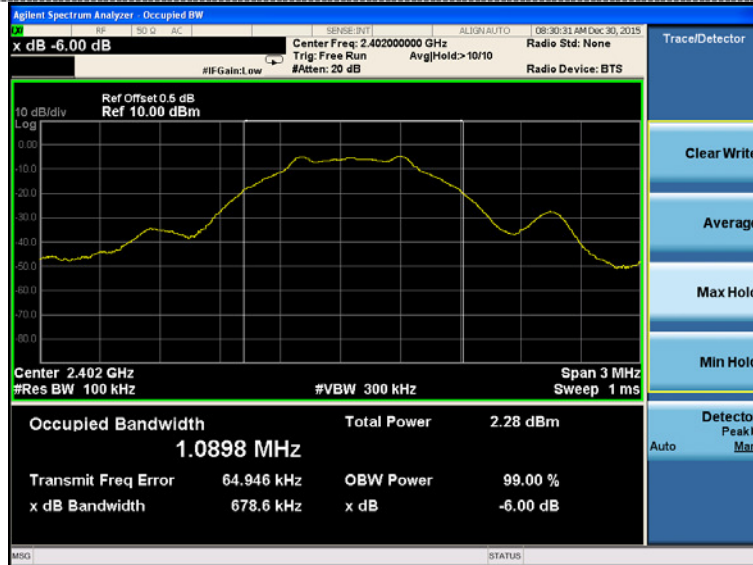

CH00

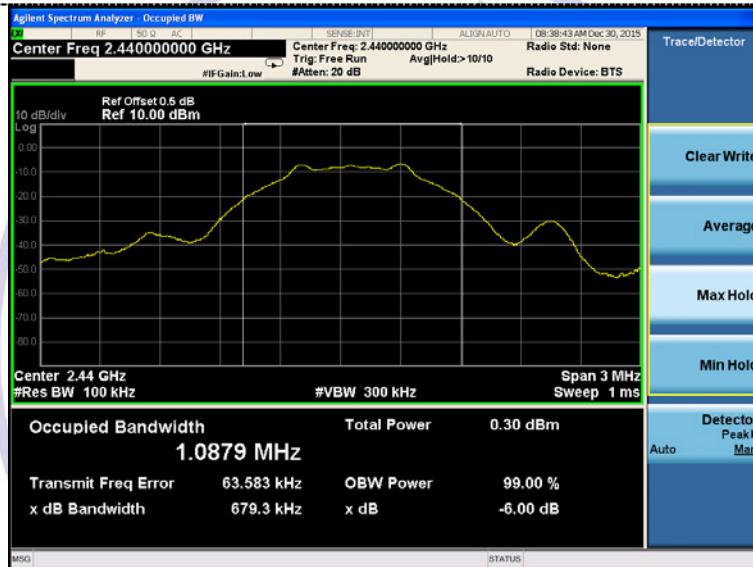

CH19

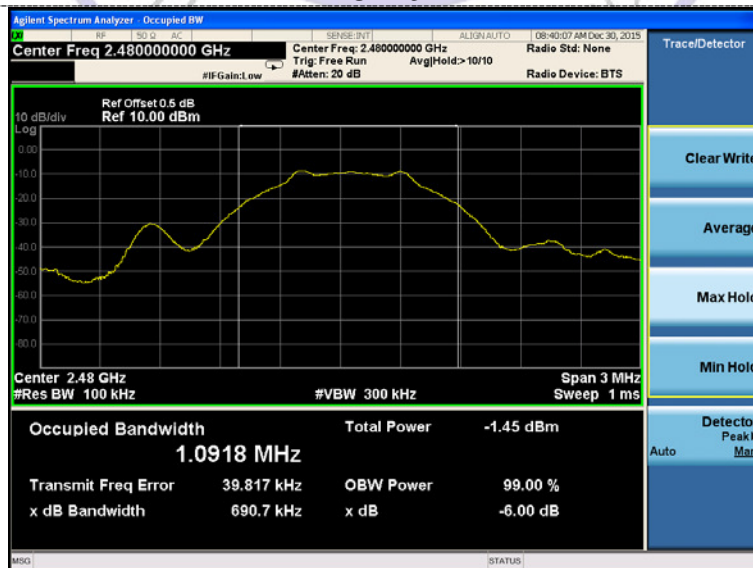

CH39

### 3.6. Out-of-band Emissions

#### Limit

In any 100 kHz bandwidth outside the frequency band in which the spread spectrum or digitally modulated device is operating, the RF power that is produced shall be at least 20 dB below that in the 100 kHz bandwidth within the band that contains the highest level of the desired power, based on either an RF conducted or a radiated measurement, provided that the transmitter demonstrates compliance with the peak conducted power limits. If the transmitter complies with the conducted power limits based on the use of root-mean-square averaging over a time interval, as permitted under Section (b)(3) of §15.247 and RSS 5.4(4), the attenuation required shall be 30 dB instead of 20 dB. Attenuation below the general field strength limits specified in §15.209(a) and RSS-Gen are not required.

#### Test Procedure

Connect the transmitter output to spectrum analyzer using a low loss RF cable, and set the spectrum analyzer to RBW=100 kHz, VBW= 300 kHz, peak detector , and max hold. Measurements utilizing these setting are made of the in-band reference level, bandedge and out-of-band emissions.

#### Test Configuration



#### Test Results

Remark: The measurement frequency range is from 30MHz to the 10th harmonic of the fundamental frequency. The lowest, middle and highest channels are tested to verify the spurious emissions and bandage measurement data.

Test plot as follows:

BLE GFSK

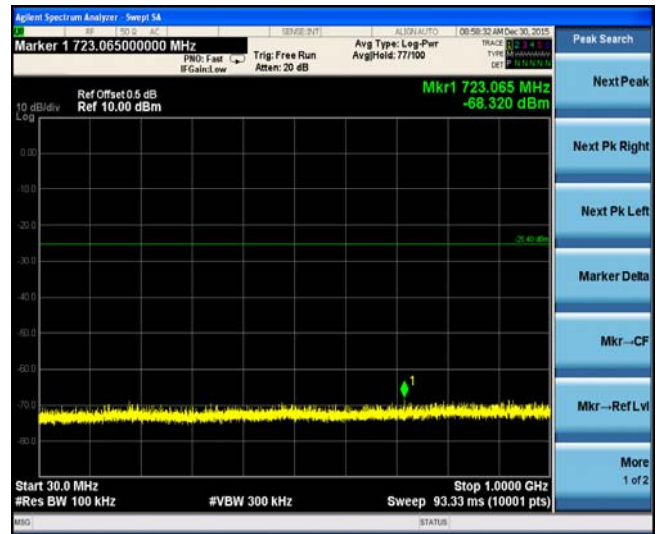

CH00

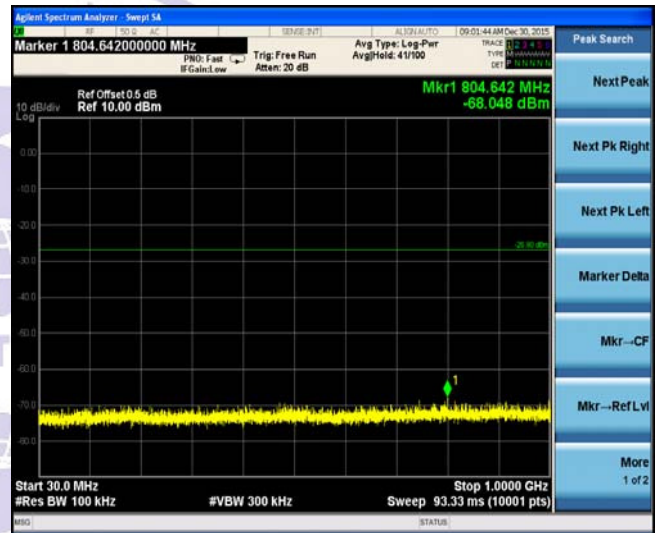

CH19

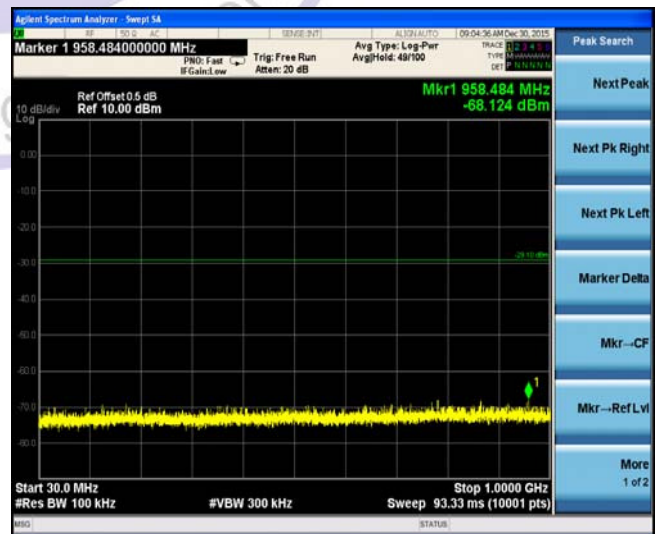
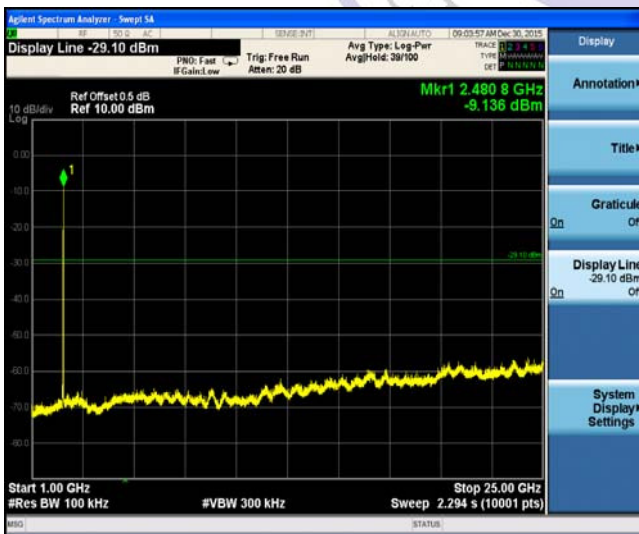

CH39





Left Band edge

Right Band edge



### 4. Test Setup Photos of the EUT

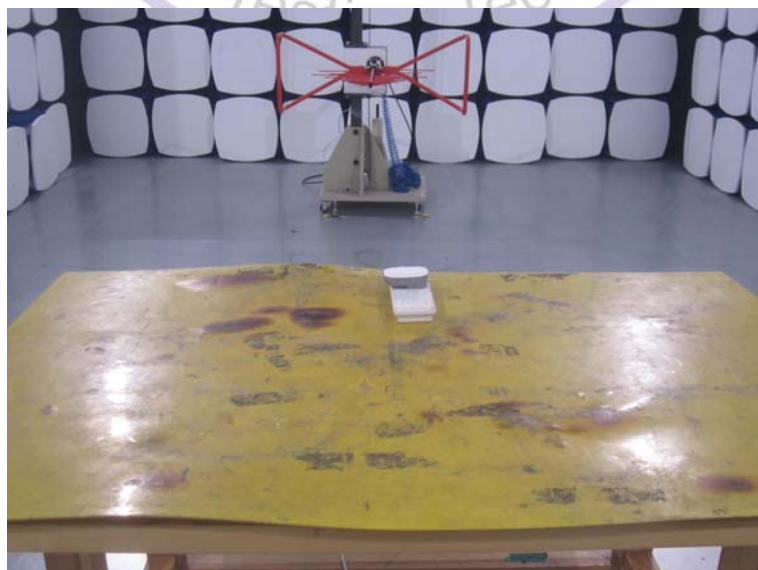



## 5. External and Internal Photos of the EUT

Please reference to the test report No.: CTL1603070590-WF-01

\*\*\*\*\* End of Report \*\*\*\*\*

