

TEST REPORT

FCC ID: 2AG87RM-915-2H

Product: Smart Radio

Model No.: RM-915-2H

Additional Model: RO-915-2H

Trade Mark: N/A

Report No.: TCT180620E009

Issued Date: Jul. 25, 2018

Issued for:

Doodle Labs (SG) Pte Ltd

150 Kampong Ampat, KA Center, Suite 05-03 Singapore, 368324 Singapore

Issued By:

Shenzhen Tongce Testing Lab.

**1B/F., Building 1, Yibaolai Industrial Park, Qiaotou, Fuyong, Baoan District,
Shenzhen, Guangdong, China**

TEL: +86-755-27673339

FAX: +86-755-27673332

Note: *This report shall not be reproduced except in full, without the written approval of Shenzhen Tongce Testing Lab.*

This document may be altered or revised by Shenzhen Tongce Testing Lab. personnel only, and shall be noted in the revision section of the document. The test results in the report only apply to the tested sample.

TABLE OF CONTENTS

1. Test Certification 3

2. Test Result Summary 4

3. EUT Description..... 5

4. General Information..... 6

 4.1. Test environment and mode..... 6

 4.2. Description of Support Units..... 7

5. Facilities and Accreditations 8

 5.1. Facilities 8

 5.2. Location 8

 5.3. Measurement Uncertainty..... 8

6. Test Results and Measurement Data 9

 6.1. Antenna requirement 9

 6.2. Conducted Emission..... 10

 6.3. Maximum Conducted (Peak) Output Power 14

 6.4. Emission Bandwidth 16

 6.5. Power Spectral Density..... 26

 6.6. Conducted Band Edge and Spurious Emission Measurement 36

 6.7. Radiated Spurious Emission Measurement..... 46

Appendix A: Photographs of Test Setup

Appendix B: Photographs of EUT

1. Test Certification

Product:	Smart Radio
Model No.:	RM-915-2H
Additional Model No.:	RO-915-2H
Trade Mark:	N/A
Applicant:	Doodle Labs (SG) Pte Ltd
Address:	150 Kampong Ampat, KA Center, Suite 05-03 Singapore, 368324 Singapore
Manufacturer:	Doodle Labs (SG) Pte Ltd
Address:	150 Kampong Ampat, KA Center, Suite 05-03 Singapore, 368324 Singapore
Date of Test:	Jun. 21, 2018 - Jul. 24, 2018
Applicable Standards:	FCC CFR Title 47 Part 15 Subpart C Section 15.247 KDB 558074 D01 DTS Meas Guidance v04

The above equipment has been tested by Shenzhen Tongce Testing Lab. and found compliance with the requirements set forth in the technical standards mentioned above. The results of testing in this report apply only to the product/system, which was tested. Other similar equipment will not necessarily produce the same results due to production tolerance and measurement uncertainties.

Tested By:



Jerry Xie

Date:

Jul. 24, 2018

Reviewed By:



Beryl Zhao

Date:

Jul. 25, 2018

Approved By:



Tomsin

Date:

Jul. 25, 2018

2. Test Result Summary

Requirement	CFR 47 Section	Result
Antenna requirement	§15.203/§15.247 (c)	PASS
AC Power Line Conducted Emission	§15.207	PASS
Conducted Peak Output Power	§15.247 (b)(3) §2.1046	PASS
6dB Emission Bandwidth	§15.247 (a)(2) §2.1049	PASS
Power Spectral Density	§15.247 (e)	PASS
Band Edge	§15.247(d) §2.1051, §2.1057	PASS
Spurious Emission	§15.205/§15.209 §2.1053, §2.1057	PASS

Note:

1. PASS: Test item meets the requirement.
2. Fail: Test item does not meet the requirement.
3. N/A: Test case does not apply to the test object.
4. The test result judgment is decided by the limit of test standard.

3. EUT Description

Product:	Smart Radio
Product Type:	WLAN(2TX, 2RX)
Radio Type:	2x2 MIMO
Model No.:	RM-915-2H
Additional Model No.:	RO-915-2H
Trade Mark:	N/A
Hardware Version:	2
Software Version:	V1.0
Operation Frequency:	905MHz~920MHz
Channel Separation:	5MHz
Number of Channel:	905 MHz, 910 MHz, 915 MHz, 920 MHz,
Modulation Technology:	DSSS, OFDM
Antenna Type:	R-SMA antenna
Antenna Gain:	All are 2dBi
Power Supply:	DC 5V from adapter (voltage range: 5V up to 42V)
Remark:	All models above are identical in interior structure, electrical circuits and components, and just model names are different for the marketing requirement.

Operation Frequency each of channel For DSSS, OFDM.

Channel	Frequency	Channel	Frequency	Channel	Frequency	Channel	Frequency
1	905MHz	2	910MHz	3	915MHz	4	920MHz

Remark: All the channels have been tested.

4. Genera Information

4.1. Test environment and mode

Operating Environment:	
Temperature:	25.0 °C
Humidity:	56 % RH
Atmospheric Pressure:	1010 mbar
Test Mode:	
Engineering mode:	Keep the EUT in continuous transmitting by above channel
<p>The sample was placed (0.8m below 1GHz, 1.5m above 1GHz) above the ground plane of 3m chamber. Measurements in both horizontal and vertical polarities were performed. During the test, each emission was maximized by: having the EUT continuously working, investigated all operating modes, rotated about all 3 axis (X, Y & Z) and considered typical configuration to obtain worst position, manipulating interconnecting cables, rotating the turntable, varying antenna height from 1m to 4m in both horizontal and vertical polarizations. The emissions worst-case are shown in Test Results of the following pages. For the full battery state and The output power to the maximum state.</p>	

4.2. Description of Support Units

The EUT has been tested as an independent unit together with other necessary accessories or support units. The following support units or accessories were used to form a representative test configuration during the tests.

Equipment	Model No.	Serial No.	FCC ID	Trade Name
900MHz Dipole Antenna	001-0002	/	/	LSR
Adapter	EP-TA20CBC	R37HAEY0DT 1RT3	/	SAMSUNG
Heat sink	/	/	/	TCT

Note:

1. All the equipment/cables were placed in the worst-case configuration to maximize the emission during the test.
2. Grounding was established in accordance with the manufacturer's requirements and conditions for the intended use.
3. For conducted measurements (Output Power, 6dB Emission Bandwidth, Power Spectral Density, Spurious Emissions), the antenna is connected to the test equipment via temporary antenna connector, the antenna connector is soldered on the antenna port of EUT, and the temporary antenna connector is listed in the Test Instruments.

5. Facilities and Accreditations

5.1. Facilities

The test facility is recognized, certified, or accredited by the following organizations:

- FCC - Registration No.: 645098

Shenzhen Tongce Testing Lab

The 3m Semi-anechoic chamber has been registered and fully described in a report with the (FCC) Federal Communications Commission. The acceptance letter from the FCC is maintained in our files.

- IC - Registration No.: 10668A-1

The 3m Semi-anechoic chamber of Shenzhen TCT Testing Technology Co., Ltd. has been registered by Certification and Engineering Bureau of Industry Canada for radio equipment testing

5.2. Location

Shenzhen Tongce Testing Lab

Address: 1B/F., Building 1, Yibaolai Industrial Park, Qiaotou, Fuyong, Baoan District, Shenzhen, Guangdong, China

TEL: +86-755-27673339

5.3. Measurement Uncertainty

The reported uncertainty of measurement $y \pm U$, where expanded uncertainty U is based on a standard uncertainty multiplied by a coverage factor of $k=2$, providing a level of confidence of approximately 95 %.

No.	Item	MU
1	Conducted Emission	$\pm 2.56\text{dB}$
2	RF power, conducted	$\pm 0.12\text{dB}$
3	Spurious emissions, conducted	$\pm 0.11\text{dB}$
4	All emissions, radiated(<1G)	$\pm 3.92\text{dB}$
5	All emissions, radiated(>1G)	$\pm 4.28\text{dB}$
6	Temperature	$\pm 0.1^\circ\text{C}$
7	Humidity	$\pm 1.0\%$

6. Test Results and Measurement Data

6.1. Antenna requirement

Standard requirement:

FCC Part15 C Section 15.203 /247(c)

15.203 requirement:

An intentional radiator shall be designed to ensure that no antenna other than that furnished by the responsible party shall be used with the device. The use of a permanently attached antenna or of an antenna that uses a unique coupling to the intentional radiator, the manufacturer may design the unit so that a broken antenna can be replaced by the user, but the use of a standard antenna jack or electrical connector is prohibited.

15.247(c) (1)(i) requirement:

(i) Systems operating in the 902-928 MHz band that is used exclusively for fixed. Point-to-point operations may employ transmitting antennas with directional gain greater than 6dBi provided the maximum conducted output power of the intentional radiator is reduced by 1 dB for every 3 dB that the directional gain of the antenna exceeds 6dBi.

E.U.T Antenna:

The EUT has R-SMA antenna which uses a unique coupling to the intentional radiator, and the best case gain of the antenna is 2dBi.

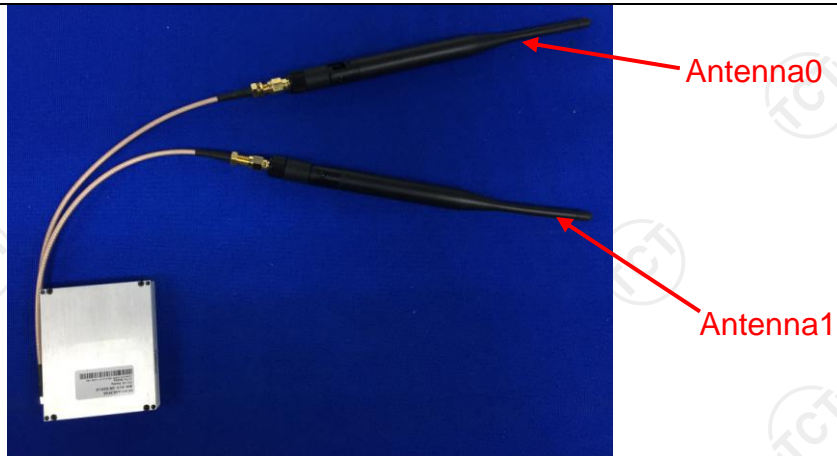

6.2. Conducted Emission

6.2.1. Test Specification

Test Requirement:	FCC Part15 C Section 15.207														
Test Method:	ANSI C63.10:2013														
Frequency Range:	150 kHz to 30 MHz														
Receiver setup:	RBW=9 kHz, VBW=30 kHz, Sweep time=auto														
Limits:	<table border="1"> <thead> <tr> <th rowspan="2">Frequency range (MHz)</th> <th colspan="2">Limit (dBuV)</th> </tr> <tr> <th>Quasi-peak</th> <th>Average</th> </tr> </thead> <tbody> <tr> <td>0.15-0.5</td> <td>66 to 56*</td> <td>56 to 46*</td> </tr> <tr> <td>0.5-5</td> <td>56</td> <td>46</td> </tr> <tr> <td>5-30</td> <td>60</td> <td>50</td> </tr> </tbody> </table>	Frequency range (MHz)	Limit (dBuV)		Quasi-peak	Average	0.15-0.5	66 to 56*	56 to 46*	0.5-5	56	46	5-30	60	50
Frequency range (MHz)	Limit (dBuV)														
	Quasi-peak	Average													
0.15-0.5	66 to 56*	56 to 46*													
0.5-5	56	46													
5-30	60	50													
Test Setup:	<p>Reference Plane</p> <p>40cm</p> <p>80cm</p> <p>E.U.T</p> <p>AC power</p> <p>Test table/Insulation plane</p> <p>LISN</p> <p>Filter</p> <p>AC power</p> <p>EMI Receiver</p> <p><i>Remark</i> E.U.T: Equipment Under Test LISN: Line Impedance Stabilization Network Test table height=0.8m</p>														
Test Mode:	Charging + transmitting with modulation														
Test Procedure:	<ol style="list-style-type: none"> 1. The E.U.T is connected to the main power through a line impedance stabilization network (L.I.S.N.). This provides a 50ohm/50uH coupling impedance for the measuring equipment. 2. The peripheral devices are also connected to the main power through a LISN that provides a 50ohm/50uH coupling impedance with 50ohm termination. (Please refer to the block diagram of the test setup and photographs). 3. Both sides of A.C. line are checked for maximum conducted interference. In order to find the maximum emission, the relative positions of equipment and all of the interface cables must be changed according to ANSI C63.10: 2013 on conducted measurement. 														
Test Result:	PASS														

6.2.2. Test Instruments

Conducted Emission Shielding Room Test Site (843)				
Equipment	Manufacturer	Model	Serial Number	Calibration Due
Test Receiver	R&S	ESPI	101401	Sep. 27, 2018
LISN	Schwarzbeck	NSLK 8126	8126453	Sep. 27, 2018
Coax cable (9KHz-30MHz)	TCT	CE-05	N/A	Sep. 27, 2018
EMI Test Software	Shurple Technology	EZ-EMC	N/A	N/A

Note: The calibration interval of the above test instruments is 12 months and the calibrations are traceable to international system unit (SI).

6.2.3. Test data

Please refer to following diagram for individual

Conducted Emission on Line Terminal of the power line (150 kHz to 30MHz)

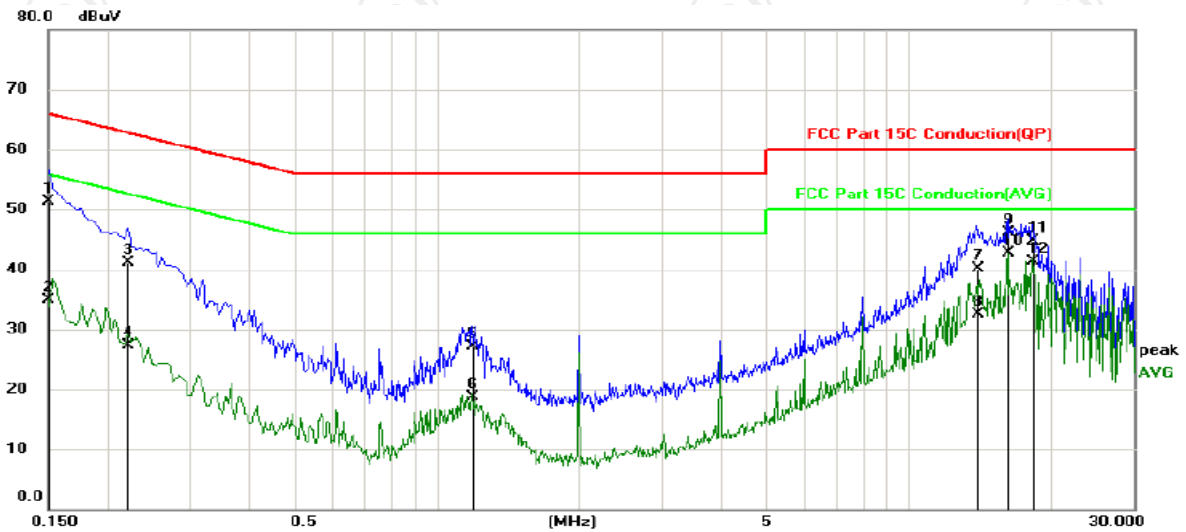

Site: Phase: **L1** Temperature: 25
 Limit: FCC Part 15C Conduction(QP) Power: AC 120V/60Hz Humidity: 55 %
 EUT: Smart Radio
 M/N: RM-915-2H
 Mode: Transmitting

No.	Mk.	Freq. MHz	Reading Level dBuV	Correct Factor dB	Measure- ment dBuV	Limit dBuV	Over dB	Detector	Comment
1		0.1504	39.88	11.49	51.37	65.98	-14.61	QP	
2		0.1504	23.40	11.49	34.89	55.98	-21.09	AVG	
3		0.2215	29.73	11.46	41.19	62.76	-21.57	QP	
4		0.2215	15.88	11.46	27.34	52.76	-25.42	AVG	
5		1.1873	15.84	11.30	27.14	56.00	-28.86	QP	
6		1.1873	7.33	11.30	18.63	46.00	-27.37	AVG	
7		13.9880	28.47	11.61	40.08	60.00	-19.92	QP	
8		13.9880	20.86	11.61	32.47	50.00	-17.53	AVG	
9		16.2288	34.58	11.43	46.01	60.00	-13.99	QP	
10	*	16.2288	31.24	11.43	42.67	50.00	-7.33	AVG	
11		18.2415	33.67	10.98	44.65	60.00	-15.35	QP	
12		18.2415	30.38	10.98	41.36	50.00	-8.64	AVG	

Note:

- Freq. = Emission frequency in MHz
- Reading level (dBuV) = Receiver reading
- Corr. Factor (dB) = Antenna factor + Cable loss
- Measurement (dBuV) = Reading level (dBuV) + Corr. Factor (dB)
- Limit (dBuV) = Limit stated in standard
- Margin (dB) = Measurement (dBuV) – Limits (dBuV)
- Q.P. =Quasi-Peak
- AVG =average
- * is meaning the worst frequency has been tested in the frequency range 150 kHz to 30MHz.

Conducted Emission on Neutral Terminal of the power line (150 kHz to 30MHz)

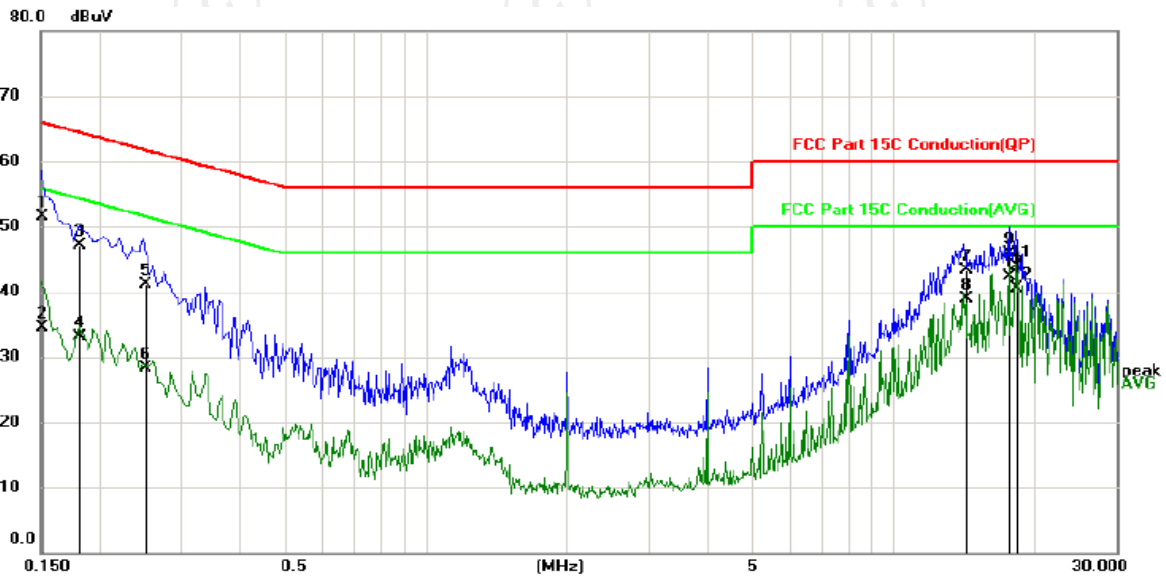

Site: Phase: **N** Temperature: 25
 Limit: FCC Part 15C Conduction(QP) Power: AC 120V/60Hz Humidity: 55 %
 EUT: Smart Radio
 M/N: RM-915-2H
 Mode: Transmitting

No.	Mk.	Freq. MHz	Reading Level dBuV	Correct Factor dB	Measure- ment dBuV	Limit dBuV	Over dB	Detector	Comment
1		0.1513	40.10	11.49	51.59	65.93	-14.34	QP	
2		0.1513	23.08	11.49	34.57	55.93	-21.36	AVG	
3		0.1818	35.54	11.48	47.02	64.40	-17.38	QP	
4		0.1818	21.65	11.48	33.13	54.40	-21.27	AVG	
5		0.2516	29.67	11.44	41.11	61.70	-20.59	QP	
6		0.2516	16.88	11.44	28.32	51.70	-23.38	AVG	
7		14.2131	31.58	11.63	43.21	60.00	-16.79	QP	
8		14.2131	27.27	11.63	38.90	50.00	-11.10	AVG	
9		17.6939	34.89	11.10	45.99	60.00	-14.01	QP	
10	*	17.6939	31.22	11.10	42.32	50.00	-7.68	AVG	
11		18.2460	32.98	10.98	43.96	60.00	-16.04	QP	
12		18.2460	29.52	10.98	40.50	50.00	-9.50	AVG	

Note:

- Freq. = Emission frequency in MHz
- Reading level (dBuV) = Receiver reading
- Corr. Factor (dB) = Antenna factor + Cable loss
- Measurement (dBuV) = Reading level (dBuV) + Corr. Factor (dB)
- Limit (dBuV) = Limit stated in standard
- Margin (dB) = Measurement (dBuV) – Limits (dBuV)
- Q.P. =Quasi-Peak
- AVG =average
- * is meaning the worst frequency has been tested in the frequency range 150 kHz to 30MHz.

6.3.3. Test Data

For DSSS / Antenna 0+Antenna 1					
Test channel	Maximum Conducted (Peak) Output Power (dBm)			Limit (dBm)	Result
	Ant0	Ant1	Total		
905MHz	25.16	25.19	28.19	30	PASS
910MHz	25.53	25.47	28.51	30	PASS
915MHz	25.06	24.21	27.67	30	PASS
920MHz	25.01	24.81	27.92	30	PASS

For OFDM / Antenna 0+Antenna 1					
Test channel	Maximum Conducted (Peak) Output Power (dBm)			Limit (dBm)	Result
	Ant0	Ant1	Total		
905MHz	24.86	25.16	28.02	30	PASS
910MHz	25.17	25.40	28.30	30	PASS
915MHz	24.30	24.32	27.32	30	PASS
920MHz	24.26	24.03	27.16	30	PASS

Note: $G_{ANT} = 2\text{dBi}$, $\text{Array Gain} = 10\log(N_{ANT}/N_{SS}) = 3.01\text{dBi}$

Directional Gain = $G_{ANT} + \text{Array Gain} = 5.01\text{dBi} < 6\text{dBi}$, So limit = 30dBm

6.4. Emission Bandwidth

6.4.1. Test Specification

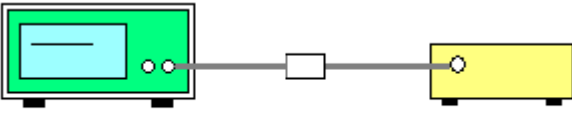
Test Requirement:	FCC Part15 C Section 15.247 (a)(2)
Test Method:	KDB 558074
Limit:	>500kHz
Test Setup:	 <p style="text-align: center;">Spectrum Analyzer EUT</p>
Test Mode:	Transmitting mode with modulation
Test Procedure:	<ol style="list-style-type: none"> 1. The testing follows FCC KDB Publication No. 558074 DTS D01 Meas. Guidance v04. 2. Set to the maximum power setting and enable the EUT transmit continuously. 3. Make the measurement with the spectrum analyzer's resolution bandwidth (RBW) = 100 kHz. Set the Video bandwidth (VBW) = 300 kHz. In order to make an accurate measurement. The 6dB bandwidth must be greater than 500 kHz. 4. Measure and record the results in the test report.
Test Result:	PASS

6.4.2. Test Instruments

RF Test Room				
Equipment	Manufacturer	Model	Serial Number	Calibration Due
Spectrum Analyzer	Agilent	N9020A	MY49100060	Sep. 27, 2018
RF Cable (9KHz-26.5GHz)	TCT	RE-06	N/A	Sep. 27, 2018
Antenna Connector	TCT	RFC-01	N/A	Sep. 27, 2018

Note: The calibration interval of the above test instruments is 12 months and the calibrations are traceable to international system unit (SI).

6.4.3. Test data

Antenna 0:

Test channel	6dB Emission Bandwidth (MHz)	
	For DSSS	For OFDM
905MHz	2.574	4.374
910MHz	2.586	4.388
915MHz	2.569	4.381
920MHz	2.560	4.127
Limit:	>500k	
Test Result:	PASS	

Antenna 1:

Test channel	6dB Emission Bandwidth (MHz)	
	For DSSS	For OFDM
905MHz	2.576	4.371
910MHz	2.563	4.196
915MHz	2.577	4.299
920MHz	2.564	4.194
Limit:	>500k	
Test Result:	PASS	

Test plots as follows:

905MHz Modulation

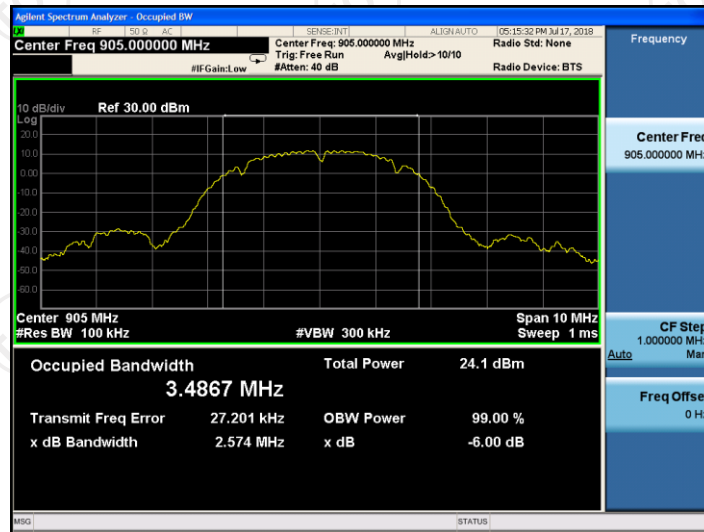

910MHz Modulation



915MHz Modulation

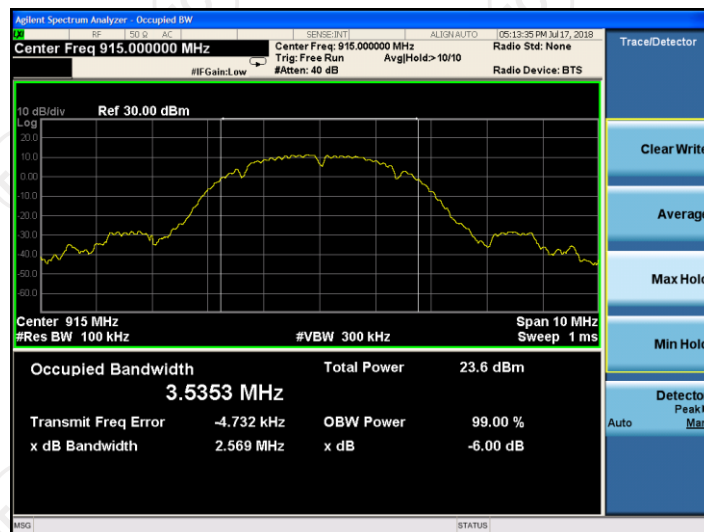

920MHz Modulation



905MHz Modulation

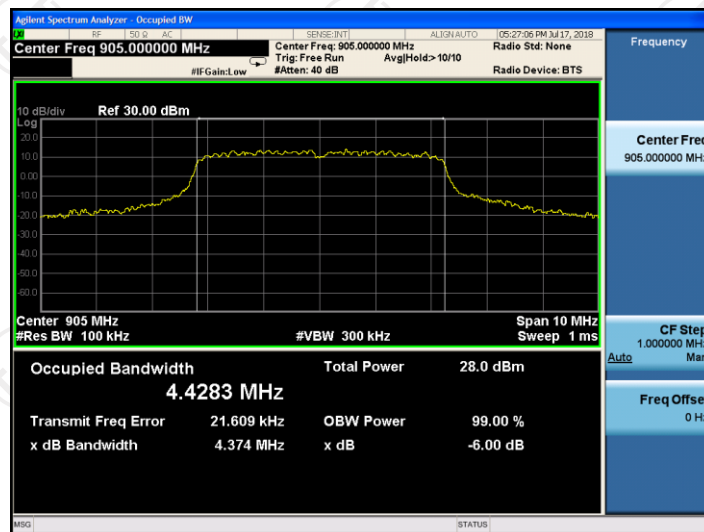

910MHz Modulation

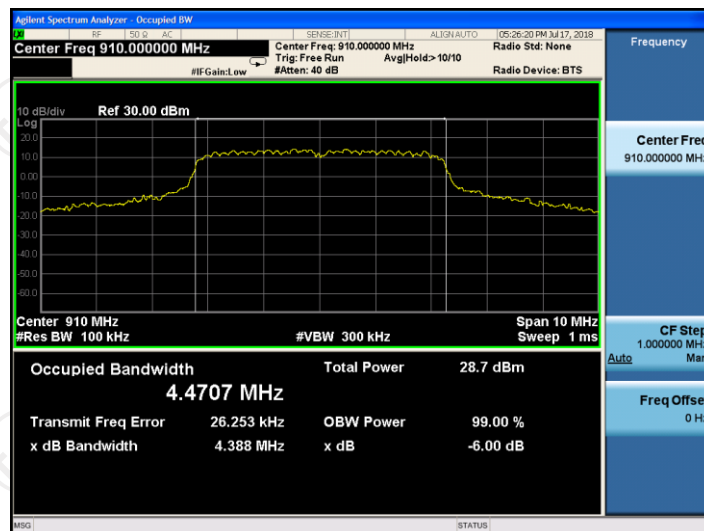

915MHz Modulation

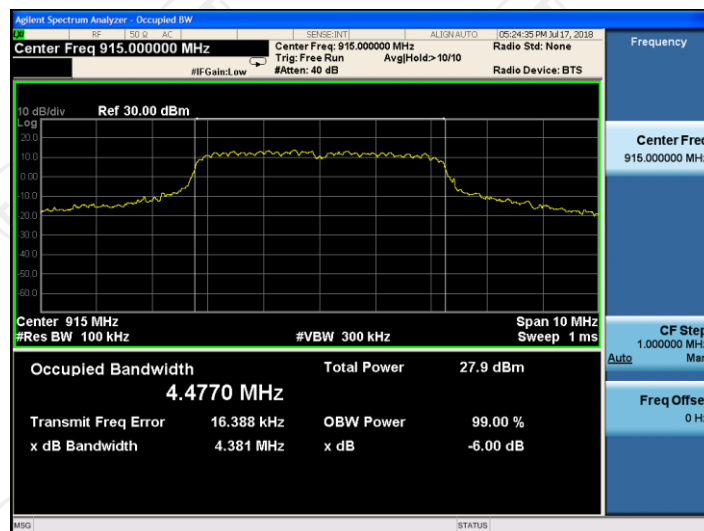

920MHz Modulation

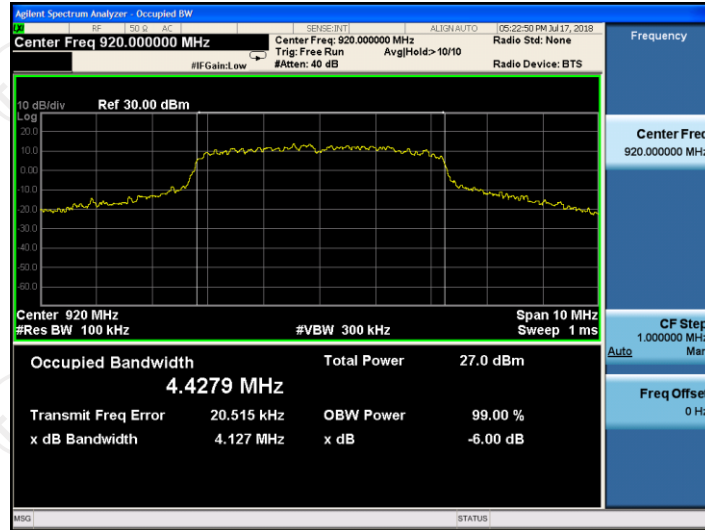

Antenna 1:
For DSSS

905MHz Modulation

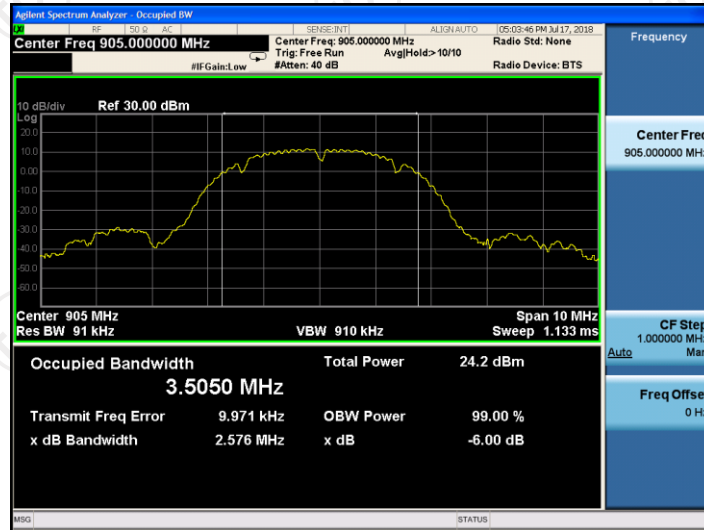

910MHz Modulation

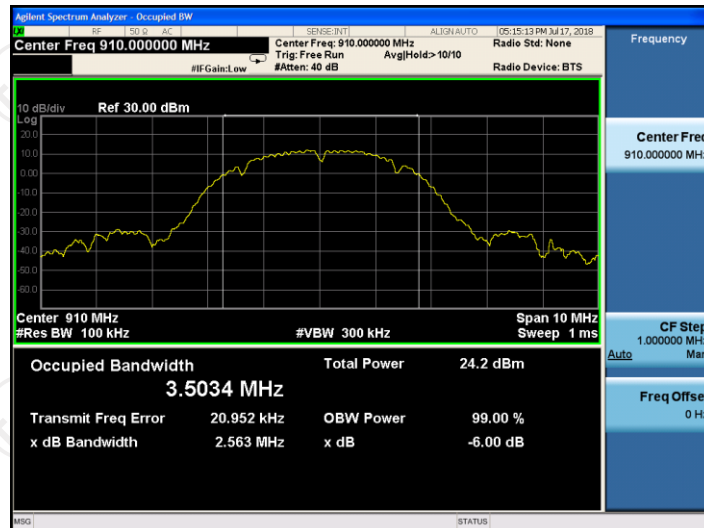

915MHz Modulation

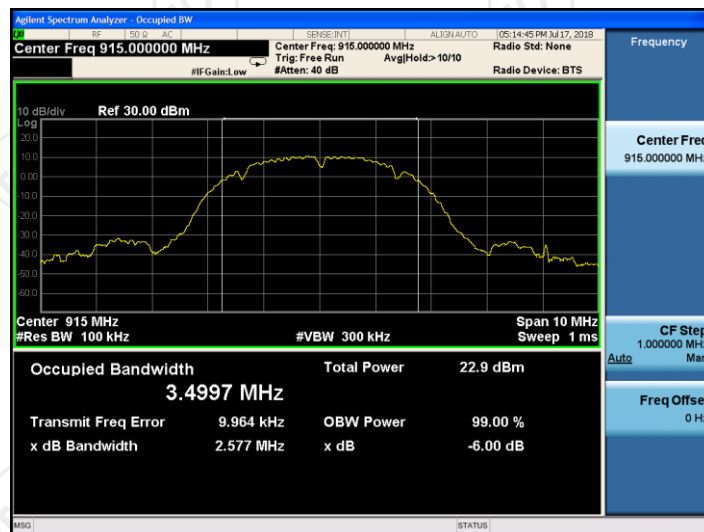

920MHz Modulation

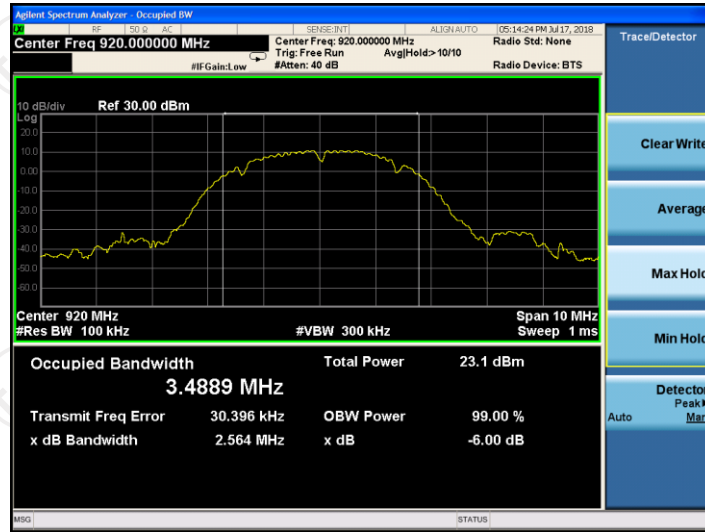

905MHz Modulation

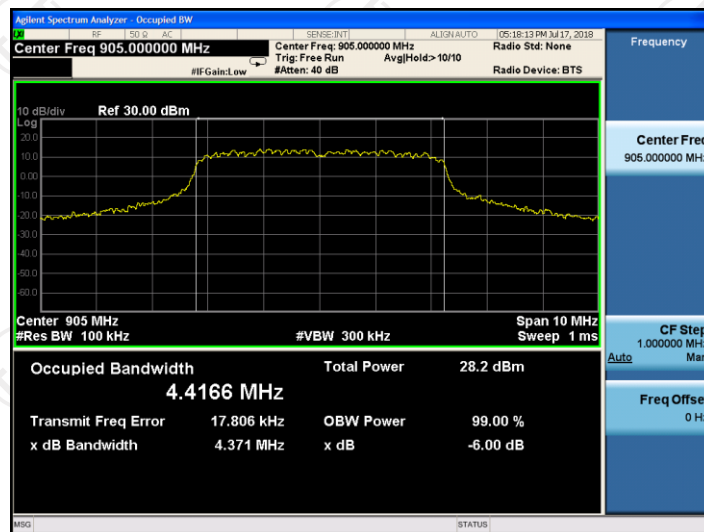

910MHz Modulation

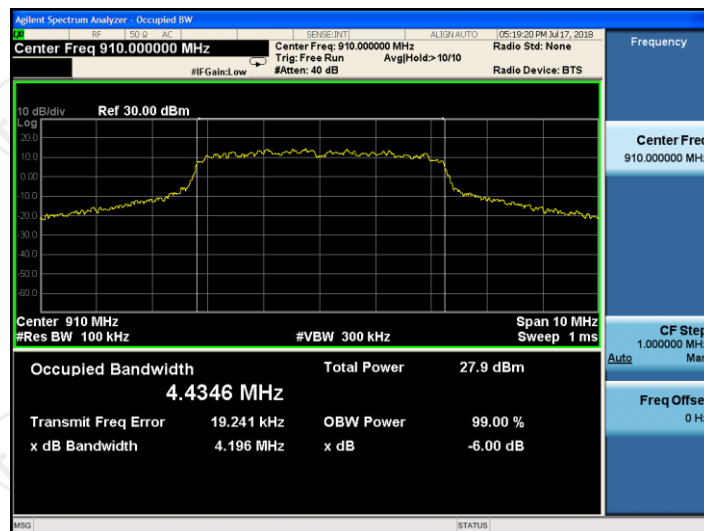

915MHz Modulation

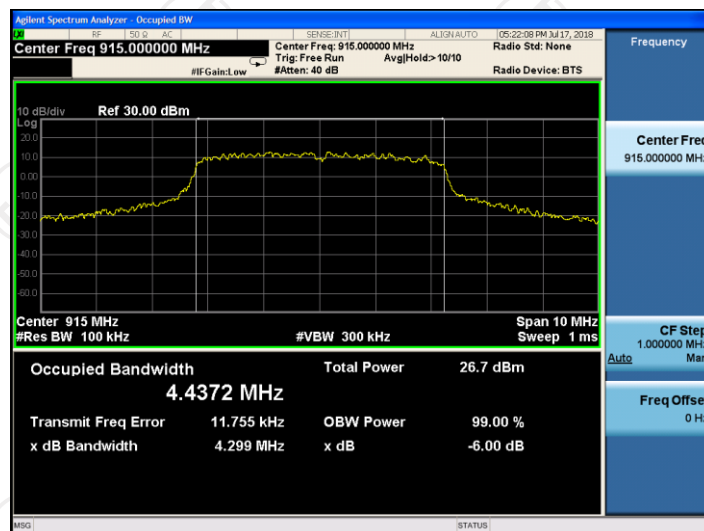

920MHz Modulation

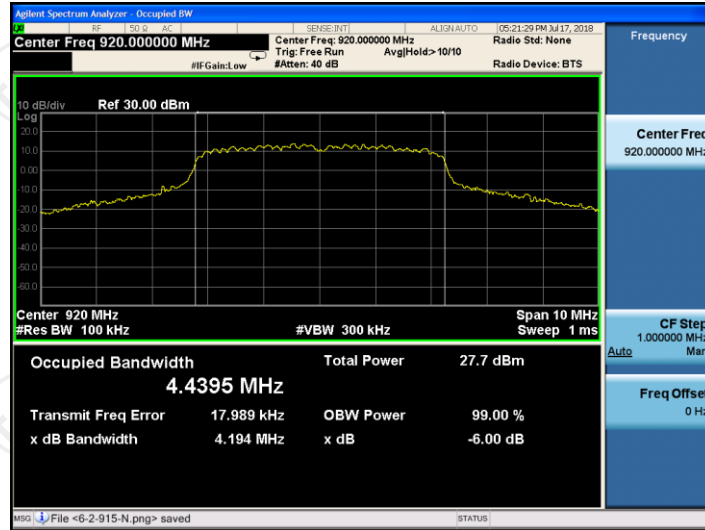

6.5. Power Spectral Density

6.5.1. Test Specification

Test Requirement:	FCC Part15 C Section 15.247 (e)
Test Method:	KDB 558074
Limit:	The average power spectral density shall not be greater than 8dBm in any 3kHz band at any time interval of continuous transmission.
Test Setup:	 <p style="text-align: center;">Spectrum Analyzer EUT</p>
Test Mode:	Transmitting mode with modulation
Test Procedure:	<ol style="list-style-type: none"> 1. The testing follows Measurement Procedure 10.3 Method AVGPSD of FCC KDB Publication No.558074 D01 DTS Meas. Guidance v04 2. The RF output of EUT was connected to the spectrum analyzer by RF cable and attenuator. The path loss was compensated to the results for each measurement. 3. Set to the maximum power setting and enable the EUT transmit continuously. 4. Make the measurement with the spectrum analyzer's resolution bandwidth (RBW): $3 \text{ kHz} \leq \text{RBW} \leq 100 \text{ kHz}$. Video bandwidth $\text{VBW} \geq 3 \times \text{RBW}$. Set the span to at least 1.5 times the OBW. 5. Detector = RMS, Sweep time = auto couple. 6. Employ trace averaging (RMS) mode over a minimum of 100 traces. Use the peak marker function to determine the maximum power level. 6. Measure and record the results in the test report.
Test Result:	PASS

6.5.2. Test Instruments

RF Test Room				
Equipment	Manufacturer	Model	Serial Number	Calibration Due
Spectrum Analyzer	Agilent	N9020A	MY49100060	Sep. 27, 2018
RF Cable (9KHz-26.5GHz)	TCT	RE-06	N/A	Sep. 27, 2018
Antenna Connector	TCT	RFC-01	N/A	Sep. 27, 2018

Note: The calibration interval of the above test instruments is 12 months and the calibrations are traceable to international system unit (SI).

6.5.3. Test data

For DSSS/ Antenna 0, Antenna 1					
Test channel	AVG Power Spectral Density (dBm/3kHz)			Limit (dBm)	Result
	Ant0	Ant1	Total		
905MHz	-2.15	-2.01	0.93	8dBm/3kHz	PASS
910MHz	-1.73	-1.84	1.23	8dBm/3kHz	PASS
915MHz	-2.70	-0.57	1.50	8dBm/3kHz	PASS
920MHz	-3.15	-1.60	0.70	8dBm/3kHz	PASS

For OFDM/ Antenna 0, Antenna 1					
Test channel	AVG Power Spectral Density (dBm/3kHz)			Limit (dBm)	Result
	Ant0	Ant1	Total		
905MHz	-5.23	-3.06	-1.00	8dBm/3kHz	PASS
910MHz	-5.27	-2.53	-0.68	8dBm/3kHz	PASS
915MHz	-5.77	-1.56	-0.16	8dBm/3kHz	PASS
920MHz	-6.58	-1.61	-0.41	8dBm/3kHz	PASS

Note: $G_{ANT} = 3\text{dBi}$, $\text{Array Gain} = 10\log(N_{ANT}/N_{SS}) = 3.01\text{dBi}$

$\text{Directional Gain} = G_{ANT} + \text{Array Gain} = 5.01\text{dBi} < 6\text{dBi}$, So limit=8dBm/3kHz

Test plots as follows:

905MHz Modulation



910MHz Modulation



915MHz Modulation

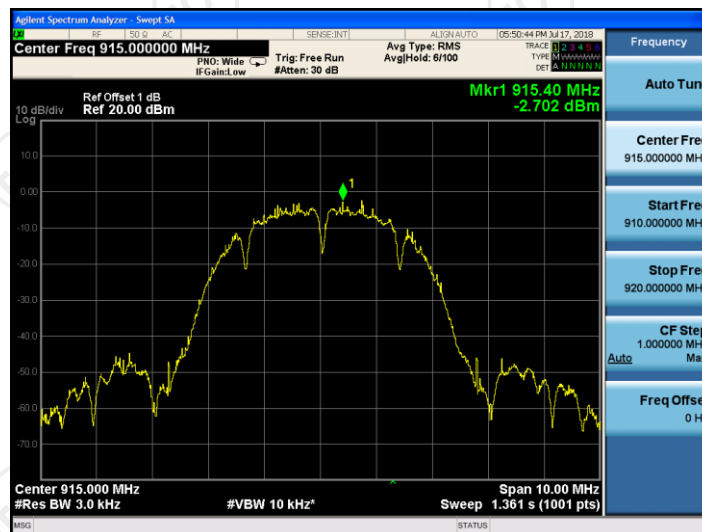

920MHz Modulation



905MHz Modulation

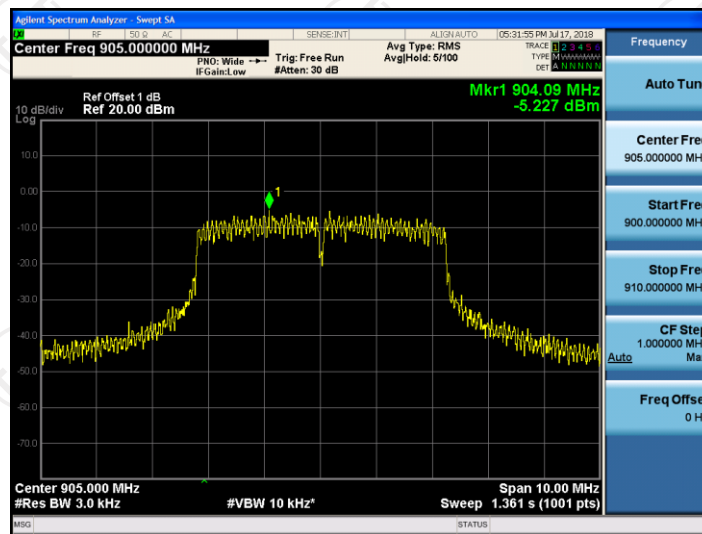

910MHz Modulation

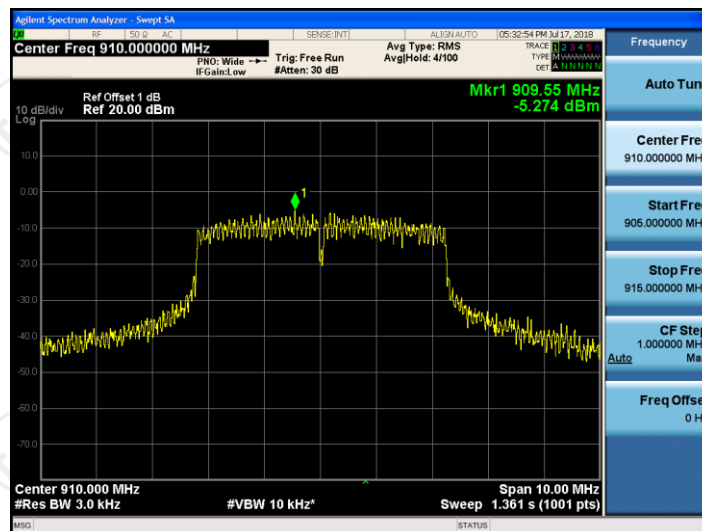

915MHz Modulation

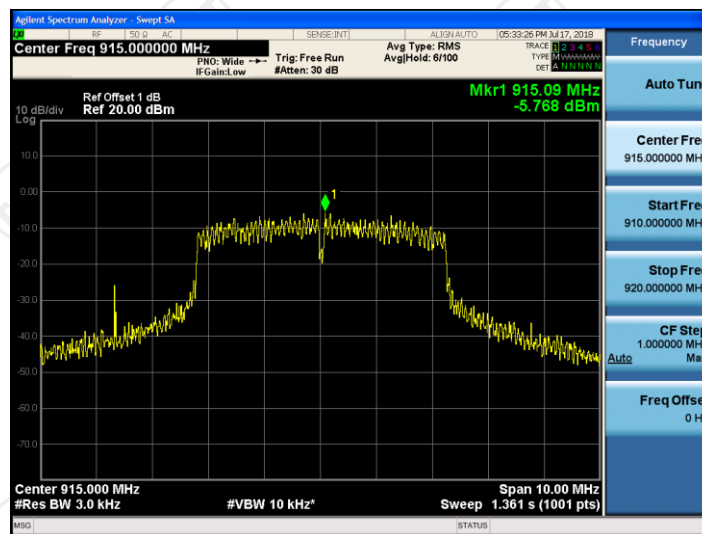

920MHz Modulation

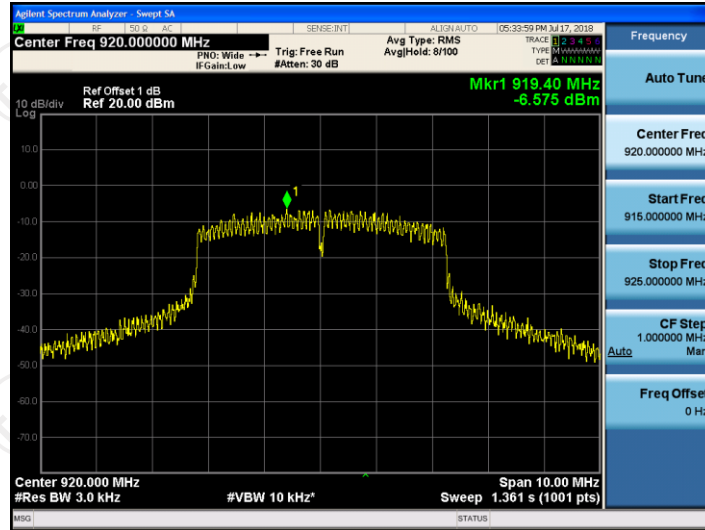

905MHz Modulation



910MHz Modulation

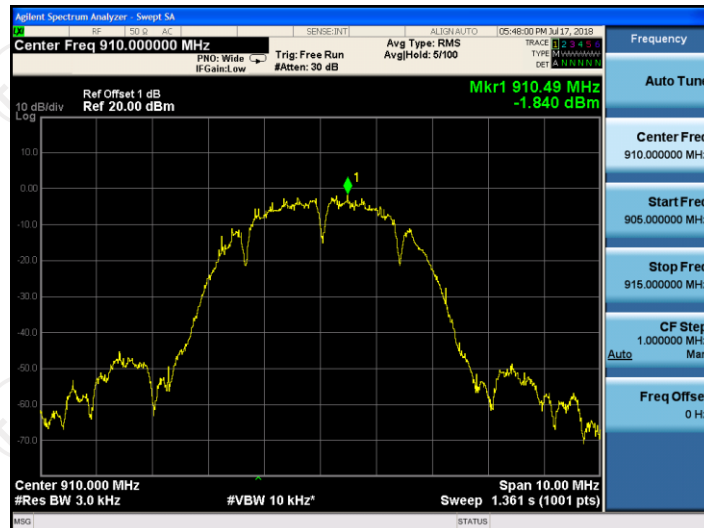

915MHz Modulation

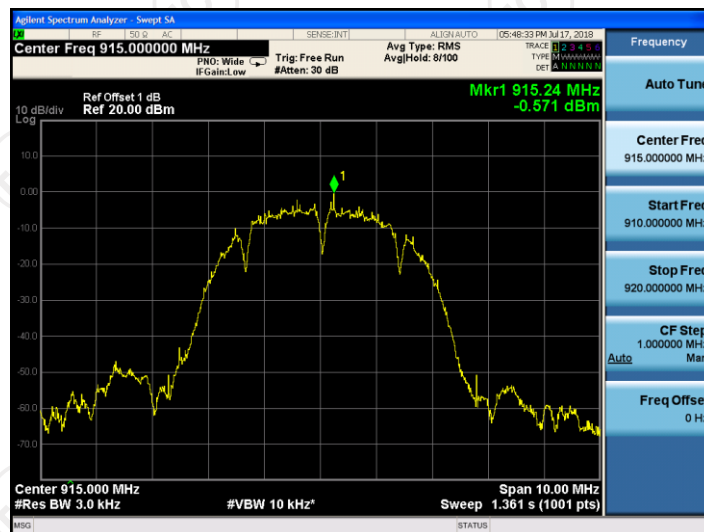

920MHz Modulation



905MHz Modulation

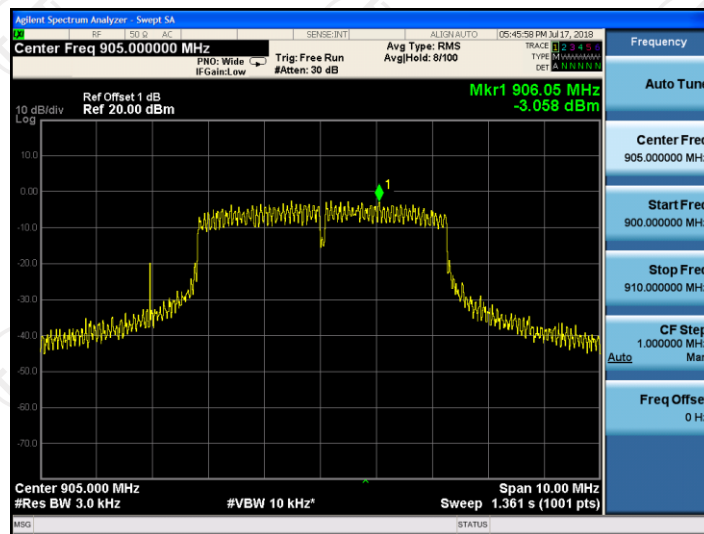

910MHz Modulation

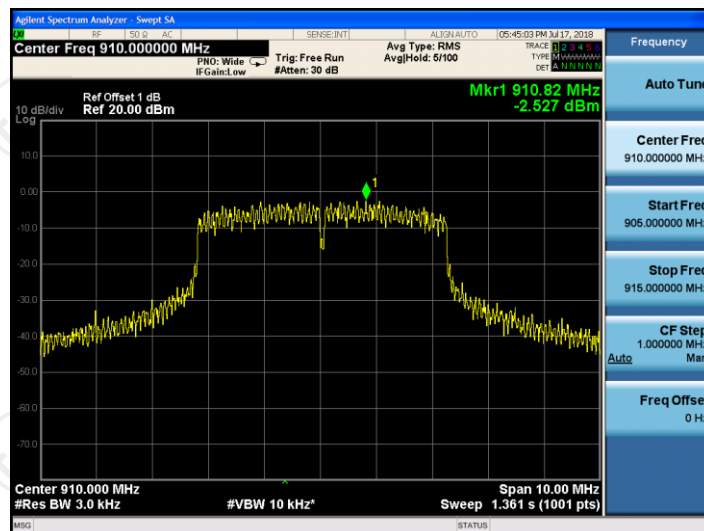

915MHz Modulation

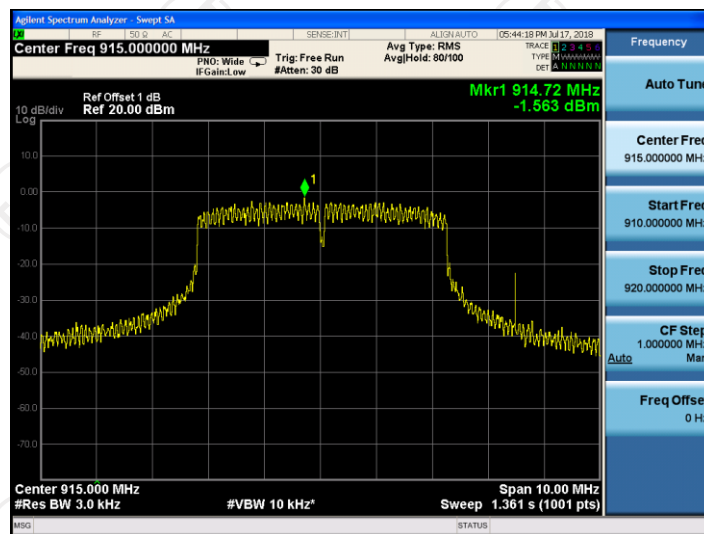

920MHz Modulation

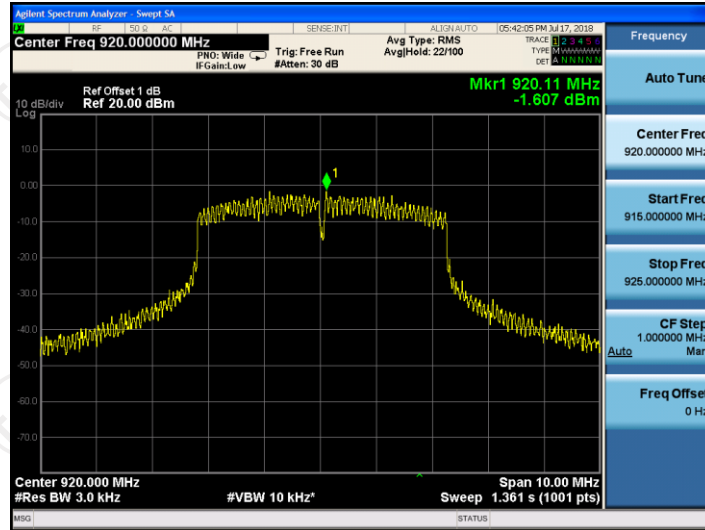

6.6. Conducted Band Edge and Spurious Emission Measurement

6.6.1. Test Specification

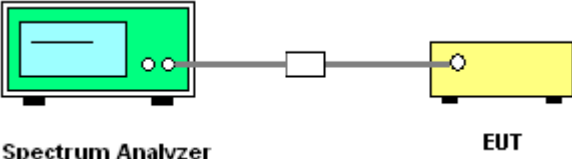
Test Requirement:	FCC Part15 C Section 15.247 (d)
Test Method:	KDB558074
Limit:	In any 100 kHz bandwidth outside of the authorized frequency band, the emissions which fall in the non-restricted bands shall be attenuated at least 20 dB / 30dB relative to the maximum PSD level in 100 kHz by RF conducted measurement and radiated emissions which fall in the restricted bands, as defined in Section 15.205(a), must also comply with the radiated emission limits specified in Section 15.209(a).
Test Setup:	 <p style="text-align: center;">Spectrum Analyzer EUT</p>
Test Mode:	Transmitting mode with modulation
Test Procedure:	<ol style="list-style-type: none"> 1. The testing follows FCC KDB Publication No. 558074 D01 DTS Meas. Guidance v04. 2. The RF output of EUT was connected to the spectrum analyzer by RF cable and attenuator. The path loss was compensated to the results for each measurement. 3. Set to the maximum power setting and enable the EUT transmit continuously. 4. Set RBW = 100 kHz, VBW=300 kHz, Peak Detector. Unwanted Emissions measured in any 100 kHz bandwidth outside of the authorized frequency band shall be attenuated by at least 20 dB relative to the maximum in-band peak PSD level in 100 kHz when maximum peak conducted output power procedure is used. If the transmitter complies with the conducted power limits based on the use of RMS averaging over a time interval, the attenuation required under this paragraph shall be 30 dB instead of 20 dB per 15.247(d). 5. Measure and record the results in the test report. 6. The RF fundamental frequency should be excluded against the limit line in the operating frequency band.
Test Result:	PASS

6.6.2. Test Instruments

RF Test Room				
Equipment	Manufacturer	Model	Serial Number	Calibration Due
Spectrum Analyzer	Agilent	N9020A	MY49100060	Sep. 27, 2018
Spectrum Analyzer	ROHDE&SCHWARZ	FSQ	200061	Sep. 27, 2018
RF Cable (9KHz-26.5GHz)	TCT	RE-06	N/A	Sep. 27, 2018
Antenna Connector	TCT	RFC-01	N/A	Sep. 27, 2018

Note: The calibration interval of the above test instruments is 12 months and the calibrations are traceable to international system unit (SI).

6.6.3. Test Data

Antenna 0:
For DSSS
905MHz

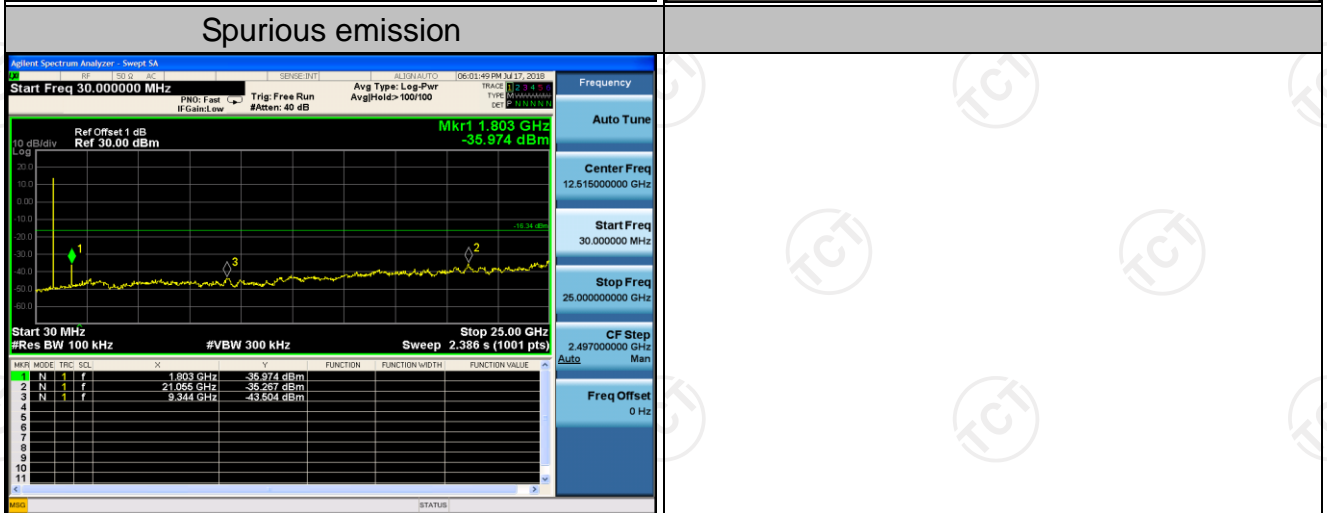
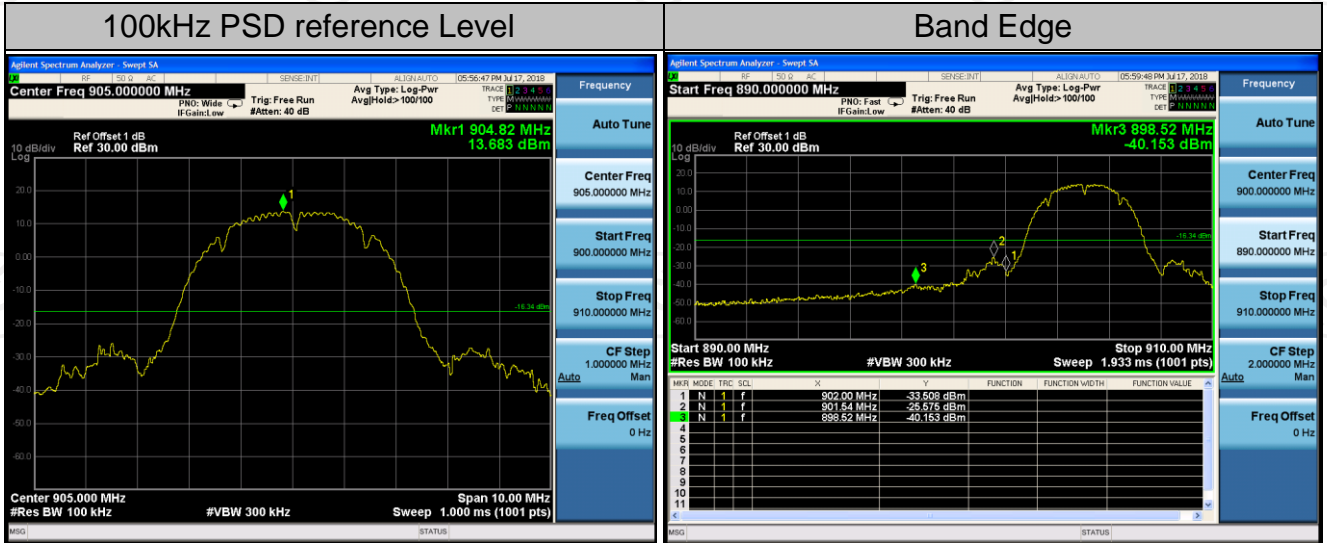

910MHz

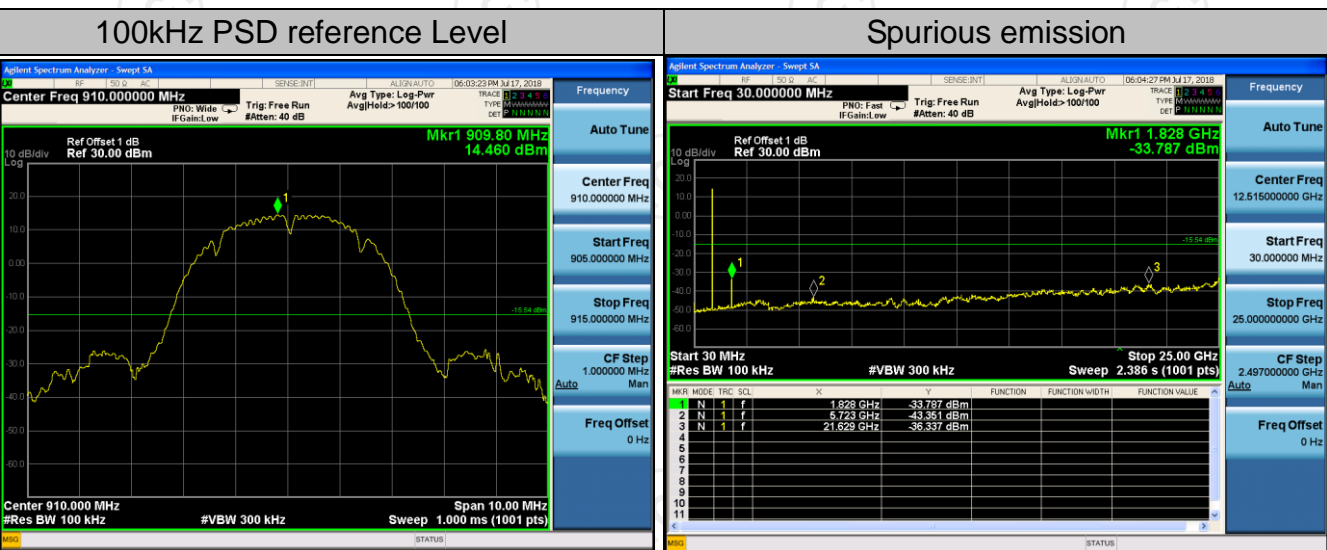

915MHz

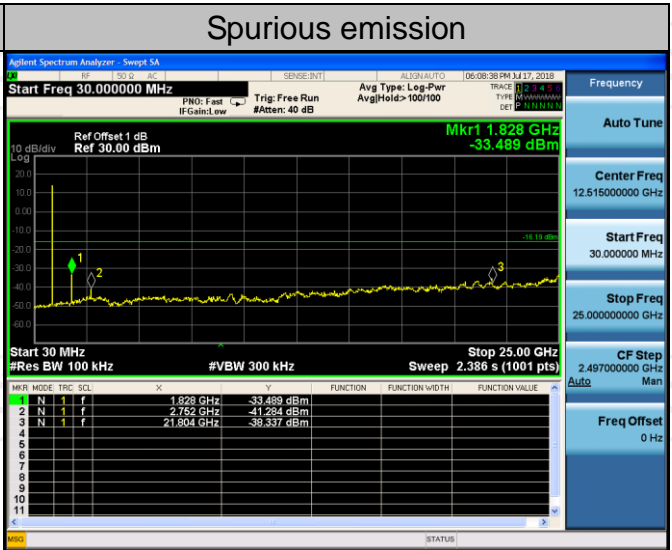
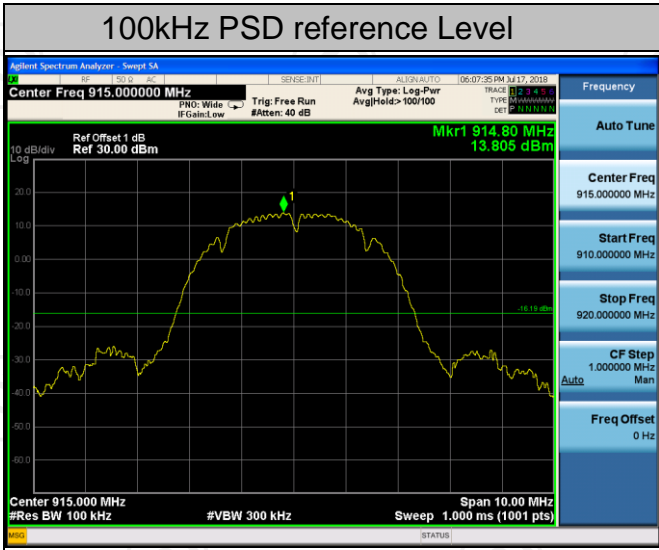

920MHz

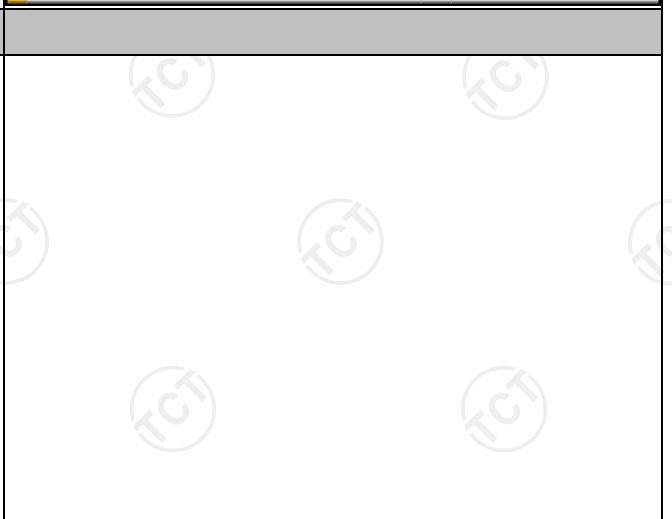
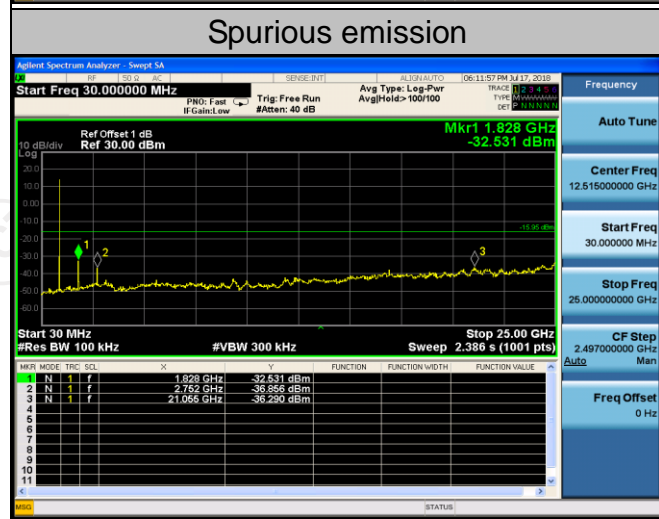
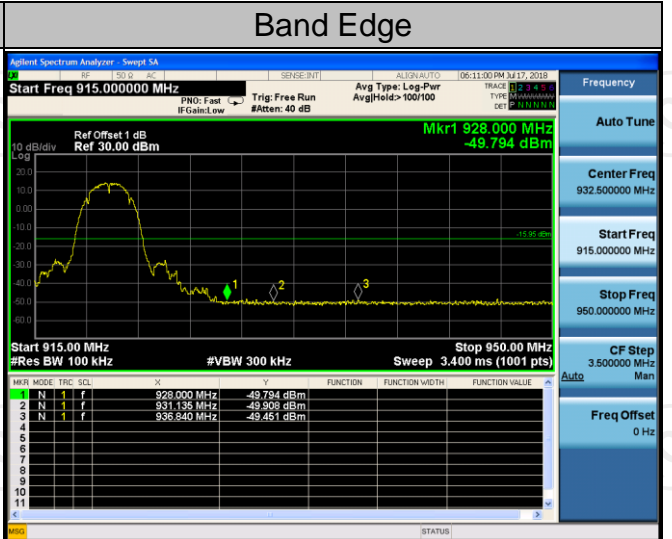
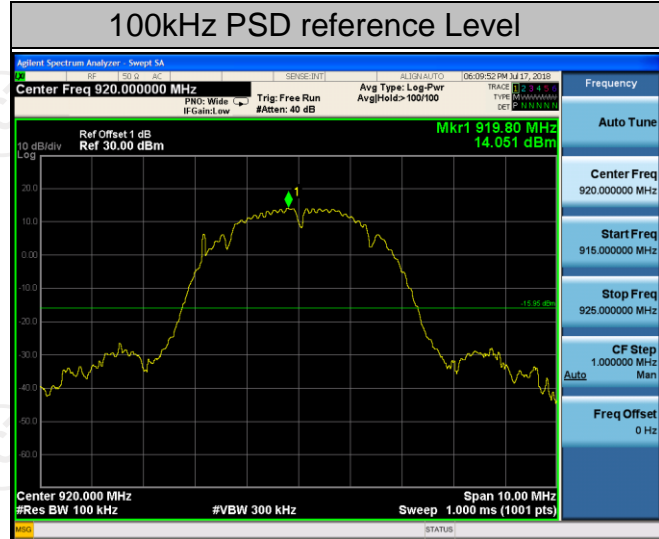

100kHz PSD reference Level

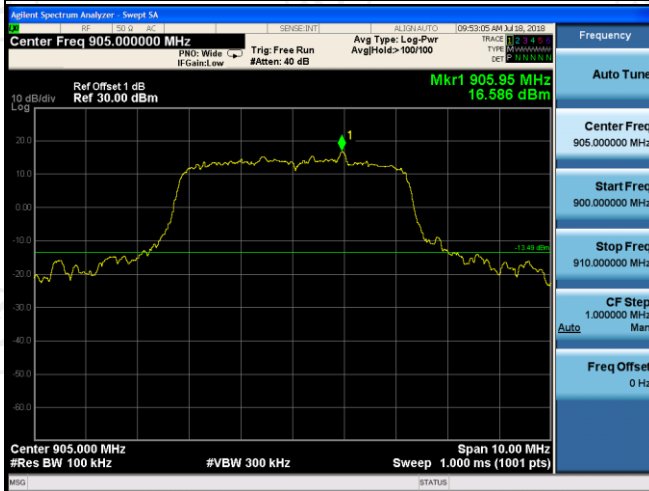

Band Edge



Spurious emission

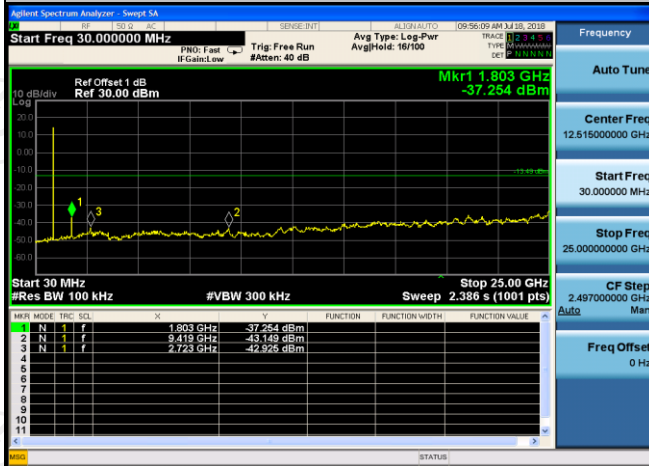

910MHz

100kHz PSD reference Level



Spurious emission

