

TEST REPORT

FCC ID: 2AG87NM-4965-1F

Product: 4.9 GHz Wireless Broadband Interface Card

Model No.: NM-4965-1F

Additional Model: NL-4965-1F

Trade Mark: Wireless Communications

Report No.: TCT160823E035

Issued Date: Nov. 21, 2016

Issued for:

Doodle Labs (SG) Pte Ltd

150 Kampong Ampat, KA Centre, Suite #05-03, Singapore 368324

Issued By:

Shenzhen Tongce Testing Lab.

1F, Leinuo Watch Building, Fuyong Town, Baoan Dist, Shenzhen, China

TEL: +86-755-27673339

FAX: +86-755-27673332

Note: This report shall not be reproduced except in full, without the written approval of Shenzhen Tongce Testing Lab.

This document may be altered or revised by Shenzhen Tongce Testing Lab. personnel only, and shall be noted in the revision section of the document. The test results in the report only apply to the tested sample.

TABLE OF CONTENTS

1. Test Certification..... 3

2. Test Result Summary 4

3. EUT Description 5

4. Genera Information..... 6

 4.1. Test environment and mode 6

 4.2. Description of Support Units 7

5. Facilities and Accreditations 8

 5.1. Facilities 8

 5.2. Location 8

 5.3. Measurement Uncertainty 8

6. Test Results and Measurement Data 9

 6.1. Occupied Bandwidth & Emissions Mask..... 9

 6.2. Output Power..... 24

 6.3. Power Spectral Density 27

 6.4. Conducted Spurious Emission Measurement 36

 6.5. Radiated Spurious Emission Measurement 43

 6.6. Frequency Stability Measurement..... 48

Appendix A: Test result of conducted Test

Appendix B: Photographs of Test Setup

Appendix C: Photographs of EUT

1. Test Certification

Product:	4.9 GHz Wireless Broadband Interface Card
Model No.:	NM-4965-1F
Additional Model No.:	NL-4965-1F
Applicant:	Doodle Labs (SG) Pte Ltd
Address:	150 Kampong Ampat, KA Centre, Suite #05-03, Singapore 368324
Manufacturer:	Doodle Labs (SG) Pte Ltd
Address:	150 Kampong Ampat, KA Centre, Suite #05-03, Singapore 368324
Date of Test:	Aug. 23 – Nov. 21, 2016
Applicable Standards:	FCC CFR Title 47 Part 90 Subpart Y

The above equipment has been tested by Shenzhen Tongce Testing Lab. and found compliance with the requirements set forth in the technical standards mentioned above. The results of testing in this report apply only to the product/system, which was tested. Other similar equipment will not necessarily produce the same results due to production tolerance and measurement uncertainties.

Tested By:



Garen

Date:

Nov. 21, 2016

Reviewed By:



Joe Zhou

Date:

Nov. 21, 2016

Approved By:



Tomsin

Date:

Nov. 21, 2016

2. Test Result Summary

Requirement	CFR 47 Section	Result
Occupied Bandwidth & Emissions Mask	FCC §2.1049 FCC §90.210	PASS
Peak Output Power	FCC §2.1046 FCC §90.1215(a)	PASS
Power Spectral Density	FCC §2.1046 FCC §90.1215(a)	PASS
Conducted Spurious Emissions at the Antenna Terminals	FCC §2.1051 FCC §90.210	PASS
Radiated Spurious Emissions	FCC §2.1053 FCC §90.210 TIA-603-D	PASS
Frequency Stability	FCC §2.1055 FCC §90.213	PASS

Note:

1. PASS: Test item meets the requirement.
2. Fail: Test item does not meet the requirement.
3. N/A: Test case does not apply to the test object.
4. The test result judgment is decided by the limit of test standard.

3. EUT Description

Product Name:	4.9 GHz Wireless Broadband Interface Card
Model :	NM-4965-1F
Additional Model:	NL-4965-1F
Trade Mark:	Wireless Communications
Operation Frequency:	4940MHz – 4990MHz
Channel Bandwidth	5MHz, 10MHz, 20MHz
Hardware Version:	V1.0
Software Version:	V1.0
Modulation Technology:	OFDM
Antenna Type:	External Antenna
Antenna Gain:	3dBi
Power Supply:	DC 3.3V from PCI

Frequency Range	Channel Bandwidth	Emission Designator
4942.5-4987.5MHz	5 MHz	4M14W7D
4945.0-4985.0 MHz	10 MHz	8M35W7D
4950.0-4980.0 MHz	20 MHz	16M77W7D

Test frequency for 5MHz Channel Bandwidth

Channel	Frequency
The lowest channel	4942.5MHz
The middle channel	4967.5MHz
The Highest channel	4987.5MHz

Test frequency for 10MHz Channel Bandwidth

Channel	Frequency
The lowest channel	4945.0MHz
The middle channel	4967.5MHz
The Highest channel	4985.0MHz

Test frequency for 20MHz Channel Bandwidth

Channel	Frequency
The lowest channel	4950.0MHz
The middle channel	4965.0MHz
The Highest channel	4980.0MHz

4. Genera Information

4.1. Test environment and mode

Operating Environment:	
Temperature:	25.0 °C
Humidity:	56 % RH
Atmospheric Pressure:	1010 mbar
Test Mode:	
Engineering mode:	Keep the EUT in continuous transmitting by select channel and modulations

The sample was placed (0.8m below 1GHz, 1.5m above 1GHz) above the ground plane of 3m chamber. Measurements in both horizontal and vertical polarities were performed. During the test, each emission was maximized by: having the EUT continuously working, investigated all operating modes, rotated about all 3 axis (X, Y & Z) and considered typical configuration to obtain worst position, manipulating interconnecting cables, rotating the turntable, varying antenna height from 1m to 4m in both horizontal and vertical polarizations. The emissions worst-case are shown in Test Results of the following pages.

Test setup for Radiation:

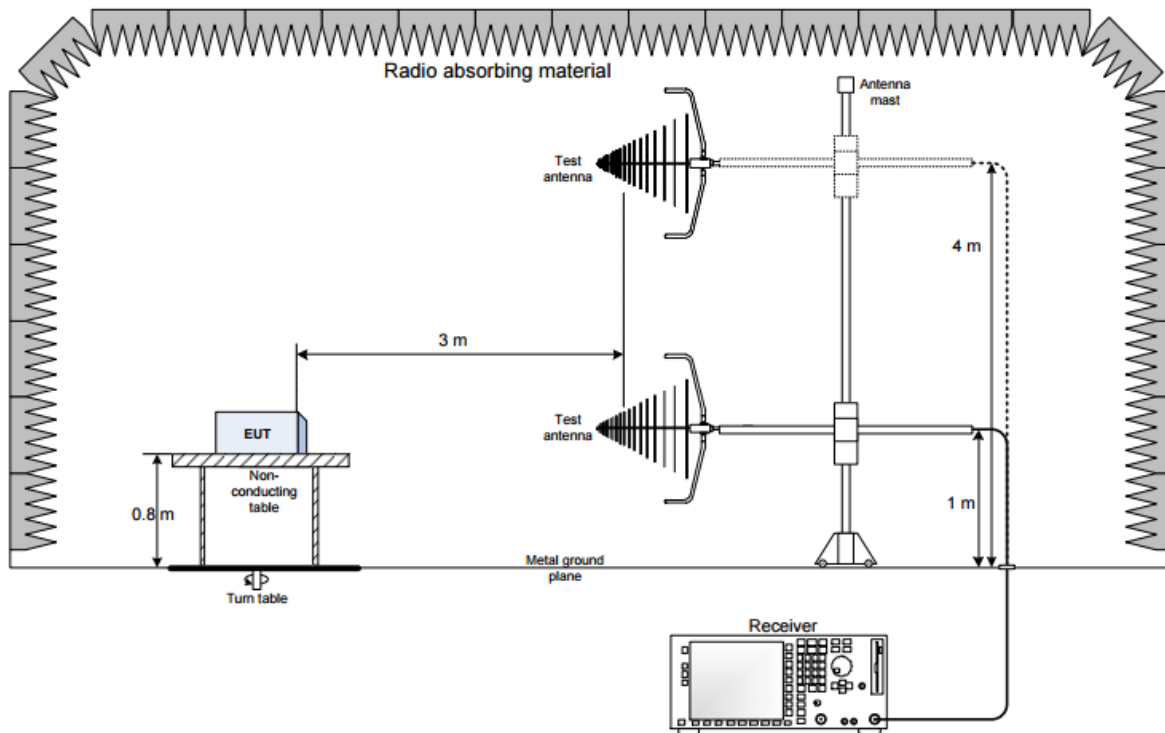

Test setup for Conducted emission (Exclude Output Power Test):

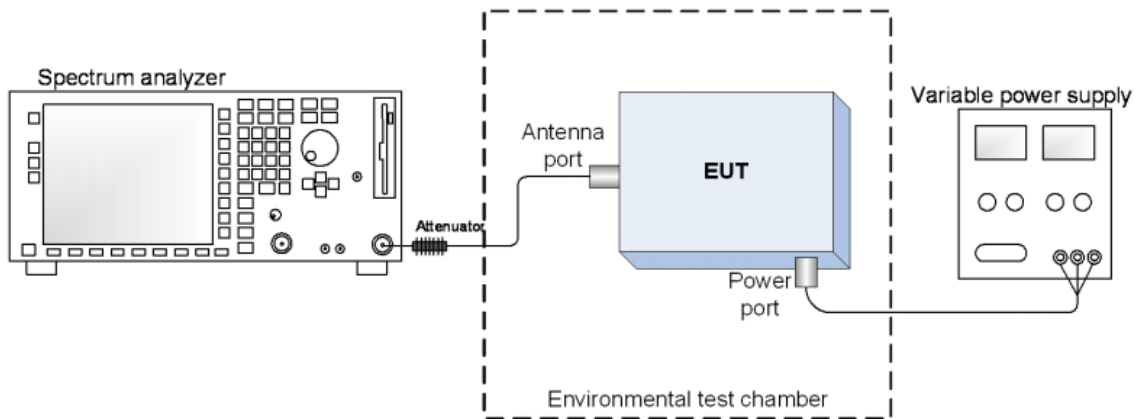

4.2. Description of Support Units

The EUT has been tested as an independent unit together with other necessary accessories or support units. The following support units or accessories were used to form a representative test configuration during the tests.

Equipment	Model No.	Serial No.	FCC ID	Trade Name
Notebook	G485	/	/	Lenovo

Note:

1. All the equipment/cables were placed in the worst-case configuration to maximize the emission during the test.
2. Grounding was established in accordance with the manufacturer's requirements and conditions for the intended use.
3. For conducted measurements (Output Power, Emission Bandwidth, Power Spectral Density, Spurious Emissions etc.), the antenna of EUT is connected to the test equipment via temporary antenna connector, the antenna connector is soldered on the antenna port of EUT, and the temporary antenna connector is listed in the Test Instruments.

5. Facilities and Accreditations

5.1. Facilities

The test facility is recognized, certified, or accredited by the following organizations:

- FCC - Registration No.: 572331
Shenzhen Tongce Testing Lab
The 3m Semi-anechoic chamber has been registered and fully described in a report with the (FCC) Federal Communications Commission. The acceptance letter from the FCC is maintained in our files.
- IC - Registration No.: 10668A-1
The 3m Semi-anechoic chamber of Shenzhen TCT Testing Technology Co., Ltd. has been registered by Certification and Engineering Bureau of Industry Canada for radio equipment testing
- CNAS - Registration No.: CNAS L6165
Shenzhen TCT Testing Technology Co., Ltd. is accredited to ISO/IEC 17025:2005 General Requirements for the Competence of Testing and Calibration laboratories for the competence of testing. The Registration No. is CNAS L6165.

5.2. Location

Shenzhen Tongce Testing Lab

Address: 1F, Leinuo Watch Building, Fuyong Town, Baoan Dist, Shenzhen, China

Tel: 86-755-36638142

5.3. Measurement Uncertainty

The reported uncertainty of measurement $y \pm U$, where expanded uncertainty U is based on a standard uncertainty multiplied by a coverage factor of $k=2$, providing a level of confidence of approximately 95 %.

No.	Item	MU
1	Conducted Emission	$\pm 2.56\text{dB}$
2	RF power, conducted	$\pm 0.12\text{dB}$
3	Spurious emissions, conducted	$\pm 0.11\text{dB}$
4	All emissions, radiated(<1G)	$\pm 3.92\text{dB}$
5	All emissions, radiated(>1G)	$\pm 4.28\text{dB}$
6	Temperature	$\pm 0.1^\circ\text{C}$
7	Humidity	$\pm 1.0\%$

6. Test Results and Measurement Data

6.1. Occupied Bandwidth & Emissions Mask

6.1.1. Test Specification

Test Requirement:	FCC CFR part §90.210, CFR part §2.1049
Limit:	N/A
Test Mode:	Transmitting mode with modulation
Test Procedure:	The zero dB reference is measured relative to the highest average power of the fundamental emission measured across the designated channel bandwidth using a resolution bandwidth of at least one percent of the occupied bandwidth of the fundamental emission and a video bandwidth of 30 kHz.
Test Result:	PASS

6.1.2. Test Instruments

Equipment	Manufacturer	Model	Serial Number	Calibration Due
Spectrum Analyzer	Agilent	N9020A	MY49100060	Aug. 12, 2017
RF cable	TCT	RE-06	N/A	Aug. 12, 2017
Antenna Connector	TCT	RFC-01	N/A	Aug. 12, 2017

Note: The calibration interval of the above test instruments is 12 months and the calibrations are traceable to international system unit (SI).

6.1.3. Test data

Channel	Frequency(MHz)	99% Bandwidth	26dB Bandwidth
Lowest	4942.5	4.14	5.64
Middle	4967.5	4.13	5.63
Highest	4987.5	4.13	5.43
5MHz Bandwidth for Radio-card+Amp			

Channel	Frequency(MHz)	99% Bandwidth	26dB Bandwidth
Lowest	4945.0	8.29	11.33
Middle	4967.5	8.35	14.33
Highest	4985.0	8.28	11.00
10MHz Bandwidth for Radio-card+Amp			

Channel	Frequency(MHz)	99% Bandwidth	26dB Bandwidth
Lowest	4950.0	16.63	24.57
Middle	4965.0	16.63	24.63
Highest	4980.0	16.64	24.18
20MHz Bandwidth for Radio-card+Amp			

Test Plots As Following Page:

5MHz

Lowest channel

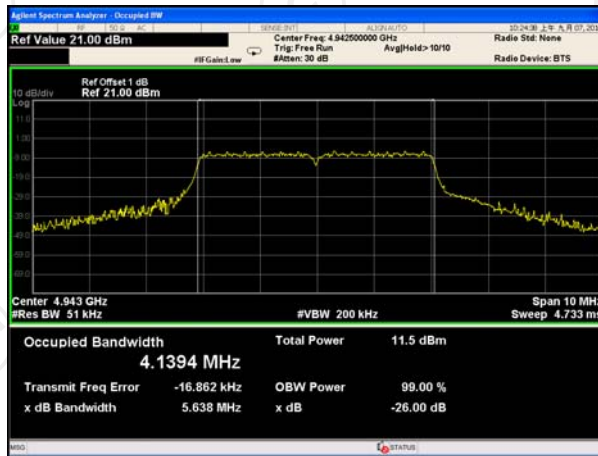

Middle channel

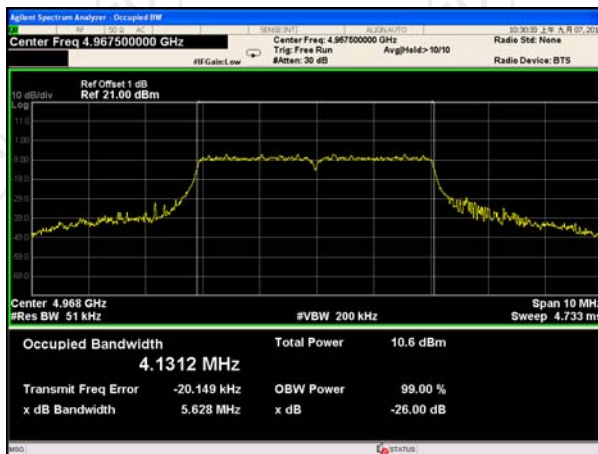

Highest channel

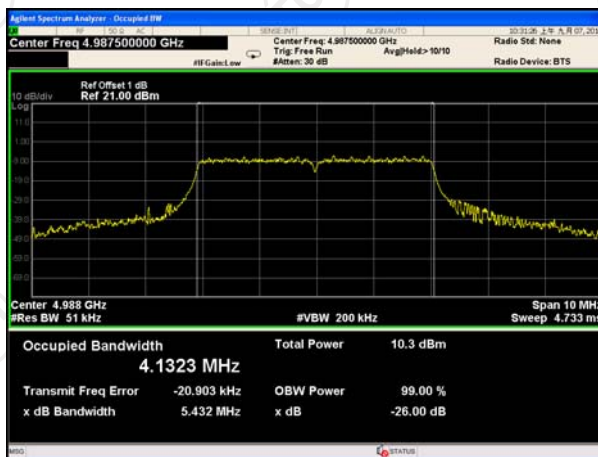

10MHz

Lowest channel

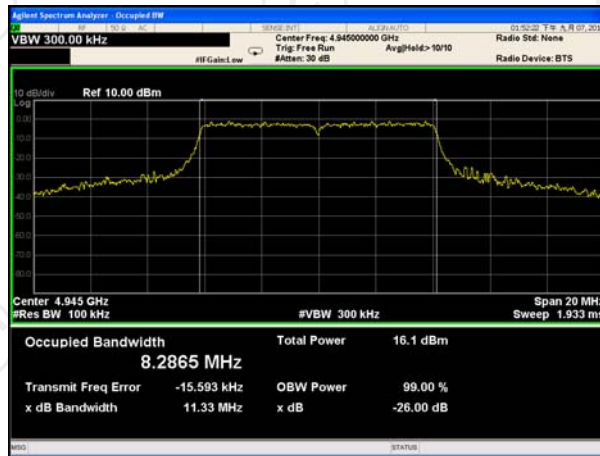

Middle channel

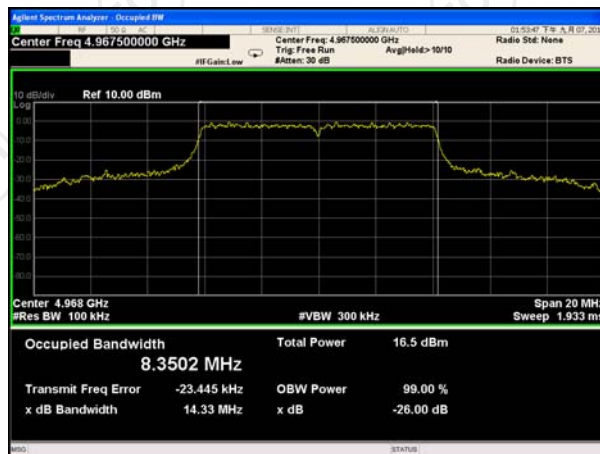

Highest channel

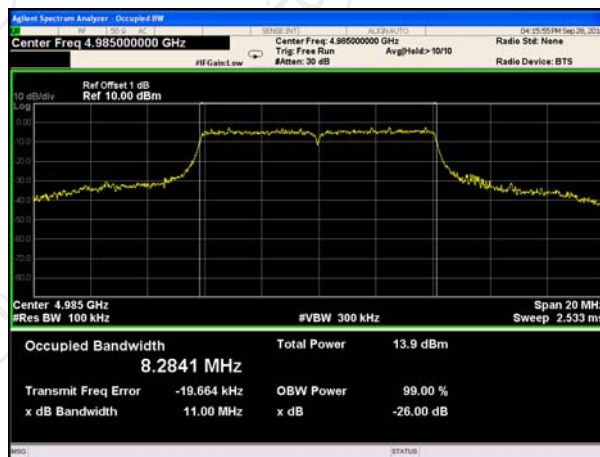

20MHz

Lowest channel

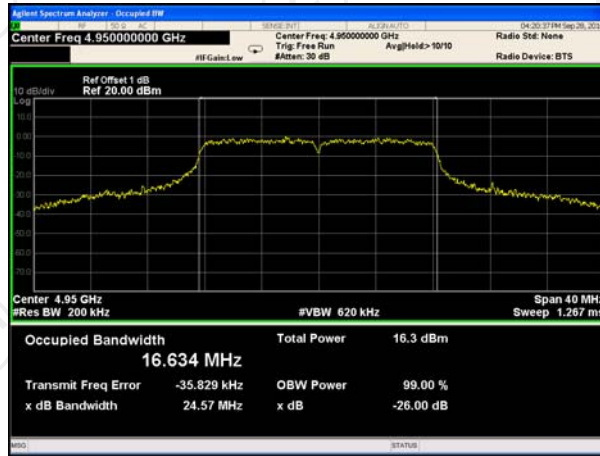

Middle channel

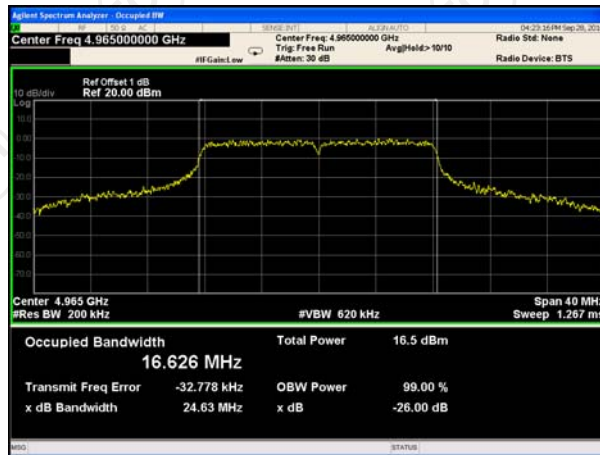

Highest channel

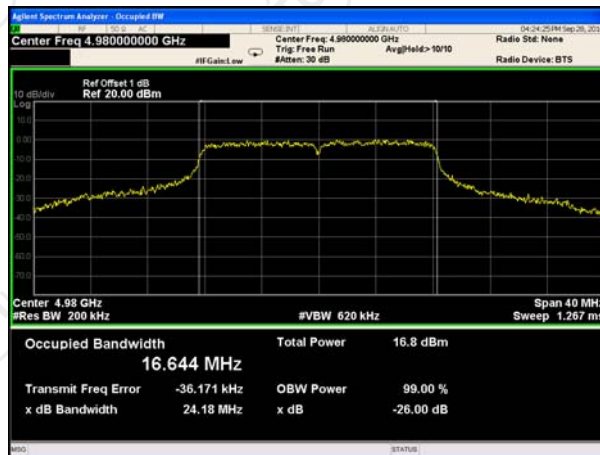

**Emission Mask Test Plots:
5MHz**

Lowest channel

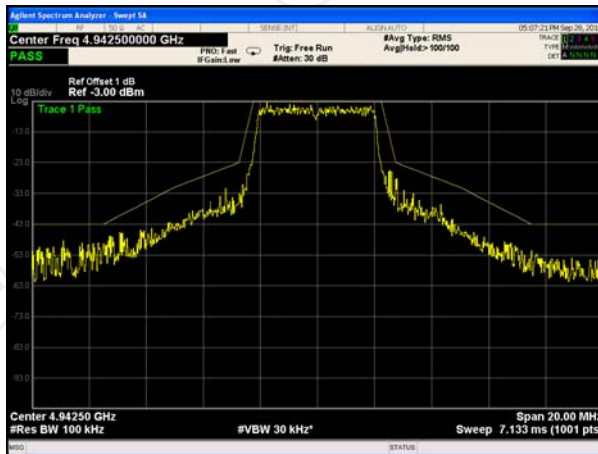

Middle channel

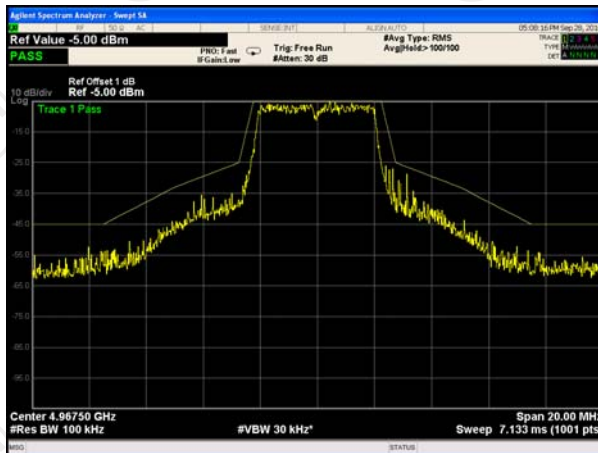

Highest channel

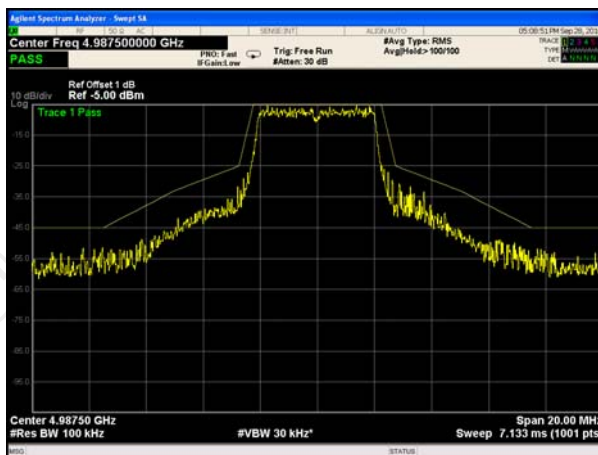

10MHz

Lowest channel

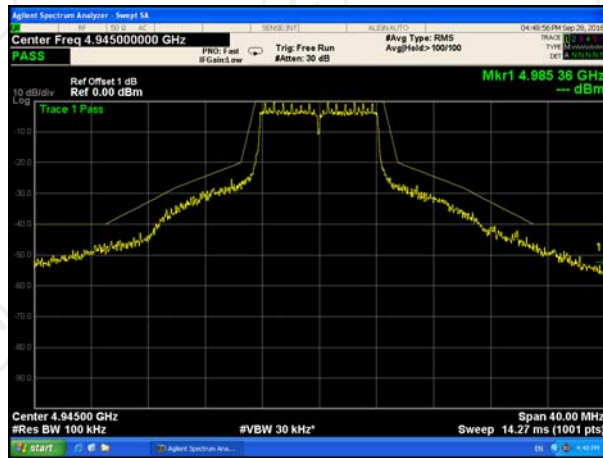

Middle channel

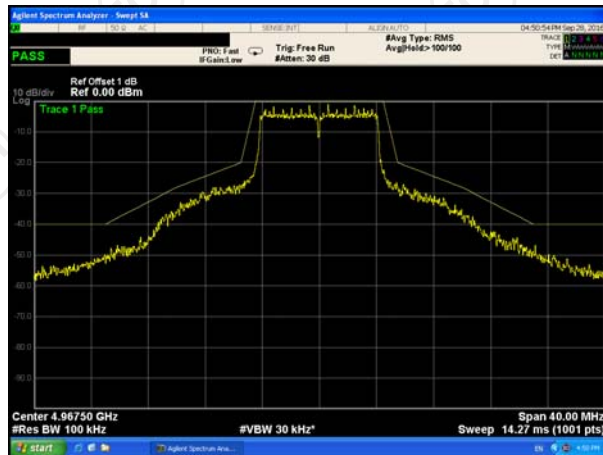

Highest channel

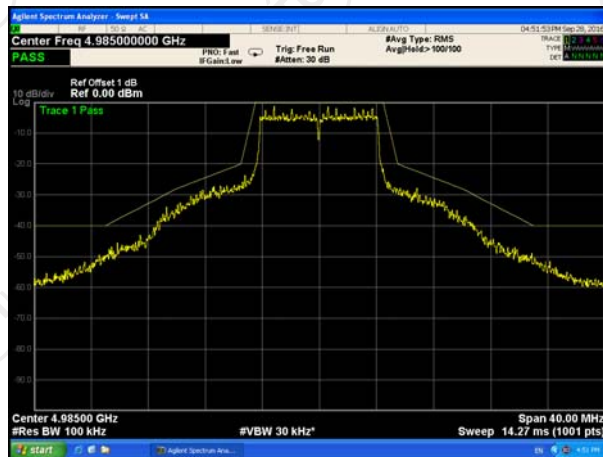

20MHz

Lowest channel

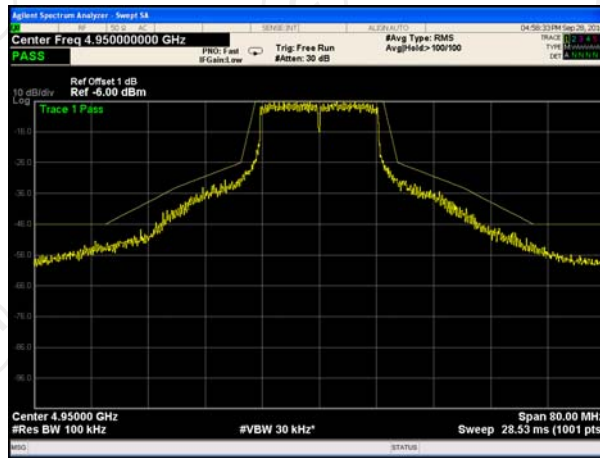

Middle channel

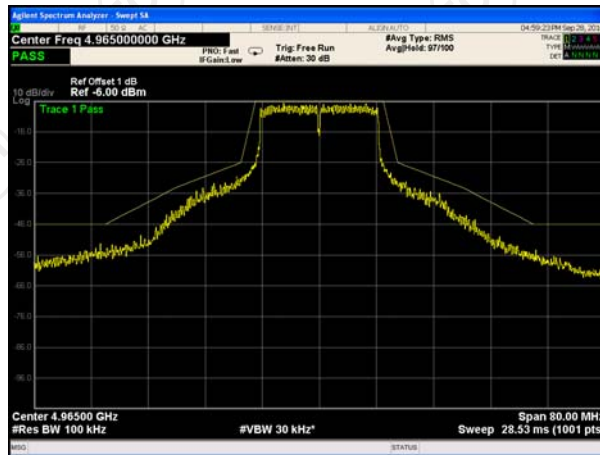

Highest channel



Channel	Frequency(MHz)	99% Bandwidth	26dB Bandwidth
Lowest	4942.5	4.14	5.72
Middle	4967.5	4.13	5.24
Highest	4987.5	4.13	5.60
5MHz Bandwidth for Radio-card			

Channel	Frequency(MHz)	99% Bandwidth	26dB Bandwidth
Lowest	4945.0	8.32	13.41
Middle	4967.5	8.32	13.02
Highest	4985.0	8.29	11.84
10MHz Bandwidth for Radio-card			

Channel	Frequency(MHz)	99% Bandwidth	26dB Bandwidth
Lowest	4950.0	16.77	29.31
Middle	4965.0	16.61	24.00
Highest	4980.0	16.57	23.13
20MHz Bandwidth for Radio-card			

Test Plots As Following Page:

5MHz

Lowest channel

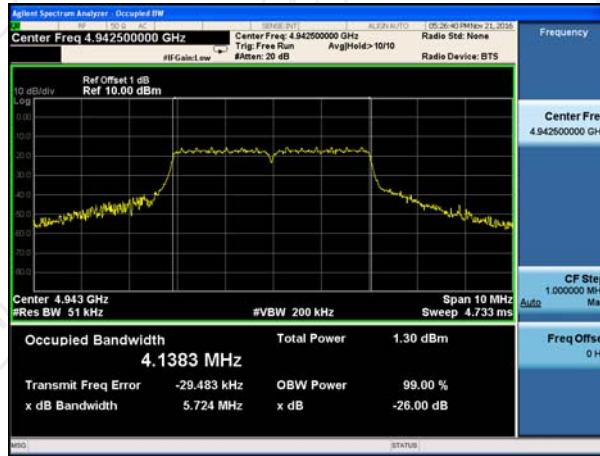

Middle channel

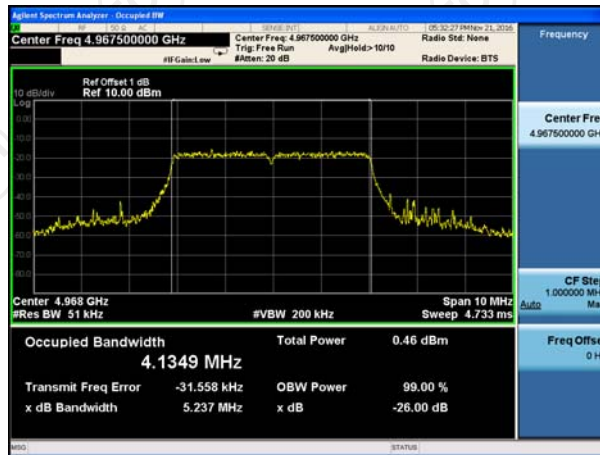

Highest channel

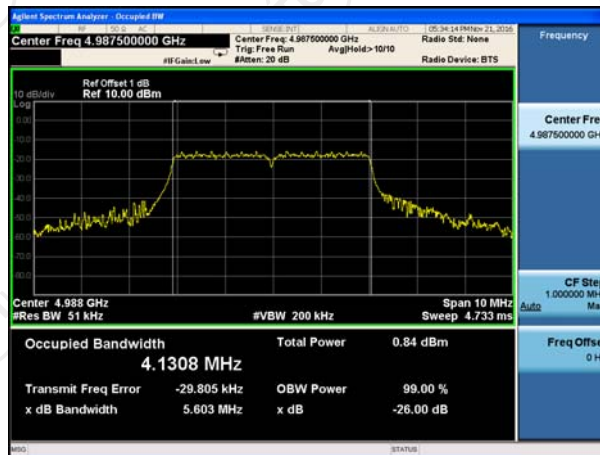

10MHz

Lowest channel

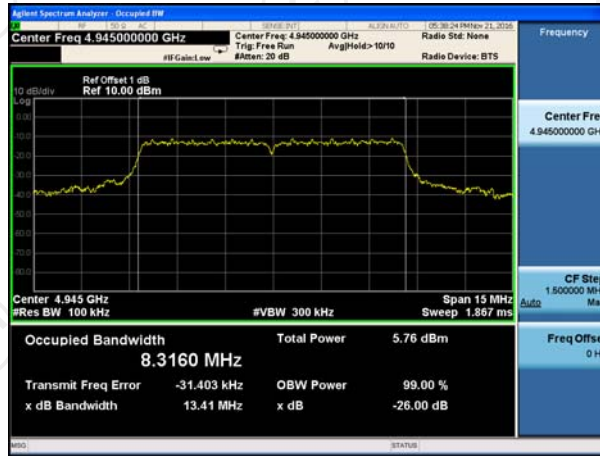

Middle channel



Highest channel

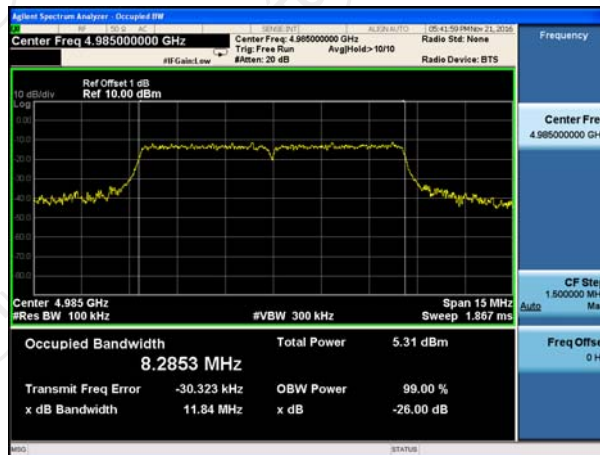

20MHz

Lowest channel

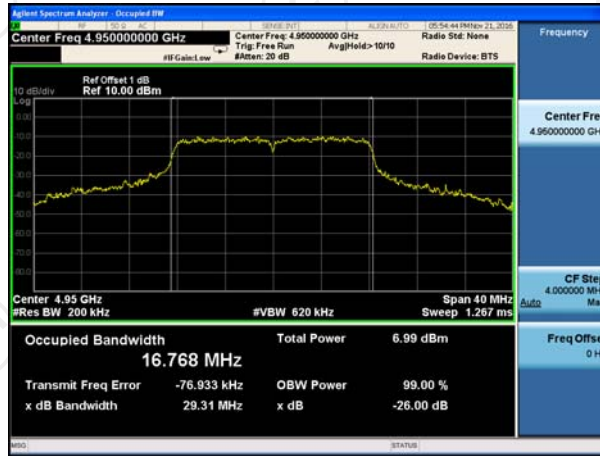

Middle channel

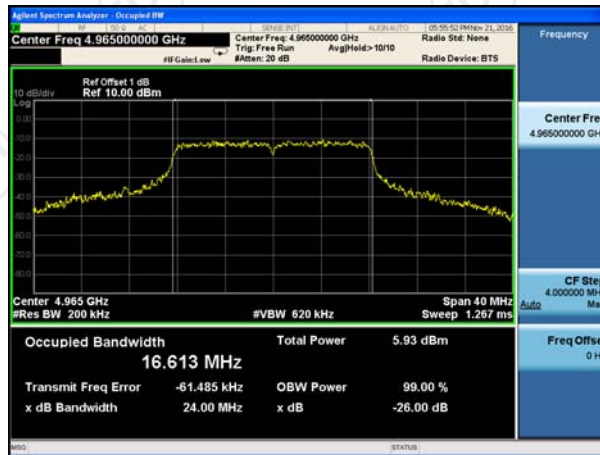

Highest channel

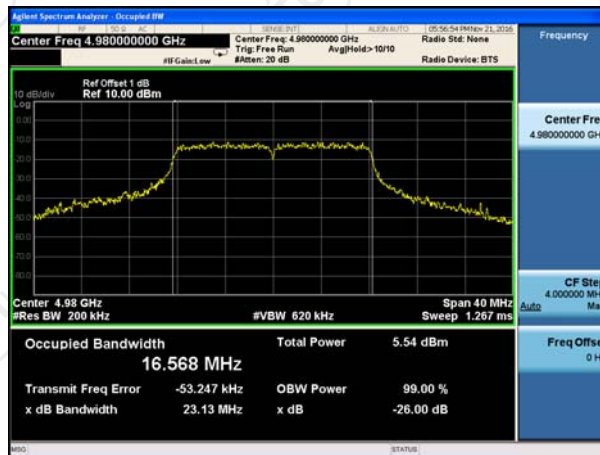

**Emission Mask Test Plots:
5MHz**

Lowest channel

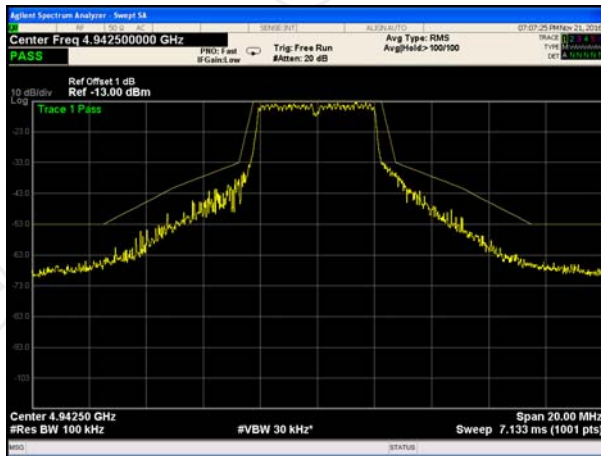

Middle channel

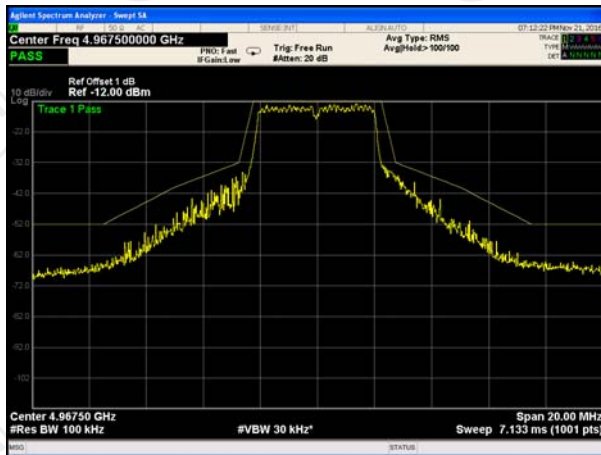

Highest channel

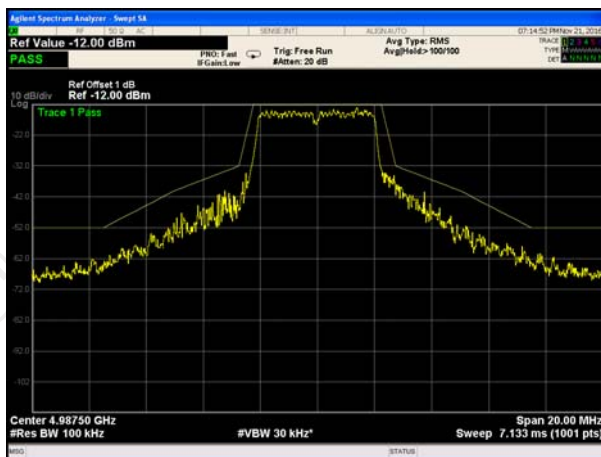

10MHz

Lowest channel

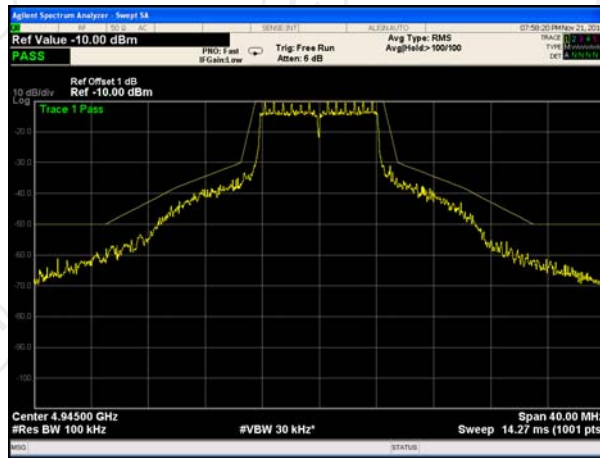

Middle channel

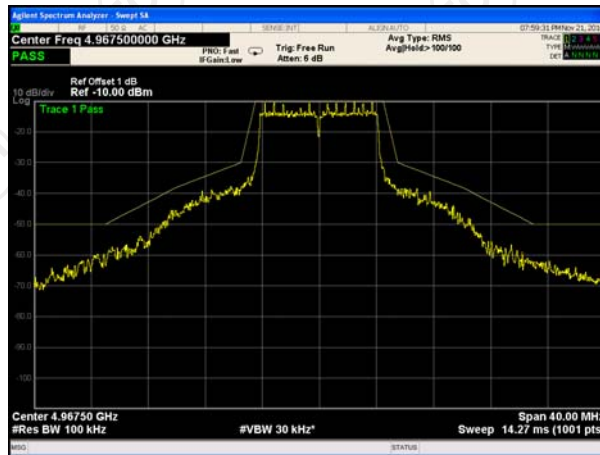

Highest channel



20MHz

Lowest channel

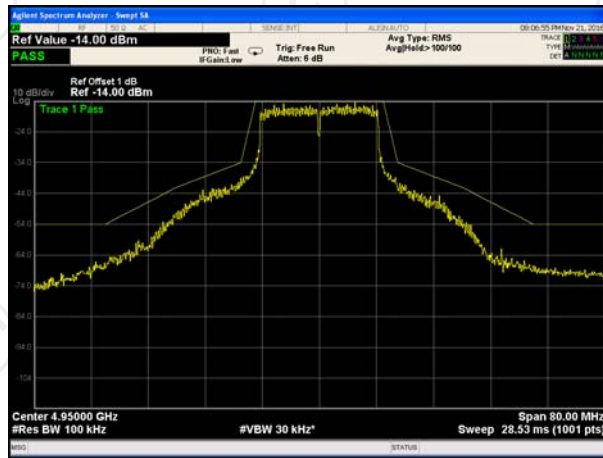

Middle channel

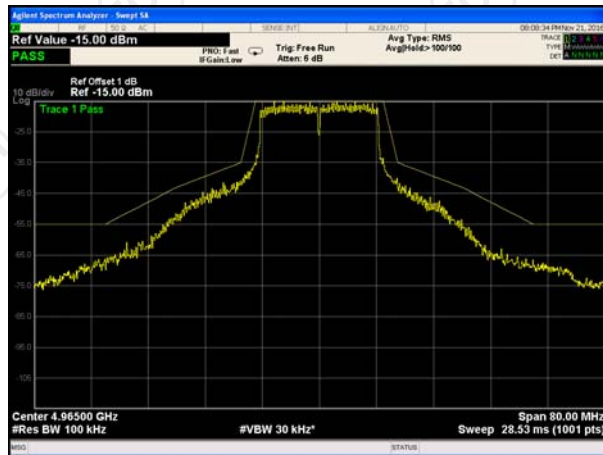

Highest channel



6.2. Output Power

6.2.1. Test Specification

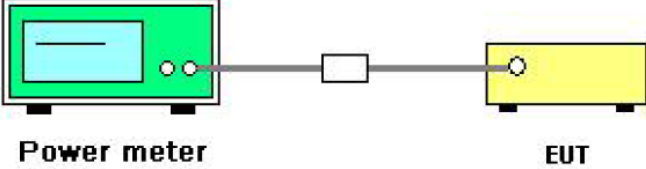
Test Requirement:	FCC CFR part §2.1046; CFR part §90.1215(a)																		
Test setup:	 <p>The diagram illustrates the test setup. On the left is a green 'Power meter'. It is connected via a grey cable to a white 'Attenuator'. This is further connected via another grey cable to a yellow 'EUT' (Equipment Under Test).</p>																		
Limit:	<p>Per FCC §90.1215, the transmitting power of stations operating in the 4940-4990 MHz band must not exceed the maximum limits in this section.</p> <p>The maximum conducted output power should not exceed:</p> <table border="1" data-bbox="611 902 1410 1151"> <thead> <tr> <th>Channel bandwidth (MHz)</th> <th>Low power maximum conducted output power (dBm)</th> <th>High power maximum conducted output power (dBm)</th> </tr> </thead> <tbody> <tr> <td>1</td> <td>7</td> <td>20</td> </tr> <tr> <td>5</td> <td>14</td> <td>27</td> </tr> <tr> <td>10</td> <td>17</td> <td>30</td> </tr> <tr> <td>15</td> <td>18.8</td> <td>31.8</td> </tr> <tr> <td>20</td> <td>20</td> <td>33</td> </tr> </tbody> </table> <p>However, high power point-to-point and point-to-multipoint operations (both fixed and temporary-fixed rapid deployment) may employ transmitting antennas with directional gain up to 26 dBi without any corresponding reduction in the maximum conducted output power or spectral density. Corresponding reduction in the maximum conducted output power and peak power spectral density should be the amount in decibels that the directional gain of the antenna exceeds 26 dBi.</p>	Channel bandwidth (MHz)	Low power maximum conducted output power (dBm)	High power maximum conducted output power (dBm)	1	7	20	5	14	27	10	17	30	15	18.8	31.8	20	20	33
Channel bandwidth (MHz)	Low power maximum conducted output power (dBm)	High power maximum conducted output power (dBm)																	
1	7	20																	
5	14	27																	
10	17	30																	
15	18.8	31.8																	
20	20	33																	
Test Mode:	Transmitting mode with modulation																		
Test Procedure:	<ol style="list-style-type: none"> 1. The RF output of EUT was connected to the power meter by RF cable and attenuator. The path loss was compensated to the results for each measurement. 2. Set to the maximum power setting and enable the EUT transmit continuously. 3. Measure the conducted output power and record the results in the test report. 																		
Test Result:	PASS																		

6.2.2. Test Instruments

RF Test Room				
Equipment	Manufacturer	Model	Serial Number	Calibration Due
Power Meter	Agilent	N1911A	MY45101557	Aug. 11, 2017
Power Sensor	Agilent	N1922A	MY44124432	Aug. 11, 2017
Antenna Connector	TCT	RFC-01	N/A	Aug. 12, 2017

Note: The calibration interval of the above test instruments is 12 months and the calibrations are traceable to international system unit (SI).

6.2.3. Test Data

Conducted Power for Radio-card+Amp				
Test Mode	Frequency	CH	Value(dBm)	Limit (dBm)
5MHz	4942.5	Low	13.25	14
	4967.5	Mid	13.35	
	4987.5	High	13.47	
10MHz	4945.0	Low	16.10	17
	4967.5	Mid	16.52	
	4985.0	High	16.24	
20MHz	4950.0	Low	19.24	20
	4965.0	Mid	19.41	
	4980.0	High	19.37	
Result	PASS			

Conducted Power for Radio-card				
Test Mode	Frequency	CH	Value(dBm)	Limit (dBm)
5MHz	4942.5	Low	1.88	14
	4967.5	Mid	1.96	
	4987.5	High	1.87	
10MHz	4945.0	Low	4.60	17
	4967.5	Mid	4.72	
	4985.0	High	4.84	
20MHz	4950.0	Low	7.54	20
	4965.0	Mid	7.61	
	4980.0	High	7.67	
Result	PASS			

6.3. Power Spectral Density

6.3.1. Test Specification

Test Requirement:	FCC CFR part §90.1215, CFR part §2.1046
Limit:	Low power devices are also limited to a peak power spectral density of 8 dBm per one MHz. Low power devices using channel bandwidths other than those listed above are permitted; however, they are limited to a peak power spectral density of 8 dBm/MHz. If transmitting antennas of directional gain greater than 9 dBi are used, both the maximum conducted output power and the peak power spectral density should be reduced by the amount in decibels that the directional gain of the antenna exceeds 9 dBi.
Test Mode:	Transmitting mode with modulation
Test Procedure:	The peak power spectral density is measured as conducted emission by direct connection of a calibrated test instrument to the equipment under test. Measurements are made over a bandwidth of one MHz or the 26 dB emission bandwidth of the device, whichever is less. A resolution bandwidth less than the measurement bandwidth can be used, provided that the measured power is integrated to show total power over the measurement bandwidth.
Test Result:	PASS

6.3.2. Test Instruments

RF Test Room				
Equipment	Manufacturer	Model	Serial Number	Calibration Due
Spectrum Analyzer	Agilent	N9020A	MY49100060	Aug. 12, 2017
RF cable	TCT	RE-06	N/A	Aug. 12, 2017
Antenna Connector	TCT	RFC-01	N/A	Aug. 12, 2017

Note: The calibration interval of the above test instruments is 12 months and the calibrations are traceable to international system unit (SI)

6.3.3. Test Data

Power Spectral Density for Radio-card+Amp				
Test Mode	Frequency	CH	Value (dBm/MHz)	Limit (dBm/MHz)
5MHz	4942.5	Low	7.67	8
	4967.5	Mid	7.46	
	4987.5	High	7.40	
10MHz	4945.0	Low	7.73	
	4967.5	Mid	6.60	
	4985.0	High	7.03	
20MHz	4950.0	Low	7.38	
	4965.0	Mid	7.80	
	4980.0	High	7.72	
Result	PASS			

Test Plots:
5MHz

Lowest channel

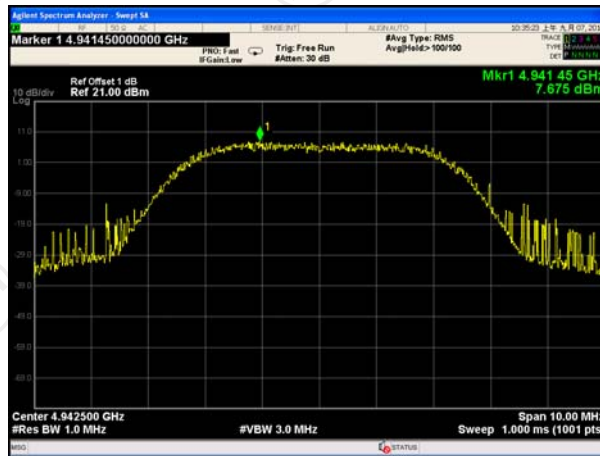

Middle channel

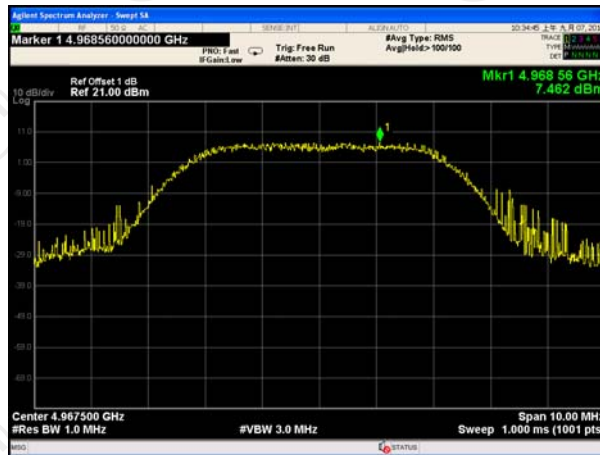

Highest channel



10MHz

Lowest channel

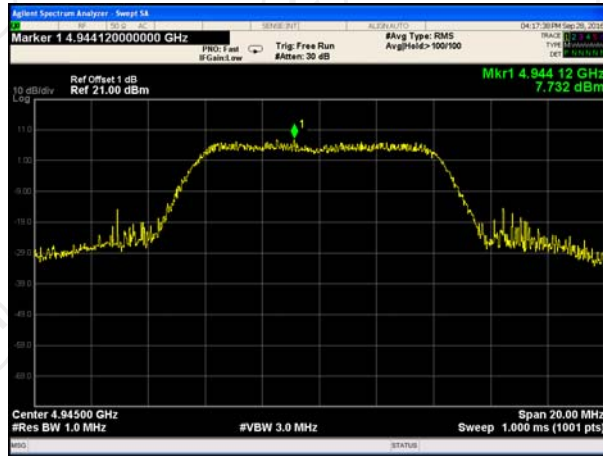

Middle channel

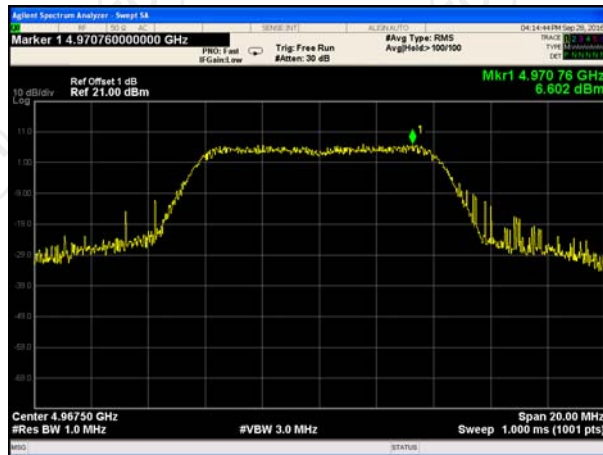

Highest channel

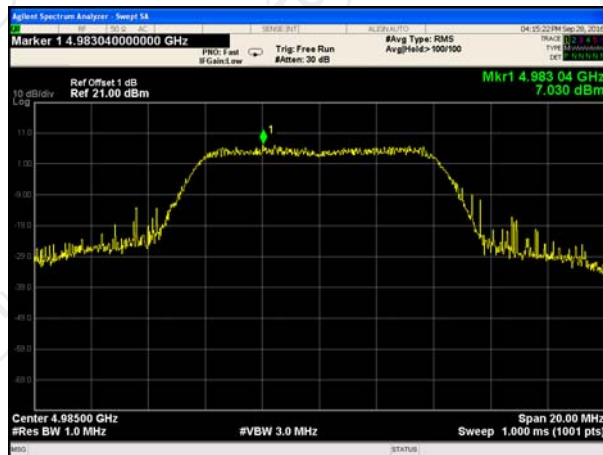

20MHz

Lowest channel

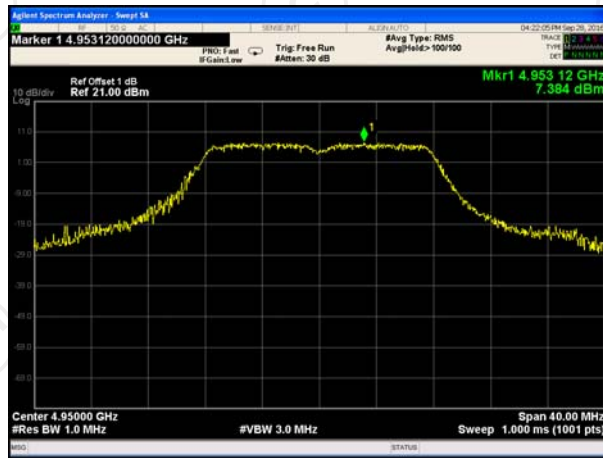

Middle channel



Highest channel

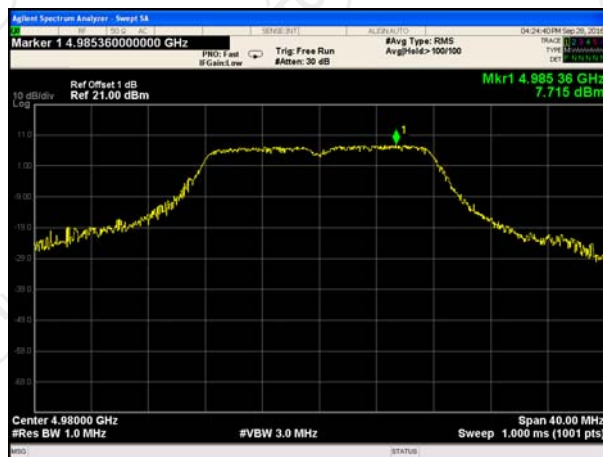

Power Spectral Density for Radio-card				
Test Mode	Frequency	CH	Value (dBm/MHz)	Limit (dBm/MHz)
5MHz	4942.5	Low	-0.14	8
	4967.5	Mid	0.34	
	4987.5	High	-1.03	
10MHz	4945.0	Low	1.27	
	4967.5	Mid	1.64	
	4985.0	High	1.43	
20MHz	4950.0	Low	-3.36	
	4965.0	Mid	-3.21	
	4980.0	High	-3.67	
Result	PASS			

**Test Plots:
5MHz**

Lowest channel

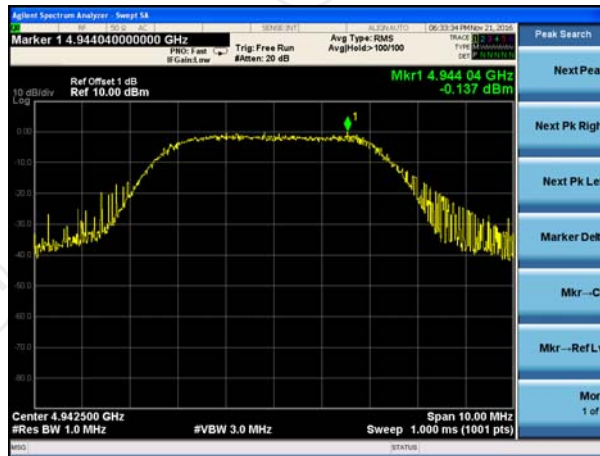

Middle channel

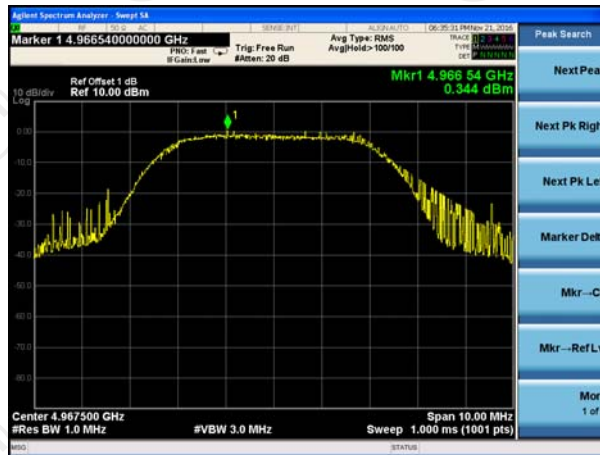

Highest channel

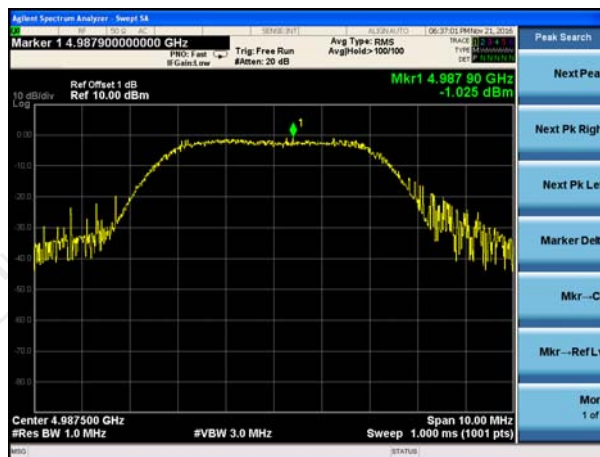

10MHz

Lowest channel



Middle channel



Highest channel



20MHz

Lowest channel



Middle channel



Highest channel

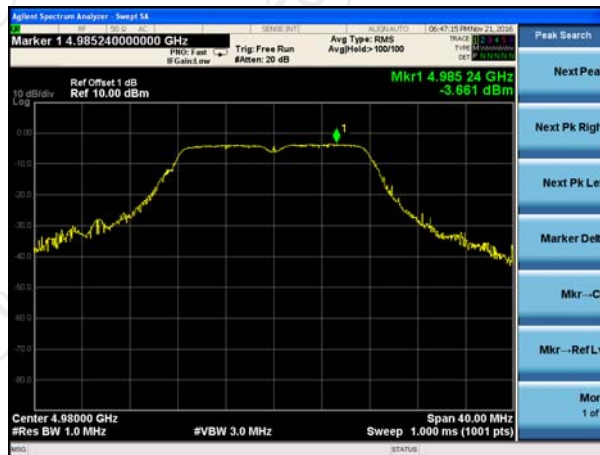

6.4. Conducted Spurious Emission Measurement

6.4.1. Test Specification

Test Requirement:	FCC CFR part §90.210, CFR part§2.1051																							
Limit:	<p>For low power transmitters (20 dBm or less) and high power transmitters (greater than 20 dBm operating in the 4940-4990 MHz frequency band, the power spectral density of the emissions must be attenuated below the output power of the transmitter as follows:</p> <table border="1"> <thead> <tr> <th rowspan="2">Frequency Offset f_d</th> <th colspan="2">Minimum Attenuation</th> </tr> <tr> <th>Low Power Transmitter</th> <th>High Power Transmitter</th> </tr> </thead> <tbody> <tr> <td>$0 < f_d \leq 45$</td> <td>0</td> <td>0</td> </tr> <tr> <td>$45 < f_d \leq 50$</td> <td>$219 \log(f_d/45)$</td> <td>$568 \log(f_d/45)$</td> </tr> <tr> <td>$50 < f_d \leq 55$</td> <td>$10 + 242 \log(f_d/50)$</td> <td>$26 + 145 \log(f_d/50)$</td> </tr> <tr> <td>$55 < f_d \leq 100$</td> <td>$20 + 31 \log(f_d/55)$</td> <td>$32 + 31 \log(f_d/55)$</td> </tr> <tr> <td>$100 < f_d \leq 150$</td> <td>$28 + 68 \log(f_d/100)$</td> <td>$40 + 57 \log(f_d/100)$</td> </tr> <tr> <td>$f_d > 150$</td> <td>40</td> <td>50 dB or $55 + 10 \log(P)$ dB, whichever is the lesser attenuation.</td> </tr> </tbody> </table> <p>f_d is the percentage of the equipment's channel bandwidth.</p>	Frequency Offset f_d	Minimum Attenuation		Low Power Transmitter	High Power Transmitter	$0 < f_d \leq 45$	0	0	$45 < f_d \leq 50$	$219 \log(f_d/45)$	$568 \log(f_d/45)$	$50 < f_d \leq 55$	$10 + 242 \log(f_d/50)$	$26 + 145 \log(f_d/50)$	$55 < f_d \leq 100$	$20 + 31 \log(f_d/55)$	$32 + 31 \log(f_d/55)$	$100 < f_d \leq 150$	$28 + 68 \log(f_d/100)$	$40 + 57 \log(f_d/100)$	$f_d > 150$	40	50 dB or $55 + 10 \log(P)$ dB, whichever is the lesser attenuation.
Frequency Offset f_d	Minimum Attenuation																							
	Low Power Transmitter	High Power Transmitter																						
$0 < f_d \leq 45$	0	0																						
$45 < f_d \leq 50$	$219 \log(f_d/45)$	$568 \log(f_d/45)$																						
$50 < f_d \leq 55$	$10 + 242 \log(f_d/50)$	$26 + 145 \log(f_d/50)$																						
$55 < f_d \leq 100$	$20 + 31 \log(f_d/55)$	$32 + 31 \log(f_d/55)$																						
$100 < f_d \leq 150$	$28 + 68 \log(f_d/100)$	$40 + 57 \log(f_d/100)$																						
$f_d > 150$	40	50 dB or $55 + 10 \log(P)$ dB, whichever is the lesser attenuation.																						
Test Mode:	Transmitting mode with modulation																							
Test Procedure:	<ol style="list-style-type: none"> The EUT was set to transmit in a modulated transmit mode. The RF output of the EUT was connected to a spectrum analyzer using appropriate attenuations. Conducted spurious emissions were measured up to 40GHz. Sufficient scans were taken to shown any out of band emissions. 																							
Test Result:	PASS																							

6.4.2. Test Instruments

RF Test Room				
Equipment	Manufacturer	Model	Serial Number	Calibration Due
Spectrum Analyzer	Agilent	N9020A	MY49100060	Aug. 12, 2017
RF cable	TCT	RE-06	N/A	Aug. 12, 2017
Antenna Connector	TCT	RFC-01	N/A	Aug. 12, 2017

Note: The calibration interval of the above test instruments is 12 months and the calibrations are traceable to international system unit (SI).

**Test Plots for Radio-card+Amp as Following Page:
5MHz**

Lowest channel

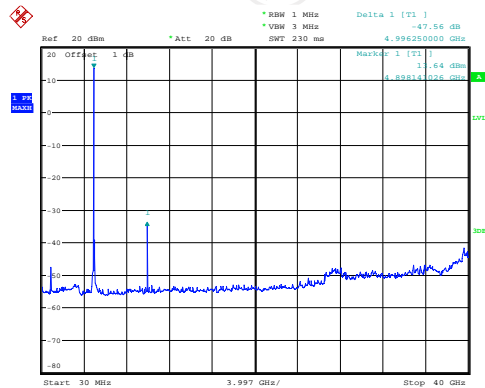

Middle channel

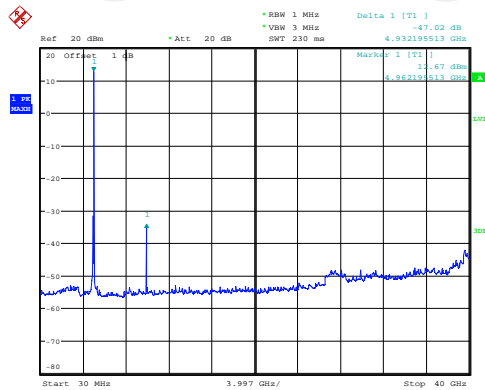

Highest channel

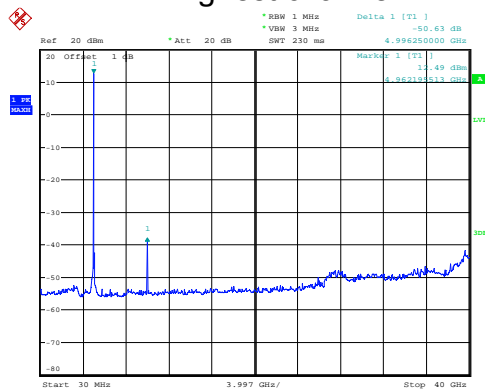

10MHz

Lowest channel

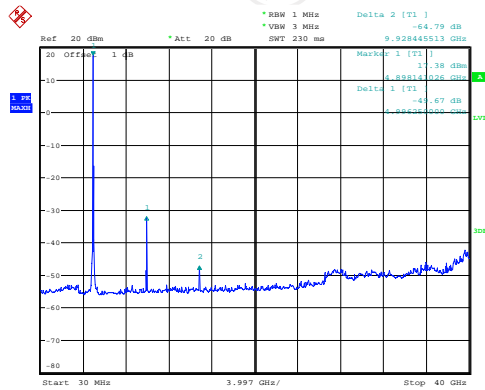

Date: 28.SEP.2016 19:41:00

Middle channel

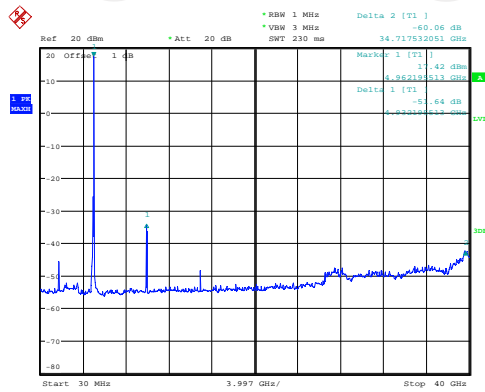

Date: 28.SEP.2016 19:42:47

Highest channel

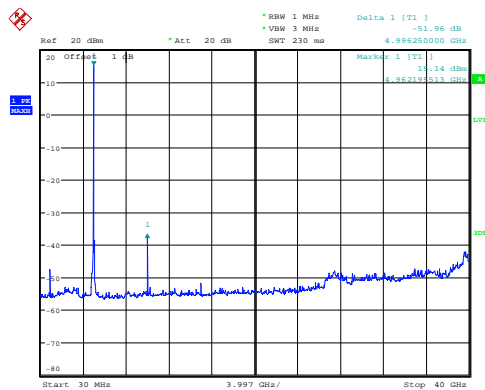

Date: 28.SEP.2016 19:43:29

20MHz

Lowest channel

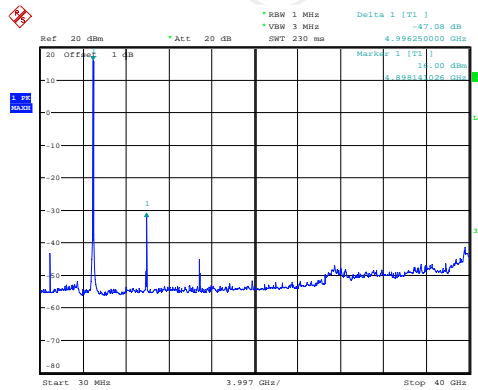

Date: 28.SEP.2016 19:44:45

Middle channel

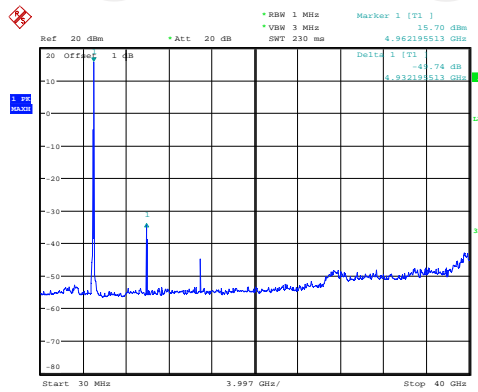

Date: 28.SEP.2016 19:45:17

Highest channel

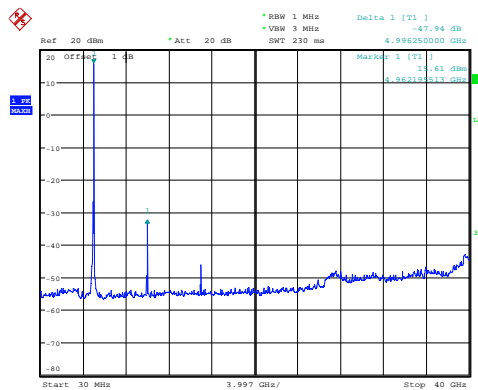

Date: 28.SEP.2016 19:46:04

Test Plots for Radio-card as Following Page:
5MHz

Lowest channel

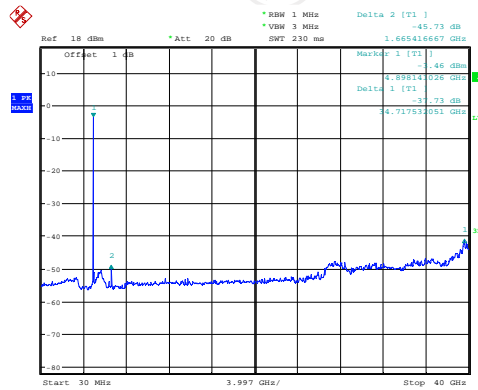

Date: 21.NOV.2016 16:18:48

Middle channel

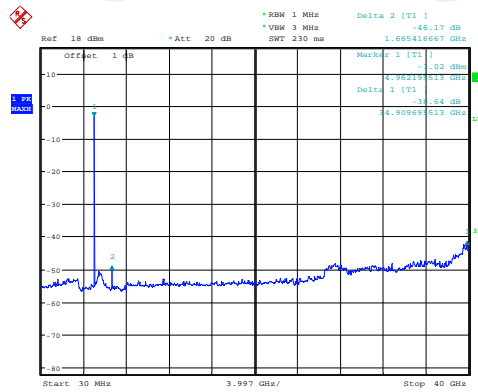

Date: 21.NOV.2016 16:25:54

Highest channel

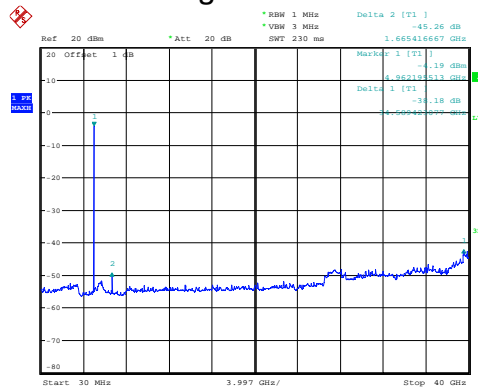

Date: 21.NOV.2016 16:35:32

10MHz

Lowest channel

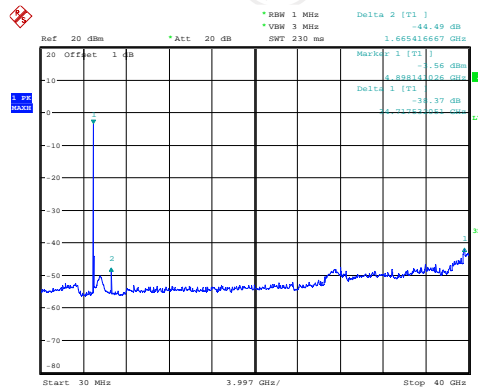

Date: 21.NOV.2016 16:37:52

Middle channel

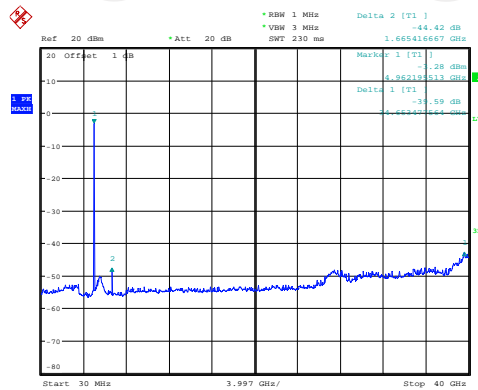

Date: 21.NOV.2016 16:40:05

Highest channel

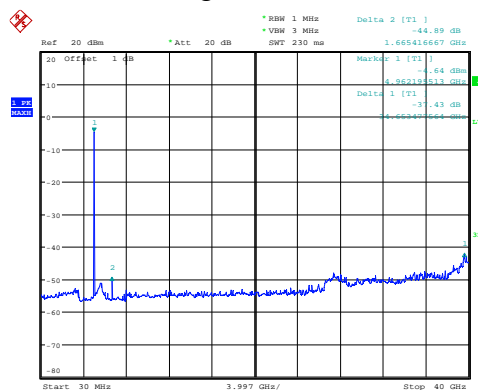

Date: 21.NOV.2016 16:41:07

20MHz

Lowest channel

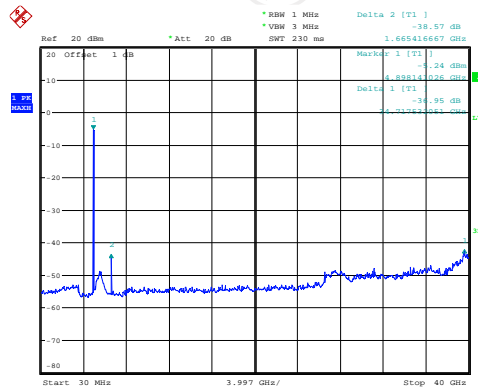

Date: 21.NOV.2016 16:47:49

Middle channel

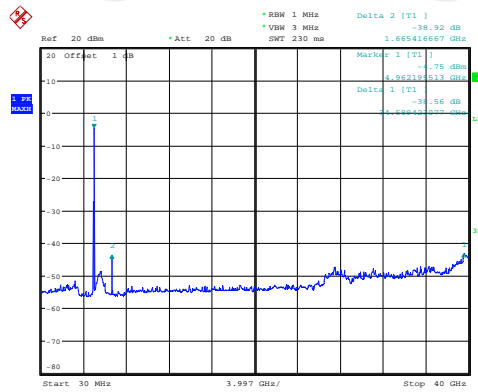

Date: 21.NOV.2016 16:45:03

Highest channel

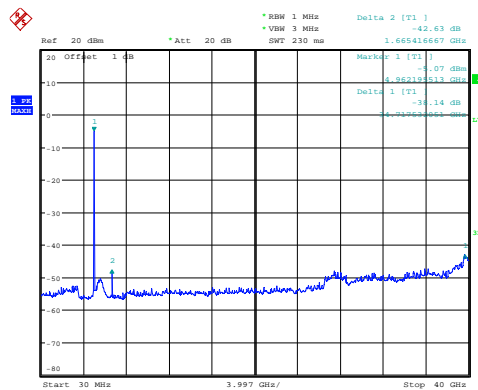

Date: 21.NOV.2016 16:46:11

6.5. Radiated Spurious Emission Measurement

6.5.1. Test Specification

Test Requirement:	FCC CFR part §90.210, CFR part§2.1053		
Frequency Range:	30MHz to 40 GHz		
Measurement Distance:	3 m		
Antenna Polarization:	Horizontal & Vertical		
Operation mode:	Transmitting mode with modulation		
Receiver Setup:	Frequency	RBW	
	30MHz-1GHz	100KHz	
	Above 1GHz	1MHz	
Limit:	For low power transmitters (20 dBm or less) and high power transmitters (greater than 20 dBm operating in the 4940-4990 MHz frequency band, the power spectral density of the emissions must be attenuated below the output power of the transmitter as follows:		
	Frequency Offset f_d	Minimum Attenuation	
		Low Power Transmitter	High Power Transmitter
	$0 < f_d \leq 45$	0	0
	$45 < f_d \leq 50$	$219 \log(f_d/45)$	$568 \log(f_d/45)$
	$50 < f_d \leq 55$	$10 + 242 \log(f_d/50)$	$26 + 145 \log(f_d/50)$
	$55 < f_d \leq 100$	$20 + 31 \log(f_d/55)$	$32 + 31 \log(f_d/55)$
$100 < f_d \leq 150$	$28 + 68 \log(f_d/100)$	$40 + 57 \log(f_d/100)$	
$f_d > 150$	40	50 dB or $55 + 10 \log(P)$ dB, whichever is the lesser attenuation.	
f_d is the percentage of the equipment's channel bandwidth.			
Test Procedure:	Radiated emission measurements were performed inside a semi-anechoic chamber. The EUT was set at a distance of 3m from the receiving antenna. The EUT's RF ports were terminated to 50ohm load. The EUT was set to transmit at the low, mid and high channels of the transmitter frequency range at its maximum power level. The EUT was rotated about 3600 and the receiving antenna scanned from 1-4m in order to capture the maximum emission. A calibrated antenna source was positioned in place of the EUT and the previously recorded signal was duplicated. The maximum EIRP of the emission was calculated by adding the forward power to the calibrated source plus its appropriate gain value. These steps were carried out with the receiving antenna in both vertical and horizontal polarization. Harmonic emissions up to the 10th or 40GHz, whichever is the lesser, were investigated. Plots were corrected for antenna and cable loss. No peaks were found above 18 GHz. Measurements were made above 18 GHz but only noise floor was		

	recorded.
Test results:	PASS

6.5.2. Test Instruments

Radiated Emission Test Site (966)				
Name of Equipment	Manufacturer	Model	Serial Number	Calibration Due
ESPI Test Receiver	ROHDE&SCHW ARZ	ESVD	100008	Aug. 11, 2017
Spectrum Analyzer	ROHDE&SCHW ARZ	FSEM	848597/001	Aug. 11, 2017
Spectrum Analyzer	Agilent	N9020A	MY49100060	Aug. 12, 2017
Pre-amplifier	EM Electronics Corporation CO.,LTD	EM30265	07032613	Aug. 11, 2017
Pre-amplifier	HP	8447D	2727A05017	Aug. 11, 2017
Loop antenna	ZHINAN	ZN30900A	12024	Aug. 13, 2017
Broadband Antenna	Schwarzbeck	VULB9163	340	Aug. 13, 2017
Horn Antenna	Schwarzbeck	BBHA 9120D	631	Aug. 13, 2017
Horn Antenna	Schwarzbeck	BBHA 9170	373	Aug. 13, 2017
Coax cable	TCT	RE-low-01	N/A	Aug. 11, 2017
Coax cable	TCT	RE-high-02	N/A	Aug. 11, 2017
Coax cable	TCT	RE-low-03	N/A	Aug. 11, 2017
Coax cable	TCT	RE-High-04	N/A	Aug. 11, 2017
Antenna Mast	CCS	CC-A-4M	N/A	Aug. 12, 2017
EMI Test Software	Shurple Technology	EZ-EMC	N/A	N/A

Note: The calibration interval of the above test instruments is 12 months and the calibrations are traceable to international system unit (SI).

6.5.3. Test Data

5MHz				
Low Channel				
Frequency (MHz)	Ant. Pol. H/V	Peak reading (dBm)	Limit (dBm)	Margin (dB)
64.27		-62.34	-26	-36.34
5842	H	-50.74	-26	-24.74
9885	H	-41.46	-26	-15.46
---	H	---	---	---
64.27	V	-61.25	-26	-35.25
5842		-49.78	-26	-23.78
9885	V	-41.58	-26	-15.58
---	V	---	---	---

5MHz				
Middle Channel				
Frequency (MHz)	Ant. Pol. H/V	Peak reading (dBm)	Limit (dBm)	Margin (dB)
64.27	H	-61.42	-26	-35.42
5864	H	-50.56	-26	-24.56
9935	H	-50.95	-26	-24.95
---	H	---	---	---
64.27	V	-61.25	-26	-35.25
5864	V	-50.42	-26	-24.42
9935	V	-50.79	-26	-24.79
---	V	---	---	---

5MHz				
High Channel				
Frequency (MHz)	Ant. Pol. H/V	Peak reading (dBm)	Limit (dBm)	Margin (dB)
64.18	H	-64.82	-26	-38.82
5854	H	-50.75	-26	-24.75
9975	H	-49.72	-26	-23.72
---	H	---	---	---
64.18	V	-65.45	-26	-39.45
5854	V	-51.17	-26	-25.17
9975	V	-50.60	-26	-24.6
---	V	---	---	---

Note: The two test modes of radio-card and radio-card+Amp are all performed test, but only show the worst case in this report, and the worst case is radio-card+Amp.

10MHz				
Low Channel				
Frequency (MHz)	Ant. Pol. H/V	Peak reading (dBm)	Limit (dBm)	Margin (dB)
65.35		-62.42	-23	-39.42
5824	H	-50.11	-23	-27.11
9900	H	-50.48	-23	-27.48
---	H	---	---	---
65.35	V	-61.15	-23	-38.15
5824		-48.32	-23	-25.32
9900	V	-50.55	-23	-27.55
---	V	---	---	---

10MHz				
Middle Channel				
Frequency (MHz)	Ant. Pol. H/V	Peak reading (dBm)	Limit (dBm)	Margin (dB)
65.15	H	-61.44	-23	-38.44
5881	H	-49.12	-23	-26.12
9935	H	-50.00	-23	-27
---	H	---	---	---
65.15	V	-61.48	-23	-38.48
5881	V	-48.29	-23	-25.29
9935	V	-50.41	-23	-27.41
---	V	---	---	---

10MHz				
High Channel				
Frequency (MHz)	Ant. Pol. H/V	Peak reading (dBm)	Limit (dBm)	Margin (dB)
65.17	H	-64.51	-23	-41.51
5874	H	-48.94	-23	-25.94
9970	H	-50.01	-23	-27.01
---	H	---	---	---
65.17	V	-64.51	-23	-41.51
5871	V	-47.75	-23	-24.75
9970	V	-50.27	-23	-27.27
---	V	---	---	---

Note: The two test modes of radio-card and radio-card+Amp are all performed test, but only show the worst case in this report, and the worst case is radio-card+Amp.

20MHz				
Low Channel				
Frequency (MHz)	Ant. Pol. H/V	Peak reading (dBm)	Limit (dBm)	Margin (dB)
65.36		-61.27	-20	-41.27
5867	H	-49.82	-20	-29.82
9890	H	-50.47	-20	-30.47
---	H	---	---	---
65.36	V	-61.24	-20	-41.24
5867		-48.34	-20	-28.34
9890	V	-50.11	-20	-30.11
---	V	---	---	---

20MHz				
Middle Channel				
Frequency (MHz)	Ant. Pol. H/V	Peak reading (dBm)	Limit (dBm)	Margin (dB)
65.57	H	-61.71	-20	-41.71
5828	H	-48.26	-20	-28.26
9930	H	-50.30	-20	-30.3
---	H	---	---	---
65.57	V	-61.52	-20	-41.52
5828	V	-48.39	-20	-28.39
9930	V	-49.86	-20	-29.86
---	V	---	---	---

20MHz				
High Channel				
Frequency (MHz)	Ant. Pol. H/V	Peak reading (dBm)	Limit (dBm)	Margin (dB)
65.18	H	-64.48	-20	-44.48
5834	H	-49.34	-20	-29.34
9960	H	-50.71	-20	-30.71
---	H	---	---	---
65.18	V	-64.41	-20	-44.41
5834	V	-48.18	-20	-28.18
9960	V	-50.35	-20	-30.35
---	V	---	---	---

Note: The two test modes of radio-card and radio-card+Amp are all performed test, but only show the worst case in this report, and the worst case is radio-card+Amp.

6.6. Frequency Stability Measurement

6.6.1. Test Specification

Test Requirement:	FCC Part 2.1055(a)(1)(b) ; Part90 Y Section 90.213
Test Method:	FCC Part 2.1055(a)(1)(b)
Operation mode:	Refer to item 4.1
Test Procedure:	The EUT was placed in the Environmental Chamber and support equipment were outside the chamber on a table. The EUT was set to transmit a CW signal corresponding to the low, mid and high Channels for 5, 10, & 20MHz Bandwidths. The frequency counter option on the Spectrum Analyzer was used to measure frequency deviations. The frequency drift was investigated for every 10C increment until the unit is stabilized then recorded the reading in tabular format with the temperature range of -30 to 50C.
Test Result:	PASS

6.6.2. Test Instruments

Equipment	Manufacturer	Model	Serial Number	Calibration Due
Spectrum Analyzer	Agilent	N9020A	MY49100060	Aug. 12, 2017
Thermal Chamber	JQ	JQ-2000	N/A	Aug. 11, 2017
RF cable	TCT	RE-06	N/A	Aug. 12, 2017
Antenna Connector	TCT	RFC-01	N/A	Aug. 12, 2017

Note: The calibration interval of the above test instruments is 12 months and the calibrations are traceable to international system unit (SI).

6.6.3. Test Data

Test Result of Temperature Variation

Bandwidth :	5MHz	Channel:	Middle
Radio-card+Amp		Frequency:	4967.5MHz
Temperature (°C)	Frequency Deviation (Hz)	Frequency Deviation (ppm)	Result
50	15	0.003	PASS
40	27	0.005	
30	10	0.002	
20	28	0.006	
10	31	0.006	
0	33	0.007	
-10	30	0.006	
-20	34	0.007	
-30	30	0.006	

Bandwidth :	10MHz	Channel:	Middle
Radio-card+Amp		Frequency:	4967.5MHz
Temperature (°C)	Frequency Deviation (Hz)	Frequency Deviation (ppm)	Result
50	13	0.003	PASS
40	24	0.005	
30	17	0.003	
20	25	0.005	
10	31	0.006	
0	38	0.008	
-10	31	0.006	
-20	32	0.006	
-30	31	0.006	

Bandwidth :	20MHz	Channel:	Middle
Radio-card+Amp		Frequency:	4965.0MHz
Temperature (°C)	Frequency Deviation (Hz)	Frequency Deviation (ppm)	Result
50	12	0.002	PASS
40	14	0.003	
30	12	0.002	
20	16	0.003	
10	32	0.006	
0	15	0.003	
-10	24	0.005	
-20	15	0.003	
-30	34	0.007	

Bandwidth :	5MHz	Channel:	Middle
Radio-card		Frequency:	4967.5MHz
Temperature (°C)	Frequency Deviation (Hz)	Frequency Deviation (ppm)	Result
50	11	0.002	PASS
40	24	0.005	
30	15	0.003	
20	24	0.005	
10	25	0.005	
0	18	0.004	
-10	22	0.004	
-20	24	0.005	
-30	16	0.003	

Bandwidth :	10MHz	Channel:	Middle
Radio-card		Frequency:	4967.5MHz
Temperature (°C)	Frequency Deviation (Hz)	Frequency Deviation (ppm)	Result
50	12	0.002	PASS
40	24	0.005	
30	18	0.004	
20	15	0.003	
10	14	0.003	
0	16	0.003	
-10	17	0.003	
-20	22	0.004	
-30	18	0.004	

Bandwidth :	20MHz	Channel:	Middle
Radio-card		Frequency:	4965.0MHz
Temperature (°C)	Frequency Deviation (Hz)	Frequency Deviation (ppm)	Result
50	14	0.003	PASS
40	15	0.003	
30	15	0.003	
20	11	0.002	
10	17	0.003	
0	12	0.002	
-10	13	0.003	
-20	28	0.006	
-30	24	0.005	

Test Result of Voltage Variation

Channel	Voltage (Volt)	Deviation (ppm)	Result
4967.5	N/A	/	PASS
	3.3	0.025	
	3.2	0.020	
4965.0	N/A	/	
	3.3	0.022	
	3.2	0.018	
Radio-card+Amp			

Channel	Voltage (Volt)	Deviation (ppm)	Result
4967.5	N/A	/	PASS
	3.3	0.024	
	3.2	0.025	
4965.0	N/A	/	
	3.3	0.027	
	3.2	0.014	
Radio-card			

Appendix B: Photographs of Test Setup

Radiated Emission



Appendix C: Photographs of EUT

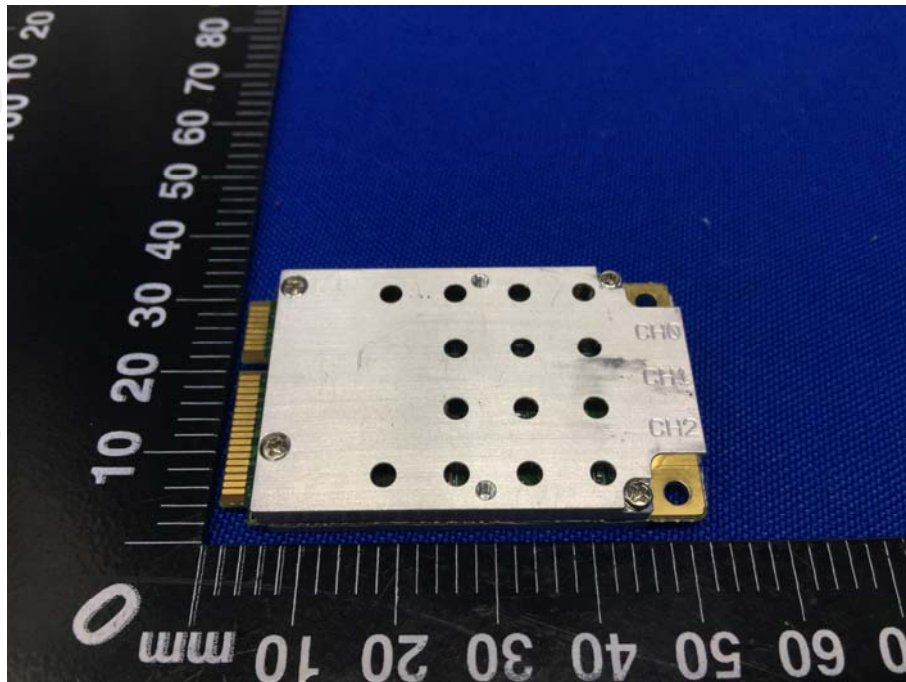



Amplifier

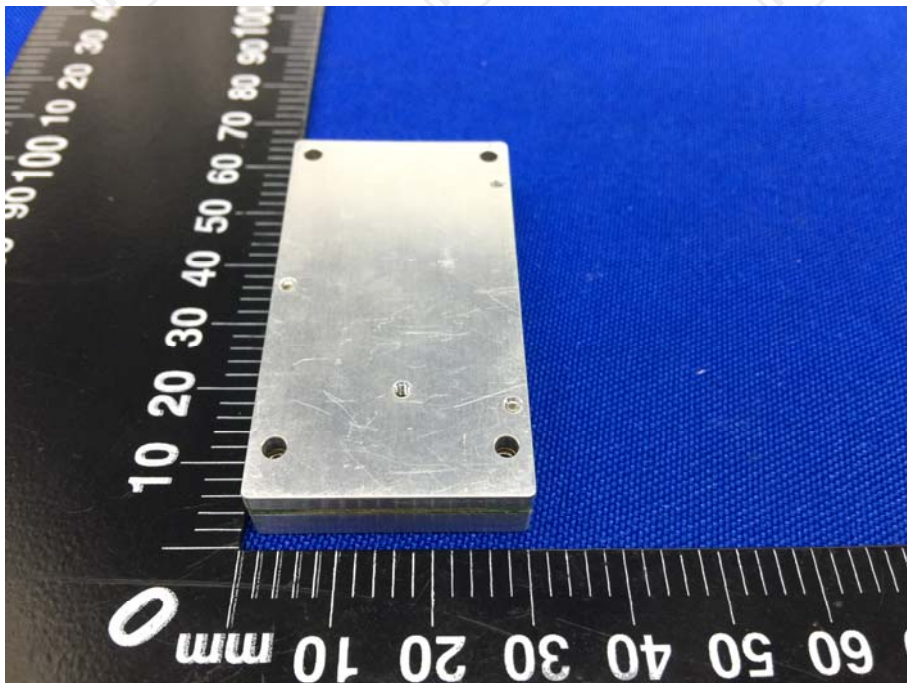
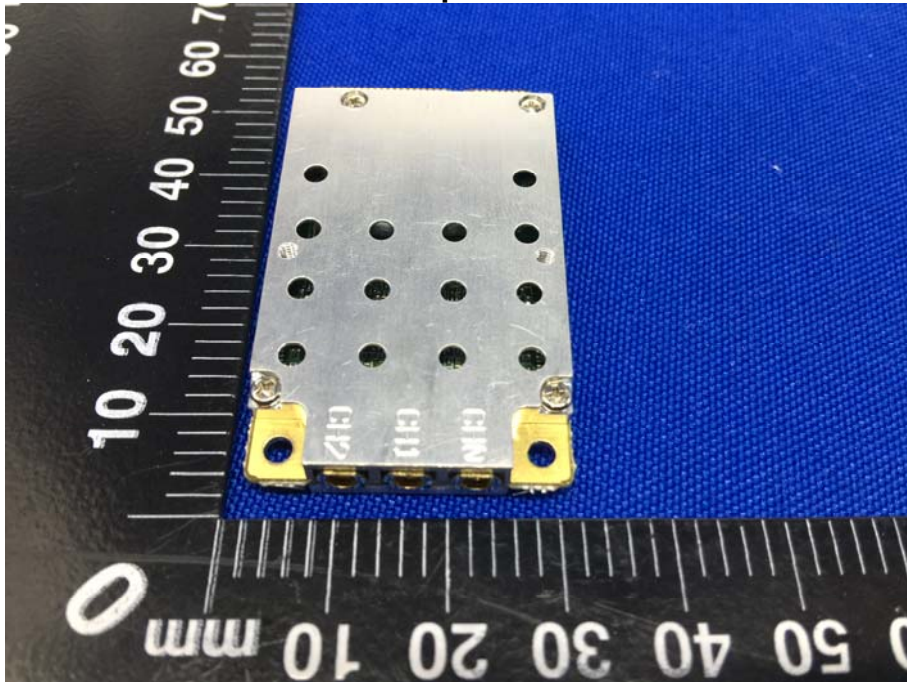

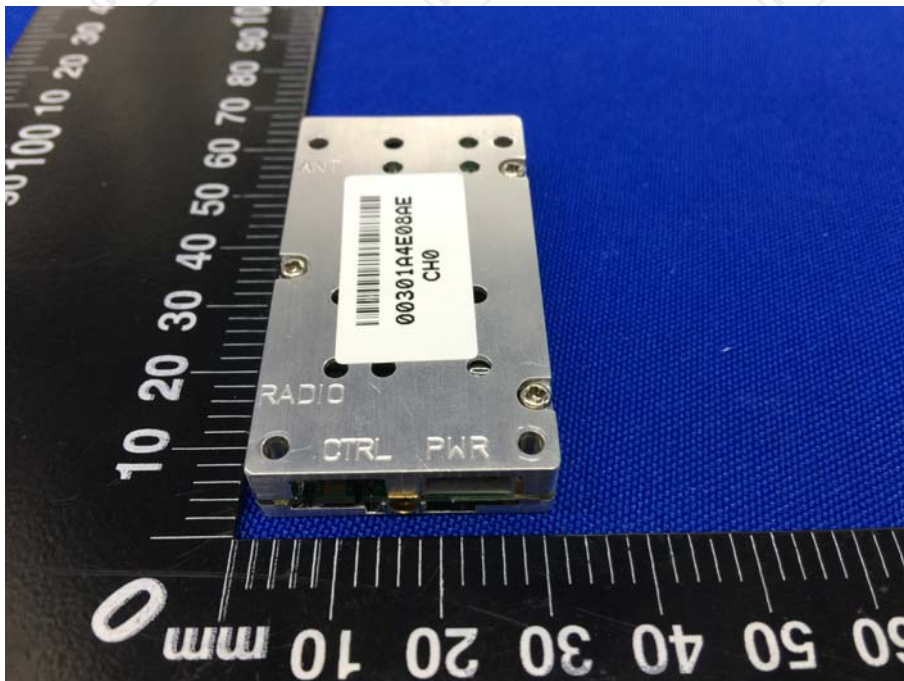
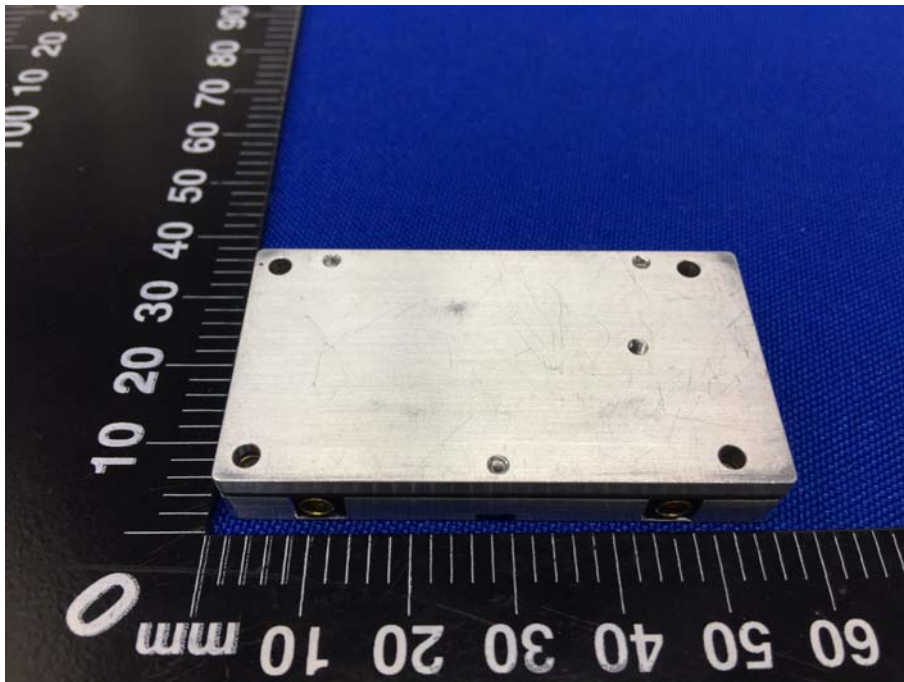

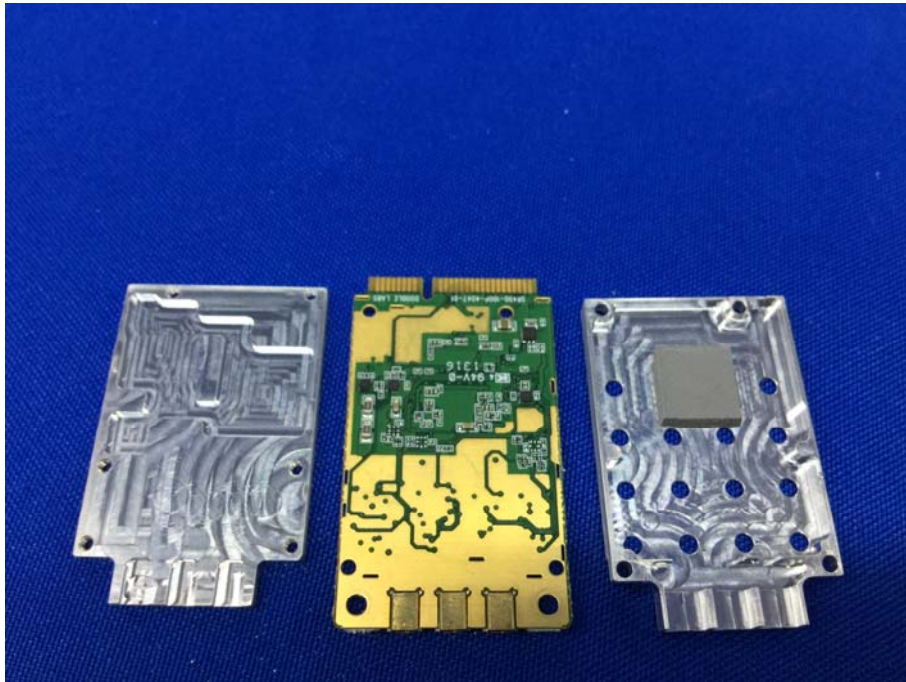

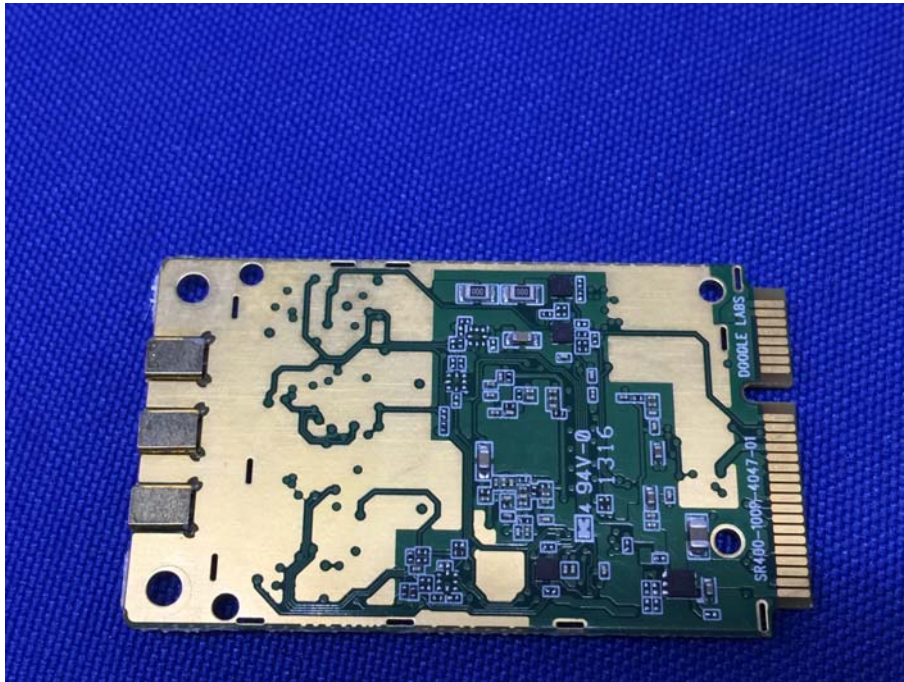

Amplifier

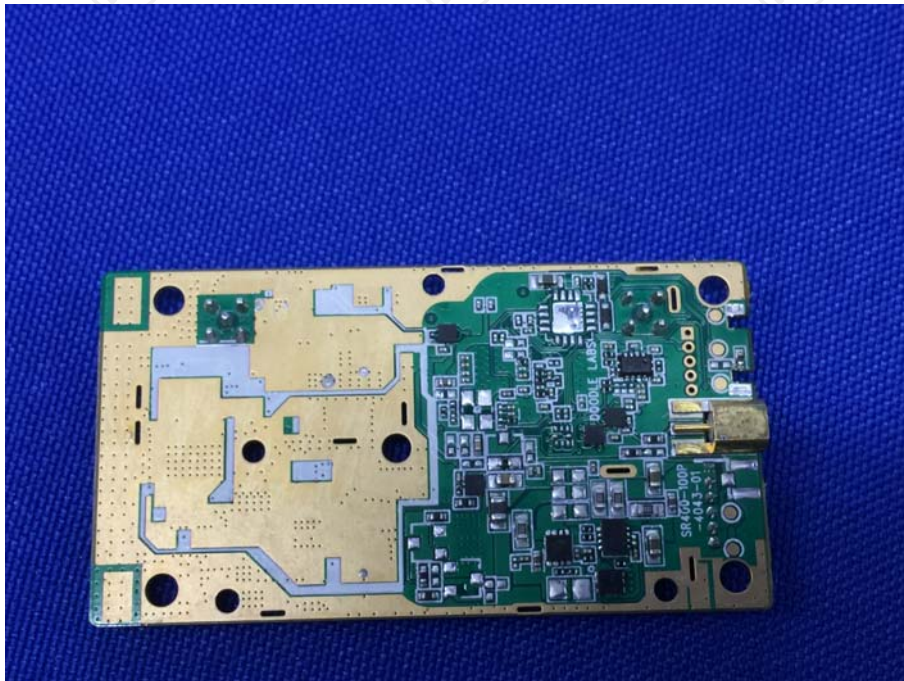



*******END OF REPORT*******