

# TEST REPORT

IC: 21411-NM24502F  
FCC ID: 2AG87NM-2450-2F  
Product: Wi-Fi® Radio Transceiver  
Model No.: NM-2450-2F

Additional Model No.: NL-2450-2F, NM-2450-1F, NL-2450-1F

Trade Mark: N/A  
Report No.: TCT160601E020  
Issued Date: Aug. 26, 2016

Issued for:

Doodle Labs (SG) Pte Ltd  
150 Kampong Ampat, KA Centre, Suite #05-03, Singapore 368324

Issued By:

Shenzhen Tongce Testing Lab.  
1F, Leinuo Watch Building, Fuyong Town, Baoan Dist, Shenzhen, China  
TEL: +86-755-27673339  
FAX: +86-755-27673332

**Note:** This report shall not be reproduced except in full, without the written approval of Shenzhen Tongce Testing Lab.  
This document may be altered or revised by Shenzhen Tongce Testing Lab. personnel only, and shall be noted in the revision section of the document. The test results in the report only apply to the tested sample.

**TABLE OF CONTENTS**

<b>1. Test Certification.....</b>	<b>3</b>
<b>2. Test Result Summary.....</b>	<b>4</b>
<b>3. EUT Description.....</b>	<b>5</b>
<b>4. Genera Information.....</b>	<b>8</b>
4.1. Test environment and mode .....	8
4.2. Description of Support Units .....	9
<b>5. Facilities and Accreditations .....</b>	<b>10</b>
5.1. Facilities .....	10
5.2. Location .....	10
5.3. Measurement Uncertainty .....	10
<b>6. Test Results and Measurement Data .....</b>	<b>11</b>
6.1. Antenna requirement .....	11
6.2. Conducted Emission.....	12
6.3. Maximum Conducted (Peak) Output Power .....	16
6.4. Emission Bandwidth .....	18
6.5. Power Spectral Density .....	37
6.6. Test Specification.....	37
6.7. Conducted Band Edge and Spurious Emission Measurement .....	47
6.8. Radiated Spurious Emission Measurement .....	65

**Appendix A: Photographs of Test Setup**

**Appendix B: Photographs of EUT**

## 1. Test Certification

<b>Product:</b>	Wi-Fi® Radio Transceiver
<b>Model No.:</b>	NM-2450-2F
<b>Additional Model No.:</b>	NL-2450-2F, NM-2450-1F, NL-2450-1F
<b>Applicant:</b>	Doodle Labs (SG) Pte Ltd
<b>Address:</b>	150 Kampong Ampat, KA Centre, Suite #05-03, Singapore 368324
<b>Manufacturer:</b>	Doodle Labs (SG) Pte Ltd
<b>Address:</b>	150 Kampong Ampat, KA Centre, Suite #05-03, Singapore 368324
<b>Date of Test:</b>	Jun. 01- Aug. 25, 2016
<b>Applicable Standards:</b>	FCC CFR Title 47 Part 15 Subpart C Section 15.247 KDB 558074 D01 DTS Meas Guidance v03r05 KDB 662911 D01 Multiple Transmitter Output v02r01 IC RSS-Gen(Issue 4, Nov. 2014) IC RSS-247(Issue 1, May 2015)

*The above equipment has been tested by Shenzhen Tongce Testing Lab. and found compliance with the requirements set forth in the technical standards mentioned above. The results of testing in this report apply only to the product/system, which was tested. Other similar equipment will not necessarily produce the same results due to production tolerance and measurement uncertainties.*

**Tested By:**

*Beryl Zhao*

**Beryl Zhao**

**Date:**

**Aug. 25, 2016**

**Reviewed By:**

*Joe Zhou*

**Joe Zhou**

**Date:**

**Aug. 26, 2016**

**Approved By:**

*Tomsin*

**Tomsin**

**Date:**

**Aug. 26, 2016**

## 2. Test Result Summary

Requirement	CFR 47 Section	IC Rule	Result
Antenna requirement	§15.203/§15.247 (c)	RSS-247, 5.4(6)	PASS
AC Power Line Conducted Emission	§15.207	RSS-GEN, 8.8;	PASS
Output Power	§15.247 (b)(3) §2.1046	RSS-247, 5.4 (4);	PASS
6dB Emission Bandwidth	§15.247 (a)(2) §2.1049	RSS-GEN, 6.6; RSS-247, 5.2 (1);	PASS
99% Bandwidth	§2.1049	RSS-Gen 4.6.1	PASS
Power Spectral Density	§15.247 (e)	RSS-247, 5.2 (2);	PASS
Band Edge	§15.247(d)	RSS-GEN, 8.9; RSS-247, 5.5;	PASS
Spurious Emission	§15.205/§15.209 §2.1053	RSS-247, 5.5;	PASS

**Note:**

1. PASS: Test item meets the requirement.
2. Fail: Test item does not meet the requirement.
3. N/A: Test case does not apply to the test object.
4. The test result judgment is decided by the limit of test standard.

### 3. EUT Description

<b>Product Name:</b>	Wi-Fi® Radio Transceiver
<b>Product Type:</b>	WLAN(2TX, 2RX)
<b>Radio Type:</b>	2x2 MIMO
<b>Model :</b>	NM-2450-2F
<b>Additional Model:</b>	NL-2450-2F, NM-2450-1F, NL-2450-1F
<b>Trade Mark:</b>	N/A
<b>Operation Frequency:</b>	2412MHz~2462MHz (802.11b/802.11g/802.11n(HT20)) 2422MHz~2452MHz (802.11n(HT40))
<b>Channel Separation:</b>	5MHz
<b>Number of Channel:</b>	11 for 802.11b/802.11g/802.11n(HT20) 7 for 802.11n(HT40)
<b>Modulation Technology: (IEEE 802.11b)</b>	Direct Sequence Spread Spectrum (DSSS)
<b>Modulation Technology: (IEEE 802.11g/802.11n)</b>	Orthogonal Frequency Division Multiplexing(OFDM)
<b>Data speed (IEEE 802.11b):</b>	1Mbps, 2Mbps, 5.5Mbps, 11Mbps
<b>Data speed (IEEE 802.11g):</b>	6Mbps, 9Mbps, 12Mbps, 18Mbps, 24Mbps, 36Mbps, 48Mbps, 54Mbps
<b>Data speed (IEEE 802.11n):</b>	Up to 150Mbps
<b>Antenna Type:</b>	R-SMA antenna
<b>Antenna Gain:</b>	All are 3dBi
<b>Power Supply:</b>	DC 3.3V

Items	Description
<b>Beamforming Function</b>	With beamforming

**Operation Frequency each of channel For 802.11b/g/n(HT20)**

Channel	Frequency	Channel	Frequency	Channel	Frequency	Channel	Frequency
1	2412MHz	4	2427MHz	7	2442MHz	10	2457MHz
2	2417MHz	5	2432MHz	8	2447MHz	11	2462MHz
3	2422MHz	6	2437MHz	9	2452MHz		

**Operation Frequency each of channel For 802.11n (HT40)**

Channel	Frequency	Channel	Frequency	Channel	Frequency	Channel	Frequency
--	--	4	2427MHz	7	2442MHz	--	--
--	--	5	2432MHz	8	2447MHz	--	--
3	2422MHz	6	2437MHz	9	2452MHz		

**Note:**

In section 15.31(m), regards to the operating frequency range over 10 MHz, the Lowest frequency, the middle frequency, and the highest frequency of channel were selected to perform the test, and the selected channel see below:

**802.11b/802.11g/802.11n (HT20)**

Channel	Frequency
The lowest channel	2412MHz
The middle channel	2437MHz
The Highest channel	2462MHz

**802.11n (HT40)**

Channel	Frequency
The lowest channel	2422MHz
The middle channel	2437MHz
The Highest channel	2452MHz

**Antenna and Band width**

Antenna	Two (TX)	
	20MHz	40MHz
Band width mode		
IEEE 802.11b	V	X
IEEE 802.11g	V	X
IEEE 802.11n	V	V

Note: "V" means support, "x" means not support.

**IEEE 802.11n Spec.**

Protocol	Number of Transmit Chains (NTX)	Data Rate/MCS
802.11n(HT20)	2	MCS0-23
802.11n(HT40)	2	MCS0-23

## 4. Genera Information

### 4.1. Test environment and mode

Operating Environment:	
Temperature:	25.0 °C
Humidity:	56 % RH
Atmospheric Pressure:	1010 mbar
Test Mode:	
Engineering mode:	Keep the EUT in continuous transmitting by select channel and modulations (The value of duty cycle is 98.46%)
<p>The sample above 1GHz was placed 1.5m (0.8m below 1GHz) above the ground plane of 3m chamber. Measurements in both horizontal and vertical polarities were performed. During the test, each emission was maximized by: having the EUT continuously working, investigated all operating modes, rotated about all 3 axis (X, Y &amp; Z) and considered typical configuration to obtain worst position, manipulating interconnecting cables, rotating the turntable, varying antenna height from 1m to 4m in both horizontal and vertical polarizations. The emissions worst-case are shown in Test Results of the following pages.</p>	

<p>We have verified the construction and function in typical operation. All the test modes were carried out with the EUT in transmitting operation, which was shown in this test report and defined as follows:</p>	
<p><b>Per-scan all kind of data rate in lowest channel, and found the follow list which it was worst case.</b></p>	
Mode	Data rate
802.11b	1Mbps
802.11g	6Mbps
802.11n(H20)	6.5Mbps
802.11n(H40)	13.5Mbps
Final Test Mode:	
Operation mode:	Keep the EUT in continuous transmitting with modulation
<p>According to ANSI C63.4 standards, the test results are both the “worst case” and “worst setup” 1Mbps for 802.11b, 6Mbps for 802.11g, 6.5Mbps for 802.11n(H20). Duty cycle setting during the transmission is 98.5% with maximum power setting for all modulations.</p>	



## 4.2. Description of Support Units

The EUT has been tested as an independent unit together with other necessary accessories or support units. The following support units or accessories were used to form a representative test configuration during the tests.

Equipment	Model No.	Serial No.	FCC ID	Trade Name
Intel NUC	D54250WYKH	G6YK4390029 U	DOC	Intel
Monitor	VX239	VX239H	DOC	ASUS
Keyboard	PK1100UE	04G10418003 9DP	DOC	ASUS
Power	RS-25-5	EB5313825		MEAN WELL

**Note:**

1. All the equipment/cables were placed in the worst-case configuration to maximize the emission during the test.
2. Grounding was established in accordance with the manufacturer's requirements and conditions for the intended use.
3. For conducted measurements (Output Power, 6dB Emission Bandwidth, Power Spectral Density, Spurious Emissions), the antenna of EUT is connected to the test equipment via temporary antenna connector, the antenna connector is soldered on the antenna port of EUT, and the temporary antenna connector is listed in the Test Instruments.

## 5. Facilities and Accreditations

### 5.1. Facilities

The test facility is recognized, certified, or accredited by the following organizations:

- FCC - Registration No.: 572331

Shenzhen Tongce Testing Lab

The 3m Semi-anechoic chamber has been registered and fully described in a report with the (FCC) Federal Communications Commission. The acceptance letter from the FCC is maintained in our files.

- IC - Registration No.: 10668A-1

The 3m Semi-anechoic chamber of Shenzhen TCT Testing Technology Co., Ltd. has been registered by Certification and Engineering Bureau of Industry Canada for radio equipment testing

- CNAS - Registration No.: CNAS L6165

Shenzhen TCT Testing Technology Co., Ltd. is accredited to ISO/IEC 17025:2005 General Requirements for the Competence of Testing and Calibration laboratories for the competence of testing. The Registration No. is CNAS L6165.

### 5.2. Location

Shenzhen Tongce Testing Lab

Address: 1F, Leinuo Watch Building, Fuyong Town, Baoan Dist, Shenzhen, China

Tel: 86-755-36638142

### 5.3. Measurement Uncertainty

The reported uncertainty of measurement  $y \pm U$ , where expanded uncertainty  $U$  is based on a standard uncertainty multiplied by a coverage factor of  $k=2$ , providing a level of confidence of approximately 95 %.

No.	Item	MU
1	Conducted Emission	$\pm 2.56\text{dB}$
2	RF power, conducted	$\pm 0.12\text{dB}$
3	Spurious emissions, conducted	$\pm 0.11\text{dB}$
4	All emissions, radiated(<1G)	$\pm 3.92\text{dB}$
5	All emissions, radiated(>1G)	$\pm 4.28\text{dB}$
6	Temperature	$\pm 0.1^\circ\text{C}$
7	Humidity	$\pm 1.0\%$

## 6. Test Results and Measurement Data

### 6.1. Antenna requirement

<b>Standard requirement:</b>	FCC Part15 C Section 15.203 /247(c)/ RSS-247, 5.4 (6)
------------------------------	---

15.203 requirement:  
An intentional radiator shall be designed to ensure that no antenna other than that furnished by the responsible party shall be used with the device. The use of a permanently attached antenna or of an antenna that uses a unique coupling to the intentional radiator, the manufacturer may design the unit so that a broken antenna can be replaced by the user, but the use of a standard antenna jack or electrical connector is prohibited.

15.247(c) (1)(i) requirement:  
(i) Systems operating in the 2400-2483.5 MHz band that is used exclusively for fixed. Point-to-point operations may employ transmitting antennas with directional gain greater than 6dBi provided the maximum conducted output power of the intentional radiator is reduced by 1 dB for every 3 dB that the directional gain of the antenna exceeds 6dBi.

<b>E.U.T Antenna:</b>	
-----------------------	--

The EUT has two R-SMA antennas which permanently attached, and the best case gain of the two antennas are 3dBi.

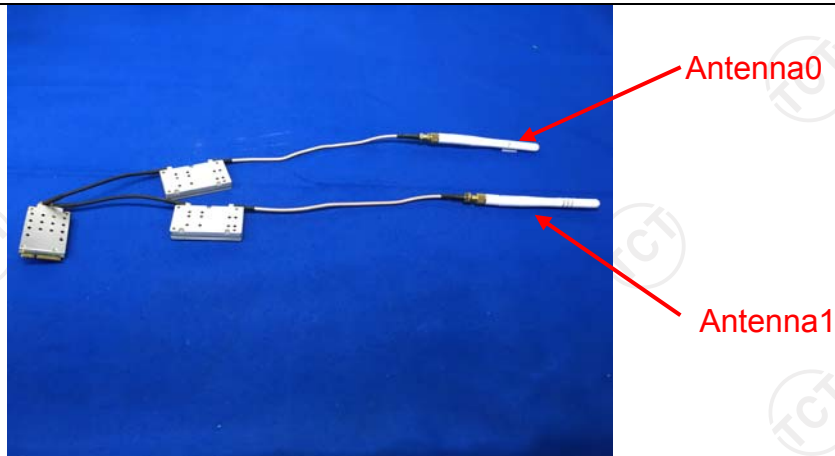

## 6.2. Conducted Emission

### 6.2.1. Test Specification

<b>Test Requirement:</b>	FCC Part15 C Section 15.207/RSS-GEN, 8.8														
<b>Test Method:</b>	ANSI C63.10:2013														
<b>Frequency Range:</b>	150 kHz to 30 MHz														
<b>Receiver setup:</b>	RBW=9 kHz, VBW=30 kHz, Sweep time=auto														
<b>Limits:</b>	<table border="1"> <thead> <tr> <th rowspan="2">Frequency range (MHz)</th> <th colspan="2">Limit (dBuV)</th> </tr> <tr> <th>Quasi-peak</th> <th>Average</th> </tr> </thead> <tbody> <tr> <td>0.15-0.5</td> <td>66 to 56*</td> <td>56 to 46*</td> </tr> <tr> <td>0.5-5</td> <td>56</td> <td>46</td> </tr> <tr> <td>5-30</td> <td>60</td> <td>50</td> </tr> </tbody> </table>	Frequency range (MHz)	Limit (dBuV)		Quasi-peak	Average	0.15-0.5	66 to 56*	56 to 46*	0.5-5	56	46	5-30	60	50
Frequency range (MHz)	Limit (dBuV)														
	Quasi-peak	Average													
0.15-0.5	66 to 56*	56 to 46*													
0.5-5	56	46													
5-30	60	50													
<b>Test Setup:</b>	<p><i>Remark</i> E.U.T: Equipment Under Test LISN: Line Impedance Stabilization Network Test table height=0.8m</p>														
<b>Test Mode:</b>	TX Mode														
<b>Test Procedure:</b>	<ol style="list-style-type: none"> <li>The E.U.T and simulators are connected to the main power through a line impedance stabilization network (L.I.S.N.). This provides a 50ohm/50uH coupling impedance for the measuring equipment.</li> <li>The peripheral devices are also connected to the main power through a LISN that provides a 50ohm/50uH coupling impedance with 50ohm termination. (Please refer to the block diagram of the test setup and photographs).</li> <li>Both sides of A.C. line are checked for maximum conducted interference. In order to find the maximum emission, the relative positions of equipment and all of the interface cables must be changed according to ANSI C63.10: 2013 on conducted measurement.</li> </ol>														
<b>Test Result:</b>	PASS														

**6.2.2. Test Instruments**

Conducted Emission Shielding Room Test Site (843)				
Equipment	Manufacturer	Model	Serial Number	Calibration Due
EMI Test Receiver	R&S	ESCS30	100139	Sep. 11, 2016
LISN	Schwarzbeck	NSLK 8126	8126453	Sep. 16, 2016
Coax cable	TCT	CE-05	N/A	Sep. 11, 2016
EMI Test Software	Shurple Technology	EZ-EMC	N/A	N/A

**Note:** The calibration interval of the above test instruments is 12 months and the calibrations are traceable to international system unit (SI).

6.2.3. Test data

Please refer to following diagram for individual

Conducted Emission on Line Terminal of the power line (150 kHz to 30MHz)

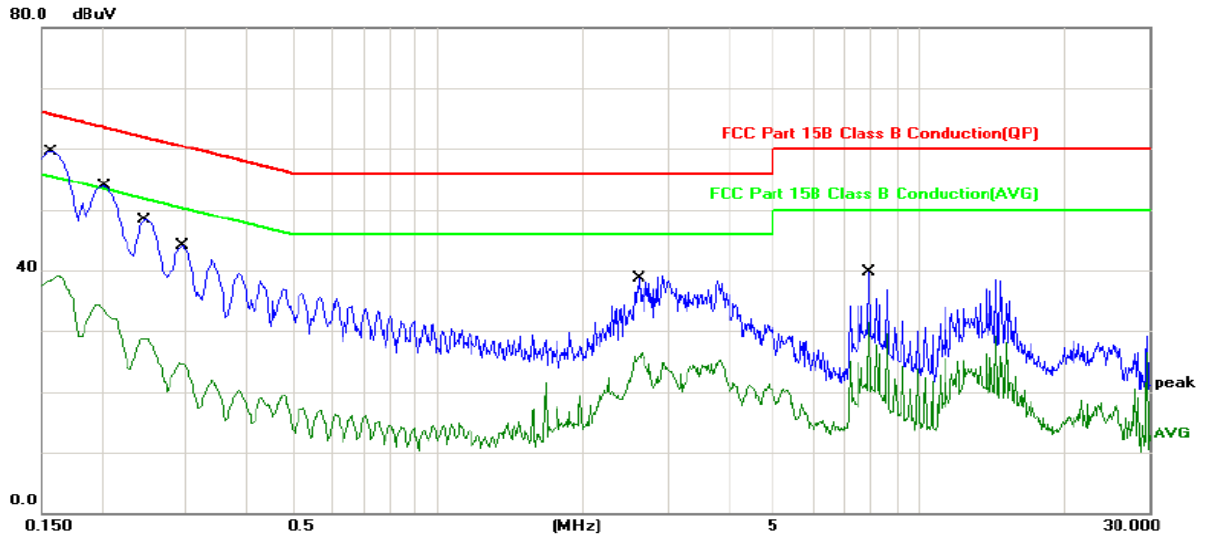

Site Chamber #2 Phase: L1 Temperature: 23  
Limit: FCC Part 15B Class B Conduction(QP) Power: Humidity: 54 %

No.	Mk.	Freq. MHz	Reading Level dBuV	Correct Factor dB	Measure- ment dBuV	Limit dBuV	Over dB	Detector	Comment
1	*	0.1580	43.92	11.47	55.39	65.56	-10.17	QP	
2		0.1580	28.16	11.47	39.63	55.56	-15.93	AVG	
3		0.2020	38.20	11.45	49.65	63.52	-13.87	QP	
4		0.2020	21.40	11.45	32.85	53.52	-20.67	AVG	
5		0.2460	32.41	11.43	43.84	61.89	-18.05	QP	
6		0.2460	17.00	11.43	28.43	51.89	-23.46	AVG	
7		0.2940	28.26	11.40	39.66	60.41	-20.75	QP	
8		0.2940	13.18	11.40	24.58	50.41	-25.83	AVG	
9		2.6099	19.12	11.47	30.59	56.00	-25.41	QP	
10		2.6099	13.93	11.47	25.40	46.00	-20.60	AVG	
11		7.8820	25.36	11.04	36.40	60.00	-23.60	QP	
12		7.8820	19.27	11.04	30.31	50.00	-19.69	AVG	

**Note:**

- Freq. = Emission frequency in MHz
- Reading level (dBuV) = Receiver reading
- Corr. Factor (dB) = Antenna factor + Cable loss
- Measurement (dBuV) = Reading level (dBuV) + Corr. Factor (dB)
- Limit (dBuV) = Limit stated in standard
- Margin (dB) = Measurement (dBuV) – Limits (dBuV)
- Q.P. =Quasi-Peak
- AVG =average
- \* is meaning the worst frequency has been tested in the frequency range 150 kHz to 30MHz.

**Conducted Emission on Neutral Terminal of the power line (150 kHz to 30MHz)**

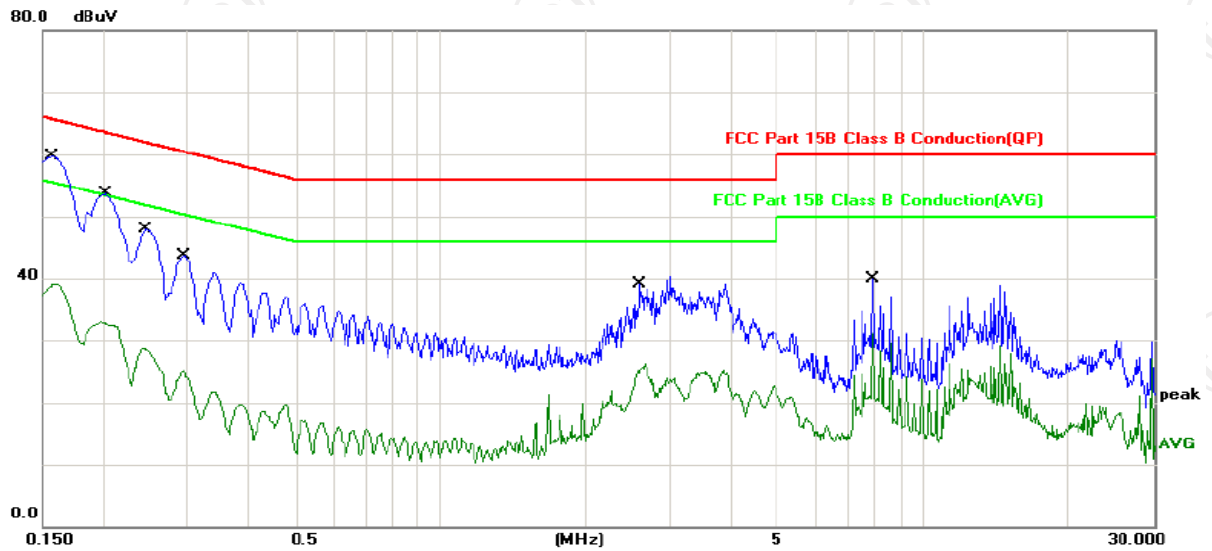

Site Chamber #2 Phase: **N** Temperature: 23  
Limit: FCC Part 15B Class B Conduction(QP) Power: Humidity: 54 %

No.	Mk.	Freq. MHz	Reading Level dBuV	Correct Factor dB	Measure- ment dBuV	Limit dBuV	Over dB	Detector	Comment
1	*	0.1580	43.81	11.47	55.28	65.56	-10.28	QP	
2		0.1580	27.84	11.47	39.31	55.56	-16.25	AVG	
3		0.2020	38.04	11.45	49.49	63.52	-14.03	QP	
4		0.2020	21.18	11.45	32.63	53.52	-20.89	AVG	
5		0.2460	32.21	11.43	43.64	61.89	-18.25	QP	
6		0.2460	16.85	11.43	28.28	51.89	-23.61	AVG	
7		0.2940	28.10	11.40	39.50	60.41	-20.91	QP	
8		0.2940	13.05	11.40	24.45	50.41	-25.96	AVG	
9		2.5940	18.76	11.47	30.23	56.00	-25.77	QP	
10		2.5940	13.52	11.47	24.99	46.00	-21.01	AVG	
11		7.8820	25.54	11.04	36.58	60.00	-23.42	QP	
12		7.8820	19.70	11.04	30.74	50.00	-19.26	AVG	

**Note:**

- Freq. = Emission frequency in MHz
- Reading level (dBuV) = Receiver reading
- Corr. Factor (dB) = attenuator factor + Cable loss
- Measurement (dBuV) = Reading level (dBuV) + Corr. Factor (dB)
- Limit (dBuV) = Limit stated in standard
- Margin (dB) = Measurement (dBuV) – Limits (dBuV)
- Q.P. =Quasi-Peak
- AVG =average
- \* is meaning the worst frequency has been tested in the frequency range 150 kHz to 30MHz.

### 6.3. Maximum Conducted (Peak) Output Power

#### 6.3.1. Test Specification

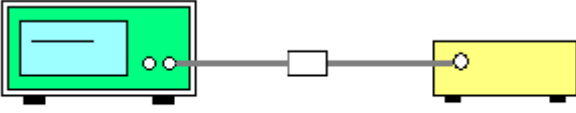
<b>Test Requirement:</b>	FCC Part15 C Section 15.247 (b)(3)/RSS-247, 5.4 (4)
<b>Test Method:</b>	KDB558074 and KDB662911
<b>Limit:</b>	30dBm
<b>Test Setup:</b>	 <p style="text-align: center;">Spectrum Analyzer                      EUT</p>
<b>Test Mode:</b>	Transmitting mode with modulation
<b>Test Procedure:</b>	<ol style="list-style-type: none"> <li>1. The testing follows the Measurement Procedure of FCC KDB No. 558074 DTS D01 Meas. Guidance v03r05.</li> <li>2. The RF output of EUT was connected to the power meter by RF cable and attenuator. The path loss was compensated to the results for each measurement.</li> <li>3. Set to the maximum power setting and enable the EUT transmit continuously.</li> <li>4. Measure the conducted output power and record the results in the test report.</li> </ol>
<b>Test Result:</b>	PASS

#### 6.3.2. Test Instruments

Equipment	Manufacturer	Model	Serial Number	Calibration Due
Power Meter	Anritsu	ML2495A	1005002	Sep. 12, 2016
Pulse Power Sensor	Anritsu	MA2411B	0917070	Sep. 12, 2016
RF cable	TCT	RE-06	N/A	Sep. 12, 2016
Antenna Connector	TCT	RFC-01	N/A	Sep. 12, 2016

**Note:** The calibration interval of the above test instruments is 12 months and the calibrations are traceable to international system unit (SI).



**6.3.3. Test Data**

Configuration IEEE 802.11b/ Antenna 0+Antenna 1					
Test channel	Maximum Conducted (Average) Output Power (dBm)			Limit (dBm)	Result
	Ant0	Ant1	Total		
Lowest	26.10	25.98	29.05	29.99	PASS
Middle	24.77	24.63	27.71	29.99	PASS
Highest	24.37	24.32	27.36	29.99	PASS

Configuration IEEE 802.11g/ Antenna 0+Antenna 1					
Test channel	Maximum Conducted (Average) Output Power (dBm)			Limit (dBm)	Result
	Ant0	Ant1	Total		
Lowest	25.22	25.17	28.21	29.99	PASS
Middle	24.98	24.92	27.96	29.99	PASS
Highest	24.43	24.36	27.41	29.99	PASS

Configuration IEEE 802.11n(HT20)/ Antenna 0+Antenna 1					
Test channel	Maximum Conducted (Average) Output Power (dBm)			Limit (dBm)	Result
	Ant0	Ant1	Total		
Lowest	24.84	24.81	27.84	29.99	PASS
Middle	24.77	24.69	27.74	29.99	PASS
Highest	24.65	24.58	27.63	29.99	PASS

Configuration IEEE 802.11n(HT40)/ Antenna 0+Antenna 1					
Test channel	Maximum Conducted (Average) Output Power (dBm)			Limit (dBm)	Result
	Ant0	Ant1	Total		
Lowest	24.65	24.61	27.64	29.99	PASS
Middle	24.65	24.59	27.63	29.99	PASS
Highest	24.65	24.63	27.65	29.99	PASS

**Note:**  $G_{ANT} = 3\text{dBi}$ , Array Gain =  $10\log(N_{ANT}/N_{SS}) = 3.01\text{dBi}$

Directional Gain =  $G_{ANT} + \text{Array Gain} = 6.01\text{dBi}$ , So limit =  $30 - (6.01 - 6) = 29.99\text{dBm}$

## 6.4. Emission Bandwidth

### 6.4.1. Test Specification

<b>Test Requirement:</b>	FCC Part15 C Section 15.247 (a)(2)/RSS-GEN, 6.6; RSS-247, 5.2(1)
<b>Test Method:</b>	KDB558074
<b>Limit:</b>	>500kHz
<b>Test Setup:</b>	 <p style="text-align: center;">Spectrum Analyzer                      EUT</p>
<b>Test Mode:</b>	Transmitting mode with modulation
<b>Test Procedure:</b>	<ol style="list-style-type: none"> <li>1. The testing follows FCC KDB Publication No. 558074 DTS D01 Meas. Guidance v03r05.</li> <li>2. Set to the maximum power setting and enable the EUT transmit continuously.</li> <li>3. Make the measurement with the spectrum analyzer's resolution bandwidth (RBW) = 100 kHz. Set the Video bandwidth (VBW) = 300 kHz. In order to make an accurate measurement. The 6dB bandwidth must be greater than 500 kHz.</li> <li>4. Set the spectrum to test 99%OBW.</li> <li>5. Measure and record the results in the test report.</li> </ol>
<b>Test Result:</b>	PASS

### 6.4.2. Test Instruments

RF Test Room				
Equipment	Manufacturer	Model	Serial Number	Calibration Due
Spectrum Analyzer	R&S	FSU	200054	Sep. 11, 2016
RF cable	TCT	RE-06	N/A	Sep. 12, 2016
Antenna Connector	TCT	RFC-01	N/A	Sep. 12, 2016

**Note:** The calibration interval of the above test instruments is 12 months and the calibrations are traceable to international system unit (SI).

**6.4.3. Test data**

**Antenna 0:**

Test channel	6dB Emission Bandwidth (MHz)			
	802.11b	802.11g	802.11n(H20)	802.11n(H40)
Lowest	10.14	16.44	17.64	36.55
Middle	10.19	16.35	17.63	36.56
Highest	10.14	16.44	17.64	36.54
Limit:	>500k			
Test Result:	PASS			

**Antenna 1:**

Test channel	6dB Emission Bandwidth (MHz)			
	802.11b	802.11g	802.11n(H20)	802.11n(H40)
Lowest	10.14	16.44	17.64	36.54
Middle	10.14	16.49	17.67	36.56
Highest	10.14	16.39	17.64	36.46
Limit:	>500k			
Test Result:	PASS			

**Antenna 0:**

Test channel	99% Emission Bandwidth (MHz)			
	802.11b	802.11g	802.11n(H20)	802.11n(H40)
Lowest	13.89	16.54	17.74	36.38
Middle	13.94	16.54	17.74	36.30
Highest	13.89	16.54	17.74	36.38
Limit:	>500k			
Test Result:	PASS			

**Antenna 1:**

Test channel	99% Emission Bandwidth (MHz)			
	802.11b	802.11g	802.11n(H20)	802.11n(H40)
Lowest	13.89	16.54	17.74	36.38
Middle	13.89	16.54	17.74	36.38
Highest	13.89	16.54	17.74	36.38
Limit:	>500k			
Test Result:	PASS			

Test plots as follows:

**6dB Emission Bandwidth**  
Antenna 0:  
802.11b Modulation

Lowest channel

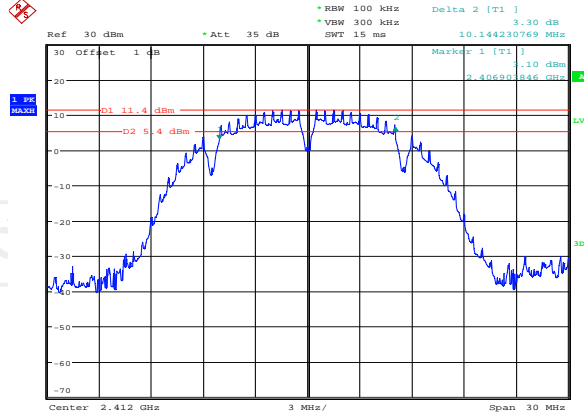

Date: 17.AUG.2016 16:47:07

Middle channel

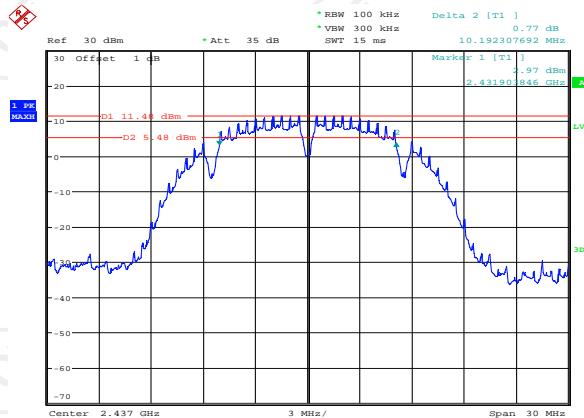

Date: 17.AUG.2016 16:51:07

Highest channel

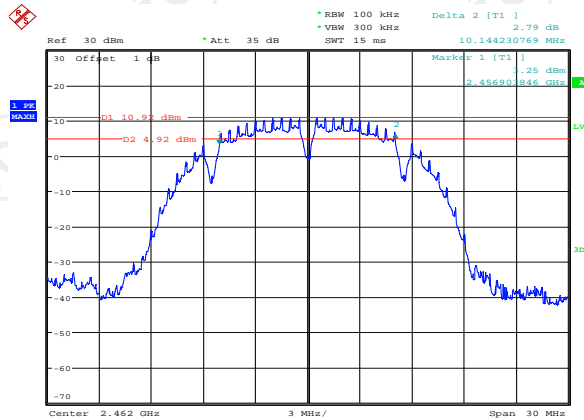

Date: 17.AUG.2016 16:54:22

## 802.11g Modulation

### Lowest channel

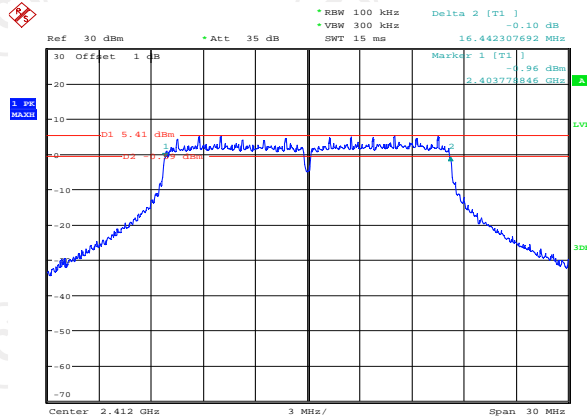

Date: 17.AUG.2016 17:15:00

### Middle channel

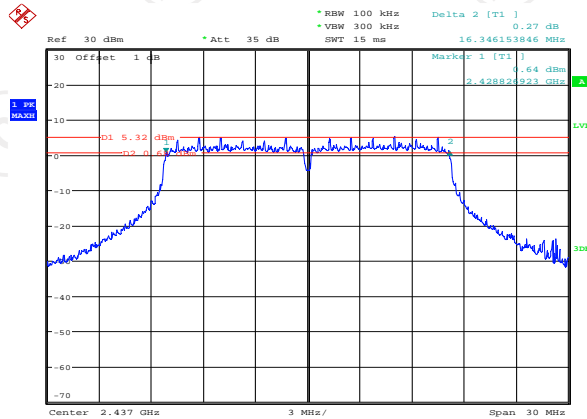

Date: 17.AUG.2016 17:12:01

### Highest channel

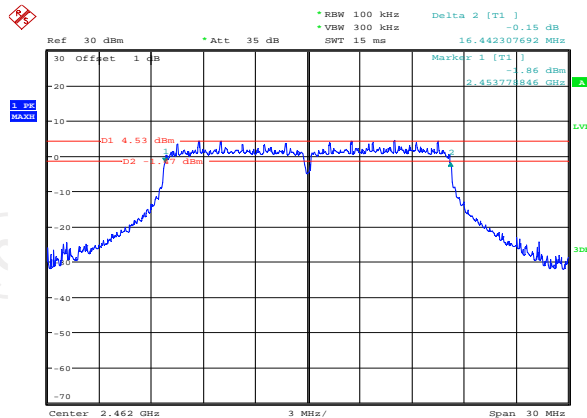

Date: 17.AUG.2016 17:08:58

## 802.11n (HT20) Modulation

### Lowest channel

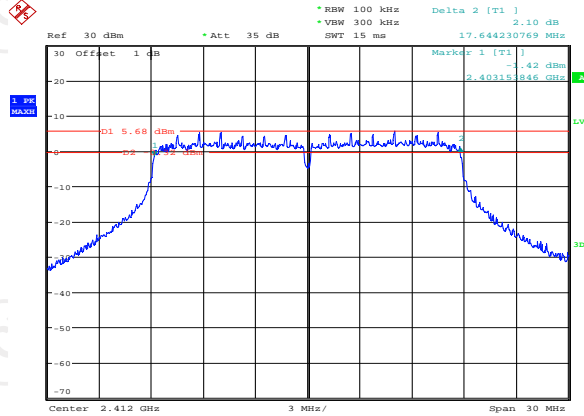

Date: 17.AUG.2016 17:31:22

### Middle channel

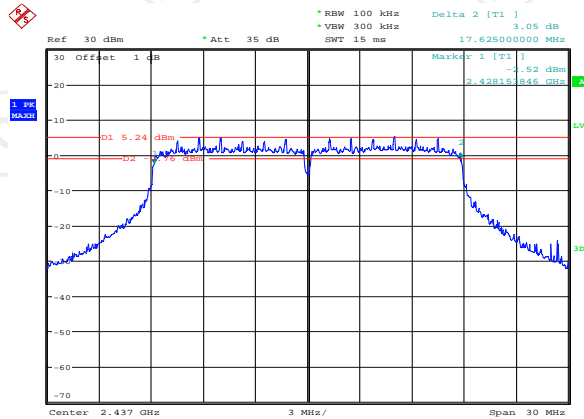

Date: 17.AUG.2016 17:26:16

### Highest channel

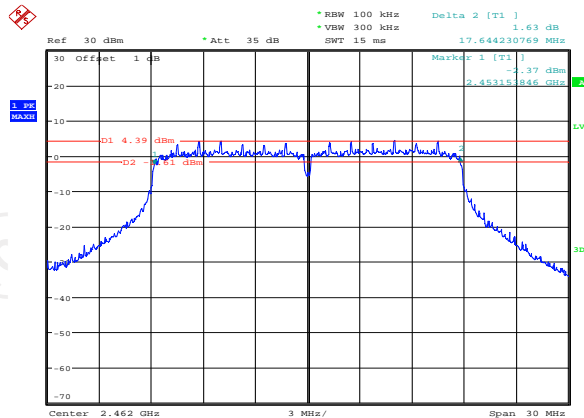

Date: 17.AUG.2016 17:24:31

## 802.11n (HT40) Modulation

### Lowest channel

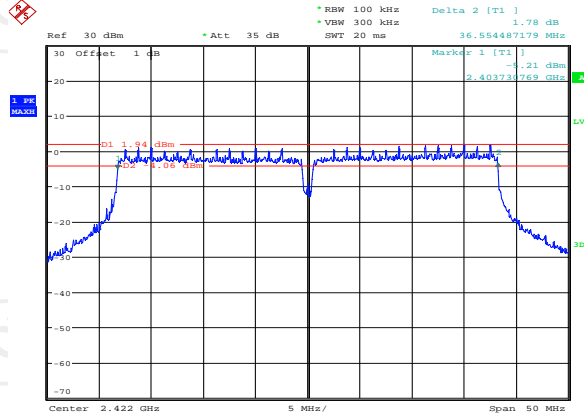

Date: 17.AUG.2016 18:07:50

### Middle channel

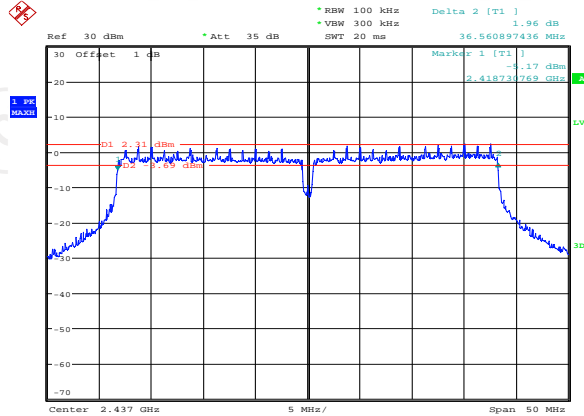

Date: 17.AUG.2016 18:05:54

### Highest channel

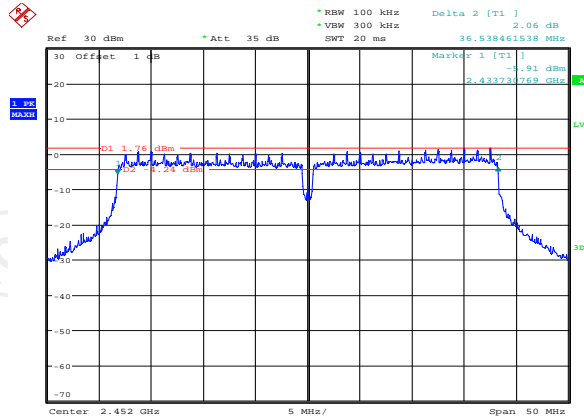

Date: 17.AUG.2016 18:02:22



Antenna 1:  
802.11b Modulation

### Lowest channel

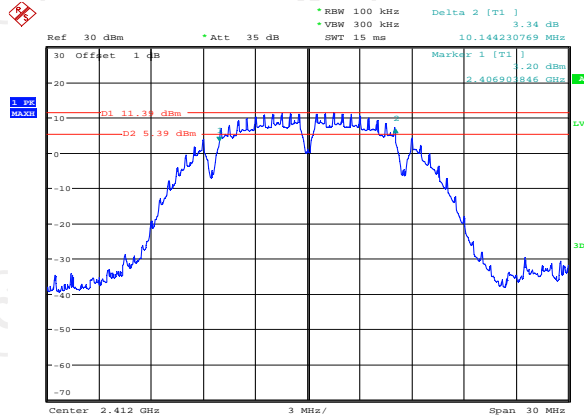

Date: 17.AUG.2016 16:48:06

### Middle channel

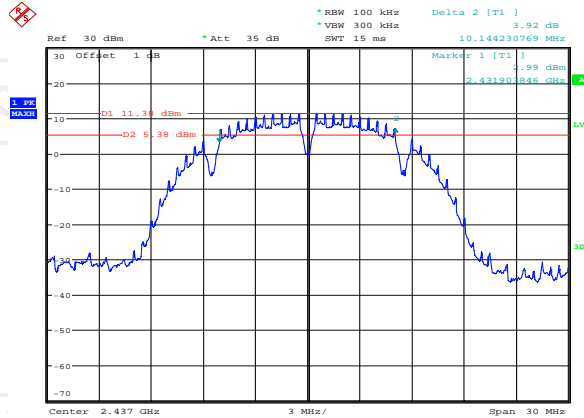

Date: 17.AUG.2016 16:52:50

### Highest channel

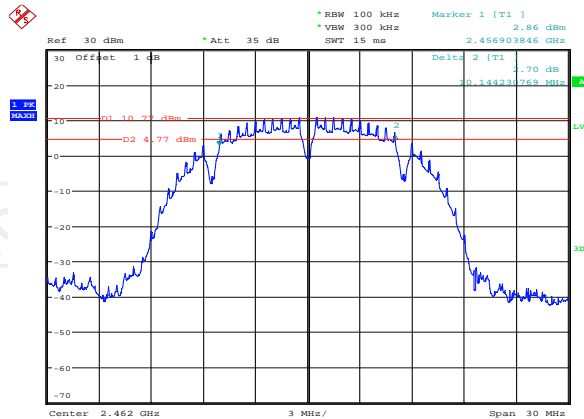

Date: 17.AUG.2016 16:55:27

## 802.11g Modulation

### Lowest channel

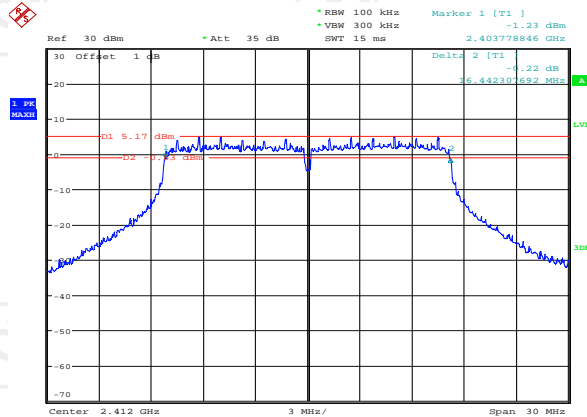

### Middle channel

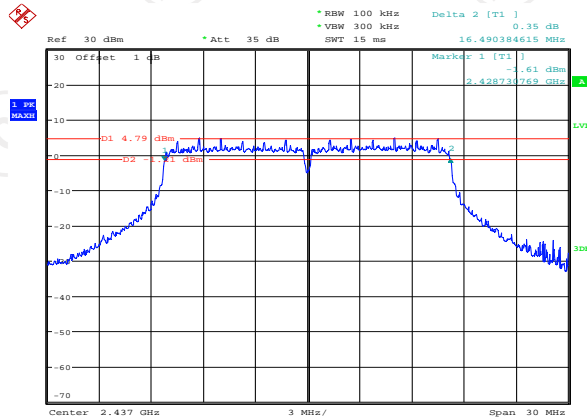

### Highest channel

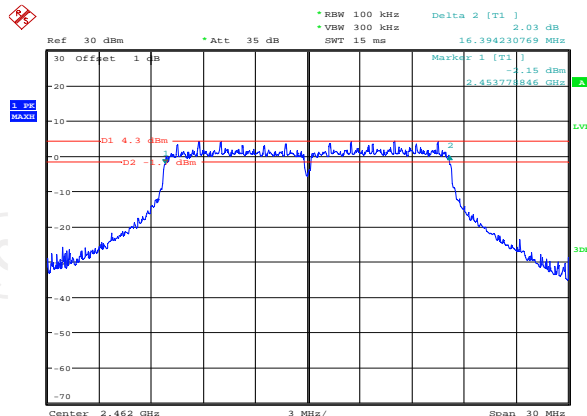

## 802.11n (HT20) Modulation

### Lowest channel

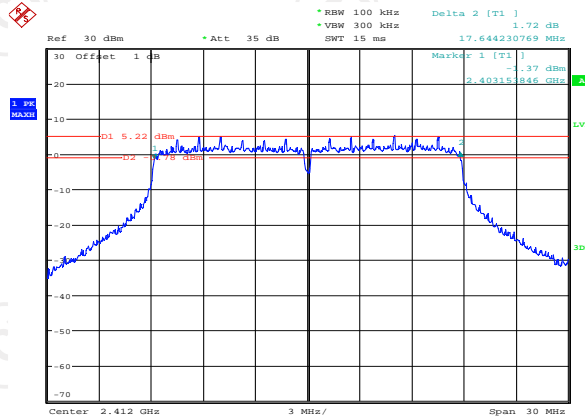

Date: 17.AUG.2016 17:37:19

### Middle channel

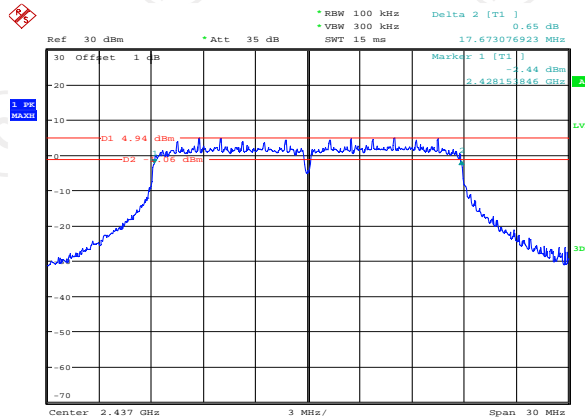

Date: 17.AUG.2016 17:28:34

### Highest channel

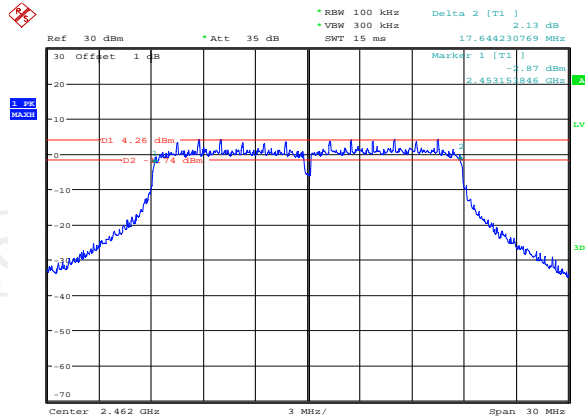

Date: 17.AUG.2016 17:25:09

## 802.11n (HT40) Modulation

### Lowest channel

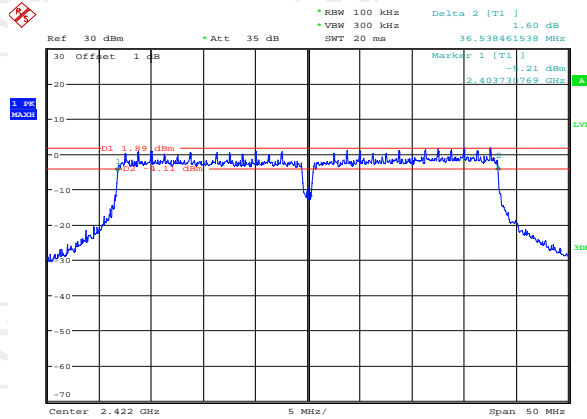

### Middle channel

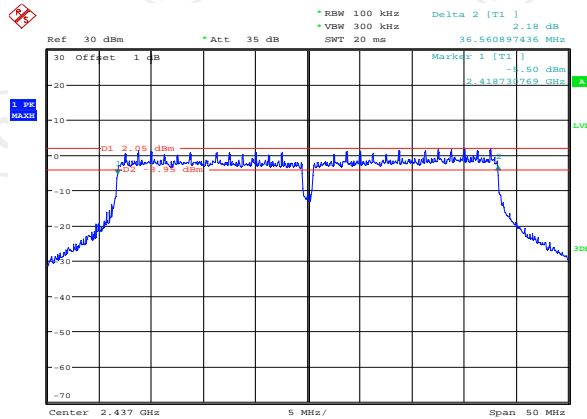

### Highest channel

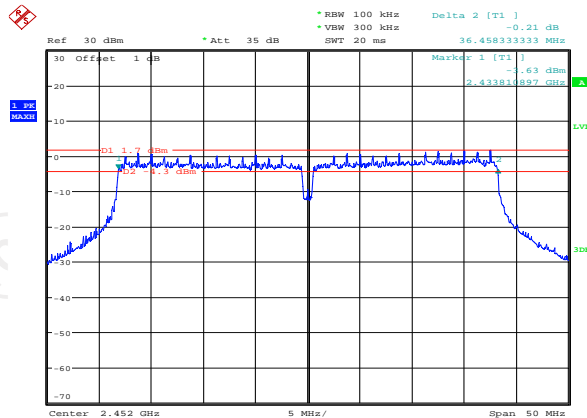

**99% Emission Bandwidth**  
**Antenna 0:**  
**802.11b Modulation**

**Lowest channel**

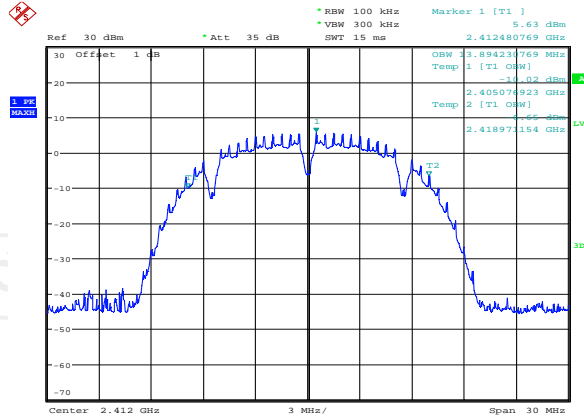

Date: 17.AUG.2016 18:22:33

**Middle channel**

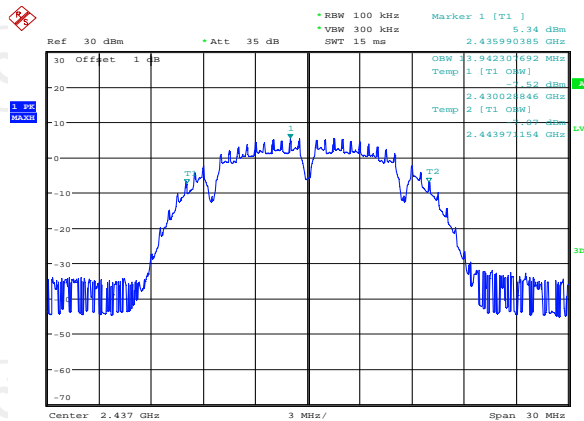

Date: 17.AUG.2016 18:23:25

**Highest channel**

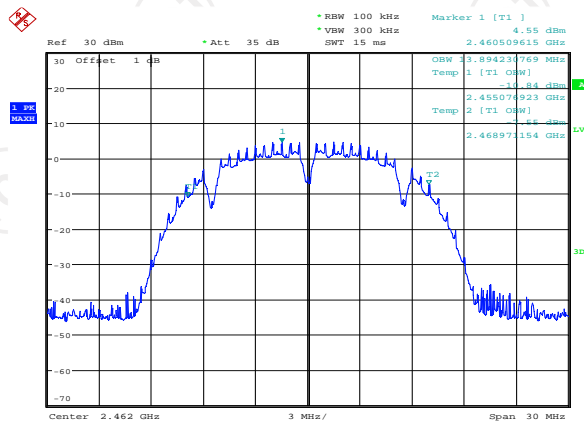

Date: 17.AUG.2016 18:24:04

802.11g Modulation

Lowest channel

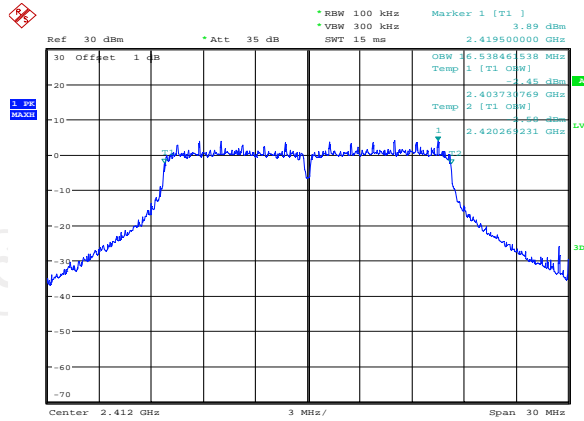

Date: 17.AUG.2016 18:17:34

Middle channel

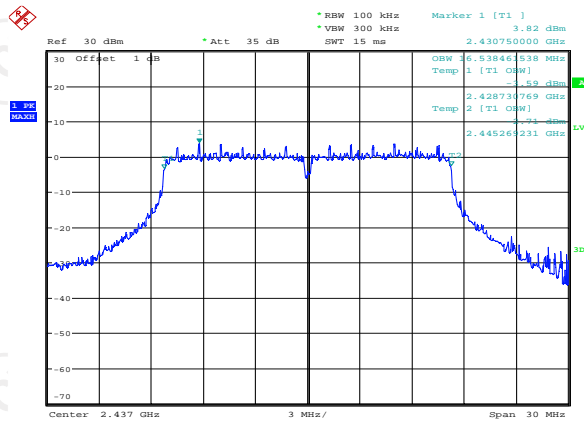

Date: 17.AUG.2016 18:20:21

Highest channel

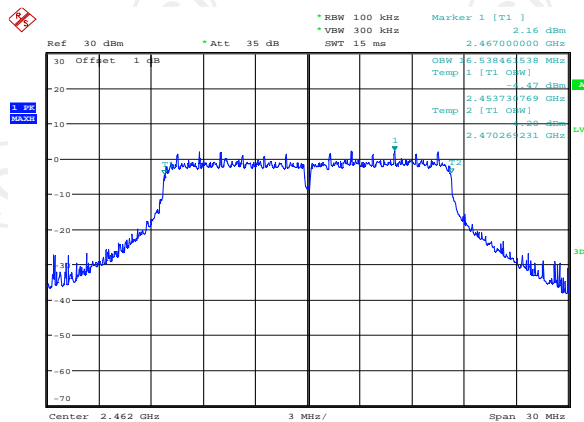

Date: 17.AUG.2016 18:21:10

## 802.11n (HT20) Modulation

### Lowest channel

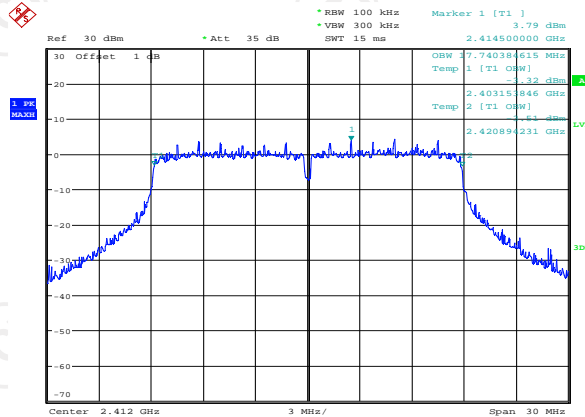

Date: 17.AUG.2016 18:16:41

### Middle channel

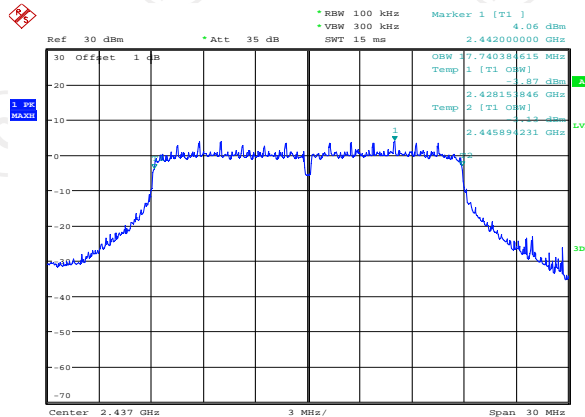

Date: 17.AUG.2016 18:16:06

### Highest channel

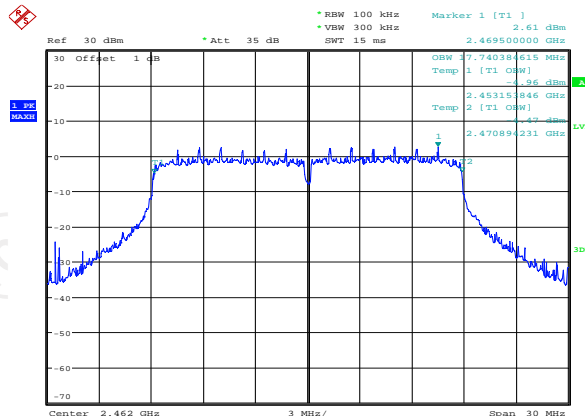

Date: 17.AUG.2016 18:15:23

## 802.11n (HT40) Modulation

### Lowest channel

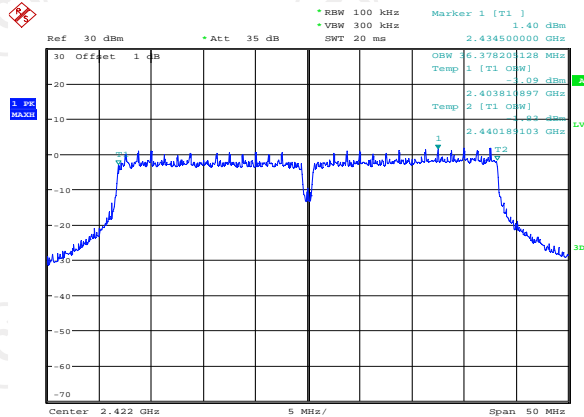

Date: 17.AUG.2016 18:09:49

### Middle channel

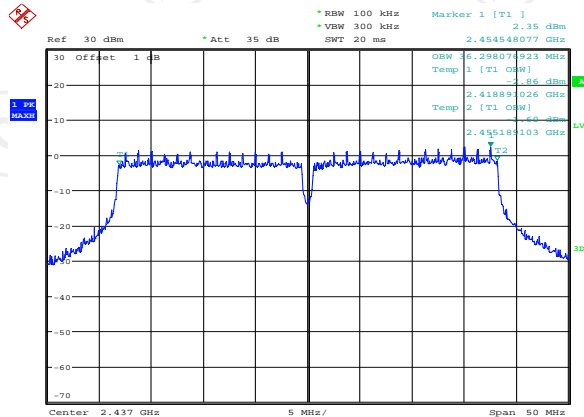

Date: 17.AUG.2016 18:10:33

### Highest channel

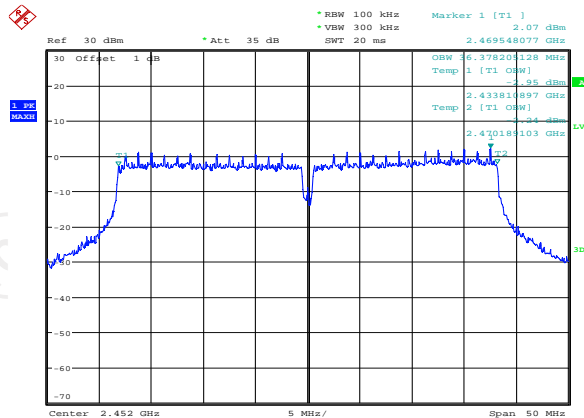

Date: 17.AUG.2016 18:11:23



Antenna 1:  
802.11b Modulation

### Lowest channel

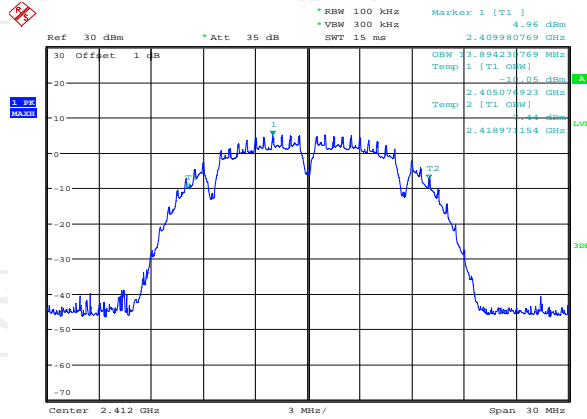

Date: 17.AUG.2016 18:22:47

### Middle channel

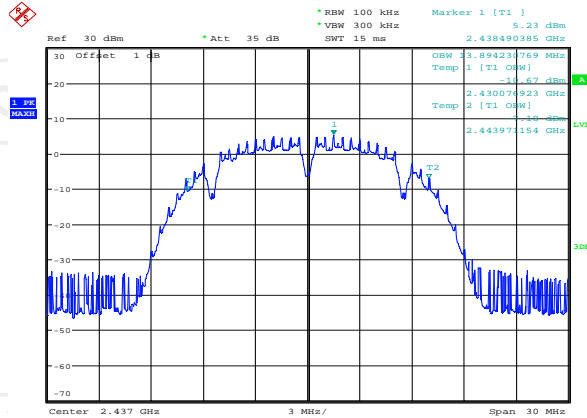

Date: 17.AUG.2016 18:23:36

### Highest channel

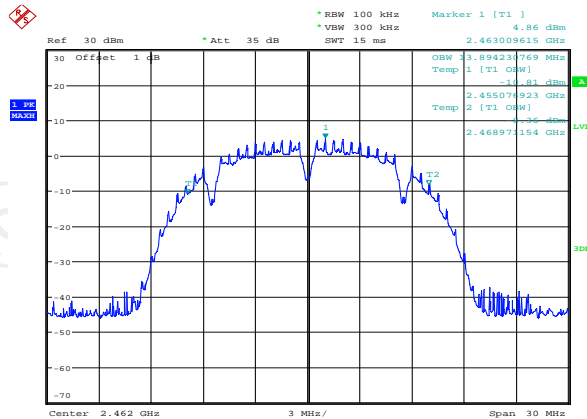

Date: 17.AUG.2016 18:24:17

802.11g Modulation

Lowest channel

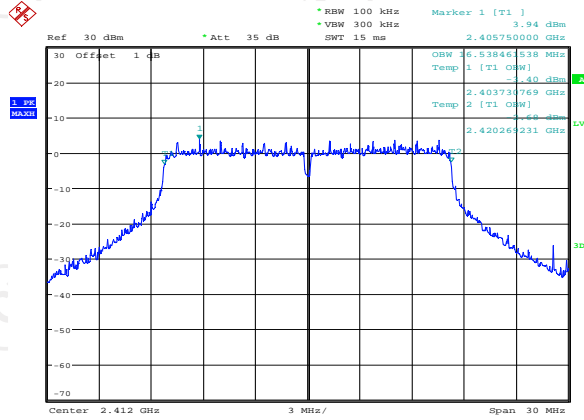

Date: 17.AUG.2016 18:17:46

Middle channel

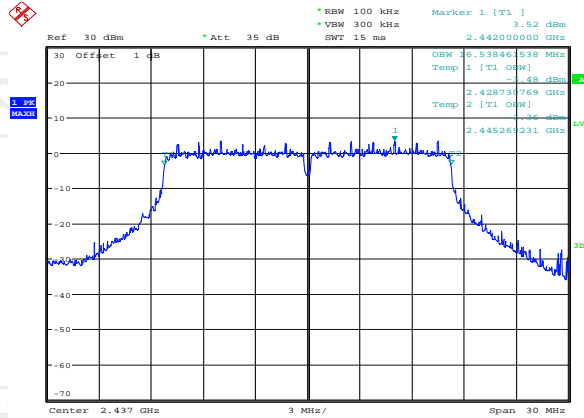

Date: 17.AUG.2016 18:20:32

Highest channel

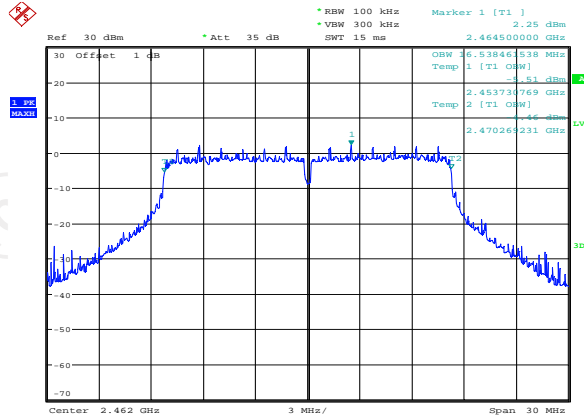

Date: 17.AUG.2016 18:21:23

## 802.11n (HT20) Modulation

### Lowest channel

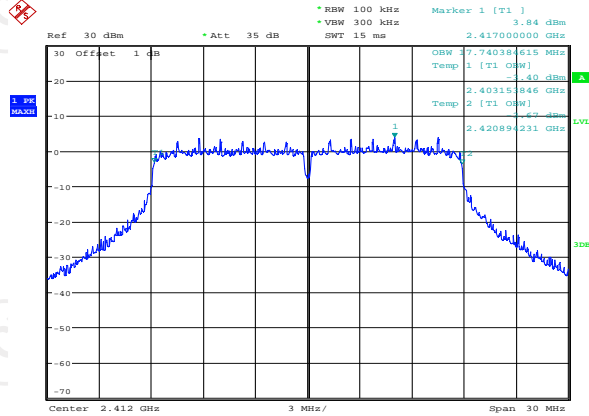

Date: 17.AUG.2016 18:16:51

### Middle channel

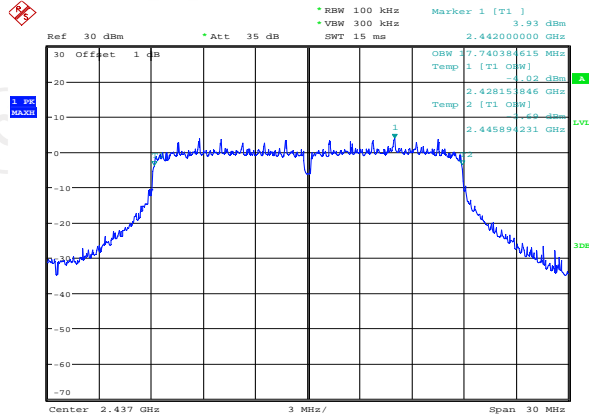

Date: 17.AUG.2016 18:16:15

### Highest channel

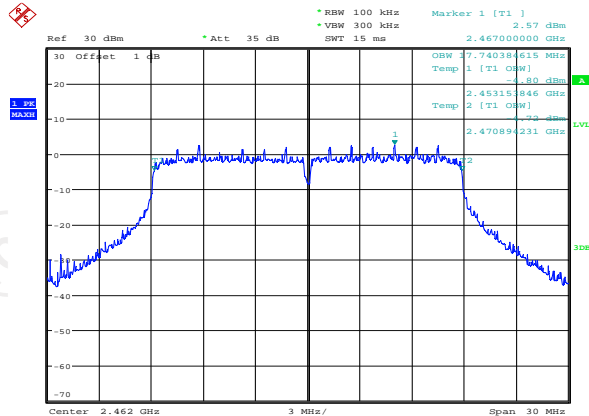

Date: 17.AUG.2016 18:15:33

## 802.11n (HT40) Modulation

### Lowest channel

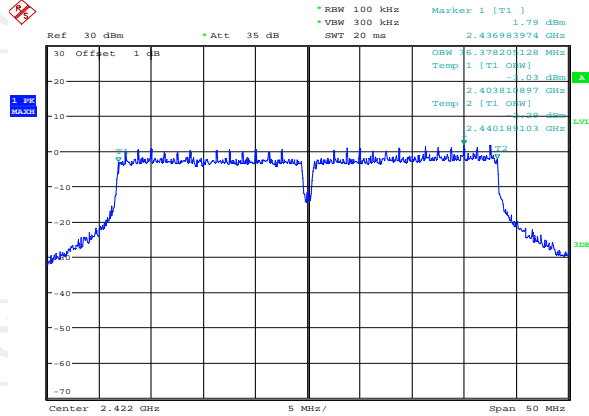

Date: 17.AUG.2016 18:10:03

### Middle channel

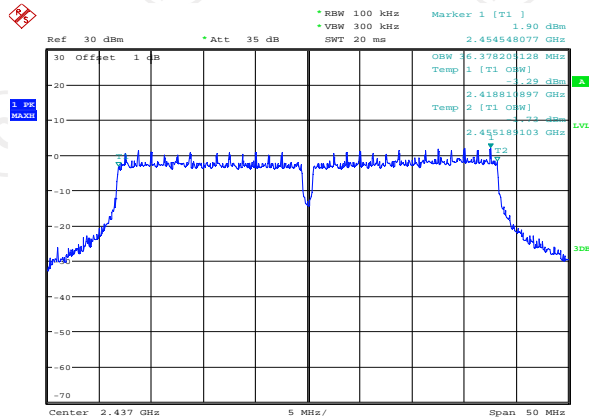

Date: 17.AUG.2016 18:10:43

### Highest channel

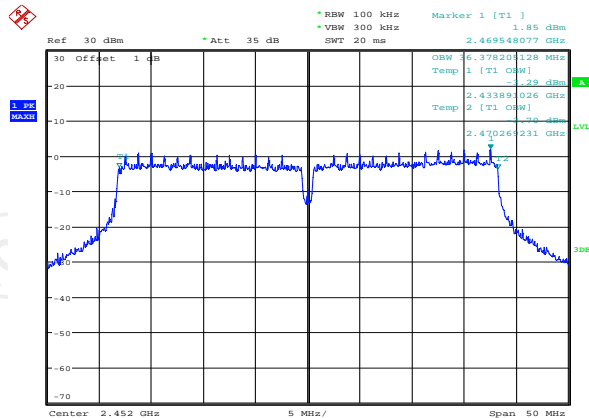

Date: 17.AUG.2016 18:11:37

## 6.5. Power Spectral Density

### 6.6. Test Specification

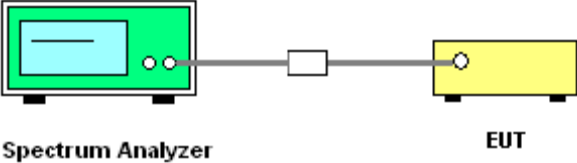
<b>Test Requirement:</b>	FCC Part15 C Section 15.247 (e)/RSS-247, 5.2(2)
<b>Test Method:</b>	KDB558074, KDB662911
<b>Limit:</b>	The Average power spectral density shall not be greater than 8dBm in any 3kHz band at any time interval of continuous transmission.
<b>Test Setup:</b>	 <p style="text-align: center;">Spectrum Analyzer                      EUT</p>
<b>Test Mode:</b>	Transmitting mode with modulation
<b>Test Procedure:</b>	<ol style="list-style-type: none"> <li>1. The testing follows Measurement Procedure 10.3 Method AVGPSD of FCC KDB Publication No.558074 D01 DTS Meas. Guidance v03r05</li> <li>2. The RF output of EUT was connected to the spectrum analyzer by RF cable and attenuator. The path loss was compensated to the results for each measurement.</li> <li>3. Set to the maximum power setting and enable the EUT transmit continuously.</li> <li>4. Make the measurement with the spectrum analyzer's resolution bandwidth (RBW): <math>3 \text{ kHz} \leq \text{RBW} \leq 100 \text{ kHz}</math>. Video bandwidth VBW <math>\geq 3 \times \text{RBW}</math>. Set the span to at least 1.5 times the OBW.</li> <li>5. Detector = RMS, Sweep time = auto couple.</li> <li>6. Employ trace averaging (RMS) mode over a minimum of 100 traces. Use the peak marker function to determine the maximum power level.</li> <li>6. Measure and record the results in the test report.</li> </ol>
<b>Test Result:</b>	PASS

#### 6.6.1. Test Instruments

RF Test Room				
Equipment	Manufacturer	Model	Serial Number	Calibration Due
Spectrum Analyzer	R&S	FSU	200054	Sep. 11, 2016
RF cable	TCT	RE-06	N/A	Sep. 12, 2016
Antenna Connector	TCT	RFC-01	N/A	Sep. 12, 2016

**Note:** The calibration interval of the above test instruments is 12 months and the calibrations are traceable to international system unit (SI).

**6.6.2. Test data**

Configuration IEEE 802.11b/ Antenna 0, Antenna 1					
Test channel	AVG Power Spectral Density (dBm/3kHz)			Limit (dBm)	Result
	Ant0	Ant1	Total		
Lowest	-3.02	-7.52	-1.70	7.99dBm/3kHz	PASS
Middle	-3.64	-3.30	-0.46	7.99dBm/3kHz	PASS
Highest	-3.56	-3.81	-0.67	7.99dBm/3kHz	PASS

Configuration IEEE 802.11g/ Antenna 0, Antenna 1					
Test channel	AVG Power Spectral Density (dBm/3kHz)			Limit (dBm)	Result
	Ant0	Ant1	Total		
Lowest	-3.87	-3.99	-0.92	7.99dBm/3kHz	PASS
Middle	-4.35	-4.47	-1.40	7.99dBm/3kHz	PASS
Highest	-3.93	-4.49	-1.19	7.99dBm/3kHz	PASS

Configuration IEEE 802.11n (HT20)/ Antenna 0, Antenna 1					
Test channel	AVG Power Spectral Density (dBm/3kHz)			Limit (dBm)	Result
	Ant0	Ant1	Total		
Lowest	-4.25	-3.73	-0.97	7.99dBm/3kHz	PASS
Middle	-4.25	-4.21	-1.22	7.99dBm/3kHz	PASS
Highest	-4.81	-5.91	-2.31	7.99dBm/3kHz	PASS

Configuration IEEE 802.11n (HT40)/ Antenna 0, Antenna 1					
Test channel	AVG Power Spectral Density (dBm/3kHz)			Limit (dBm)	Result
	Ant0	Ant1	Total		
Lowest	-7.15	-7.27	-4.20	7.99dBm/3kHz	PASS
Middle	-6.77	-6.27	-3.50	7.99dBm/3kHz	PASS
Highest	-7.89	-6.78	-4.29	7.99dBm/3kHz	PASS

**Note:**  $G_{ANT} = 3\text{dBi}$ ,  $\text{Array Gain} = 10\log(N_{ANT}/N_{SS}) = 3.01\text{dBi}$

$\text{Directional Gain} = G_{ANT} + \text{Array Gain} = 6.01\text{dBi}$ , So  $\text{limit} = 8 - (6.01 - 6) = 7.99\text{dBm/3kHz}$

Test plots as follows:  
Antenna 0:  
802.11b Modulation

Lowest channel

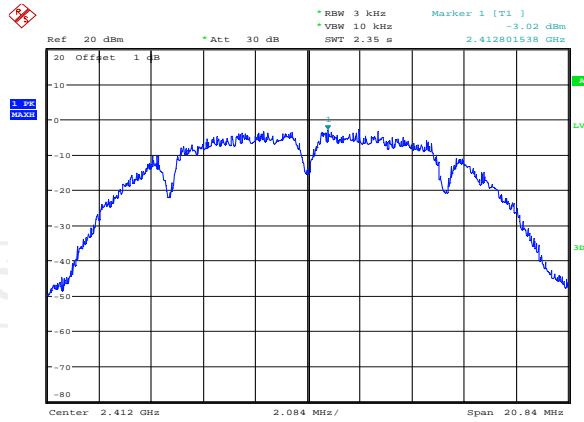

Date: 17.AUG.2016 23:01:34

Middle channel

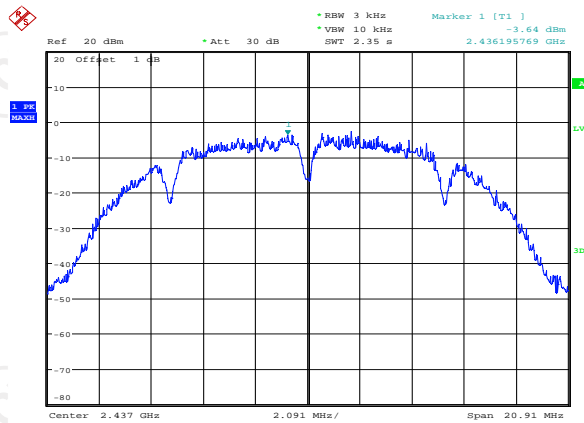

Date: 17.AUG.2016 23:06:16

Highest channel

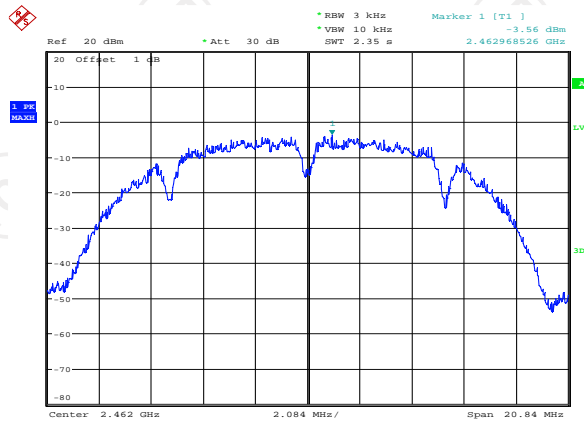

Date: 17.AUG.2016 23:05:24

## 802.11g Modulation

### Lowest channel

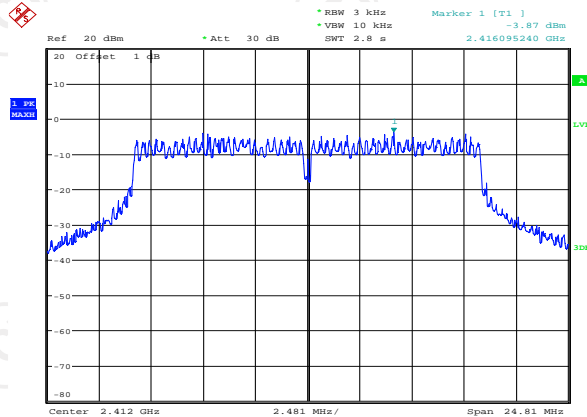

Date: 17.AUG.2016 22:14:30

### Middle channel

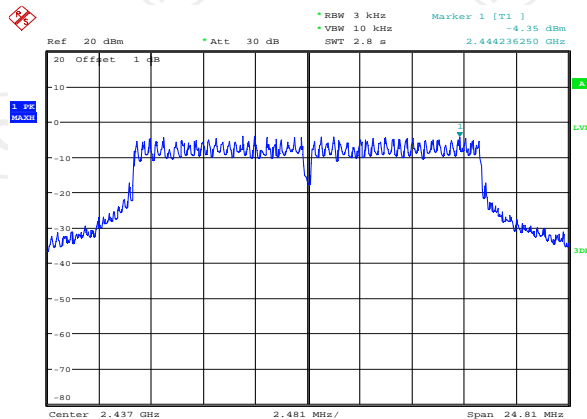

Date: 18.AUG.2016 16:18:20

### Highest channel

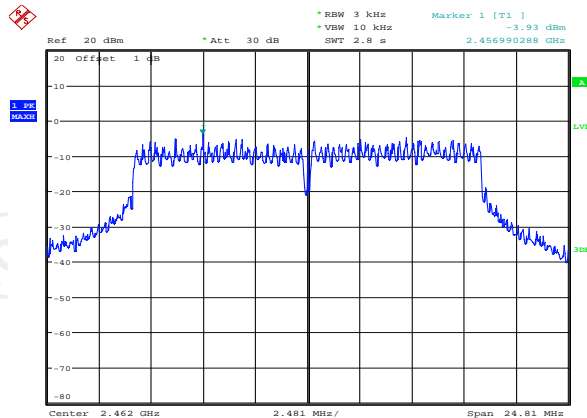

Date: 18.AUG.2016 16:20:00



## 802.11n (HT20) Modulation

### Lowest channel

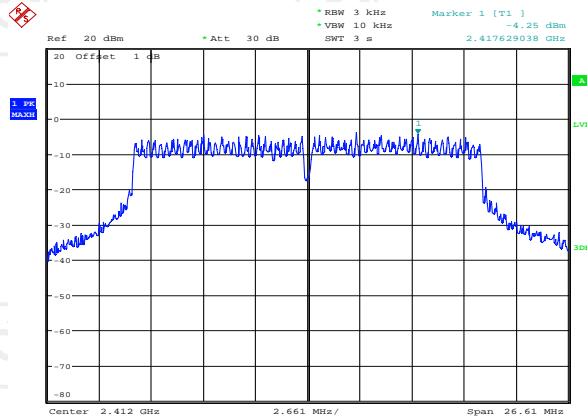

Date: 17.AUG.2016 22:27:20

### Middle channel

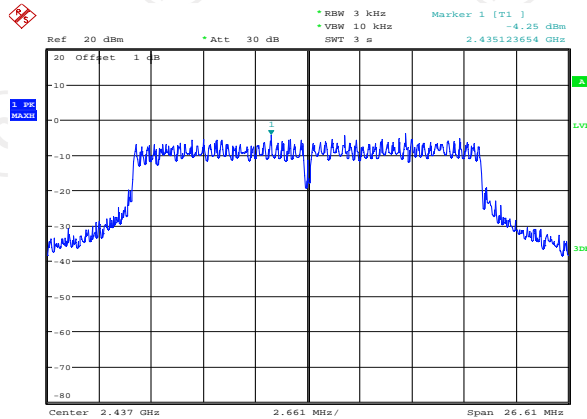

Date: 17.AUG.2016 22:43:57

### Highest channel

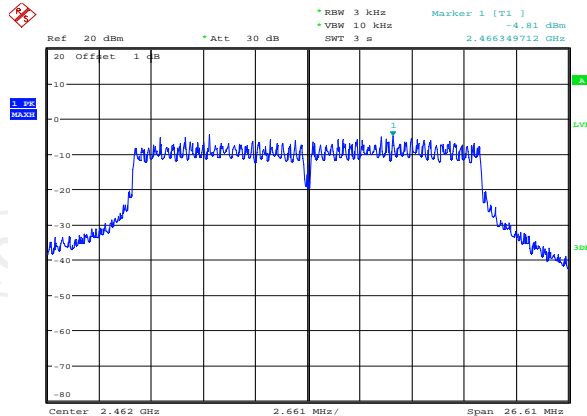

Date: 17.AUG.2016 22:47:10

## 802.11n (HT40) Modulation

### Lowest channel

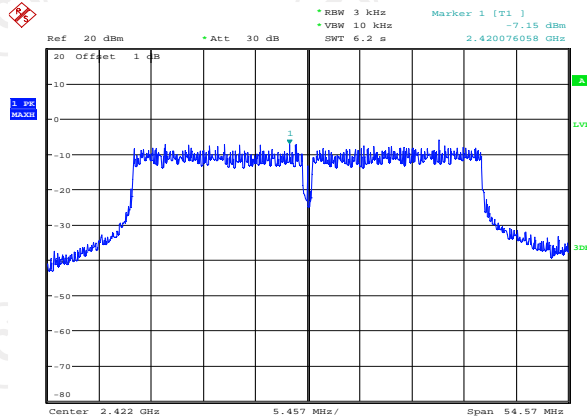

Date: 17.AUG.2016 22:49:57

### Middle channel

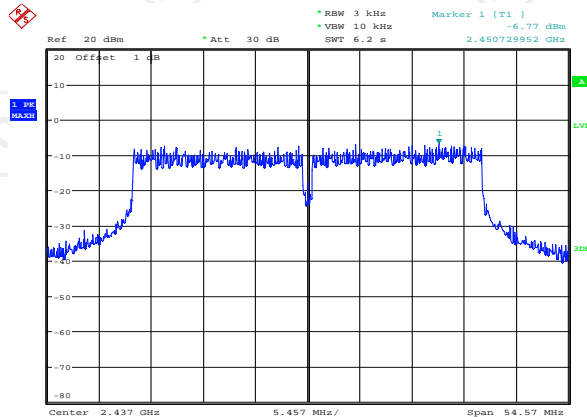

Date: 17.AUG.2016 22:52:58

### Highest channel

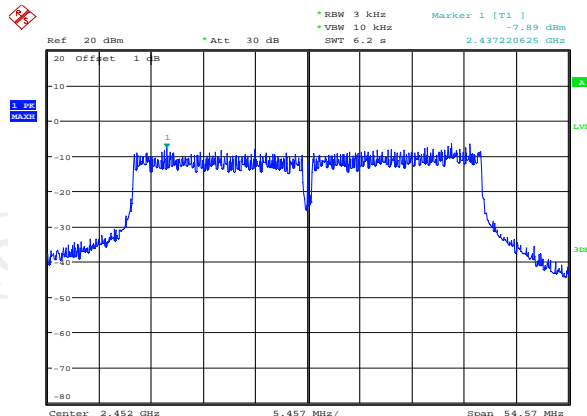

Date: 17.AUG.2016 22:58:42



## 802.11g Modulation

### Lowest channel

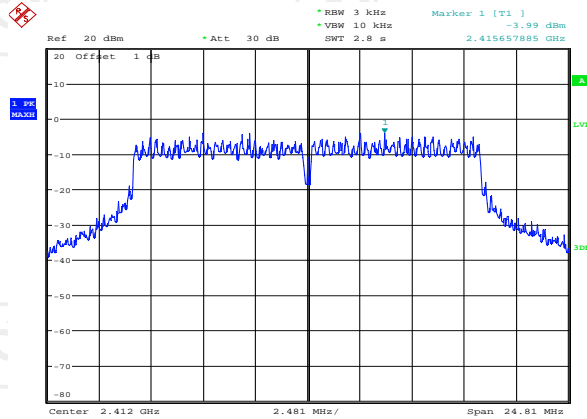

Date: 17.AUG.2016 22:14:50

### Middle channel

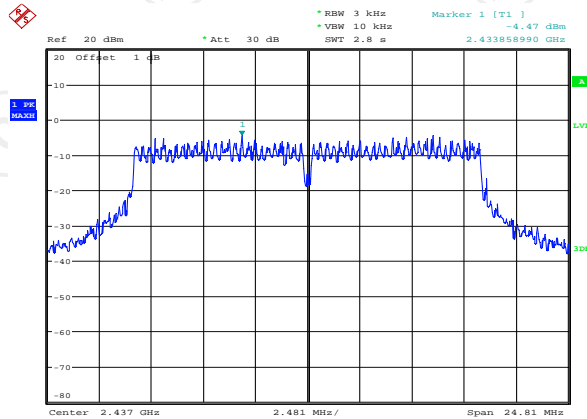

Date: 18.AUG.2016 16:18:33

### Highest channel

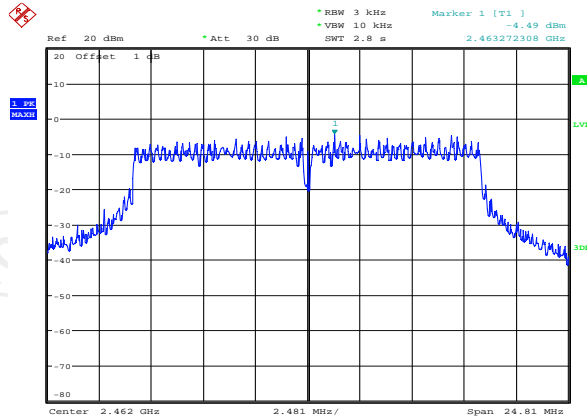

Date: 18.AUG.2016 16:20:13

## 802.11n (HT20) Modulation

### Lowest channel

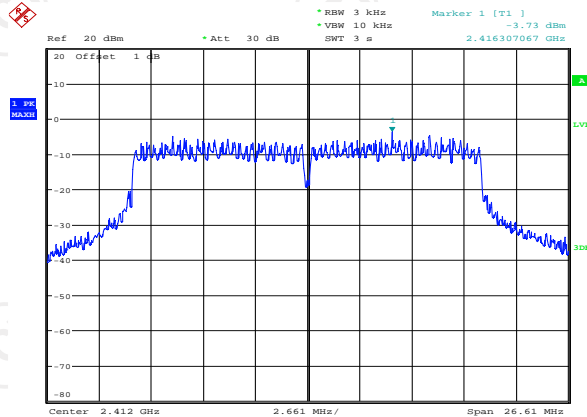

Date: 17.AUG.2016 22:27:33

### Middle channel

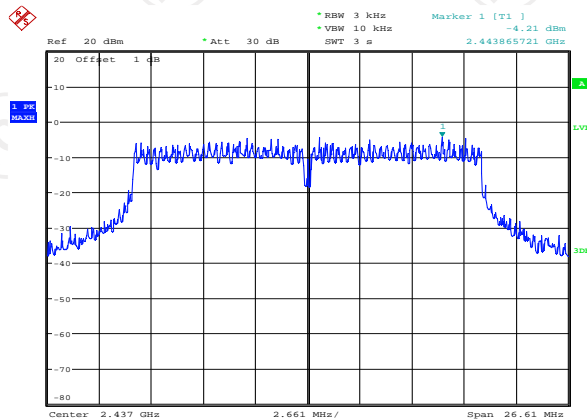

Date: 17.AUG.2016 22:44:11

### Highest channel

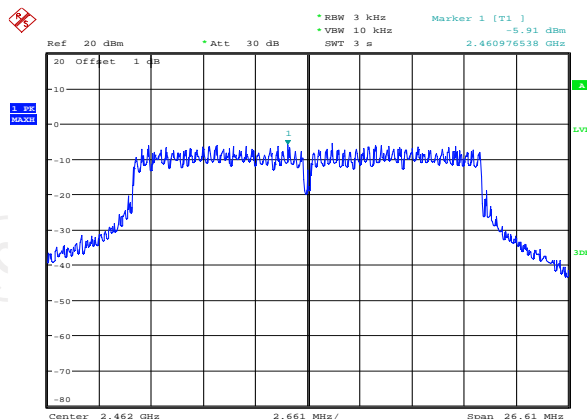

Date: 17.AUG.2016 22:47:58

802.11n (HT40) Modulation

Lowest channel

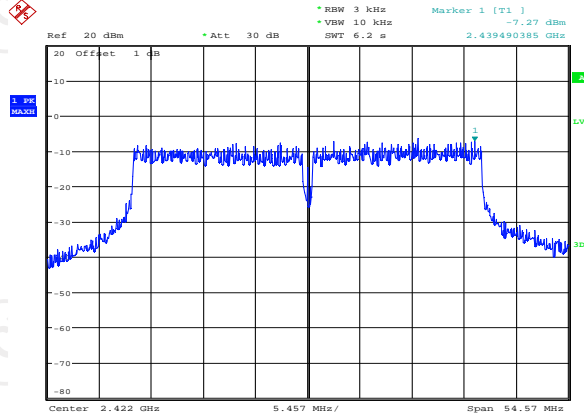

Date: 17.AUG.2016 22:50:14

Middle channel

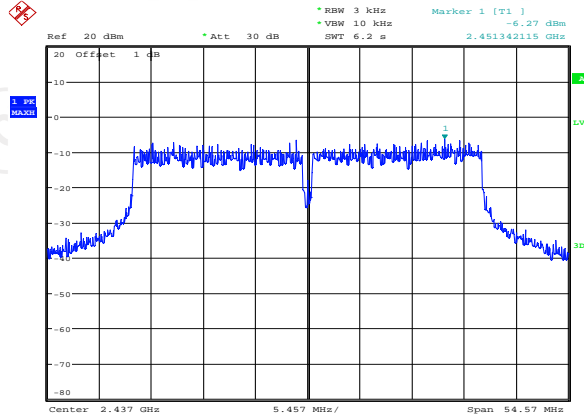

Date: 17.AUG.2016 22:53:15

Highest channel

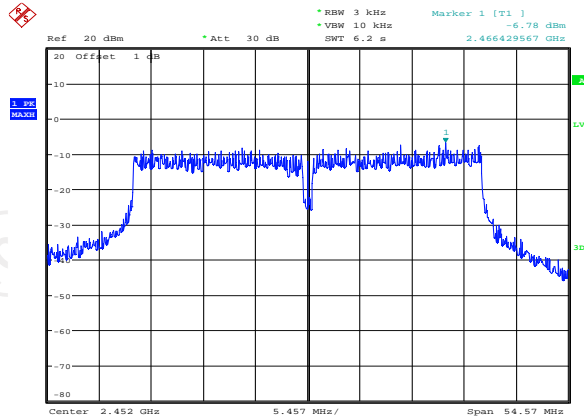

Date: 17.AUG.2016 22:58:53