



# FCC REPORT

**Report Reference No.**..... : **TRE1607012201** R/C.....:57823

**FCC ID**..... : **2AG7M-G1818A**

**Applicant's name**..... : **Tech Corp America**

**Address**..... : 5511 NW 112 AVE #106 BORAL FL 33178 USA

**Manufacturer**..... : GPLUS.TELECOM CO.,LIMITED

**Address**..... : Room 505-507,East Science And Technology Building, Keyuan Road Science And Technology Park,Nanshan,Shenzhen,China

**Test item description** ..... : Mobile Phone

**Trade Mark** ..... : BITCOM

**Model/Type reference**..... : G1818A

**Listed Model(s)** ..... : -

**Standard** ..... : **FCC Part 22: PUBLIC MOBILE SERVICES**  
**FCC Part 24:PERSONAL COMMUNICATIONS SERVICES**

**Date of receipt of test sample**.....: July 18, 2016

**Date of testing**.....: July 19, 2016– July 29, 2016

**Date of issue**.....: July 29, 2016

**Result**.....: **Pass**

Compiled by  
( position+printedname+signature)....: File administrators Shayne Zhu

Supervised by  
(position+printedname+signature)....: Project Engineer Lion Cai

Approved by  
(position+printedname+signature)....: Manager Hans Hu

**Testing Laboratory Name** ..... : **Shenzhen Huatongwei International Inspection Co., Ltd**

**Address**..... : 1/F, Bldg 3, Hongfa Hi-tech Industrial Park, Genyu Road, Tianliao, Gongming, Shenzhen, China

**Shenzhen Huatongwei International Inspection Co., Ltd. All rights reserved.**

This publication may be reproduced in whole or in part for non-commercial purposes as long as the Shenzhen Huatongwei International Inspection Co., Ltd is acknowledged as copyright owner and source of the material. Shenzhen Huatongwei International Inspection Co., Ltd takes no responsibility for and will not assume liability for damages resulting from the reader's interpretation of the reproduced material due to its placement and context.

## Contents

<b>1.</b>	<b><u>TEST STANDARDS AND TEST DESCRIPTION</u></b>	<b>3</b>
1.1.	Test Standards	3
1.2.	Test Description	3
<b>2.</b>	<b><u>SUMMARY</u></b>	<b>4</b>
2.1.	Client Information	4
2.2.	Product Description	4
2.3.	EUT operation mode	5
2.4.	EUT configuration	5
2.5.	Modifications	5
<b>3.</b>	<b><u>TEST ENVIRONMENT</u></b>	<b>6</b>
3.1.	Address of the test laboratory	6
3.2.	Test Facility	6
3.3.	Environmental conditions	7
3.4.	Statement of the measurement uncertainty	7
3.5.	Equipments Used during the Test	8
<b>4.</b>	<b><u>TEST CONDITIONS AND RESULTS</u></b>	<b>9</b>
4.1.	Conducted Output Power	9
4.2.	Occupancy Bandwidth	10
4.3.	Out of band emission at antenna terminals	13
4.4.	Band Edge compliance	15
4.5.	Radiated Power Measurement	17
4.6.	Radiated Spurious Emission	19
4.7.	Frequency stability V.S. Temperature measurement	23
4.8.	Frequency stability V.S. Voltage measurement	24
4.9.	Peak-Average Ratio	25
<b>5.</b>	<b><u>TEST SETUP PHOTOS OF THE EUT</u></b>	<b>26</b>
<b>6.</b>	<b><u>EXTERNAL AND INTERNAL PHOTOS OF THE EUT</u></b>	<b>27</b>

# 1. TEST STANDARDS AND TEST DESCRIPTION

## 1.1. Test Standards

The tests were performed according to following standards:

[FCC Part 22\(10-1-13 Edition\)](#):PRIVATE LAND MOBILE RADIO SERVICES.

[FCC Part 24\(10-1-13 Edition\)](#):PUBLIC MOBILE SERVICES

[TIA/EIA 603 D June 2010](#):Land Mobile FM or PM Communications Equipment Measurement and Performance Standards.

[47 CFR FCC Part 15 Subpart B](#): - Unintentional Radiators

[FCC Part 2](#):FREQUENCY ALLOCATIONS AND RADIO TREATY MATTERS; GENERAL RULES AND REGULATIONS

[971168 D01 Power Meas License Digital Systems v02r02](#): provides a methodology for fully characterizing the fundamental power of wideband (> 1 MHz) digitally modulated RF signals acceptable to the FCC for demonstrating compliance for licensed transmitters.

[ANSI C63.10-2013](#):AmericanNationalStandardforTestingUnlicensedWirelessDevices

## 1.2. Test Description

Test Item	Section in CFR 47	Result
RF Output Power	Part 2.1046 Part 22.913 (a)(2) Part 24.232 (c)	Pass
Modulation Characteristics	Part 2.1047	Pass
99% & -26 dB Occupied Bandwidth	Part 2.1049 Part 22.917 Part 24.238	Pass
Spurious Emissions at Antenna Terminal	Part 2.1051 Part 22.917 (a) Part 24.238 (a)	Pass
Field Strength of Spurious Radiation	Part 2.1053 Part 22.917 (a) Part 24.238 (a)	Pass
Out of band emission, Band Edge	Part 22.917 (a) Part 24.238 (a)	Pass
Frequency stability vs. temperature	Part 2.1055(a)(1)(b)	Pass
Frequency stability vs. voltage	Part 2.1055(d)(1)(2)	Pass
Peak-Average Ratio	Part 24.232 (d)	Pass

Remark: The measurement uncertainty is not included in the test result.

## 2. SUMMARY

### 2.1. Client Information

Applicant:	Tech Corp America
Address:	5511 NW 112 AVE #106 BORAL FL 33178 USA
Manufacturer:	GPLUS.TELECOM CO.,LIMITED
Address:	Room 505-507,East Science And Technology Building, Keyuan Road Science And Technology Park,Nanshan,Shenzhen,China

### 2.2. Product Description

Name of EUT	Mobile Phone
Trade Mark:	BITCOM
Model No.:	G1818A
Listed Model(s):	-
IMEI 1:	352273017386340
IMEI 2:	352751019523267
Power supply:	DC 3.7V From internal battery
Adapter information:	Model: G1818A Input: 100-240Va.c.,50-60Hz,0.2A Output:5.0Vd.c.,500mA
<b>2G:</b>	
Support Network:	GSM, GPRS,
Support Band:	GSM850, DCS1900
Modulation:	GSM/GPRS: GMSK
Transmit Frequency:	GSM850: 824.20MHz-848.80MHz PCS1900: 1850.20MHz-1909.80MHz
Receive Frequency:	GSM850: 869.20MHz-893.80MHz PCS1900: 1930.20MHz-1989.80MHz
GPRS Class:	12
Antenna type:	Intergal Antenna
Antenna gain:	GSM850:0.8dBi PCS1900:0.8dBi
Hardware version:	F61_MB_V1.0_20160422
Software version:	F61_MB_V1.0

Test Frequency:

GSM 850		PCS1900	
Channel	Frequency (MHz)	Channel	Frequency (MHz)
128	824.20	512	1850.20
190	836.60	661	1880.00
251	848.80	810	1909.80

### 2.3. EUT operation mode

1.The EUT has been tested under typical operating condition. The Applicant provided software to control the EUT for staying in continuous transmitting and receiving mode for testing.

### 2.4. EUT configuration

**The following peripheral devices and interface cables were connected during the measurement:**

● - supplied by the manufacturer

○ - supplied by the lab

	Length (m) :	/
	Shield :	/
	Detachable :	/
	Manufacturer :	/
	Model No. :	/

### 2.5. Modifications

No modifications were implemented to meet testing criteria.

### **3. TEST ENVIRONMENT**

#### **3.1. Address of the test laboratory**

Laboratory: Shenzhen Huatongwei International Inspection Co., Ltd.

Address: 1/F, Bldg 3, Hongfa Hi-tech Industrial Park, Genyu Road, Tianliao, Gongming, Shenzhen, China

Phone: 86-755-26748019 Fax: 86-755-26748089

#### **3.2. Test Facility**

The test facility is recognized, certified, or accredited by the following organizations:

##### **CNAS-Lab Code: L1225**

Shenzhen Huatongwei International Inspection Co., Ltd. has been assessed and proved to be in compliance with CNAS-CL01 Accreditation Criteria for Testing and Calibration Laboratories (identical to ISO/IEC17025: 2005 General Requirements) for the Competence of Testing and Calibration Laboratories, Date of Registration: February 28, 2015. Valid time is until February 27, 2018.

##### **A2LA-Lab Cert. No. 3902.01**

Shenzhen Huatongwei International Inspection Co., Ltd. EMC Laboratory has been accredited by A2LA for technical competence in the field of electrical testing, and proved to be in compliance with ISO/IEC 17025: 2005 General Requirements for the Competence of Testing and Calibration Laboratories and any additional program requirements in the identified field of testing. Valid time is until December 31, 2016.

##### **FCC-Registration No.: 317478**

Shenzhen Huatongwei International Inspection Co., Ltd. EMC Laboratory has been registered and fully described in a report filed with the FCC (Federal Communications Commission). The acceptance letter from the FCC is maintained in our files. Registration 317478, Renewal date Jul. 18, 2014, valid time is until Jul. 18, 2017.

##### **IC-Registration No.: 5377A&5377B**

The 3m Alternate Test Site of Shenzhen Huatongwei International Inspection Co., Ltd. has been registered by Certification and Engineering Bureau of Industry Canada for the performance of radiated measurements with Registration No. 5377A on Dec. 31, 2013, valid time is until Dec. 31, 2016.

Two 3m Alternate Test Site of Shenzhen Huatongwei International Inspection Co., Ltd. has been registered by Certification and Engineering Bureau of Industry Canada for the performance of radiated measurements with Registration No. 5377B on Dec.03, 2014, valid time is until Dec.03, 2017.

##### **ACA**

Shenzhen Huatongwei International Inspection Co., Ltd. EMC Laboratory can also perform testing for the Australian C-Tick mark as a result of our A2LA accreditation.

##### **VCCI**

The 3m Semi-

anechoic chamber (12.2m×7.95m×6.7m) of Shenzhen Huatongwei International Inspection Co., Ltd.

has been registered in accordance with the Regulations for Voluntary Control Measures with Registration No.: R-2484. Date of Registration: Dec. 20, 2012. Valid time is until Dec. 29, 2015.

Radiated disturbance above 1GHz measurement of Shenzhen Huatongwei International Inspection Co., Ltd. has been registered in accordance with the Regulations for Voluntary Control Measures with Registration No.: G-292. Date of Registration: Dec. 24, 2013. Valid time is until Dec. 23, 2016.

Main Ports Conducted Interference Measurement of Shenzhen Huatongwei International Inspection Co., Ltd. has been registered in accordance with the Regulations for Voluntary Control Measures with Registration No.: C-2726. Date of Registration: Dec. 20, 2012. Valid time is until Dec. 19, 2015.

Telecommunication Ports Conducted Interference Measurement of Shenzhen Huatongwei International Inspection Co., Ltd. has been registered in accordance with the Regulations for Voluntary Control Measures with Registration No.: T-1837. Date of Registration: May 07, 2013. Valid time is until May 06, 2016.

##### **DNV**

Shenzhen Huatongwei International Inspection Co., Ltd. has been found to comply with the requirements of DNV towards subcontractor of EMC and safety testing services in conjunction with the EMC and Low voltage Directives and in the voluntary field. The acceptance is based on a formal quality Audit and follow-ups according to relevant parts of ISO/IEC Guide 17025 (2005), in accordance with the requirements of the DNV Laboratory Quality Manual towards subcontractors. Valid time is until Aug. 24, 2016.

### 3.3. Environmental conditions

During the measurement the environmental conditions were within the listed ranges:

Normal Temperature/Tnor:	15~35°C
Relative Humidity	30~60 %
Air Pressure	950-1050 hPa

### 3.4. Statement of the measurement uncertainty

The data and results referenced in this document are true and accurate. The reader is cautioned that there may be errors within the calibration limits of the equipment and facilities. The measurement uncertainty was calculated for all measurements listed in this test report acc. to TR-100028-01 "Electromagnetic compatibility and Radio spectrum Matters (ERM); Uncertainties in the measurement of mobile radio equipment characteristics; Part 1" and TR-100028-02 "Electromagnetic compatibility and Radio spectrum Matters (ERM); Uncertainties in the measurement of mobile radio equipment characteristics; Part 2" and is documented in the Shenzhen Huatongwei International Inspection Co., Ltd quality system acc. to DIN EN ISO/IEC 17025. Furthermore, component and process variability of devices similar to that tested may result in additional deviation. The manufacturer has the sole responsibility of continued compliance of the device.

Hereafter the best measurement capability for Shenzhen Huatongwei laboratory is reported:

Test Items	Measurement Uncertainty	Notes
Frequency stability	25 Hz	(1)
Transmitter power conducted	0.57 dB	(1)
Transmitter power Radiated	2.20 dB	(1)
Conducted spurious emission 9KHz-12.75 GHz	1.60 dB	(1)
Conducted Emission 9KHz-30MHz	3.39 dB	(1)
Radiated Emission 30~1000MHz	4.24 dB	(1)
Radiated Emission 1~18GHz	5.16 dB	(1)
Radiated Emission 18-40GHz	5.54 dB	(1)
Occupied Bandwidth	-----	(1)
Emission Mask	-----	(1)
Modulation Characteristic	-----	(1)
Transmitter Frequency Behavior	-----	(1)

(1) This uncertainty represents an expanded uncertainty expressed at approximately the 95% confidence level using a coverage factor of  $k=1.96$ .

### 3.5. Equipments Used during the Test

<b>Output Power(Conducted) &amp;Occupied Bandwidth&amp;Emission Bandwidth&amp;Band Edge Compliance&amp;Conducted Spurious Emission</b>					
No.	Equipment	Manufacturer	Model No.	SerialNo.	Last Cal.
1	UNIVERSAL RADIO COMMUNICATION	Rohde&Schwarz	CMU200	112012	2015/11/2
2	Spectrum Analyzer	Rohde&Schwarz	FSU26	201141	2015/11/2
3	Splitter	Mini-Circuit	ZAPD-4	400059	2015/11/2

<b>Frequency Stability</b>					
No.	Equipment	Manufacturer	Model No.	SerialNo.	Last Cal.
1	UNIVERSAL RADIO COMMUNICATION	Rohde&Schwarz	CMU200	112012	2015/11/2
2	Spectrum Analyzer	Rohde&Schwarz	FSU26	201141	2015/11/2
3	Climate Chamber	ESPEC	EL-10KA	05107008	2015/11/2
4	Splitter	Mini-Circuit	ZAPD-4	400059	2015/11/2

<b>Output Power (Radiated) &amp;Radiated Spurious Emission</b>					
No.	Equipment	Manufacturer	Model No.	SerialNo.	Last Cal.
1	UNIVERSAL RADIO COMMUNICATION	Rohde&Schwarz	CMU200	112012	2015/11/2
2	Spectrum Analyzer	Rohde&Schwarz	FSU26	201141	2015/11/2
3	HORNANTENNA	ShwarzBeck	9120D	1012	2015/11/2
4	HORNANTENNA	ShwarzBeck	9120D	1011	2015/11/2
5	Ultra-Broadband Antenna	ShwarzBeck	VULB9163	538	2015/11/2
6	Ultra-Broadband Antenna	ShwarzBeck	VULB9163	539	2015/11/2
7	TURNTABLE	MATURO	TT2.0	----	N/A
8	ANTENNA MAST	MATURO	TAM-4.0-P	----	N/A
9	EMI Test Software	Audix	E3	N/A	N/A
10	EMI Test Receiver	Rohde&Schwarz	ESIB 26	100009	2015/11/2
11	RF Test Panel	Rohde&Schwarz	TS / RSP	335015/ 0017	2015/11/2
12	High pass filter	Compliance Direction systems	BSU-6	34202	2015/11/2
13	Splitter	Mini-Circuit	ZAPD-4	400059	2015/11/2
14	Horn Antenna	SCHWARZBECK	BBHA9170	25841	2015/11/2
15	Horn Antenna	SCHWARZBECK	BBHA9170	25842	2015/11/2
16	Preamplifier	ShwarzBeck	BBV 9718	BBV 9718	2015/11/2
17	Broadband Preamplifier	ShwarzBeck	BBV743	9743-0079	2015/11/2
18	Signal Generator	Rohde&Schwarz	SMF100A	101932	2015/11/2
19	Amplifer	Compliance Direction systems	PAP1-4060	120	2015/11/2
20	TURNTABLE	ETS	2088	2149	2015/11/2
21	ANTENNA MAST	ETS	2075	2346	2015/11/2
22	HORNANTENNA	Rohde&Schwarz	HF906	100068	2015/11/2
23	HORNANTENNA	Rohde&Schwarz	HF906	100039	2015/11/2

The calibration interval was one year.



## 4. TEST CONDITIONS AND RESULTS

### 4.1. Conducted Output Power

#### TEST CONFIGURATION

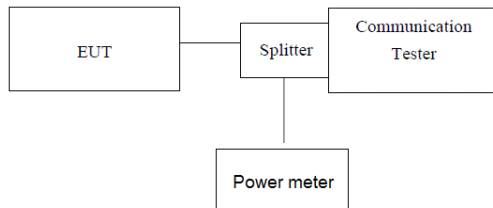

*Note: Measurement setup for testing on Antenna connector*

#### TEST PROCEDURE

1. The transmitter output port was connected to base station.
2. The RF output of EUT was connected to the power meter by RF cable and attenuator, the path loss was compensated to the results for each measurement.
3. Set EUT at maximum power through base station.
4. Select lowest, middle, and highest channels for each band and different modulation.
5. Measure the maximum burst average power.

#### TEST RESULTS

EUT Mode	Channel	Frequency (MHz)	Power (dBm)
GSM 850 (GMSK)	128	824.2	31.70
	190	836.6	31.51
	251	848.8	31.43
GPRS850 (GMSK,1Slot)	128	824.2	31.39
	190	836.6	31.41
	251	848.8	31.30
PCS1900 (GMSK)	512	1850.2	28.86
	661	1880	28.75
	810	1909.8	28.50
GPRS1900 (GMSK,1Slot)	512	1850.2	28.01
	661	1880	26.86
	810	1909.8	27.06

## 4.2. Occupy Bandwidth

### TEST CONFIGURATION

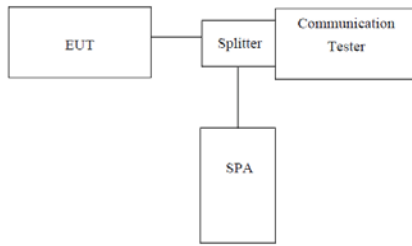

*Note: Measurement setup for testing on Antenna connector*

### TEST PROCEDURE

1. The EUT's output RF connector was connected with a short cable to the spectrum analyzer
2. RBW was set to about 1% of emission BW, VBW= 3 times RBW.
3. -26dBc display line was placed on the screen (or 99% bandwidth), the occupied bandwidth is the delta frequency between the two points where the display line intersects the signal trace.

### TEST RESULTS

EUT Mode	Channel	Frequency (MHz)	99% Occupy bandwidth (KHz)	-26dB bandwidth (KHz)
GSM 850 (GMSK)	128	824.20	243.13	321.30
	190	836.60	243.13	321.27
	251	848.80	243.13	315.50
GPRS850 (GMSK, 1Slot)	128	824.20	243.00	318.07
	190	836.60	241.00	326.30
	251	848.80	243.00	319.97
PCS1900 (GMSK)	512	1850.20	242.00	318.20
	661	1880.00	243.00	321.52
	810	1909.80	244.00	319.20
GPRS1900 (GMSK, 1Slot)	512	1850.20	242.00	323.00
	661	1880.00	242.00	322.80
	810	1909.80	243.00	321.30

GSM850 For GMSK Modulation

99% Occupy bandwidth & -26dB bandwidth

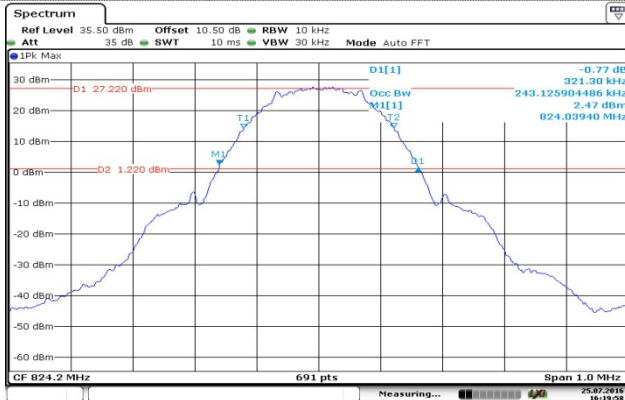

Channel 128

99% Occupy bandwidth & -26dB bandwidth

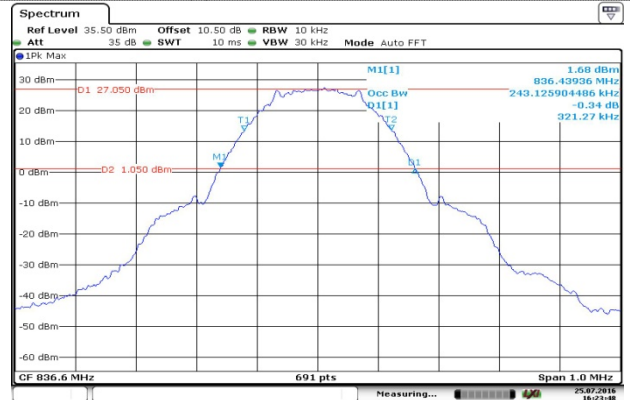

Channel 190

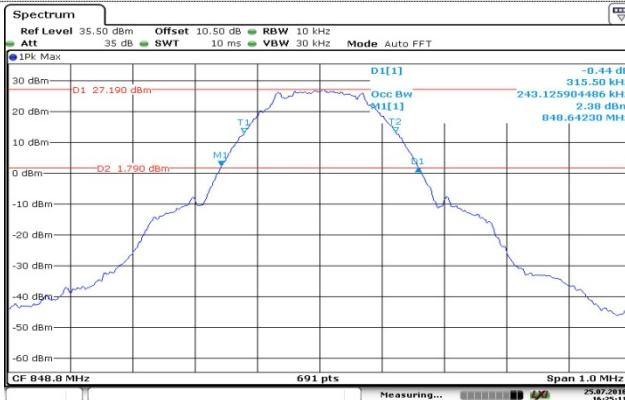

Channel 251

GPRS850 For GMSK Modulation

99% Occupy bandwidth & -26dB bandwidth

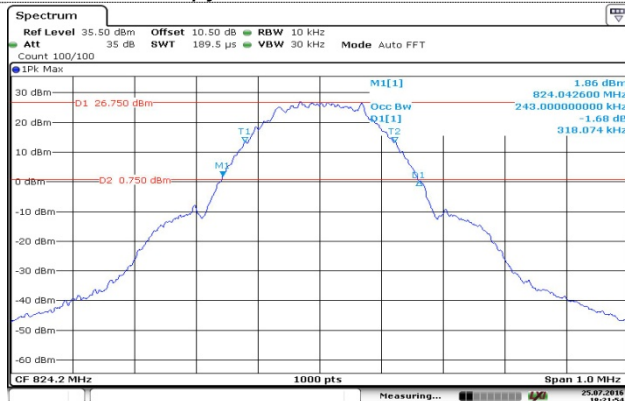

Channel 128

99% Occupy bandwidth & -26dB bandwidth

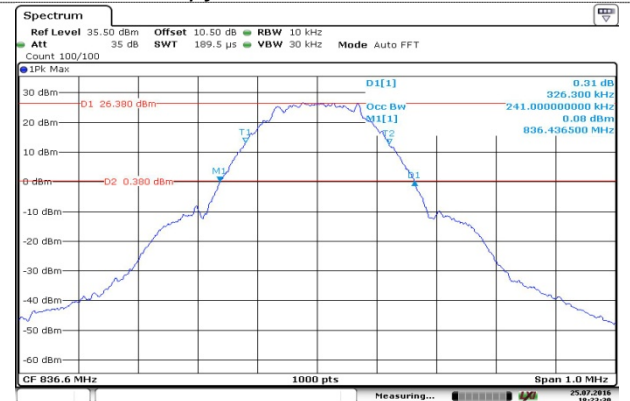

Channel 190

99% Occupy bandwidth & -26dB bandwidth

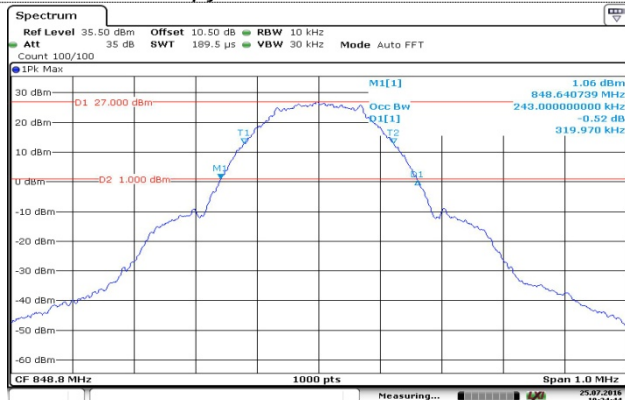

Channel 251

99% Occupy bandwidth & -26dB bandwidth

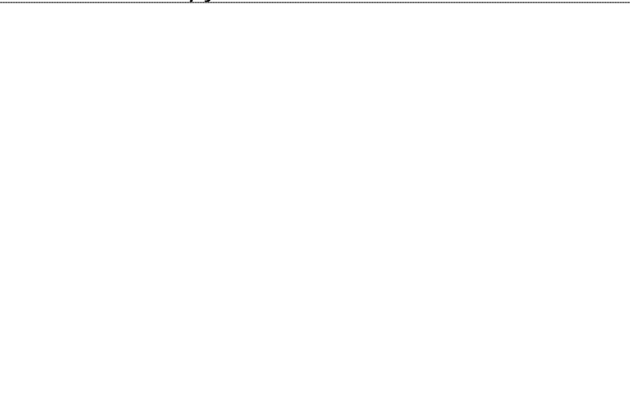

PCS1900 For GMSK Moudlation

99% Occupy bandwidth&-26dB bandwidth

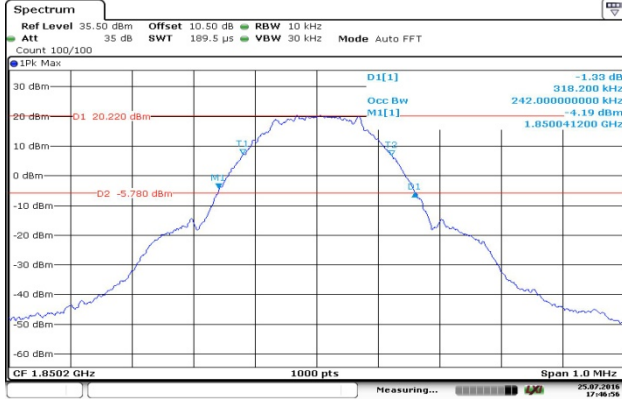

Channel 512

99% Occupy bandwidth&-26dB bandwidth

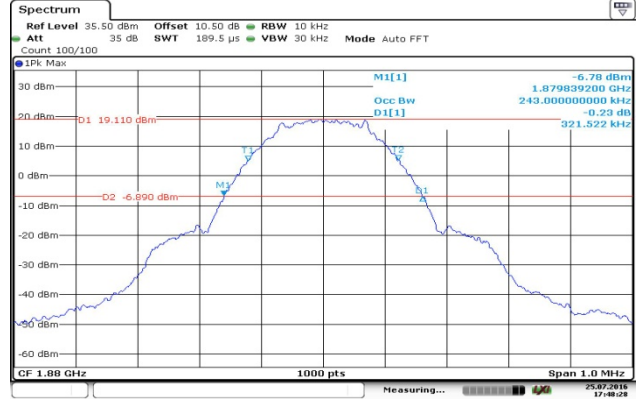

Channel 661

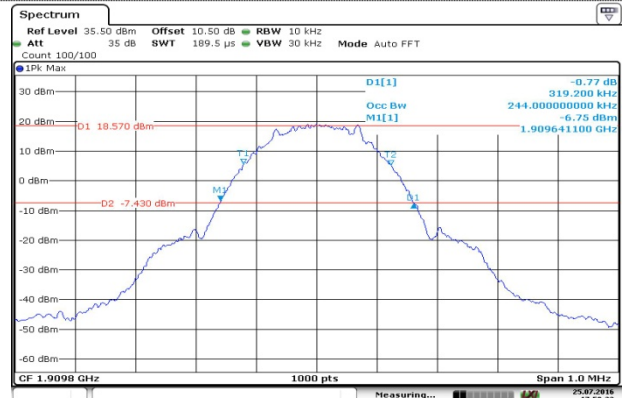

Channel 810

GPRS1900 For GMSK Moudlation

99% Occupy bandwidth&-26dB bandwidth

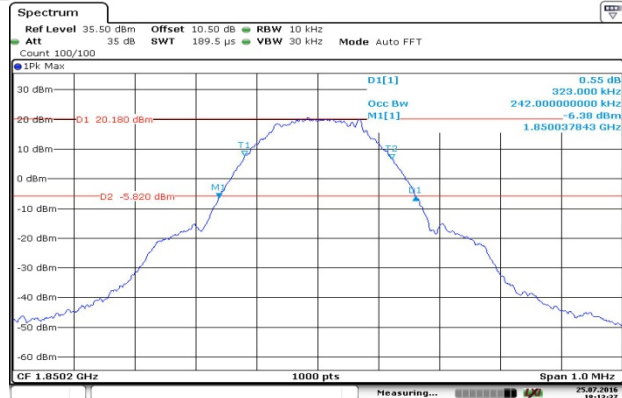

Channel 512

99% Occupy bandwidth&-26dB bandwidth

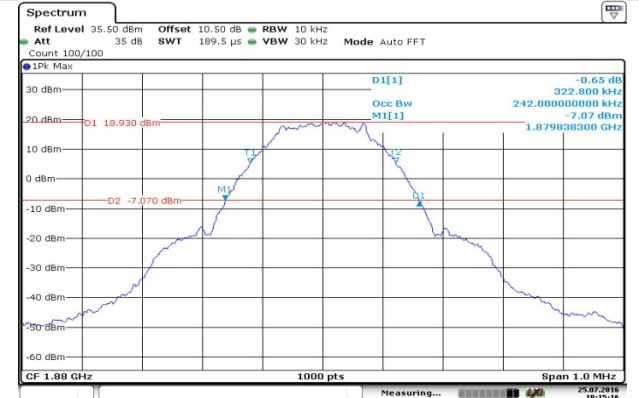

Channel 661

99% Occupy bandwidth&-26dB bandwidth

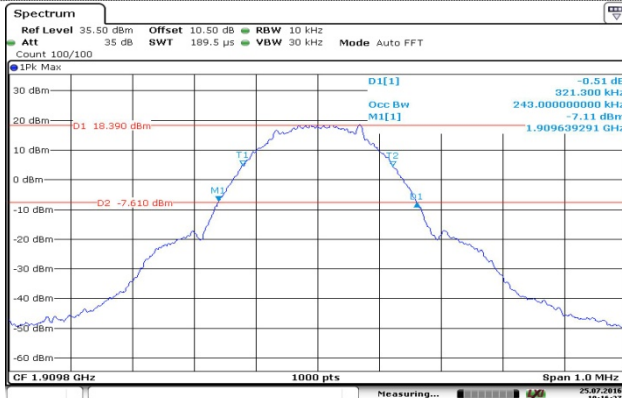

Channel 810

99% Occupy bandwidth&-26dB bandwidth

### 4.3. Out of band emission at antenna terminals

#### LIMIT

Part 24.238 and Part 22.917 specify that the power of any emission outside of the authorized operating frequency ranges must be attenuated below the transmitting power (P) by a factor of at least  $43 + 10 \log(P)$  dB.

The specification that emissions shall be attenuated below the transmitter power (P) by at least  $43 + 10 \log(P)$  dB, translates in the relevant power range (1 to 0.001 W) to -13 dBm. At 1 W the specified minimum attenuation becomes 43 dB and relative to a 30 dBm (1 W) carrier becomes a limit of -13 dBm. At 0.001 W (0 dBm) the minimum attenuation is 13 dB, which again yields a limit of -13 dBm. In this way a translation of the specification from relative to absolute terms is carried out.

#### TEST CONFIGURATION

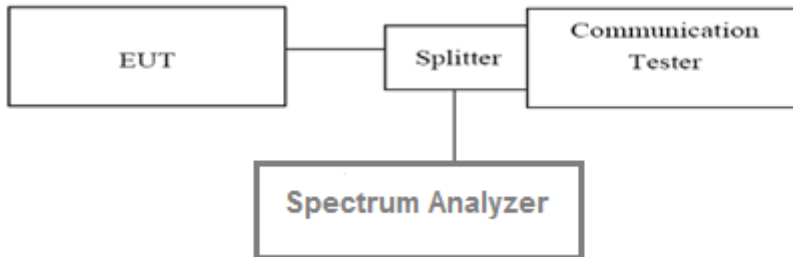

#### TEST PROCEDURE

1. The RF output of the transceiver was connected to a spectrum analyzer through appropriate attenuation.
2. The resolution bandwidth of the spectrum analyzer was set at 1MHz, sufficient scans were taken to show the out of band Emissions if any up to 10th harmonic.
3. For the out of band: Set the RBW= 1MHz, VBW = 3MHz, Start=30MHz, Stop= 10th harmonic.

#### TEST RESULTS

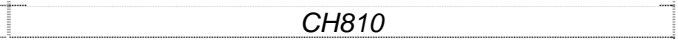
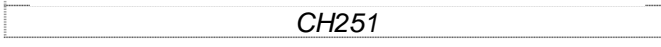
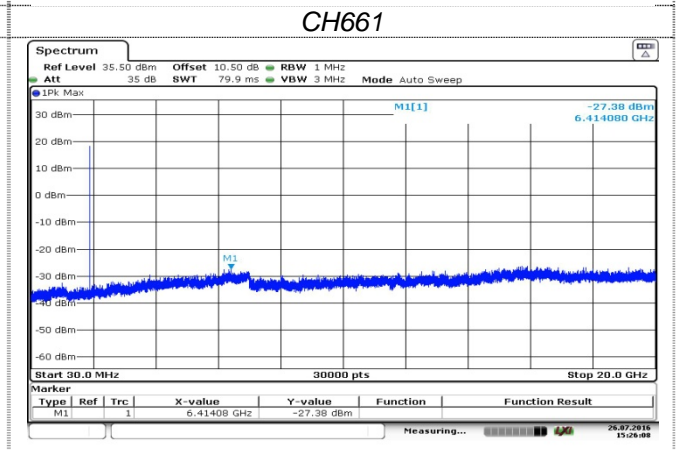
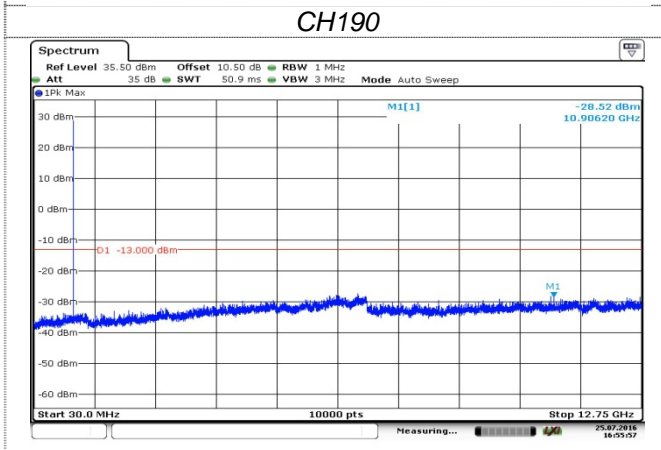
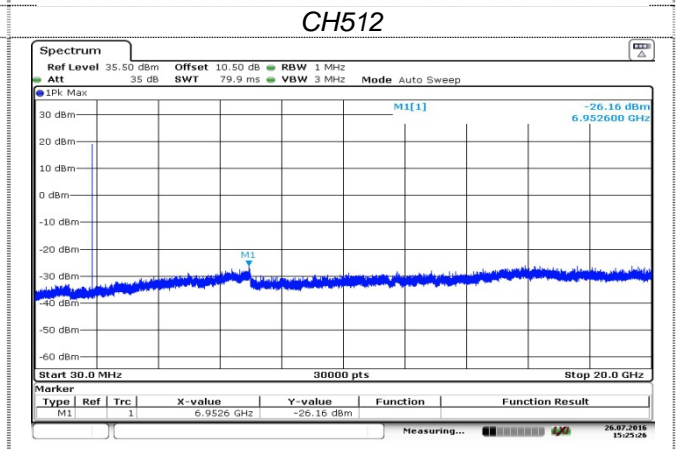
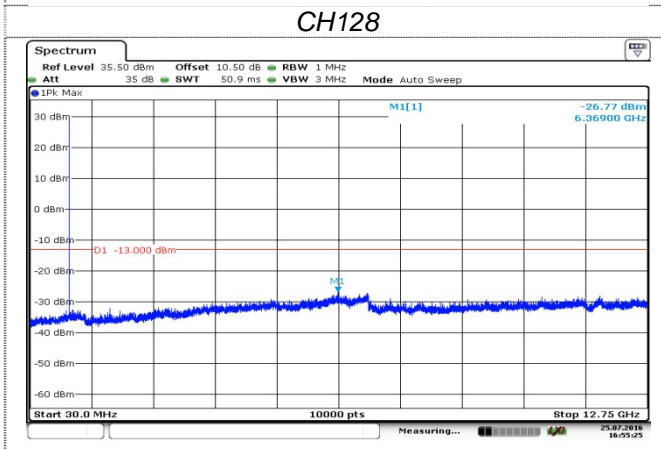
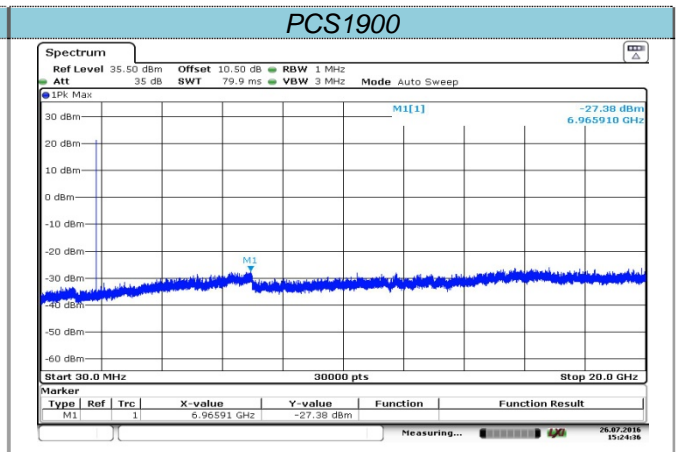
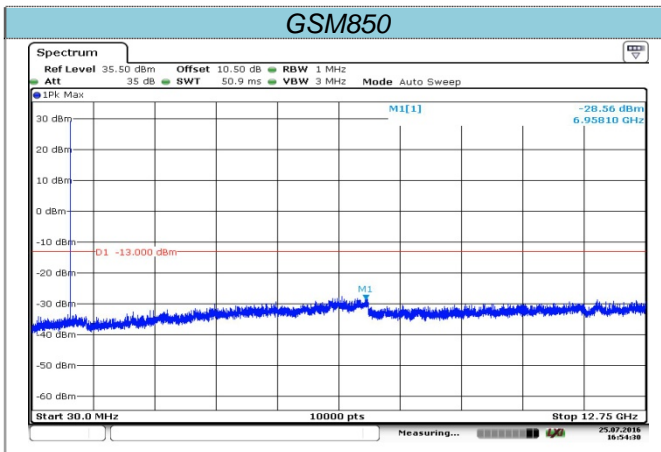

### 4.4. Band Edge compliance

#### LIMIT

Part 24.238 and Part 22.917 specify that the power of any emission outside of the authorized operating frequency ranges must be attenuated below the transmitting power (P) by a factor of at least  $43 + 10 \log(P)$  dB.

The specification that emissions shall be attenuated below the transmitter power (P) by at least  $43 + 10 \log(P)$  dB, translates in the relevant power range (1 to 0.001 W) to -13 dBm. At 1 W the specified minimum attenuation becomes 43 dB and relative to a 30 dBm (1 W) carrier becomes a limit of -13 dBm. At 0.001 W (0 dBm) the minimum attenuation is 13 dB, which again yields a limit of -13 dBm. In this way a translation of the specification from relative to absolute terms is carried out.

#### TEST CONFIGURATION

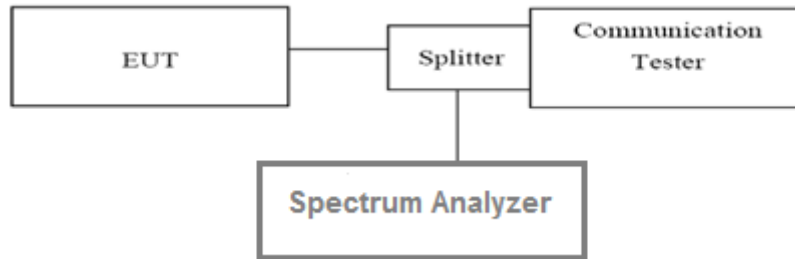

#### TEST PROCEDURE

1. The RF output of the transceiver was connected to a spectrum analyzer through appropriate attenuation.
2. For the bandedge: 2G:Set the RBW=3KHz, VBW = 10KHz, Sweep time= Auto

#### TEST RESULTS

GSM850					
Channel Number	Frequency (MHz)	Measurement Results		Limit (dBm)	Verdict
		Frequency(MHz)	Values(dBm)		
128	824.20	823.9957	-16.38	-13.00	Pass
251	848.80	849.0039	-15.94	-13.00	Pass

GPRS850					
Channel Number	Frequency (MHz)	Measurement Results		Limit (dBm)	Verdict
		Frequency(MHz)	Values(dBm)		
128	824.20	823.9972	-16.18	-13.00	Pass
251	848.80	849.0216	-18.47	-13.00	Pass

PCS1900					
Channel Number	Frequency (MHz)	Measurement Results		Limit (dBm)	Verdict
		Frequency(MHz)	Values(dBm)		
512	1850.20	1849.9967	-19.48	-13.00	Pass
810	1909.80	1910.0207	-22.60	-13.00	Pass

GPRS1900					
Channel Number	Frequency (MHz)	Measurement Results		Limit (dBm)	Verdict
		Frequency(MHz)	Values(dBm)		
512	1850.20	1849.9967	-20.30	-13.00	Pass
810	1909.80	1910.0024	-22.37	-13.00	Pass



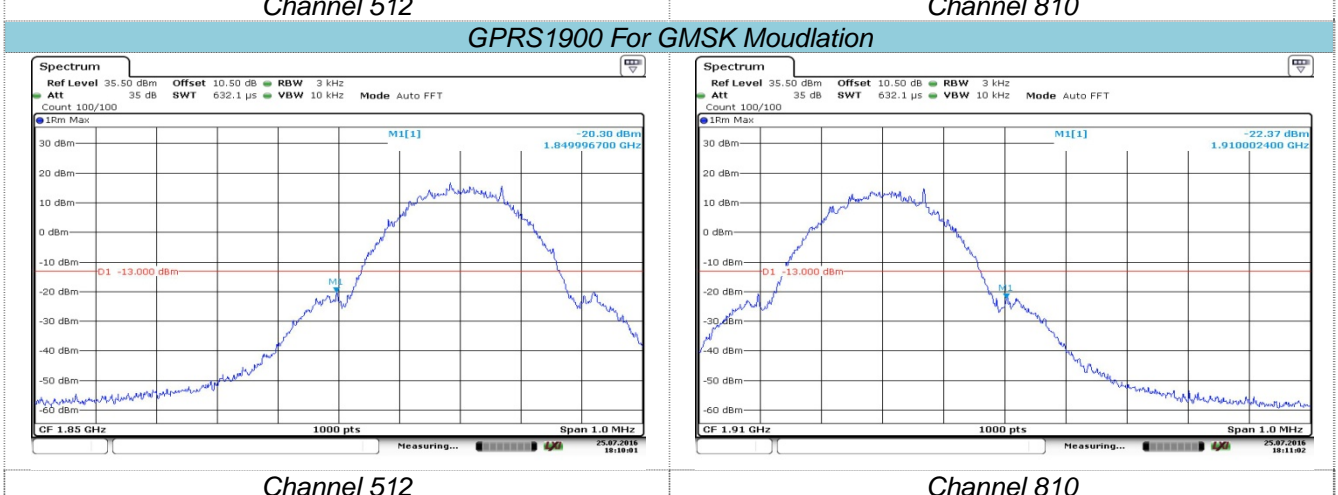
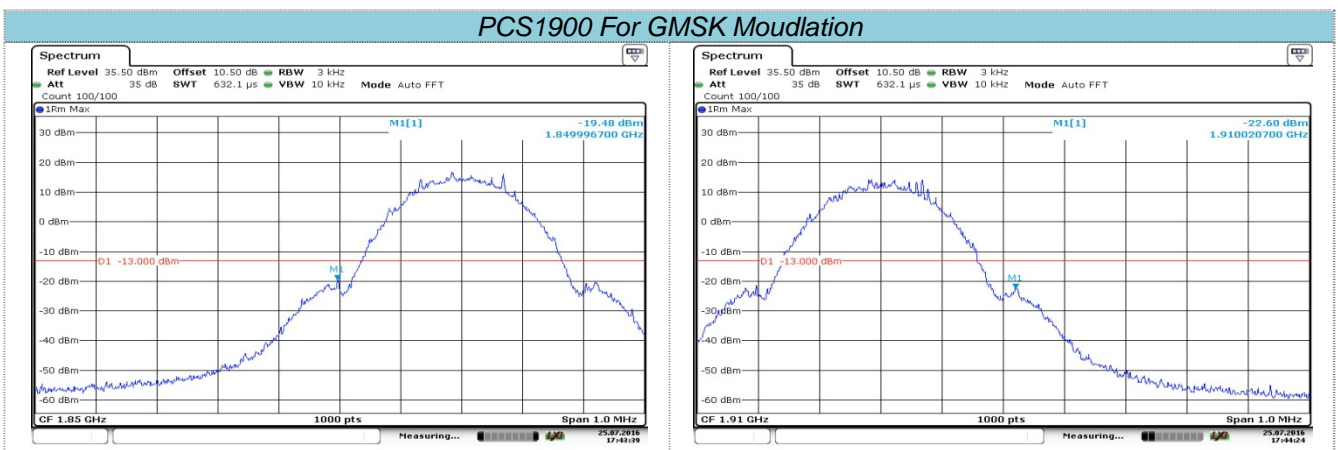
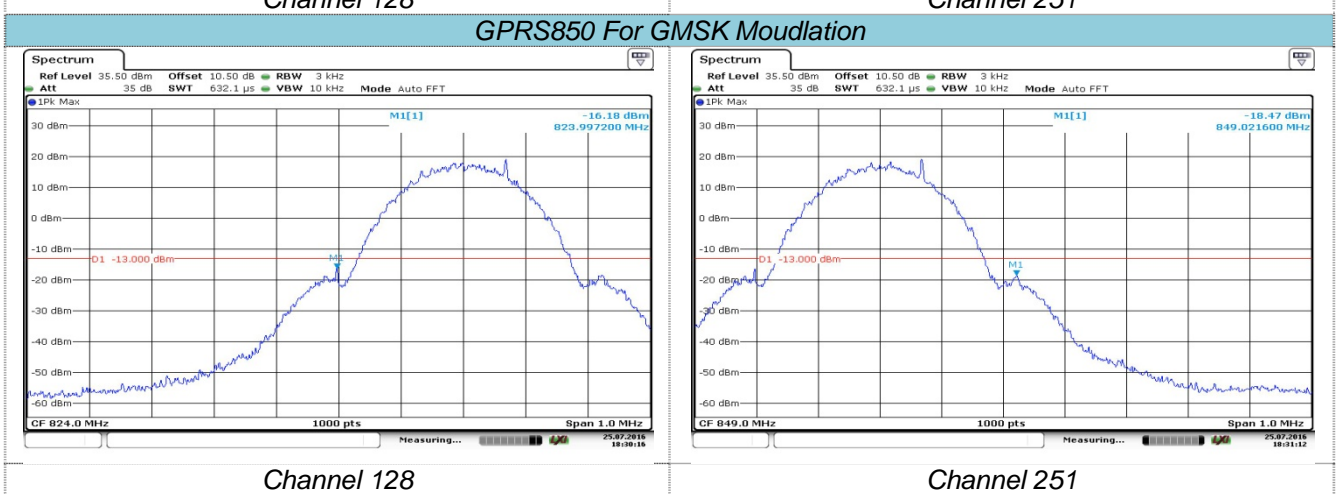
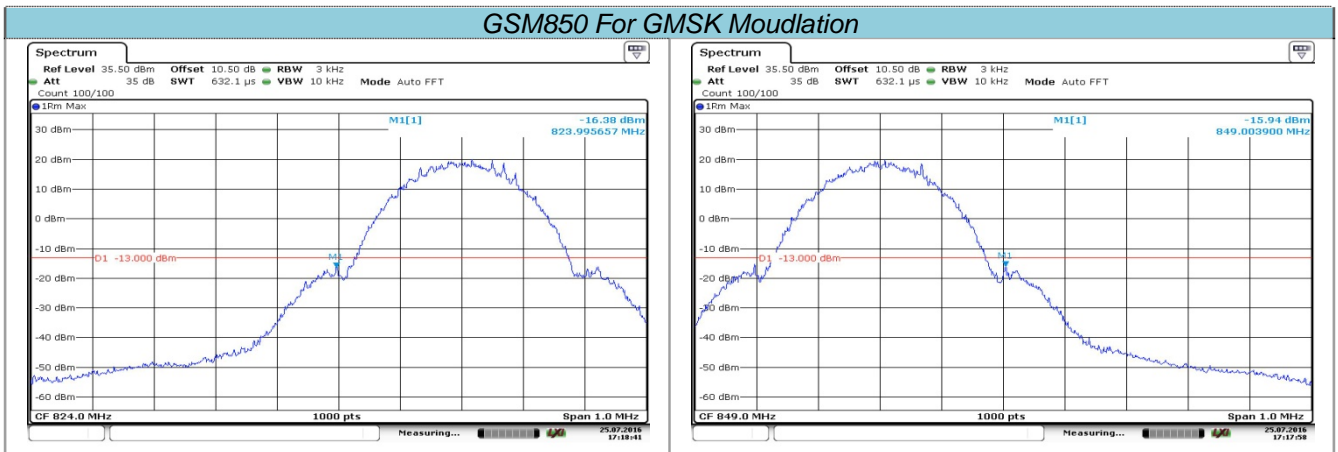



## 4.5. Radiated Power Measurement

### LIMIT

GSM850: 7W ERP

PCS1900: 2W EIRP

### TEST CONFIGURATION

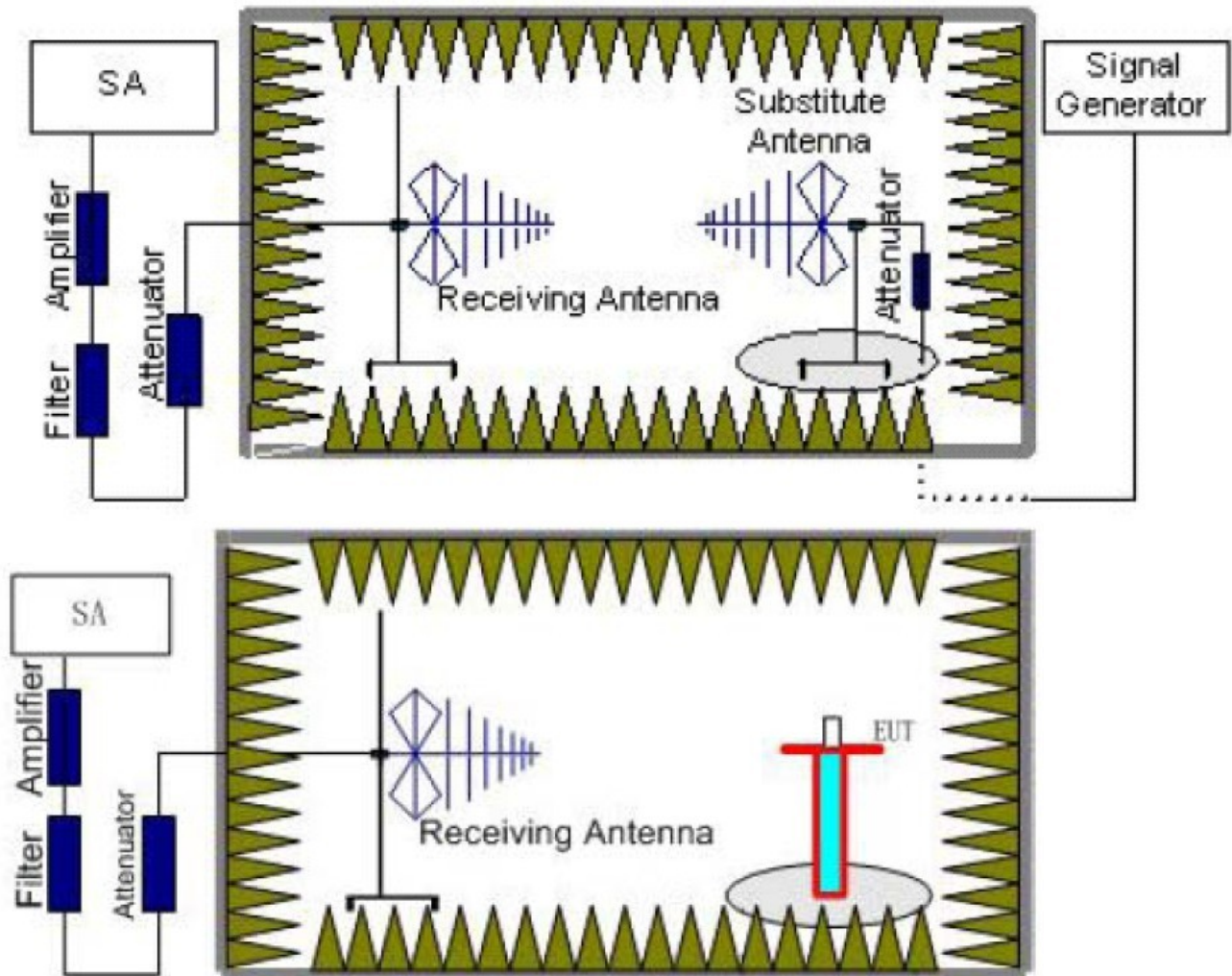

### TEST PROCEDURE

1. EUT was placed on a 1.5 meter high non-conductive stand at a 3 meter test distance from the receive antenna. A receiving antenna was placed on the antenna mast 3 meters from the EUT for emission measurements. The height of receiving antenna is 1.0m. Detected emissions were maximized at each frequency by rotating the EUT through 360° and adjusting the receiving antenna polarization. The radiated emission measurements of all transmit frequencies in three channels (High, Middle, Low) were measured with peak detector.
2. A log-periodic antenna or double-ridged waveguide horn antenna shall be substituted in place of the EUT. The log-periodic antenna will be driven by a signal generator and the level will be adjusted till the same power value on the spectrum analyzer or receiver. The level of the spurious emissions can be calculated through the level of the signal generator, cable loss, the gain of the substitution antenna and the reading of the spectrum analyzer or receiver.
3. The EUT is then put into continuously transmitting mode at its maximum power level during the test. Set Test Receiver or Spectrum RBW=1MHz, VBW=3MHz for above 1GHz and RBW=100kHz, VBW=300kHz for 30MHz to 1GHz, And the maximum value of the receiver should be recorded as (Pr).
4. The EUT shall be replaced by a substitution antenna. In the chamber, an substitution antenna for the frequency band of interest is placed at the reference point of the chamber. An RF Signal source for the frequency band of interest is connected to the substitution antenna with a cable that has been constructed to not interfere with the radiation pattern of the antenna. A power (PMea) is applied to the input of the

substitution antenna, and adjust the level of the signal generator output until the value of the receiver reach the previously recorded (Pr). The power of signal source (PMea) is recorded. The test should be performed by rotating the test item and adjusting the receiving antenna polarization.

5. A amplifier should be connected to the Signal Source output port. And the cable should be connect between the Amplifier and the Substitution Antenna. The cable loss (Pcl) ,the Substitution Antenna Gain (Ga) and the Amplifier Gain (PAg) should be recorded after test.
6. The measurement results are obtained as described below:  
 $Power(EIRP)=PMea- PAg - Pcl+ Ga$   
 We used SMF100A microwave signal generator which signal level can up to 33dBm,so we not used power Amplifier for substitution test; The measurement results are amend as described below:  
 $Power(EIRP)=PMea- Pcl+Ga$
7. This value is EIRP since the measurement is calibrated using an antenna of known gain (2.15 dBi) and known input power.  
 ERP can be calculated from EIRP by subtracting the gain of the dipole,  $ERP = EIRP-2.15dBi$ .

**TEST RESULTS**

GSM:

Mode	Channel	Antenna Pol.	ERP	Limit (dBm)	Result
GSM850	128	V	30.75	38.45	Pass
		H	22.43		
	190	V	30.45		
		H	22.14		
	251	V	30.76		
		H	21.85		
GPRS850	128	V	30.43	38.45	Pass
		H	22.14		
	190	V	30.47		
		H	22.25		
	251	V	30.48		
		H	22.74		

Mode	Channel	Antenna Pol.	EIRP	Limit (dBm)	Result
PCS1900	512	V	25.45	33.01	Pass
		H	22.38		
	661	V	25.72		
		H	22.14		
	810	V	25.63		
		H	22.24		
GPRS1900	512	V	25.86	33.01	Pass
		H	22.47		
	661	V	25.36		
		H	22.38		
	810	V	25.72		
		H	22.43		

## 4.6. Radiated Spurious Emission

### LIMIT

-13dBm

### TEST CONFIGURATION

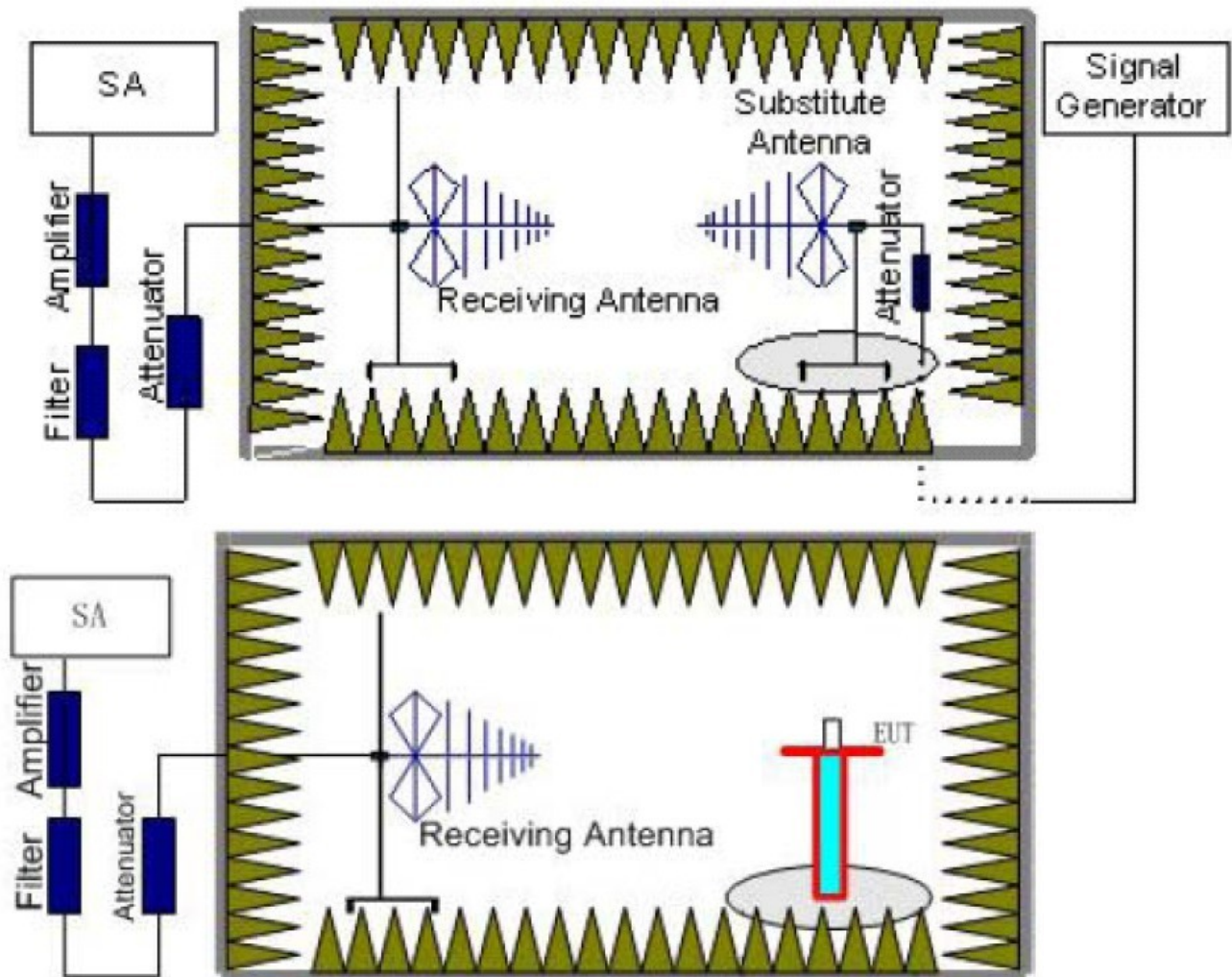

### TEST RESULTS

1. EUT was placed on a 1.5 meter high non-conductive stand at a 3 meter test distance from the receive antenna. A receiving antenna was placed on the antenna mast 3 meters from the EUT for emission measurements. The height of receiving antenna is 1.0m. Detected emissions were maximized at each frequency by rotating the EUT through 360° and adjusting the receiving antenna polarization. The radiated emission measurements of all transmit frequencies in three channels (High, Middle, Low) were measured with peak detector.
2. A log-periodic antenna or double-ridged waveguide horn antenna shall be substituted in place of the EUT. The log-periodic antenna will be driven by a signal generator and the level will be adjusted till the same power value on the spectrum analyzer or receiver. The level of the spurious emissions can be calculated through the level of the signal generator, cable loss, the gain of the substitution antenna and the reading of the spectrum analyzer or receiver.
3. The EUT is then put into continuously transmitting mode at its maximum power level during the test. Set Test Receiver or Spectrum RBW=1MHz, VBW=3MHz for above 1GHz and RBW=100kHz, VBW=300kHz for 30MHz to 1GHz, And the maximum value of the receiver should be recorded as (Pr).
4. The EUT shall be replaced by a substitution antenna. In the chamber, an substitution antenna for the frequency band of interest is placed at the reference point of the chamber. An RF Signal source for the frequency band of interest is connected to the substitution antenna with a cable that has been constructed to not interfere with the radiation pattern of the antenna. A power (PMea) is applied to the input of the substitution antenna, and adjust the level of the signal generator output until the value of the receiver reach the previously recorded (Pr). The power of signal source (PMea) is recorded. The test should be performed by rotating the test item and adjusting the receiving antenna polarization.

5. A amplifier should be connected to the Signal Source output port. And the cable should be connect between the Amplifier and the Substitution Antenna. The cable loss (Pcl) ,the Substitution Antenna Gain (Ga) and the Amplifier Gain (PAg) should be recorded after test.
6. The measurement results are obtained as described below:  
Power(EIRP)=PMea- PAg - Pcl+ Ga  
We used SMF100A micowave signal generator which signal level can up to 33dBm,so we not used power Amplifier for substitution test; The measurement results are amend as described below:  
Power(EIRP)=PMea- Pcl+Ga
7. This value is EIRP since the measurement is calibrated using an antenna of known gain (2.15 dBi) and known input power.  
ERP can be calculated from EIRP by subtracting the gain of the dipole, ERP = EIRP-2.15dBi.

## **TEST RESULTS**

GSM850					
Channel	Frequency (MHz)	Spurious Emission		Limit (dBm)	Result
		Polarization	Level (dBm)		
128	1648.40	Vertical	-29.93	-13.00	Pass
	2472.60	V	-46.85		
	3296.80	V	-47.43		
	4121.00	V	-44.85		
	4945.20	V	---		
	1648.40	Horizontal	-38.09	-13.00	Pass
	2472.60	H	-43.72		
	3296.80	H	-50.42		
	4121.00	H	-50.78		
	4945.20	H	---		
190	1673.20	Vertical	-28.54	-13.00	Pass
	2509.80	V	-45.47		
	3346.40	V	-46.47		
	4183.00	V	-44.25		
	5019.60	V	---		
	1673.20	Horizontal	-39.38	-13.00	Pass
	2509.80	H	-44.25		
	3346.40	H	-50.14		
	4183.00	H	-51.25		
	5019.60	H	---		
251	1697.60	Vertical	-29.24	-13.00	Pass
	2546.40	V	-46.75		
	3395.20	V	-46.84		
	4244.00	V	-44.25		
	5092.80	V	---		
	1697.60	Horizontal	-38.39	-13.00	Pass
	2546.40	H	-42.54		
	3395.20	H	-49.38		
	4244.00	H	-51.25		
	5092.80	H	---		

## Remark :

1. The emission behaviour belongs to narrowband spurious emission.
2. Remark"---" means that the emission level is too low to be measured
3. The emission levels of below 1 GHz are very lower than the limit and not show in test report.

PCS1900					
Channel	Frequency (MHz)	Spurious Emission		Limit (dBm)	Result
		Polarization	Level (dBm)		
512	3700.40	Vertical	-34.11	-13.00	Pass
	5550.60	V	-34.35		
	7400.80	V	-50.43		
	9251.00	V	-51.25		
	11101.20	V	---		
	3700.40	Horizontal	-34.25	-13.00	Pass
	5550.60	H	-30.69		
	7400.80	H	-52.47		
	9251.00	H	-53.65		
	11101.20	H	---		
661	3760.00	Vertical	-33.24	-13.00	Pass
	5640.00	V	-34.52		
	7520.00	V	-50.65		
	9400.00	V	-51.47		
	11280.00	V	---		
	3760.00	Horizontal	-35.24	-13.00	Pass
	5640.00	H	-30.67		
	7520.00	H	-49.75		
	9400.00	H	-52.85		
	11280.00	H	---		
810	3819.60	Vertical	-34.25	-13.00	Pass
	5729.40	V	-33.87		
	7639.20	V	-49.75		
	9549.00	V	-50.24		
	11458.80	V	---		
	3819.60	Horizontal	-33.64	-13.00	Pass
	5729.40	H	-32.38		
	7639.20	H	-51.43		
	9549.00	H	-52.08		
	11458.80	H	---		

Remark :

1. The emission behaviour belongs to narrowband spurious emission.
2. Remark"---" means that the emission level is too low to be measured
3. The emission levels of below 1 GHz are very lower than the limit and not show in test report.

### 4.7. Frequency stability V.S. Temperature measurement

**LIMIT**

2.5ppm

**TEST CONFIGURATION**

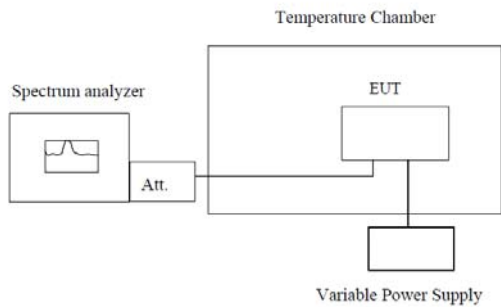

Note : Measurement setup for testing on Antenna connector

**TEST PROCEDURE**

1. The equipment under test was connected to an external DC power supply and input rated voltage.
2. RF output was connected to a frequency counter or spectrum analyzer via feed through attenuators.
3. The EUT was placed inside the temperature chamber.
4. Set the spectrum analyzer RBW low enough to obtain the desired frequency resolution and measure EUT 25°C operating frequency as reference frequency.
5. Turn EUT off and set the chamber temperature to -30°C. After the temperature stabilized for approximately 30 minutes recorded the frequency.
6. Repeat step measure with 10°C increased per stage until the highest temperature of +50°C reached.

**TEST RESULTS**

Reference Frequency: GSM850 Middle channel=190 channel=836.6MHz					
Power supplied (Vdc)	Temperature (°C)	Frequency error		Limit (ppm)	Result
		Hz	ppm		
3.70	-30	-34	-0.041	2.5	Pass
	-20	-35	-0.042		
	-10	-33	-0.039		
	0	-32	-0.038		
	10	-28	-0.033		
	20	-35	-0.042		
	30	-29	-0.035		
	40	-31	-0.037		
	50	-39	-0.047		
Reference Frequency: PCS1900 Middle channel=661 channel=1880MHz					
Power supplied (Vdc)	Temperature (°C)	Frequency error		Limit (ppm)	Result
		Hz	ppm		
3.70	-30	-34	-0.018	2.5	Pass
	-20	-39	-0.021		
	-10	-32	-0.017		
	0	-27	-0.014		
	10	-29	-0.015		
	20	-33	-0.018		
	30	-35	-0.019		
	40	-33	-0.018		
	50	-32	-0.017		



### 4.8. Frequency stability V.S. Voltagemasurement

**LIMIT**

2.5ppm

**TEST CONFIGURATION**

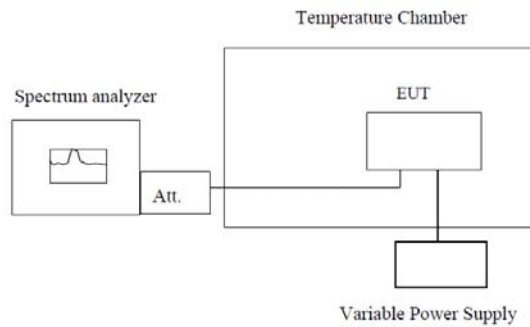

Note : Measurement setup for testing on Antenna connector

**TEST PROCEDURE**

1. Set chamber temperature to 25°C. Use a variable DC power source to power the EUT and set the voltage to rated voltage.
2. Set the spectrum analyzer RBW low enough to obtain the desired frequency resolution and recorded the frequency.
3. Reduce the input voltage to specified extreme voltage variation (+/- 15%) and endpoint, record the maximum frequency change.

**TEST RESULTS**

Reference Frequency: GSM850 (GSM link) Middle channel=190 channel=836.6MHz					
Temperature (°C)	Power supplied (Vdc)	Frequency error		Limit (ppm)	Result
		Hz	ppm		
25	4.20	-33	-0.039	2.5	Pass
	3.70	-35	-0.042		
	3.50	-29	-0.035		
Reference Frequency: PCS1900 (GSM link) Middle channel=661 channel=1880MHz					
Temperature (°C)	Power supplied (Vdc)	Frequency error		Limit (ppm)	Result
		Hz	ppm		
25	4.20	-28	-0.015	2.5	Pass
	3.70	-33	-0.018		
	3.50	-32	-0.017		



### 4.9. Peak-Average Ratio

**LIMIT**

13dB

**TEST CONFIGURATION**

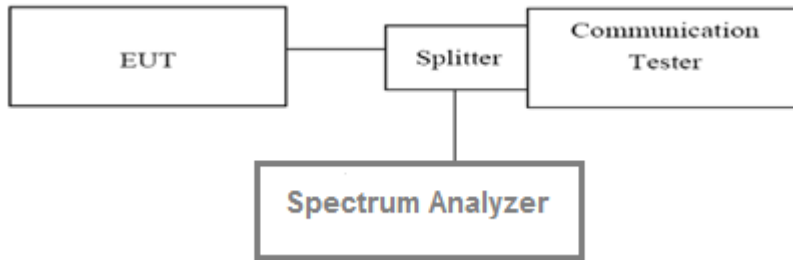

**TEST PROCEDURE**

According with KDB 971168

1. The signal analyzer' s CCDF measurement profile is enabled
2. Frequency = carrier center frequency
3. Measurement BW > Emission bandwidth of signal
4. The signal analyzer was set to collect one million samples to generate the CCDF curve
5. The measurement interval was set depending on the type of signal analyzed. For continuous signals (>98% duty cycle), the measurement interval was set to 1ms. For burst transmissions, the spectrum analyzer is set to use an internal " RF Burst" trigger that is synced with an incoming pulse and the measurement interval is set to less than the duration of the " on time" of one burst to ensure that energy is only captured during a time in which the transmitter is operating at maximum power

**TEST RESULTS**

**Worst case GSM1900.**

Band	Channel	Frequency(MHz)	PAR	Limit(dB)	Result
GSM1900	512	1850.2	8.89	13	Pass
	661	1880.0	8.97	13	Pass
	810	1909.8	9.05	13	Pass

## 5. Test Setup Photos of the EUT

Radiated emission:

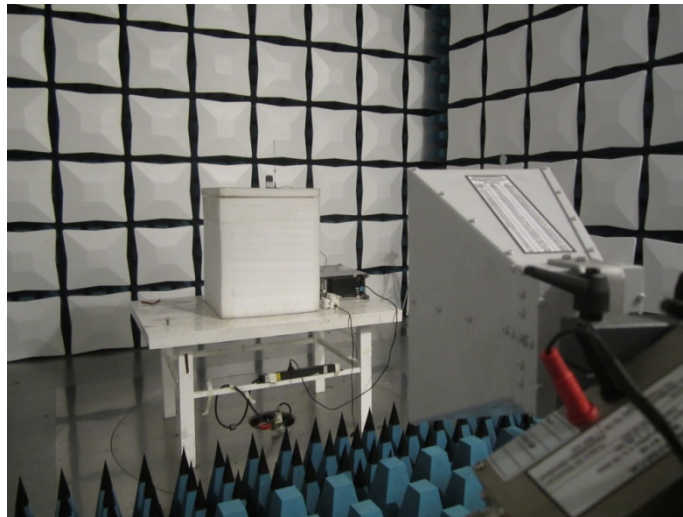
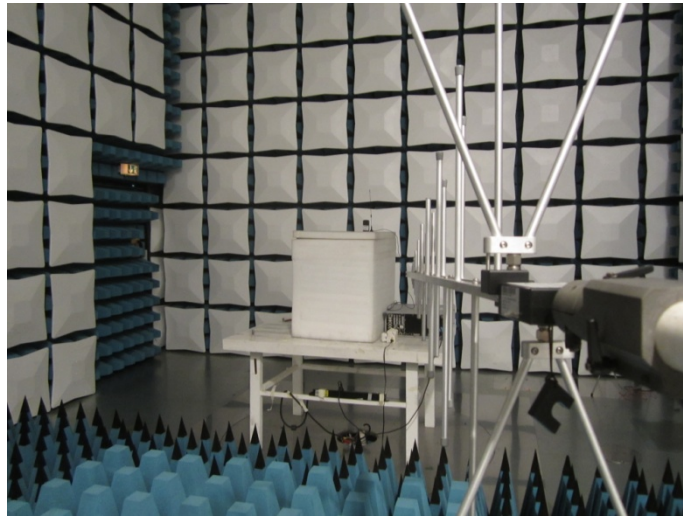

## 6. External and Internal Photos of the EUT

### External photos of the EUT







**Bitcom**  
TECHNOLOGIES

**Adapter AC/DC**

Model: G1818A

INPUT:100-240 VAC 50-60Hz 0.2A

OUTPUT:5 VDC 500mA

  **FC** 

Made in China



**Internal photos of the EUT**

