

Spezifikation für Freigabe / specification for release

Kunde / customer : _____
 Artikelnummer / part number : **7488910092**
 Bezeichnung : **SMD Antenne WE-MCA**
 description : **Chip-Antenna WE-MCA**

LF



DATUM / DATE : 2007-01-12

A Mechanische Abmessungen / dimensions:

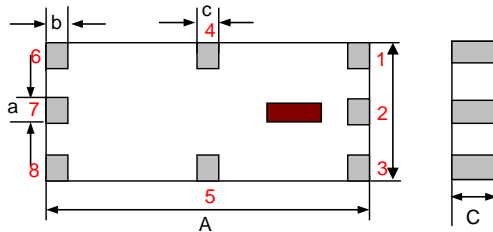

size	11 x 5,1	
------	-----------------	--

A	11,0 ± 0,3	mm
B	5,1 ± 0,3	mm
C	1,5 ± 0,2	mm
a	1,0 ± 0,2	mm
b	0,5 ± 0,3	mm
c	0,5 ± 0,3	mm
	1 NC	
	2 Feeding Point	
3 - 8	NC	

B Elektrische Eigenschaften / electrical properties:

Eigenschaften / properties	Testbedingungen / test conditions		Wert / value	Einheit / unit	tol.
Frequenzbereich / frequency range		f	868 ... 960	MHz	
VSWR			2,5		max.
Impedanz / impedance		Z	50	Ω	
Antennengewinn / peak gain	(XZ-V)	A	-0,7	dBi	typ.
Antennengewinn / average gain	(XZ-V)	A	-2,6	dBi	typ.

C Abbildung / appearance:

D Prüfgeräte / test equipment:

Agilent E5071A

E Testbedingungen / test conditions:

Luftfeuchtigkeit / humidity: 50 ~ 70%
 Umgebungstemperatur / temperature: 20°C ~ 25°C

F Werkstoffe & Zulassungen / material & approvals:

Basismaterial / base material: Keramik / ceramic
 Kontakt Material / contact plating: Ag + Ni + Sn

G Eigenschaften / general specifications:

Betriebstemp. / operating temperature: -40°C ~ +85°C
 Lagerbedingung / storage conditions: 15°C ~ 35°C
 45 ~ 75% RH
 Leistung/ power capacity : 5 W max.

Freigabe erteilt / general release:	Kunde / customer		
		
Datum / date	Unterschrift / signature		
	Würth Elektronik		
		
Geprüft / checked	Kontrolliert / approved		
	Name	Änderung / modification	Datum / date
	Skle	Version 3	07-01-12
	AWe	Version 2	05-02-09
	AWe	Version 1	04-10-11

Würth Elektronik eiSos GmbH & Co.KG

D-74638 Waldenburg · Max-Eyth-Str. 1 · Germany · Telefon (+49) (0) 7942 - 945 - 0 · Telefax (+49) (0) 7942 - 945 - 400
<http://www.we-online.de>

Spezifikation für Freigabe / specification for release

Kunde / customer : _____
 Artikelnummer / part number : **7488910092**
 Bezeichnung : **SMD Antenne WE-MCA**
 description : **Chip-Antenna WE-MCA**

LF



DATUM / DATE : 2007-01-12

H Lötpadempfehlung / solder pads:

Without Matching Circuit:

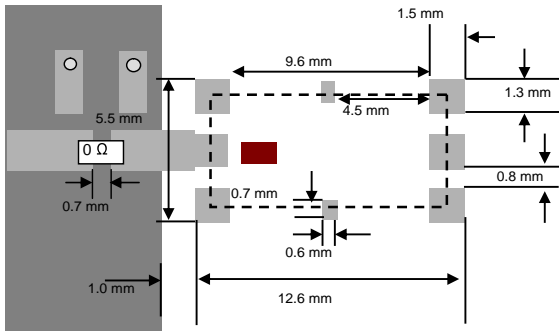

With Matching Circuit:

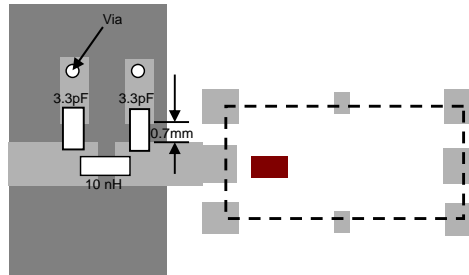

*Line width should be designed to match 50Ω characteristic impedance, depending on PCB material and thickness.
 (Matching circuit and component values will be different, depending on PCB layout)

K Messdiagramme/ measuring diagrams:

Without Matching Circuit:

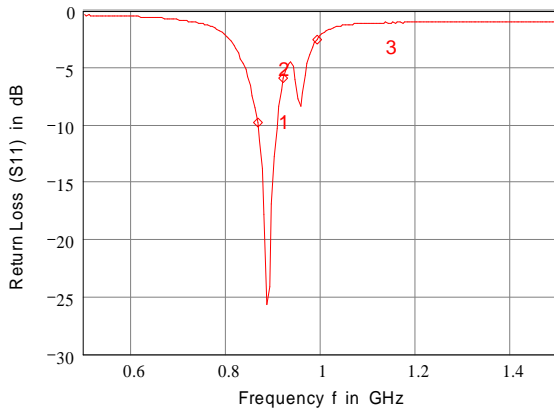

1: 865 MHz	-9.699 dB
2: 920 MHz	-5.859 dB
3: 990 MHz	-2.484 dB

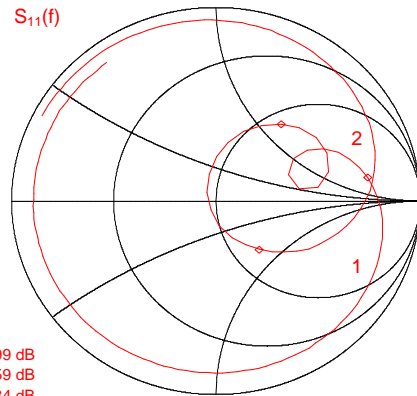

f = 0.5 GHz ... 1.5 GHz

With Matching Circuit:

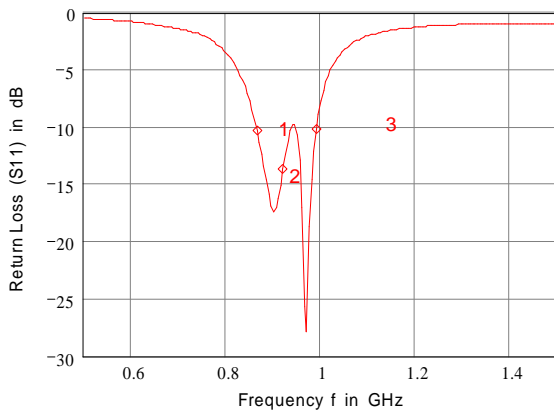

1: 865 MHz	-10.284 dB
2: 920 MHz	-13.682 dB
3: 990 MHz	-10.215 dB

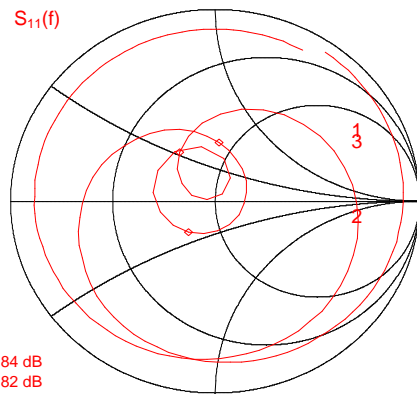

f = 0.5 GHz ... 1.5 GHz

Würth Elektronik eiSos GmbH & Co.KG

D-74638 Waldenburg · Max-Eyth-Str. 1 · Germany · Telefon (+49) (0) 7942 - 945 - 0 · Telefax (+49) (0) 7942 - 945 - 400
<http://www.we-online.de>

Spezifikation für Freigabe / specification for release

Kunde / customer : _____
 Artikelnummer / part number : **7488910092**
 Bezeichnung : **SMD Antenne WE-MCA**
 description : **Chip-Antenna WE-MCA**

LF



DATUM / DATE : 2007-01-12

L Richtdiagramme / radiation patterns:

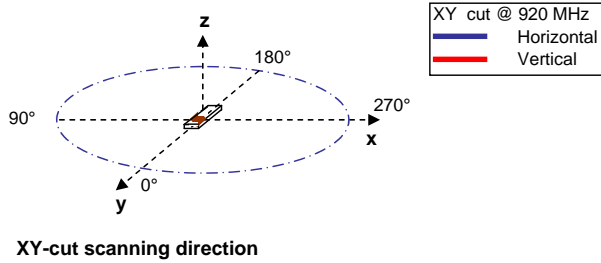

XY cut @ 920 MHz
 — Horizontal
 — Vertical

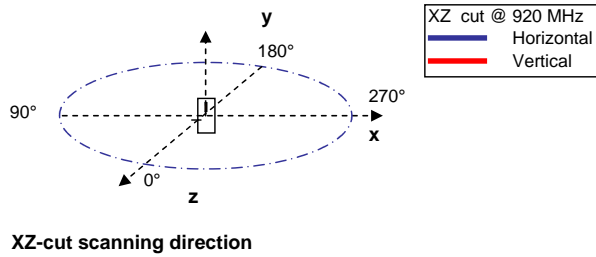
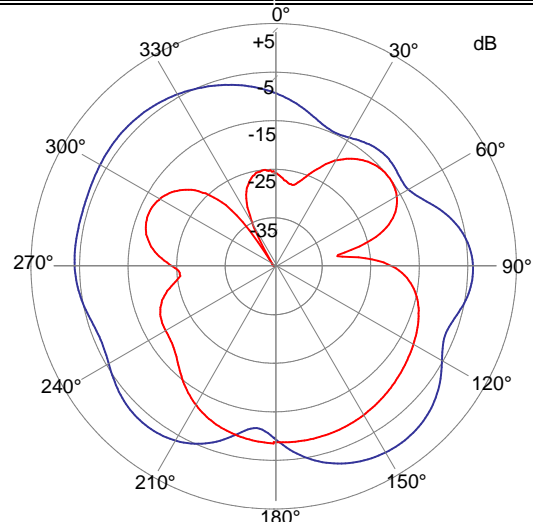

XZ cut @ 920 MHz
 — Horizontal
 — Vertical

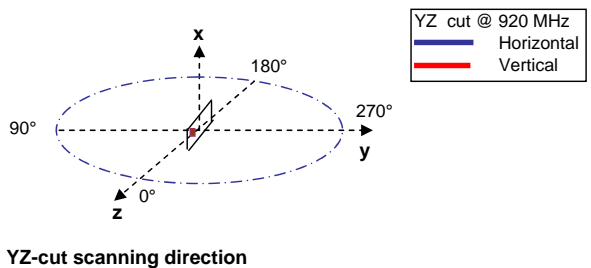
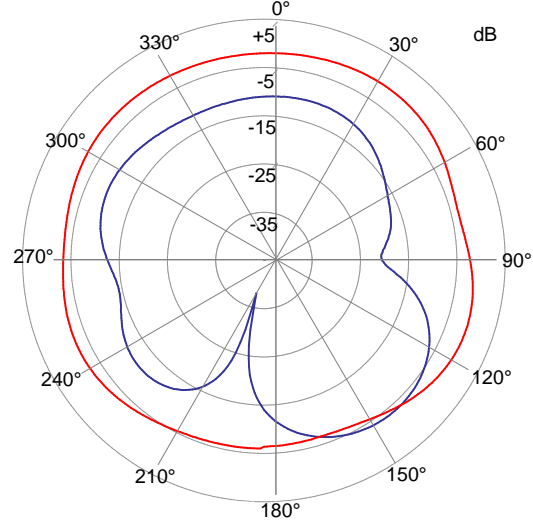

YZ cut @ 920 MHz
 — Horizontal
 — Vertical

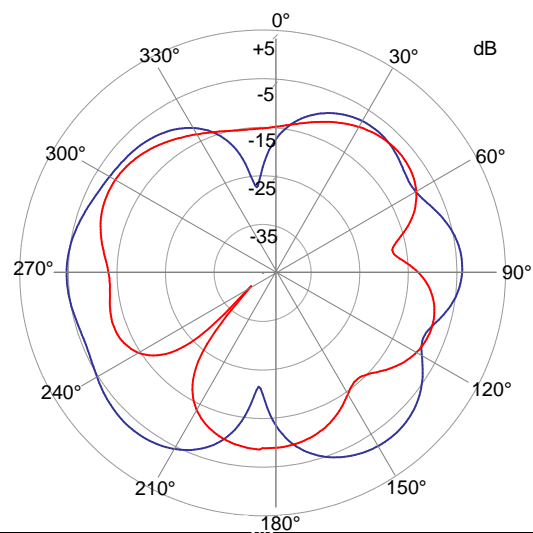

Würth Elektronik eiSos GmbH & Co.KG

D-74638 Waldenburg · Max-Eyth-Str. 1 · Germany · Telefon (+49) (0) 7942 - 945 - 0 · Telefax (+49) (0) 7942 - 945 - 400
<http://www.we-online.de>

Spezifikation für Freigabe / specification for release

Kunde / customer : _____

Artikelnummer / part number : **7488910092**

LF



Bezeichnung : **SMD Antenne WE-MCA**

description : **Chip-Antenna WE-MCA**

DATUM / DATE : 2007-01-12

M Testboard / evaluation board:

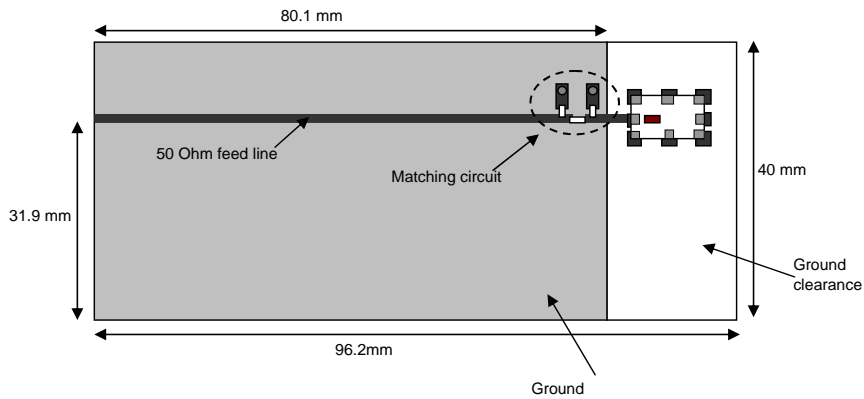

This electronic component has been designed and developed for usage in general electronic equipment. Before incorporating this component into any equipment where higher safety and reliability is especially required or if there is the possibility of direct damage or injury to human body, for example in the range of aerospace, aviation, nuclear control, submarine, transportation, (automotive control, train control, ship control), transportation signal, disaster prevention, medical, public information network etc, Würth Elektronik eiSos GmbH must be informed before the design-in stage. In addition, sufficient reliability evaluation checks for safety must be performed on every electronic component which is used in electrical circuits that require high safety and reliability functions or performance.

Würth Elektronik eiSos GmbH & Co.KG

D-74638 Waldenburg · Max-Eyth-Str. 1 · Germany · Telefon (+49) (0) 7942 - 945 - 0 · Telefax (+49) (0) 7942 - 945 - 400
<http://www.we-online.de>



Key Features

- Adjustable mount
- SMA/SMA-RP male connector
- Quad band GSM frequency
- 6dBi peak gain
- ISM: 868 and 915MHz
- 3G: 2100MHz

General Description

The Siretta Multiband whip antenna is based on a 2008 redesign giving excellent performance in the quad band GSM 800/900/1800/1900/2100MHz frequencies.

Terminated with an SMA/SMA-RP male connector, the unique knuckle adjusts through a 0 / 45 & 90 degree angle and swivels to ensure a vertical polarity when fitted to the radio module.

The radiating element consists of a two part design and is over moulded in black, high grade rubber giving a rugged, stylish finish.

The Delta 6A is a popular antenna for customers requiring a straightforward to fit, reliable product and is qualified and used with many of today's GSM / GPRS and 3G terminals.

Additional Considerations

- Ensures antenna can be flexibly installed with equipment
- Fits to most popular GSM / GPRS and 3G terminal equipment
- Does not rely on mounting on metallic surface
- Meets all EU compliance criteria for electronic goods

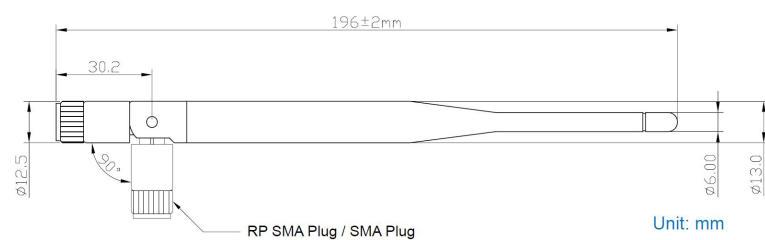

Rev 1.3

Key Specifications - Electrical

Storage temperature range:	-30 to 75 °C
Operating temperature range:	-20 to 60 °C
Impedance:	50 ohm
VSWR:	<2:1
Operating frequencies:	850, 900, 1800, 1900MHz
Polarization:	Vertical
Radiating element:	Dipole
Return loss:	880MHz - 6dB 960MHz - 12dB 1710MHz - 10dB 1990MHz - 9.9dB

Gain

ISM	
868MHz:	4.1dBi
915MHz:	4.05dBi
GSM	
850MHz:	3.75dBi
900MHz:	4.02dBi
1800MHz:	6.78dBi
1900MHz:	6.2dBi
3G	
2100MHz:	3.44dBi

Key Specifications - Mechanical

Dimensions:	187.5mm x 9.6mm
Connector:	SMA
Mounting method:	Direct connect

Test Reports

Vertical

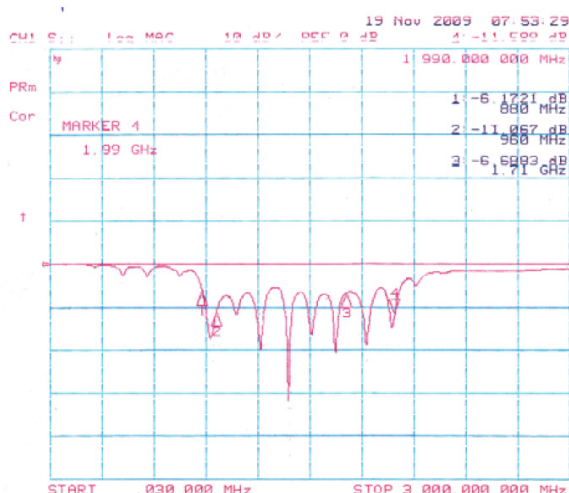

Horizontal

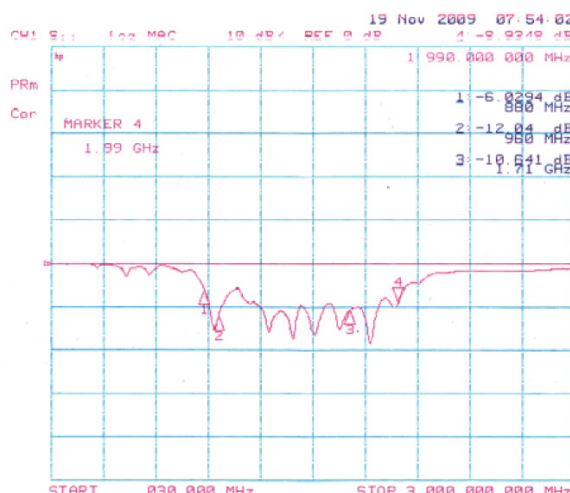

Gain vs. Frequency Graph

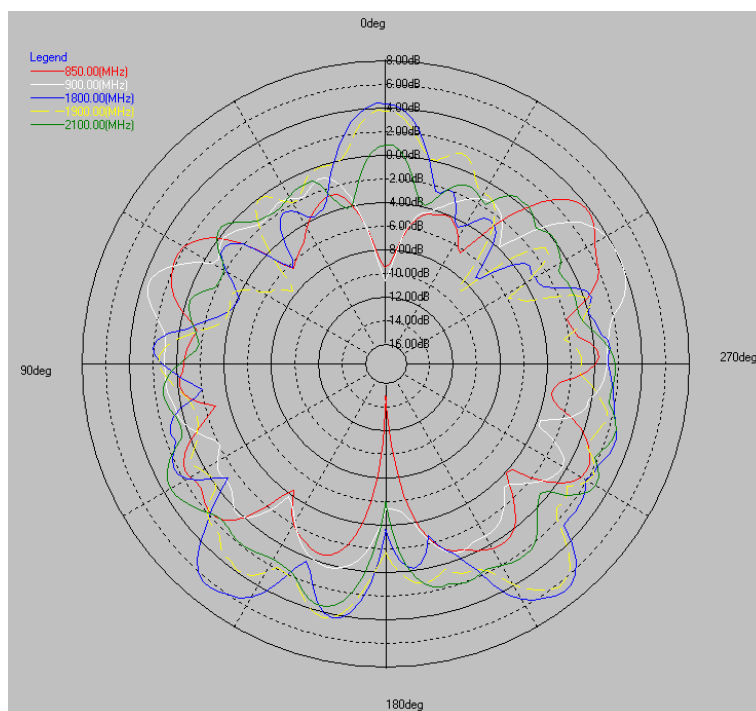

UL Tested (Basingstoke, UK)
Part: DELTA6A

Ordering Details

Part number	Description
DELTA6A/X/SMAM/S/S/11	Quad Band GSM, 3G & ISM Swivel Antenna, SMA Male Connector

Electrical Properties:

Frequency Range: 902~928 MHz
 Impedance: 50Ω nominal
 VSWR: <2.0:1
 Gain: 2 dBi
 Radiation: Omni
 Polarization: Vertical
 Wave: ½ wave

Mechanical Properties:

Connector: SMA type
 Material: Wire (Black)
 Whip: Polyacetal(Black)
 Base: Brass with black chrome plating
 Connector: SMA type
 Operation Temp.: -20°C to +65°C
 Storage Temp.: -30°C to +75°C

This is a RoHS compliant product.

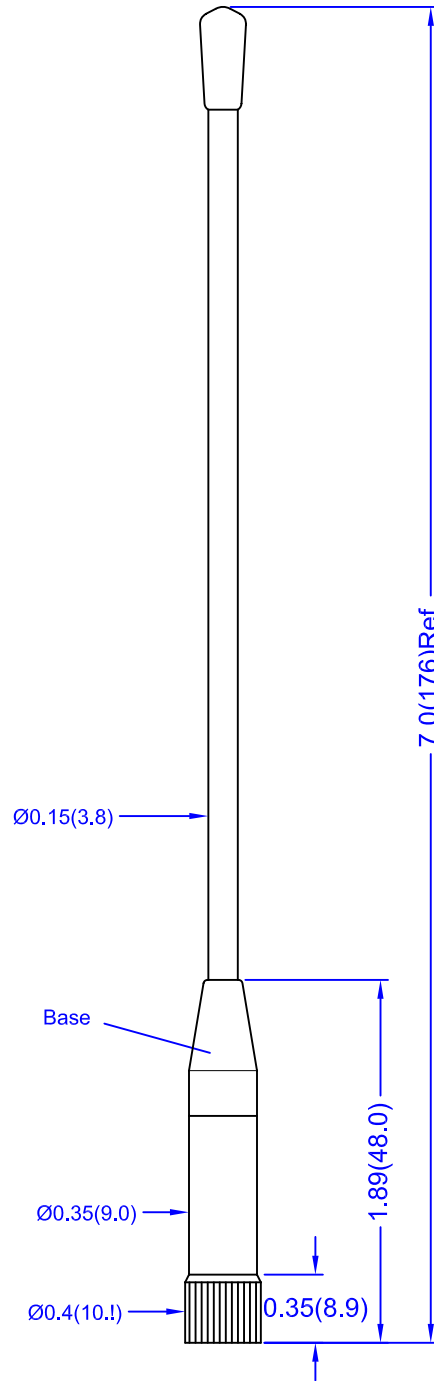

Series Part Numbers

Connector Code - XX -	Description	P / N
AM	SMA Plug	S463AM-915
AH	SMA Plug Reverse Polarity	S463AH-915

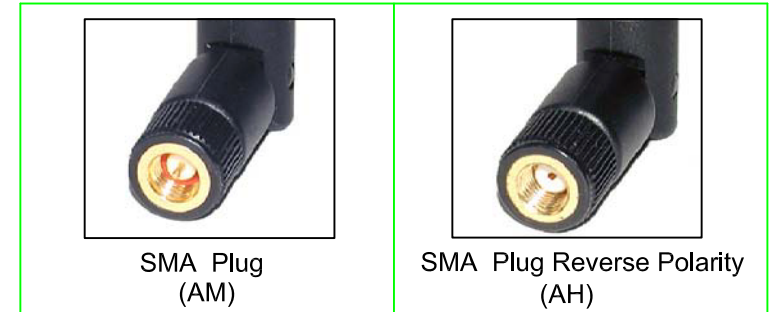

Connector Interface

TITLE	900 MHz ISM Band Straight Antenna -463 Model		Rev. Date	SHEET
UNIT	DWG. NO.	S463XX-915	02/03/06	1 of 1
in.(mm)				
SCALE				
none				

ANT-916-CW-QW

Data Sheet

Product Description

CW Series ¼-wave antennas deliver outstanding performance in a rugged and cosmetically attractive package. These antennas are available with standard SMA or FCC Part 15 compliant RP-SMA connectors. RP-SMA connectors allow for easy field replacement while complying with FCC requirements. A wide variety of matching connectors permit numerous mounting options.

Features

- Low cost
- Excellent performance
- Omni-directional pattern
- Wide bandwidth
- Very low VSWR
- Fully weatherized
- Flexible main shaft
- Rugged & damage-resistant
- SMA or Part 15 compliant RP-SMA connector
- Use with plastic* or metal enclosures

*Requires proximity ground plane

Electrical Specifications

Center Frequency:	916MHz
Recom. Freq. Range:	865–965MHz
Wavelength:	¼-wave
Peak Gain:	1.8dBi
VSWR:	<1.9 typ. at center
Impedance:	50-ohms
Connector:	RP-SMA or SMA
Oper. Temp. Range:	–40°C to +90°C

Electrical specifications and plots measured on 10.16 cm x 10.16 cm (4.00" x 4.00") reference ground plane

Ordering Information

ANT-916-CW-QW (with RP-SMA connector)
ANT-916-CW-QW-SMA (with SMA connector)

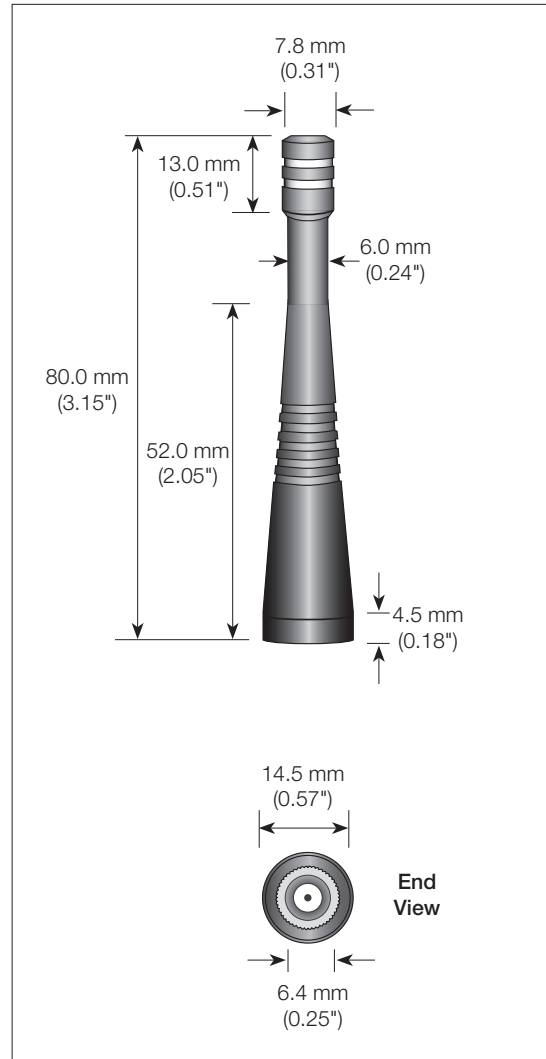

Counterpoise

Quarter-wave or monopole antennas require an associated ground plane counterpoise for proper operation. The size and location of the ground plane relative to the antenna will affect the overall performance of the antenna in the final design. When used in conjunction with a ground plane smaller than that used to tune the antenna, the center frequency typically will shift higher in frequency and the bandwidth will decrease. The proximity of other circuit elements and packaging near the antenna will also affect the final performance. For further discussion and guidance on the importance of the ground plane counterpoise, please refer to Linx Application Note AN-00501: Understanding Antenna Specifications and Operation.

VSWR Graph

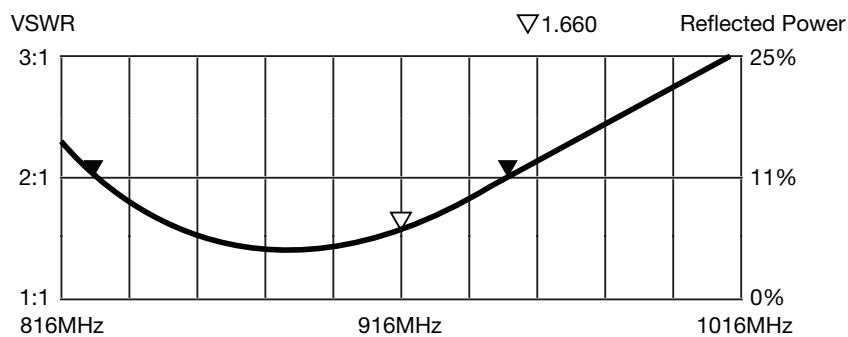

What is VSWR?

The Voltage Standing Wave Ratio (VSWR) is a measurement of how well an antenna is matched to a source impedance, typically 50-ohms. It is calculated by measuring the voltage wave that is headed toward the load versus the voltage wave that is reflected back from the load. A perfect match will have a VSWR of 1:1. The higher the first number, the worse the match, and the more inefficient the system. Since a perfect match cannot ever be obtained, some benchmark for performance needs to be set. In the case of antenna VSWR, this is usually 2:1. At this point, 88.9% of the energy sent to the antenna by the transmitter is radiated into free space and 11.1% is either reflected back into the source or lost as heat on the structure of the antenna. In the other direction, 88.9% of the energy recovered by the antenna is transferred into the receiver. As a side note, since the “:1” is always implied, many data sheets will remove it and just display the first number.

How to Read a VSWR Graph

VSWR is usually displayed graphically versus frequency. The lowest point on the graph is the antenna’s operational center frequency. In most cases, this will be different than the designed center frequency due to fabrication tolerances. The VSWR at that point denotes how close to 50-ohms the antenna gets. Linx specifies the recommended bandwidth as the range where the typical antenna VSWR is less than 2:1.