

DFS Test Report

Applicant : Plume Design, Inc.
Product Name : SuperPod with WiFi 6
Trade Name : Plume Design, Inc.
Model Number : F4A
Applicable Standard : FCC 47 CFR PART 15 SUBPART E
ANSI C63.10:2013
Received Date : Mar. 14, 2022
Test Period : Mar. 21 ~ Jun. 30, 2022
Issued Date : Jul. 01, 2022

Issued by

A Test Lab Techno Corp.
No. 140-1, Changan Street, Bade District,
Taoyuan City 334025, Taiwan (R.O.C.)
Tel : +886-3-2710188 / Fax : +886-3-2710190



Taiwan Accreditation Foundation accreditation number: 1330
Frequency Range : 9 kHz to 40 GHz
Test Firm MRA designation number: TW0010

Note:

- 1.The test results are valid only for samples provided by customers and under the test conditions described in this report.
- 2.This report shall not be reproduced except in full, without the written approval of A Test Lab Technology Corporation.
- 3.The relevant information is provided by customers in this test report. According to the correctness, appropriateness or completeness of the information provided by the customer, if there is any doubt or error in the information which affects the validity of the test results, the laboratory does not take the responsibility.

Revision History

Rev.	Issued Date	Revisions	Revised By
00	Jun. 17, 2022	Initial Issue	Emma Chao
01	Jul. 01, 2022	Update Test Period (P.1) Update chapter 1 (P.6) Update chapter 3.2 (P.12,13) Update chapter 3.3 (P.14) Update chapter 5.7 (P.74, P.203~209)	Emma Chao

Verification of Compliance

Applicant : Plume Design, Inc.

Product Name : SuperPod with WiFi 6

Trade Name : Plume Design, Inc.

Model Number : F4A

FCC ID : 2AG7G-F4A

Applicable Standard : FCC 47 CFR PART 15 SUBPART E
ANSI C63.10:2013

Test Result : Complied

Performing Lab. : A Test Lab Techno Corp.
No. 140-1, Changan Street, Bade District,
Taoyuan City 334025, Taiwan (R.O.C.)
Tel : +886-3-2710188 / Fax : +886-3-2710190
Taiwan Accreditation Foundation accreditation number: 1330



A Test Lab Techno Corp. tested the above equipment in accordance with the requirements set forth in the above standards. All indications of Pass/Fail in this report are opinions expressed by A Test Lab Techno Corp. based on interpretations and/or observations of test results. The test results show that the equipment tested is capable of demonstrating compliance with the requirements as documented in this report.

Approved By : _____
(Kai Yu Yang)

TABLE OF CONTENTS

1	EUT Description	5
2	Test Methodology	7
3	Dynamic Frequency Selection	8
3.1.	Limits	8
3.2.	Test and Measurement System	12
3.3.	Test Instruments	14
4	Test Methodology	15
4.1.	Mode of Operation	15
4.2.	EUT Test Step	15
4.3.	Test Site Environment	15
5	Test Results	16
5.1.	Radar Waveforms and Traffic	16
5.2.	Channel Loading	51
5.3.	Channel Availability Check Time	55
5.4.	Channel Move Time and Channel Closing Transmission Time	61
5.5.	Non-Occupancy Period	68
5.6.	U-NII Detection Bandwidth	69
5.7.	Statistical Performance check	74
Appendix A. Test Setup Photographs		
Appendix B. Verify Data		

1 EUT Description

Applicant	Plume Design, Inc. 325 Lytton Ave., Palo Alto, CA 94301			
Product Name	SuperPod with WiFi 6			
Trade Name	Plume Design, Inc.			
Model Number	F4A			
FCC ID	2AG7G-F4A			
Operate Frequency	Frequency Band		Frequency Range (MHz)	Number of Channels
	IEEE 802.11a / IEEE 802.11n 5 GHz 20 MHz / IEEE 802.11ac 20 MHz / IEEE 802.11ax 20 MHz	U-NII Band 2-A	5260 – 5320	4
		U-NII Band 2-C	5500 – 5720	12
	IEEE 802.11n 5 GHz 40 MHz / IEEE 802.11ac 40 MHz / IEEE 802.11ax 40 MHz	U-NII Band 2-A	5270 – 5310	2
		U-NII Band 2-C	5510 – 5710	6
	IEEE 802.11ac 80 MHz / IEEE 802.11ax 80 MHz	U-NII Band 2-A	5290	1
		U-NII Band 2-C	5530 – 5690	3
IEEE 802.11ac 160 MHz / IEEE 802.11ax 160 MHz	U-NII Band 2-A	5250	1	
Modulation Type	OFDM/OFDMA			
Equipment Type (DFS)	Master			
Antenna information	Band	Antenna	Type	Max. Gain (dBi)
	U-NII Band 2-A	5G L1	PIFA Antenna	3.2
		5G L2		2.1
		5G L3		3.1
		5G L4		3.7
	U-NII Band 2-C	5G H1	PIFA Antenna	4.1
5G H2		2.3		
Antenna Delivery	IEEE 802.11a / IEEE 802.11ac 20 MHz / 40 MHz / 80 MHz / 160 MHz IEEE 802.11ax 20 MHz / 40 MHz / 80 MHz / 160 MHz		5470~5.725 MHz	2TX
			5250~5350 MHz	4TX
Operate Temp. Range	-30 ~ +50 °C			
EUT Power Rating	100-240 V, 50-60 Hz, 0.45 A			

EUT Modify Description :

<p>Modify Description: (1)The differences between the original EUT and new one (Hardware removal only): Remove UWB function. (2)Update model number.</p> <p>After the verification of worst cast of AC Power Conducted Emission 、 Transmitter Radiated Emissions (Below 1 GHz) and DFS, all test data can be referred to the original report and showed in this report.</p>
<p>Original Report : 2205FR14 Modify: 2205FR23</p>

Items	Description	
Communication Mode	<input checked="" type="checkbox"/> IP Based (Load Based)	<input type="checkbox"/> Frame Based
TPC Function	<input checked="" type="checkbox"/> With TPC	<input type="checkbox"/> Without TPC
Weather Band (5600 ~ 5650 MHz)	<input checked="" type="checkbox"/> With 5600 ~ 5650 MHz	<input type="checkbox"/> Without 5600 ~ 5650 MHz
Beamforming Function	<input checked="" type="checkbox"/> With Beamforming	<input type="checkbox"/> Without Beamforming
Equipment Type	<input type="checkbox"/> Outdoor access point	
	<input checked="" type="checkbox"/> Indoor access point	
	<input type="checkbox"/> Fixed point-to-point access points	
	<input type="checkbox"/> Client devices	
Operating mode	<input checked="" type="checkbox"/> Master	
	<input type="checkbox"/> Client with radar detection	
	<input type="checkbox"/> Client without radar detection	
	<input type="checkbox"/> Ad-Hoc	
	<input checked="" type="checkbox"/> Bridge	
	<input type="checkbox"/> MESH	

Note : DFS controls (hardware or software) related to radar detection are NOT accessible to the user.

Manufacturer statement confirming that information regarding the parameters of the detected Radar Waveforms is not available to the end user.

2 Test Methodology

The tests documented in this report were performed in accordance with ANSI C63.10-2013, FCC CFR 47 Part 2, FCC CFR 47 Part 15.

The tests documented in this report were performed in accordance with FCC KDB request:

- FCC KDB 905462 D02 UNII DFS Compliance Procedures New Rules v02
- FCC KDB 905462 D03 UNII Clients Without Radar Detection New Rules v01r02

3 Dynamic Frequency Selection

3.1. Limits

§15.407 (h) and FCC KDB 905462 D02 UNII DFS Compliance Procedures New Rules v02 Compliance measurement procedures for unlicensed-national information infrastructure devcies operating in the 5250-5350 MHz and 5470-5725 MHz bands incorporating dynamic frequency selection.

Table 1: Applicability of DFS Requirements Prior to Use of a Channel			
Requirement	Operational Mode		
	Master	Client (without Radar Detection)	Client (with Radar Detection)
Non-Occupancy Period	Yes	Not required	Yes
DFS Detection Threshold	Yes	Not required	Yes
Channel Availability Check Time	Yes	Not required	Not required
U-NII Detection Bandwidth	Yes	Not required	Yes

Table 2: Applicability of DFS requirements during normal operation		
Requirement	Operational Mode	
	Master Device or Client With Radar Detection	Client without Radar Detection
DFS Detection Threshold	Yes	Not required
Channel Closing Transmission Time	Yes	Yes
Channel Move Time	Yes	Yes
U-NII Detection Bandwidth	Yes	Not required

Additional requirements for devices with multiple bandwidth modes	Master Device or Client With Radar Detection	Client without Radar Detection
U-NII Detection Bandwidth and Statistical Performance Check	All BW modes must be tested	Not required
Channel Move Time and Channel Closing Transmission Time	Test using widest BW mode available	Test using the widest BW mode available for the link
All other tests	Any single BW mode	Not required

Note : Frequencies selected for statistical performance check (Section 7.8.4) should include several frequencies within the radar detection bandwidth and frequencies near the edge of the radar detection bandwidth. For 802.11 devices it is suggested to select frequencies in all 20 MHz channel blocks and a null frequencies between the bonded 20 MHz channel blocks

Table 3: DFS Detection Thresholds for Master Devices and Client Devices With Radar Detection	
Maximum Transmit Power	U-NII Band 2-Aalue (See Notes 1,2 and 3)
EIRP ≥ 200 milliwatt	-64 dBm
EIRP < 200 milliwatt and Power spectral density < 10 dBm/MHz	-62 dBm
EIRP < 200 milliwatt that do not meet the power spectral density requirement	-64 dBm
<p>Note 1: This is the level at the input of the receiver assuming a 0 dBi receive antenna.</p> <p>Note 2: Throughout these test procedures an additional 1 dB has been added to the amplitude of the test transmission waveforms to account for variations in measurement equipment. This will ensure that the test signal is at or above the detection threshold level to trigger a DFS response.</p> <p>Note 3: EIRP is based on the highest antenna gain. For MIMO devices refer to FCC KDB Publication 662911 D01.</p>	

Table 4: DFS Response Requirement U-NII Band 2-Aalues	
Parameter	U-NII Band 2-Aalue
Non-occupancy period	Minimum 30 minutes
Channel Availability Check Time	60 seconds
Channel Move Time	10 seconds See Note 1.
Channel Closing Transmission Time	200 milliseconds + an aggregate of 60 milliseconds over remaining 10 second period. See Notes 1 and 2.
U-NII Detection Bandwidth	Minimum 100 % of the U-NII 99 % transmission power bandwidth. See Note 3.
<p>Note 1: Channel Move Time and the Channel Closing Transmission Time should be performed with Radar Type 0. The measurement timing begins at the end of the Radar Type 0 burst.</p> <p>Note 2: The Channel Closing Transmission Time is comprised of 200 milliseconds starting at the beginning of the Channel Move Time plus any additional intermittent control signals required to facilitate a Channel move (an aggregate of 60 milliseconds) during the remainder of the 10 second period. The aggregate duration of control signals will not count quiet periods in between transmissions.</p> <p>Note 3: During the U-NII Detection Bandwidth detection test, radar type 0 should be used. For each frequency step the minimum percentage of detection is 90 percent. Measurements are performed with no data traffic.</p>	

Table 5: Short Pulse Radar Test Waveforms					
Radar Type	Pulse Width (μsec)	PRI (μsec)	Number of Pulses	Minimum Percentage of Successful Detection	Minimum Number of Trials
0	1	1428	18	See Note 1	See Note 1
1	1	Test A: 15 unique PRI values randomly selected from the list of 23 PRI values in Table 5a <hr/> Test B: 15 unique PRI values randomly selected within the range of 518-3066 μsec, with a minimum increment of 1 μsec, excluding PRI values selected in Test A	$\text{Roundup} \left\{ \begin{array}{l} \left(\frac{1}{360} \right) \cdot \\ \left(\frac{19 \cdot 10^6}{\text{PRI}_{\mu\text{sec}}} \right) \end{array} \right\}$	60 %	30
2	1-5	150-230	23-29	60 %	30
3	6-10	200-500	16-18	60 %	30
4	11-20	200-500	12-16	60 %	30
Aggregate (Radar Types 1-4)				80 %	120
Note 1: Short Pulse Radar Type 0 should be used for the detection bandwidth test, channel move time, and channel closing time tests.					

Table 5a: Pulse Repetition Intervals U-NII Band 2-Aalues for Test A		
Pulse Repetition Frequency Number	Pulse Repetition Frequency (Pulses Per Second)	Pulse Repetition Interval (Microseconds)
1	1930.5	518
2	1858.7	538
3	1792.1	558
4	1730.1	578
5	1672.2	598
6	1618.1	618
7	1567.4	638
8	1519.8	658
9	1474.9	678
10	1432.7	698
11	1392.8	718
12	1355	738
13	1319.3	758
14	1285.3	778
15	1253.1	798
16	1222.5	818
17	1193.3	838
18	1165.6	858
19	1139	878
20	1113.6	898
21	1089.3	918
22	1066.1	938
23	326.2	3066

Table 6 – Long Pulse Radar Test Signal							
Radar Waveform	Bursts	Pulses per Burst	Pulse Width (µsec)	Chirp Width (MHz)	PRI (µsec)	Minimum Percentage of Successful Detection	Minimum Trials
5	8-20	1-3	50-100	5-20	1000-2000	80 %	30

Table 7 – Frequency Hopping Radar Test Signal							
Radar Waveform	Pulse Width (µsec)	PRI (µsec)	Burst Length (ms)	Pulses per Hop	Hopping Rate (kHz)	Minimum Percentage of Successful Detection	Minimum Trials
6	1	333	300	9	0.333	70 %	30

3.2. Test and Measurement System

3.2.1. Setup for Master with injection at the Master

Example Conducted Setup where UUT is a Master and Radar Test Waveforms are injected into the Master

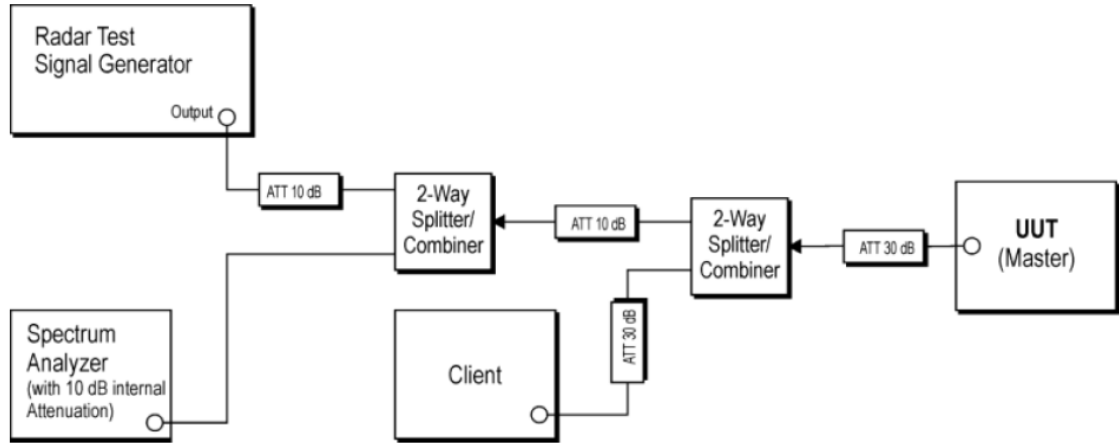

Tested System Details

The types for all equipments, plus descriptions of all cables used in the tested system (including inserted cards) are:

	Product	Manufacturer	Model No.	ID
1.	SuperPod with WiFi 6	Plume Design, Inc.	F4A	FCC : 2AG7G-F4A

3.2.2. System Calibration

The short pulse types 0,1,2, 3 and 4, and the long pulse type 5 parameters are randomized at run-time. The hopping type 6 pulse parameters are fixed while the hopping sequence is based on the May 2014 NTIA Hopping Frequency List. The initial starting point randomized at run-time and each subsequent starting point is incremented by 475. Each frequency in the 100-length segment is compared to the boundaries of the EUT Detection Bandwidth and the software creates a hopping burst pattern in accordance with Section 7.4.1.3 Method #2 Simulated Frequency Hopping Radar Waveform Generating Subsystem of FCC KDB 905462 D02 UNII DFS Compliance Procedures New Rules v02 The frequency of the signal generator is incremented in 1 MHz steps from FL to FH for each successive trial. This incremental sequence is repeated as required to generate a minimum of 30 total trials and to maintain a uniform frequency distribution over the entire Detection Bandwidth.

The signal monitoring equipment consists of a spectrum analyzer. The aggregate ON time is calculated by multiplying the number of bins above a threshold during a particular observation period by the dwell time per bin, with the analyzer set to peak detection and max hold.

3.2.3. System Calibration

The Interference Radar Detection Threshold Level is (-64 dBm), The above equipment setup was used to calibrate the conducted Radar Waveform. A vector signal generator was utilized to establish the test signal level for each radar type. During this process there were replace 50 ohm terminal form Master and Client device and no transmissions by either the Master or Client Device. The spectrum analyzer was switched to the zero span (Time Domain) at the frequency of the Radar Waveform generator. Peak detection was used. The spectrum analyzer resolution bandwidth (RBW) and video bandwidth (U-NII Band 2-ABW) were set to at least 3 MHz.

The vector signal generator amplitude was set so that the power level measured at the spectrum analyzer was (-64 dBm). Capture the spectrum analyzer plots on short pulse radar types, long pulse radar type and hopping radar waveform.

3.2.4. Adjustment of Displayed Traffic Level

A link is established between the Master and Slave and the distance between the units is adjusted as needed to provide a suitable received level at the Master and Slave devices. Software to ping the client is permitted to simulate data transfer but must have random ping intervals. The monitoring antenna is adjusted so that the WLAN traffic level, as displayed on the spectrum analyzer, is at lower amplitude than the radar detection threshold.

3.3. Test Instruments

For Conducted

Test Period: Mar. 21 ~ Aug. 18, 2022

Testing Engineer: Brian Lin

Use	Equipment	Manufacturer	Model Number	Serial Number	Cal. Date	Cal. Period
<input type="checkbox"/>	Power Sensor	Anritsu	MA2411B	1126022	Sep. 03, 2021	1 year
<input type="checkbox"/>	Power Meter	Anritsu	ML2495A	1135009	Sep. 03, 2021	1 year
<input type="checkbox"/>	Power Sensor	Agilent	N1921A	MY45241957	Dec. 06, 2021	1 year
<input type="checkbox"/>	Power Meter	Agilent	N1911A	MY45101619	Dec. 06, 2021	1 year
<input checked="" type="checkbox"/>	Spectrum Analyzer (10 Hz~26.5 GHz)	Keysight	N9010B	MY59071418	Mar. 16, 2022	1 year
<input type="checkbox"/>	Spectrum Analyzer (9 kHz~26.5 GHz)	Agilent	N9010A	MY48030518	Jul. 23, 2021 Jul. 21, 2022	1 year
<input type="checkbox"/>	Spectrum Analyzer (20 Hz~26.5 GHz)	Agilent	N9020A	US47520902	Sep. 09, 2021	1 year
<input type="checkbox"/>	Spectrum Analyzer (3 Hz~50 GHz)	Agilent	N9030A	MY53120541	Jan. 05, 2022	1 year
<input type="checkbox"/>	Temperature & Humidity Chamber	TAICHY	MHU-225LA	980729	Mar. 30, 2021	1 year
<input checked="" type="checkbox"/>	Signal Generator	Keysight	N5182B	MY53052569	Apr. 20, 2021 Apr. 16, 2022	1 year
<input checked="" type="checkbox"/>	Signal Generator	Keysight	N5182BX07	MY59360221	Apr. 20, 2021 Apr. 16, 2022	1 year
<input type="checkbox"/>	Bluetooth Tester	R&S	CBT	100350	Mar. 17, 2021	2 years
<input type="checkbox"/>	Wireless Connectivity Tester	R&S	CMW270	102208	Jun. 02, 2021 Jun. 01, 2022	1 year
<input type="checkbox"/>	Power Supply	KEITHLEY	2303	4045290	Jan. 19, 2022	1 year

Note: N.C.R. = No Calibration Request.

4 Test Methodology

4.1. Mode of Operation

Decision of Test ATL has verified the construction and function in typical operation. All the test modes were carried out with the EUT in normal operation, which was shown in this test report and defined as:

Test Mode
Mode 1: IEEE 802.11ax 20 MHz Continuous TX mode
Mode 2: IEEE 802.11ax 40 MHz Continuous TX mode
Mode 3: IEEE 802.11ax 80 MHz Continuous TX mode
Mode 4: IEEE 802.11ax 160 MHz Continuous TX mode

IEEE 802.11ax 20 MHz Continuous TX mode:

Unless otherwise noted, all tests were performed with the radar burst at the channel center frequency of 5300 MHz and 5560 MHz.

IEEE 802.11ax 40 MHz Continuous TX mode:

Unless otherwise noted, all tests were performed with the radar burst at the channel center frequency of 5310 MHz and 5550 MHz.

IEEE 802.11ax 80 MHz Continuous TX mode:

Unless otherwise noted, all tests were performed with the radar burst at the channel center frequency of 5290 MHz and 5530 MHz.

IEEE 802.11ax 160 MHz Continuous TX mode:

Unless otherwise noted, all tests were performed with the radar burst at the channel center frequency of 5250 MHz

4.2. EUT Test Step

1.	Setup the EUT shown on 3.2.
2.	Turn on the power of all equipment.
3.	Turn on Wi-Fi function link to Access Point.
4.	The EUT is operated in the normal mode to the purposes of measurement.

4.3. Test Site Environment

Items	Required (IEC 60068-1)	Actual
Temperature (°C)	15-35	20-30
Humidity (%RH)	25-75	45-75

5 Test Results

5.1. Radar Waveforms and Traffic

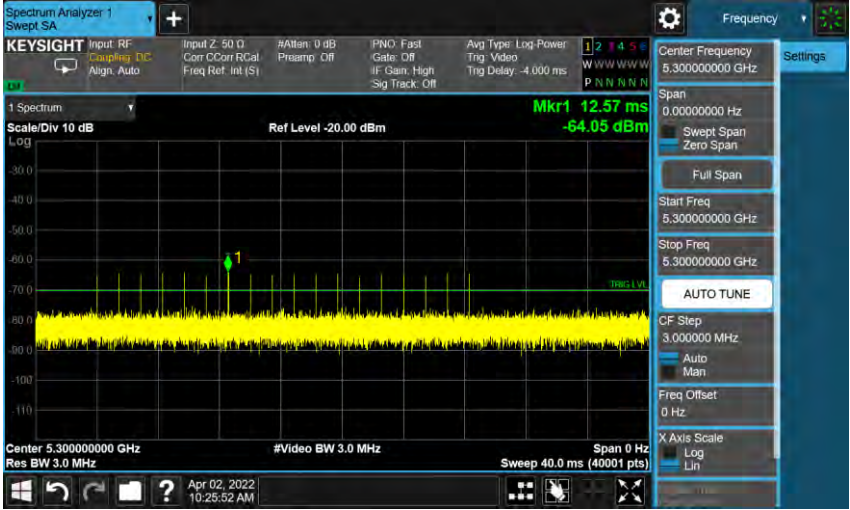
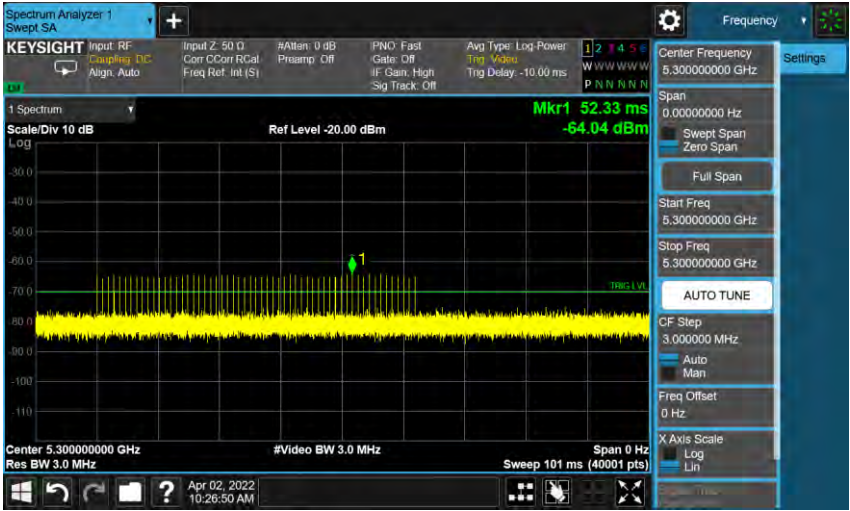
Mode 1: IEEE 802.11ax 20 MHz Continuous TX mode_5300 MHz	
<p>Short Pulse Radar Type 0</p>	 <p>The screenshot shows a Keysight Spectrum Analyzer interface. The main display is a spectrum plot with a yellow signal trace. A green marker labeled 'Mkr1' is positioned at 12.57 ms and -64.05 dBm. The center frequency is 5.300000000 GHz, and the resolution bandwidth is 3.0 MHz. The sweep time is 40.0 ms. The interface includes various control panels for input, settings, and frequency.</p>
<p>Short Pulse Radar Type 1A</p>	 <p>The screenshot shows a Keysight Spectrum Analyzer interface. The main display is a spectrum plot with a yellow signal trace. A green marker labeled 'Mkr1' is positioned at 52.33 ms and -64.04 dBm. The center frequency is 5.300000000 GHz, and the resolution bandwidth is 3.0 MHz. The sweep time is 101 ms. The interface includes various control panels for input, settings, and frequency.</p>

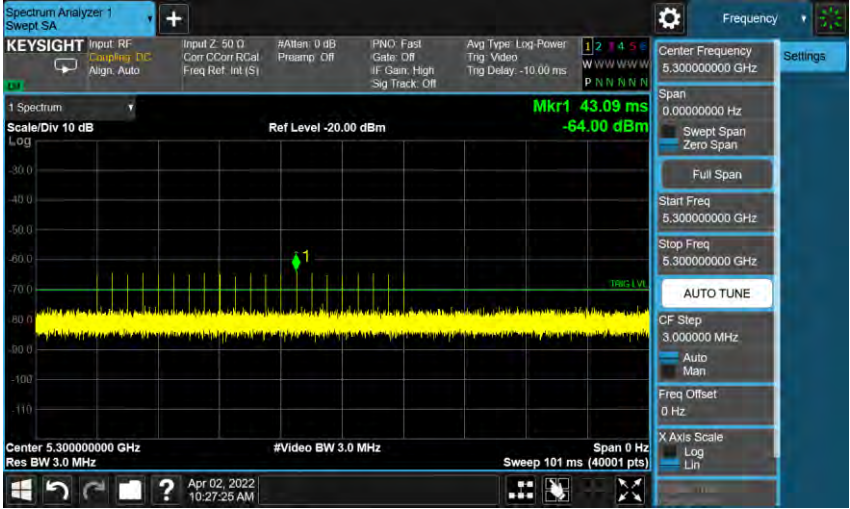
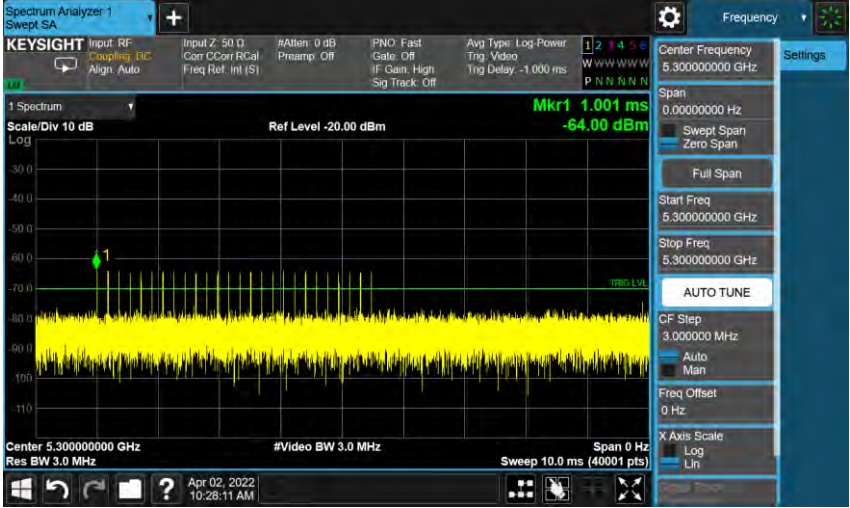
Mode 1: IEEE 802.11ax 20 MHz Continuous TX mode_5300 MHz	
<p>Short Pulse Radar Type 1B</p>	 <p>The screenshot shows a Keysight Spectrum Analyzer interface. The main display is a spectrum plot with a yellow signal trace. A marker 'Mkr1' is placed on the signal, showing a duration of 43.09 ms and a power level of -64.00 dBm. The center frequency is 5.300000000 GHz. The video bandwidth is 3.0 MHz. The sweep rate is 101 ms. The interface includes various control panels for input, settings, and display options.</p>
<p>Short Pulse Radar Type 2</p>	 <p>The screenshot shows a Keysight Spectrum Analyzer interface. The main display is a spectrum plot with a yellow signal trace. A marker 'Mkr1' is placed on the signal, showing a duration of 1.001 ms and a power level of -64.00 dBm. The center frequency is 5.300000000 GHz. The video bandwidth is 3.0 MHz. The sweep rate is 10.0 ms. The interface includes various control panels for input, settings, and display options.</p>

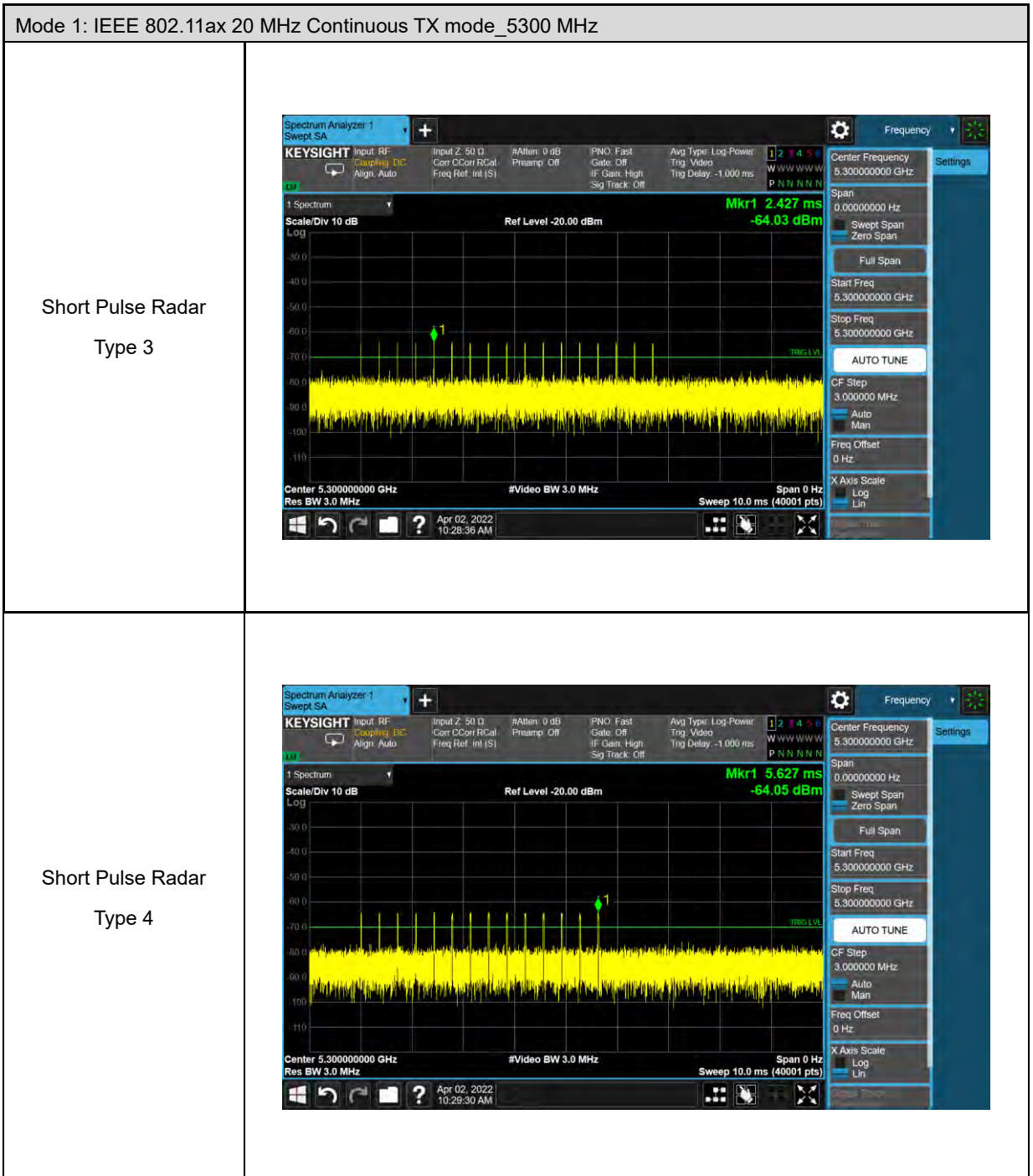

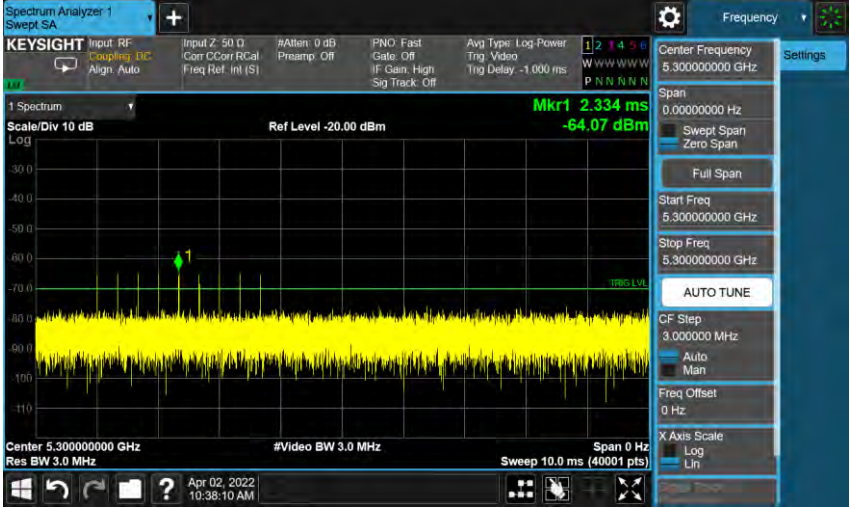

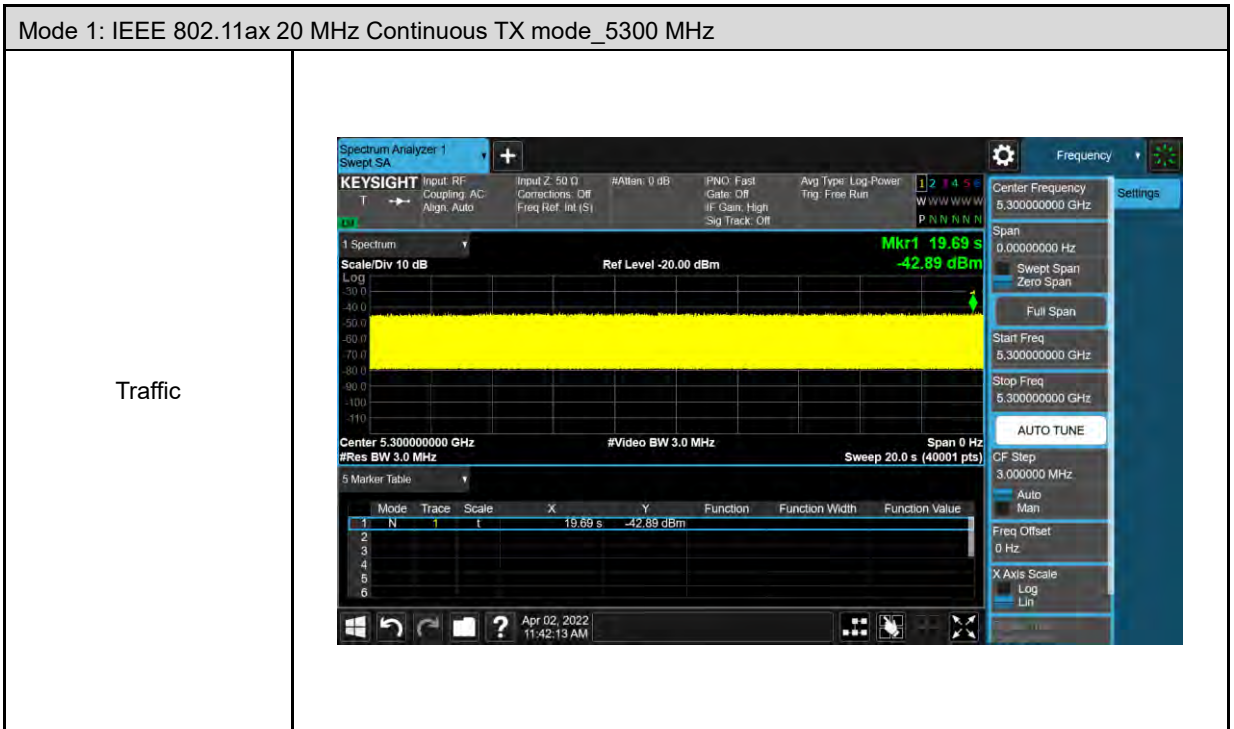
Mode 1: IEEE 802.11ax 20 MHz Continuous TX mode_5300 MHz	
<p>Long Pulse Radar Type 5</p>	 <p>KEYSIGHT Spectrum Analyzer 1 Swept SA</p> <p>Center Frequency: 5.300000000 GHz Span: 0.00000000 Hz Start Freq: 5.300000000 GHz Stop Freq: 5.300000000 GHz CF Step: 3.000000 MHz Freq Offset: 0 Hz X Axis Scale: Log Sweep: 20.0 s (40001 pts)</p> <p>Mkr1 1.339 s -64.09 dBm</p>
<p>Frequency Hopping Radar Type 6</p>	 <p>KEYSIGHT Spectrum Analyzer 1 Swept SA</p> <p>Center Frequency: 5.300000000 GHz Span: 0.00000000 Hz Start Freq: 5.300000000 GHz Stop Freq: 5.300000000 GHz CF Step: 3.000000 MHz Freq Offset: 0 Hz X Axis Scale: Log Sweep: 10.0 ms (40001 pts)</p> <p>Mkr1 2.334 ms -64.07 dBm</p>

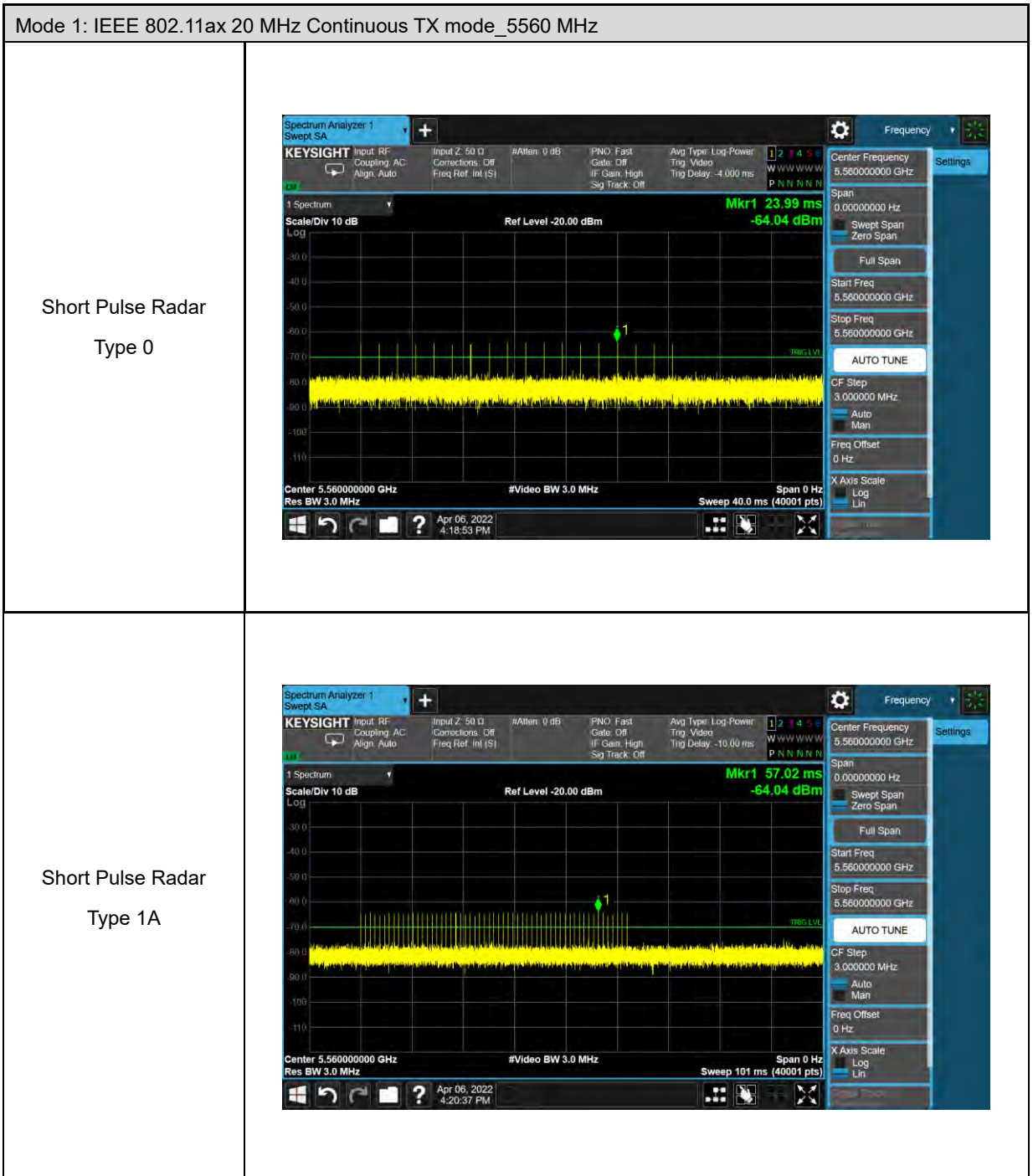

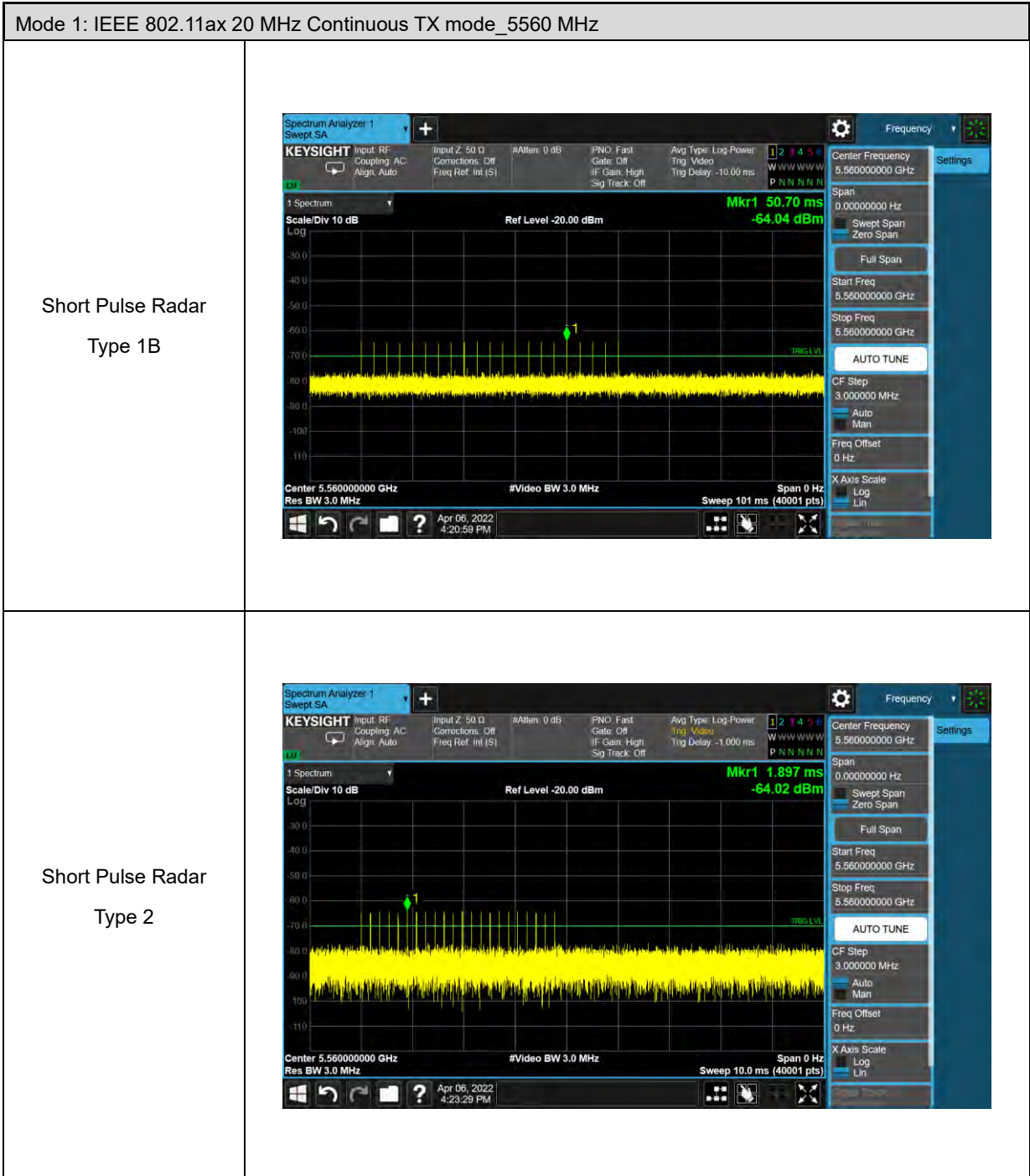

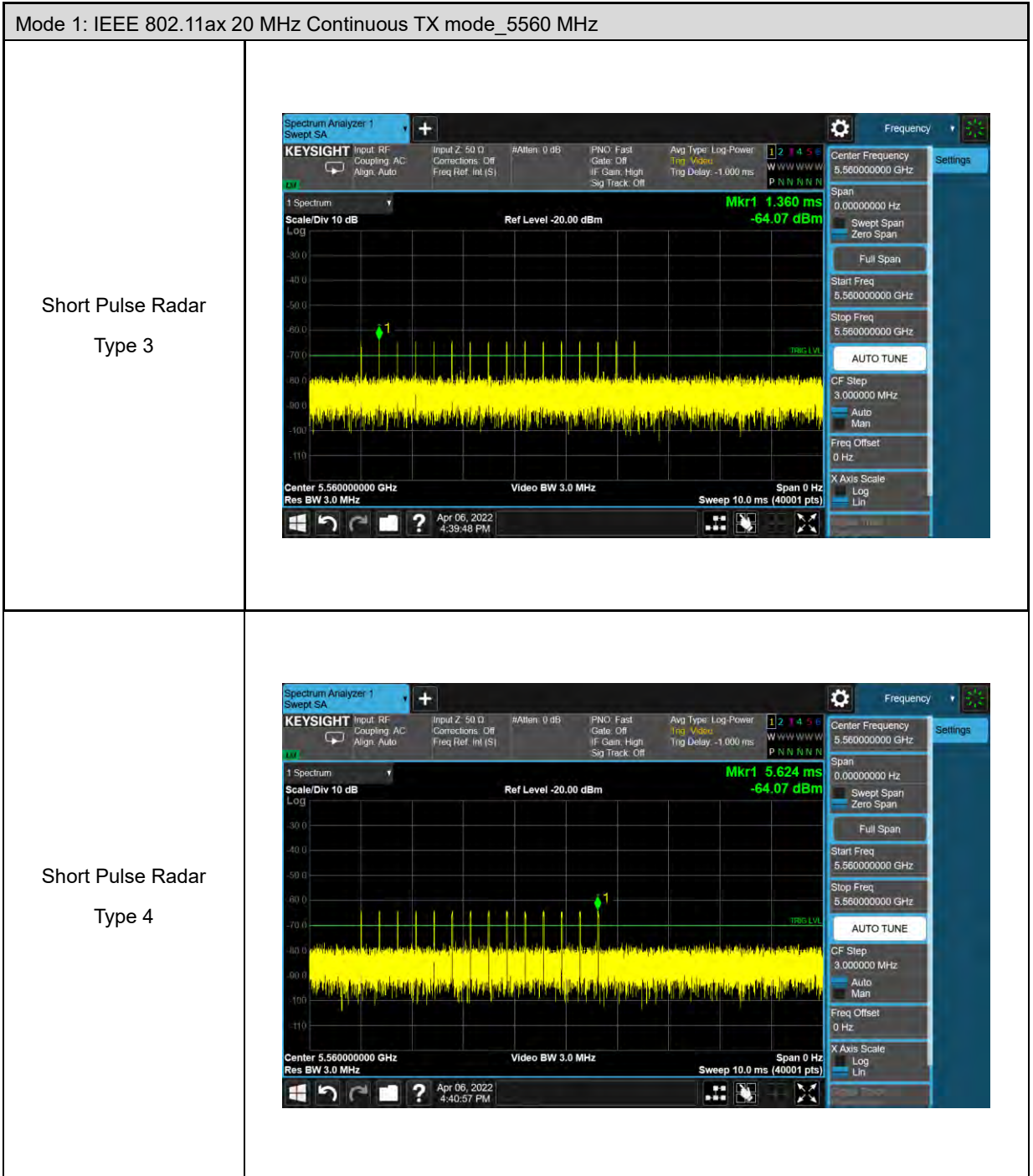

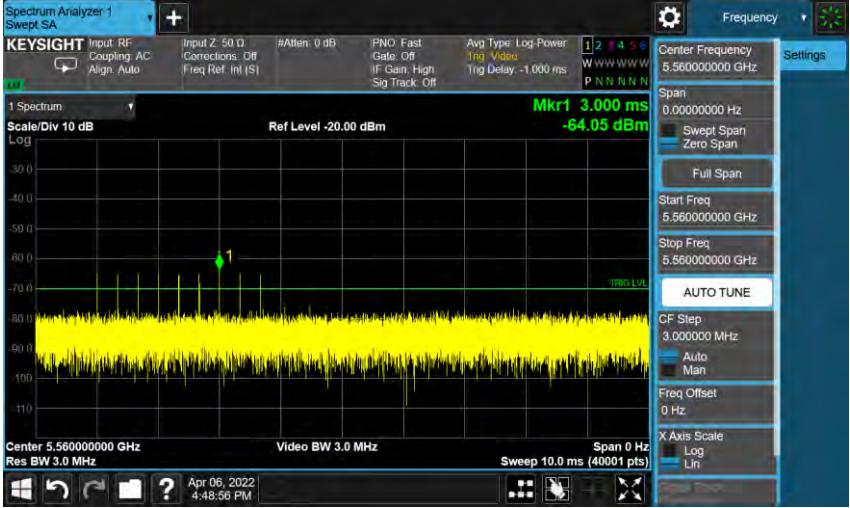

Mode 1: IEEE 802.11ax 20 MHz Continuous TX mode_5560 MHz	
<p>Long Pulse Radar Type 5</p>	 <p>The screenshot shows a Keysight Spectrum Analyzer interface. The main display is a spectrum plot with a yellow signal line. A marker 'Mkr1' is positioned at 5.508 s and -64.04 dBm. The plot title is 'Spectrum Analyzer 1 Swept SA'. The center frequency is 5.560000000 GHz. The span is 0 Hz. The sweep time is 20.0 s. The video bandwidth is 3.0 MHz. The resolution bandwidth is 3.0 MHz. The scale/div is 10 dB. The reference level is -20.00 dBm. The plot shows a continuous signal with a marker at 5.508 s and -64.04 dBm. The settings on the right include Center Frequency 5.560000000 GHz, Span 0.00000000 Hz, Swept Span Zero Span, Full Span, Start Freq 5.560000000 GHz, Stop Freq 5.560000000 GHz, AUTO TUNE, CF Step 3.000000 MHz, Auto Man, Freq Offset 0 Hz, X Axis Scale Log Lin.</p>
<p>Frequency Hopping Radar Type 6</p>	 <p>The screenshot shows a Keysight Spectrum Analyzer interface. The main display is a spectrum plot with a yellow signal line. A marker 'Mkr1' is positioned at 3.000 ms and -64.05 dBm. The plot title is 'Spectrum Analyzer 1 Swept SA'. The center frequency is 5.560000000 GHz. The span is 0 Hz. The sweep time is 10.0 ms. The video bandwidth is 3.0 MHz. The resolution bandwidth is 3.0 MHz. The scale/div is 10 dB. The reference level is -20.00 dBm. The plot shows a signal with a marker at 3.000 ms and -64.05 dBm. The settings on the right include Center Frequency 5.560000000 GHz, Span 0.00000000 Hz, Swept Span Zero Span, Full Span, Start Freq 5.560000000 GHz, Stop Freq 5.560000000 GHz, AUTO TUNE, CF Step 3.000000 MHz, Auto Man, Freq Offset 0 Hz, X Axis Scale Log Lin.</p>

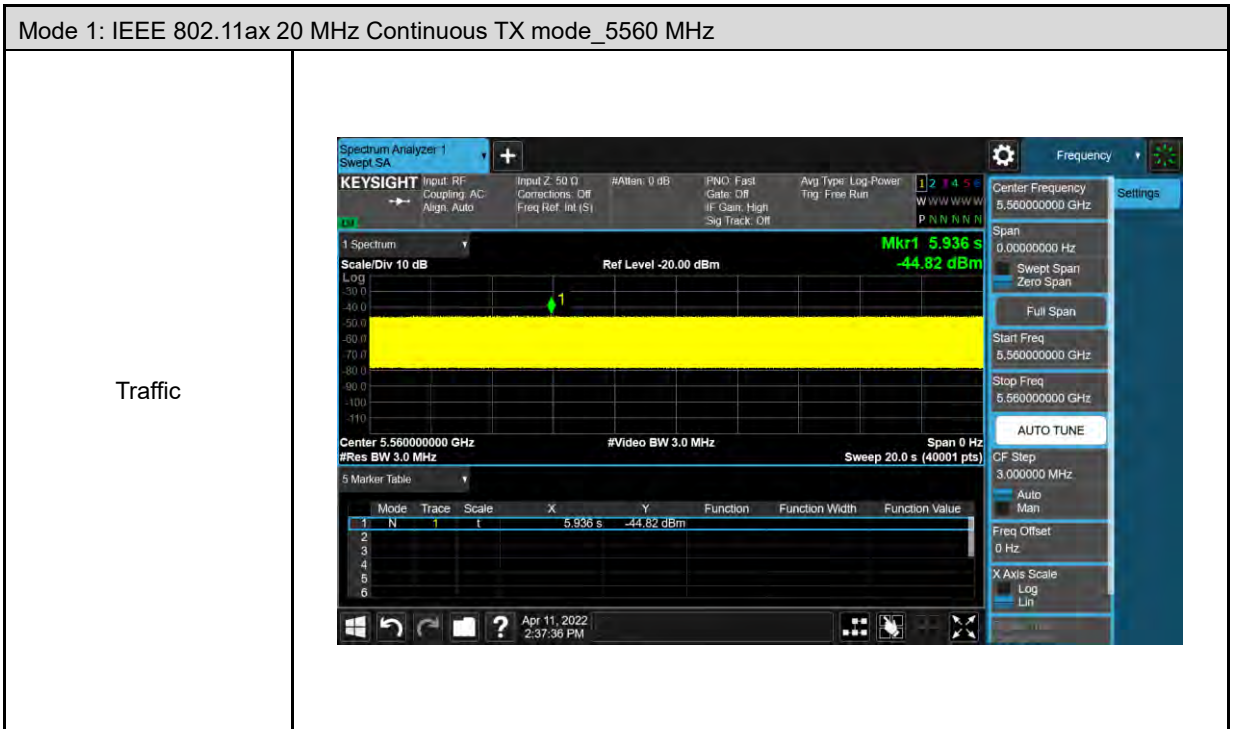

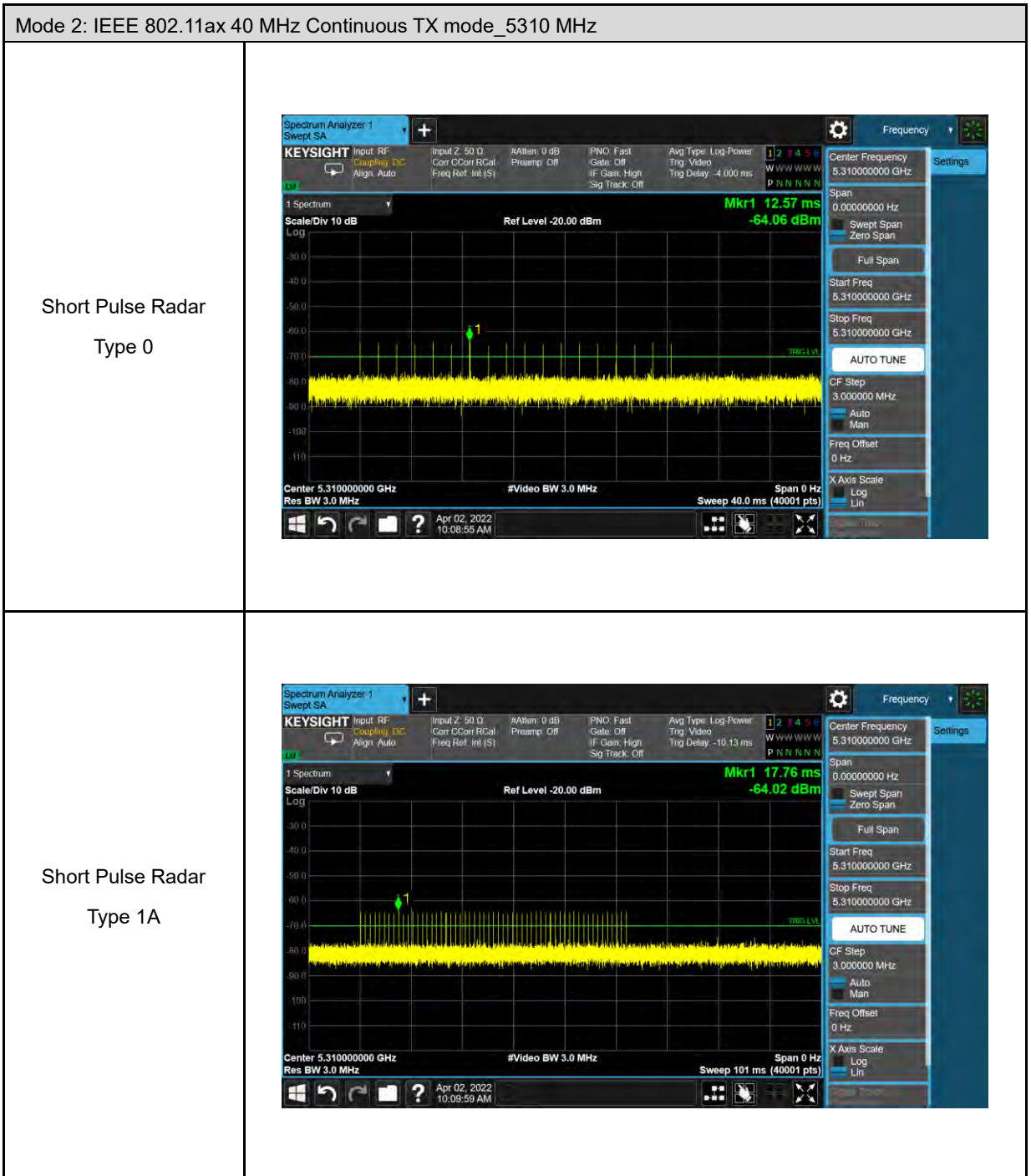

Mode 2: IEEE 802.11ax 40 MHz Continuous TX mode_5310 MHz

Short Pulse Radar
Type 1B

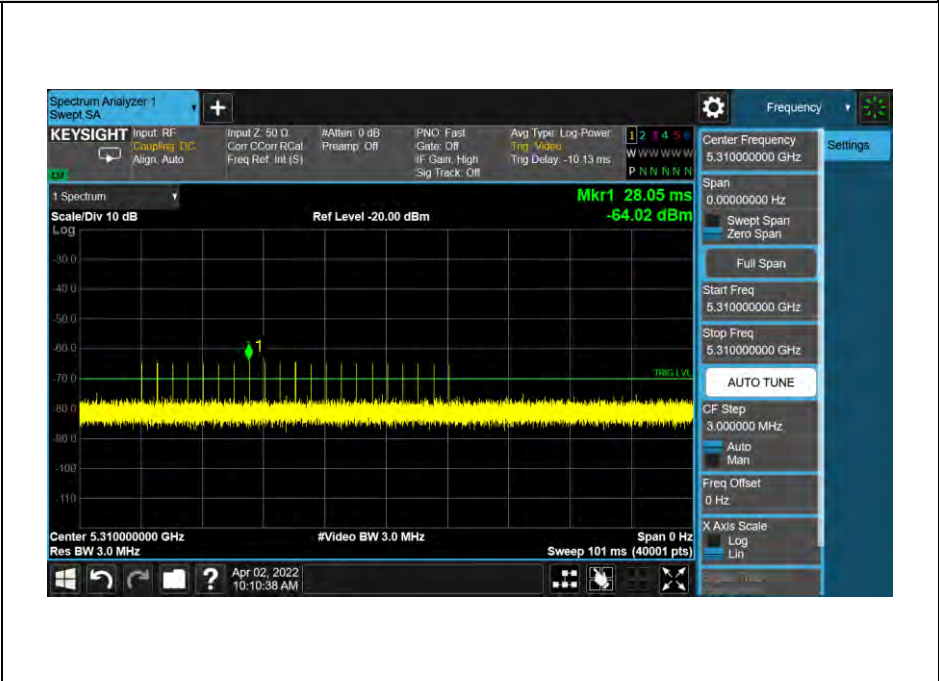

Short Pulse Radar
Type 2

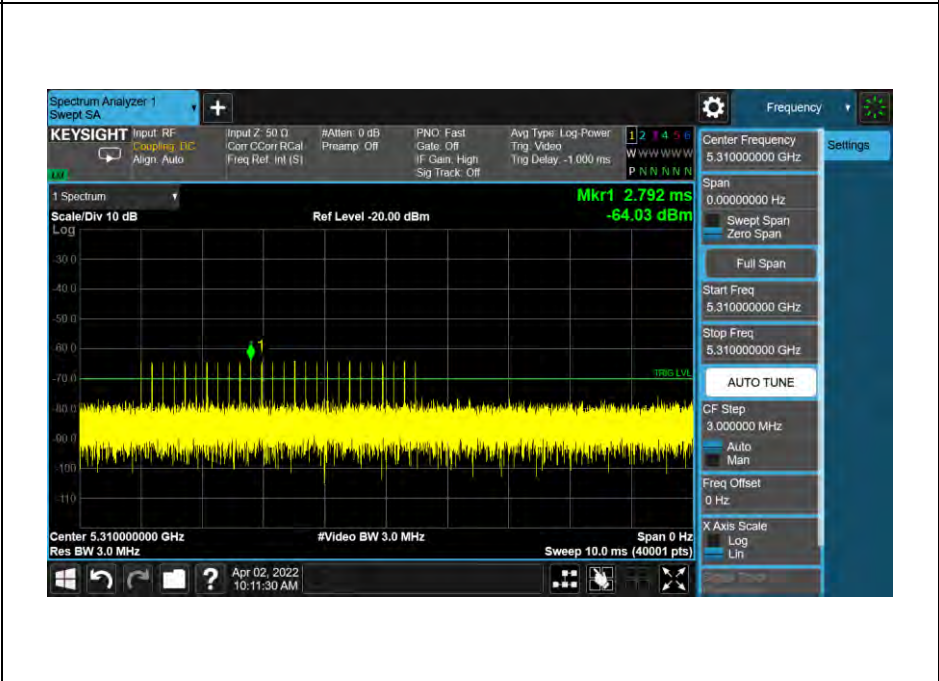

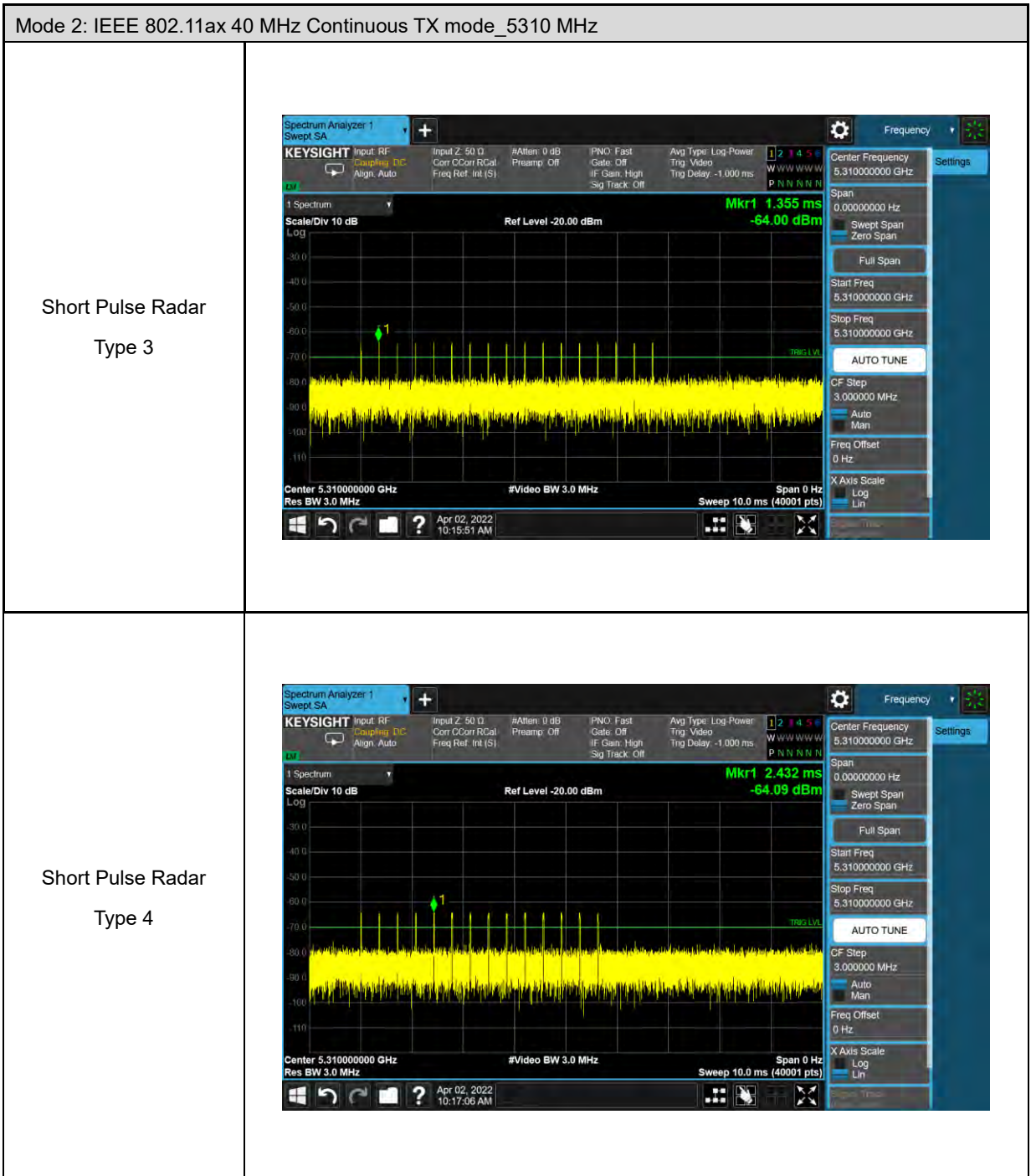

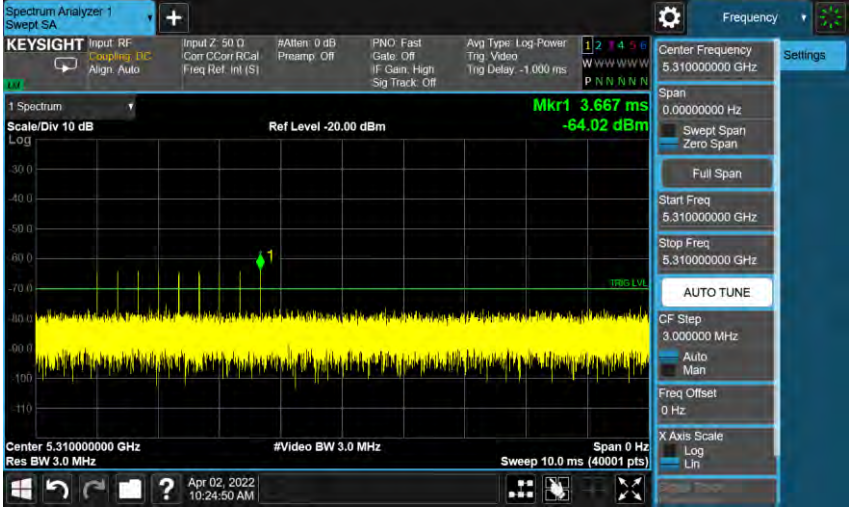
Mode 2: IEEE 802.11ax 40 MHz Continuous TX mode_5310 MHz	
<p>Long Pulse Radar Type 5</p>	 <p>The screenshot shows a Keysight Spectrum Analyzer interface. The main display is a log-log plot of power spectral density. A yellow signal is visible across the frequency range. A green marker 'Mkr1' is positioned at 2.330 s and -64.08 dBm. The center frequency is 5.310 GHz, video bandwidth is 3.0 MHz, and the sweep is 20.0 s. The reference level is -20.00 dBm. The plot shows a continuous signal with a marker at 2.330 s and -64.08 dBm. The center frequency is 5.310 GHz, video bandwidth is 3.0 MHz, and sweep is 20.0 s.</p>
<p>Frequency Hopping Radar Type 6</p>	 <p>The screenshot shows a Keysight Spectrum Analyzer interface. The main display is a log-log plot of power spectral density. A yellow signal is visible across the frequency range, showing frequency hopping. A green marker 'Mkr1' is positioned at 3.667 ms and -64.02 dBm. The center frequency is 5.310 GHz, video bandwidth is 3.0 MHz, and the sweep is 10.0 ms. The reference level is -20.00 dBm. The plot shows a signal with frequency hopping, with a marker at 3.667 ms and -64.02 dBm. The center frequency is 5.310 GHz, video bandwidth is 3.0 MHz, and sweep is 10.0 ms.</p>

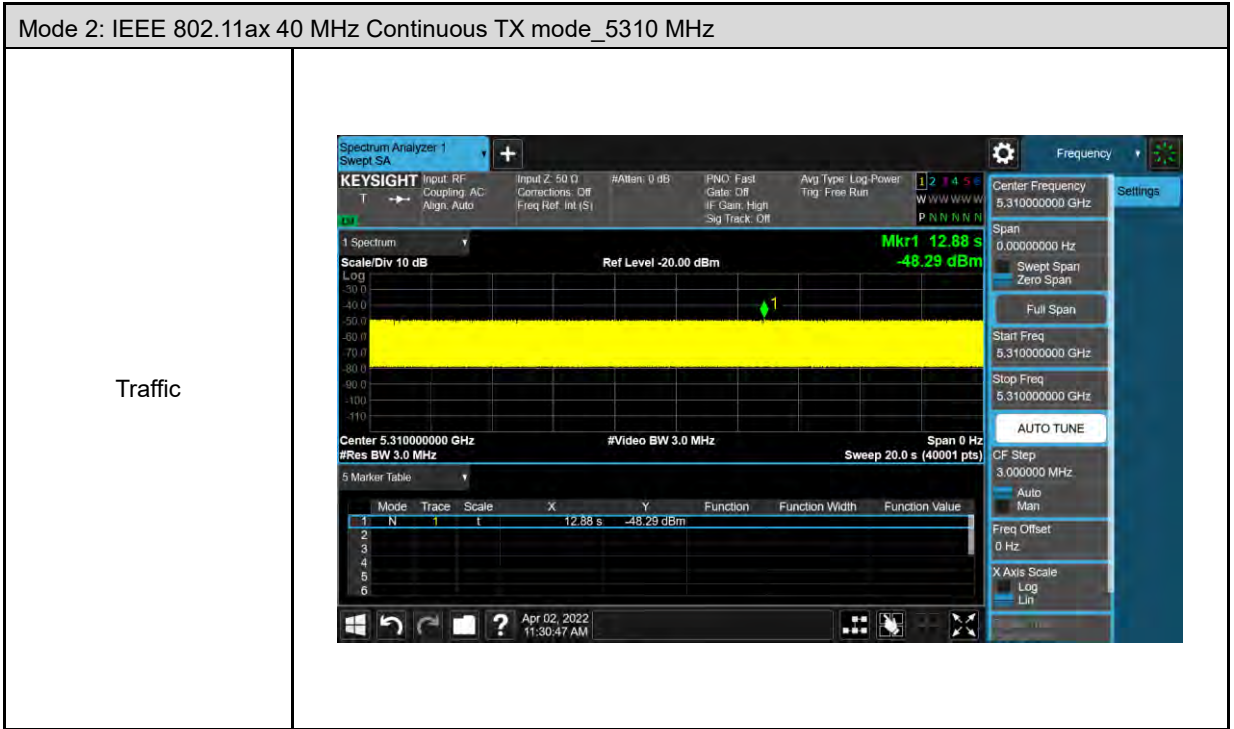

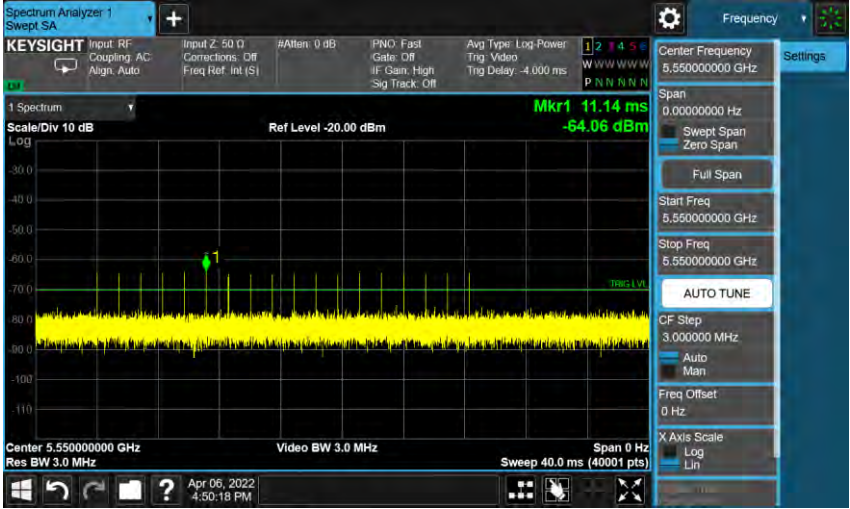
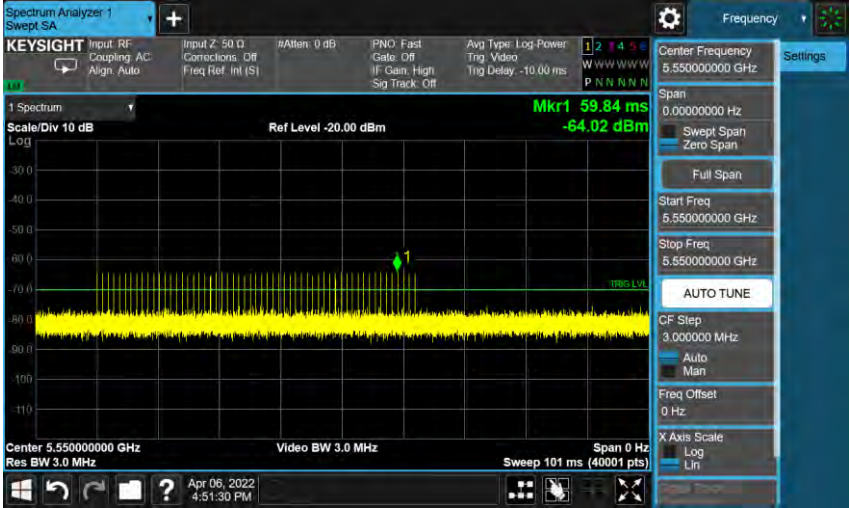
Mode 2: IEEE 802.11ax 40 MHz Continuous TX mode_5550 MHz	
<p>Short Pulse Radar Type 0</p>	 <p>KEYSIGHT Spectrum Analyzer 1 Swept SA</p> <p>Center Frequency: 5.550000000 GHz Span: 0.00000000 Hz Start Freq: 5.550000000 GHz Stop Freq: 5.550000000 GHz CF Step: 3.000000 MHz Freq Offset: 0 Hz X Axis Scale: Log Scale/Div: 10 dB Ref Level: -20.00 dBm Mkr1: 11.14 ms, -64.06 dBm Sweep: 40.0 ms (40001 pts) Video BW: 3.0 MHz Res BW: 3.0 MHz Apr 06, 2022 4:50:18 PM</p>
<p>Short Pulse Radar Type 1A</p>	 <p>KEYSIGHT Spectrum Analyzer 1 Swept SA</p> <p>Center Frequency: 5.550000000 GHz Span: 0.00000000 Hz Start Freq: 5.550000000 GHz Stop Freq: 5.550000000 GHz CF Step: 3.000000 MHz Freq Offset: 0 Hz X Axis Scale: Log Scale/Div: 10 dB Ref Level: -20.00 dBm Mkr1: 59.84 ms, -64.02 dBm Sweep: 101 ms (40001 pts) Video BW: 3.0 MHz Res BW: 3.0 MHz Apr 06, 2022 4:51:30 PM</p>

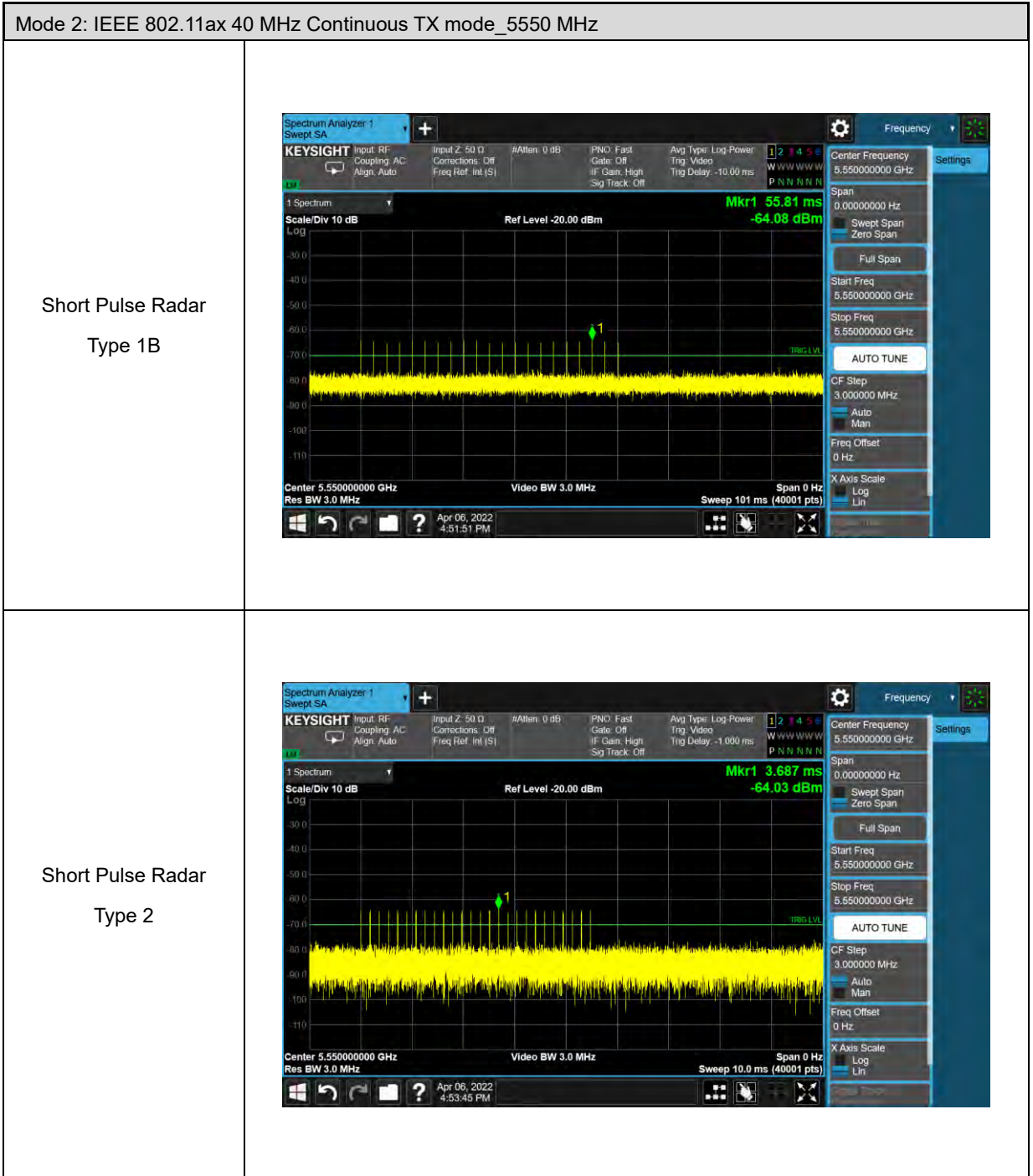

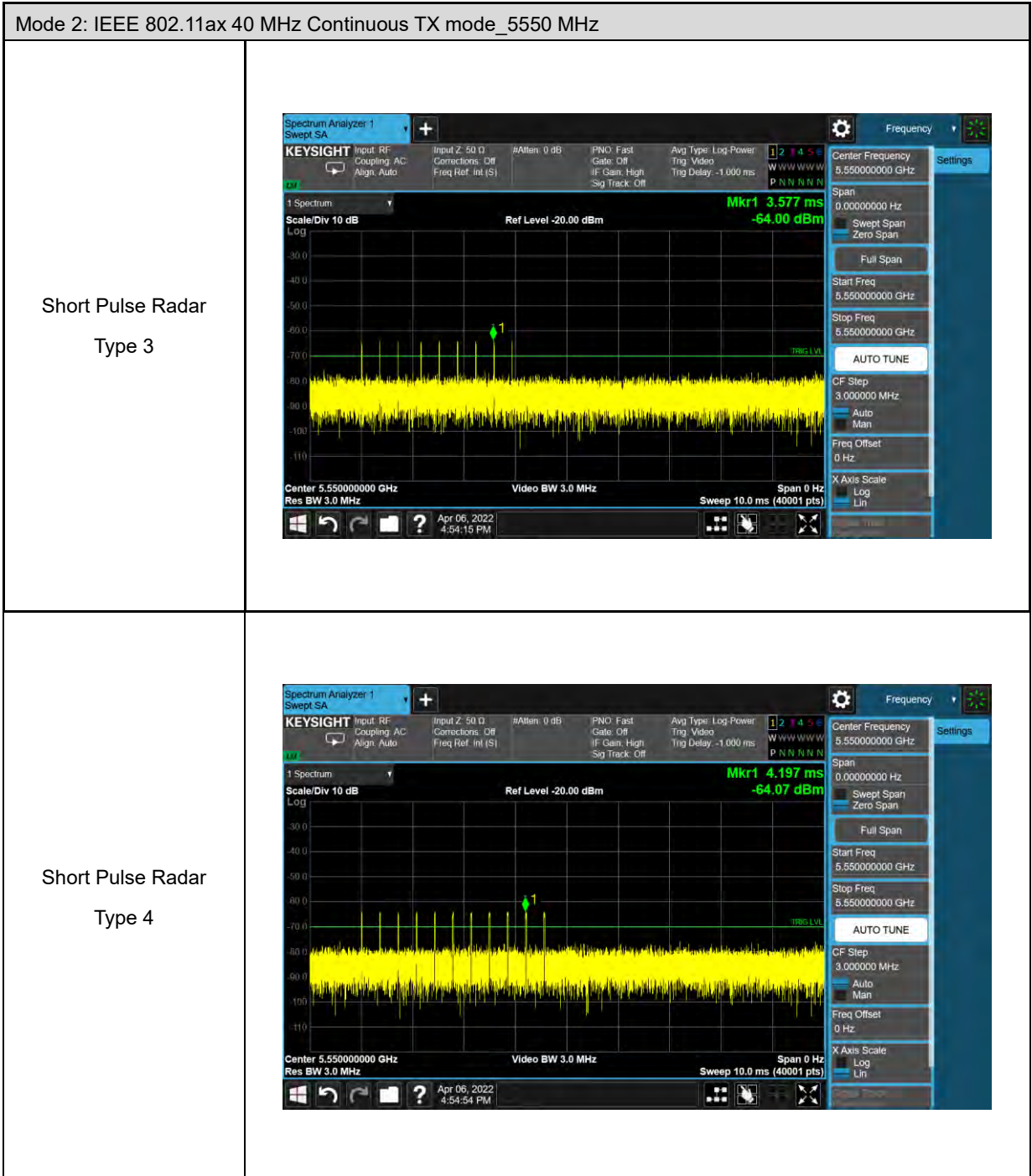

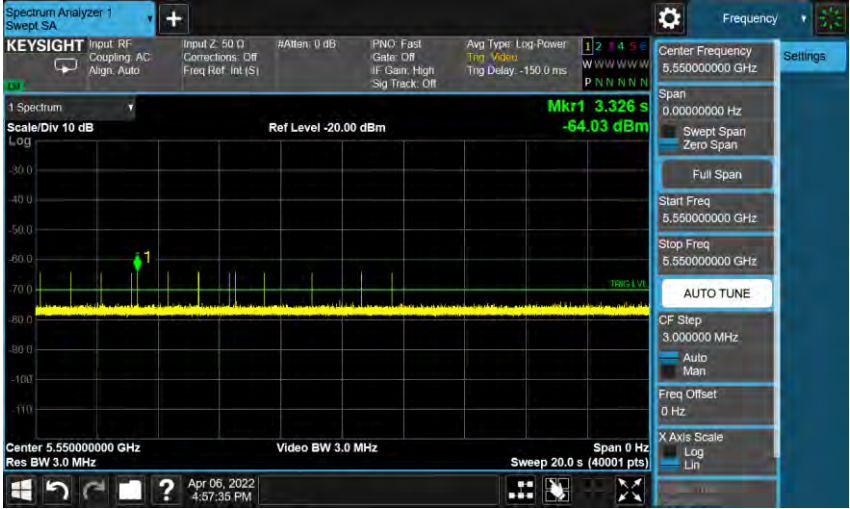
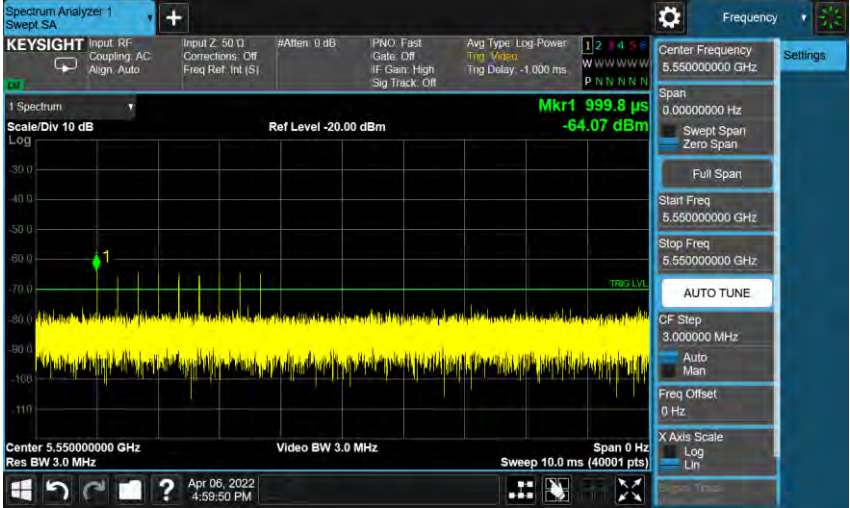

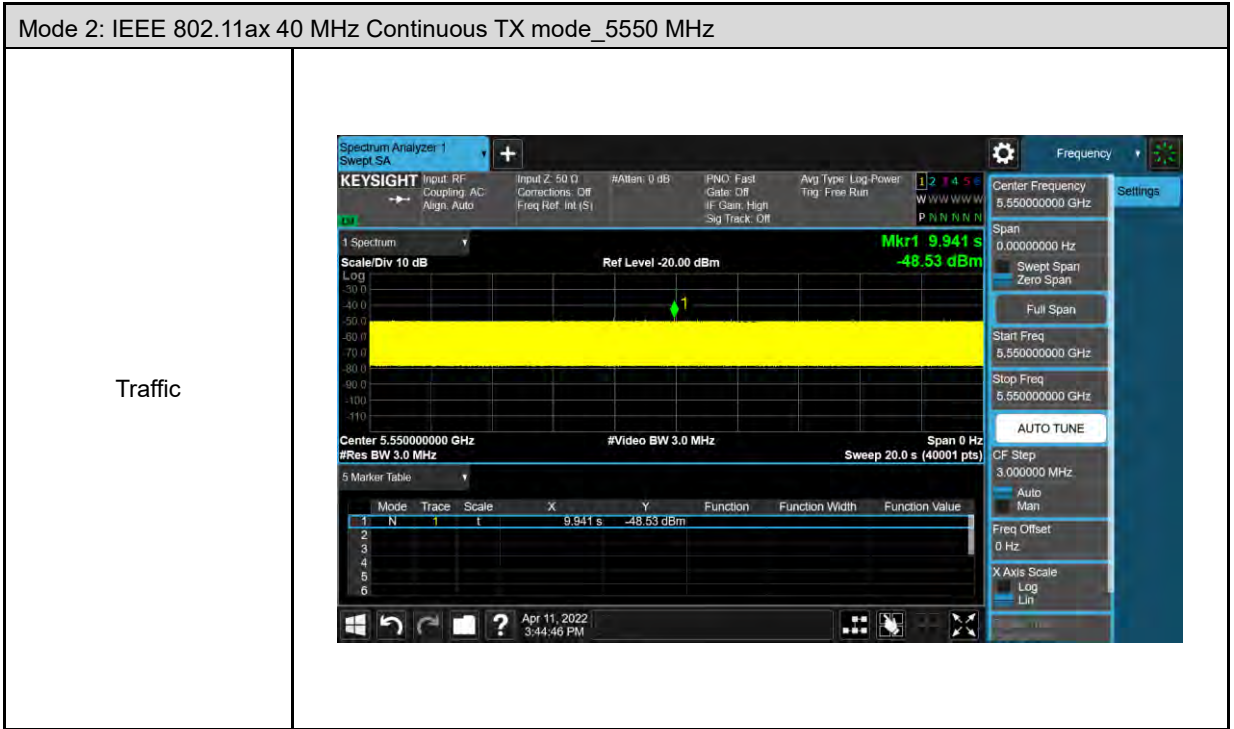
Mode 2: IEEE 802.11ax 40 MHz Continuous TX mode_5550 MHz	
<p>Long Pulse Radar Type 5</p>	 <p>The screenshot shows a Keysight Spectrum Analyzer interface. The main display is a spectrum plot with a yellow signal line. A marker 'Mkr1' is positioned at 3.326 s and -64.03 dBm. The center frequency is 5.550000000 GHz, video bandwidth is 3.0 MHz, and the sweep is 20.0 s. The plot shows a continuous signal with some noise. The right-hand side of the screen contains various settings like Span, Start Freq, Stop Freq, and CF Step.</p>
<p>Frequency Hopping Radar Type 6</p>	 <p>The screenshot shows a Keysight Spectrum Analyzer interface. The main display is a spectrum plot with a yellow signal line. A marker 'Mkr1' is positioned at 999.8 μs and -64.07 dBm. The center frequency is 5.550000000 GHz, video bandwidth is 3.0 MHz, and the sweep is 10.0 ms. The plot shows a signal with a hopping pattern. The right-hand side of the screen contains various settings like Span, Start Freq, Stop Freq, and CF Step.</p>

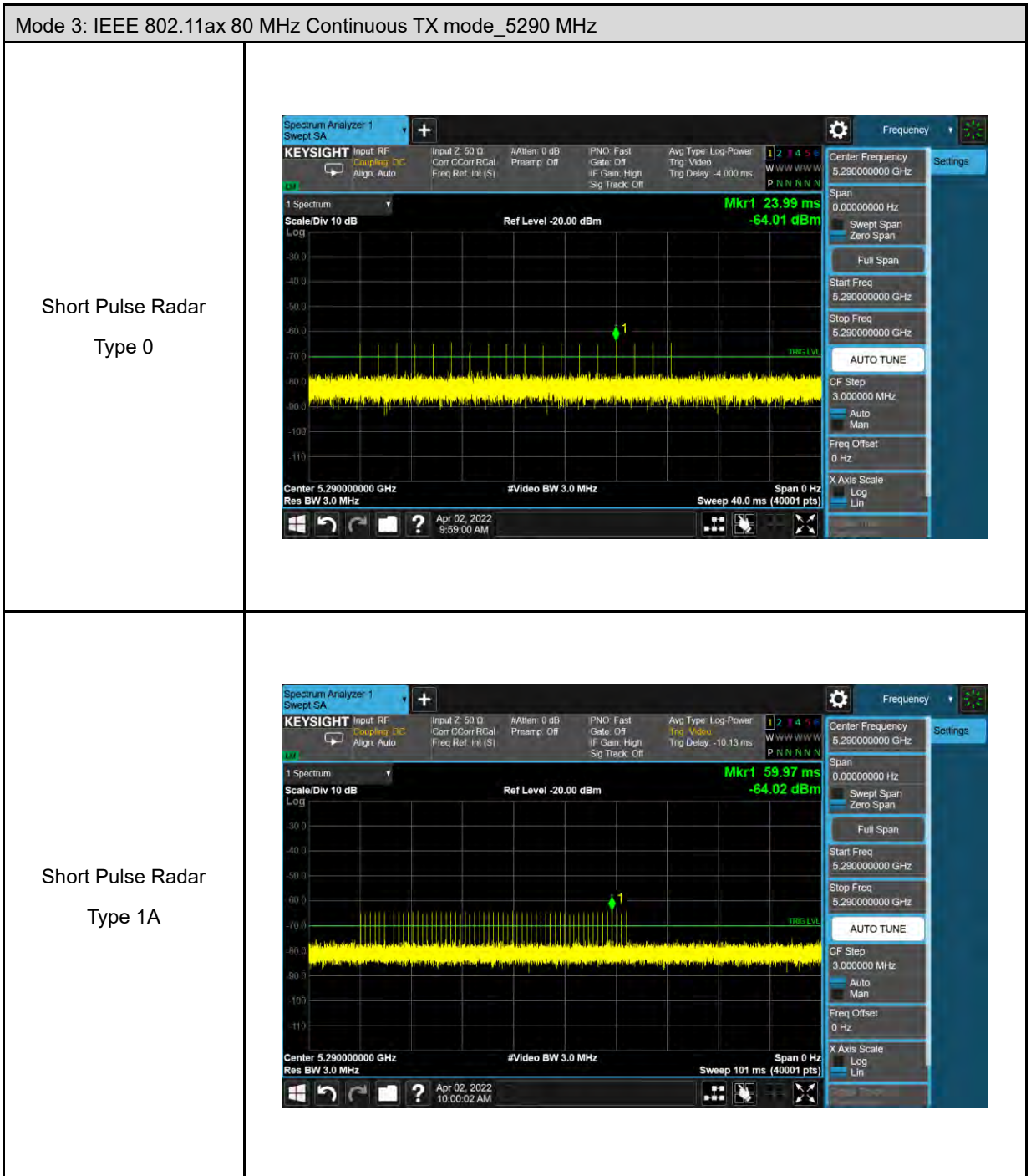

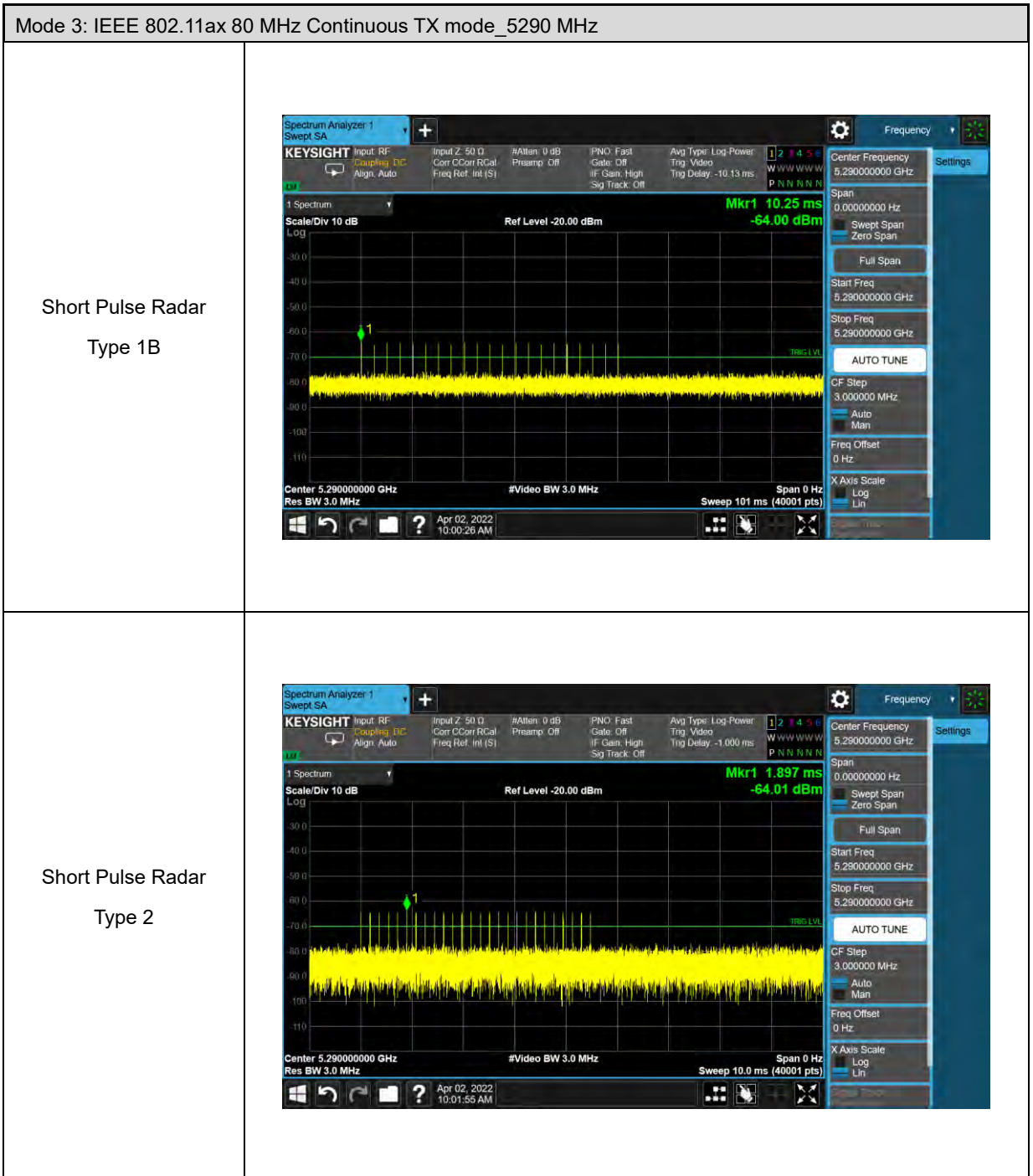

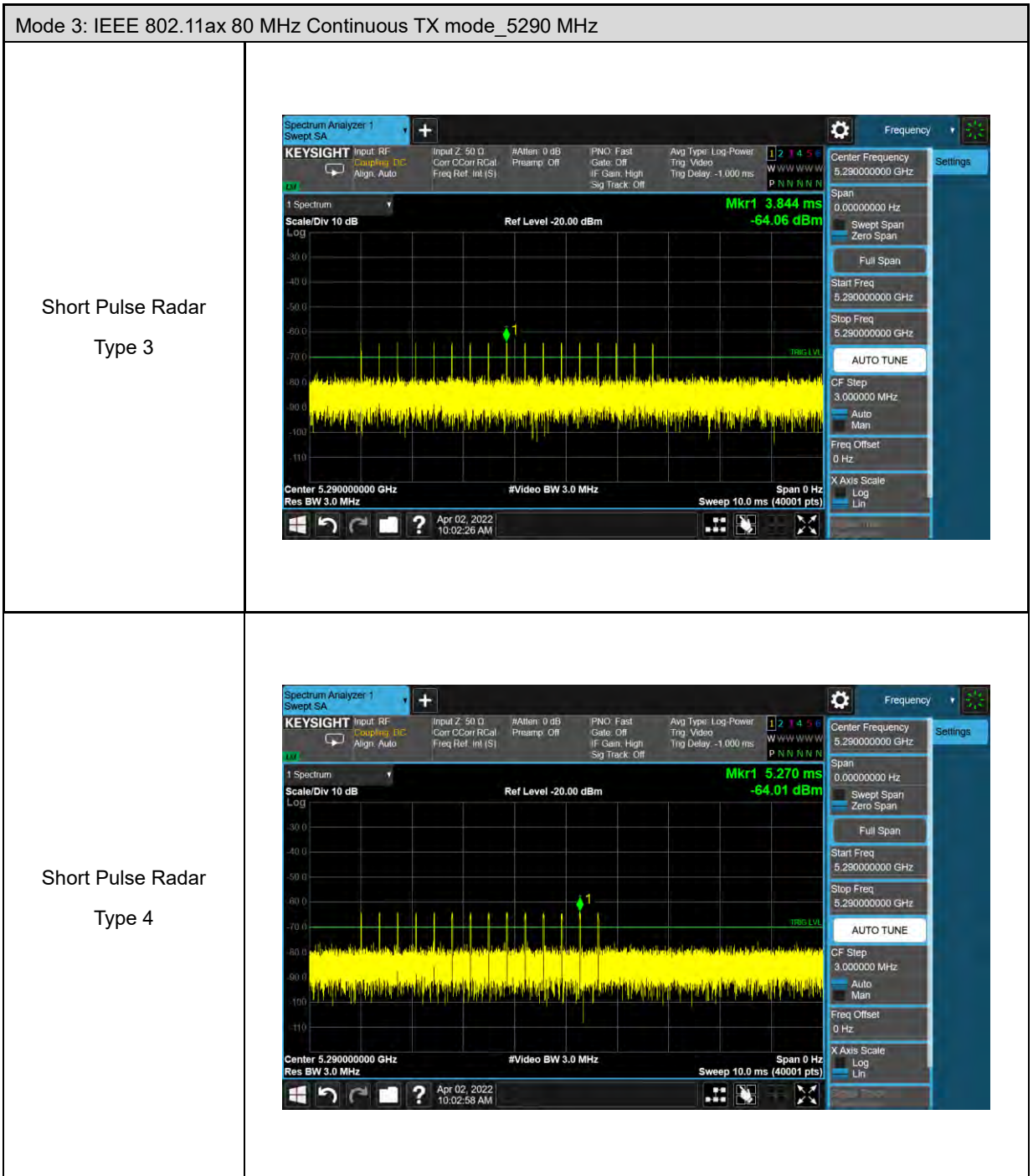



Mode 3: IEEE 802.11ax 80 MHz Continuous TX mode_5290 MHz	
<p>Long Pulse Radar Type 5</p>	 <p>KEYSIGHT Spectrum Analyzer 1 Swept SA</p> <p>Center Frequency: 5.290000000 GHz Span: 0.00000000 Hz Start Freq: 5.290000000 GHz Stop Freq: 5.290000000 GHz Sweep: 20.0 s (40001 pts)</p> <p>Mkr1 7.690 s -64.08 dBm</p>
<p>Frequency Hopping Radar Type 6</p>	 <p>KEYSIGHT Spectrum Analyzer 1 Swept SA</p> <p>Center Frequency: 5.290000000 GHz Span: 0.00000000 Hz Start Freq: 5.290000000 GHz Stop Freq: 5.290000000 GHz Sweep: 10.0 ms (40001 pts)</p> <p>Mkr1 2.334 ms -64.06 dBm</p>

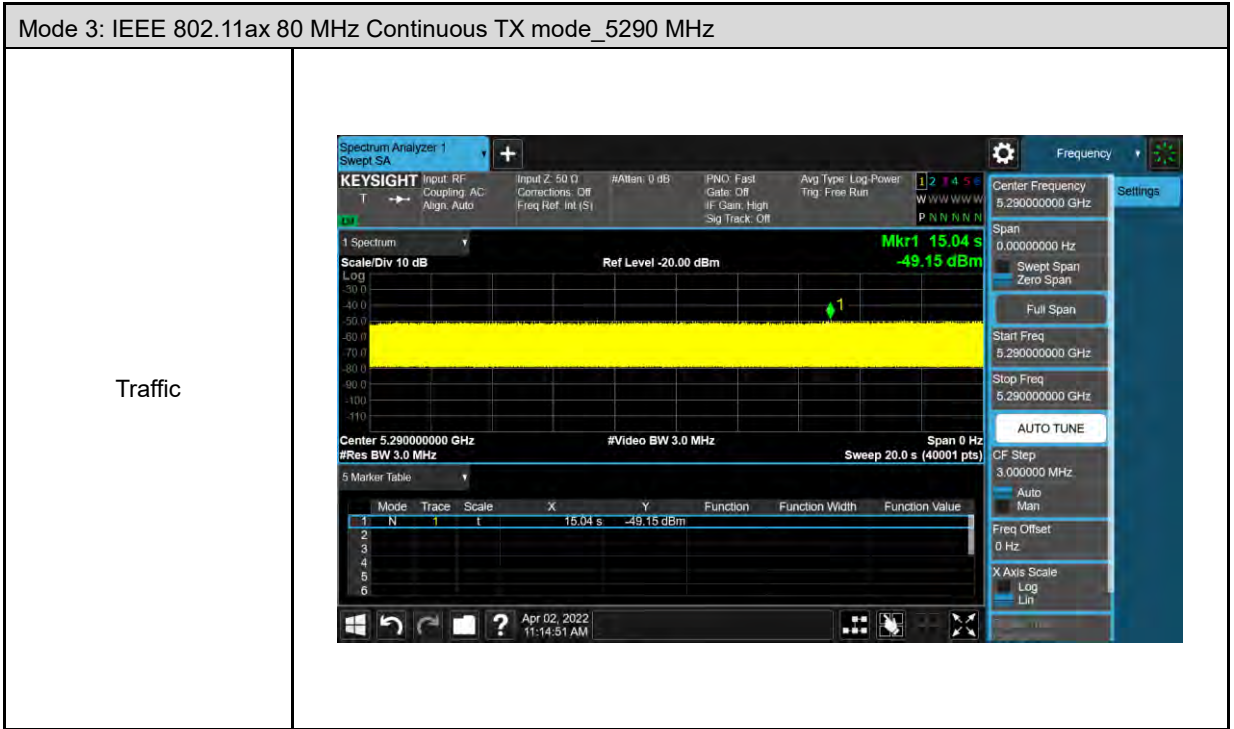

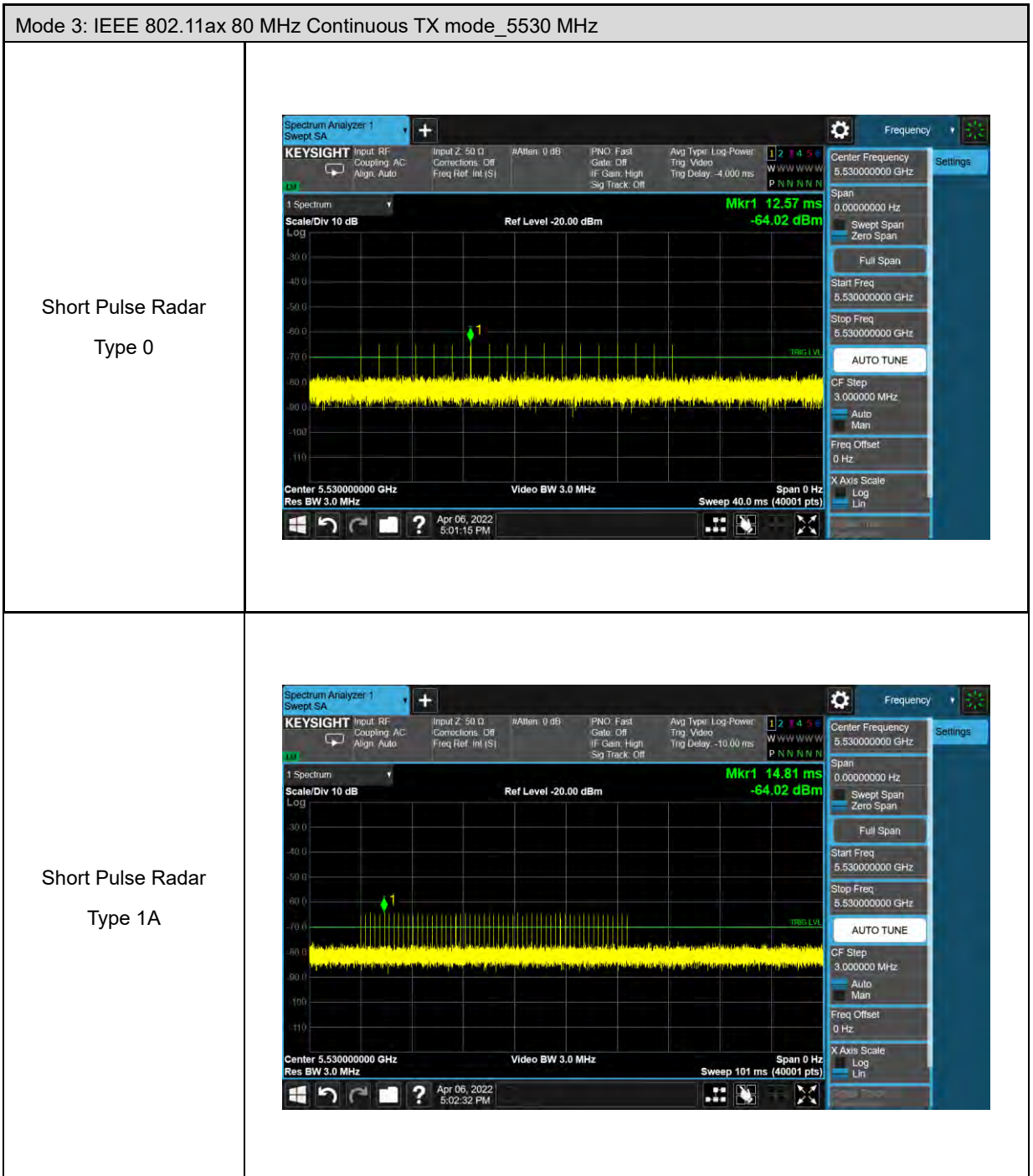

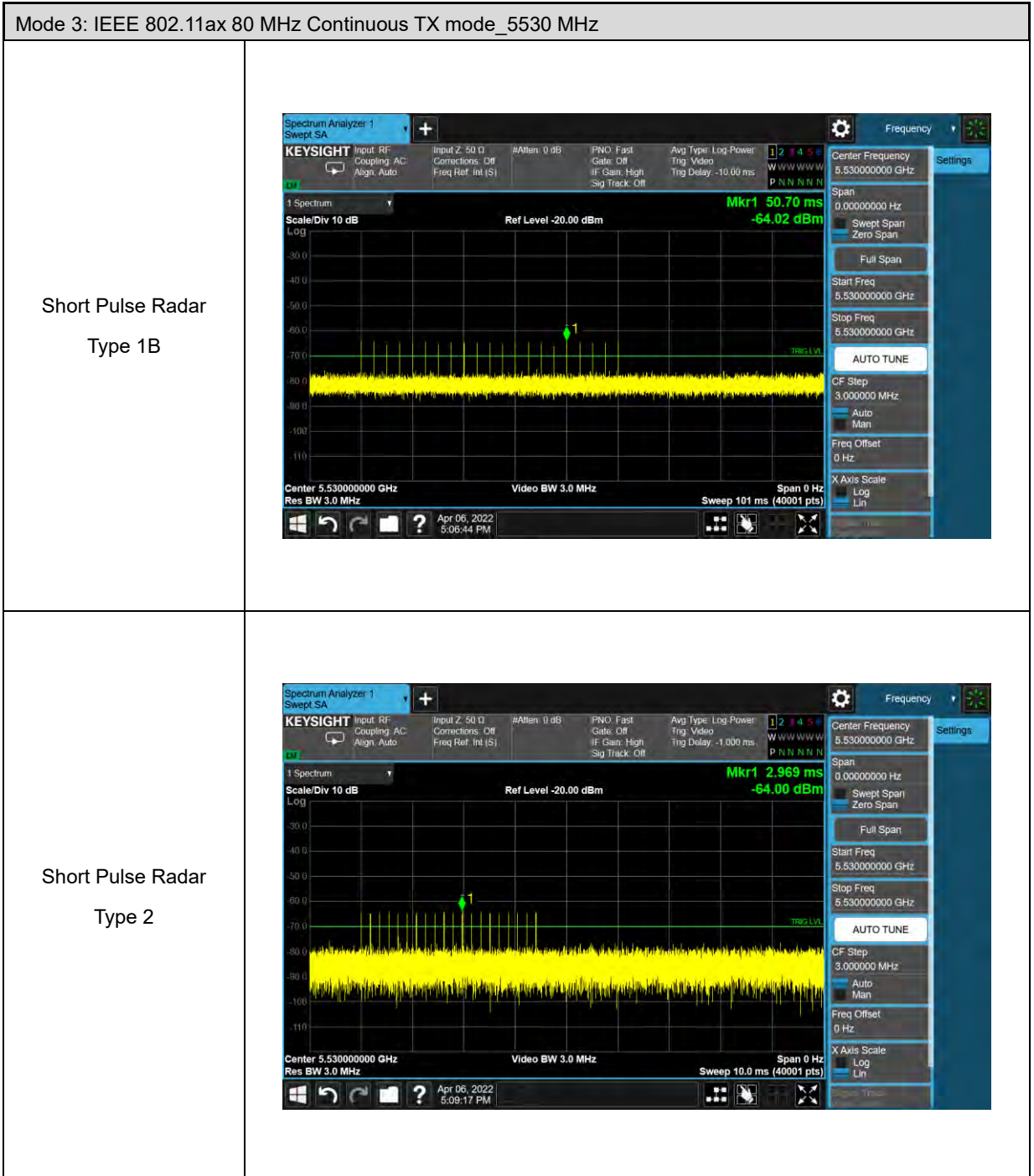

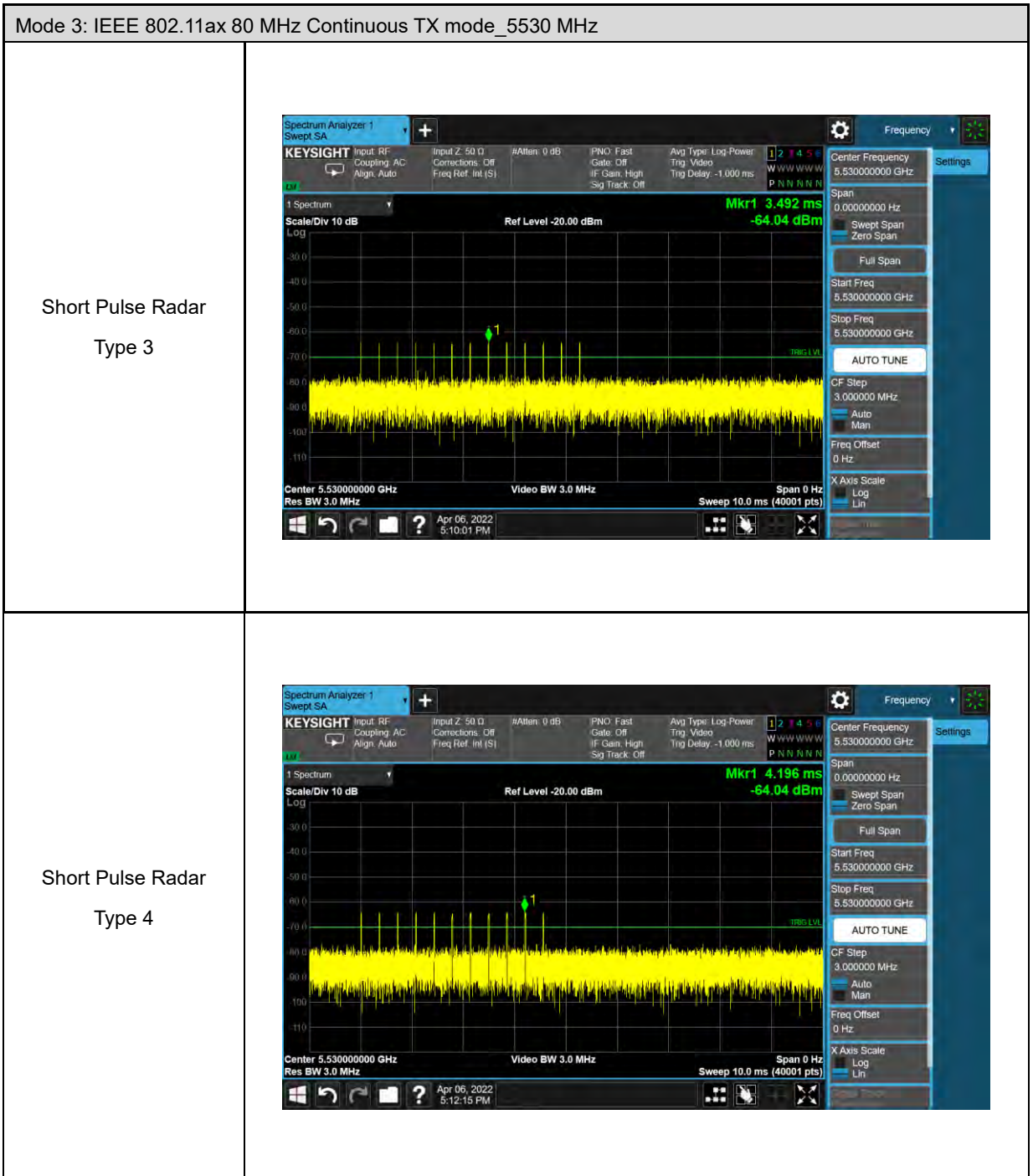

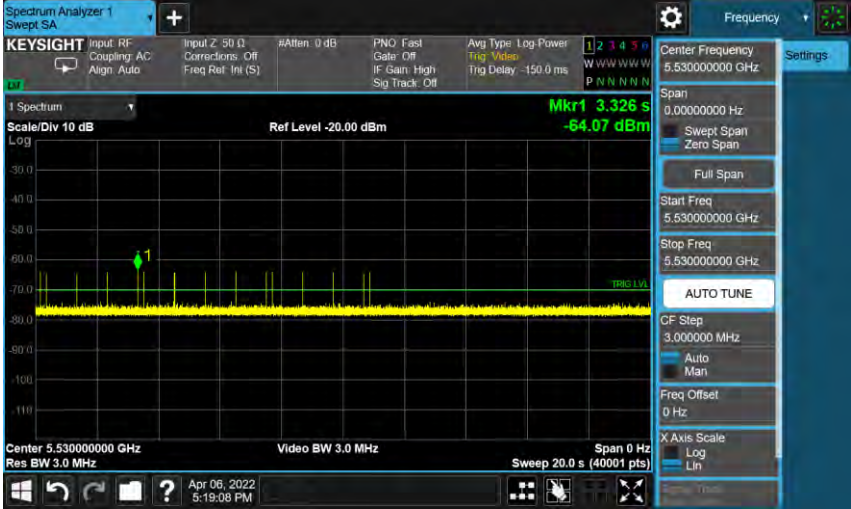
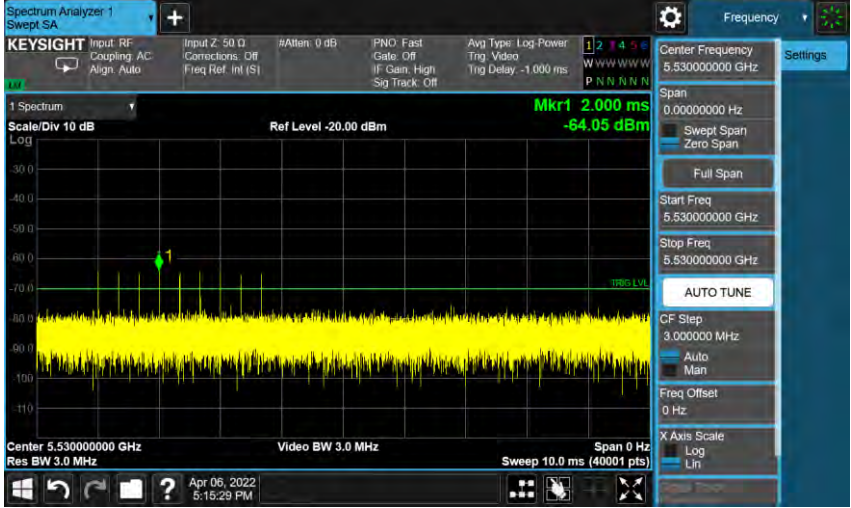

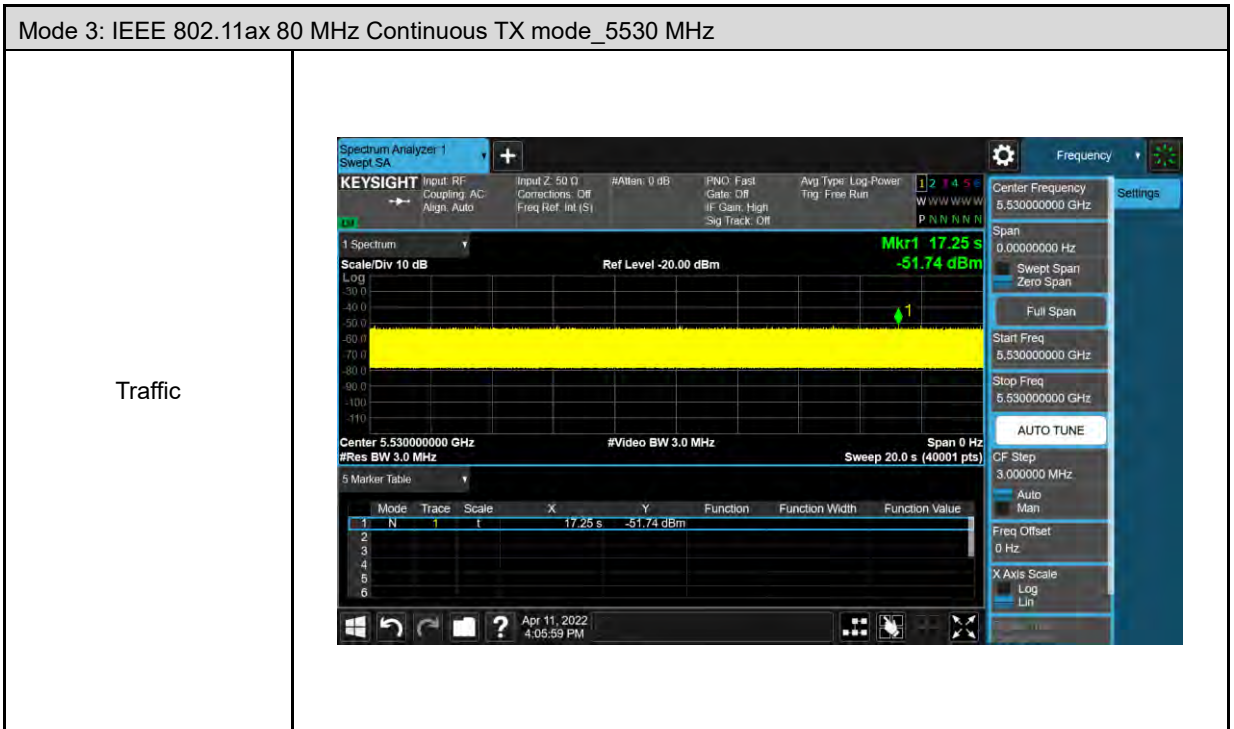

Mode 3: IEEE 802.11ax 80 MHz Continuous TX mode_5330 MHz	
<p>Long Pulse Radar Type 5</p>	 <p>The screenshot shows a Keysight Spectrum Analyzer interface. The main display is a spectrum plot with a center frequency of 5.530000000 GHz and a span of 0 Hz. A signal is visible at 5.530 GHz with a power level of -64.07 dBm. The sweep rate is 20.0 s. The plot shows a signal with a peak at 5.530 GHz and a power level of -64.07 dBm. The plot also shows a noise floor at approximately -80 dBm. The plot is titled 'Spectrum Analyzer 1 Swept SA'.</p>
<p>Frequency Hopping Radar Type 6</p>	 <p>The screenshot shows a Keysight Spectrum Analyzer interface. The main display is a spectrum plot with a center frequency of 5.530000000 GHz and a span of 0 Hz. A signal is visible at 5.530 GHz with a power level of -64.05 dBm. The sweep rate is 10.0 ms. The plot shows a signal with a peak at 5.530 GHz and a power level of -64.05 dBm. The plot also shows a noise floor at approximately -80 dBm. The plot is titled 'Spectrum Analyzer 1 Swept SA'.</p>

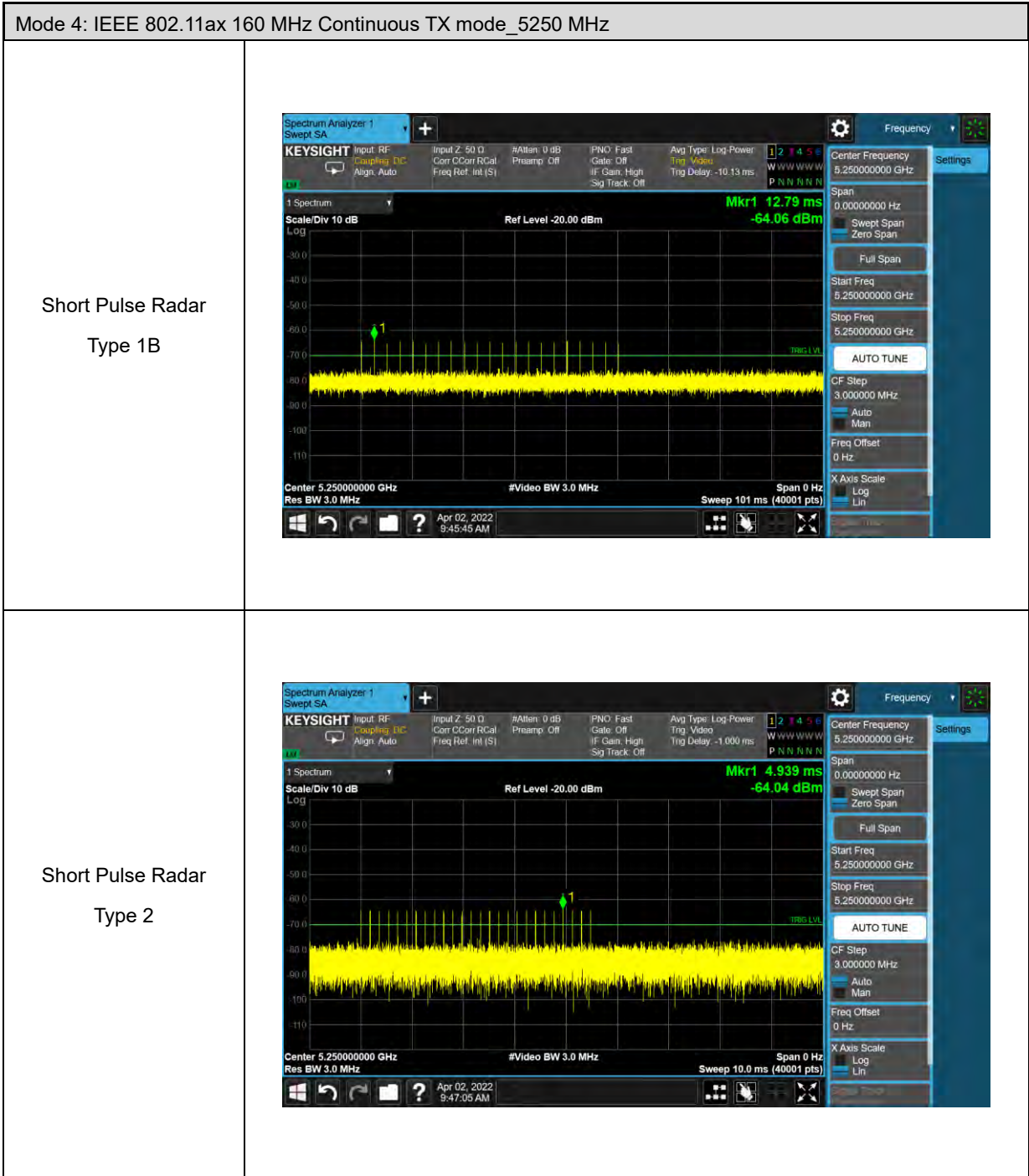

Mode 4: IEEE 802.11ax 160 MHz Continuous TX mode_5250 MHz	
<p>Short Pulse Radar Type 0</p>	 <p>The screenshot shows a Keysight Spectrum Analyzer interface. The main display is a spectrum plot with a yellow signal trace. A marker 'Mkr1' is positioned at 28.27 ms and -64.00 dBm. The center frequency is 5.250000000 GHz, and the video bandwidth is 3.0 MHz. The sweep rate is 40.0 ms. The plot shows a series of pulses over time.</p>
<p>Short Pulse Radar Type 1A</p>	 <p>The screenshot shows a Keysight Spectrum Analyzer interface. The main display is a spectrum plot with a yellow signal trace. A marker 'Mkr1' is positioned at 13.07 ms and -64.09 dBm. The center frequency is 5.250000000 GHz, and the video bandwidth is 3.0 MHz. The sweep rate is 101 ms. The plot shows a series of pulses over time.</p>

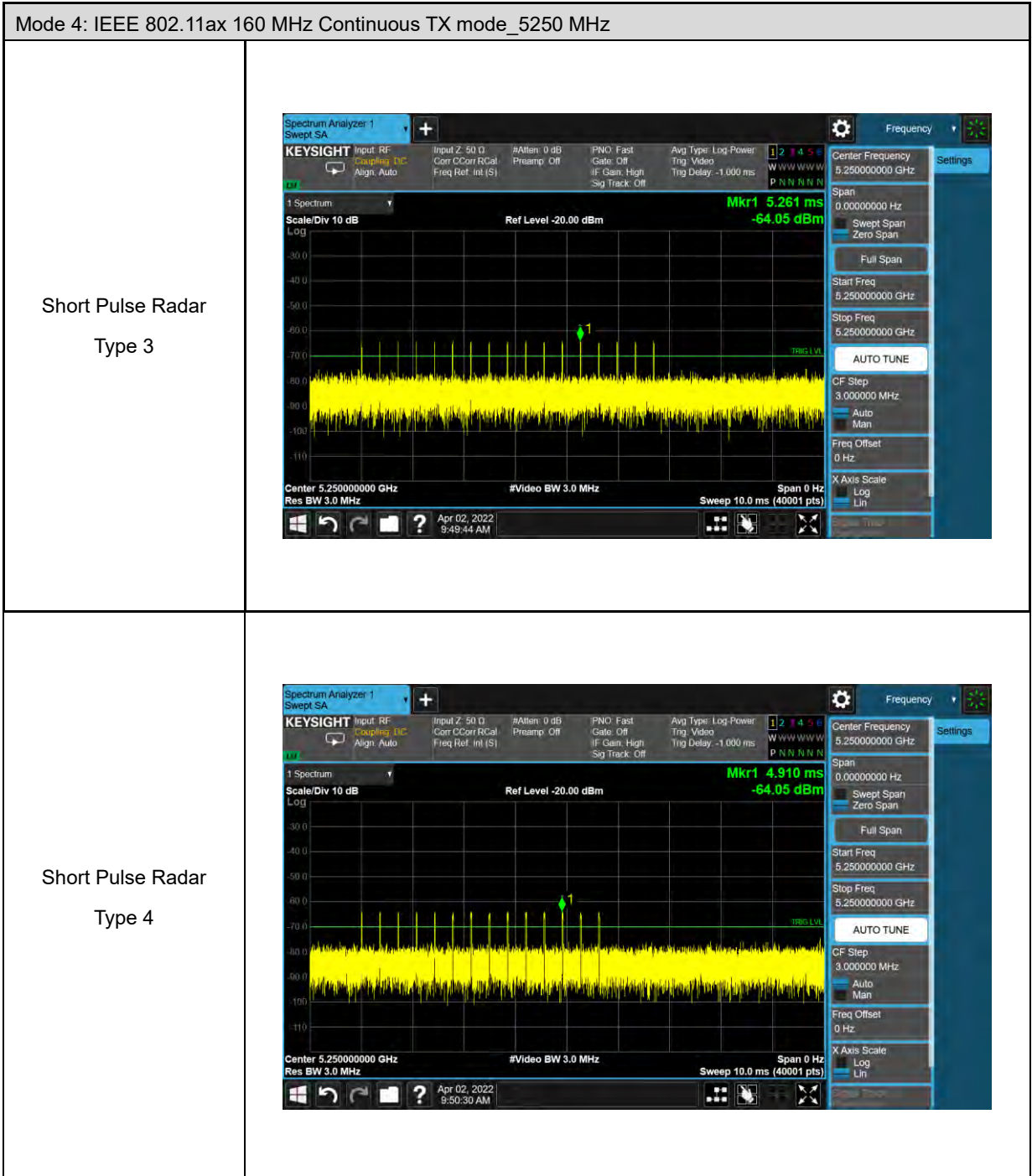

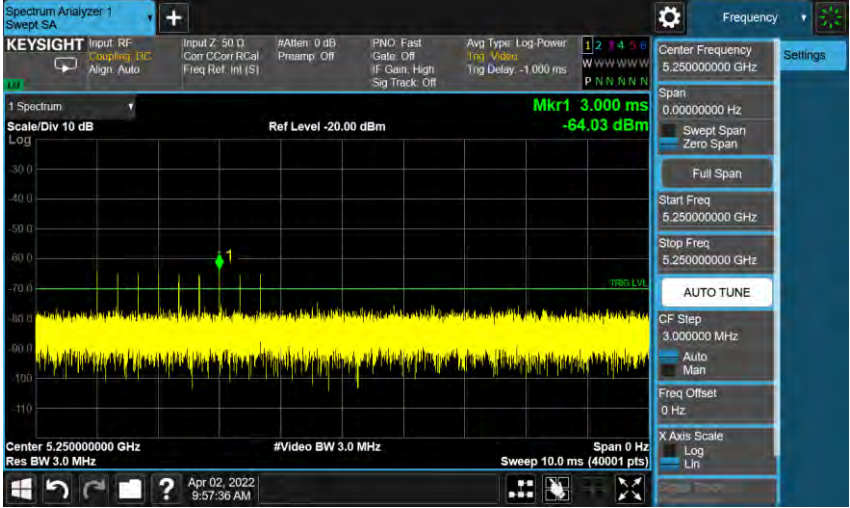

Mode 4: IEEE 802.11ax 160 MHz Continuous TX mode_5250 MHz	
<p>Long Pulse Radar Type 5</p>	 <p>The screenshot shows a Keysight Spectrum Analyzer interface. The main display is a spectrum plot with a yellow signal trace. A marker 'Mkr1' is positioned at 13.07 s and -64.01 dBm. The plot parameters include a center frequency of 5.250000000 GHz, a video bandwidth of 3.0 MHz, and a sweep of 20.0 s. The plot scale is 10 dB. The interface also shows various settings like input Z, #Atten, PNO, and Avg Type.</p>
<p>Frequency Hopping Radar Type 6</p>	 <p>The screenshot shows a Keysight Spectrum Analyzer interface. The main display is a spectrum plot with a yellow signal trace. A marker 'Mkr1' is positioned at 3.000 ms and -64.03 dBm. The plot parameters include a center frequency of 5.250000000 GHz, a video bandwidth of 3.0 MHz, and a sweep of 10.0 ms. The plot scale is 10 dB. The interface also shows various settings like input Z, #Atten, PNO, and Avg Type.</p>

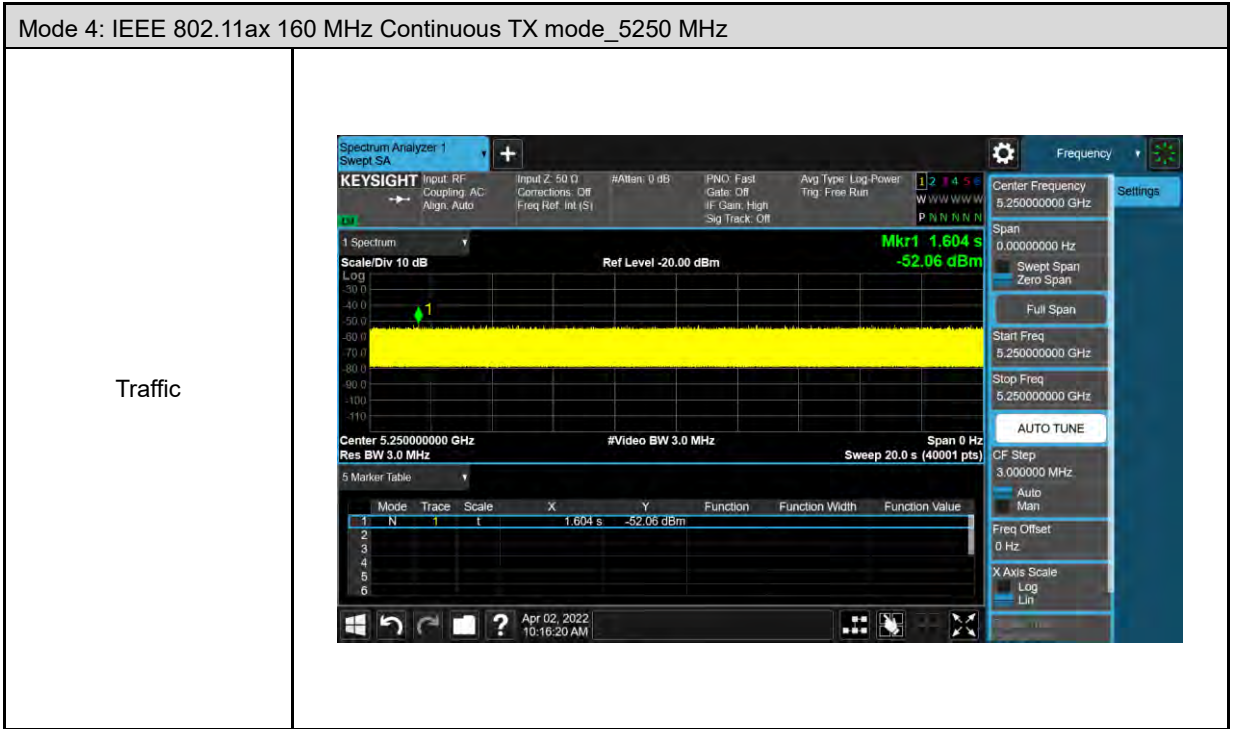

5.2. Channel Loading

LowBand

■ Duty cycle $\geq 17\%$

Mode 1: IEEE 802.11ax 20 MHz Continuous TX mode



Mode 2: IEEE 802.11ax 40 MHz Continuous TX mode

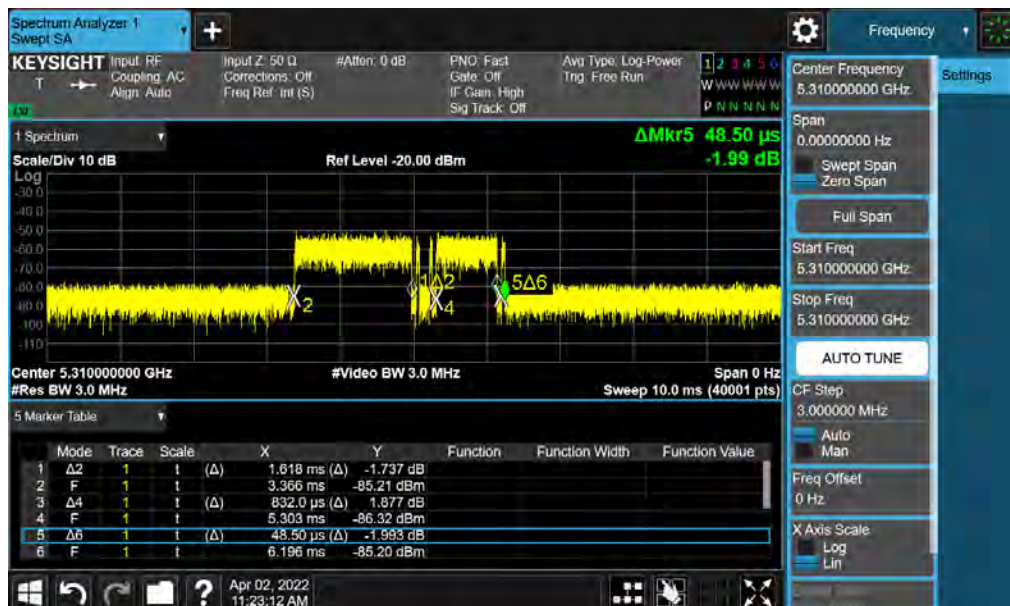

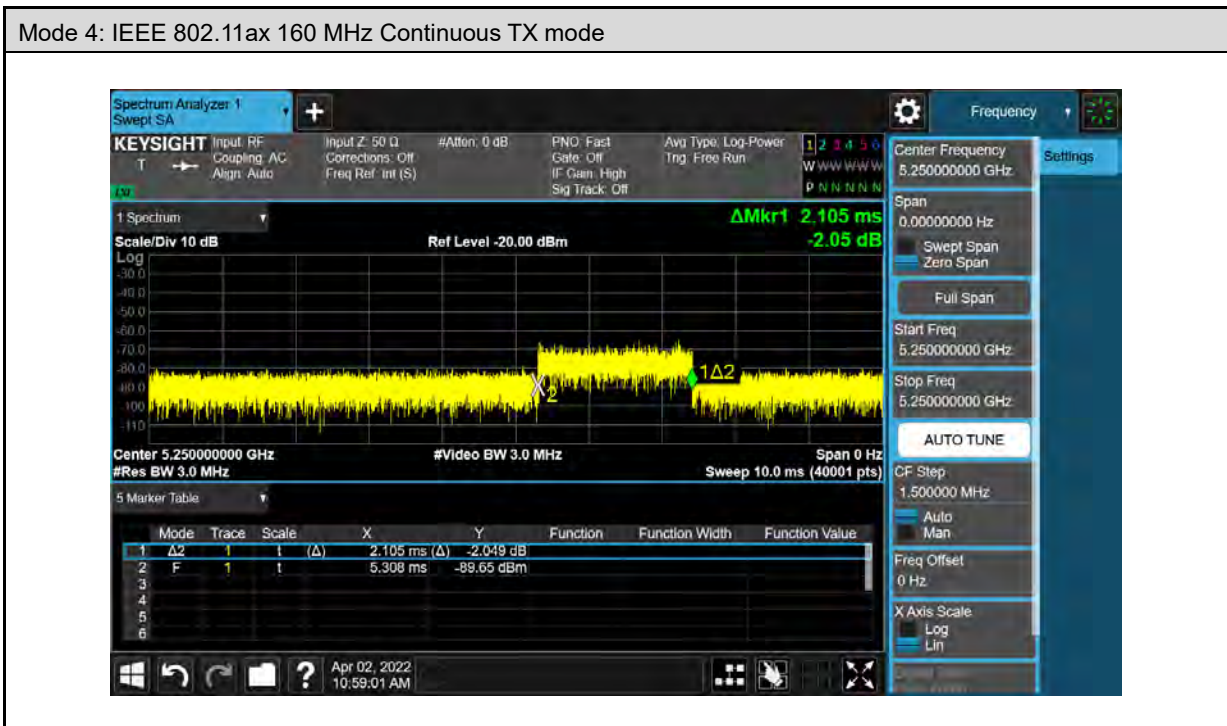
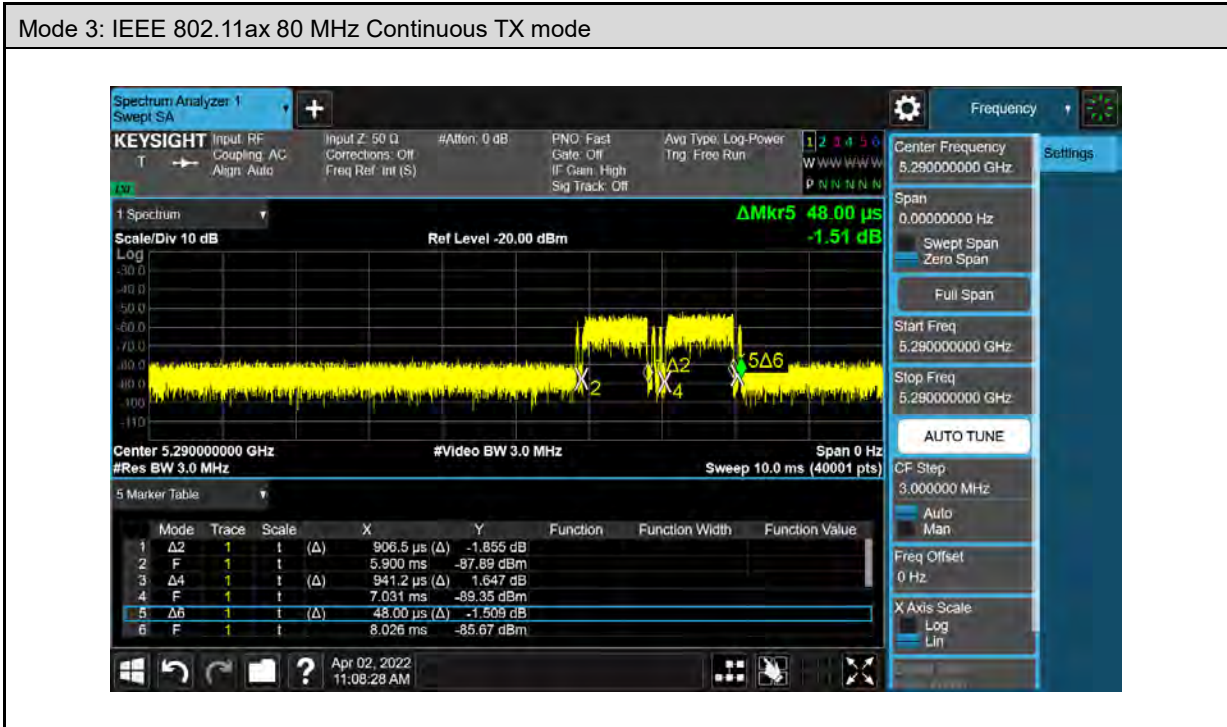

HighBand

■ Duty cycle $\geq 17\%$

Mode 1: IEEE 802.11ax 20 MHz Continuous TX mode

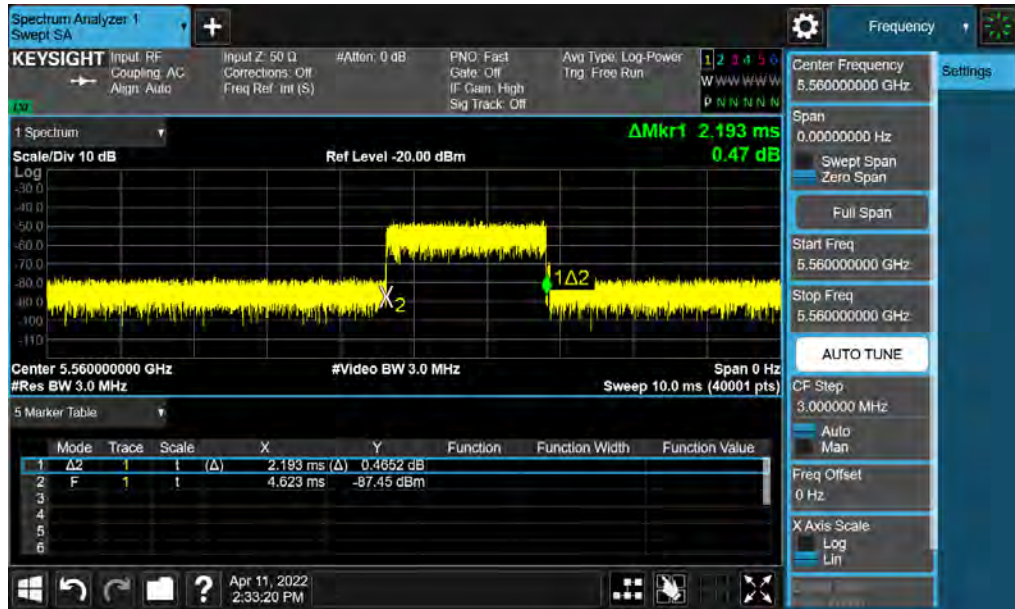

Mode 2: IEEE 802.11ax 40 MHz Continuous TX mode

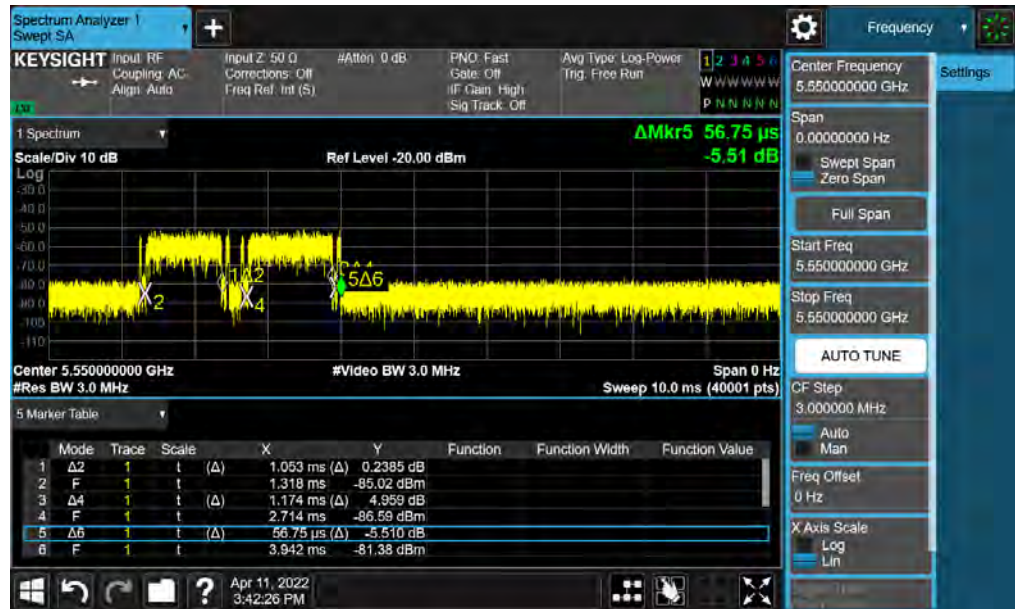

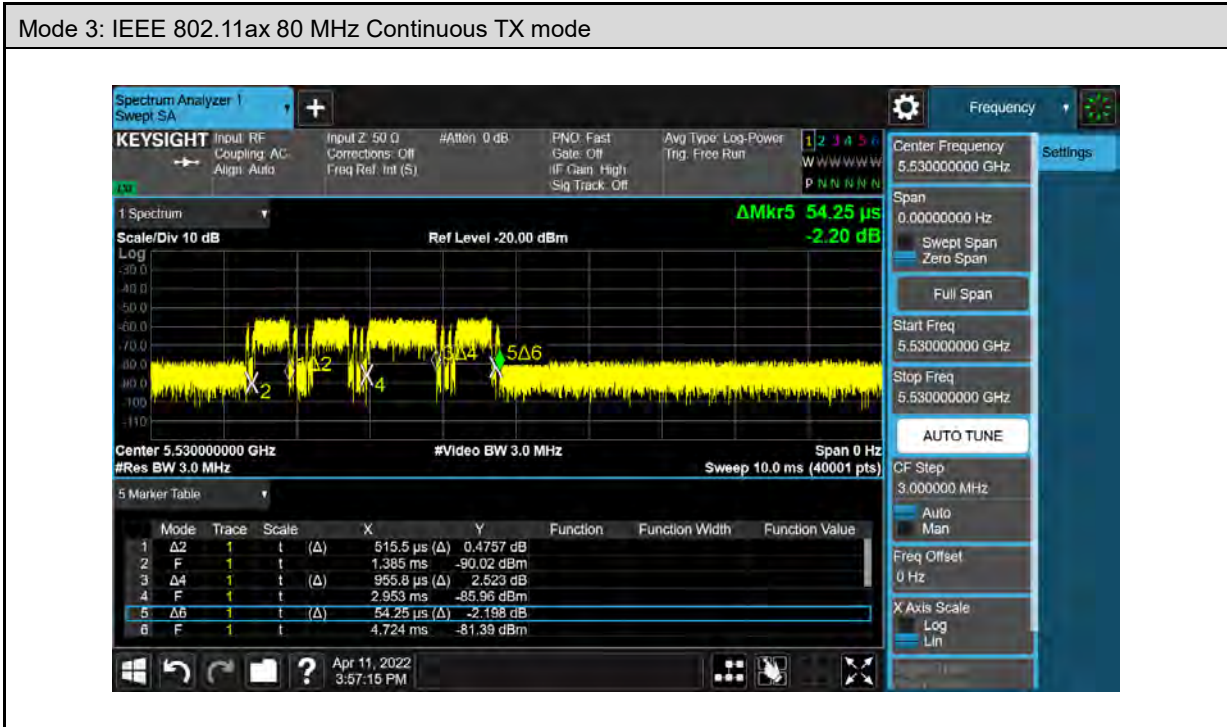

5.3. Channel Availability Check Time

5.3.1. Procedure to Determine Initial Power-Up Cycle Time

A link was established on channel then the EUT was rebooted. The time from the cessation of traffic to the re-initialization of traffic was measured as the time required for the EUT to complete the total power-up cycle. The time to complete the initial power-up period is 60 seconds less than this total power-up time.

5.3.2. Procedure for Timing Of Radar Burst

With a link established on channel, the EUT was rebooted. A radar signal was triggered within 0 to 6 seconds after the initial power-up period, and transmissions on the channel were monitored on the spectrum analyzer.

The Non-Occupancy list was cleared. With a link established on channel, the EUT was rebooted. A radar signal was triggered within 54 to 60 seconds after the initial power-up period, and transmissions on the channel were monitored on the spectrum analyzer.

5.3.3. Quantitative Results

No Radar Triggered						
Test Mode	Frequency (MHz)	Timing of Reboot (sec)	Delta (sec)	Timing of Start of Traffic (sec)	Total Power-up Cycle Time (sec)	Initial Power-up Cycle Time (sec)
Mode 1	5300	2.490	114.200	116.690	114.200	54.200
	5560	4.417	116.300	120.717	116.300	56.300

Radar Near Beginning of CAC					
Test Mode	Frequency (MHz)	Timing of Reboot (sec)	Timing of Radar Burst (sec)	Radar Relative to Reboot (sec)	Radar Relative to Start of CAC (sec)
Mode 1	5300	2.490	59.120	56.630	2.430
	5560	4.417	62.770	58.353	2.053

Radar Near End of CAC					
Test Mode	Frequency (MHz)	Timing of Radar Burst (sec)	Radar Relative to Reboot (sec)	Radar Relative to Start of CAC (sec)	Radar Relative to Start of CAC (sec)
Mode 1	5300	2.490	113.100	110.610	56.410
	5560	4.417	116.800	112.383	56.083

5.3.4. Qualitative Results

Timing of Radar Burst	Display on Control Computer	Spectrum Analyzer Display
No Radar Triggered	EUT marks Channel as active	Transmissions begin on channel after completion of the initial power-up cycle and the CAC
Within 0 to 6 second window	EUT indicates radar detected	No transmissions on channel
Within 54 to 60 second window	EUT indicates radar detected	No transmissions on channel

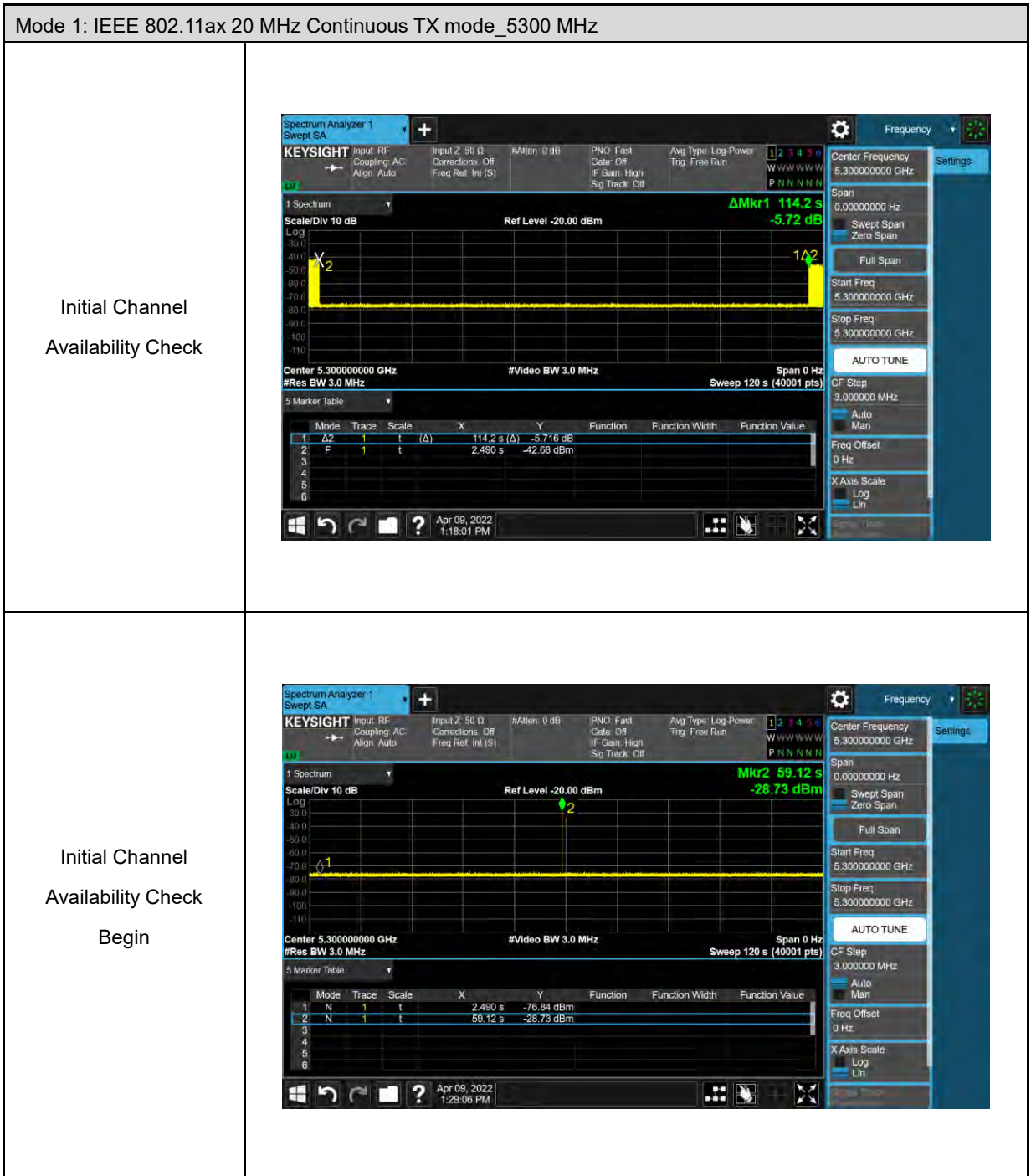

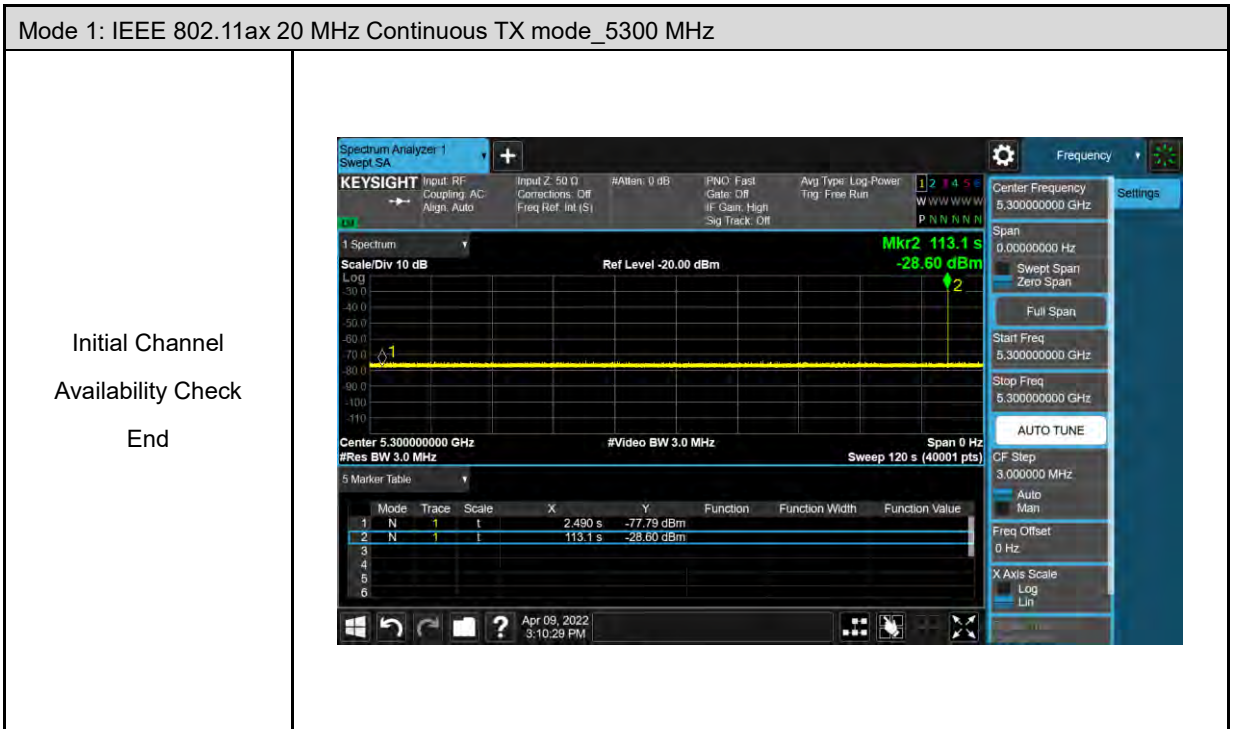

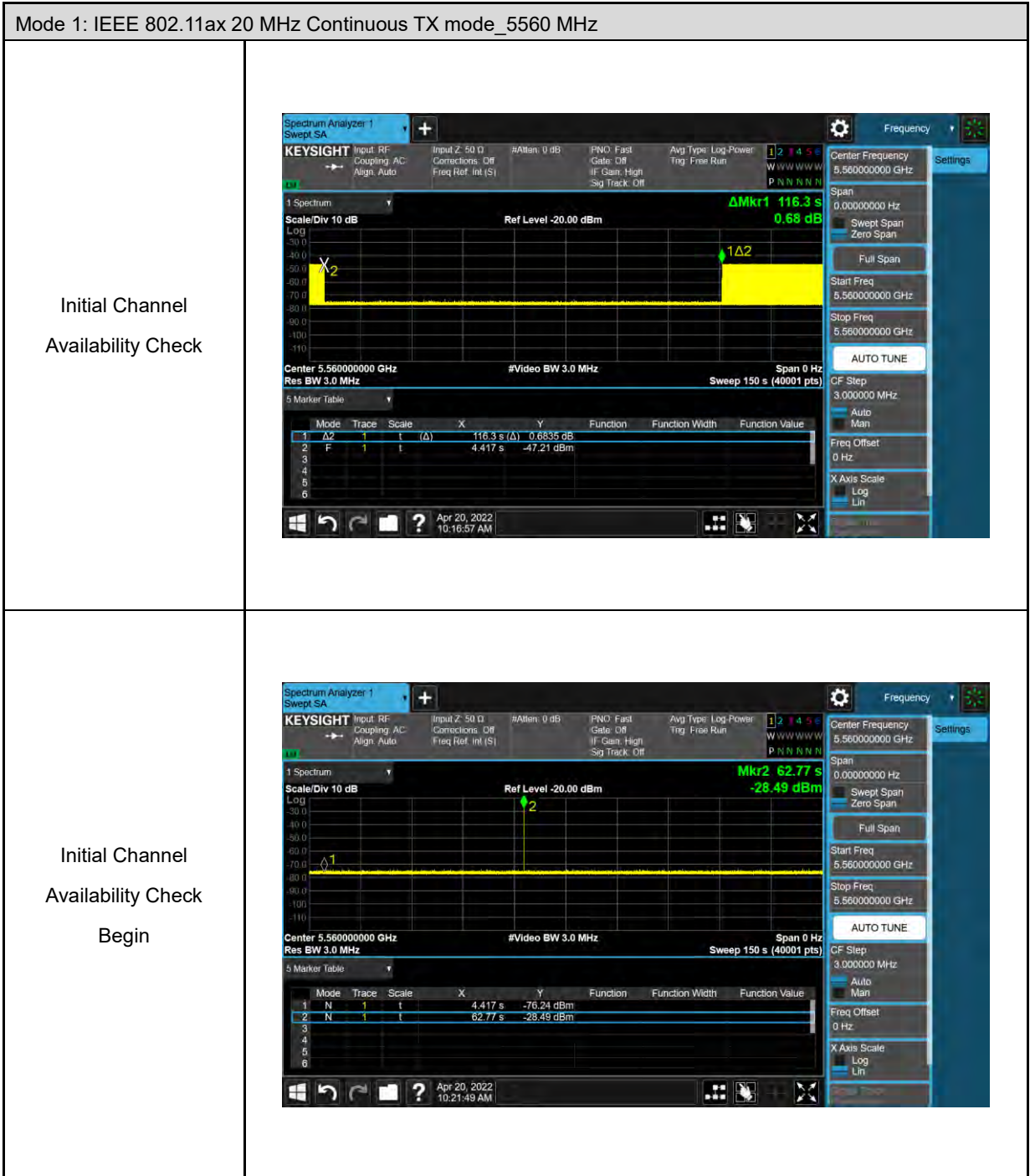

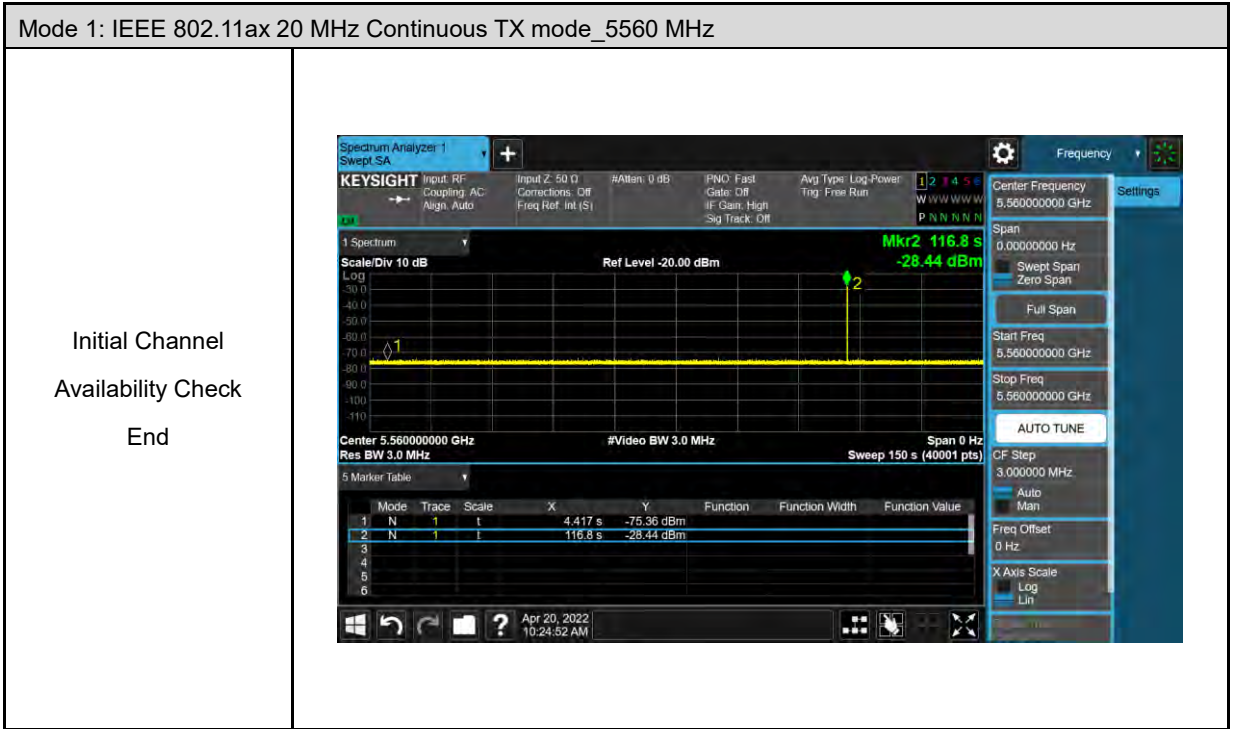

5.4. Channel Move Time and Channel Closing Transmission Time

5.4.1. Reporting Notes

The reference marker is set at the end of last radar pulse.

The delta marker is set at the end of the last WLAN transmission following the radar pulse.

This delta is the channel move time.

The aggregate channel closing transmission time is calculated as follows:

Aggregate Transmission Time = (Number of analyzer bins showing transmission) * (dwell time per bin)

The Channel Closing Transmission Time is comprised of 200 milliseconds starting at the beginning of the Channel Move Time plus any additional intermittent control signals required to facilitate a Channel move (an aggregate of 60 milliseconds) during the remainder of the 10 second period. The aggregate duration of control signals will not count quiet periods in between transmissions.

Results

Test Mode	Frequency (MHz)	Radar Type	Channel Move Time (msec)	Limit (sec)
			Master	
Mode 3	5530	Type 0	0.8520	10
Mode 4	5250	Type 0	0	10

Frequency (MHz)	Frequency (MHz)	Radar Type	Aggregate Channel Closing Transmission Time (msec)	Limit (msec)
			Master	
Mode 3	5530	Type 0	5.9999	60
Mode 4	5250	Type 0	0	60

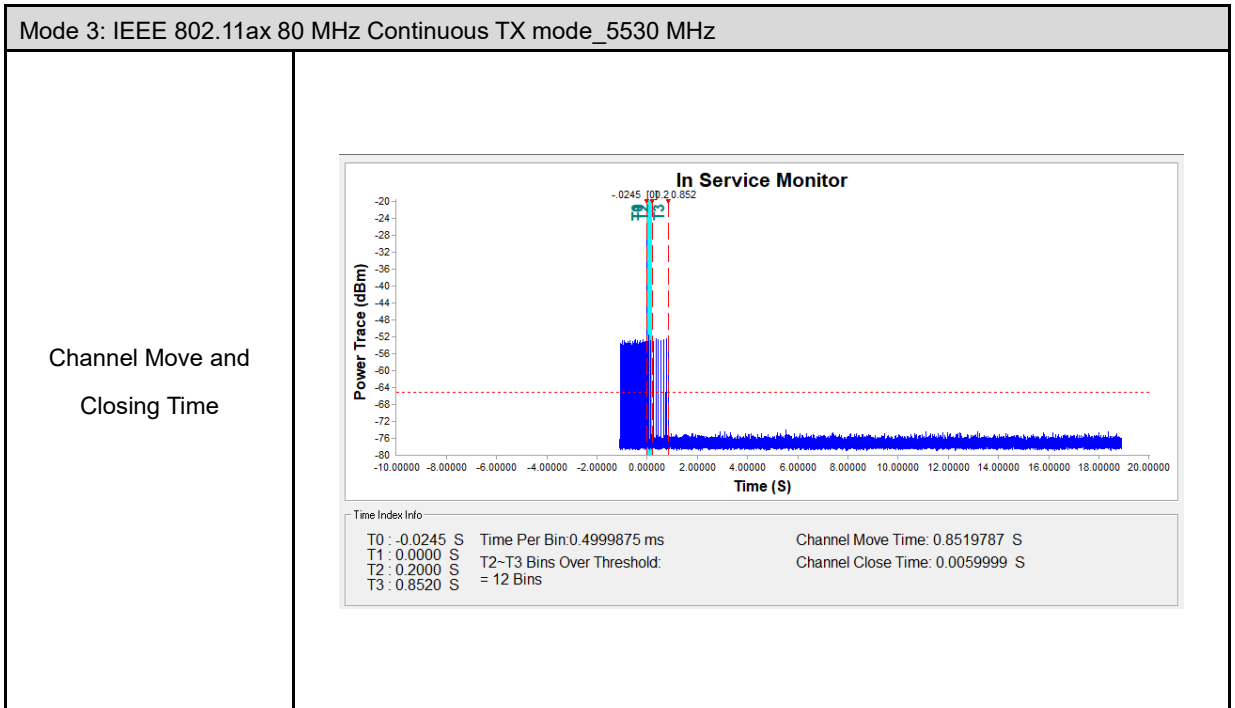

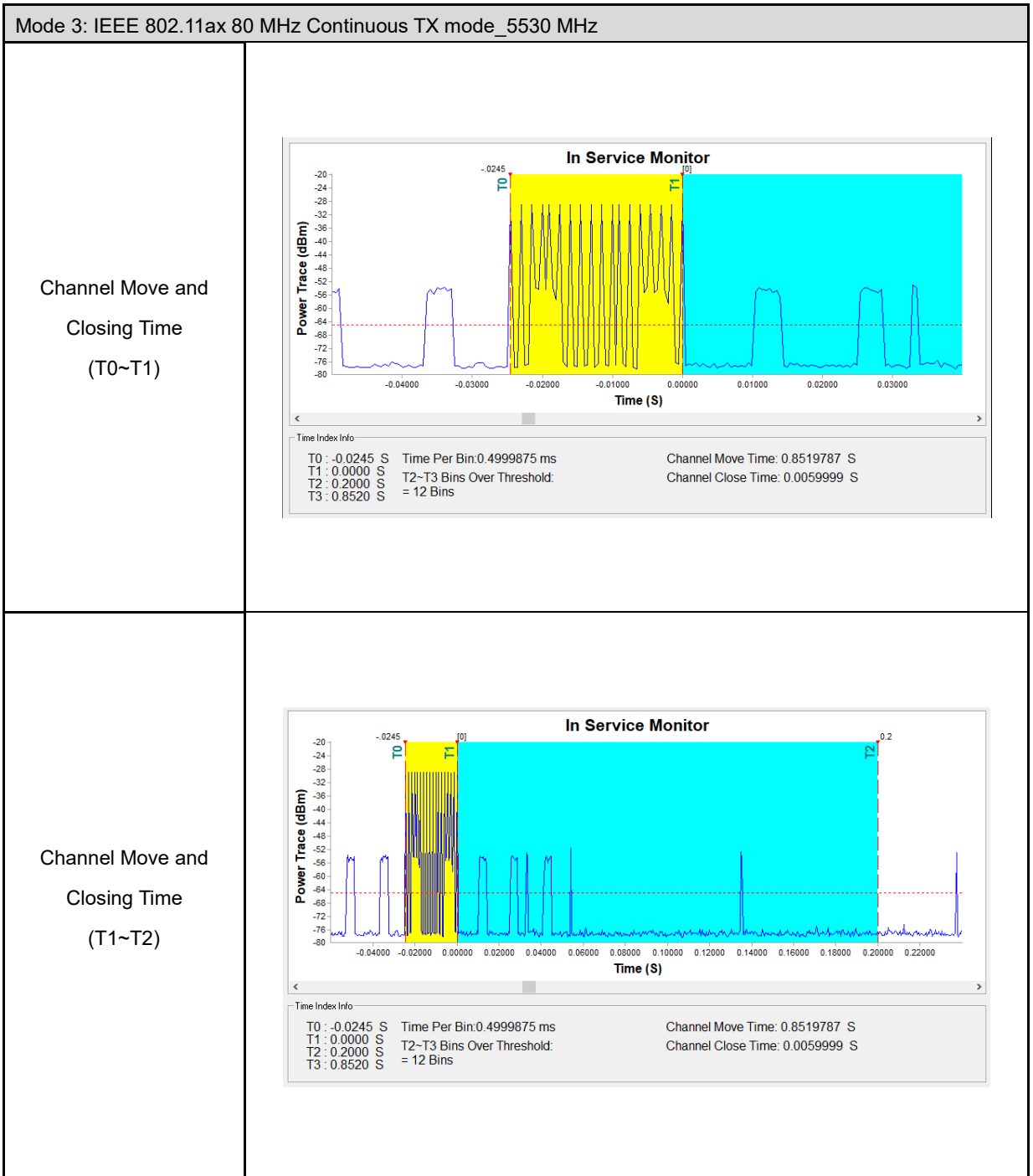

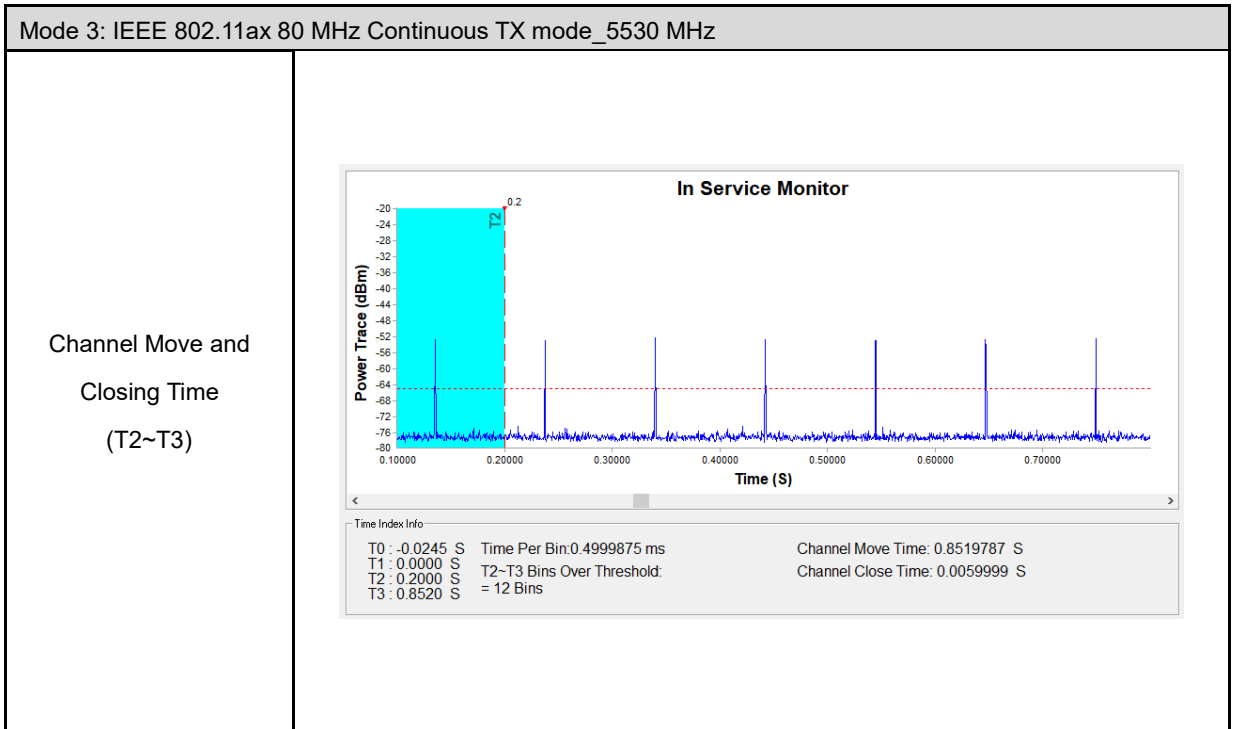

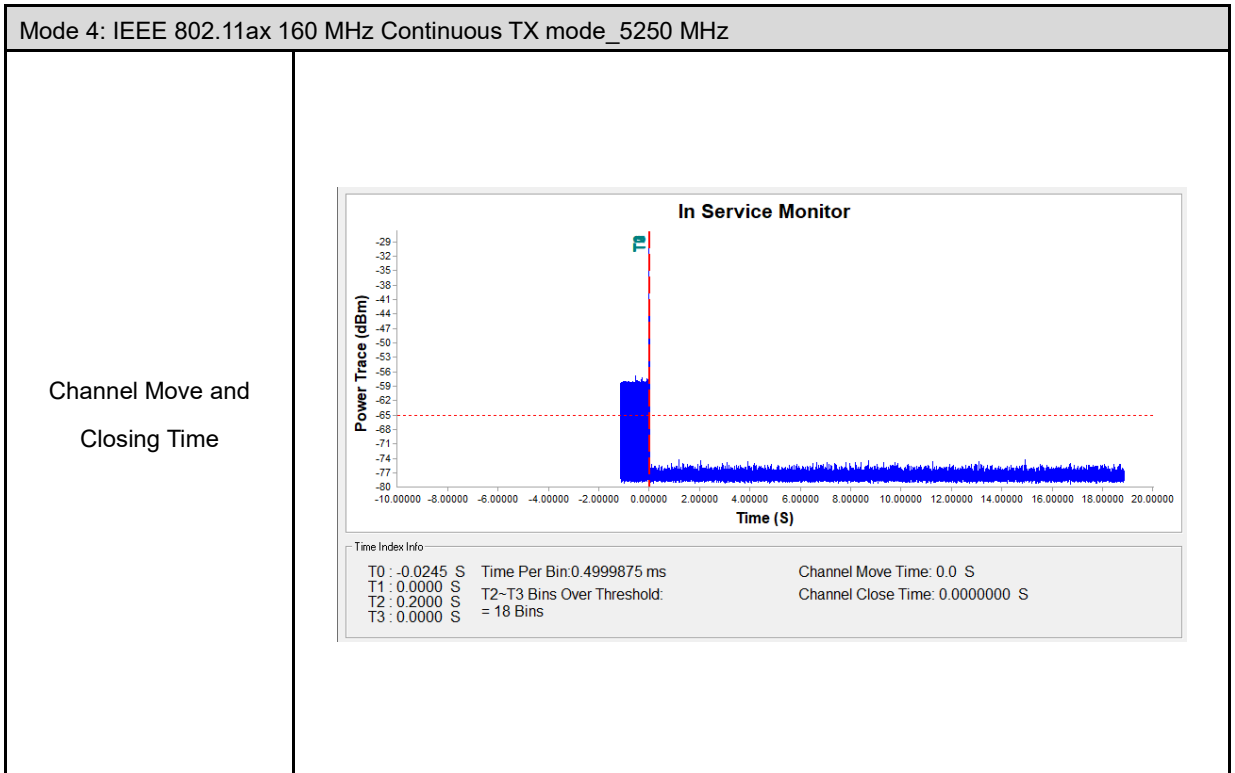

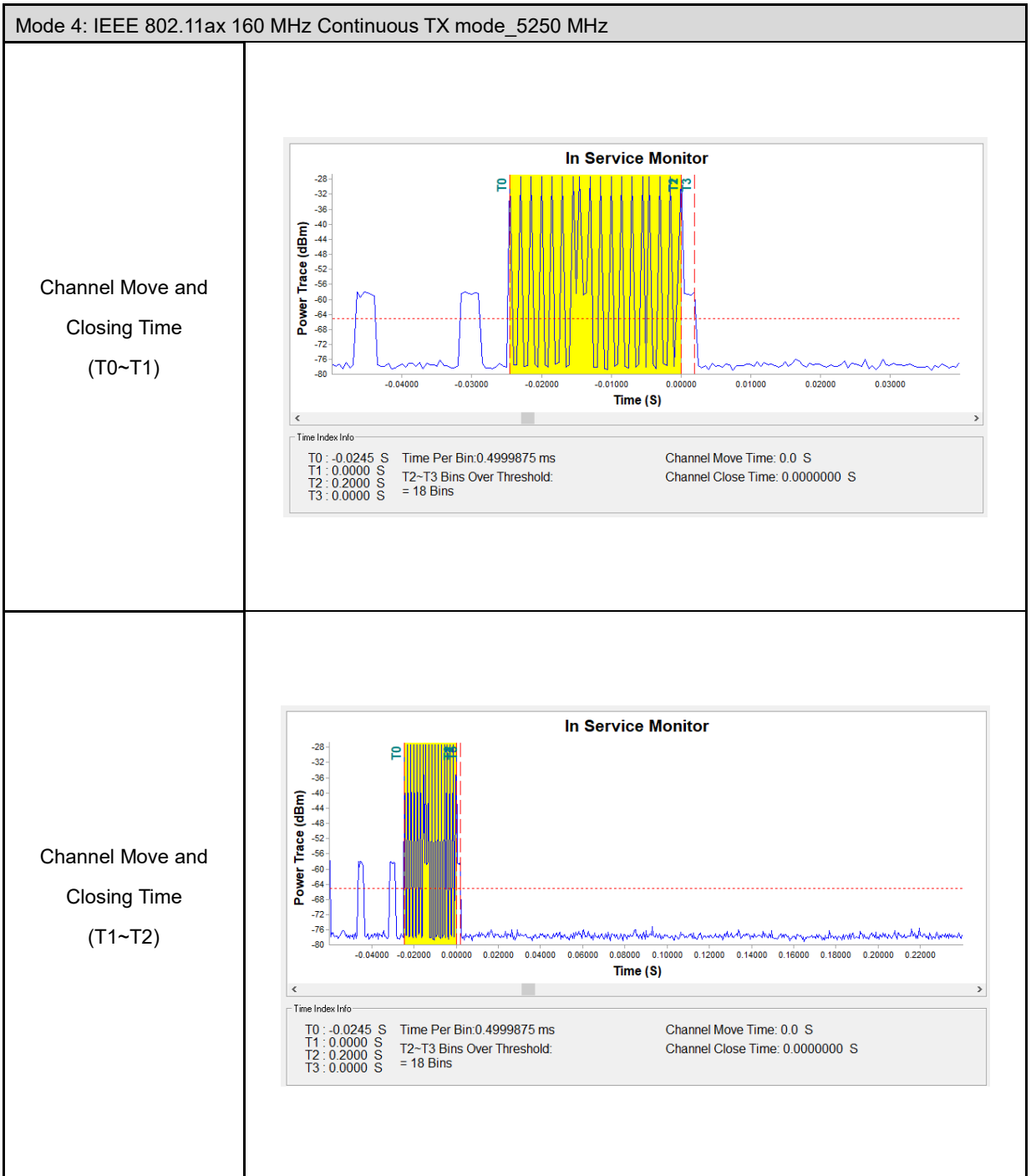

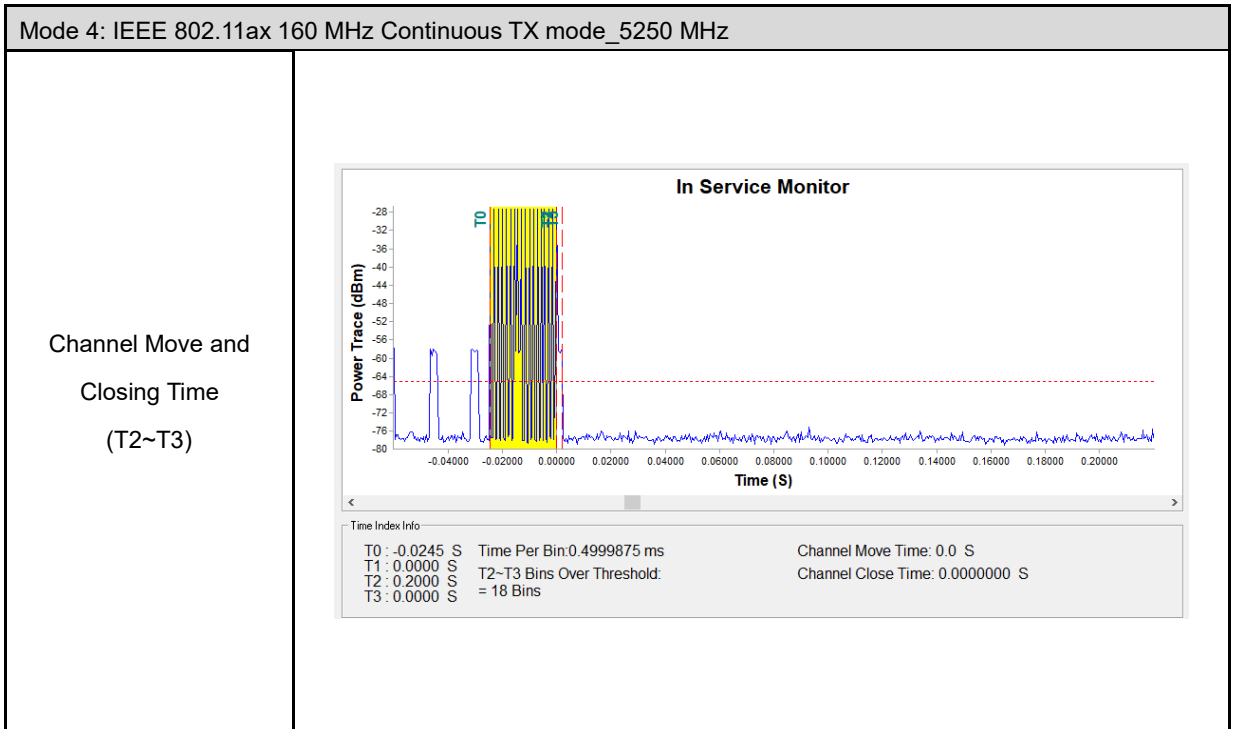

5.5. Non-Occupancy Period

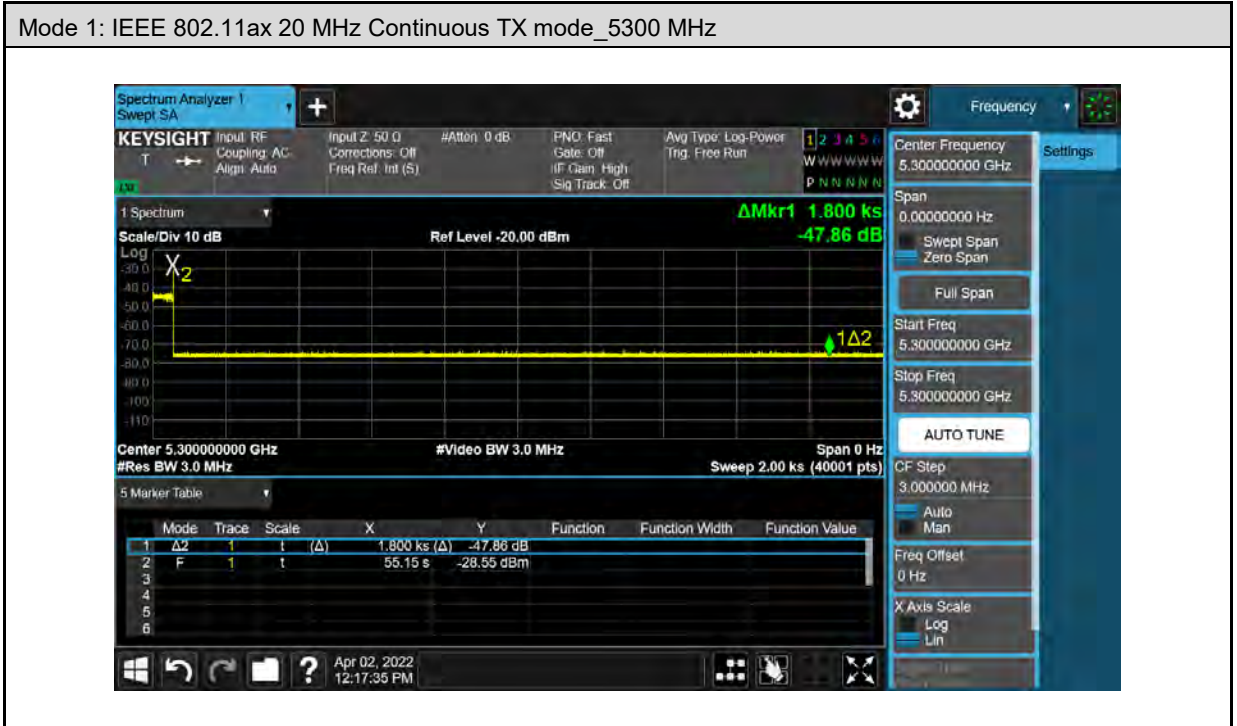

Note: Non-Occupancy Period time is 30 minute during which a Channel will not be utilized after a Radar Waveform is detected on that Channel.

5.6. U-NII Detection Bandwidth

■ Test Results

Test Mode	Mode 1: IEEE 802.11ax 20 MHz Continuous TX mode					
Frequency (MHz)	FL (MHz)	FH (MHz)	Detection Bandwidth (MHz)	99 % Power Bandwidth (MHz)	Ratio of Detection BW to 99 % Power BW (%)	Minimum Limit (%)
5300	5290	5310	20	19.077	104.84	≥ 100
5560	5550	5570	20	19.123	104.59	≥ 100

Test Mode	Mode 2: IEEE 802.11ax 40 MHz Continuous TX mode					
Frequency (MHz)	FL (MHz)	FH (MHz)	Detection Bandwidth (MHz)	99 % Power Bandwidth (MHz)	Ratio of Detection BW to 99 % Power BW (%)	Minimum Limit (%)
5310	5290	5330	40	37.768	105.91	≥ 100
5550	5532	5569	37	36.179	102.27	≥ 100

Test Mode	Mode 3: IEEE 802.11ax 80 MHz Continuous TX mode					
Frequency (MHz)	FL (MHz)	FH (MHz)	Detection Bandwidth (MHz)	99 % Power Bandwidth (MHz)	Ratio of Detection BW to 99 % Power BW (%)	Minimum Limit (%)
5290	5252	5330	78	76.799	101.56	≥ 100
5530	5493	5569	76	75.619	100.50	≥ 100

Test Mode	Mode 4: IEEE 802.11ax 160 MHz Continuous TX mode					
Frequency (MHz)	FL (MHz)	FH (MHz)	Detection Bandwidth (MHz)	99 % Power Bandwidth (MHz)	Ratio of Detection BW to 99 % Power BW (%)	Minimum Limit (%)
5250	5250	5329	79	78.08	101.18	≥ 100

■ Test Graphs

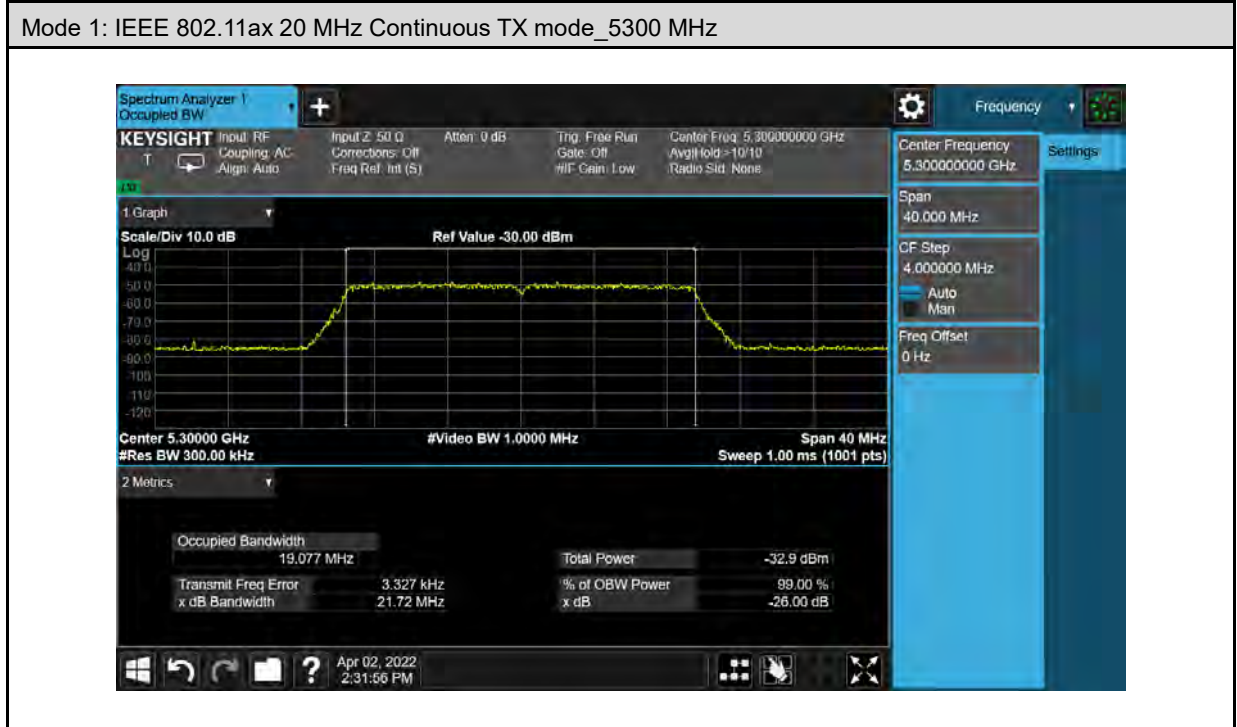

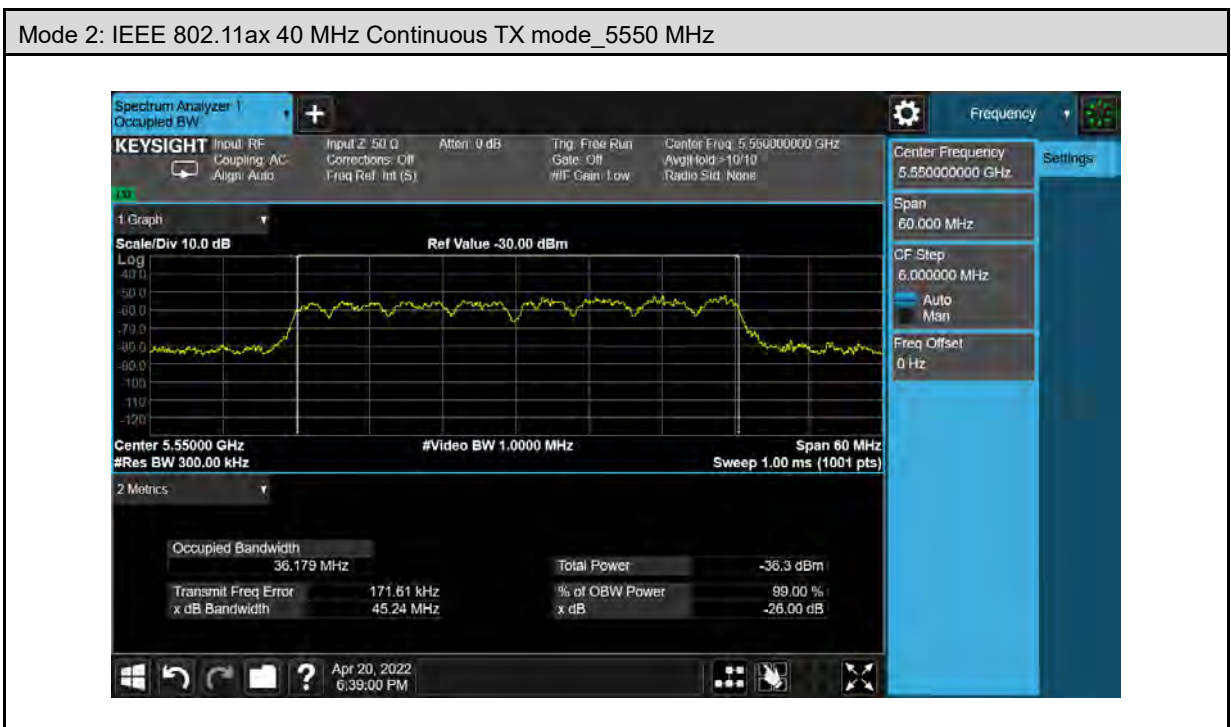

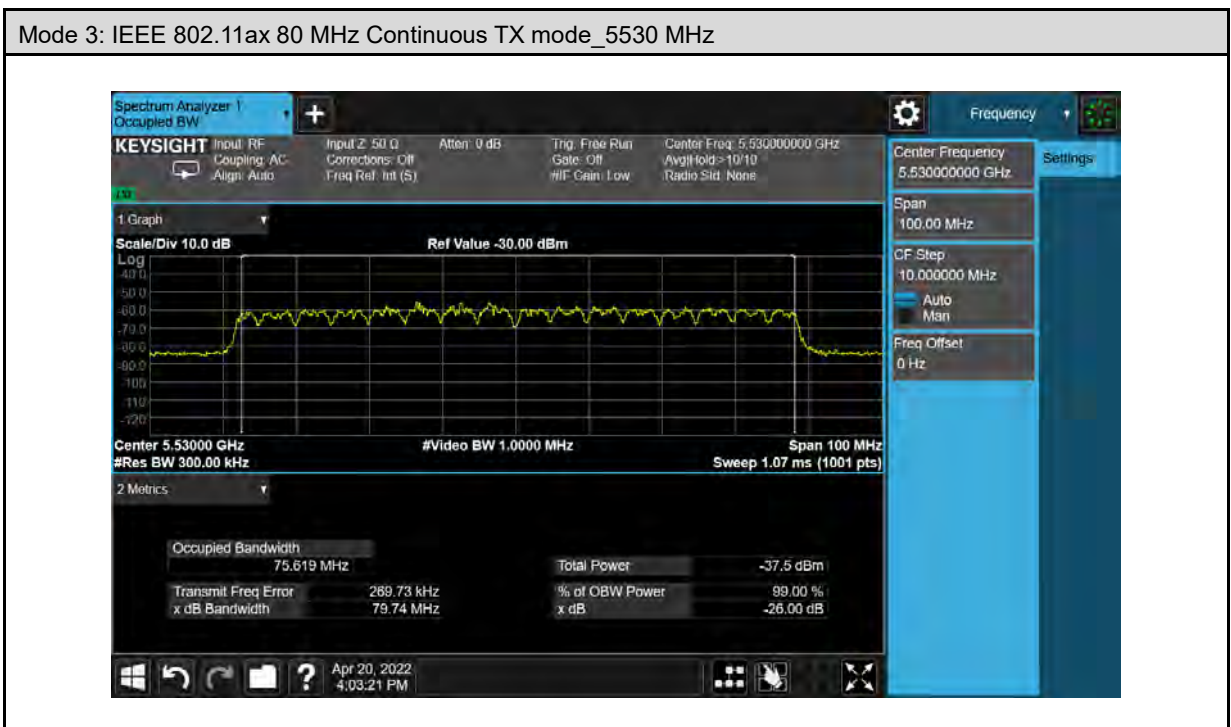
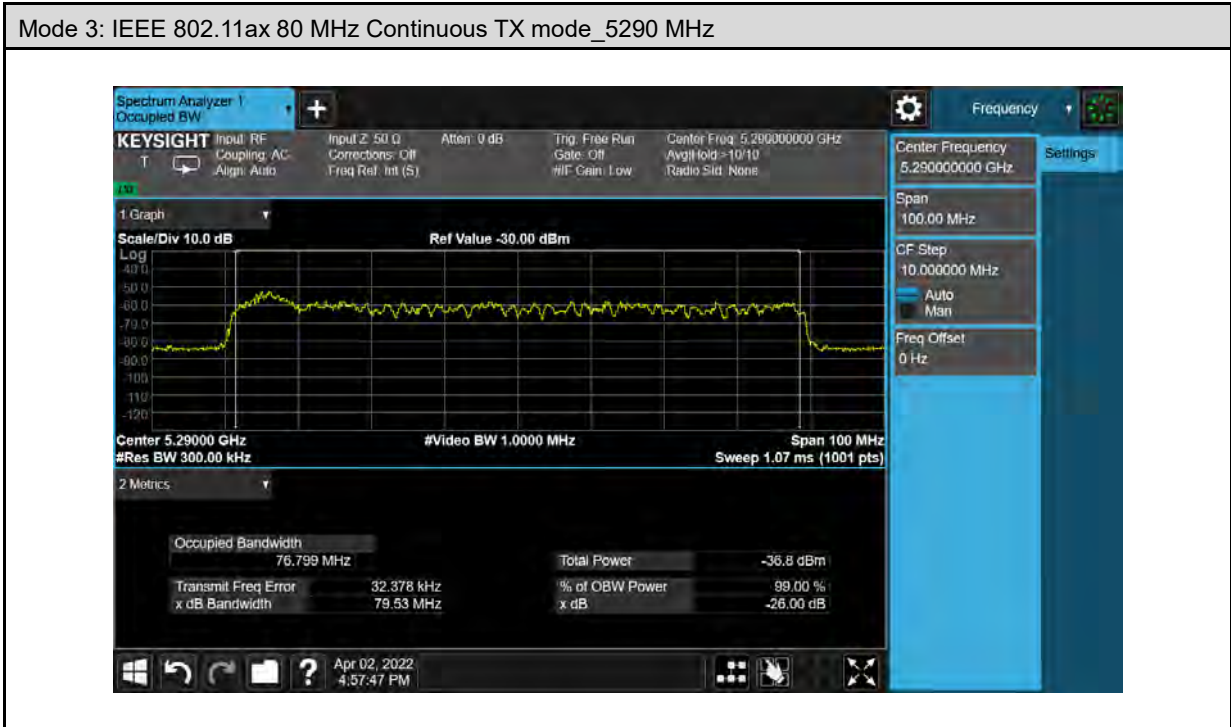

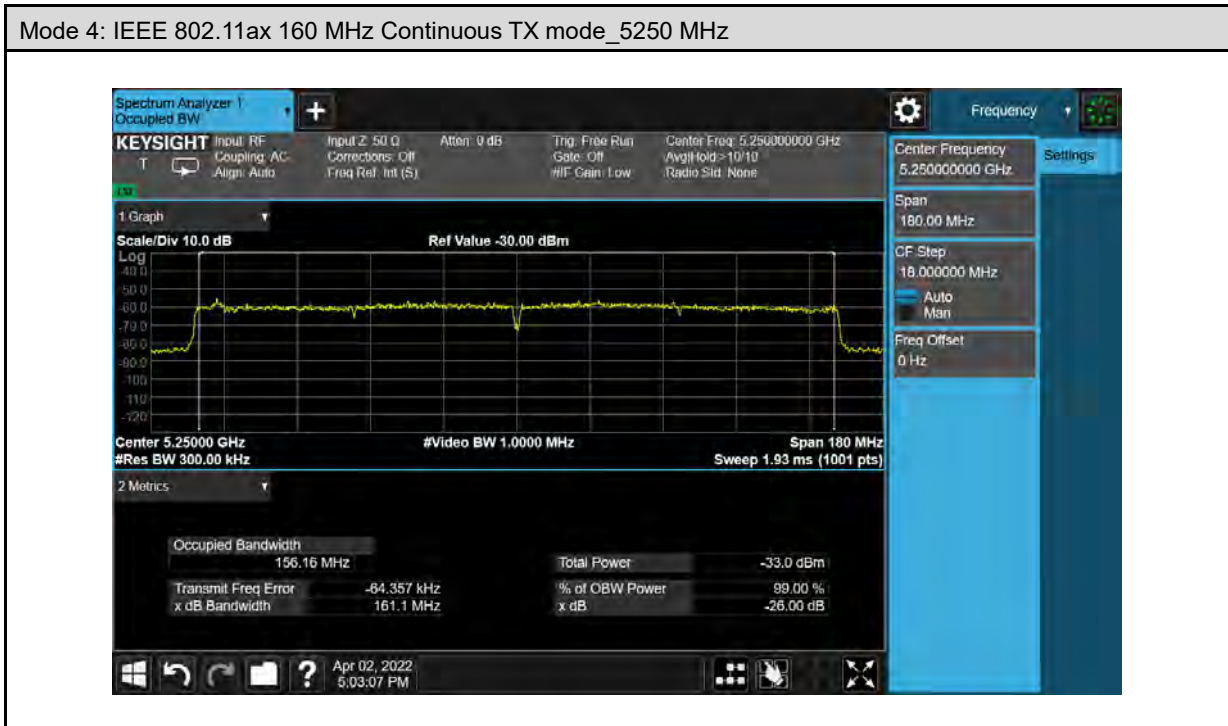

5.7. Statistical Performance check

■ Test Results

Master Mode

Test Mode		Mode 1: IEEE 802.11ax 20 MHz Continuous TX mode					
Frequency (MHz)	Radar Signal	PRI (Msec)	Pulse width W (μs)	Pass Times	Fail Times	Probability	Limit
5300	Type1	Table 5a	1	26	4	86.67%	≥ 60 %
	Type2	Random	Random	24	6	80.00%	≥ 60 %
	Type3	Random	Random	23	7	76.67%	≥ 60 %
	Type4	Random	Random	23	7	76.67%	≥ 60 %
	Type1~4					80.00%	≥ 80 %
	Type5	Random	Random	25	5	83.33%	≥ 80 %
	Type6	Hopping	1	24	6	80.00%	≥ 70 %
5560	Type1	Table 5a	1	28	2	93.33%	≥ 60 %
	Type2	Random	Random	27	3	90.00%	≥ 60 %
	Type3	Random	Random	23	7	76.67%	≥ 60 %
	Type4	Random	Random	23	7	76.67%	≥ 60 %
	Type1~4					84.17%	≥ 80 %
	Type5	Random	Random	25	5	83.33%	≥ 80 %
	Type6	Hopping	1	24	6	80.00%	≥ 70 %

Test Mode		Mode 2: IEEE 802.11ax 40 MHz Continuous TX mode					
Frequency (MHz)	Radar Signal	PRI (Msec)	Pulse width W (μs)	Pass Times	Fail Times	Probability	Limit
5310	Type1	Table 5a	1	28	2	93.33%	≥ 60 %
	Type2	Random	Random	28	2	93.33%	≥ 60 %
	Type3	Random	Random	26	4	86.67%	≥ 60 %
	Type4	Random	Random	26	4	86.67%	≥ 60 %
	Type1~4					90.00%	≥ 80 %
	Type5	Random	Random	25	5	83.33%	≥ 80 %
	Type6	Hopping	1	25	5	83.33%	≥ 70 %
5550	Type1	Table 5a	1	26	4	86.67%	≥ 60 %
	Type2	Random	Random	26	4	86.67%	≥ 60 %
	Type3	Random	Random	25	5	83.33%	≥ 60 %
	Type4	Random	Random	24	6	80.00%	≥ 60 %
	Type1~4					84.17%	≥ 80 %

	Type5	Random	Random	25	5	83.33%	$\geq 80\%$
	Type6	Hopping	1	25	5	83.33%	$\geq 70\%$

Test Mode		Mode 3: IEEE 802.11ax 80 MHz Continuous TX mode					
Frequency (MHz)	Radar Signal	PRI (Msec)	Pulse width W (μ s)	Pass Times	Fail Times	Probability	Limit
5290	Type1	Table 5a	1	26	4	86.67%	$\geq 60\%$
	Type2	Random	Random	26	4	86.67%	$\geq 60\%$
	Type3	Random	Random	22	8	73.33%	$\geq 60\%$
	Type4	Random	Random	22	8	73.33%	$\geq 60\%$
	Type1~4					80.00%	$\geq 80\%$
	Type5	Random	Random	24	6	80.00%	$\geq 80\%$
	Type6	Hopping	1	24	6	80.00%	$\geq 70\%$
5530	Type1	Table 5a	1	26	4	86.67%	$\geq 60\%$
	Type2	Random	Random	25	5	83.33%	$\geq 60\%$
	Type3	Random	Random	25	5	83.33%	$\geq 60\%$
	Type4	Random	Random	24	6	80.00%	$\geq 60\%$
	Type1~4					83.33%	$\geq 80\%$
	Type5	Random	Random	25	5	83.33%	$\geq 80\%$
	Type6	Hopping	1	26	4	86.67%	$\geq 70\%$

Test Mode		Mode 4: IEEE 802.11ax 160 MHz Continuous TX mode					
Frequency (MHz)	Radar Signal	PRI (Msec)	Pulse width W (μ s)	Pass Times	Fail Times	Probability	Limit
5250	Type1	Table 5a	1	25	5	83.33%	$\geq 60\%$
	Type2	Random	Random	23	7	76.67%	$\geq 60\%$
	Type3	Random	Random	24	6	80.00%	$\geq 60\%$
	Type4	Random	Random	24	6	80.00%	$\geq 60\%$
	Type1~4					80.00%	$\geq 80\%$
	Type5	Random	Random	25	5	83.33%	$\geq 80\%$
	Type6	Hopping	1	22	8	73.33%	$\geq 70\%$

Test Mode		Mode 1				
Frequency		5300 MHz				
Radar Signal		Type 1				
Trial #	Test Frequency (MHz)	Pulse Width (us)	PRI (us)	Number of Pluse	PRF (Hz)	1=Detection ; 0=No Detection
1	5300	1	918	58	1089	1
2	5300	1	698	76	1433	1
3	5300	1	938	57	1066	1
4	5300	1	718	74	1393	1
5	5300	1	778	68	1285	1
6	5300	1	578	92	1730	0
7	5300	1	918	58	1089	1
8	5300	1	738	72	1355	1
9	5300	1	778	68	1285	1
10	5300	1	898	59	1114	1
11	5300	1	678	78	1475	1
12	5300	1	698	76	1433	0
13	5300	1	938	57	1066	1
14	5300	1	518	102	1931	1
15	5300	1	738	72	1355	1
16	5300	1	3025	18	331	1
17	5300	1	3055	18	327	1
18	5300	1	1417	38	706	1
19	5300	1	1708	31	585	0
20	5300	1	2119	25	472	1
21	5300	1	1328	40	753	1
22	5300	1	589	90	1698	1
23	5300	1	2186	25	457	1
24	5300	1	1465	37	683	1
25	5300	1	1548	35	646	0
26	5300	1	2508	22	399	1
27	5300	1	880	60	1136	1
28	5300	1	3047	18	328	1
29	5300	1	2377	23	421	1
30	5300	1	1789	30	559	1
Detection Percentage (%)						86.67

Test Mode		Mode 1				
Frequency		5300 MHz				
Radar Signal		Type 2				
Trial #	Test Frequency (MHz)	Pulse Width (us)	PRI (us)	Number of Pluse	PRF (Hz)	1=Detection ; 0=No Detection
1	5300	2.40	213.80	26	4677	1
2	5300	2.10	204.10	28	4900	0
3	5300	3.50	153.80	24	6502	1
4	5300	3.00	202.80	23	4931	1
5	5300	3.40	218.90	25	4568	1
6	5300	1.20	222.10	24	4502	1
7	5300	5.00	167.50	24	5970	0
8	5300	3.80	203.50	23	4914	1
9	5300	3.50	196.20	28	5097	1
10	5300	4.80	223.20	24	4480	0
11	5300	4.80	155.80	27	6418	1
12	5300	4.20	186.80	26	5353	1
13	5300	2.50	165.30	23	6050	1
14	5300	4.40	170.40	29	5869	1
15	5300	3.10	204.60	25	4888	1
16	5300	4.80	190.60	24	5247	0
17	5300	2.50	213.30	25	4688	1
18	5300	1.00	201.90	26	4953	1
19	5300	1.10	177.60	23	5631	1
20	5300	5.00	223.70	24	4470	0
21	5300	4.60	217.30	29	4602	0
22	5300	2.90	181.80	23	5501	1
23	5300	2.30	219.80	28	4550	1
24	5300	3.50	161.10	24	6207	1
25	5300	2.80	156.30	28	6398	1
26	5300	3.30	227.20	29	4401	1
27	5300	2.90	174.70	29	5724	1
28	5300	3.60	190.60	24	5247	1
29	5300	1.70	190.00	24	5263	1
30	5300	2.20	210.40	24	4753	1
Detection Percentage (%)						80.00

Test Mode		Mode 1				
Frequency		5300 MHz				
Radar Signal		Type 3				
Trial #	Test Frequency (MHz)	Pulse Width (us)	PRI (us)	Number of Pluse	PRF (Hz)	1=Detection ; 0=No Detection
1	5300	8.20	243.70	16	4103.41	0
2	5300	9.00	348.90	17	2866.15	1
3	5300	9.60	499.60	17	2001.60	1
4	5300	7.90	474.80	18	2106.15	1
5	5300	7.80	257.50	17	3883.50	1
6	5300	7.10	251.30	17	3979.31	1
7	5300	6.80	308.20	18	3244.65	1
8	5300	8.80	250.40	16	3993.61	0
9	5300	9.70	204.30	17	4894.76	1
10	5300	6.40	249.60	17	4006.41	1
11	5300	6.20	341.50	16	2928.26	1
12	5300	8.40	450.60	18	2219.26	0
13	5300	8.70	412.70	16	2423.07	1
14	5300	9.30	336.60	17	2970.89	0
15	5300	6.90	469.40	16	2130.38	1
16	5300	8.60	344.80	18	2900.23	1
17	5300	6.10	476.50	18	2098.64	1
18	5300	8.70	464.90	18	2151.00	1
19	5300	7.20	237.20	18	4215.85	1
20	5300	6.90	497.90	17	2008.44	1
21	5300	6.60	423.30	18	2362.39	1
22	5300	7.00	270.90	17	3691.40	1
23	5300	7.40	286.60	18	3489.18	1
24	5300	6.50	373.80	18	2675.23	0
25	5300	8.50	479.30	17	2086.38	0
26	5300	7.50	236.70	16	4224.76	1
27	5300	9.50	469.40	18	2130.38	1
28	5300	7.80	228.20	16	4382.12	0
29	5300	6.60	357.40	18	2797.99	1
30	5300	8.20	243.70	16	4103.41	1
Detection Percentage (%)						76.67

Test Mode		Mode 1				
Frequency		5300 MHz				
Radar Signal		Type 4				
Trial #	Test Frequency (MHz)	Pulse Width (us)	PRI (us)	Number of Pluse	PRF (Hz)	1=Detection ; 0=No Detection
1	5300	14.30	361.00	12	2770	1
2	5300	14.40	216.60	14	4617	1
3	5300	17.90	299.70	16	3337	1
4	5300	14.90	295.30	12	3386	0
5	5300	19.80	409.30	15	2443	1
6	5300	12.70	261.30	15	3827	1
7	5300	12.20	466.70	12	2143	1
8	5300	16.20	415.50	12	2407	1
9	5300	15.20	333.80	16	2996	1
10	5300	18.30	202.30	15	4943	0
11	5300	16.60	303.70	14	3293	1
12	5300	15.40	324.30	13	3084	1
13	5300	19.70	485.80	12	2058	1
14	5300	17.50	395.30	13	2530	0
15	5300	13.40	273.50	15	3656	1
16	5300	12.20	461.90	15	2165	0
17	5300	16.20	375.20	16	2665	1
18	5300	16.70	450.80	15	2218	1
19	5300	12.50	281.90	15	3547	1
20	5300	11.90	322.60	15	3100	1
21	5300	12.10	239.20	12	4181	0
22	5300	12.40	335.40	14	2982	1
23	5300	12.10	289.40	13	3455	0
24	5300	16.70	319.80	14	3127	1
25	5300	17.30	306.60	13	3262	1
26	5300	15.80	366.60	12	2728	1
27	5300	11.40	450.90	13	2218	1
28	5300	18.50	224.80	14	4448	0
29	5300	19.10	444.10	16	2252	1
30	5300	12.80	270.70	16	3694	1
Detection Percentage (%)						76.67

Test Mode		Mode 1					
Frequency		5300 MHz					
Radar Signal		Type 5					
Trial #	Test Frequency (MHz)	Burst#	Pulse Width (us)	Chirp Width (MHz)	PRI (us)	Number of Pulses / Burst	1=Detection ; 0=No Detection
1	5293	1	92.2	7	1042.0	3	1
	5292	2	64.4	6	1384.3	1	
	5294	3	51.3	11	1037.3	2	
	5295	4	67.2	12	1554.1	3	
	5293	5	89.4	7	1813.5	3	
	5292	6	70.1	6	1311.3	1	
	5297	7	87.8	18	1855.6	3	
	5298	8	66.3	20	1210.4	1	
	5296	9	90.8	15	1817.3	2	
	5296	10	99.5	15	1479.4	1	
	5297	11	88.5	18	1760.9	1	
2	5294	1	61.1	11	1947.3	2	1
	5294	2	65.9	11	1837.1	1	
	5296	3	75.3	15	1741.2	3	
	5294	4	54.1	10	1889.7	1	
	5296	5	98.9	16	1063.6	2	
	5294	6	55.2	9	1979.5	2	
	5295	7	73.8	12	1441.3	3	
	5296	8	64.6	16	1084.7	3	
	5296	9	75.6	16	1281.5	3	
	5297	10	54.2	18	1565.0	3	
	5296	11	77.8	16	1497.0	1	
	5294	12	82.9	10	1699.8	1	
3	5293	1	58.4	7	1770.5	2	1
	5298	2	98.5	20	1278.9	1	
	5296	3	56.1	15	1499.4	1	
	5298	4	57.6	19	1699.2	2	
	5296	5	69.2	14	1503.0	1	
	5297	6	61.8	17	1339.6	3	
	5295	7	98.4	13	1207.2	1	
	5294	8	81.5	11	1816.6	3	
	5294	9	75.8	10	1544.6	1	
	5296	10	97.0	16	1006.6	3	
	5297	11	89.0	18	1580.1	1	
	5295	12	61.2	13	1920.9	3	
	5296	13	72.8	16	1452.5	1	

Test Mode		Mode 1					
Frequency		5300 MHz					
Radar Signal		Type 5					
Trial #	Test Frequency (MHz)	Burst#	Pulse Width (us)	Chirp Width (MHz)	PRI (us)	Number of Pulses / Burst	1=Detection ; 0=No Detection
4	5295	1	67.1	12	1199.4	1	1
	5298	2	95.1	19	1629.5	3	
	5292	3	52.0	6	1648.7	1	
	5293	4	77.7	7	1840.6	3	
	5298	5	99.8	19	1218.6	2	
	5298	6	97.3	19	1663.4	1	
	5297	7	56.9	17	1510.0	2	
	5297	8	67.7	18	1304.1	2	
	5294	9	99.4	11	1636.5	3	
5	5296	1	64.5	16	1330.9	1	1
	5293	2	80.2	8	1589.7	3	
	5294	3	93.9	11	1354.6	2	
	5294	4	99.0	9	1958.3	3	
	5297	5	58.2	18	1847.4	2	
	5296	6	63.6	15	1753.8	2	
	5293	7	74.6	8	1695.2	1	
	5294	8	77.2	9	1914.2	1	
	5297	9	97.9	17	1147.1	3	
	5292	10	77.1	6	1208.8	1	
	5294	11	63.9	9	1289.6	3	
	5294	12	64.4	9	1211.3	1	
	5298	13	50.2	20	1092.1	1	
	5293	14	50.7	7	1502.5	3	
	5298	15	81.5	19	1406.2	1	
6	5296	1	72.7	16	1467.7	3	1
	5295	2	87.3	13	1141.1	3	
	5296	3	99.4	15	1852.1	1	
	5298	4	91.7	19	1278.9	2	
	5292	5	66.1	6	1603.3	2	
	5296	6	81.6	14	1207.1	1	
	5294	7	61.9	10	1249.6	2	
	5293	8	71.5	8	1156.5	1	
	5294	9	86.6	9	1211.3	1	
	5293	10	69.5	7	1794.3	3	
	5293	11	66.7	7	1399.7	3	
	5295	12	73.9	12	1643.8	2	
	5296	13	82.6	16	1455.3	3	
	5294	14	86.5	10	1716.8	2	

Test Mode		Mode 1					
Frequency		5300 MHz					
Radar Signal		Type 5					
Trial #	Test Frequency (MHz)	Burst#	Pulse Width (us)	Chirp Width (MHz)	PRI (us)	Number of Pulses / Burst	1=Detection ; 0=No Detection
7	5294	1	70.8	11	1603.4	3	1
	5292	2	86.4	6	1489.9	3	
	5294	3	56.4	10	1358.2	1	
	5296	4	52.4	14	1446.2	1	
	5294	5	96.7	10	1848.9	2	
	5295	6	84.8	13	1330.4	2	
	5296	7	55.6	16	1307.2	3	
	5297	8	69.9	17	1989.3	1	
	5294	9	56.1	10	1520.0	1	
	5298	10	64.1	19	1165.5	2	
	5293	11	62.8	8	1826.0	3	
	5295	12	69.0	12	1933.4	3	
	5296	13	67.0	14	1142.4	3	
	5293	14	51.9	7	1579.8	1	
	5292	15	72.4	6	1635.4	3	
	5296	16	52.2	16	1654.7	3	
	5294	17	67.1	9	1021.6	1	
8	5292	1	69.3	5	1358.7	2	1
	5294	2	99.7	11	1215.7	2	
	5295	3	52.7	13	1915.6	2	
	5293	4	63.5	8	1724.3	3	
	5292	5	57.3	5	1624.9	1	
	5293	6	73.9	8	1997.9	2	
	5294	7	83.4	9	1892.7	2	
	5296	8	57.0	16	1668.5	2	
	5293	9	52.4	7	1487.3	1	
	5293	10	88.7	7	1056.7	3	
	5294	11	73.6	9	1214.4	2	
	5295	12	77.9	12	1012.4	1	
	5295	13	67.0	13	1231.7	1	
	5295	14	76.0	12	1481.4	3	
	5294	15	60.7	10	1220.7	3	
	5297	16	69.8	17	1447.0	1	
	5298	17	74.2	19	1576.1	1	
	5292	18	51.4	6	1250.6	3	