

DFS Test Report

Applicant : Plume Design, Inc.

Product Name : SuperPod with WiFi 6

Trade Name : Plume Design, Inc.

Model Number : F3A

Applicable Standard : FCC 47 CFR PART 15 SUBPART E
ANSI C63.10:2013

Received Date : Sep. 30, 2022

Test Period : Oct. 04 - Oct. 05, 2022

Issued Date : Oct. 31, 2022

Issued by

Eurofins E&E Wireless Taiwan Co., Ltd.
No. 140-1, Changan Street, Bade District,
Taoyuan City 334025, Taiwan (R.O.C.)
Tel : +886-3-2710188 / Fax : +886-3-2710190



Taiwan Accreditation Foundation accreditation number: 1330
Frequency Range : 9 kHz to 40 GHz
Test Firm MRA designation number: TW0010

Note:

1. The test results are valid only for samples provided by customers and under the test conditions described in this report.
2. This report shall not be reproduced except in full, without the written approval of Eurofins E&E Wireless Taiwan Co., Ltd.
3. The relevant information is provided by customers in this test report. According to the correctness, appropriateness or completeness of the information provided by the customer, if there is any doubt or error in the information which affects the validity of the test results, the laboratory does not take the responsibility.

Revision History

Version	Issued Date	Revisions	Revised By
00	Oct. 27, 2022	Initial Issue	Snow Wang
01	Oct. 31, 2022	Update chapter 5.3.3 (P.22)	Snow Wang

Verification of Compliance

Applicant : Plume Design, Inc.

Product Name : SuperPod with WiFi 6

Trade Name : Plume Design, Inc.

Model Number : F3A

FCC ID : 2AG7G-F3A

Applicable Standard : FCC 47 CFR PART 15 SUBPART E
ANSI C63.10:2013

Test Result : Complied

Performing Lab. : Eurofins E&E Wireless Taiwan Co., Ltd.
No. 140-1, Changan Street, Bade District,
Taoyuan City 334025, Taiwan (R.O.C.)
Tel : +886-3-2710188 / Fax : +886-3-2710190
Taiwan Accreditation Foundation accreditation number: 1330



Eurofins E&E Wireless Taiwan Co., Ltd. tested the above equipment in accordance with the requirements set forth in the above standards. All indications of Pass/Fail in this report are opinions expressed by Eurofins E&E Wireless Taiwan Co., Ltd. based on interpretations and/or observations of test results. The test results show that the equipment tested is capable of demonstrating compliance with the requirements as documented in this report.

Approved By : _____

TABLE OF CONTENTS

1	General Information	5
1.1.	EUT Description	5
1.2.	Testing Location	6
2	Test Methodology	7
3	Dynamic Frequency Selection	8
3.1.	Limits	8
3.2.	Test and Measurement System	12
3.3.	Test Instruments	14
4	Test Methodology	15
4.1.	Mode of Operation	15
4.2.	EUT Test Step	15
4.3.	Test Site Environment	15
5	Test Results	16
5.1.	Radar Waveforms and Traffic	16
5.2.	Channel Loading	21
5.3.	Channel Availability Check Time	22
5.4.	Channel Move Time and Channel Closing Transmission Time	26
5.5.	Non-Occupancy Period	30
5.6.	U-NII Detection Bandwidth	31
5.7.	Statistical Performance check	32

Appendix A. Test Setup Photographs

1 General Information

1.1. EUT Description

Applicant	Plume Design, Inc. 325 Lytton Ave., Palo Alto, CA 94301			
Product Name	SuperPod with WiFi 6			
Trade Name	Plume Design, Inc.			
Model Number	F3A			
FCC ID	2AG7G-F3A			
Operate Frequency	Frequency Band		Frequency Range (MHz)	Number of Channels
	802.11a / 802.11n HT20 / 802.11ac VHT20 / 802.11ax HE20	U-NII Band 2-A	5260 – 5320	4
		U-NII Band 2-C	5500 – 5700	11
		Straddle band	5720	1
	802.11n HT40 / 802.11ac VHT40 / 802.11ax HE40	U-NII Band 2-A	5270 – 5310	2
		U-NII Band 2-C	5510 – 5670	5
		Straddle band	5710	1
	802.11ac VHT80 / 802.11ax HE80	U-NII Band 2-A	5290	1
		U-NII Band 2-C	5530 – 5610	2
		Straddle band	5690	1
	802.11ac VHT160 / 802.11ax HE160	U-NII Band 2-A	5250	1
		U-NII Band 2-C	5570	1
Modulation Type	OFDM/OFDMA			
Antenna Delivery	5250~5350 MHz : 4TX 5470~5725 MHz : 2TX			
Operate Temp. Range	-30 ~ +50 °C			
EUT Power Rating	100-240 V, 50-60 Hz, 0.45 A			

Antenna information				
Type	Antenna		Frequency	Max. Gain (dBi)
PIFA Antenna	5G L1	ANT-0	U-NII Band 2-A	3.20
	5G L2	ANT-1	U-NII Band 2-A	2.10
	5G L3	ANT-2	U-NII Band 2-A	3.10
	5G L4	ANT-3	U-NII Band 2-A	3.70
	5G H1	ANT-0	U-NII Band 2-C	4.10
	5G H2	ANT-1	U-NII Band 2-C	2.30

EUT Modify Description :

Modify Description:

1. In order to improve the de-sense issue, added 3 gaskets on F3A.
2. To enable the bandwidth up to 160 MHz for U-NII-2c by software.

The difference will influence the test results. Therefore, all test items need to be re-evaluated.

Items	Description	
Communication Mode	<input checked="" type="checkbox"/> IP Based (Load Based)	<input type="checkbox"/> Frame Based
TPC Function	<input checked="" type="checkbox"/> With TPC	<input type="checkbox"/> Without TPC
Weather Band (5600 ~ 5650 MHz)	<input checked="" type="checkbox"/> With 5600 ~ 5650 MHz	<input type="checkbox"/> Without 5600 ~ 5650 MHz
Beamforming Function	<input checked="" type="checkbox"/> With Beamforming	<input type="checkbox"/> Without Beamforming
Equipment Type	<input type="checkbox"/> Outdoor access point	
	<input checked="" type="checkbox"/> Indoor access point	
	<input type="checkbox"/> Fixed point-to-point access points	
	<input type="checkbox"/> Client devices	
Operating mode	<input checked="" type="checkbox"/> Master	
	<input type="checkbox"/> Client with radar detection	
	<input type="checkbox"/> Client without radar detection	
	<input type="checkbox"/> Ad-Hoc	
	<input checked="" type="checkbox"/> Bridge	
	<input type="checkbox"/> MESH	

Note : DFS controls (hardware or software) related to radar detection are NOT accessible to the user.
 Manufacturer statement confirming that information regarding the parameters of the detected Radar Waveforms is not available to the end user.

1.2. Testing Location

Site Name: Eurofins E&E Wireless Taiwan Co., Ltd.

Site Address: No. 140-1, Changan Street, Bade District, Taoyuan City 334025, Taiwan (R.O.C.)

Site Address: No. 2, Wuquan 5th Rd. Wugu Dist., New Taipei City, Taiwan (R.O.C.)

2 Test Methodology

The tests documented in this report were performed in accordance with ANSI C63.10-2013, FCC CFR 47 Part 2, FCC CFR 47 Part 15.

The tests documented in this report were performed in accordance with FCC KDB request:

- FCC KDB 905462 D02 UNII DFS Compliance Procedures New Rules v02
- FCC KDB 905462 D03 UNII Clients Without Radar Detection New Rules v01r02

3 Dynamic Frequency Selection

3.1. Limits

§ 15.407 (h) and FCC KDB 905462 D02 UNII DFS Compliance Procedures New Rules v02 Compliance measurement procedures for unlicensed-national information infrastructure devcies operating in the 5250-5350 MHZ and 5470-5725 MHZ bands incorporating dynamic frequency selection.

Table 1: Applicability of DFS Requirements Prior to Use of a Channel			
Requirement	Operational Mode		
	Master	Client (without Radar Detection)	Client (with Radar Detection)
Non-Occupancy Period	Yes	Not required	Yes
DFS Detection Threshold	Yes	Not required	Yes
Channel Availability Check Time	Yes	Not required	Not required
U-NII Detection Bandwidth	Yes	Not required	Yes

Table 2: Applicability of DFS requirements during normal operation		
Requirement	Operational Mode	
	Master Device or Client With Radar Detection	Client without Radar Detection
DFS Detection Threshold	Yes	Not required
Channel Closing Transmission Time	Yes	Yes
Channel Move Time	Yes	Yes
U-NII Detection Bandwidth	Yes	Not required

Additional requirements for devices with multiple bandwidth modes	Master Device or Client With Radar Detection	Client without Radar Detection
U-NII Detection Bandwidth and Statistical Performance Check	All BW modes must be tested	Not required
Channel Move Time and Channel Closing Transmission Time	Test using widest BW mode available	Test using the widest BW mode available for the link
All other tests	Any single BW mode	Not required

Note : Frequencies selected for statistical performance check (Section 7.8.4) should include several frequencies within the radar detection bandwidth and frequencies near the edge of the radar detection bandwidth. For 802.11 devices it is suggested to select frequencies in all 20 MHz channel blocks and a null frequencies between the bonded 20 MHz channel blocks

Table 3: DFS Detection Thresholds for Master Devices and Client Devices With Radar Detection	
Maximum Transmit Power	U-NII Band 2-Aalue (See Notes 1,2 and 3)
EIRP \geq 200 milliwatt	-64 dBm
EIRP < 200 milliwatt and Power spectral density < 10 dBm/MHz	-62 dBm
EIRP < 200 milliwatt that do not meet the power spectral density requirement	-64 dBm
Note 1: This is the level at the input of the receiver assuming a 0 dBi receive antenna. Note 2: Throughout these test procedures an additional 1 dB has been added to the amplitude of the test transmission waveforms to account for variations in measurement equipment. This will ensure that the test signal is at or above the detection threshold level to trigger a DFS response. Note 3: EIRP is based on the highest antenna gain. For MIMO devices refer to FCC KDB Publication 662911 D01.	

Table 4: DFS Response Requirement U-NII Band 2-Aalues	
Parameter	U-NII Band 2-Aalue
Non-occupancy period	Minimum 30 minutes
Channel Availability Check Time	60 seconds
Channel Move Time	10 seconds See Note 1.
Channel Closing Transmission Time	200 milliseconds + an aggregate of 60 milliseconds over remaining 10 second period. See Notes 1 and 2.
U-NII Detection Bandwidth	Minimum 100 % of the U-NII 99 % transmission power bandwidth. See Note 3.
Note 1: Channel Move Time and the Channel Closing Transmission Time should be performed with Radar Type 0. The measurement timing begins at the end of the Radar Type 0 burst. Note 2: The Channel Closing Transmission Time is comprised of 200 milliseconds starting at the beginning of the Channel Move Time plus any additional intermittent control signals required to facilitate a Channel move (an aggregate of 60 milliseconds) during the remainder of the 10 second period. The aggregate duration of control signals will not count quiet periods in between transmissions. Note 3: During the U-NII Detection Bandwidth detection test, radar type 0 should be used. For each frequency step the minimum percentage of detection is 90 percent. Measurements are performed with no data traffic.	

Table 5: Short Pulse Radar Test Waveforms					
Radar Type	Pulse Width (μsec)	PRI (μsec)	Number of Pulses	Minimum Percentage of Successful Detection	Minimum Number of Trials
0	1	1428	18	See Note 1	See Note 1
1	1	Test A: 15 unique PRI values randomly selected from the list of 23 PRI values in Table 5a <hr/> Test B: 15 unique PRI values randomly selected within the range of 518-3066 μsec, with a minimum increment of 1 μsec, excluding PRI values selected in Test A	Roundup $\left\{ \begin{array}{l} \left(\frac{1}{360} \right) \cdot \\ \left(\frac{19 \cdot 10^6}{\text{PRI}_{\mu\text{sec}}} \right) \end{array} \right\}$	60 %	30
2	1-5	150-230	23-29	60 %	30
3	6-10	200-500	16-18	60 %	30
4	11-20	200-500	12-16	60 %	30
Aggregate (Radar Types 1-4)				80 %	120
Note 1: Short Pulse Radar Type 0 should be used for the detection bandwidth test, channel move time, and channel closing time tests.					

Table 5a: Pulse Repetition Intervals U-NII Band 2-Aalues for Test A		
Pulse Repetition Frequency Number	Pulse Repetition Frequency (Pulses Per Second)	Pulse Repetition Interval (Microseconds)
1	1930.5	518
2	1858.7	538
3	1792.1	558
4	1730.1	578
5	1672.2	598
6	1618.1	618
7	1567.4	638
8	1519.8	658
9	1474.9	678
10	1432.7	698
11	1392.8	718
12	1355	738
13	1319.3	758
14	1285.3	778
15	1253.1	798
16	1222.5	818
17	1193.3	838
18	1165.6	858
19	1139	878
20	1113.6	898
21	1089.3	918
22	1066.1	938
23	326.2	3066

Table 6 – Long Pulse Radar Test Signal							
Radar Waveform	Bursts	Pulses per Burst	Pulse Width (µsec)	Chirp Width (MHz)	PRI (µsec)	Minimum Percentage of Successful Detection	Minimum Trials
5	8-20	1-3	50-100	5-20	1000-2000	80 %	30

Table 7 – Frequency Hopping Radar Test Signal							
Radar Waveform	Pulse Width (µsec)	PRI (µsec)	Burst Length (ms)	Pulses per Hop	Hopping Rate (kHz)	Minimum Percentage of Successful Detection	Minimum Trials
6	1	333	300	9	0.333	70 %	30

3.2. Test and Measurement System

3.2.1. Setup for Master with injection at the Master

Example Radiated Setup where UUT is a Master and Radar Test Waveforms are injected into the Master

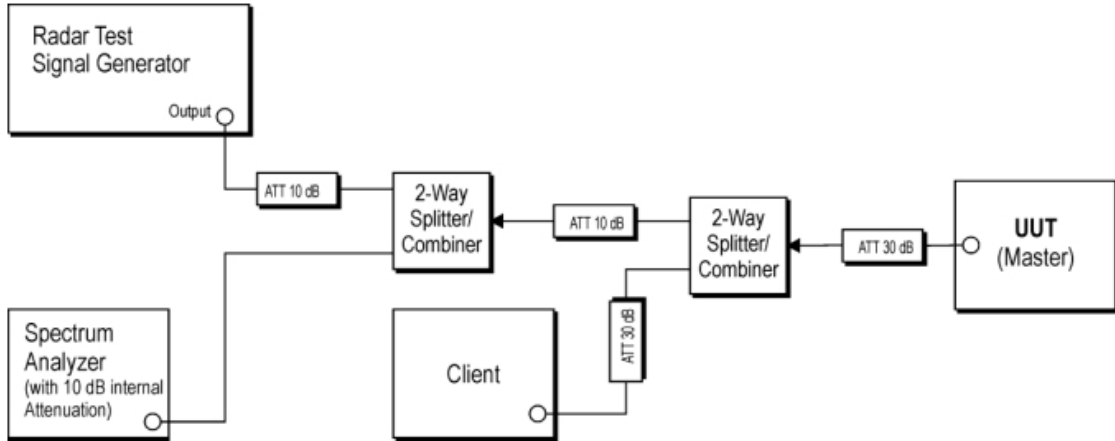

Tested System Details

The types for all equipments, plus descriptions of all cables used in the tested system (including inserted cards) are:

	Product	Manufacturer	Model No.	ID
1.	Mobile phone	Samsung	SM-F926U	FCC ID : A3LSMF926U

3.2.2. System Calibration

The short pulse types 0,1,2, 3 and 4, and the long pulse type 5 parameters are randomized at run-time. The hopping type 6 pulse parameters are fixed while the hopping sequence is based on the May 2014 NTIA Hopping Frequency List. The initial starting point randomized at run-time and each subsequent starting point is incremented by 475. Each frequency in the 100-length segment is compared to the boundaries of the EUT Detection Bandwidth and the software creates a hopping burst pattern in accordance with Section 7.4.1.3 Method #2 Simulated Frequency Hopping Radar Waveform Generating Subsystem of FCC KDB 905462 D02 UNII DFS Compliance Procedures New Rules v02 The frequency of the signal generator is incremented in 1 MHz steps from FL to FH for each successive trial. This incremental sequence is repeated as required to generate a minimum of 30 total trials and to maintain a uniform frequency distribution over the entire Detection Bandwidth.

The signal monitoring equipment consists of a spectrum analyzer. The aggregate ON time is calculated by multiplying the number of bins above a threshold during a particular observation period by the dwell time per bin, with the analyzer set to peak detection and max hold.

3.2.3. System Calibration

The Interference Radar Detection Threshold Level is (-63 dBm), The above equipment setup was used to calibrate the radiated Radar Waveform. A vector signal generator was utilized to establish the test signal level for each radar type. During this process there were replace 50 ohm terminal form Master and Client device and no transmissions by either the Master or Client Device. The spectrum analyzer was switched to the zero span (Time Domain) at the frequency of the Radar Waveform generator. Peak detection was used. The spectrum analyzer resolution bandwidth (RBW) and video bandwidth (U-NII Band 2-ABW) were set to at least 3 MHz.

The vector signal generator amplitude was set so that the power level measured at the spectrum analyzer was (-63 dBm). Capture the spectrum analyzer plots on short pulse radar types, long pulse radar type and hopping radar waveform.

3.2.4. Adjustment of Displayed Traffic Level

A link is established between the Master and Slave and the distance between the units is adjusted as needed to provide a suitable received level at the Master and Slave devices. Software to ping the client is permitted to simulate data transfer but must have random ping intervals. The monitoring antenna is adjusted so that the WLAN traffic level, as displayed on the spectrum analyzer, is at lower amplitude than the radar detection threshold.

3.3. Test Instruments

For Conducted

Test Period: Oct. 4 ~ Oct. 05, 2022

Testing Engineer: Brian Lin

Test Site		RF01-BD				
Use	Equipment	Manufacturer	Model Number	Serial Number	Cal. Date	Cal. Period
<input type="checkbox"/>	Power Sensor	Anritsu	MA2411B	1126022	Sep. 04, 2022	1 year
<input type="checkbox"/>	Power Meter	Anritsu	ML2495A	1135009	Sep. 04, 2022	1 year
<input checked="" type="checkbox"/>	Spectrum Analyzer (10 Hz~26.5 GHz)	Keysight	N9010B	MY59071418	Mar. 16, 2022	1 year
<input checked="" type="checkbox"/>	Signal Generator	Keysight	N5182B	MY53052569	Apr. 16, 2022	1 year
<input checked="" type="checkbox"/>	Signal Generator	Keysight	N5182BX07	MY59360221	Apr. 16, 2022	1 year

Note: N.C.R. = No Calibration Request

4 Test Methodology

4.1. Mode of Operation

Decision of Test Eurofins has verified the construction and function in typical operation. All the test modes were carried out with the EUT in normal operation, which was shown in this test report and defined as:

Test Mode
802.11ax HE160

802.11ax HE160:

Unless otherwise noted, all tests were performed with the radar burst at the channel center frequency of 5570 MHz.

4.2. EUT Test Step

1.	Setup the EUT shown on 3.2.
2.	Turn on the power of all equipment.
3.	Turn on Wi-Fi function link to Access Point.
4.	The EUT is operated in the normal mode to the purposes of measurement.

4.3. Test Site Environment

Items	Required (IEC 60068-1)	Actual
Temperature (°C)	15-35	20-30
Humidity (%RH)	25-75	45-75

5 Test Results

5.1. Radar Waveforms and Traffic

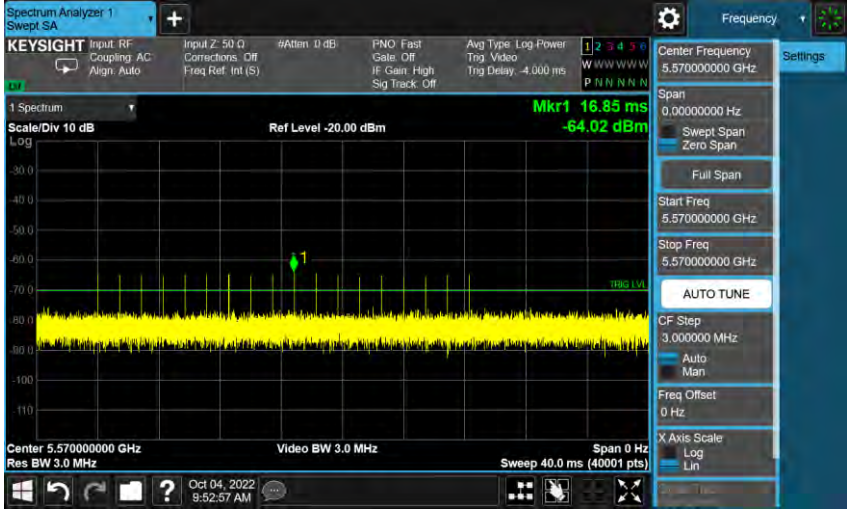
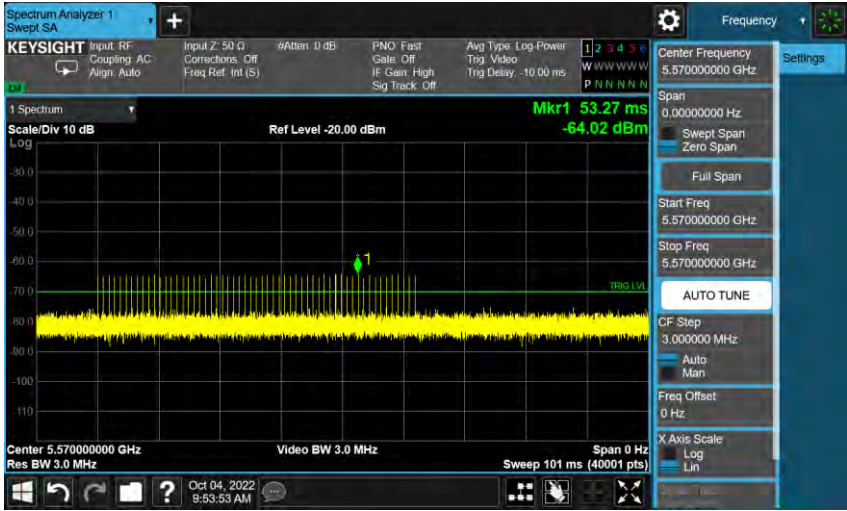
802.11ax HE160_5570 MHz	
<p>Short Pulse Radar Type 0</p>	 <p>The screenshot shows a Keysight Spectrum Analyzer interface. The main display is a spectrum plot with a yellow signal trace. A green marker 'Mkr1' is positioned at 16.85 ms and -64.02 dBm. The center frequency is 5.570000000 GHz, and the span is 0 Hz. The sweep time is 40.00 ms. The interface includes various control panels for input, settings, and display options.</p>
<p>Short Pulse Radar Type 1A</p>	 <p>The screenshot shows a Keysight Spectrum Analyzer interface. The main display is a spectrum plot with a yellow signal trace. A green marker 'Mkr1' is positioned at 53.27 ms and -64.02 dBm. The center frequency is 5.570000000 GHz, and the span is 0 Hz. The sweep time is 101 ms. The interface includes various control panels for input, settings, and display options.</p>

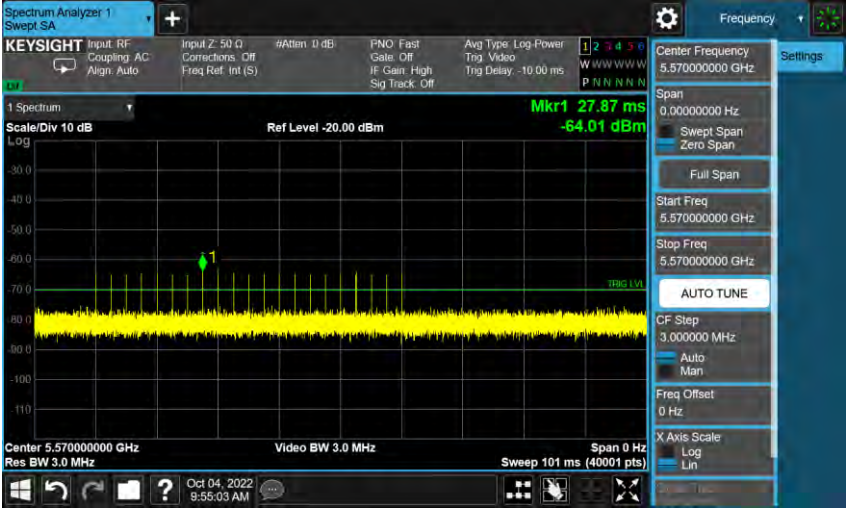
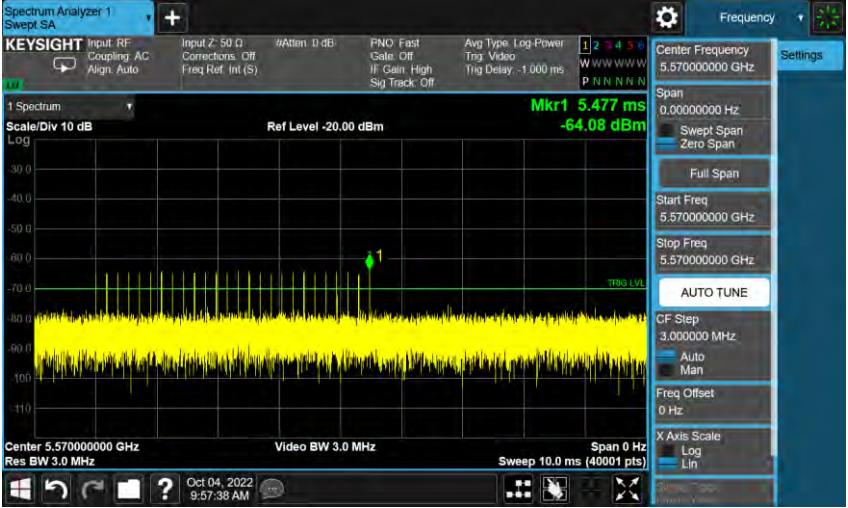
802.11ax HE160_5570 MHz	
<p>Short Pulse Radar Type 1B</p>	 <p>The screenshot shows a Keysight Spectrum Analyzer interface. The main display is a spectrum plot with a yellow signal trace. A marker 'Mkr1' is placed at 27.87 ms with a level of -64.01 dBm. The center frequency is 5.570000000 GHz, and the video bandwidth is 3.0 MHz. The sweep rate is 101 ms. The interface includes various control panels for settings, span, and frequency.</p>
<p>Short Pulse Radar Type 2</p>	 <p>The screenshot shows a Keysight Spectrum Analyzer interface. The main display is a spectrum plot with a yellow signal trace. A marker 'Mkr1' is placed at 5.477 ms with a level of -64.08 dBm. The center frequency is 5.570000000 GHz, and the video bandwidth is 3.0 MHz. The sweep rate is 10.0 ms. The interface includes various control panels for settings, span, and frequency.</p>

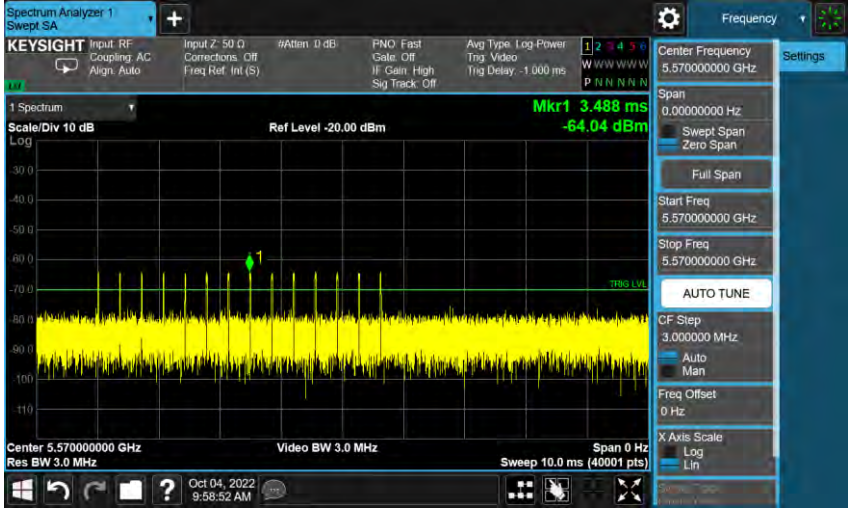
802.11ax HE160_5570 MHz	
<p>Short Pulse Radar Type 3</p>	
<p>Short Pulse Radar Type 4</p>	

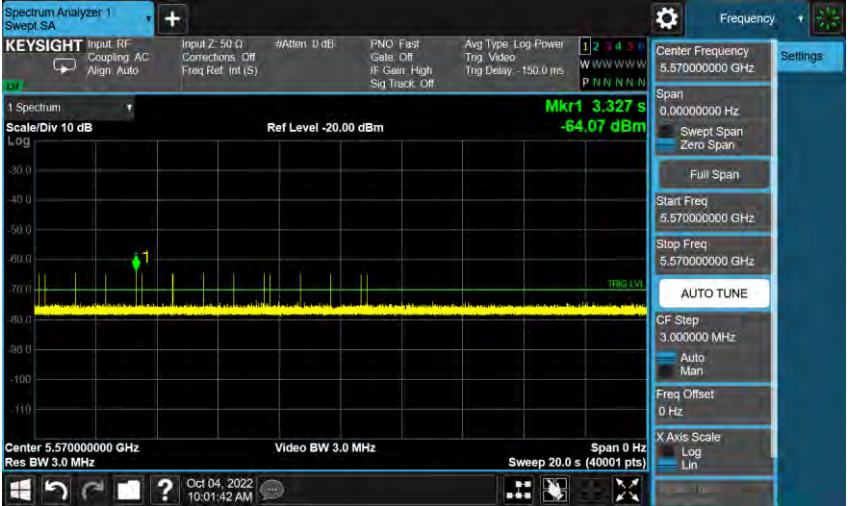
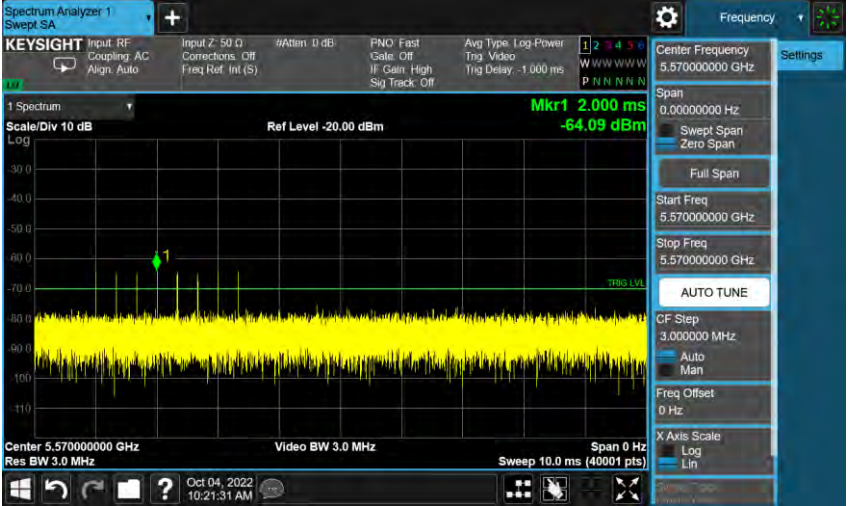
802.11ax HE160_5570 MHz	
<p>Long Pulse Radar Type 5</p>	
<p>Frequency Hopping Radar Type 6</p>	

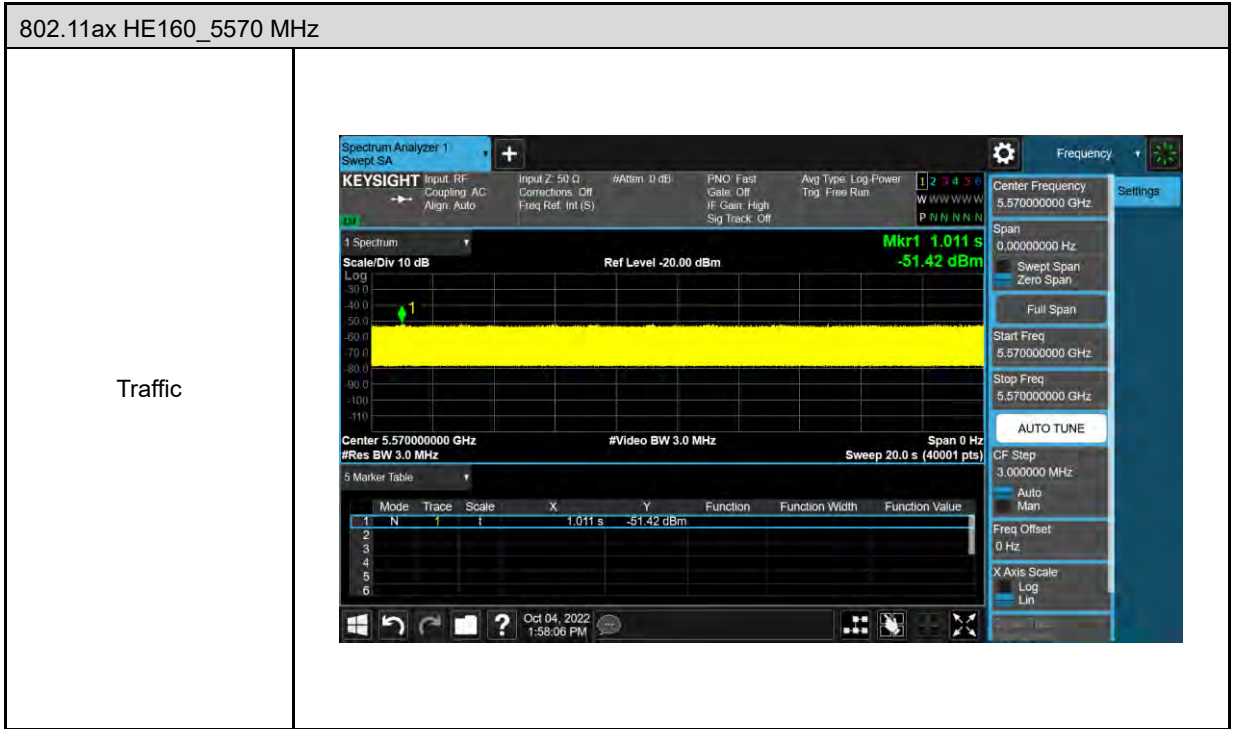

5.2. Channel Loading

High Band

■ Duty cycle $\geq 17\%$

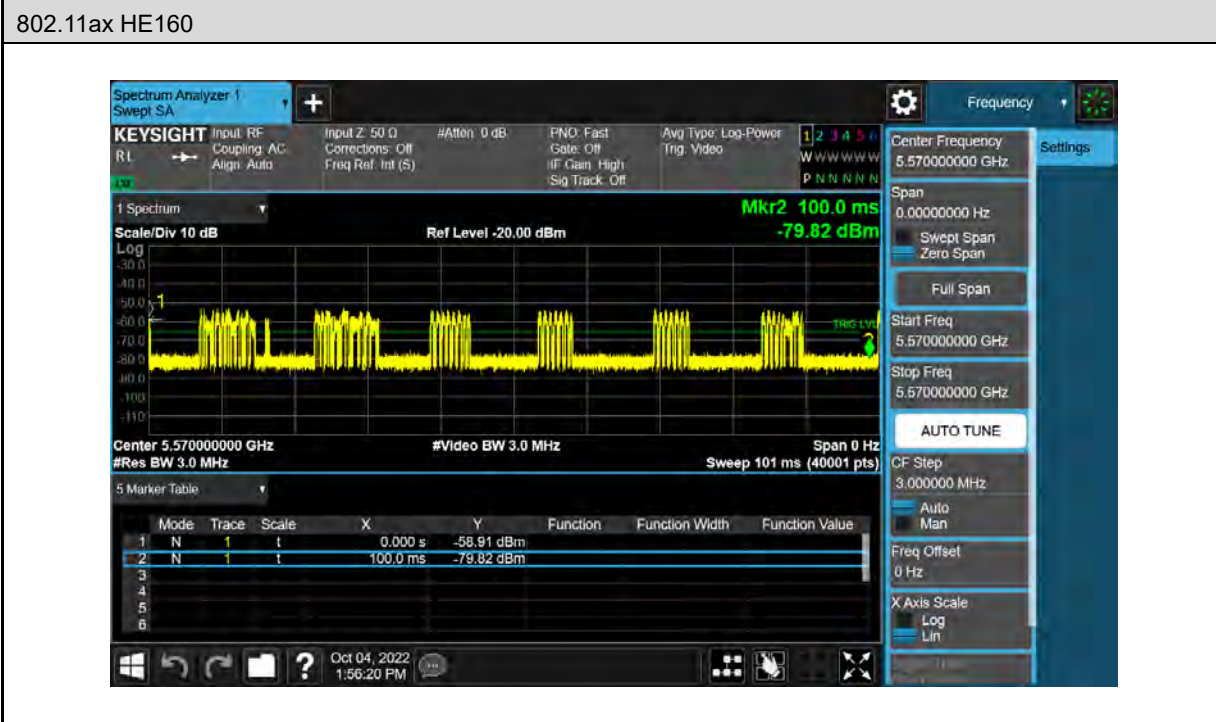

5.3. Channel Availability Check Time

5.3.1. Procedure to Determine Initial Power-Up Cycle Time

A link was established on channel then the EUT was rebooted. The time from the cessation of traffic to the re-initialization of traffic was measured as the time required for the EUT to complete the total power-up cycle. The time to complete the initial power-up period is 60 seconds less than this total power-up time.

5.3.2. Procedure for Timing Of Radar Burst

With a link established on channel, the EUT was rebooted. A radar signal was triggered within 0 to 6 seconds after the initial power-up period, and transmissions on the channel were monitored on the spectrum analyzer.

The Non-Occupancy list was cleared. With a link established on channel, the EUT was rebooted. A radar signal was triggered within 54 to 60 seconds after the initial power-up period, and transmissions on the channel were monitored on the spectrum analyzer.

5.3.3. Quantitative Results

No Radar Triggered						
Test Mode	Frequency (MHz)	Timing of Reboot (sec)	Delta (sec)	Timing of Start of Traffic (sec)	Total Power-up Cycle Time (sec)	Initial Power-up Cycle Time (sec)
802.11ax HE160	5570	7.684	117.000	124.684	117.000	57.000

Radar Near Beginning of CAC					
Test Mode	Frequency (MHz)	Timing of Reboot (sec)	Timing of Radar Burst (sec)	Radar Relative to Reboot (sec)	Radar Relative to Start of CAC (sec)
802.11ax HE160	5570	7.684	66.130	58.446	1.446

Radar Near End of CAC					
Test Mode	Frequency (MHz)	Timing of Reboot (sec)	Timing of Radar Burst (sec)	Radar Relative to Reboot (sec)	Radar Relative to Start of CAC (sec)
802.11ax HE160	5570	7.684	120.100	112.416	55.416

5.3.4. Qualitative Results

Timing of Radar Burst	Display on Control Computer	Spectrum Analyzer Display
No Radar Triggered	EUT marks Channel as active	Transmissions begin on channel after completion of the initial power-up cycle and the CAC
Within 0 to 6 second window	EUT indicates radar detected	No transmissions on channel
Within 54 to 60 second window	EUT indicates radar detected	No transmissions on channel

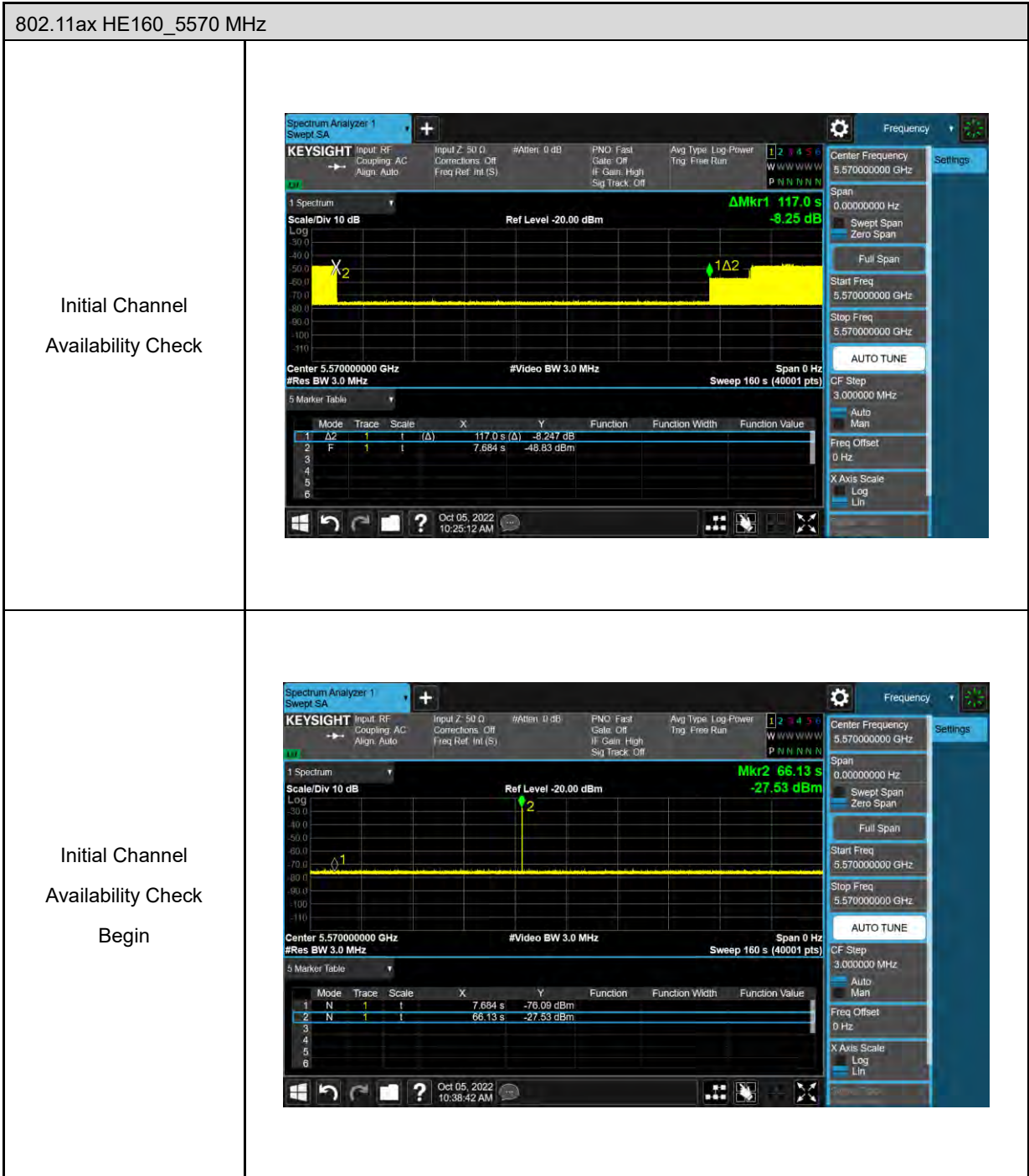

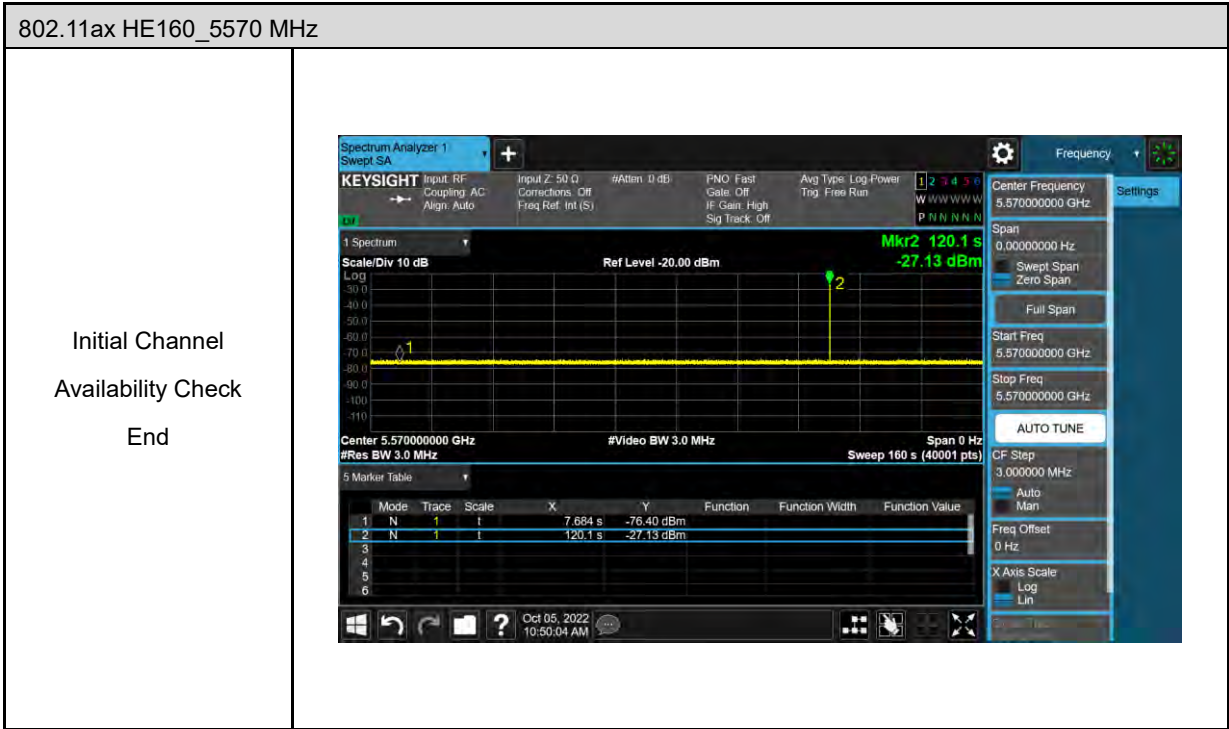

5.4. Channel Move Time and Channel Closing Transmission Time

5.4.1. Reporting Notes

The reference marker is set at the end of last radar pulse.

The delta marker is set at the end of the last WLAN transmission following the radar pulse.

This delta is the channel move time.

The aggregate channel closing transmission time is calculated as follows:

Aggregate Transmission Time = (Number of analyzer bins showing transmission) * (dwell time per bin)

The Channel Closing Transmission Time is comprised of 200 milliseconds starting at the beginning of the Channel Move Time plus any additional intermittent control signals required to facilitate a Channel move (an aggregate of 60 milliseconds) during the remainder of the 10 second period. The aggregate duration of control signals will not count quiet periods in between transmissions.

Results

Test Mode	Frequency (MHz)	Radar Type	Channel Move Time (sec)	Limit (sec)
			Master	
802.11ax HE160	5570	Type 0	1.4370	10

Frequency (MHz)	Frequency (MHz)	Radar Type	Aggregate Channel Closing Transmission Time (msec)	Limit (msec)
			Master	
802.11ax HE160	5570	Type 0	7.9998	60

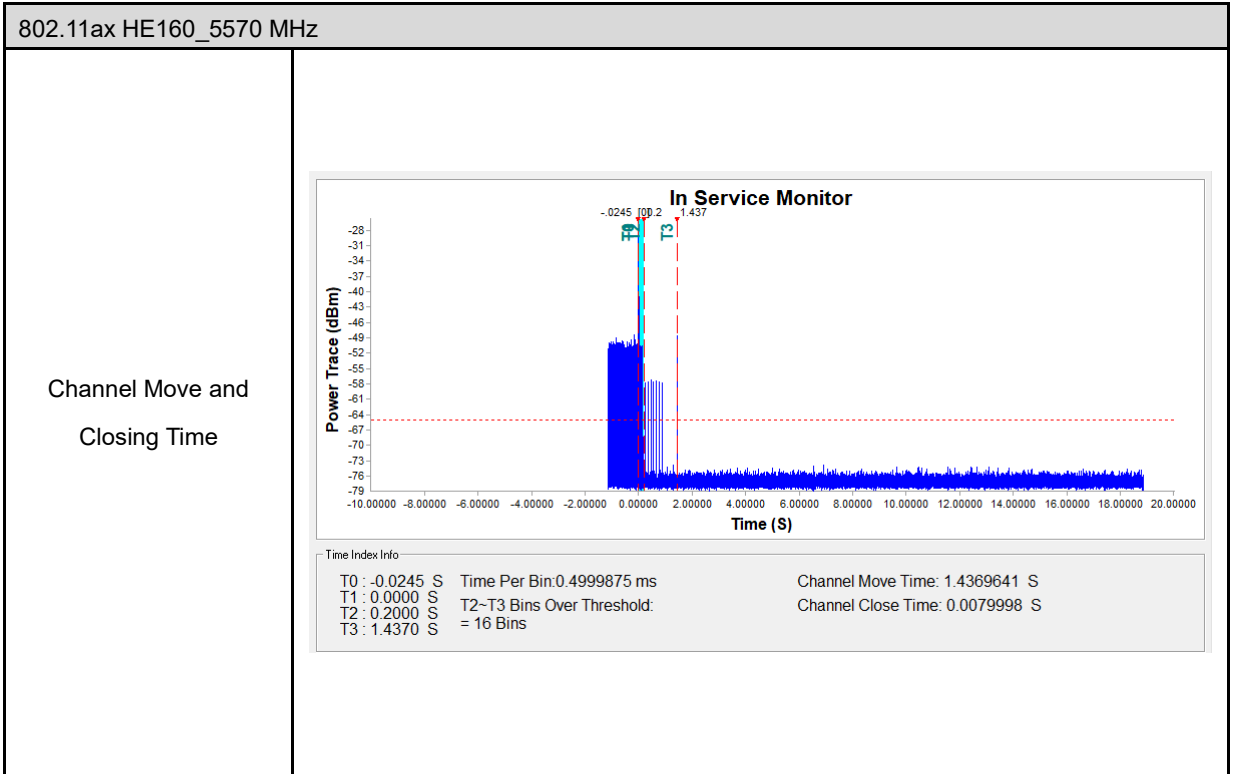

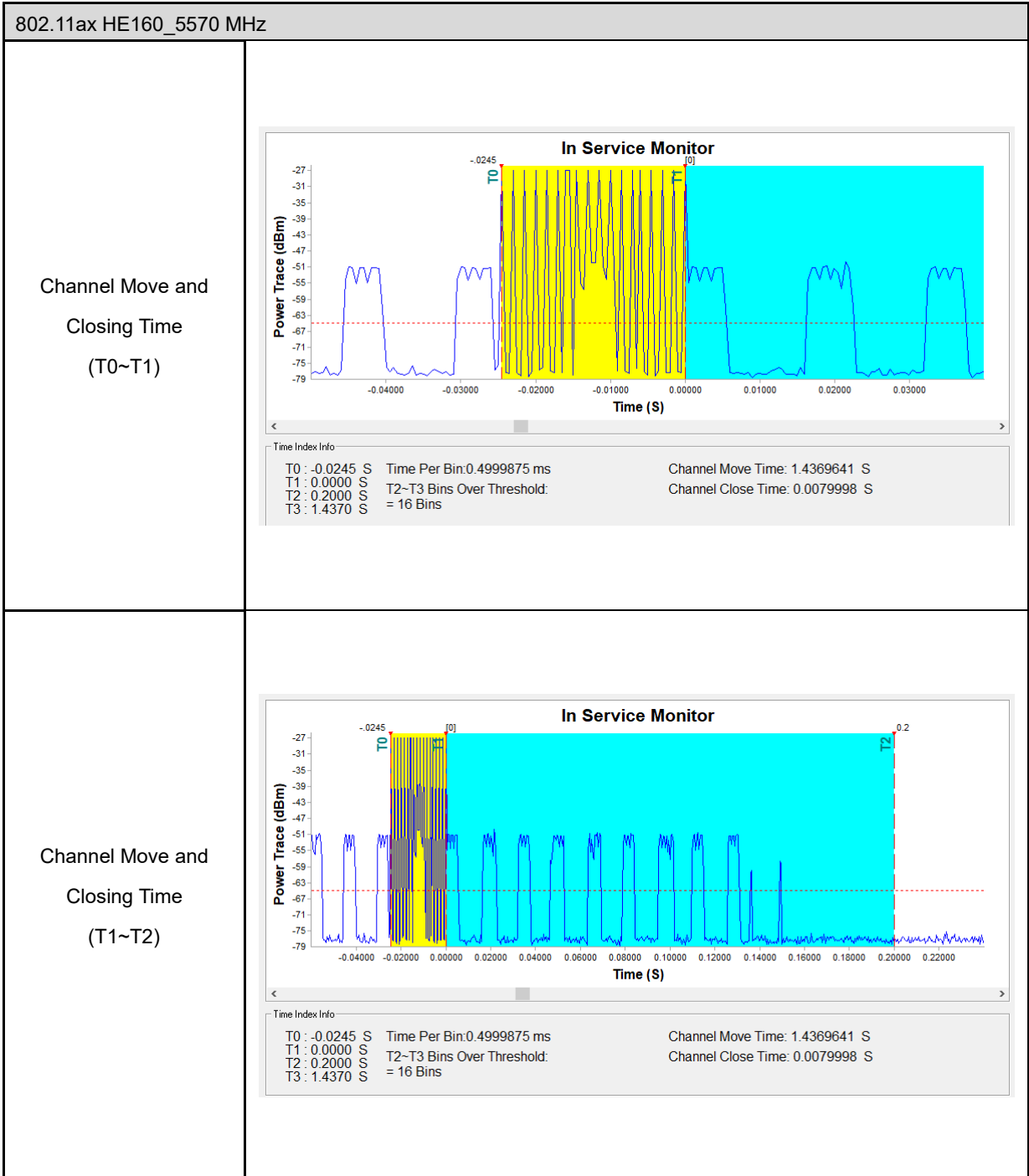

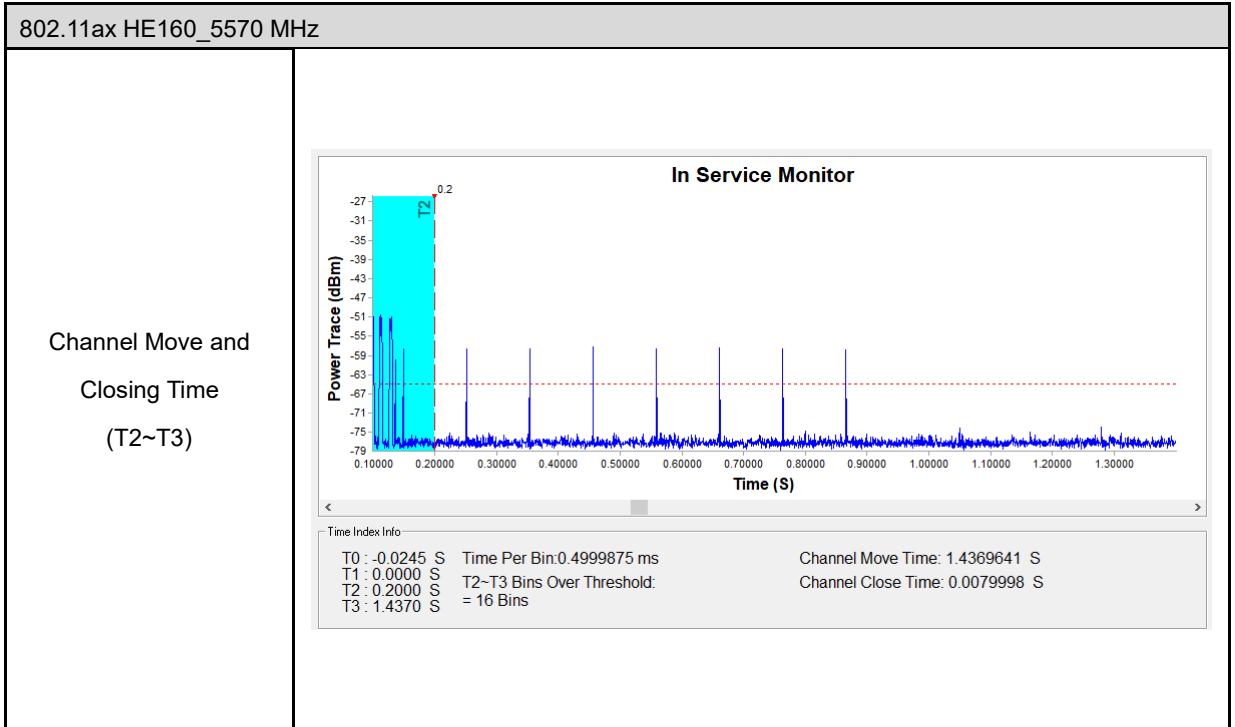

5.5. Non-Occupancy Period

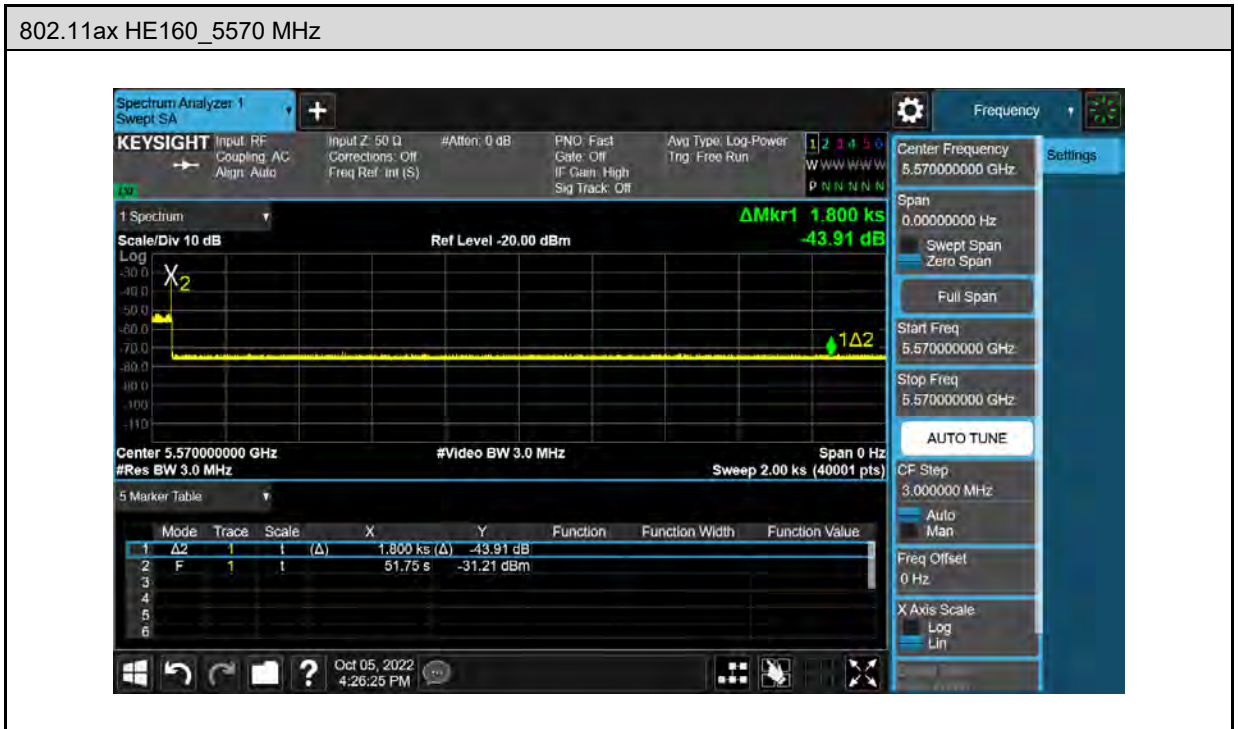

Note: Non-Occupancy Period time is 30 minute during which a Channel will not be utilized after a Radar Waveform is detected on that Channel.

5.6. U-NII Detection Bandwidth

■ Test Results

Test Mode	802.11ax HE160					
Frequency (MHz)	FL (MHz)	FH (MHz)	Detection Bandwidth (MHz)	99 % Power Bandwidth (MHz)	Ratio of Detection BW to 99 % Power BW (%)	Minimum Limit (%)
5570	5494	5649	155	153.73	100.83	≥ 100

■ Test Graphs



5.7. Statistical Performance check

■ Test Results

Master Mode

Test Mode		802.11ax HE160					
Frequency (MHz)	Radar Signal	PRI (Msec)	Pulse width W (μs)	Pass Times	Fail Times	Probability	Limit
5570	Type1	Table 5a	1	27	3	90.00%	≥60 %
	Type2	Random	Random	26	4	86.67%	≥60 %
	Type3	Random	Random	24	6	80.00%	≥60 %
	Type4	Random	Random	26	4	86.67%	≥60 %
	Type1~4					85.83%	≥80 %
	Type5	Random	Random	24	6	80.00%	≥80 %
	Type6	Hopping		1	26	4	86.67%

Test Mode		802.11ax HE160				
Frequency		5570 MHz				
Radar Signal		Type 1				
Trial #	Test Frequency (MHz)	Pulse Width (us)	PRI (us)	Number of Pluse	PRF (Hz)	1=Detection ; 0=No Detection
1	5570	1	698	76	1433	1
2	5570	1	838	63	1193	1
3	5570	1	698	76	1433	1
4	5570	1	678	78	1475	1
5	5570	1	898	59	1114	1
6	5570	1	878	61	1139	0
7	5570	1	638	83	1567	1
8	5570	1	718	74	1393	1
9	5570	1	678	78	1475	1
10	5570	1	798	67	1253	1
11	5570	1	538	99	1859	1
12	5570	1	518	102	1931	1
13	5570	1	558	95	1792	0
14	5570	1	3066	18	326	1
15	5570	1	518	102	1931	1
16	5570	1	2782	19	359	1
17	5570	1	521	102	1919	1
18	5570	1	665	80	1504	1
19	5570	1	1037	51	964	1
20	5570	1	1641	33	609	1
21	5570	1	1390	38	719	1
22	5570	1	2524	21	396	1
23	5570	1	551	96	1815	1
24	5570	1	1942	28	515	1
25	5570	1	2579	21	388	0
26	5570	1	2756	20	363	1
27	5570	1	2909	19	344	1
28	5570	1	835	64	1198	1
29	5570	1	2367	23	422	1
30	5570	1	1806	30	554	1
Detection Percentage (%)						90.00

Test Mode		802.11ax HE160				
Frequency		5570 MHz				
Radar Signal		Type 2				
Trial #	Test Frequency (MHz)	Pulse Width (us)	PRI (us)	Number of Pluse	PRF (Hz)	1=Detection ; 0=No Detection
1	5570	4.00	191.90	28	5211	1
2	5570	3.20	169.10	25	5914	1
3	5570	3.90	154.50	25	6472	1
4	5570	1.90	188.70	28	5299	1
5	5570	3.30	161.90	27	6177	1
6	5570	4.70	208.50	28	4796	1
7	5570	2.30	157.00	27	6369	1
8	5570	1.00	184.00	23	5435	1
9	5570	3.70	156.00	25	6410	1
10	5570	1.40	196.90	28	5079	1
11	5570	1.70	170.10	25	5879	1
12	5570	1.60	212.40	26	4708	1
13	5570	4.60	154.80	23	6460	1
14	5570	1.10	158.90	29	6293	1
15	5570	1.60	229.50	23	4357	1
16	5570	2.70	171.90	26	5817	0
17	5570	2.30	219.80	23	4550	0
18	5570	3.40	229.60	26	4355	1
19	5570	1.90	165.80	26	6031	1
20	5570	2.50	205.40	29	4869	1
21	5570	1.40	157.30	29	6357	1
22	5570	4.60	220.60	25	4533	1
23	5570	3.90	152.40	25	6562	1
24	5570	4.20	199.30	29	5018	1
25	5570	3.10	169.10	24	5914	0
26	5570	2.60	206.80	26	4836	1
27	5570	2.10	178.40	27	5605	1
28	5570	2.80	172.90	24	5784	1
29	5570	3.90	160.20	29	6242	1
30	5570	1.90	160.80	24	6219	0
Detection Percentage (%)						86.67

Test Mode		802.11ax HE160				
Frequency		5570 MHz				
Radar Signal		Type 3				
Trial #	Test Frequency (MHz)	Pulse Width (us)	PRI (us)	Number of Pluse	PRF (Hz)	1=Detection ; 0=No Detection
1	5570	6.50	218.30	16	4580.85	1
2	5570	8.40	211.30	17	4732.61	1
3	5570	8.80	411.50	16	2430.13	0
4	5570	8.70	318.70	17	3137.75	1
5	5570	9.00	252.40	17	3961.97	1
6	5570	10.00	445.40	17	2245.17	1
7	5570	7.30	320.60	17	3119.15	1
8	5570	6.00	449.30	16	2225.68	1
9	5570	9.00	368.50	18	2713.70	1
10	5570	8.70	372.40	16	2685.28	1
11	5570	9.90	304.10	16	3288.39	0
12	5570	7.10	269.60	16	3709.20	1
13	5570	7.30	440.60	17	2269.63	1
14	5570	8.90	433.20	17	2308.40	1
15	5570	7.50	274.20	18	3646.97	0
16	5570	7.30	451.50	18	2214.84	1
17	5570	9.00	464.50	18	2152.85	1
18	5570	9.20	407.80	16	2452.18	1
19	5570	8.00	465.40	17	2148.69	1
20	5570	6.60	238.70	16	4189.36	1
21	5570	9.20	271.50	16	3683.24	0
22	5570	8.20	237.30	17	4214.08	1
23	5570	7.00	279.80	17	3573.98	1
24	5570	7.10	408.30	16	2449.18	1
25	5570	8.80	346.00	18	2890.17	1
26	5570	9.90	418.50	18	2389.49	0
27	5570	8.10	204.60	16	4887.59	1
28	5570	7.90	424.70	17	2354.60	1
29	5570	9.40	479.40	16	2085.94	1
30	5570	8.90	243.60	16	4105.09	0
Detection Percentage (%)						80.00

Test Mode		802.11ax HE160				
Frequency		5570 MHz				
Radar Signal		Type 4				
Trial #	Test Frequency (MHz)	Pulse Width (us)	PRI (us)	Number of Pluse	PRF (Hz)	1=Detection ; 0=No Detection
1	5570	11.80	337.50	16	2963	1
2	5570	13.10	303.20	14	3298	1
3	5570	11.20	239.10	13	4182	1
4	5570	17.90	301.10	13	3321	1
5	5570	14.50	271.00	15	3690	1
6	5570	17.20	454.90	16	2198	1
7	5570	11.70	280.80	13	3561	1
8	5570	19.70	483.20	12	2070	0
9	5570	14.60	469.20	16	2131	1
10	5570	13.60	207.40	15	4822	1
11	5570	14.70	283.20	16	3531	1
12	5570	17.30	363.40	14	2752	1
13	5570	19.60	336.70	14	2970	1
14	5570	16.20	211.40	15	4730	1
15	5570	14.20	387.40	16	2581	1
16	5570	18.80	261.90	16	3818	0
17	5570	16.30	327.90	14	3050	0
18	5570	15.00	326.40	16	3064	1
19	5570	17.00	491.70	14	2034	1
20	5570	19.40	483.50	16	2068	1
21	5570	15.70	276.00	12	3623	1
22	5570	17.60	272.10	14	3675	0
23	5570	14.80	451.00	15	2217	1
24	5570	19.20	232.30	15	4305	1
25	5570	12.20	295.60	14	3383	1
26	5570	17.50	248.70	15	4021	1
27	5570	17.20	458.70	15	2180	1
28	5570	17.10	366.30	16	2730	1
29	5570	11.40	408.50	12	2448	1
30	5570	14.10	443.20	16	2256	1
Detection Percentage (%)						86.67

Test Mode		802.11ax HE160					
Frequency		5570 MHz					
Radar Signal		Type 5					
Trial #	Test Frequency (MHz)	Burst#	Pulse Width (us)	Chirp Width (MHz)	PRI (us)	Number of Pulses / Burst	1=Detection ; 0=No Detection
1	5496	1	75.4	8	1097.1	2	1
	5499	2	78.9	14	1630.8	3	
	5497	3	67.9	11	1171.1	1	
	5500	4	80.9	18	1550.8	2	
	5500	5	59.1	18	1142.9	3	
	5498	6	55.2	12	1899.9	2	
	5496	7	67.5	7	1790.7	1	
	5499	8	88.2	16	1329.1	2	
	5499	9	86.8	14	1448.6	3	
	5498	10	53.3	12	1643.3	3	
	5498	11	93.2	13	1949.7	3	
2	5496	1	85.3	8	1940.2	2	1
	5501	2	96.8	19	1398.9	2	
	5500	3	87.9	17	1616.0	3	
	5496	4	96.8	7	1508.3	3	
	5500	5	82.9	17	1109.1	2	
	5495	6	84.2	6	1044.1	3	
	5500	7	95.5	18	1753.0	3	
	5495	8	57.2	6	1731.5	1	
	5496	9	58.3	7	1271.2	1	
	5501	10	54.3	19	1798.4	1	
	5499	11	79.3	16	1566.2	3	
	5498	12	97.9	12	1874.4	1	
3	5497	1	88.5	10	1641.0	1	1
	5499	2	89.2	14	1414.5	2	
	5499	3	97.4	15	1744.2	2	
	5499	4	74.7	16	1312.9	1	
	5498	5	55.0	12	1334.7	1	
	5496	6	92.7	7	1550.5	3	
	5500	7	94.0	18	1056.3	3	
	5499	8	57.1	14	1749.8	1	
	5500	9	61.3	17	1711.3	1	
	5496	10	100.0	8	1578.8	3	
	5495	11	65.2	6	1732.5	1	
	5499	12	60.2	14	1684.5	3	
	5500	13	98.5	18	1844.0	1	

Test Mode		802.11ax HE160					
Frequency		5570 MHz					
Radar Signal		Type 5					
Trial #	Test Frequency (MHz)	Burst#	Pulse Width (us)	Chirp Width (MHz)	PRI (us)	Number of Pulses / Burst	1=Detection ; 0=No Detection
4	5501	1	87.4	20	1754.3	1	1
	5497	2	69.4	11	1329.6	3	
	5496	3	96.4	8	1885.7	3	
	5497	4	80.2	9	1138.3	3	
	5496	5	72.5	8	1521.6	2	
	5501	6	73.5	19	1077.4	2	
	5498	7	94.4	13	1448.6	3	
	5499	8	95.6	14	1126.3	2	
5	5501	9	61.0	20	1264.2	2	1
	5495	1	88.4	5	1839.2	1	
	5501	2	72.5	19	1435.8	1	
	5498	3	90.4	12	1723.3	1	
	5499	4	69.1	16	1559.4	3	
	5500	5	99.6	18	1829.0	1	
	5495	6	62.3	6	1929.4	2	
	5495	7	99.8	6	1101.4	2	
	5501	8	71.7	19	1241.8	3	
	5496	9	80.6	8	1018.7	3	
	5500	10	68.4	17	1313.3	2	
	5496	11	56.4	7	1729.3	2	
	5499	12	70.7	14	1338.1	3	
	5495	13	98.7	6	1326.5	2	
	5496	14	52.9	7	1670.3	2	
5498	15	85.1	13	1548.7	2		
6	5498	1	76.3	12	1222.8	1	1
	5495	2	99.3	6	1864.2	1	
	5499	3	57.3	14	1565.7	3	
	5497	4	95.6	11	1256.7	3	
	5495	5	85.5	6	1089.8	1	
	5497	6	83.5	11	1410.6	2	
	5499	7	68.7	14	1725.1	1	
	5501	8	89.7	20	1143.3	3	
	5500	9	67.4	18	1384.1	3	
	5501	10	50.8	19	1285.7	2	
	5499	11	98.7	16	1353.7	3	
	5499	12	98.5	15	1404.9	3	
	5499	13	55.8	16	1403.5	1	
	5501	14	93.4	19	1130.1	1	

Test Mode		802.11ax HE160					
Frequency		5570 MHz					
Radar Signal		Type 5					
Trial #	Test Frequency (MHz)	Burst#	Pulse Width (us)	Chirp Width (MHz)	PRI (us)	Number of Pulses / Burst	1=Detection ; 0=No Detection
7	5497	1	93.6	9	1780.1	1	1
	5498	2	99.1	13	1493.4	1	
	5497	3	50.9	10	1911.4	3	
	5497	4	59.1	11	1369.2	1	
	5499	5	76.0	16	1820.3	3	
	5496	6	91.4	7	1237.3	1	
	5501	7	87.5	19	1315.7	3	
	5499	8	50.9	15	1182.5	2	
	5499	9	59.0	15	1047.6	1	
	5500	10	51.8	17	1945.4	3	
	5497	11	81.9	11	1870.7	1	
	5498	12	73.1	13	1751.6	3	
	5496	13	88.8	7	1354.6	3	
	5495	14	53.6	5	1751.9	1	
	5498	15	76.9	12	1833.9	1	
	5496	16	53.4	8	1907.3	1	
	5500	17	95.3	18	1260.8	1	
8	5500	1	80.5	18	1970.2	1	1
	5495	2	90.8	5	1925.4	3	
	5497	3	75.9	11	1432.7	1	
	5500	4	51.1	17	1326.5	1	
	5500	5	74.8	17	1185.1	2	
	5497	6	93.1	10	1511.4	1	
	5501	7	55.0	20	1466.8	2	
	5496	8	84.4	7	1755.0	3	
	5498	9	60.0	12	1707.5	2	
	5498	10	52.9	13	1569.1	2	
	5497	11	77.1	10	1503.0	3	
	5499	12	60.1	15	1949.2	2	
	5501	13	95.5	19	1254.6	3	
	5495	14	63.0	6	1251.2	2	
	5496	15	73.5	8	1987.6	1	
	5501	16	83.0	19	1650.3	3	
	5501	17	84.4	19	1882.6	1	
	5500	18	55.6	17	1597.3	1	

Test Mode		802.11ax HE160					
Frequency		5570 MHz					
Radar Signal		Type 5					
Trial #	Test Frequency (MHz)	Burst#	Pulse Width (us)	Chirp Width (MHz)	PRI (us)	Number of Pulses / Burst	1=Detection ; 0=No Detection
9	5497	1	53.3	9	1525.7	2	1
	5497	2	51.4	10	1905.9	2	
	5495	3	65.1	6	1077.1	3	
	5497	4	63.9	11	1370.3	1	
	5499	5	90.6	16	1775.6	2	
	5499	6	77.8	16	1081.4	3	
	5497	7	95.6	9	1164.1	3	
	5500	8	88.9	17	1141.0	1	
	5495	9	61.4	6	1116.6	1	
	5495	10	74.7	6	1741.3	3	
	5496	11	57.7	8	1713.5	3	
	5498	12	95.0	13	1297.1	3	
	5496	13	87.6	7	1978.9	2	
	5498	14	94.7	13	1811.5	2	
	5500	15	65.0	18	1156.0	2	
	5500	16	84.3	17	1405.6	3	
	5500	17	52.7	17	1387.9	2	
	5499	18	59.5	15	1760.8	2	
	5497	19	72.9	10	1319.1	1	
10	5500	1	82.4	18	1794.0	1	0
	5500	2	67.7	18	1455.9	3	
	5497	3	86.0	9	1116.6	1	
	5498	4	60.2	13	1704.4	3	
	5499	5	89.9	16	1307.7	2	
	5500	6	80.3	17	1587.0	1	
	5497	7	98.3	9	1675.0	3	
	5500	8	55.1	17	1332.9	2	

Test Mode		802.11ax HE160					
Frequency		5570 MHz					
Radar Signal		Type 5					
Trial #	Test Frequency (MHz)	Burst#	Pulse Width (us)	Chirp Width (MHz)	PRI (us)	Number of Pulses / Burst	1=Detection ; 0=No Detection
11	5570	1	75.2	8	1651.2	1	0
	5570	2	65.7	13	1233.7	3	
	5570	3	94.6	14	1522.2	1	
	5570	4	100.0	6	1657.3	1	
	5570	5	80.8	20	1431.3	2	
	5570	6	78.3	8	1068.8	1	
	5570	7	60.0	12	1985.1	2	
	5570	8	81.2	12	1969.7	1	
	5570	9	51.6	20	1875.5	2	
	5570	10	61.8	9	1430.8	3	
	5570	11	94.3	13	1630.4	3	
	5570	12	72.7	14	1333.0	3	
	5570	13	57.9	14	1855.5	2	
	5570	14	97.6	19	1263.0	1	
	5570	15	82.0	16	1225.1	3	
	5570	16	51.1	11	1625.5	1	
12	5570	1	83.5	9	1166.0	3	1
	5570	2	61.1	16	1425.4	3	
	5570	3	57.3	9	1923.8	1	
	5570	4	53.2	18	1006.0	2	
	5570	5	98.8	7	1716.6	2	
	5570	6	57.2	5	1553.3	2	
	5570	7	95.5	14	1709.0	3	
	5570	8	58.6	13	1062.6	2	
	5570	9	72.4	18	1939.8	1	
	5570	10	77.1	9	1670.6	1	
	5570	11	84.8	11	1485.9	3	
	5570	12	89.7	12	1121.8	2	
	5570	13	58.6	17	1542.5	1	
	5570	14	83.5	13	1140.1	1	
	5570	15	99.8	12	1414.4	3	
	5570	16	82.2	8	1872.4	1	
	5570	17	97.6	11	1332.8	3	
	5570	18	58.7	17	1476.1	3	
	5570	19	94.0	17	1693.4	1	
	5570	20	70.2	12	1468.0	2	

Test Mode		802.11ax HE160					
Frequency		5570 MHz					
Radar Signal		Type 5					
Trial #	Test Frequency (MHz)	Burst#	Pulse Width (us)	Chirp Width (MHz)	PRI (us)	Number of Pulses / Burst	1=Detection ; 0=No Detection
13	5570	1	97.1	12	1549.9	2	1
	5570	2	87.7	15	1017.4	3	
	5570	3	76.8	9	1823.5	1	
	5570	4	79.4	10	1578.6	1	
	5570	5	92.0	10	1058.3	2	
	5570	6	56.2	6	1441.2	2	
	5570	7	70.2	18	1078.0	3	
	5570	8	85.6	14	1211.6	1	
	5570	9	78.2	15	1473.1	2	
	5570	10	85.7	7	1687.0	2	
14	5570	1	57.4	6	1057.4	1	1
	5570	2	66.0	5	1295.7	2	
	5570	3	76.5	18	1043.6	3	
	5570	4	94.4	6	1205.2	2	
	5570	5	72.0	18	1786.4	2	
	5570	6	80.7	20	1791.5	1	
	5570	7	52.8	19	1202.4	1	
	5570	8	54.7	19	1906.8	1	
	5570	9	60.7	14	1012.2	2	
	5570	10	72.0	8	1537.0	1	
	5570	11	95.3	11	1412.7	1	
	5570	12	91.9	11	1483.4	3	
	5570	13	69.0	13	1270.4	3	
	5570	14	89.6	10	1436.3	2	
	5570	15	88.9	10	1209.1	1	
	5570	16	54.0	11	1984.5	2	
	5570	17	90.2	11	1570.4	1	
	5570	18	70.8	10	1733.9	1	
	5570	19	87.2	17	1468.0	1	
	5570	20	95.6	16	1899.4	2	

Test Mode		802.11ax HE160					
Frequency		5570 MHz					
Radar Signal		Type 5					
Trial #	Test Frequency (MHz)	Burst#	Pulse Width (us)	Chirp Width (MHz)	PRI (us)	Number of Pulses / Burst	1=Detection ; 0=No Detection
15	5570	1	87.3	20	1143.0	2	1
	5570	2	94.2	6	1231.3	1	
	5570	3	98.7	6	1289.7	2	
	5570	4	79.7	14	1838.7	3	
	5570	5	56.8	12	1190.8	1	
	5570	6	70.3	20	1439.9	3	
	5570	7	76.5	16	1421.6	3	
	5570	8	62.6	18	1937.2	1	
	5570	9	69.1	10	1257.0	2	
	5570	10	85.1	20	1923.6	2	
	5570	11	76.5	11	1011.2	1	
	5570	12	83.5	10	1458.3	3	
	5570	13	56.6	13	1412.8	2	
	5570	14	58.4	9	1917.3	1	
	5570	15	99.5	17	1264.9	2	
	5570	16	84.6	17	1895.4	3	
	5570	17	64.1	9	1598.9	1	
	5570	18	65.0	18	1404.2	1	
	5570	19	53.8	9	1825.3	1	
16	5570	1	60.8	6	1858.3	1	1
	5570	2	59.0	15	1181.9	2	
	5570	3	73.6	11	1409.8	2	
	5570	4	73.5	12	1852.2	3	
	5570	5	89.3	16	1662.2	3	
	5570	6	72.4	13	1470.9	2	
	5570	7	62.1	11	1236.9	1	
	5570	8	53.2	12	1573.0	1	
	5570	9	95.9	16	1002.0	2	
	5570	10	59.4	5	1398.1	1	
	5570	11	50.1	8	1112.7	3	
	5570	12	73.2	14	1680.8	3	
	5570	13	80.0	15	1491.0	3	
	5570	14	80.4	12	1831.0	3	
	5570	15	61.6	9	1509.1	3	
	5570	16	80.0	13	1783.3	2	
	5570	17	70.0	13	1957.2	1	
	5570	18	90.9	7	1831.5	1	

Test Mode		802.11ax HE160					
Frequency		5570 MHz					
Radar Signal		Type 5					
Trial #	Test Frequency (MHz)	Burst#	Pulse Width (us)	Chirp Width (MHz)	PRI (us)	Number of Pulses / Burst	1=Detection ; 0=No Detection
17	5570	1	76.0	5	1439.1	3	0
	5570	2	92.5	11	1431.7	2	
	5570	3	96.0	19	1140.0	1	
	5570	4	87.4	13	1324.7	2	
	5570	5	50.2	19	1698.2	3	
	5570	6	76.0	7	1964.5	1	
	5570	7	53.8	8	1225.3	3	
	5570	8	74.8	17	1779.7	2	
	5570	9	86.6	12	1625.0	1	
	5570	10	98.5	17	1886.2	3	
	5570	11	54.2	5	1585.9	2	
	5570	12	57.5	10	1726.2	1	
	5570	13	92.1	19	1868.9	2	
	5570	14	68.0	5	1493.9	1	
	5570	15	84.8	7	1170.2	3	
	5570	16	91.0	12	1977.2	1	
	5570	17	93.1	18	1076.5	3	
18	5570	1	55.5	14	1777.2	3	1
	5570	2	72.0	8	1503.1	2	
	5570	3	88.7	18	1209.7	3	
	5570	4	78.3	12	1285.7	1	
	5570	5	93.4	7	1675.8	3	
	5570	6	90.1	9	1133.9	2	
	5570	7	91.2	14	1735.3	2	
	5570	8	57.5	19	1234.4	2	
	5570	9	60.2	8	1135.0	3	
	5570	10	79.6	18	1671.6	2	
	5570	11	91.4	10	1470.9	2	
	5570	12	71.7	14	1800.5	2	
	5570	13	55.5	7	1905.7	3	
	5570	14	60.5	18	1783.6	2	
	5570	15	73.7	16	1439.1	2	

Test Mode		802.11ax HE160					
Frequency		5570 MHz					
Radar Signal		Type 5					
Trial #	Test Frequency (MHz)	Burst#	Pulse Width (us)	Chirp Width (MHz)	PRI (us)	Number of Pulses / Burst	1=Detection ; 0=No Detection
19	5570	1	62.7	14	1855.6	1	1
	5570	2	71.7	10	1916.8	2	
	5570	3	87.4	12	1951.2	3	
	5570	4	88.7	15	1724.7	3	
	5570	5	91.9	6	1171.7	2	
	5570	6	89.9	14	1275.2	3	
	5570	7	88.9	7	1783.0	1	
	5570	8	65.9	5	1798.1	1	
	5570	9	60.8	13	1545.3	1	
	5570	10	58.5	9	1163.3	2	
	5570	11	71.0	9	1032.3	1	
	5570	12	78.4	11	1636.8	1	
	5570	13	53.7	13	1532.4	1	
	5570	14	70.4	10	1058.3	2	
20	5570	1	84.6	16	1308.4	1	1
	5570	2	67.5	14	1468.2	3	
	5570	3	93.8	16	1786.6	2	
	5570	4	73.6	17	1040.4	2	
	5570	5	69.5	20	1220.3	3	
	5570	6	55.2	12	1304.2	3	
	5570	7	65.6	13	1741.3	2	
	5570	8	93.1	15	1711.8	1	
	5570	9	62.3	19	1096.9	1	
	5570	10	74.7	12	1952.9	1	
21	5641	1	70.2	16	1287.2	3	1
	5644	2	78.5	7	1181.7	3	
	5643	3	71.4	10	1275.0	2	
	5641	4	92.2	14	1490.2	3	
	5643	5	57.6	9	1835.2	2	
	5643	6	94.5	9	1149.6	2	
	5640	7	63.4	18	1765.1	3	
	5644	8	99.6	7	1171.8	1	
	5639	9	72.9	19	1756.2	3	
	5645	10	83.3	5	1524.5	1	
	5641	11	50.6	14	1681.8	3	
	5640	12	71.3	17	1006.3	2	

Test Mode		802.11ax HE160					
Frequency		5570 MHz					
Radar Signal		Type 5					
Trial #	Test Frequency (MHz)	Burst#	Pulse Width (us)	Chirp Width (MHz)	PRI (us)	Number of Pulses / Burst	1=Detection ; 0=No Detection
22	5642	1	67.2	13	1211.6	3	0
	5639	2	67.3	19	1526.7	3	
	5645	3	61.3	6	1886.8	3	
	5641	4	65.8	16	1987.8	1	
	5643	5	73.9	9	1158.8	2	
	5642	6	57.7	12	1995.3	1	
	5643	7	53.5	9	1387.2	1	
	5641	8	82.8	15	1757.1	3	
	5639	9	93.0	19	1240.7	2	
23	5641	1	79.7	14	1686.1	3	0
	5639	2	51.0	19	1692.9	1	
	5639	3	60.6	19	1705.0	1	
	5643	4	59.6	10	1021.3	2	
	5642	5	67.0	13	1101.8	3	
	5643	6	95.2	10	1855.7	3	
	5641	7	93.2	14	1549.3	1	
	5643	8	58.5	9	1569.7	1	
	5641	9	52.2	16	1229.0	2	
	5643	10	50.4	9	1810.0	1	
	5641	11	81.8	15	1986.4	1	
	5640	12	64.2	18	1678.3	1	
	5639	13	78.2	19	1961.2	2	
	5642	14	99.1	12	1295.3	2	
	5645	15	54.3	6	1086.1	1	
24	5641	1	65.6	16	1945.0	1	1
	5645	2	94.9	6	1206.5	3	
	5643	3	67.6	10	1673.4	2	
	5645	4	78.4	5	1812.5	2	
	5643	5	59.4	11	1861.8	2	
	5643	6	71.9	9	1320.1	1	
	5643	7	50.3	10	1372.4	2	
	5643	8	88.0	11	1158.8	1	
	5644	9	50.7	8	1380.8	3	
	5641	10	89.6	14	1333.8	3	
	5639	11	87.7	19	1927.8	2	
	5640	12	73.2	18	1798.2	3	
	5645	13	93.0	6	1689.9	2	
	5641	14	76.7	16	1362.0	3	

Test Mode		802.11ax HE160					
Frequency		5570 MHz					
Radar Signal		Type 5					
Trial #	Test Frequency (MHz)	Burst#	Pulse Width (us)	Chirp Width (MHz)	PRI (us)	Number of Pulses / Burst	1=Detection ; 0=No Detection
25	5640	1	80.6	18	1154.9	1	1
	5642	2	66.1	12	1855.0	3	
	5640	3	71.1	17	1529.2	2	
	5640	4	50.4	18	1457.2	1	
	5642	5	60.5	13	1547.0	2	
	5643	6	76.7	9	1804.2	2	
	5641	7	73.8	16	1387.4	2	
	5644	8	54.0	8	1316.4	2	
	5645	9	72.3	6	1560.1	2	
	5643	10	69.3	11	1319.5	2	
	5641	11	77.1	16	1487.2	3	
	5643	12	52.5	9	1355.4	1	
	5639	13	81.5	19	1863.0	1	
	5644	14	77.9	7	1834.1	1	
	5642	15	57.0	12	1808.1	2	
	5641	16	96.9	14	1622.1	2	
	5643	17	99.2	10	1930.4	2	
	5642	18	50.5	12	1656.8	2	
26	5639	1	99.5	19	1420.3	1	1
	5644	2	99.9	8	1341.6	1	
	5643	3	79.9	11	1121.4	2	
	5640	4	78.0	17	1940.2	1	
	5642	5	75.4	12	1233.5	3	
	5643	6	55.9	9	1153.0	3	
	5644	7	98.7	7	1349.9	1	
	5639	8	77.5	19	1921.7	3	
	5645	9	68.1	5	1178.4	2	
	5641	10	78.0	15	1972.5	1	
	5642	11	88.3	13	1114.6	3	
	5640	12	79.8	17	1419.7	3	
	5644	13	71.5	8	1572.7	1	
	5642	14	51.4	12	1212.8	1	
	5640	15	70.0	18	1091.4	2	
	5644	16	69.5	7	1717.5	1	

Test Mode		802.11ax HE160					
Frequency		5570 MHz					
Radar Signal		Type 5					
Trial #	Test Frequency (MHz)	Burst#	Pulse Width (us)	Chirp Width (MHz)	PRI (us)	Number of Pulses / Burst	1=Detection ; 0=No Detection
27	5643	1	90.0	11	1936.3	1	1
	5639	2	76.0	20	1812.8	2	
	5640	3	76.6	17	1528.3	1	
	5642	4	61.8	13	1261.5	2	
	5644	5	87.0	8	1381.4	2	
	5643	6	54.7	11	1903.1	1	
	5640	7	61.3	18	1132.4	2	
	5644	8	51.3	7	1192.2	1	
	5645	9	79.6	6	1572.2	3	
	5643	10	95.9	9	1812.7	1	
	5642	11	84.1	12	1134.4	2	
	5643	12	60.8	10	1682.1	2	
	5644	13	97.7	7	1813.7	2	
	5641	14	71.9	16	1389.4	1	
	5644	15	59.4	7	1844.4	3	
	5641	16	54.5	14	1148.8	2	
	5642	17	82.1	12	1436.4	3	
	5641	18	68.2	14	1888.6	3	
	5641	19	77.6	16	1464.3	1	
	5643	20	89.5	10	1635.7	1	
28	5641	1	74.5	15	1985.1	2	0
	5643	2	70.4	9	1677.4	2	
	5642	3	65.0	13	1235.2	2	
	5643	4	93.8	10	1565.3	1	
	5644	5	98.9	7	1898.1	2	
	5642	6	74.5	12	1176.9	1	
	5644	7	81.7	8	1839.1	1	
	5642	8	89.2	12	1121.3	2	
	5643	9	60.5	9	1095.0	1	
	5644	10	66.8	7	1113.9	2	
	5643	11	65.9	11	1721.0	3	
	5643	12	65.2	9	1515.2	2	
	5643	13	82.6	11	1321.6	3	
	5643	14	53.6	10	1194.7	3	
	5644	15	62.3	7	1728.3	2	
	5645	16	50.4	6	1928.0	3	
	5643	17	78.4	11	1172.7	2	
	5639	18	84.3	19	1523.3	3	
	5641	19	61.2	14	1029.4	3	
	5643	20	90.0	11	1864.0	2	

Test Mode		802.11ax HE160					
Frequency		5570 MHz					
Radar Signal		Type 5					
Trial #	Test Frequency (MHz)	Burst#	Pulse Width (us)	Chirp Width (MHz)	PRI (us)	Number of Pulses / Burst	1=Detection ; 0=No Detection
29	5641	1	88.9	16	1142.2	1	1
	5644	2	69.0	8	1344.2	2	
	5641	3	56.1	14	1052.5	3	
	5640	4	70.8	18	1185.3	2	
	5643	5	64.5	9	1325.5	2	
	5643	6	73.3	10	1044.0	3	
	5644	7	92.7	7	1697.4	1	
	5643	8	86.4	11	1180.6	3	
	5640	9	91.3	17	1963.2	2	
	5641	10	94.7	16	1613.6	1	
	5642	11	95.7	13	1017.2	1	
	5644	12	94.8	8	1143.3	1	
	5644	13	82.3	7	1266.5	1	
	5641	14	57.6	14	1530.5	2	
	5641	15	76.5	16	1752.3	1	
	5645	16	76.2	5	1370.0	2	
	5643	17	96.6	11	1323.0	3	
30	5639	1	63.3	20	1627.9	1	1
	5643	2	89.6	10	1669.1	1	
	5644	3	91.1	8	1884.3	1	
	5641	4	78.1	16	1696.0	3	
	5642	5	61.3	12	1202.0	3	
	5642	6	55.3	13	1836.6	2	
	5641	7	95.7	15	1391.7	2	
	5644	8	66.6	7	1982.4	2	
	5643	9	94.1	11	1547.2	1	
	5639	10	77.7	20	1771.3	1	
	5641	11	86.8	14	1870.3	2	
	5642	12	94.4	13	1849.3	2	
	5642	13	66.1	12	1129.1	1	
	5643	14	67.2	11	1407.0	2	
Detection Percentage (%)							80.00

Test Mode		802.11ax HE160				
Frequency		5570 MHz				
Radar Signal		Type 6				
Trial #	Pulse Width (us)	PRI (us)	Pulses / Hop	Hopping Rate (kHz)	Hopping Sequence Length (ms)	1=Detection ; 0=No Detection
1	1	333	9	0.333	300	1
2	1	333	9	0.333	300	1
3	1	333	9	0.333	300	1
4	1	333	9	0.333	300	1
5	1	333	9	0.333	300	1
6	1	333	9	0.333	300	1
7	1	333	9	0.333	300	1
8	1	333	9	0.333	300	1
9	1	333	9	0.333	300	1
10	1	333	9	0.333	300	1
11	1	333	9	0.333	300	1
12	1	333	9	0.333	300	1
13	1	333	9	0.333	300	0
14	1	333	9	0.333	300	1
15	1	333	9	0.333	300	1
16	1	333	9	0.333	300	1
17	1	333	9	0.333	300	1
18	1	333	9	0.333	300	0
19	1	333	9	0.333	300	1
20	1	333	9	0.333	300	1
21	1	333	9	0.333	300	1
22	1	333	9	0.333	300	1
23	1	333	9	0.333	300	1
24	1	333	9	0.333	300	0
25	1	333	9	0.333	300	1
26	1	333	9	0.333	300	0
27	1	333	9	0.333	300	1
28	1	333	9	0.333	300	1
29	1	333	9	0.333	300	1
30	1	333	9	0.333	300	1
Detection Percentage (%)						86.67

Bridge Mode

Test Mode		802.11ax HE160					
Frequency (MHz)	Radar Signal	PRI (Msec)	Pulse width W (μs)	Pass Times	Fail Times	Probability	Limit
5570	Type1	Table 5a	1	28	2	93.33%	≥ 60 %

Test Mode		802.11ax HE160				
Frequency		5570 MHz				
Radar Signal		Type 1				
Trial #	Test Frequency (MHz)	Pulse Width (us)	PRI (us)	Number of Pluse	PRF (Hz)	1=Detection ; 0=No Detection
1	5570	1	878	61	1139	1
2	5570	1	3066	18	326	1
3	5570	1	3066	18	326	1
4	5570	1	938	57	1066	0
5	5570	1	618	86	1618	1
6	5570	1	738	72	1355	1
7	5570	1	798	67	1253	1
8	5570	1	718	74	1393	1
9	5570	1	898	59	1114	1
10	5570	1	738	72	1355	1
11	5570	1	3066	18	326	1
12	5570	1	518	102	1931	1
13	5570	1	758	70	1319	1
14	5570	1	578	92	1730	1
15	5570	1	718	74	1393	1
16	5570	1	2086	26	479	1
17	5570	1	879	61	1138	1
18	5570	1	828	64	1208	1
19	5570	1	776	69	1289	1
20	5570	1	1137	47	880	1
21	5570	1	2722	20	367	1
22	5570	1	2593	21	386	1
23	5570	1	1506	36	664	1
24	5570	1	683	78	1464	1
25	5570	1	2132	25	469	1
26	5570	1	2751	20	364	1
27	5570	1	2681	20	373	1
28	5570	1	2131	25	469	0
29	5570	1	2433	22	411	1
30	5570	1	2694	20	371	1
Detection Percentage (%)						93.33

---END---