

## RF Test Report

Applicant : Plume Design, Inc.  
Product Name : SuperPod with WiFi 6  
Trade Name : Plume Design, Inc.  
Model Number : F3A  
Applicable Standard : FCC 47 CFR PART 15 SUBPART C  
ANSI C63.10:2013  
Received Date : Mar. 02, 2022  
Test Period : Mar. 19 ~ Apr. 28 , 2022  
Issued Date : Jun. 17, 2022

### Issued by

A Test Lab Techno Corp.  
No. 140-1, Changan Street, Bade District,  
Taoyuan City 334025, Taiwan (R.O.C.)  
Tel : +886-3-2710188 / Fax : +886-3-2710190



Taiwan Accreditation Foundation accreditation number: 1330  
Frequency Range : 9 kHz to 40 GHz  
Test Firm MRA designation number: TW0010

#### **Note:**

1. The test results are valid only for samples provided by customers and under the test conditions described in this report.
2. This report shall not be reproduced except in full, without the written approval of A Test Lab Technology Corporation.
3. The relevant information is provided by customers in this test report. According to the correctness, appropriateness or completeness of the information provided by the customer, if there is any doubt or error in the information which affects the validity of the test results, the laboratory does not take the responsibility.

**Revision History**

Rev.	Issued Date	Revisions	Revised By
00	Jun. 17, 2022	Initial Issue	Emma Chao

## Verification of Compliance

Applicant : Plume Design, Inc.

Product Name : SuperPod with WiFi 6

Trade Name : Plume Design, Inc.

Model Number : F3A

FCC ID : 2AG7G-F3A

Applicable Standard : FCC 47 CFR PART 15 SUBPART C  
ANSI C63.10:2013

Test Result : Complied

Performing Lab. : A Test Lab Techno Corp.  
No. 140-1, Changan Street, Bade District,  
Taoyuan City 334025, Taiwan (R.O.C.)  
Tel : +886-3-2710188 / Fax : +886-3-2710190  
Taiwan Accreditation Foundation accreditation number: 1330



A Test Lab Techno Corp. tested the above equipment in accordance with the requirements set forth in the above standards. All indications of Pass/Fail in this report are opinions expressed by A Test Lab Techno Corp. based on interpretations and/or observations of test results. The test results show that the equipment tested is capable of demonstrating compliance with the requirements as documented in this report.

Approved By :

---

(Kai Yu Yang)

## TABLE OF CONTENTS

<b>1</b>	<b>General Information</b>	<b>5</b>
1.1.	Summary of Test Result	5
1.2.	Measurement Uncertainty	6
<b>2</b>	<b>EUT Description</b>	<b>7</b>
<b>3</b>	<b>Test Methodology</b>	<b>9</b>
3.1.	Mode of Operation	9
3.2.	EUT Test Step	17
3.3.	Configuration of Test System Details	18
3.4.	Test Instruments	19
3.5.	Test Site Environment	21
<b>4</b>	<b>Measurement Procedure</b>	<b>22</b>
4.1.	AC Power Line Conducted Emission Measurement	22
4.2.	Radiated Emission Measurement	24
4.3.	Maximum Conducted Output Power Measurement	28
4.4.	6 dB RF Bandwidth Measurement	29
4.5.	Maximum Power Spectral Density Measurement	30
4.6.	Out of Band Conducted Emissions Measurement	31
4.7.	Antenna Measurement	32
<b>5</b>	<b>Test Results</b>	<b>34</b>
5.1.	Conducted Emission	34
5.2.	Conducted Test Results	36
5.3.	Radiated Emission Measurement	110

### Appendix A. Test Setup Photographs

# 1 General Information

## 1.1. Summary of Test Result

Standard	Item	Result	Remark
15.207	AC Power Conducted Emission	PASS	----
15.247(d)	Transmitter Radiated Emissions	PASS	----
15.247(b)(3)	Max. Output Power	PASS	----
15.247(a)(2)	6 dB RF Bandwidth	PASS	----
15.247(e)	Maximum Power Spectral Density	PASS	----
15.247(d)	Out of Band Conducted Spurious Emission	PASS	----
15.203	Antenna Requirement	PASS	----

### Decision Rule

- Uncertainty is not included.
- Uncertainty is included.

Standard	Description
CFR47, Part 15, Subpart C	Intentional Radiators
ANSI C63. 10: 2013	American National Standard of Procedures for Compliance Testing of Unlicensed Wireless Devices
KDB 558074 D01 15.247 Meas Guidance v05r02	GUIDANCE FOR COMPLIANCE MEASUREMENTS ON DIGITAL TRANSMISSION SYSTEM, FREQUENCY HOPPING SPREAD SPECTRUM SYSTEM, AND HYBRID SYSTEM DEVICES OPERATING UNDER SECTION 15.247 OF THE FCC RULES
KDB 662911 D01 v02r01	Emissions Testing of Transmitters with Multiple Outputs in the Same Band (e.g., MIMO, Smart Antenna, etc)

## 1.2. Measurement Uncertainty

Test Item	Frequency Range	Uncertainty
Conducted Emission	150 kHz ~ 30 MHz	2.7 dB
Radiated Emission	9 kHz ~ 30 MHz	2.2 dB
	30 MHz ~ 1000 MHz	5.1 dB
	1000 MHz ~ 18000 MHz	5.2 dB
	18000 MHz ~ 26500 MHz	4.6 dB
	26500 MHz ~ 40000 MHz	4.6 dB
Conducted Output Power	1.1 dB	
RF Bandwidth	4.7 %	
Power Spectral Density	1.1 dB	

## 2 EUT Description

Applicant	Plume Design, Inc. 325 Lytton Ave., Palo Alto, CA 94301			
Product Name	SuperPod with WiFi 6			
Trade Name	Plume Design, Inc.			
Model Number	F3A			
FCC ID	2AG7G-F3A			
Operate Freq. Band	Frequency Range (MHz)	Modulation	Channel Bandwidth	Data Rate 400 / 800 GI (ns)
IEEE 802.11b	2412 ~ 2462	DSSS	20 MHz	Up to 11 Mbps
IEEE 802.11g	2412 ~ 2462	OFDM	20 MHz	Up to 54 Mbps
IEEE 802.11n 2.4 GHz 20 MHz	2412 ~ 2462	OFDM(64QAM)	20 MHz	Up to 144.4 Mbps
IEEE 802.11n 2.4 GHz 40 MHz	2422 ~ 2452	OFDM(64QAM)	40 MHz	Up to 300 Mbps
IEEE 802.11n 2.4 GHz 20 MHz	2412 ~ 2462	OFDM(256QAM)	20 MHz	Up to 173.3 Mbps
IEEE 802.11n 2.4 GHz 40 MHz	2422 ~ 2452	OFDM(256QAM)	40 MHz	Up to 400 Mbps
IEEE 802.11ax 2.4 GHz 20 MHz	2412 ~ 2462	OFDMA	20 MHz	MCS11
IEEE 802.11ax 2.4 GHz 40 MHz	2422 ~ 2452	OFDMA	40 MHz	MCS11
Antenna information	ANT		Type	Max. Gain (dBi)
	ANT-0	2G1	PIFA Antenna	2.5
	ANT-1	2G2	PIFA Antenna	3.1
Antenna Delivery	See section 3.1			
Operate Temp. Range	-30 ~ +50 °C			
EUT Power Rating	100-240 V, 50-60 Hz, 0.45 A			

## 1X1

Frequency Band	Max. RF Output Power (W)
IEEE 802.11b	0.258
IEEE 802.11g	0.260
IEEE 802.11n 2.4 GHz 20 MHz(64QAM)	0.250
IEEE 802.11n 2.4 GHz 40 MHz(64QAM)	0.108
IEEE 802.11n 2.4 GHz 20 MHz(256QAM)	0.254
IEEE 802.11n 2.4 GHz 40 MHz(256QAM)	0.111
IEEE 802.11ax 2.4 GHz 20 MHz	0.260
IEEE 802.11ax 2.4 GHz 40 MHz	0.112

## 2X2

Frequency Band	Max. RF Output Power (W)
IEEE 802.11b	0.546
IEEE 802.11g	0.507
IEEE 802.11n 2.4 GHz 20 MHz(64QAM)	0.524
IEEE 802.11n 2.4 GHz 40 MHz(64QAM)	0.211
IEEE 802.11n 2.4 GHz 20 MHz(256QAM)	0.533
IEEE 802.11n 2.4 GHz 40 MHz(256QAM)	0.215
IEEE 802.11ax 2.4 GHz 20 MHz	0.541
IEEE 802.11ax 2.4 GHz 40 MHz	0.218

## Beamforming on

Frequency Band	Max. RF Output Power (W)
IEEE 802.11n 2.4 GHz 20 MHz(64QAM)	0.258
IEEE 802.11n 2.4 GHz 40 MHz(64QAM)	0.103
IEEE 802.11n 2.4 GHz 20 MHz(256QAM)	0.260
IEEE 802.11n 2.4 GHz 40 MHz(256QAM)	0.106
IEEE 802.11ax 2.4 GHz 20 MHz	0.262
IEEE 802.11ax 2.4 GHz 40 MHz	0.108



### 3 Test Methodology

#### 3.1. Mode of Operation

Decision of Test ATL has verified the construction and function in typical operation. All the test modes were carried out with the EUT in normal operation, which was shown in this test report and defined as:

Pre-Test Mode
Mode 1: Transmit mode
Mode 2: IEEE 802.11b Continuous TX mode
Mode 3: IEEE 802.11g Continuous TX mode
Mode 4: IEEE 802.11n 2.4 GHz 20 MHz(64QAM) Continuous TX Mode
Mode 5: IEEE 802.11n 2.4 GHz 40 MHz(64QAM) Continuous TX Mode
Mode 6: IEEE 802.11n 2.4 GHz 20 MHz(256QAM) Continuous TX Mode
Mode 7: IEEE 802.11n 2.4 GHz 40 MHz(256QAM) Continuous TX Mode
Mode 8: IEEE 802.11ax 2.4 GHz 20 MHz Continuous TX Mode
Mode 9: IEEE 802.11ax 2.4 GHz 40 MHz Continuous TX Mode

Final-Test Mode
Mode 1: Transmit mode
Mode 2: IEEE 802.11b Continuous TX mode
Mode 3: IEEE 802.11g Continuous TX mode
Mode 8: IEEE 802.11ax 2.4 GHz 20 MHz Continuous TX Mode
Mode 9: IEEE 802.11ax 2.4 GHz 40 MHz Continuous TX Mode

Software used to control the EUT for staying in continuous transmitting mode was programmed.

After verification, all tests were carried out with the worst case test modes.

By preliminary testing and verifying three axis (X, Y and Z) position of EUT transmitted status, it was found that “Y axis” position was the worst, then the final test was executed the worst condition and test data were recorded in this report.

Note 1: This product supports normal mode and Beamforming on mode. According to power table, the normal mode is worst power. So, normal mode has to test and record results for Conducted.

Note 2: Investigation has been done on all the possible configurations for searching the worst cases (2.4 GHz HE20/HE40 covers 64QAM/256QAM). The table is a list of the test modes show in this test report.

Note 3: IEEE 802.11ax test results only support Full RU ◦

1X1

Test Mode	ANT-0
Mode 2	V
Mode 3	V
Mode 4	V
Mode 5	V
Mode 6	V
Mode 7	V
Mode 8	V
Mode 9	V

Test Mode	Antenna Delivery	Data Rate (Mbps)	Test Channel
Mode 2	1TX	1	1, 6, 11
Mode 3	1TX	6	1, 6, 11
Mode 4	1TX	6.5	1, 6, 11
Mode 5	1TX	13.5	3, 6, 9
Mode 6	1TX	6.5	1, 6, 11
Mode 7	1TX	13.5	3, 6, 9
Mode 8	1TX	MCS0	1, 6, 11
Mode 9	1TX	MCS0	3, 6, 9

2X2
-----

Test Mode	ANT-0	ANT-1	ANT-0+1
Mode 2	V	V	V
Mode 3	V	V	V
Mode 4	V	V	V
Mode 5	V	V	V
Mode 6	V	V	V
Mode 7	V	V	V
Mode 8	V	V	V
Mode 9	V	V	V

Test Mode	Antenna Delivery	Data Rate (Mbps)	Test Channel
Mode 2	2TX (CDD)	1	1, 6, 11
Mode 3	2TX (CDD)	6	1, 6, 11
Mode 4	2TX (CDD)	13	1, 6, 11
Mode 5	2TX (CDD)	27	3, 6, 9
Mode 6	2TX (CDD)	13	1, 6, 11
Mode 7	2TX (CDD)	27	3, 6, 9
Mode 8	2TX (CDD)	MCS0	1, 6, 11
Mode 9	2TX (CDD)	MCS0	3, 6, 9

1X1

**Duty cycle**

Test Mode	Frequency (MHz)	on time (ms)	on+off time (ms)	Duty cycle	Duty Factor (dB)	1/T Minimum VBW (kHz)
Mode 2	2412	8.520	9.090	0.937	0.281	0.117
Mode 3	2412	0.133	0.234	0.569	2.447	7.508
Mode 8	2412	0.323	0.348	0.928	0.326	3.098
Mode 9	2422	0.312	0.338	0.923	0.348	3.205

2X2

**Duty cycle**

Test Mode	Frequency (MHz)	on time (ms)	on+off time (ms)	Duty cycle	Duty Factor (dB)	1/T Minimum VBW (kHz)
Mode 2	2412	8.520	9.060	0.940	0.267	0.117
Mode 3	2412	0.136	0.236	0.574	2.414	7.375
Mode 8	2412	0.322	0.347	0.926	0.333	3.109
Mode 9	2422	0.309	0.337	0.917	0.377	3.236

1X1

Duty Cycle Graphs

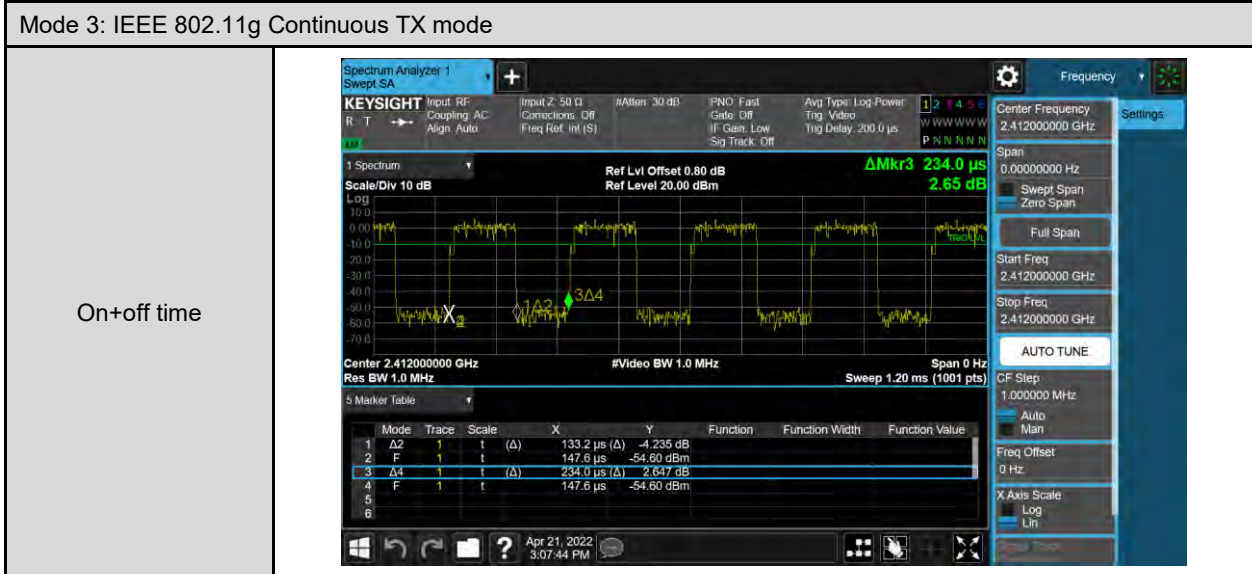
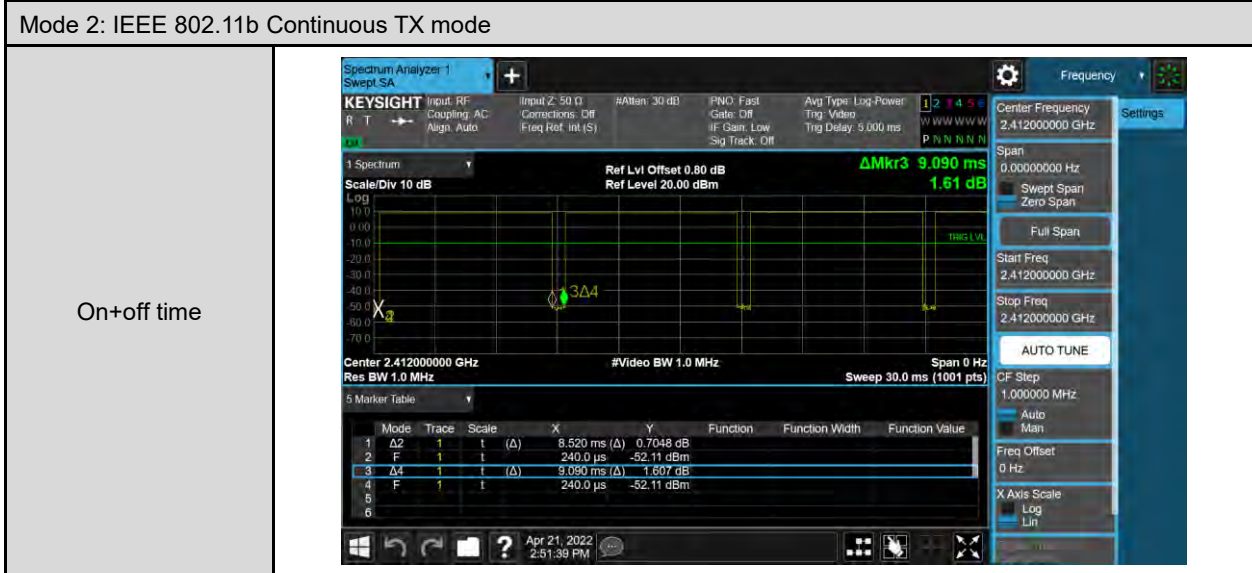

Mode 8: IEEE 802.11ax 2.4 GHz 20 MHz Continuous TX Mode

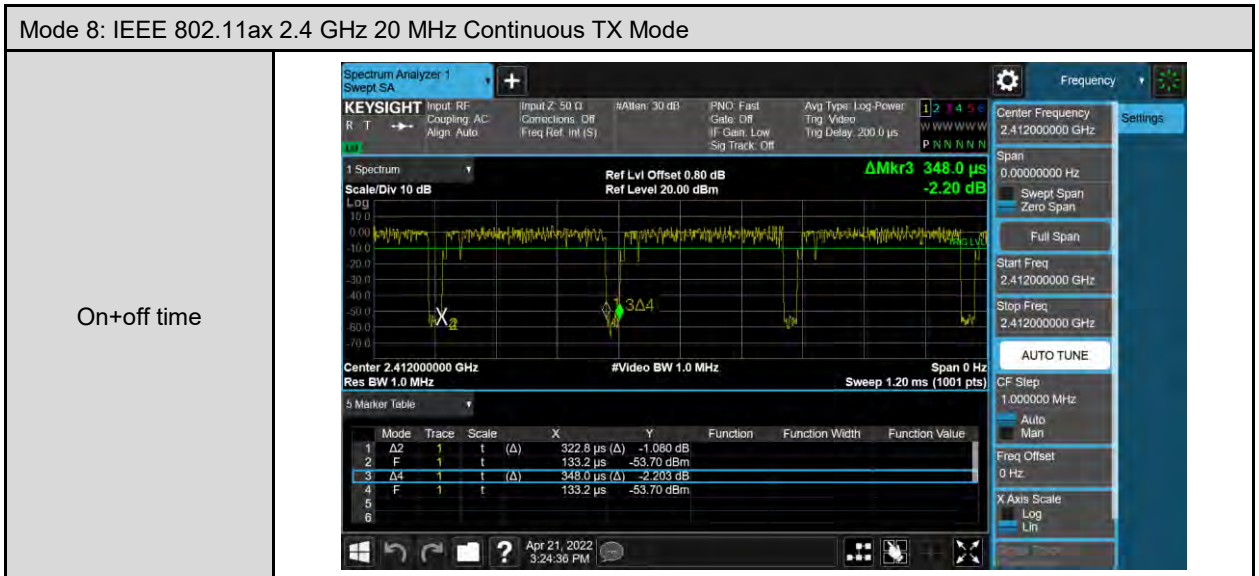

Mode 9: IEEE 802.11ax 2.4 GHz 40 MHz Continuous TX Mode

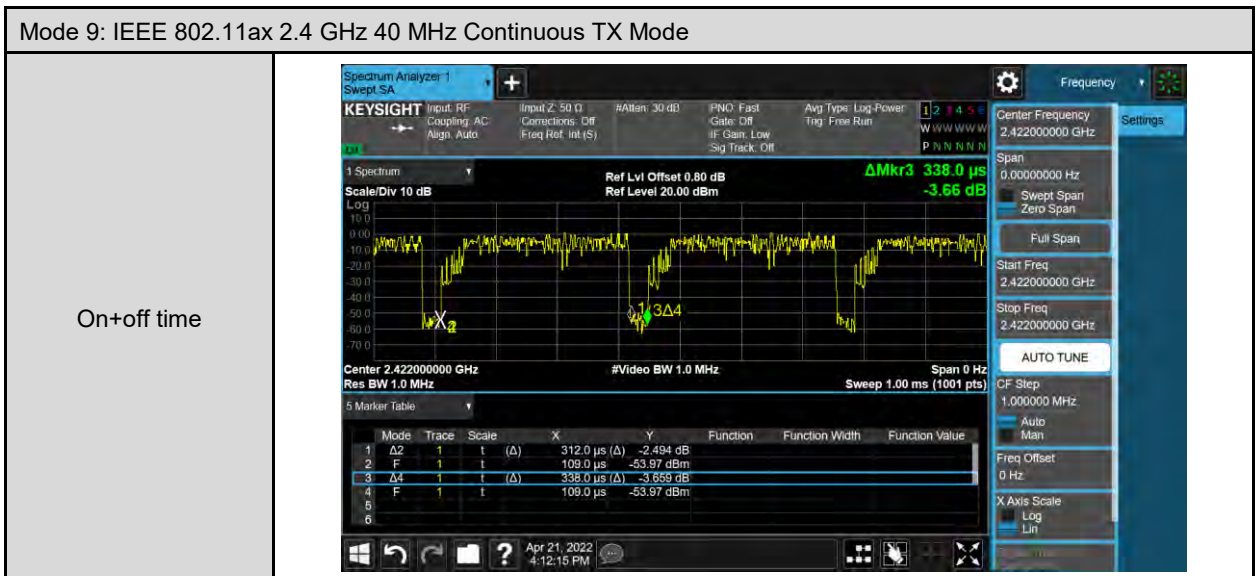

2X2

Duty Cycle Graphs

Mode 2: IEEE 802.11b Continuous TX mode

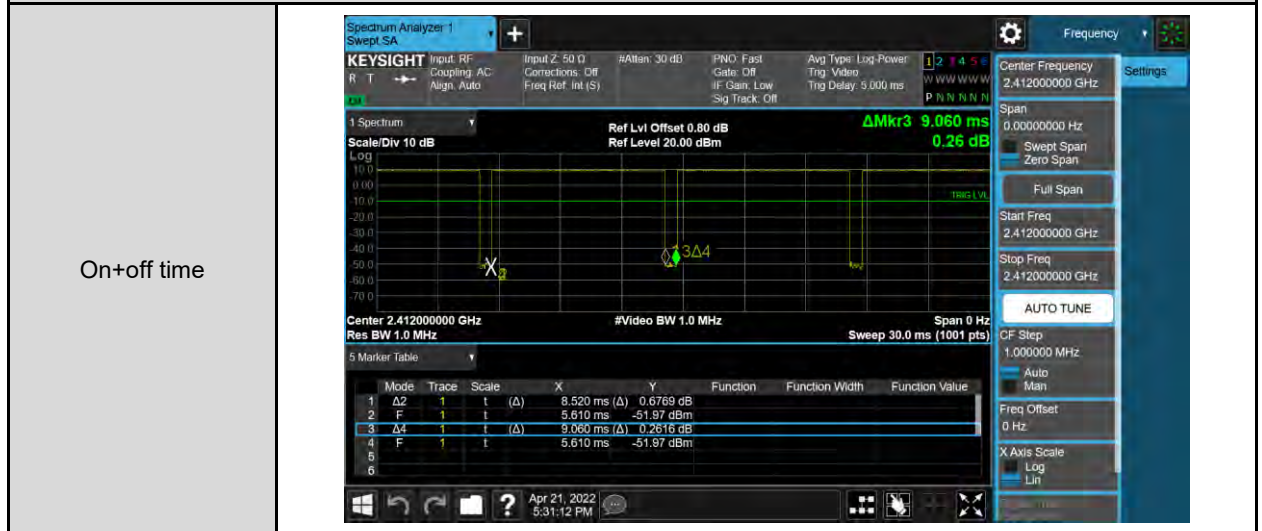

Mode 3: IEEE 802.11g Continuous TX mode

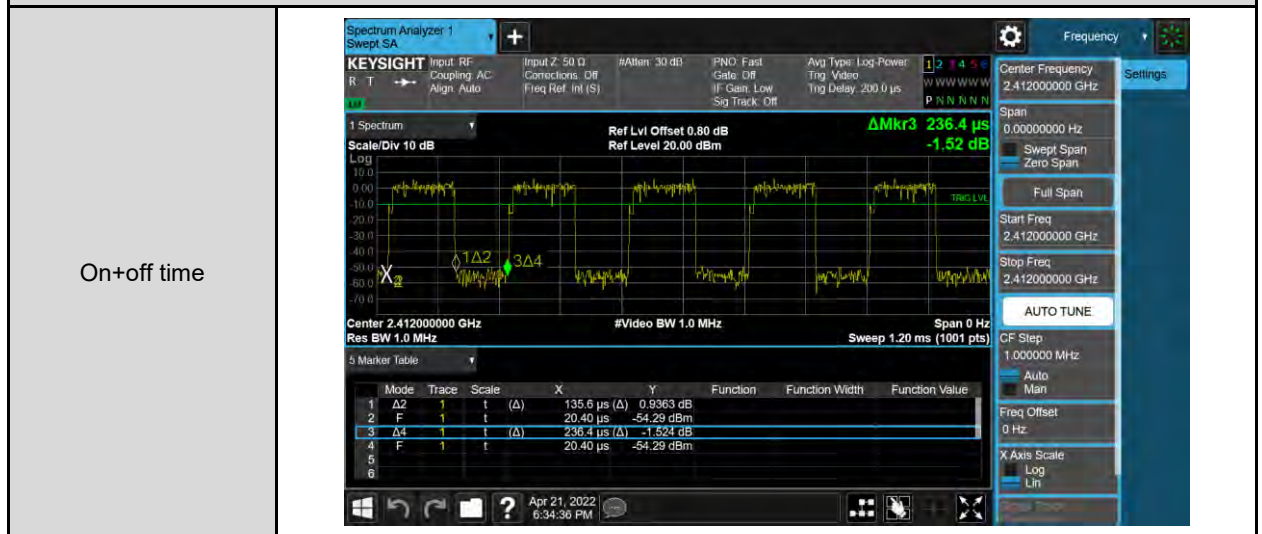

Mode 8: IEEE 802.11ax 2.4 GHz 20 MHz Continuous TX Mode

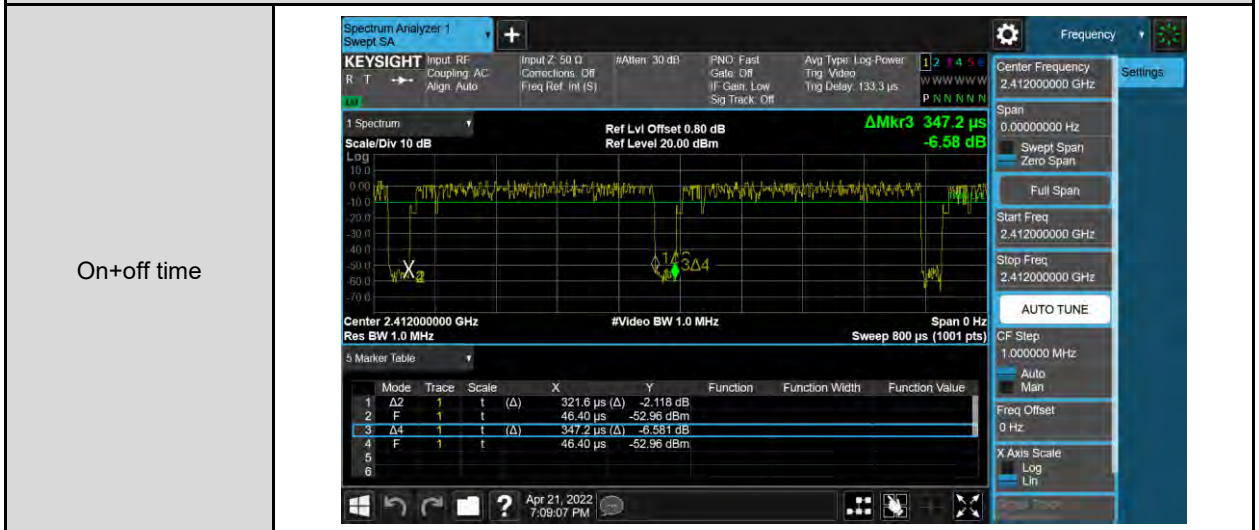

Mode 9: IEEE 802.11ax 2.4 GHz 40 MHz Continuous TX Mode

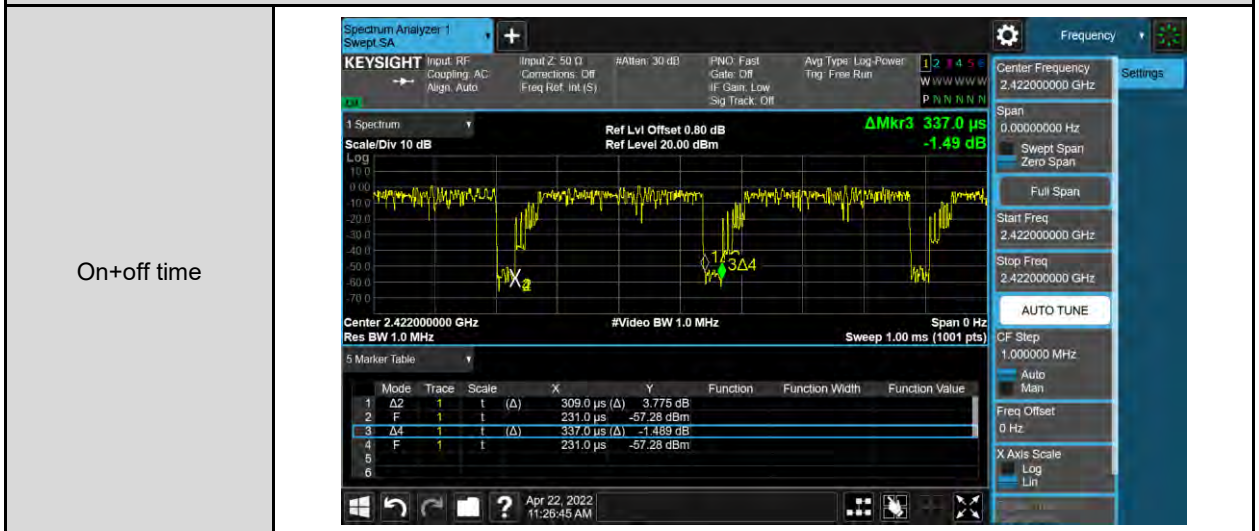



### 3.2. EUT Test Step

1.	Setup the EUT shown on "Configuration of Test System Details".
2.	Turn on the power of all equipment.
3.	Turn on TX function.
4.	EUT run test program.

### 3.3. Configuration of Test System Details

#### Conducted Emissions

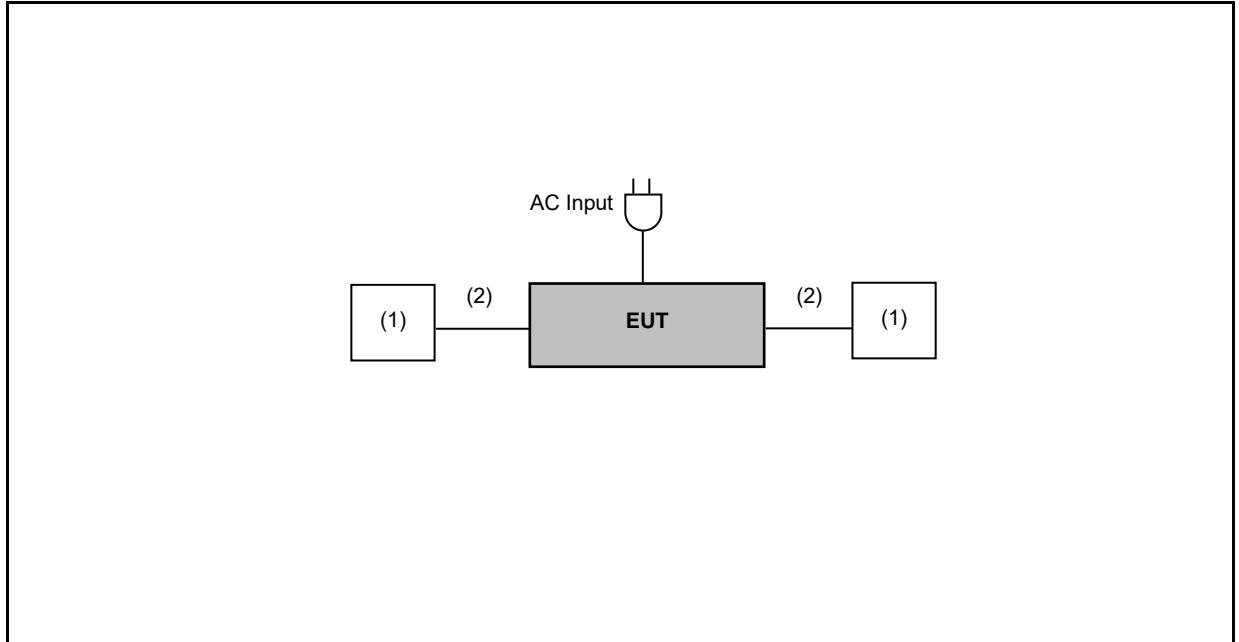

#### Radiated Emission

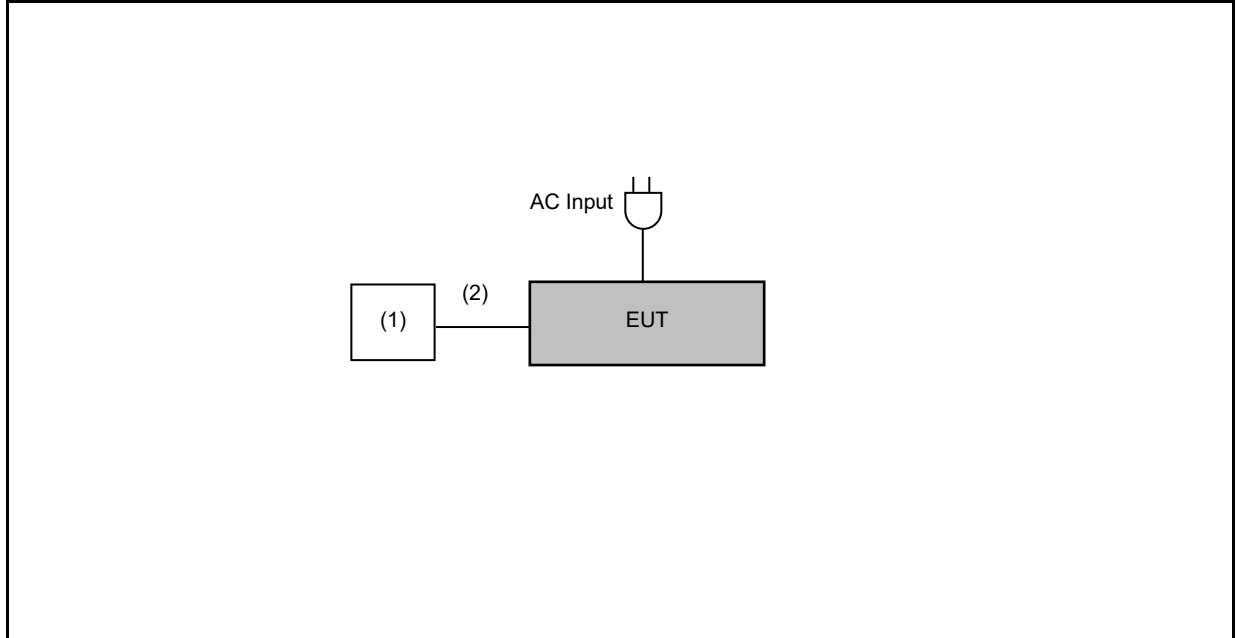

	Product	Manufacturer	Model Number	Serial Number	Power Cord
(1)	Notebook	acer	N19C1	---	---
(2)	RJ45	---	---	---	---

### 3.4. Test Instruments

For Conducted Emission

Test Period: Mar. 19, 2022

Testing Engineer: Chi Chung

Use	Equipment	Manufacturer	Model Number	Serial Number	Cal. Date	Cal. Period
<input checked="" type="checkbox"/>	Test Receiver	R&S	ESCI	100367	May 21, 2021	1 year
<input type="checkbox"/>	Test Receiver	R&S	ESCI	100722	Nov. 02, 2021	1 year
<input type="checkbox"/>	Test Receiver	R&S	ESCI	101000	Nov. 26, 2021	1 year
<input checked="" type="checkbox"/>	LISN	R&S	ENV216	101040	Mar. 29, 2021	1 year
<input checked="" type="checkbox"/>	LISN	R&S	ENV216	101041	Apr. 08, 2021	1 year
<input checked="" type="checkbox"/>	RF Cable	Woken	00100D1380194M	TE-02-03	May 28, 2021	1 year
<input checked="" type="checkbox"/>	Software	EZ EMC	1.1.4.3	N/A	N.C.R.	---

For Conducted

Test Period: Mar. 25 ~ Apr. 28, 2022

Testing Engineer: Brian Lin

Use	Equipment	Manufacturer	Model Number	Serial Number	Cal. Date	Cal. Period
<input checked="" type="checkbox"/>	Power Sensor	Anritsu	MA2411B	1126022	Sep. 03, 2021	1 year
<input checked="" type="checkbox"/>	Power Meter	Anritsu	ML2495A	1135009	Sep. 03, 2021	1 year
<input type="checkbox"/>	Power Sensor	Agilent	N1921A	MY45241957	Dec. 06, 2021	1 year
<input type="checkbox"/>	Power Meter	Agilent	N1911A	MY45101619	Dec. 06, 2021	1 year
<input type="checkbox"/>	Spectrum Analyzer (10 Hz~26.5 GHz)	Keysight	N9010B	MY59071418	Mar. 16, 2022	1 year
<input checked="" type="checkbox"/>	Spectrum Analyzer (9 kHz~26.5 GHz)	Agilent	N9010A	MY48030518	Jul. 23, 2021	1 year
<input type="checkbox"/>	Spectrum Analyzer (20 Hz~26.5 GHz)	Agilent	N9020A	US47520902	Sep. 09, 2021	1 year
<input type="checkbox"/>	Spectrum Analyzer (3 Hz~50 GHz)	Agilent	N9030A	MY53120541	Jan. 05, 2022	1 year
<input type="checkbox"/>	Temperature & Humidity Chamber	TAICHY	MHU-225LA	980729	Mar. 30, 2021 Mar. 28, 2022	1 year
<input type="checkbox"/>	Signal Generator	Keysight	N5182B	MY53052569	Apr. 20, 2021 Apr. 16, 2022	1 year
<input type="checkbox"/>	Signal Generator	Keysight	N5182BX07	MY59360221	Apr. 20, 2021 Apr. 16, 2022	1 year
<input type="checkbox"/>	Bluetooth Tester	R&S	CBT	100350	Mar. 17, 2021	2 years
<input type="checkbox"/>	Wireless Connectivity Tester	R&S	CMW270	102208	Jun. 02, 2021	1 year
<input type="checkbox"/>	Power Supply	KEITHLEY	2303	4045290	Jan. 19, 2022	1 year

Note: N.C.R. = No Calibration Request.

For Radiated Emissions

Test Period: Mar. 23 ~ Apr. 15, 2022

Testing Engineer: Marc Yeh, Hung Chou, Eason Lee

Radiation test sites		Semi Anechoic Room				
Use	Equipment	Manufacturer	Model Number	Serial Number	Cal. Date	Cal. Period
<input type="checkbox"/>	Spectrum Analyzer (10 Hz~44 GHz)	Keysight	N9010A	MY52221312	Jan. 13, 2022	1 year
<input type="checkbox"/>	Spectrum Analyzer (3 Hz~50 GHz)	Agilent	N9030A	MY53120541	Jan. 05, 2022	1 year
<input checked="" type="checkbox"/>	Spectrum Analyzer (2 Hz~50 GHz)	Keysight	N9030B	MY57143537	Apr. 19, 2021	1 year
<input checked="" type="checkbox"/>	Amplifier (100 kHz~1.3 GHz)	Agilent	8447D	2944A11119	Jan. 14, 2022	1 year
<input type="checkbox"/>	Amplifier (100 kHz~1.3 GHz)	Agilent	8447D	2944A10961	Jul. 06, 2021	1 year
<input type="checkbox"/>	Broadband Amplifier (100 kHz~1 GHz)	Titan	T0910E00014330A1F	001	Jul. 23, 2021	1 year
<input type="checkbox"/>	Amplifier (1 GHz~26.5 GHz)	Agilent	8449B	3008A02237	Oct. 21, 2021	1 year
<input checked="" type="checkbox"/>	Broadband Amplifier (1 GHz~26.5 GHz)	Titan	T0912E01263025A1F	002	Jul. 26, 2021	1 year
<input type="checkbox"/>	Preamplifier (26.5 GHz~40 GHz)	EMCI	EMC2654045	980028	Aug. 19, 2021	1 year
<input checked="" type="checkbox"/>	Loop Antenna (9 kHz~30 MHz)	COM-POWER CORPORATION	AL-130	121014	Mar. 28, 2022	1 year
<input checked="" type="checkbox"/>	Trilog Broadband Antenna (30 kHz~1 GHz)	Schwarzbeck Mess-Elektronik	VULB9168	01146	Jul. 19, 2021	1 year
<input type="checkbox"/>	Trilog Broadband Antenna (30 kHz~1 GHz)	Schwarzbeck Mess-Elektronik	VULB9168	416	Nov. 17, 2021	1 year
<input checked="" type="checkbox"/>	Broadband Horn Antenna (1 GHz~18 GHz)	Schwarzbeck Mess-Elektronik	9120D	02207	Jul. 09, 2021	1 year
<input type="checkbox"/>	Broadband Horn Antenna (1 GHz~18 GHz)	Schwarzbeck Mess-Elektronik	9120D	9120D-550	Aug. 24, 2021	1 year
<input checked="" type="checkbox"/>	Broadband Horn Antenna (18 GHz~40 GHz)	Schwarzbeck Mess-Elektronik	9170	9170-320	Aug. 24, 2021	1 year
<input type="checkbox"/>	Horn Antenna (18 GHz~40 GHz)	ETS	3116	00086467	Dec. 03, 2021	1 year
<input type="checkbox"/>	RF Cable	EMCI	EMC104-N-N-6000	TE01-1	Feb. 18, 2022	1 year
<input type="checkbox"/>	Microwave Cable	EMCI	EMC104-SM-SM-13000	170814	Feb. 18, 2022	1 year
<input type="checkbox"/>	Microwave Cable	EMCI	EMC102-KM-KM-14000	151001	Feb. 18, 2022	1 year
<input checked="" type="checkbox"/>	Coaxial Cable	Titan	T0710AT327A10A100	J11005	Aug. 06, 2021	1 year
<input checked="" type="checkbox"/>	Coaxial Cable	Titan	T0710AT327A10A900	J11004	Aug. 06, 2021	1 year
<input checked="" type="checkbox"/>	Coaxial Cable	Titan	CFD400NL-LW	001	Aug. 06, 2021	1 year
<input type="checkbox"/>	Bluetooth Tester	R&S	CBT	100350	Mar. 17, 2021	2 years
<input type="checkbox"/>	Wireless Connectivity Tester	R&S	CMW270	102208	Jun. 02, 2021	1 year
<input type="checkbox"/>	Power Supply	KEITHLEY	2303	4045290	Jan. 19, 2022	1 year
<input checked="" type="checkbox"/>	Software	EZ EMC	1.1.4.4	N/A	N.C.R.	---

Note: N.C.R. = No Calibration Request.

### 3.5. Test Site Environment

Items	Required (IEC 60068-1)	Actual
Temperature (°C)	15-35	20-30
Humidity (%RH)	25-75	45-75

## 4 Measurement Procedure

### 4.1. AC Power Line Conducted Emission Measurement

#### ■ Limit

Frequency (MHz)	Quasi-peak	Average
0.15 - 0.5	66 to 56	56 to 46
0.50 - 5.0	56	46
5.0 - 30.0	60	50

#### ■ Test Setup

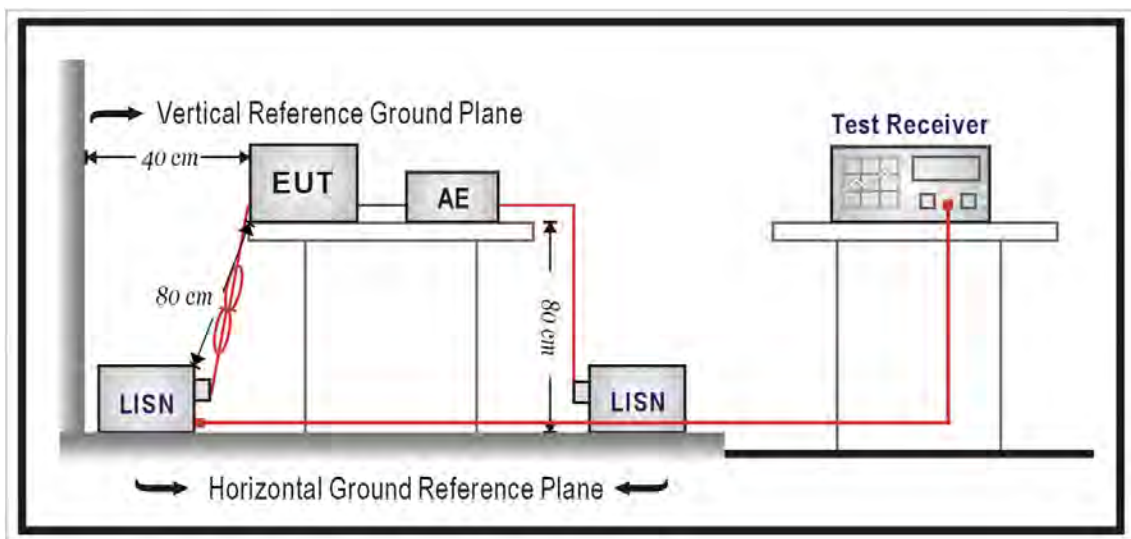

#### ■ Test Procedure

The EUT and simulators are connected to the main power through a line impedance stabilization network (L.I.S.N.). This provides a  $50 \Omega // 50 \mu\text{H}$  coupling impedance for the measuring equipment. The peripheral devices are also connected to the main power through a LISN that provides a  $50 \Omega // 50 \mu\text{H}$  coupling impedance with 50 ohm termination.

Tabletop device shall be placed on a non-conducting platform, of nominal size 1 m by 1.5 m, raised 80 cm above the reference ground plane. The wall of screened room shall be located 40 cm to the rear of the EUT. Other surfaces of tabletop or floor standing EUT shall be at least 80 cm from any other ground conducting surface including one or more LISNs. For floor-standing device shall be placed under the EUT with a 12 mm insulating material.

Conducted emissions were investigated over the frequency range from 0.15 MHz to 30 MHz using a resolution bandwidth of 9 kHz. The equipment under test (EUT) shall be meet the limits in section 4.1, as applicable, including the average limit and the quasi-peak limit when using respectively, an average detector and quasi-peak detector measured in accordance with the methods described of related standard. When all of peak value were complied with quasi-peak and average limit from 150 kHz to 30 MHz then quasi-peak and average measurement was unnecessary.

The AMN shall be placed 0.8 m from the boundary of the unit under test and bonded to a ground reference plane for AMNs mounted on top of the ground reference plane. This distance is between the closest points of the AMN and the EUT. All other units of the EUT and associated equipment shall be at least 0.8 m from the AMN. If the mains power cable is longer than 1 m then the cable shall be folded back and forth at the centre of the lead to form a bundle no longer than 0.4 m. All of interconnecting cables that hang closer than 40 cm to the ground plane shall be folded back and forth in the center forming a bundle 30 cm to 40 cm long. All of EUT and AE shall be separate place more than 0.1 m. All  $50 \Omega$  ports of the LISN shall be resistively terminated into  $50 \Omega$  loads when not connected to the measuring instrument.

If the reading of the measuring receiver shows fluctuations close to the limit, the reading shall be observed for at least 15 s at each measurement frequency; the higher reading shall be recorded with the exception of any brief isolated high reading which shall be ignored.

## 4.2. Radiated Emission Measurement

### ■ Limit

According to §15.209(a), except as provided elsewhere in this subpart, the emissions from an intentional radiator shall not exceed the field strength levels specified in the following table:

Frequency (MHz)	Field Strength ( $\mu\text{V}/\text{m}$ at meter)	Measurement Distance (meters)
0.009 – 0.490	$2400 / F$ (kHz)	300
0.490 – 1.705	$24000 / F$ (kHz)	30
1.705 – 30.0	30	30
30 - 88	100**	3
88-216	150**	3
216-960	200**	3
Above 960	500	3

\*\* Except as provided in paragraph (g), fundamental emissions from intentional radiators operating under this Section shall not be located in the frequency bands 54-72 MHz, 76-88 MHz, 174-216 MHz or 470-806 MHz. However, operation within these frequency bands is permitted under other sections of this Part, e.g., Sections 15.231 and 15.241.

### ■ Setup

9 kHz ~ 30 MHz

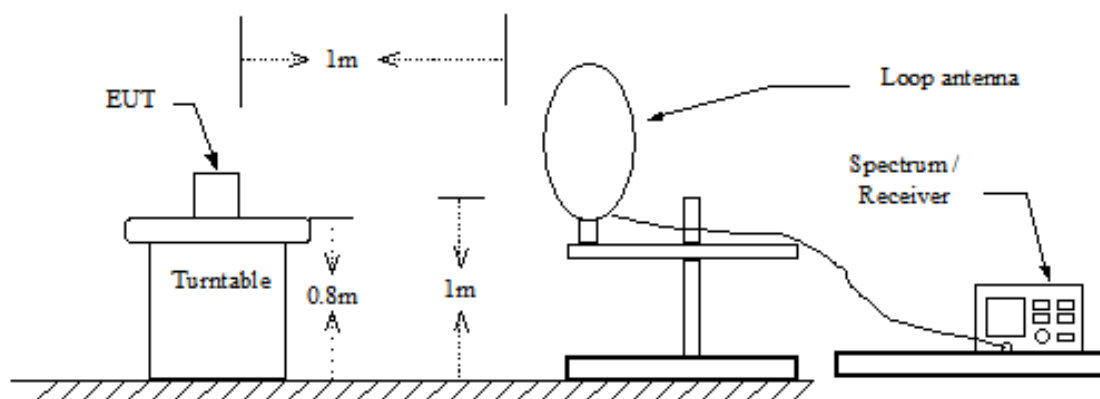



Below 1 GHz

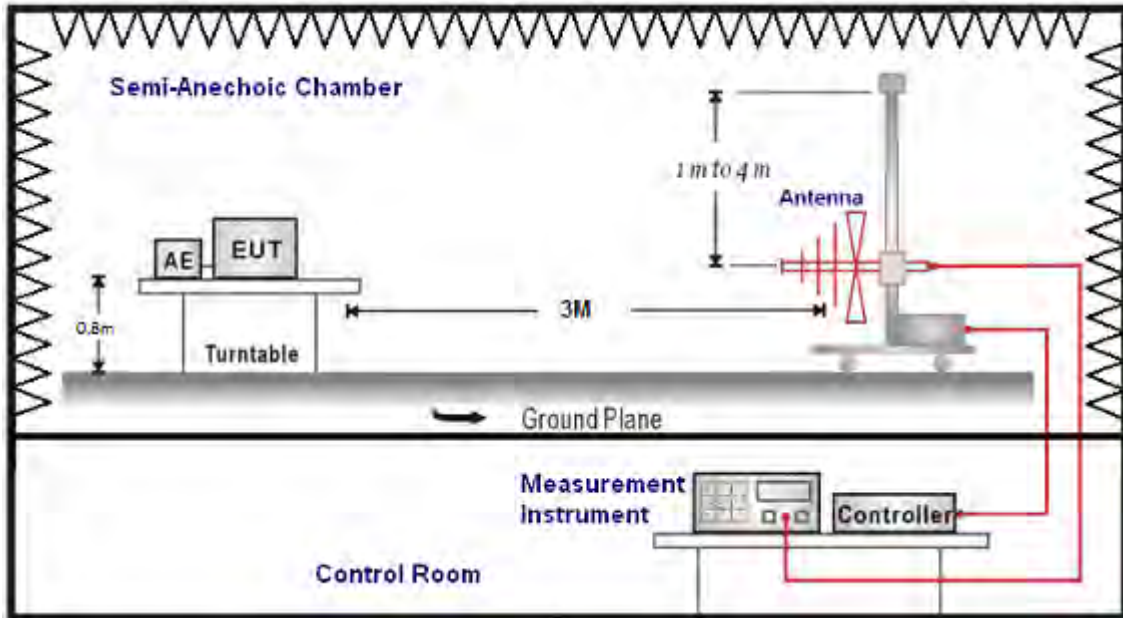

Above 1 GHz

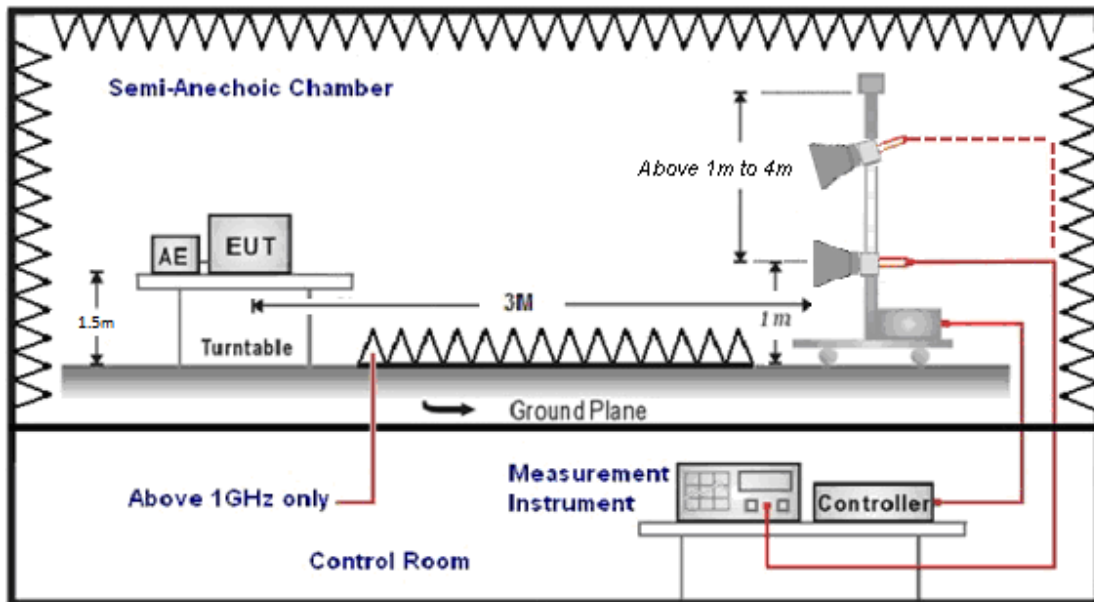

### ■ Test Procedure

Final radiation measurements were made on a three-meter, Semi Anechoic Chamber. The EUT system was placed on a nonconductive turntable which is 0.8 or 1.5 meters height, top surface 1.0 x 1.5 meter. The spectrum was examined from 250 MHz to 2.5 GHz in order to cover the whole spectrum below 10th harmonic which could generate from the EUT. During the test, EUT was set to transmit continuously & Measurements spectrum range from 9 kHz to 26.5 GHz is investigated.

For measurements below 1 GHz the resolution bandwidth is set to 100 kHz for peak detection measurements or 120 kHz for quasi-peak detection measurements. Peak detection is used unless otherwise noted as quasi-peak.

For measurements above 1 GHz the resolution bandwidth is set to 1 MHz, and then the video bandwidth is set to 3 MHz for peak measurements and 10 Hz for average measurements when Duty cycle  $>0.98$  /  $1/T$  for average measurements when Duty cycle  $<0.98$ . A nonconductive material surrounded the EUT to supporting the EUT for standing on three orthogonal planes. At each condition, the EUT was rotated 360 degrees, and the antenna was raised and lowered from one to four meters to find the maximum emission levels. Measurements were taken using both horizontal and vertical antenna polarization.

SCHWARZBECK MESS-ELEKTRONIK Biconilog Antenna at 3 Meter and the SCHWARZBECK Double Ridged Guide Antenna was used in frequencies 1 –26.5 GHz at a distance of 3 meter. The antenna at an angle toward the source of the emission. All test results were extrapolated to equivalent signal at 3 meters utilizing an inverse linear distance extrapolation Factor (20 dB/decade).

For testing above 1 GHz, the emission level of the EUT in peak mode was 20 dB lower than average limit (that means the emission level in peak mode also complies with the limit in average mode), then testing will be stopped and peak values of EUT will be reported, otherwise, the emissions will be measured in average mode again and reported.

Appropriate preamplifiers were used for improving sensitivity and precautions were taken to avoid overloading or desensitizing the spectrum analyzer. No post – detector video filters were used in the test.

The spectrum analyzer's 6 dB bandwidth was set to 1 MHz, and the analyzer was operated in the peak detection mode, for frequencies both below and up 1 GHz. The average levels were obtained by subtracting the duty cycle correction factor from the peak readings.

The following procedures were used to convert the emission levels measured in decibels referenced to 1 microvolt (dBuV) into field intensity in micro volts pre meter (uV/m).

The actual field intensity in decibels referenced to 1 microvolt in to field intensity in micro volts per meter (dBuV/m).

The actual field intensity in referenced to 1 microvolt per meter (dBuV/m) is determined by algebraically adding the measured reading in dBuV, the antenna factor (dB), and cable loss (dB) and Subtracting the gain of preamplifier (dB) is auto calculate in spectrum analyzer.

$$(1) \text{ Amplitude (dBuV/m) = FI (dBuV) +AF (dBuV) +CL (dBuV)-Gain (dB)}$$

FI= Reading of the field intensity.

AF= Antenna factor.

CL= Cable loss.

P.S Amplitude is auto calculate in spectrum analyzer.

$$(2) \text{ Actual Amplitude (dBuV/m) = Amplitude (dBuV)-Dis(dB)}$$

The FCC specified emission limits were calculated according the EUT operating frequency and by following linear interpolation equations:

(a) For fundamental frequency : Transmitter Output < +30 dBm

(b) For spurious frequency : Spurious emission limits = fundamental emission limit /10

Data of measurement within this frequency range without mark in the table above means the reading of emissions are attenuated more than 20 dB below the permissible limits or the field strength is too small to be measured.

### 4.3. Maximum Conducted Output Power Measurement

#### ■ Limit

For systems using digital modulation in the 2400-2483.5 MHz, the limit for maximum output power is 30 dBm.

And According to 15.247 (b), if transmitting antennas of directional gain greater than 6 dBi are used, the power shall be reduced by the amount in dB that the directional gain of the antenna exceeds 6 dBi.

#### ■ Test Setup

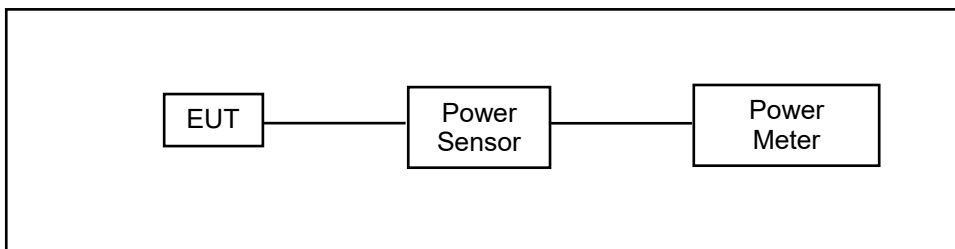

#### ■ Test Procedure

The testing follows the Measurement Procedure of ANSI C63.10:2013 section 11.9.2.3.2 Method AVGPM.

The tests below are run with the EUT's transmitter set at high power in TX mode. The EUT is needed to force selection of output power level and channel number. While testing, EUT was set to transmit continuously. Remove the Subjective device's antenna and connect the RF output port to power sensor.

#### 4.4. 6 dB RF Bandwidth Measurement

##### ■ Limit

6 dB RF Bandwidth: Systems using digital modulation techniques may operate in the 2400–2483.5 MHz bands. The minimum 6 dB band-width shall be at least 500 kHz.

##### ■ Test Setup

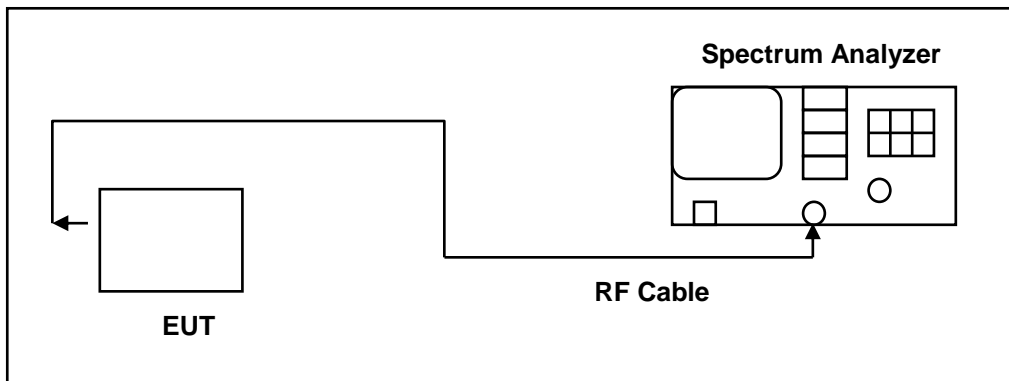

##### ■ Test Procedure

The EUT tested to DTS test procedure of ANSI C63.10:2013 section 11.8.2 option2 for compliance to FCC 47CFR 15.247 requirements.

6 dB RF Bandwidth: The antenna port of the EUT was connected to the input of a spectrum analyzer. Analyzer RBW was set to 100 kHz. For each RF output channel investigated, the spectrum analyzer center frequency was set to the channel carrier. A peak output reading was taken, a DISPLAY line was drawn 6 dB lower than peak level. The 6 dB bandwidth was determined from where the channel output spectrum intersected the display line.

The test was performed at 3 channels (Channel low, middle, high)

## 4.5. Maximum Power Spectral Density Measurement

### ■ Limit

For digitally modulated systems, the power spectral density conducted from the intentional radiator to the antenna shall not be greater than 8 dBm in any 3 kHz band during any time interval of continuous transmission.

### ■ Test Setup

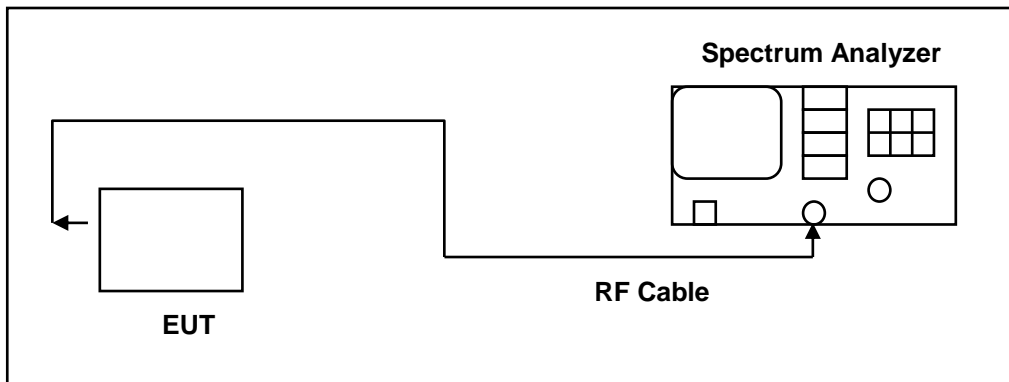

### ■ Test Procedure

The EUT tested to DTS test procedure of ANSI C63.10:2013 section 11.10.2 Method PKPSD for compliance to FCC 47CFR 15.247 requirements.

1. Set analyzer center frequency to DTS channel center frequency.
2. Set the span to 1.5 times the DTS bandwidth.
3. Set the RBW to:  $3 \text{ kHz} \leq \text{RBW} \leq 100 \text{ kHz}$ .
4. Set the VBW  $\geq 3 \times \text{RBW}$ .
5. Detector = peak.
6. Sweep time = auto couple.
7. Trace mode = max hold.
8. Allow trace to fully stabilize.
9. Use the peak marker function to determine the maximum amplitude level within the RBW.
10. If measured value exceeds limit, reduce RBW (no less than 3 kHz) and repeat.

#### 4.6. Out of Band Conducted Emissions Measurement

##### ■ Limit

In any 100 kHz bandwidth outside the frequency band in which the spread spectrum or digitally modulated intentional radiator is operating, the radio frequency power that is produced by the intentional radiator shall be at least 30 dB below that in the 100 kHz bandwidth within the band that contains the highest level of the desired power

##### ■ Test Setup

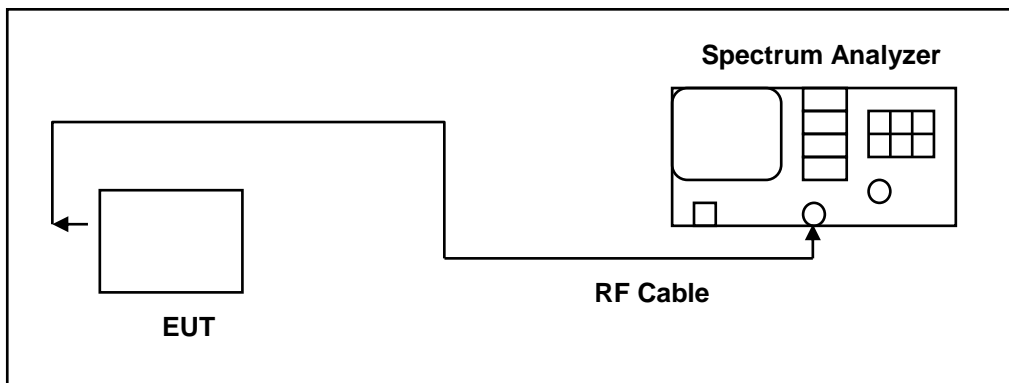

##### ■ Test Procedure

In any 100 kHz bandwidth outside the EUT pass band, the RF power produced by the modulation products of the spreading sequence, the information sequence, and the carrier frequency shall be at least 30 dB below that of the maximum in-band 100 kHz emission, antenna output of the EUT was coupled directly to spectrum analyzer; if an external attenuator and/or cable was used, these losses are compensated for with the analyzer OFFSET function.

All other types of emissions from the EUT shall meet the general limits for radiated frequencies outside the pass band. The test was performed at 3 channels.

## 4.7. Antenna Measurement

### ■ Limit

For intentional device, according to 15.203, an intentional radiator shall be designed to ensure that no antenna other than that furnished by the responsible party shall be used with the device.

And According to 15.247 (b), if transmitting antennas of directional gain greater than 6 dBi are used, the power shall be reduced by the amount in dB that the directional gain of the antenna exceeds 6 dBi.

### ■ Antenna Description

See section 2 – antenna information.

### ■ Directional Gain Calculated

1X1
-----

$$\text{Directional Gain} = 10 \cdot \log\left\{\frac{10^{G1/10} + 10^{G2/10} + \dots + 10^{Gn/10}}{NANT}\right\}$$

Operate Freq. Band	Directional Gain (dBi)
IEEE 802.11b	2.5
IEEE 802.11g	2.5
IEEE 802.11n 2.4 GHz 20 MHz(64QAM)	2.5
IEEE 802.11n 2.4 GHz 40 MHz(64QAM)	2.5
IEEE 802.11n 2.4 GHz 20 MHz(256QAM)	2.5
IEEE 802.11n 2.4 GHz 40 MHz(256QAM)	2.5
IEEE 802.11ax 2.4 GHz 20 MHz	2.5
IEEE 802.11ax 2.4 GHz 40 MHz	2.5



2X2

**For Maximum Conducted Output Power**

$$\text{Directional Gain} = 10 \cdot \log\{[10^{(G1/10)} + 10^{(G2/10)} + \dots + 10^{(Gn/10)}] / NANT\}$$

Operate Freq. Band	Directional Gain (dBi)
IEEE 802.11b	3.1
IEEE 802.11g	3.1
IEEE 802.11n 2.4 GHz 20 MHz(64QAM)	3.1
IEEE 802.11n 2.4 GHz 40 MHz(64QAM)	3.1
IEEE 802.11n 2.4 GHz 20 MHz(256QAM)	3.1
IEEE 802.11n 2.4 GHz 40 MHz(256QAM)	3.1
IEEE 802.11ax 2.4 GHz 20 MHz	3.1
IEEE 802.11ax 2.4 GHz 40 MHz	3.1

**For Maximum Power Density**

$$\text{Directional Gain} = 10 \cdot \log\{[10^{(G1/20)} + 10^{(G2/20)} + \dots + 10^{(Gn/20)}]^2 / NANT\}$$

Operate Freq. Band	Directional Gain (dBi)
IEEE 802.11b	5.82
IEEE 802.11g	5.82
IEEE 802.11n 2.4 GHz 20 MHz(64QAM)	5.82
IEEE 802.11n 2.4 GHz 40 MHz(64QAM)	5.82
IEEE 802.11n 2.4 GHz 20 MHz(256QAM)	5.82
IEEE 802.11n 2.4 GHz 40 MHz(256QAM)	5.82
IEEE 802.11ax 2.4 GHz 20 MHz	5.82
IEEE 802.11ax 2.4 GHz 40 MHz	5.82

Beamforming on

**For Maximum Conducted Output Power**

$$\text{Directional Gain} = 10 \cdot \log\{[10^{(G1/20)} + 10^{(G2/20)} + \dots + 10^{(Gn/20)}]^2 / NANT\}$$

Operate Freq. Band	Directional Gain (dBi)
IEEE 802.11n 2.4 GHz 20 MHz(64QAM)	5.82
IEEE 802.11n 2.4 GHz 40 MHz(64QAM)	5.82
IEEE 802.11n 2.4 GHz 20 MHz(256QAM)	5.82
IEEE 802.11n 2.4 GHz 40 MHz(256QAM)	5.82
IEEE 802.11ax 2.4 GHz 20 MHz	5.82
IEEE 802.11ax 2.4 GHz 40 MHz	5.82

## 5 Test Results

### 5.1. Conducted Emission

Standard:	FCC Part 15.247	Line:	L1
Test item:	Conducted Emission	Power:	AC 120 V/60 Hz
Mode:	Mode 1		
Description:			

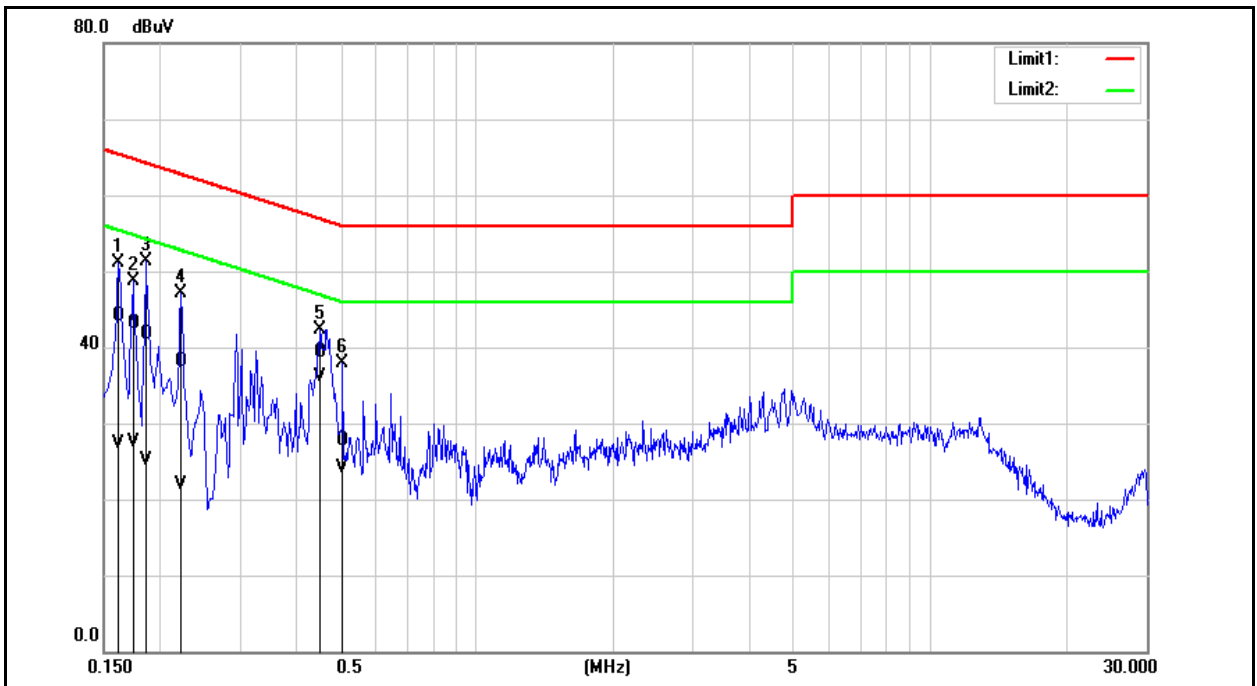

No.	Frequency (MHz)	QP reading (dBuV)	AVG reading (dBuV)	Correction factor (dB)	QP result (dBuV)	AVG result (dBuV)	QP limit (dBuV)	AVG limit (dBuV)	QP margin (dB)	AVG margin (dB)	Remark
1	0.1620	34.45	17.57	9.74	44.19	27.31	65.36	55.36	-21.17	-28.05	Pass
2	0.1740	33.45	17.84	9.74	43.19	27.58	64.77	54.77	-21.58	-27.19	Pass
3	0.1860	31.87	15.42	9.74	41.61	25.16	64.21	54.21	-22.60	-29.05	Pass
4	0.2220	28.44	12.08	9.74	38.18	21.82	62.74	52.74	-24.56	-30.92	Pass
5	0.4500	29.52	26.30	9.74	39.26	36.04	56.88	46.88	-17.62	-10.84	Pass
6	0.5060	18.01	14.36	9.74	27.75	24.10	56.00	46.00	-28.25	-21.90	Pass

Note: 1. Result (dBuV) = Correction factor (dB) + Reading(dBuV).  
2. Correction factor (dB) = Cable loss (dB) + L.I.S.N. factor (dB).

Standard:	FCC Part 15.247	Line:	N
Test item:	Conducted Emission	Power:	AC 120 V/60 Hz
Mode:	Mode 1		
Description:			

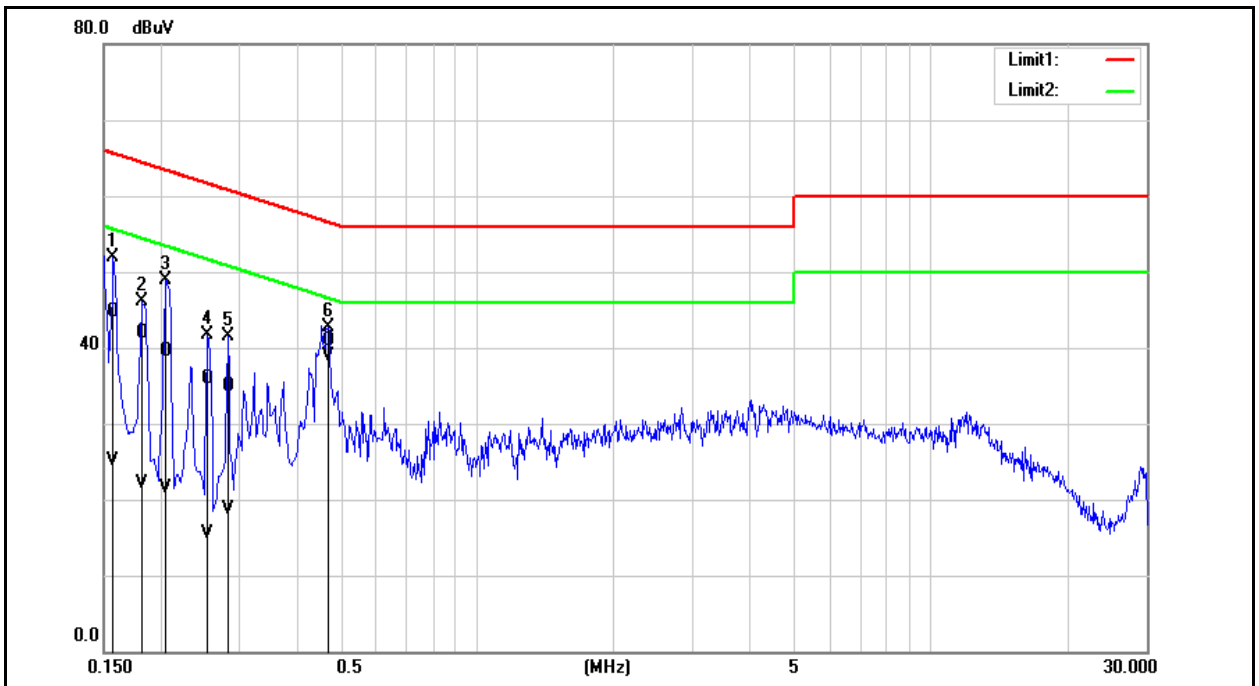

No.	Frequency (MHz)	QP reading (dBuV)	AVG reading (dBuV)	Correction factor (dB)	QP result (dBuV)	AVG result (dBuV)	QP limit (dBuV)	AVG limit (dBuV)	QP margin (dB)	AVG margin (dB)	Remark
1	0.1580	35.04	15.28	9.74	44.78	25.02	65.57	55.57	-20.79	-30.55	Pass
2	0.1820	32.11	12.38	9.73	41.84	22.11	64.39	54.39	-22.55	-32.28	Pass
3	0.2060	29.81	11.74	9.73	39.54	21.47	63.37	53.37	-23.83	-31.90	Pass
4	0.2540	26.20	5.75	9.73	35.93	15.48	61.63	51.63	-25.70	-36.15	Pass
5	0.2820	25.18	8.91	9.73	34.91	18.64	60.76	50.76	-25.85	-32.12	Pass
6	0.4700	31.27	29.16	9.73	41.00	38.89	56.51	46.51	-15.51	-7.62	Pass

Note: 1. Result (dBuV) = Correction factor (dB) + Reading(dBuV).  
2. Correction factor (dB) = Cable loss (dB) + L.I.S.N. factor (dB).

## 5.2. Conducted Test Results

1X1

### Maximum Conducted Output Power Measurement

Test Mode	Frequency (MHz)	RF Power setting in Test Software	Test Software Version
		ANT-0	
Mode 2	2412	100.0	Putty / accessMTool
	2437	100.0	
	2462	100.0	
Mode 3	2412	85.0	
	2437	100.0	
	2462	81.0	
Mode 4	2412	79.0	
	2437	99.0	
	2462	76.0	
Mode 5	2422	79.0	
	2437	82.0	
	2452	73.0	
Mode 6	2412	79.0	
	2437	99.0	
	2462	76.0	
Mode 7	2422	79.0	
	2437	82.0	
	2452	73.0	
Mode 8	2412	79.0	
	2437	99.0	
	2462	76.0	
Mode 9	2422	79.0	
	2437	82.0	
	2452	73.0	

ANT-0					
Test Mode	Frequency (MHz)	Data Rate	Average Output Power		
			Measurement Results		Limit
			dBm	W	dBm
Mode 2	2412	1 M	24.11	0.258	≤ 30
	2437		24.01	0.252	≤ 30
	2462		23.99	0.251	≤ 30
Mode 3	2412	6 M	21.08	0.128	≤ 30
	2437		24.15	0.260	≤ 30
	2462		19.82	0.096	≤ 30
Mode 4	2412	6.5 M	19.66	0.092	≤ 30
	2437		23.98	0.250	≤ 30
	2462		18.82	0.076	≤ 30
Mode 5	2422	13.5 M	19.53	0.090	≤ 30
	2437		20.32	0.108	≤ 30
	2452		18.17	0.066	≤ 30
Mode 6	2412	6.5 M	19.77	0.095	≤ 30
	2437		24.05	0.254	≤ 30
	2462		18.90	0.078	≤ 30
Mode 7	2422	13.5 M	19.63	0.092	≤ 30
	2437		20.45	0.111	≤ 30
	2452		18.28	0.067	≤ 30
Mode 8	2412	<b>MCS0</b>	19.83	0.096	≤ 30
	2437		24.15	0.260	≤ 30
	2462		18.96	0.079	≤ 30
Mode 9	2422	<b>MCS0</b>	19.68	0.093	≤ 30
	2437		20.51	0.112	≤ 30
	2452		18.29	0.067	≤ 30

Note: The relevant measured result has the offset with cable loss already.

**6 dB RF Bandwidth Measurement**

ANT-0			
Test Mode	Frequency (MHz)	Measurement (kHz)	Limit (kHz)
Mode 2	2412	7105	≥ 500
	2437	7103	≥ 500
	2462	7106	≥ 500
Mode 3	2412	16150	≥ 500
	2437	16120	≥ 500
	2462	16140	≥ 500
Mode 8	2412	18990	≥ 500
	2437	18870	≥ 500
	2462	18980	≥ 500
Mode 9	2422	37820	≥ 500
	2437	37510	≥ 500
	2452	37760	≥ 500

■ Test Graphs

Mode 2: IEEE 802.11b Continuous TX Mode_ANT-0	
2412 MHz	<p>Center Frequency: 2.41200000 GHz Span: 40.000 MHz CF Step: 4.000000 MHz Ref Lvl Offset: 0.80 dB Ref Value: 20.00 dBm Occupied Bandwidth: 10.413 MHz Total Power: 22.5 dBm Transmit Freq Error: 41.489 kHz % of OBW Power: 99.00 % x dB Bandwidth: 7.105 MHz x dB: -6.00 dB</p>
2437 MHz	<p>Center Frequency: 2.43700000 GHz Span: 40.000 MHz CF Step: 4.000000 MHz Ref Lvl Offset: 0.80 dB Ref Value: 20.00 dBm Occupied Bandwidth: 10.437 MHz Total Power: 22.4 dBm Transmit Freq Error: 50.236 kHz % of OBW Power: 99.00 % x dB Bandwidth: 7.103 MHz x dB: -6.00 dB</p>
2462 MHz	<p>Center Frequency: 2.46200000 GHz Span: 40.000 MHz CF Step: 4.000000 MHz Ref Lvl Offset: 0.80 dB Ref Value: 20.00 dBm Occupied Bandwidth: 10.442 MHz Total Power: 22.3 dBm Transmit Freq Error: 54.571 kHz % of OBW Power: 99.00 % x dB Bandwidth: 7.106 MHz x dB: -6.00 dB</p>

Mode 3: IEEE 802.11g Continuous TX Mode\_ANT-0

2412 MHz

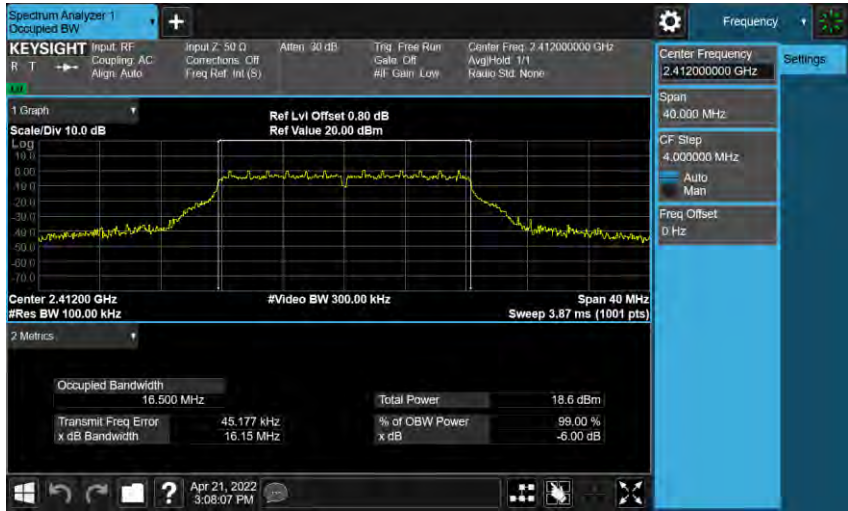

2437 MHz



2462 MHz





Mode 8: IEEE 802.11ax 2.4 GHz 20 MHz Continuous TX Mode\_ANT-0

2412 MHz

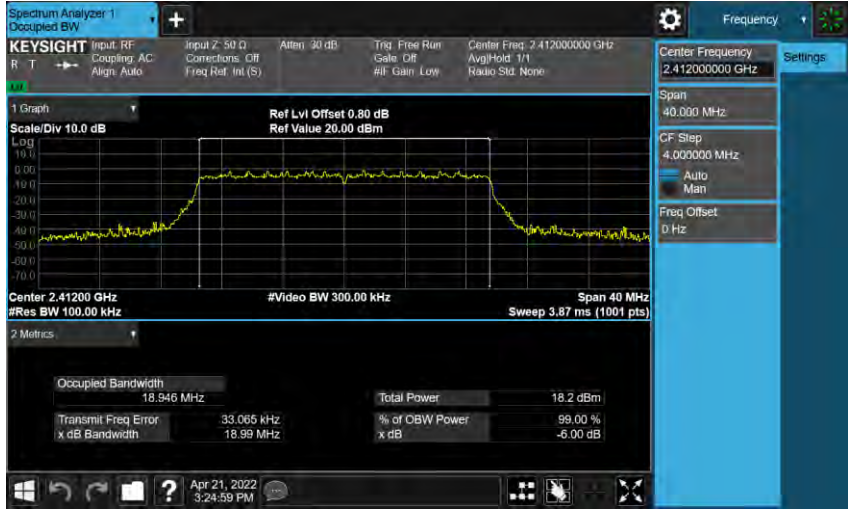

2437 MHz

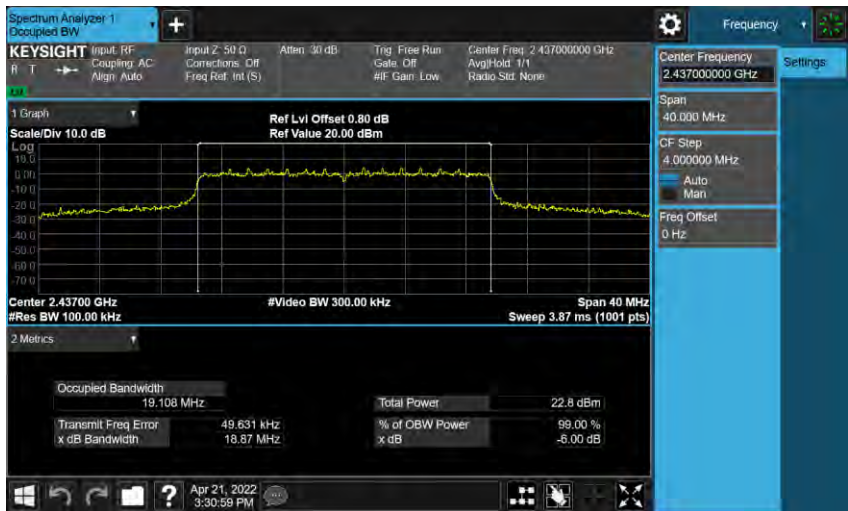

2462 MHz

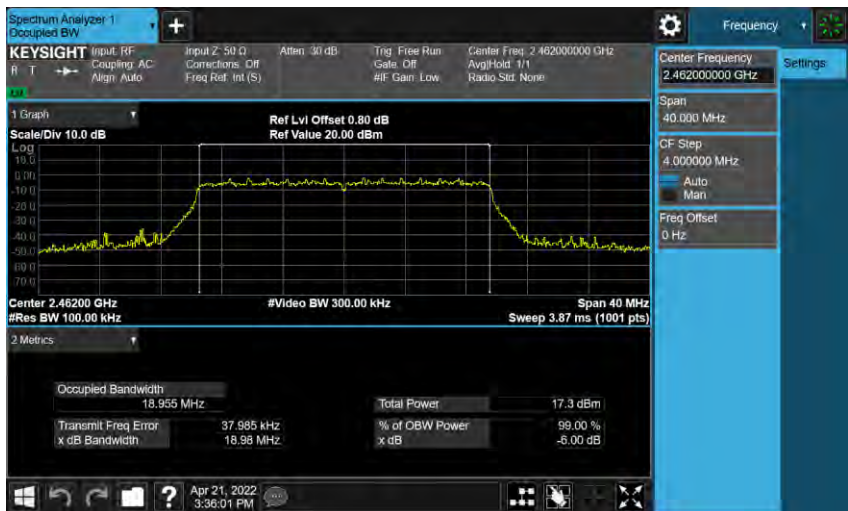

Mode 9: IEEE 802.11ax 2.4 GHz 40 MHz Continuous TX Mode\_ANT-0

2422 MHz

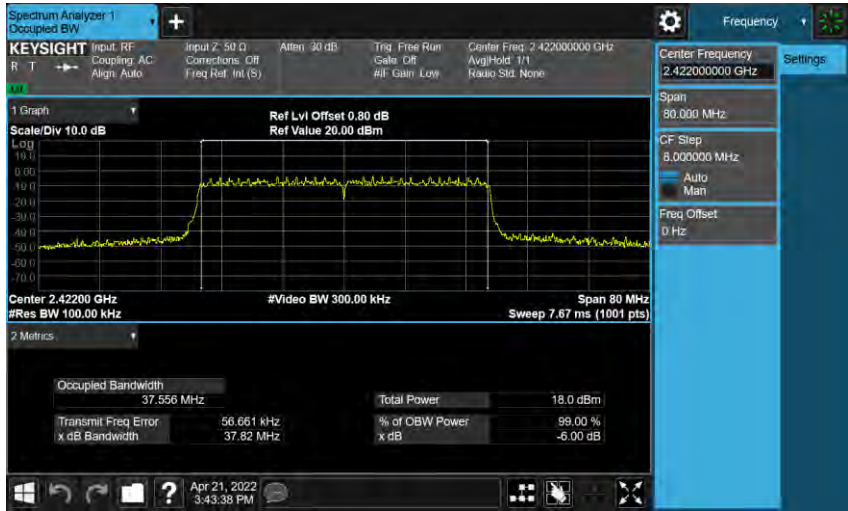

2437 MHz

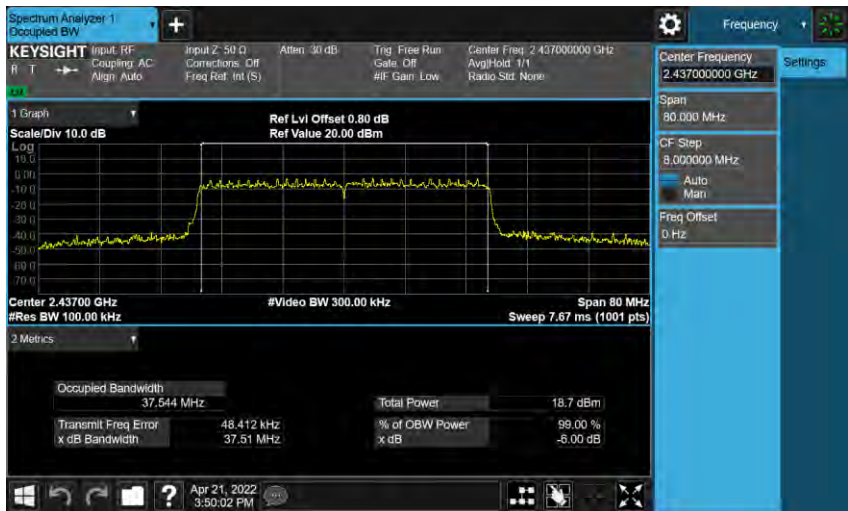

2452 MHz

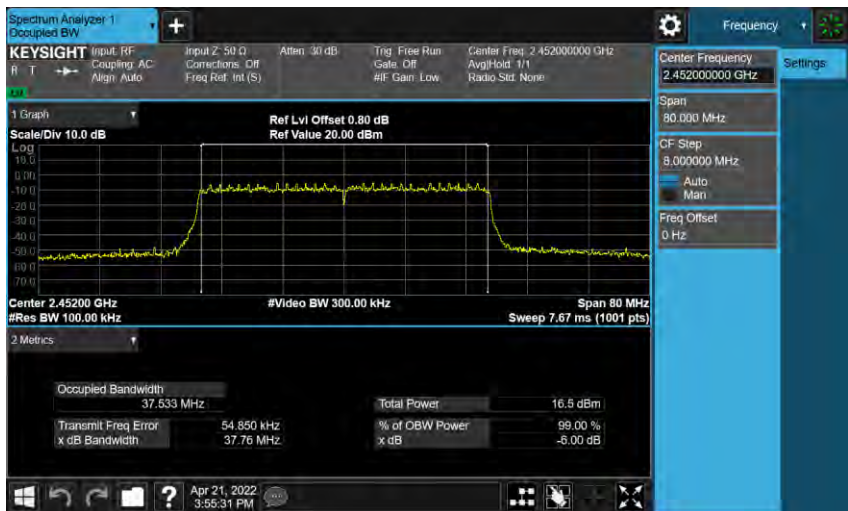

**Maximum Power Spectral Density Measurement**

ANT-0			
Test Mode	Frequency (MHz)	Measurement (dBm/3 kHz)	Limit (dBm/ 3 kHz)
Mode 2	2412	-5.880	≤ 8
	2437	-6.670	≤ 8
	2462	-6.710	≤ 8
Mode 3	2412	-13.830	≤ 8
	2437	-11.210	≤ 8
	2462	-15.140	≤ 8
Mode 8	2412	-15.420	≤ 8
	2437	-11.280	≤ 8
	2462	-16.560	≤ 8
Mode 9	2422	-19.360	≤ 8
	2437	-18.530	≤ 8
	2452	-20.670	≤ 8

■ Test Graphs

Mode 2: IEEE 802.11b Continuous TX Mode_ANT-0	
2412 MHz	
2437 MHz	
2462 MHz	

Mode 3: IEEE 802.11g Continuous TX Mode\_ANT-0

2412 MHz

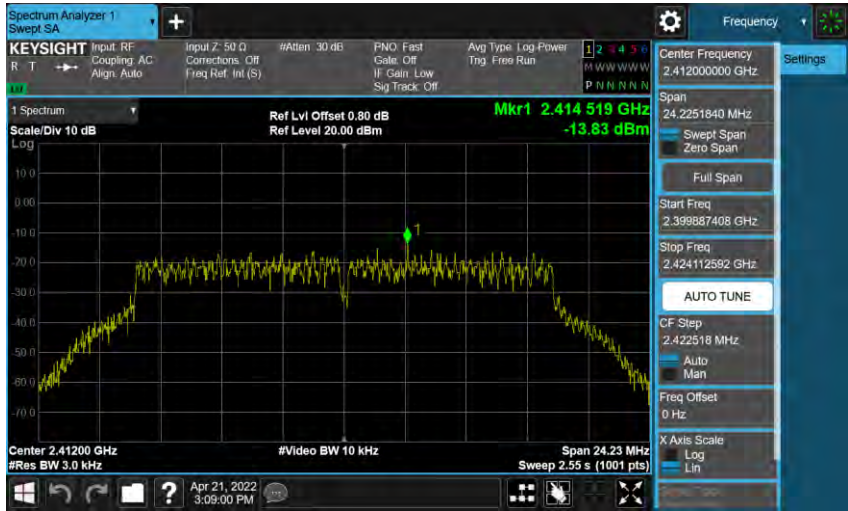

2437 MHz

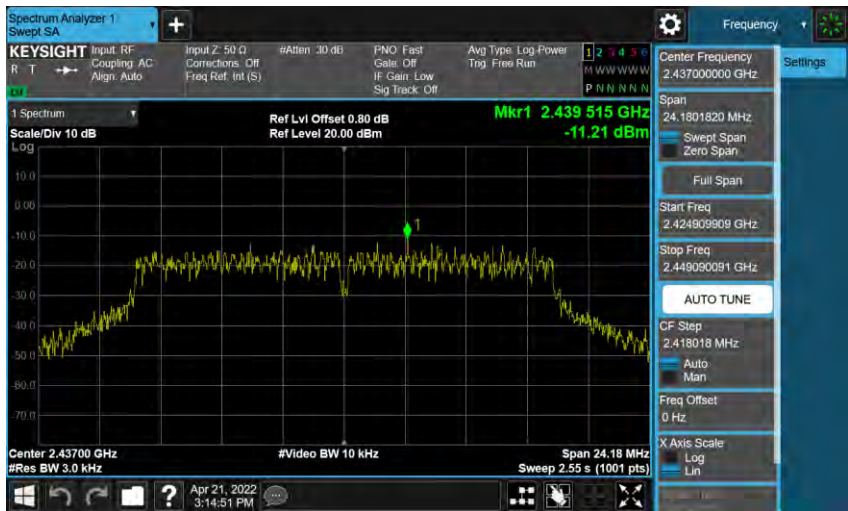

2462 MHz

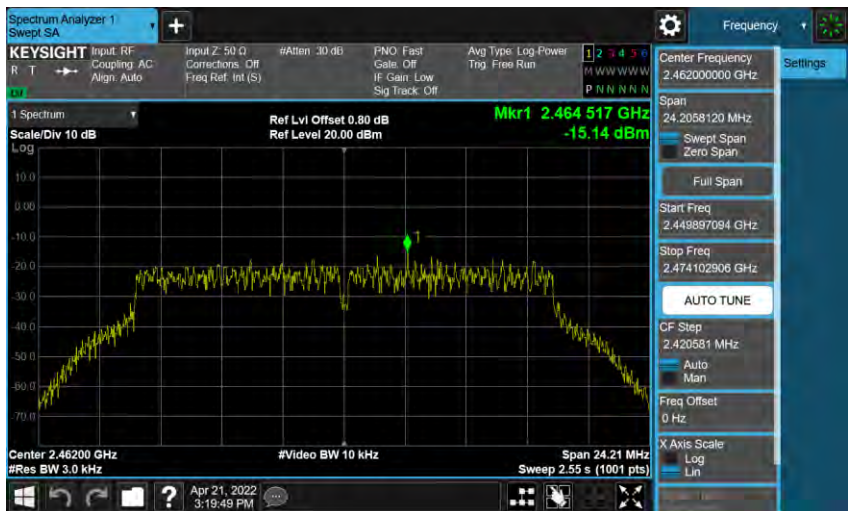

Mode 8: IEEE 802.11ax 2.4 GHz 20 MHz Continuous TX Mode\_ANT-0

2412 MHz

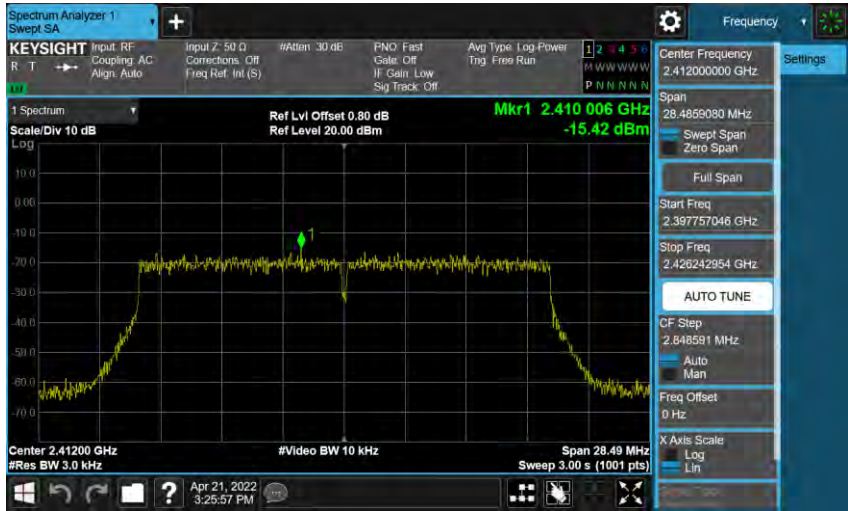

2437 MHz



2462 MHz

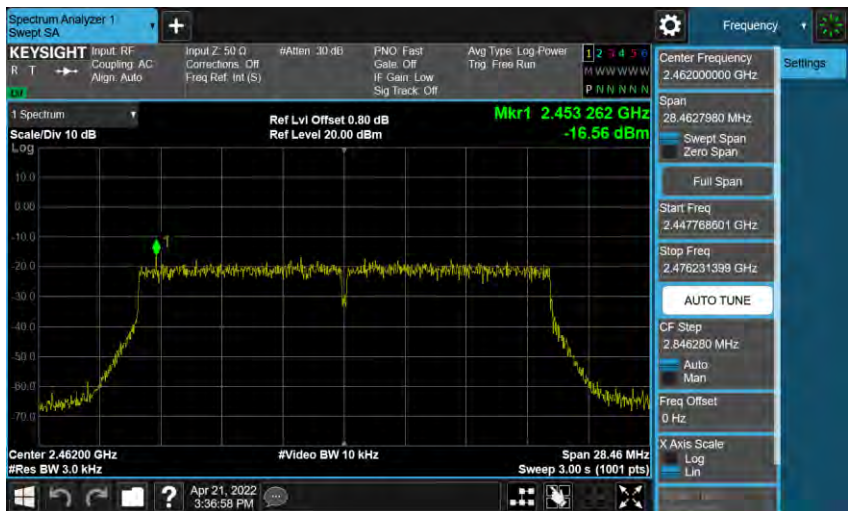

Mode 9: IEEE 802.11ax 2.4 GHz 40 MHz Continuous TX Mode\_ANT-0

2422 MHz

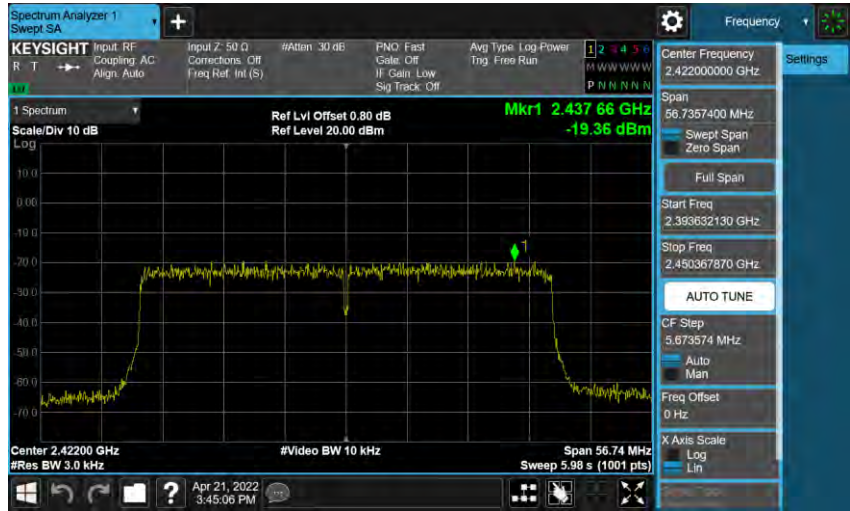

2437 MHz

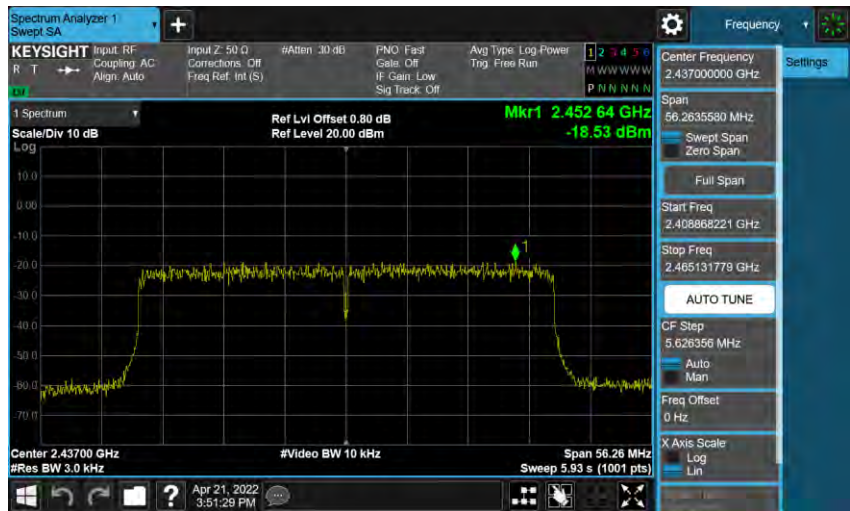

2452 MHz

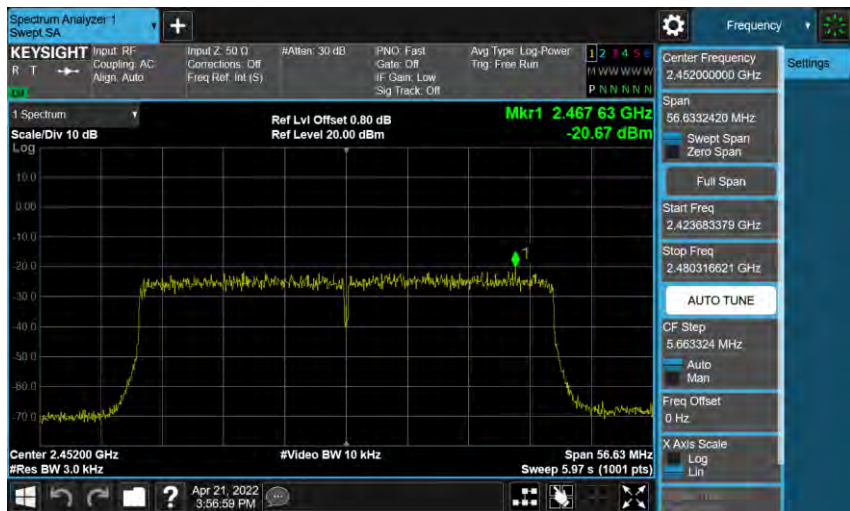

Out of Band Conducted Emissions Measurement

Reference level

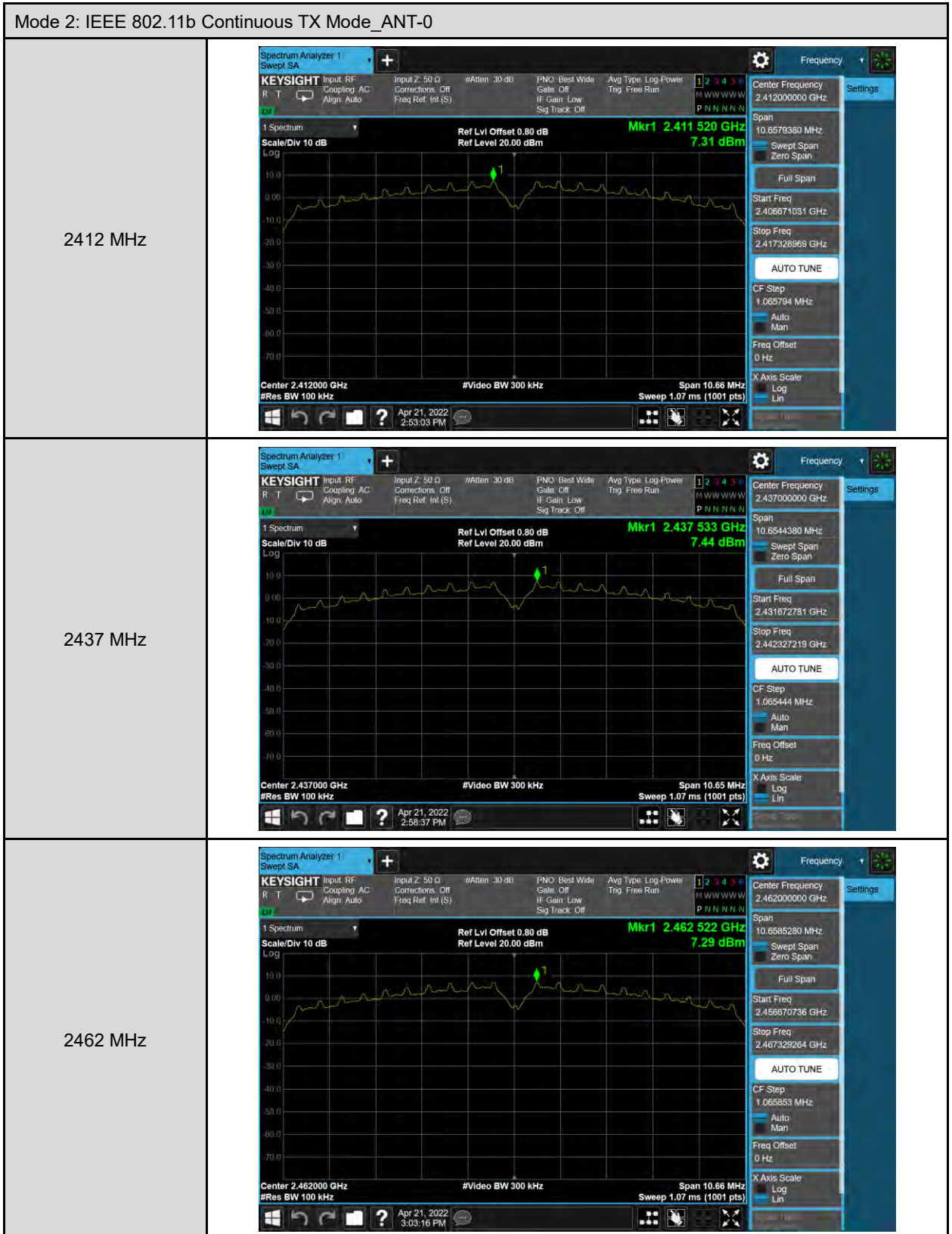



Mode 3: IEEE 802.11g Continuous TX Mode\_ANT-0

2412 MHz



2437 MHz



2462 MHz

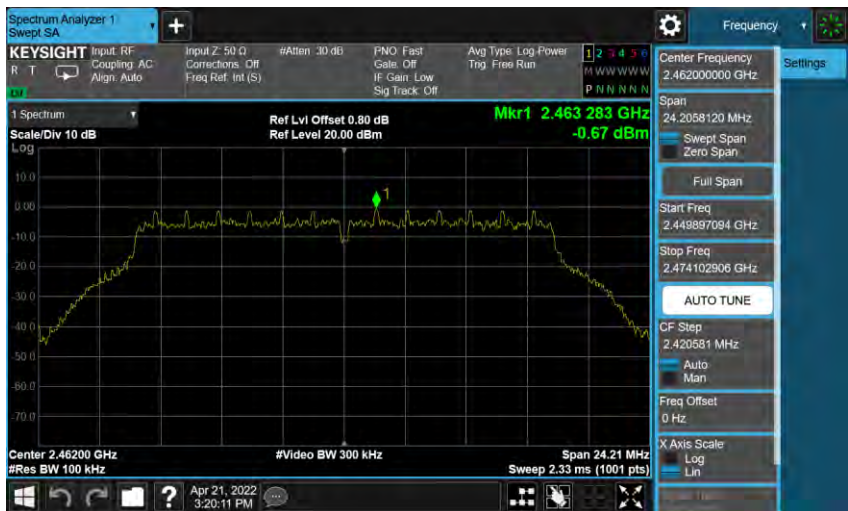

Mode 8: IEEE 802.11ax 2.4 GHz 20 MHz Continuous TX Mode\_ANT-0

2412 MHz



2437 MHz



2462 MHz

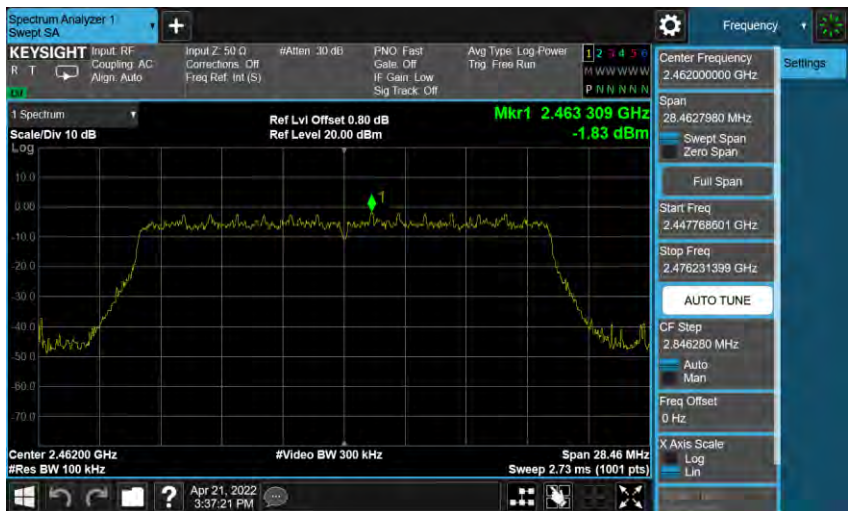

Mode 9: IEEE 802.11ax 2.4 GHz 40 MHz Continuous TX Mode\_ANT-0

2422 MHz

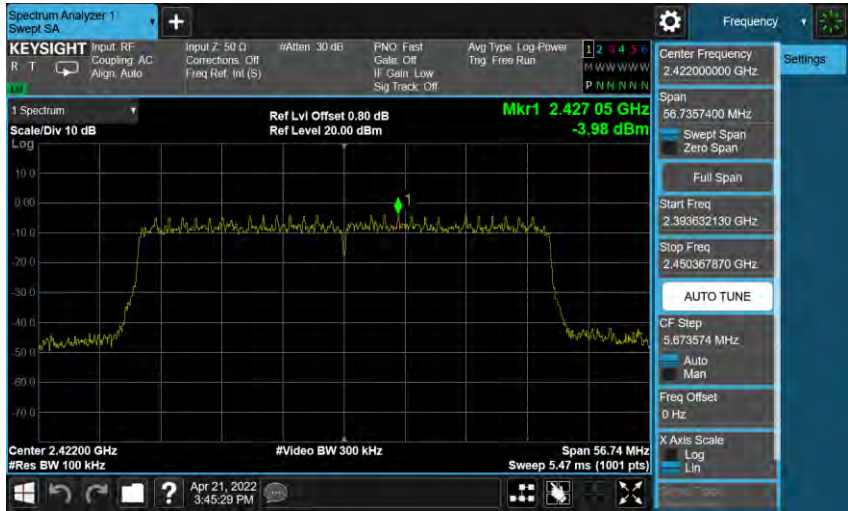

2437 MHz

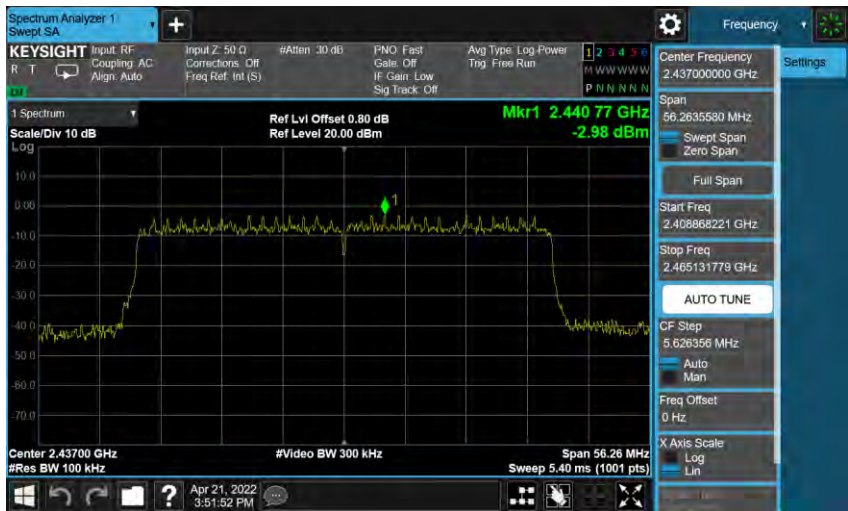

2452 MHz

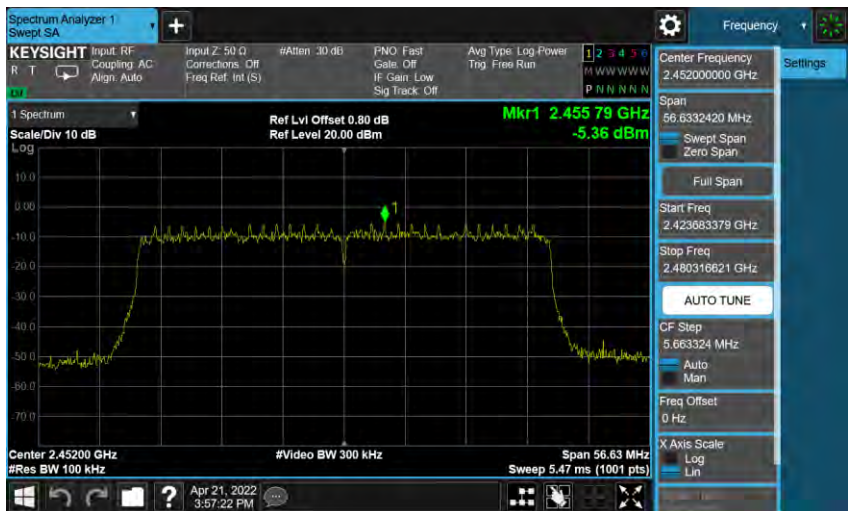

Out of Band Conducted Emissions

Mode 2: IEEE 802.11b Continuous TX Mode\_ANT-0

2412 MHz



2437 MHz



2462 MHz



Mode 3: IEEE 802.11g Continuous TX Mode\_ANT-0

2412 MHz



2437 MHz



2462 MHz



Mode 8: IEEE 802.11ax 2.4 GHz 20 MHz Continuous TX Mode\_ANT-0

2412 MHz



2437 MHz



2462 MHz



Mode 9: IEEE 802.11ax 2.4 GHz 40 MHz Continuous TX Mode\_ANT-0

2422 MHz



2437 MHz



2452 MHz



Conducted Band Edge

Mode 2: IEEE 802.11b Continuous TX Mode\_ANT-0

2412 MHz



2462 MHz

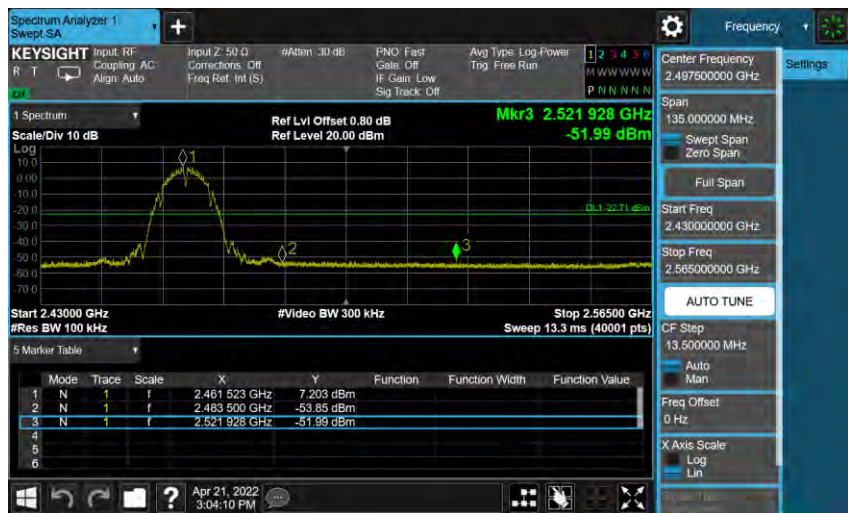



Mode 3: IEEE 802.11g Continuous TX Mode\_ANT-0

2412 MHz



2462 MHz



Mode 8: IEEE 802.11ax 2.4 GHz 20 MHz Continuous TX Mode\_ANT-0

2412 MHz



2462 MHz



Mode 9: IEEE 802.11ax 2.4 GHz 40 MHz Continuous TX Mode\_ANT-0

2422 MHz



2452 MHz

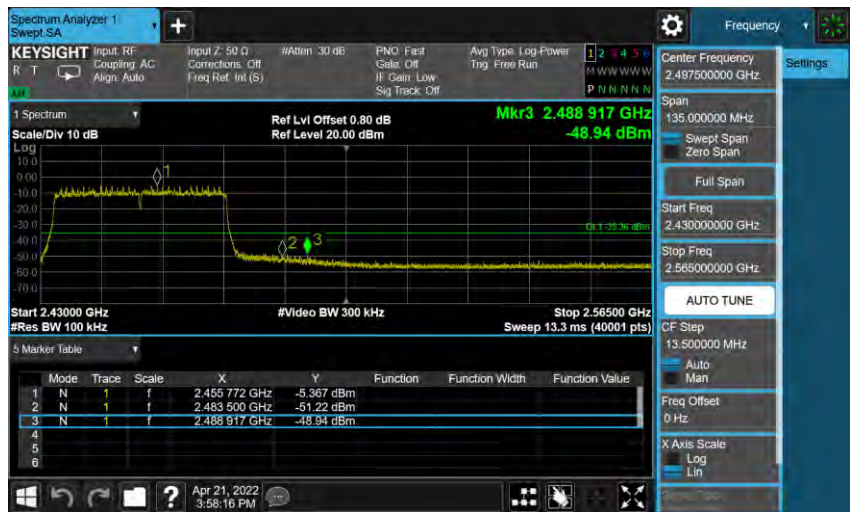

2X2

**Maximum Conducted Output Power Measurement**

Test Mode	Frequency (MHz)	RF Power setting in Test Software		Test Software Version
		ANT-0	ANT-1	
Mode 2	2412	100.0	100.0	Putty / accessMTool
	2437	100.0	100.0	
	2462	100.0	100.0	
Mode 3	2412	85.0	85.0	
	2437	100.0	100.0	
	2462	81.0	81.0	
Mode 4	2412	79.0	79.0	
	2437	100.0	100.0	
	2462	78.0	78.0	
Mode 5	2422	75.0	75.0	
	2437	82.0	82.0	
	2452	74.0	74.0	
Mode 6	2412	79.0	79.0	
	2437	100.0	100.0	
	2462	78.0	78.0	
Mode 7	2422	75.0	75.0	
	2437	82.0	82.0	
	2452	74.0	74.0	
Mode 8	2412	79.0	79.0	
	2437	100.0	100.0	
	2462	78.0	78.0	
Mode 9	2422	75.0	75.0	
	2437	82.0	82.0	
	2452	74.0	74.0	

Beamforming on

**Maximum Conducted Output Power Measurement**

Test Mode	Frequency (MHz)	RF Power setting in Test Software		Test Software Version
		ANT-0	ANT-1	
Mode 4	2412	67.00	67.00	Putty / accessMTool
	2437	88.00	88.00	
	2462	66.00	66.00	
Mode 5	2422	63.00	63.00	
	2437	70.00	70.00	
	2452	62.00	62.00	
Mode 6	2412	67.00	67.00	
	2437	88.00	88.00	
	2462	66.00	66.00	
Mode 7	2422	63.00	63.00	
	2437	70.00	70.00	
	2452	62.00	62.00	
Mode 8	2412	67.00	67.00	
	2437	88.00	88.00	
	2462	66.00	66.00	
Mode 9	2422	63.00	63.00	
	2437	70.00	70.00	
	2452	62.00	62.00	

2X2
-----

ANT-0					
Test Mode	Frequency (MHz)	Data Rate	Average Output Power		
			Measurement Results		Limit
			dBm	W	dBm
Mode 2	2412	1 M	24.11	0.258	≤ 30
	2437		24.12	0.258	≤ 30
	2462		23.95	0.248	≤ 30
Mode 3	2412	6 M	21.15	0.130	≤ 30
	2437		24.09	0.256	≤ 30
	2462		19.88	0.097	≤ 30
Mode 4	2412	13 M	19.71	0.094	≤ 30
	2437		24.30	0.269	≤ 30
	2462		19.08	0.081	≤ 30
Mode 5	2422	27 M	18.67	0.074	≤ 30
	2437		20.37	0.109	≤ 30
	2452		18.19	0.066	≤ 30
Mode 6	2412	13 M	19.73	0.094	≤ 30
	2437		24.33	0.271	≤ 30
	2462		19.17	0.083	≤ 30
Mode 7	2422	27 M	18.76	0.075	≤ 30
	2437		20.41	0.110	≤ 30
	2452		18.32	0.068	≤ 30
Mode 8	2412	MCS0	19.85	0.097	≤ 30
	2437		24.35	0.272	≤ 30
	2462		19.31	0.085	≤ 30
Mode 9	2422	MCS0	18.86	0.077	≤ 30
	2437		20.42	0.110	≤ 30
	2452		18.45	0.070	≤ 30

Note: The relevant measured result has the offset with cable loss already.

ANT-1					
Test Mode	Frequency (MHz)	Data Rate	Average Output Power		
			Measurement Results		Limit
			dBm	W	dBm
Mode 2	2412	1 M	24.46	0.279	≤ 30
	2437		24.59	0.288	≤ 30
	2462		24.51	0.282	≤ 30
Mode 3	2412	6 M	20.62	0.115	≤ 30
	2437		23.99	0.251	≤ 30
	2462		19.76	0.095	≤ 30
Mode 4	2412	13 M	19.64	0.092	≤ 30
	2437		24.07	0.255	≤ 30
	2462		19.07	0.081	≤ 30
Mode 5	2422	27 M	18.68	0.074	≤ 30
	2437		20.07	0.102	≤ 30
	2452		18.44	0.070	≤ 30
Mode 6	2412	13 M	19.65	0.092	≤ 30
	2437		24.19	0.262	≤ 30
	2462		19.17	0.083	≤ 30
Mode 7	2422	27 M	18.71	0.074	≤ 30
	2437		20.20	0.105	≤ 30
	2452		18.58	0.072	≤ 30
Mode 8	2412	MCS0	19.71	0.094	≤ 30
	2437		24.29	0.269	≤ 30
	2462		19.28	0.085	≤ 30
Mode 9	2422	MCS0	18.77	0.075	≤ 30
	2437		20.31	0.107	≤ 30
	2452		18.61	0.073	≤ 30

Note: The relevant measured result has the offset with cable loss already.

ANT-0+1					
Test Mode	Frequency (MHz)	Data Rate	Average Output Power		
			Measurement Results		Limit
			dBm	W	dBm
Mode 2	2412	1 M	27.30	0.537	≤ 30
	2437		27.37	0.546	≤ 30
	2462		27.25	0.531	≤ 30
Mode 3	2412	6 M	23.90	0.246	≤ 30
	2437		27.05	0.507	≤ 30
	2462		22.83	0.192	≤ 30
Mode 4	2412	13 M	22.69	0.186	≤ 30
	2437		27.20	0.524	≤ 30
	2462		22.09	0.162	≤ 30
Mode 5	2422	27 M	21.69	0.147	≤ 30
	2437		23.23	0.211	≤ 30
	2452		21.33	0.136	≤ 30
Mode 6	2412	13 M	22.70	0.186	≤ 30
	2437		27.27	0.533	≤ 30
	2462		22.18	0.165	≤ 30
Mode 7	2422	27 M	21.75	0.149	≤ 30
	2437		23.32	0.215	≤ 30
	2452		21.46	0.140	≤ 30
Mode 8	2412	MCS0	22.79	0.190	≤ 30
	2437		27.33	0.541	≤ 30
	2462		22.31	0.170	≤ 30
Mode 9	2422	MCS0	21.83	0.152	≤ 30
	2437		23.38	0.218	≤ 30
	2452		21.54	0.143	≤ 30

Note: The relevant measured result has the offset with cable loss already.



Beamforming on
----------------

ANT-0					
Test Mode	Frequency (MHz)	Data Rate	Average Output Power		
			Measurement Results		Limit
			dBm	W	dBm
Mode 4	2412	13 M	16.81	0.048	≤ 30
	2437		21.55	0.143	≤ 30
	2462		16.32	0.043	≤ 30
Mode 5	2422	27 M	15.91	0.039	≤ 30
	2437		17.40	0.055	≤ 30
	2452		15.34	0.034	≤ 30
Mode 6	2412	13 M	16.91	0.049	≤ 30
	2437		21.57	0.144	≤ 30
	2462		16.43	0.044	≤ 30
Mode 7	2422	27 M	15.94	0.039	≤ 30
	2437		17.54	0.057	≤ 30
	2452		15.46	0.035	≤ 30
Mode 8	2412	MCS0	17.00	0.050	≤ 30
	2437		21.59	0.144	≤ 30
	2462		16.48	0.044	≤ 30
Mode 9	2422	MCS0	16.01	0.040	≤ 30
	2437		17.60	0.058	≤ 30
	2452		15.57	0.036	≤ 30

Note: The relevant measured result has the offset with cable loss already.

ANT-1					
Test Mode	Frequency (MHz)	Data Rate	Average Output Power		
			Measurement Results		Limit
			dBm	W	dBm
Mode 4	2412	13 M	16.96	0.050	≤ 30
	2437		21.28	0.134	≤ 30
	2462		16.41	0.044	≤ 30
Mode 5	2422	27 M	15.93	0.039	≤ 30
	2437		17.45	0.056	≤ 30
	2452		15.56	0.036	≤ 30
Mode 6	2412	13 M	16.99	0.050	≤ 30
	2437		21.33	0.136	≤ 30
	2462		16.45	0.044	≤ 30
Mode 7	2422	27 M	16.03	0.040	≤ 30
	2437		17.60	0.058	≤ 30
	2452		15.69	0.037	≤ 30
Mode 8	2412	MCS0	17.04	0.051	≤ 30
	2437		21.36	0.137	≤ 30
	2462		16.59	0.046	≤ 30
Mode 9	2422	MCS0	16.04	0.040	≤ 30
	2437		17.64	0.058	≤ 30
	2452		15.80	0.038	≤ 30

Note: The relevant measured result has the offset with cable loss already.



ANT-0+1					
Test Mode	Frequency (MHz)	Data Rate	Average Output Power		
			Measurement Results		Limit
			dBm	W	dBm
Mode 4	2412	13 M	19.90	0.098	≤ 30
	2437		24.43	0.277	≤ 30
	2462		19.38	0.087	≤ 30
Mode 5	2422	27 M	18.93	0.078	≤ 30
	2437		20.44	0.111	≤ 30
	2452		18.46	0.070	≤ 30
Mode 6	2412	13 M	19.96	0.099	≤ 30
	2437		24.46	0.279	≤ 30
	2462		19.45	0.088	≤ 30
Mode 7	2422	27 M	19.00	0.079	≤ 30
	2437		20.58	0.114	≤ 30
	2452		18.59	0.072	≤ 30
Mode 8	2412	MCS0	20.03	0.101	≤ 30
	2437		24.49	0.281	≤ 30
	2462		19.55	0.090	≤ 30
Mode 9	2422	MCS0	19.04	0.080	≤ 30
	2437		20.63	0.116	≤ 30
	2452		18.70	0.074	≤ 30

Note: The relevant measured result has the offset with cable loss already.

**6 dB RF Bandwidth Measurement**

Test Mode	Frequency (MHz)	Measurement (kHz)		Limit (kHz)
		ANT-0	ANT-1	
Mode 2	2412	7102	7106	≥ 500
	2437	7103	7099	≥ 500
	2462	7118	7104	≥ 500
Mode 3	2412	16140	16360	≥ 500
	2437	16130	16330	≥ 500
	2462	16150	16360	≥ 500
Mode 8	2412	18980	18970	≥ 500
	2437	18820	18920	≥ 500
	2462	18940	18930	≥ 500
Mode 9	2422	37830	37410	≥ 500
	2437	37750	37740	≥ 500
	2452	37860	37450	≥ 500

■ Test Graphs

Mode 2: IEEE 802.11b Continuous TX Mode_ANT-0													
2412 MHz	 <p>Center 2.41200 GHz #Res BW 100.00 kHz #Video BW 300.00 kHz Span 40 MHz Sweep 3.87 ms (1001 pts)</p> <p>2 Metrics</p> <table border="1"> <tr> <td>Occupied Bandwidth</td> <td>10.428 MHz</td> <td>Total Power</td> <td>22.5 dBm</td> </tr> <tr> <td>Transmit Freq Error</td> <td>31.740 kHz</td> <td>% of OBW Power</td> <td>99.00 %</td> </tr> <tr> <td>x dB Bandwidth</td> <td>7.102 MHz</td> <td>x dB</td> <td>-6.00 dB</td> </tr> </table>	Occupied Bandwidth	10.428 MHz	Total Power	22.5 dBm	Transmit Freq Error	31.740 kHz	% of OBW Power	99.00 %	x dB Bandwidth	7.102 MHz	x dB	-6.00 dB
Occupied Bandwidth	10.428 MHz	Total Power	22.5 dBm										
Transmit Freq Error	31.740 kHz	% of OBW Power	99.00 %										
x dB Bandwidth	7.102 MHz	x dB	-6.00 dB										
2437 MHz	 <p>Center 2.43700 GHz #Res BW 100.00 kHz #Video BW 300.00 kHz Span 40 MHz Sweep 3.87 ms (1001 pts)</p> <p>2 Metrics</p> <table border="1"> <tr> <td>Occupied Bandwidth</td> <td>10.493 MHz</td> <td>Total Power</td> <td>22.4 dBm</td> </tr> <tr> <td>Transmit Freq Error</td> <td>53.729 kHz</td> <td>% of OBW Power</td> <td>99.00 %</td> </tr> <tr> <td>x dB Bandwidth</td> <td>7.103 MHz</td> <td>x dB</td> <td>-6.00 dB</td> </tr> </table>	Occupied Bandwidth	10.493 MHz	Total Power	22.4 dBm	Transmit Freq Error	53.729 kHz	% of OBW Power	99.00 %	x dB Bandwidth	7.103 MHz	x dB	-6.00 dB
Occupied Bandwidth	10.493 MHz	Total Power	22.4 dBm										
Transmit Freq Error	53.729 kHz	% of OBW Power	99.00 %										
x dB Bandwidth	7.103 MHz	x dB	-6.00 dB										
2462 MHz	 <p>Center 2.46200 GHz #Res BW 100.00 kHz #Video BW 300.00 kHz Span 40 MHz Sweep 3.87 ms (1001 pts)</p> <p>2 Metrics</p> <table border="1"> <tr> <td>Occupied Bandwidth</td> <td>10.499 MHz</td> <td>Total Power</td> <td>22.4 dBm</td> </tr> <tr> <td>Transmit Freq Error</td> <td>59.002 kHz</td> <td>% of OBW Power</td> <td>99.00 %</td> </tr> <tr> <td>x dB Bandwidth</td> <td>7.118 MHz</td> <td>x dB</td> <td>-6.00 dB</td> </tr> </table>	Occupied Bandwidth	10.499 MHz	Total Power	22.4 dBm	Transmit Freq Error	59.002 kHz	% of OBW Power	99.00 %	x dB Bandwidth	7.118 MHz	x dB	-6.00 dB
Occupied Bandwidth	10.499 MHz	Total Power	22.4 dBm										
Transmit Freq Error	59.002 kHz	% of OBW Power	99.00 %										
x dB Bandwidth	7.118 MHz	x dB	-6.00 dB										

Mode 3: IEEE 802.11g Continuous TX Mode\_ANT-0

2412 MHz

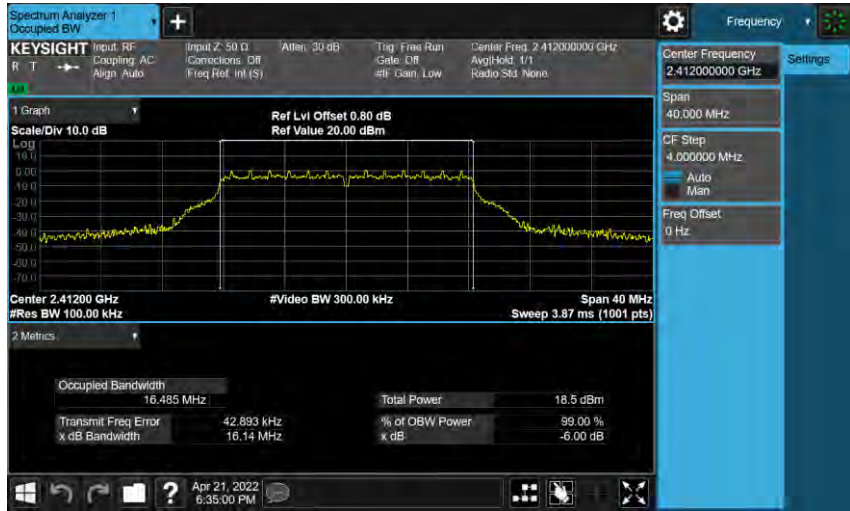

2437 MHz



2462 MHz

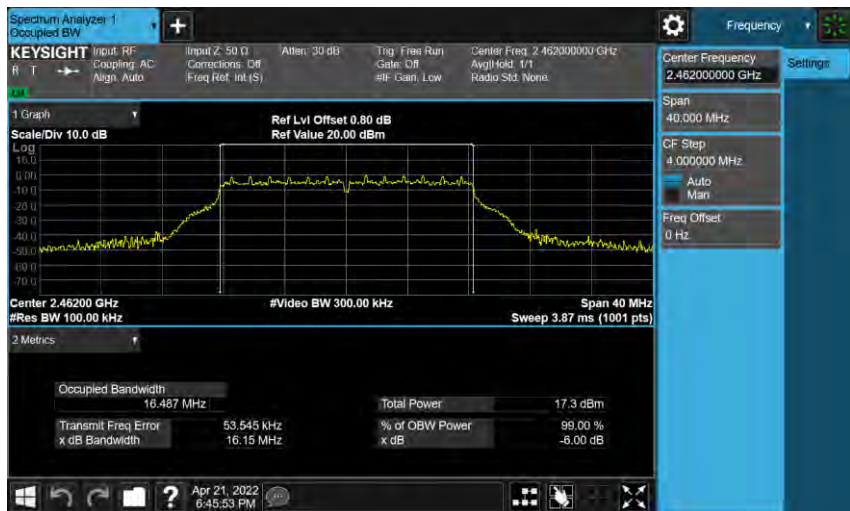

Mode 8: IEEE 802.11ax 2.4 GHz 20 MHz Continuous TX Mode\_ANT-0

<p>2412 MHz</p>	<p>Center 2.41200 GHz #Res BW 100.00 kHz Span 40 MHz Sweep 3.87 ms (1001 pts)</p> <table border="1"> <tr> <td>Occupied Bandwidth</td> <td>18.942 MHz</td> <td>Total Power</td> <td>18.4 dBm</td> </tr> <tr> <td>Transmit Freq Error</td> <td>32.329 kHz</td> <td>% of OBW Power</td> <td>99.00 %</td> </tr> <tr> <td>x dB Bandwidth</td> <td>18.98 MHz</td> <td>x dB</td> <td>-6.00 dB</td> </tr> </table>	Occupied Bandwidth	18.942 MHz	Total Power	18.4 dBm	Transmit Freq Error	32.329 kHz	% of OBW Power	99.00 %	x dB Bandwidth	18.98 MHz	x dB	-6.00 dB
Occupied Bandwidth	18.942 MHz	Total Power	18.4 dBm										
Transmit Freq Error	32.329 kHz	% of OBW Power	99.00 %										
x dB Bandwidth	18.98 MHz	x dB	-6.00 dB										
<p>2437 MHz</p>	<p>Center 2.43700 GHz #Res BW 100.00 kHz Span 40 MHz Sweep 3.87 ms (1001 pts)</p> <table border="1"> <tr> <td>Occupied Bandwidth</td> <td>19.153 MHz</td> <td>Total Power</td> <td>23.0 dBm</td> </tr> <tr> <td>Transmit Freq Error</td> <td>51.205 kHz</td> <td>% of OBW Power</td> <td>99.00 %</td> </tr> <tr> <td>x dB Bandwidth</td> <td>18.82 MHz</td> <td>x dB</td> <td>-6.00 dB</td> </tr> </table>	Occupied Bandwidth	19.153 MHz	Total Power	23.0 dBm	Transmit Freq Error	51.205 kHz	% of OBW Power	99.00 %	x dB Bandwidth	18.82 MHz	x dB	-6.00 dB
Occupied Bandwidth	19.153 MHz	Total Power	23.0 dBm										
Transmit Freq Error	51.205 kHz	% of OBW Power	99.00 %										
x dB Bandwidth	18.82 MHz	x dB	-6.00 dB										
<p>2462 MHz</p>	<p>Center 2.46200 GHz #Res BW 100.00 kHz Span 40 MHz Sweep 3.87 ms (1001 pts)</p> <table border="1"> <tr> <td>Occupied Bandwidth</td> <td>18.938 MHz</td> <td>Total Power</td> <td>18.0 dBm</td> </tr> <tr> <td>Transmit Freq Error</td> <td>30.115 kHz</td> <td>% of OBW Power</td> <td>99.00 %</td> </tr> <tr> <td>x dB Bandwidth</td> <td>18.94 MHz</td> <td>x dB</td> <td>-6.00 dB</td> </tr> </table>	Occupied Bandwidth	18.938 MHz	Total Power	18.0 dBm	Transmit Freq Error	30.115 kHz	% of OBW Power	99.00 %	x dB Bandwidth	18.94 MHz	x dB	-6.00 dB
Occupied Bandwidth	18.938 MHz	Total Power	18.0 dBm										
Transmit Freq Error	30.115 kHz	% of OBW Power	99.00 %										
x dB Bandwidth	18.94 MHz	x dB	-6.00 dB										

Mode 9: IEEE 802.11ax 2.4 GHz 40 MHz Continuous TX Mode\_ANT-0

2422 MHz

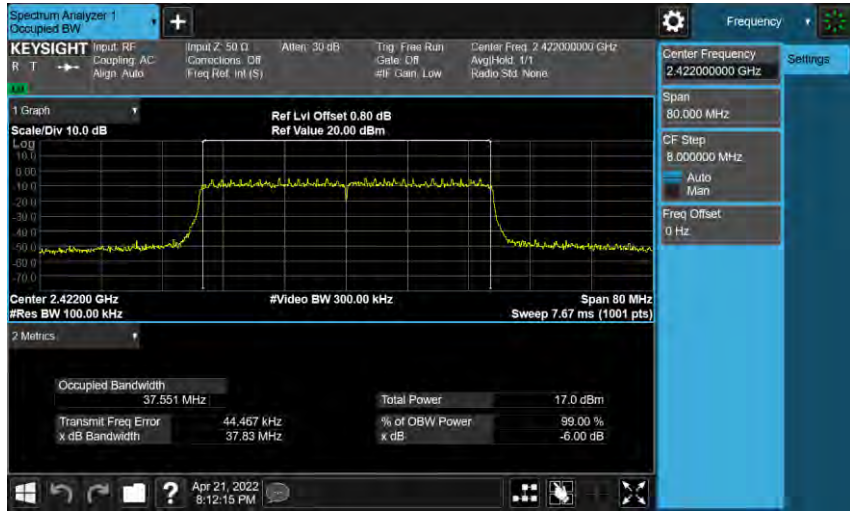

2437 MHz



2452 MHz

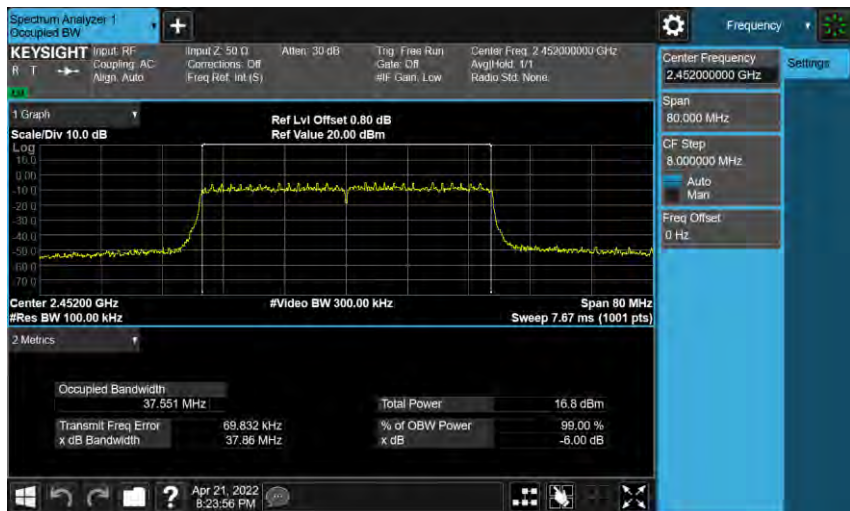



Mode 2: IEEE 802.11b Continuous TX Mode\_ANT-1

2412 MHz

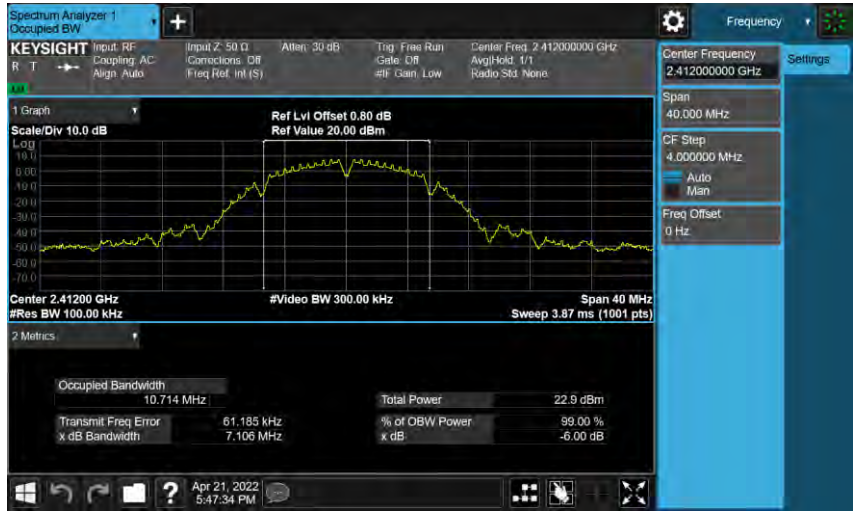

2437 MHz



2462 MHz



Mode 3: IEEE 802.11g Continuous TX Mode\_ANT-1

2412 MHz

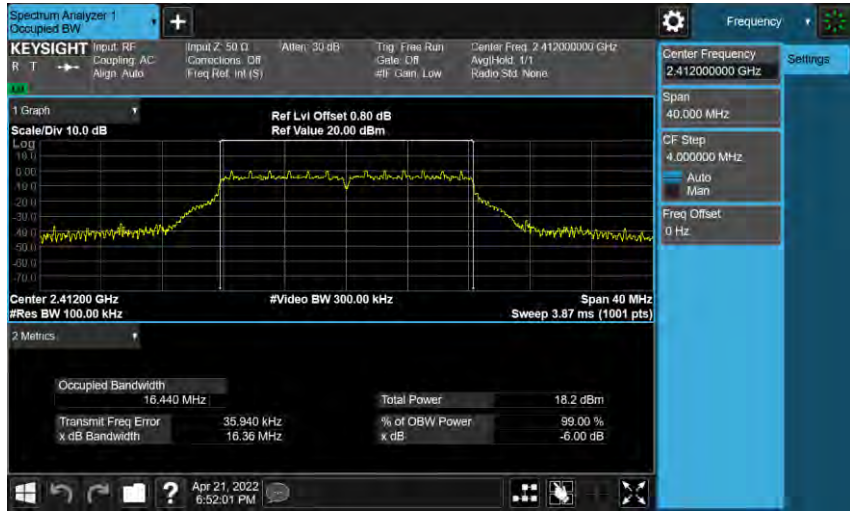

2437 MHz

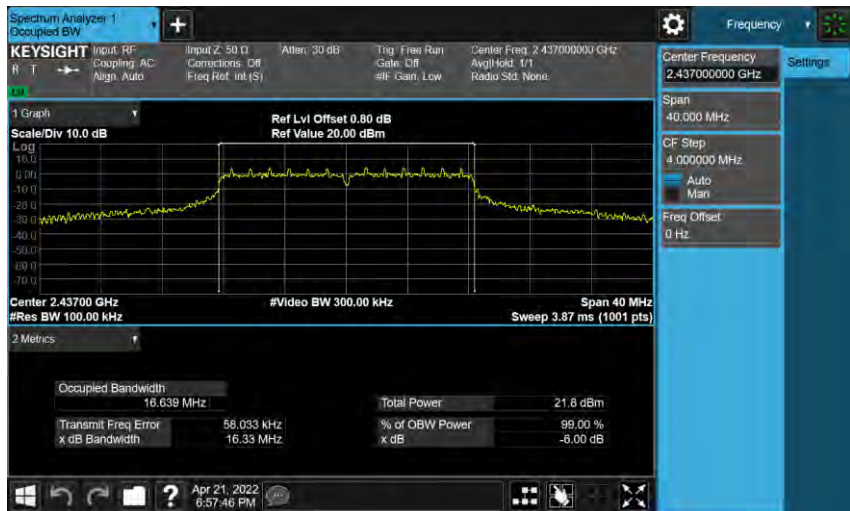

2462 MHz



Mode 8: IEEE 802.11ax 2.4 GHz 20 MHz Continuous TX Mode\_ANT-1

<p>2412 MHz</p>	<p>Center 2.41200 GHz #Res BW 100.00 kHz #Video BW 300.00 kHz Span 40 MHz Sweep 3.87 ms (1001 pts)</p> <table border="1"> <tr> <td>Occupied Bandwidth</td> <td>18.939 MHz</td> <td>Total Power</td> <td>18.0 dBm</td> </tr> <tr> <td>Transmit Freq Error</td> <td>33.966 kHz</td> <td>% of OBW Power</td> <td>99.00 %</td> </tr> <tr> <td>x dB Bandwidth</td> <td>18.97 MHz</td> <td>x dB</td> <td>-6.00 dB</td> </tr> </table>	Occupied Bandwidth	18.939 MHz	Total Power	18.0 dBm	Transmit Freq Error	33.966 kHz	% of OBW Power	99.00 %	x dB Bandwidth	18.97 MHz	x dB	-6.00 dB
Occupied Bandwidth	18.939 MHz	Total Power	18.0 dBm										
Transmit Freq Error	33.966 kHz	% of OBW Power	99.00 %										
x dB Bandwidth	18.97 MHz	x dB	-6.00 dB										
<p>2437 MHz</p>	<p>Center 2.43700 GHz #Res BW 100.00 kHz #Video BW 300.00 kHz Span 40 MHz Sweep 3.87 ms (1001 pts)</p> <table border="1"> <tr> <td>Occupied Bandwidth</td> <td>19.254 MHz</td> <td>Total Power</td> <td>22.7 dBm</td> </tr> <tr> <td>Transmit Freq Error</td> <td>58.007 kHz</td> <td>% of OBW Power</td> <td>99.00 %</td> </tr> <tr> <td>x dB Bandwidth</td> <td>18.92 MHz</td> <td>x dB</td> <td>-6.00 dB</td> </tr> </table>	Occupied Bandwidth	19.254 MHz	Total Power	22.7 dBm	Transmit Freq Error	58.007 kHz	% of OBW Power	99.00 %	x dB Bandwidth	18.92 MHz	x dB	-6.00 dB
Occupied Bandwidth	19.254 MHz	Total Power	22.7 dBm										
Transmit Freq Error	58.007 kHz	% of OBW Power	99.00 %										
x dB Bandwidth	18.92 MHz	x dB	-6.00 dB										
<p>2462 MHz</p>	<p>Center 2.46200 GHz #Res BW 100.00 kHz #Video BW 300.00 kHz Span 40 MHz Sweep 3.87 ms (1001 pts)</p> <table border="1"> <tr> <td>Occupied Bandwidth</td> <td>18.957 MHz</td> <td>Total Power</td> <td>17.7 dBm</td> </tr> <tr> <td>Transmit Freq Error</td> <td>35.840 kHz</td> <td>% of OBW Power</td> <td>99.00 %</td> </tr> <tr> <td>x dB Bandwidth</td> <td>18.93 MHz</td> <td>x dB</td> <td>-6.00 dB</td> </tr> </table>	Occupied Bandwidth	18.957 MHz	Total Power	17.7 dBm	Transmit Freq Error	35.840 kHz	% of OBW Power	99.00 %	x dB Bandwidth	18.93 MHz	x dB	-6.00 dB
Occupied Bandwidth	18.957 MHz	Total Power	17.7 dBm										
Transmit Freq Error	35.840 kHz	% of OBW Power	99.00 %										
x dB Bandwidth	18.93 MHz	x dB	-6.00 dB										

Mode 9: IEEE 802.11ax 2.4 GHz 40 MHz Continuous TX Mode\_ANT-1

2422 MHz

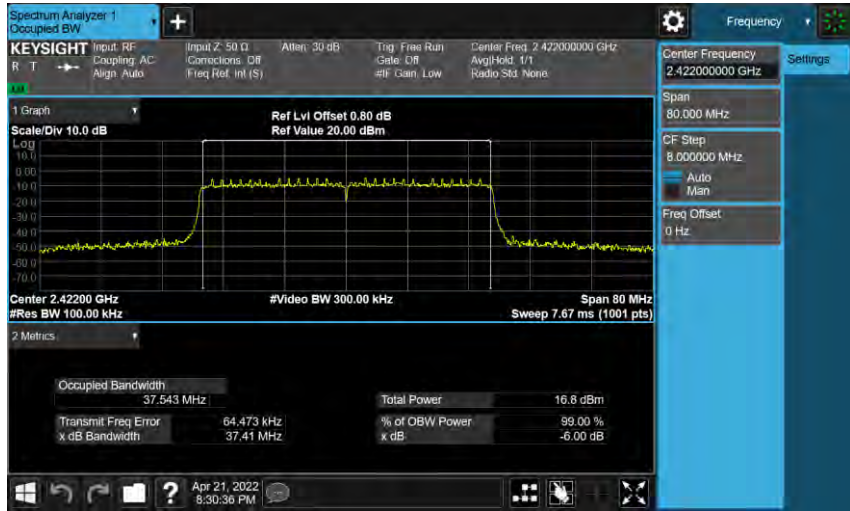

2437 MHz



2452 MHz

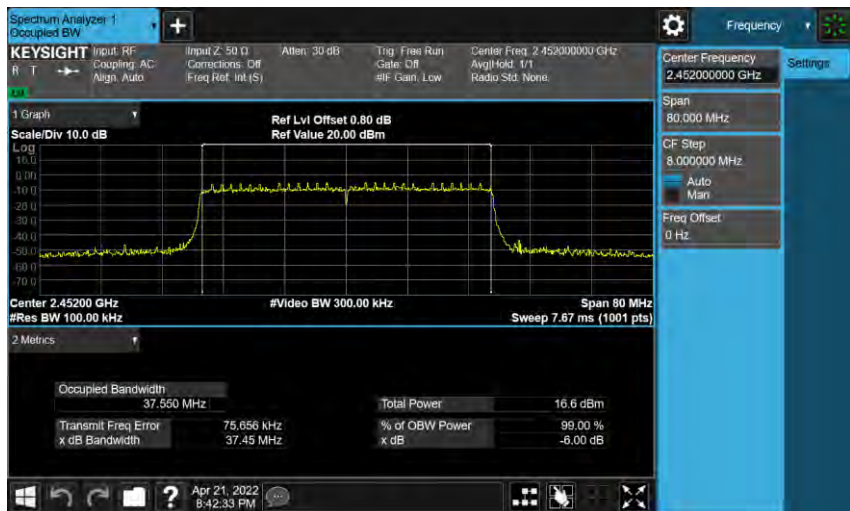

**Maximum Power Spectral Density Measurement**

Test Mode	Frequency (MHz)	Measurement (dBm/3 kHz)			Limit (dBm/ 3 kHz)
		ANT-0	ANT-1	ANT-0+1	
Mode 2	2412	-6.890	-5.870	-3.340	≤ 8
	2437	-4.870	-5.560	-2.191	≤ 8
	2462	-6.640	-5.730	-3.151	≤ 8
Mode 3	2412	-13.800	-15.140	-11.408	≤ 8
	2437	-10.570	-11.740	-8.105	≤ 8
	2462	-15.070	-15.520	-12.279	≤ 8
Mode 8	2412	-15.410	-15.460	-12.425	≤ 8
	2437	-10.850	-11.500	-8.153	≤ 8
	2462	-15.240	-16.630	-12.869	≤ 8
Mode 9	2422	-20.320	-19.360	-16.803	≤ 8
	2437	-17.570	-17.650	-14.600	≤ 8
	2452	-19.890	-20.000	-16.934	≤ 8

■ Test Graphs

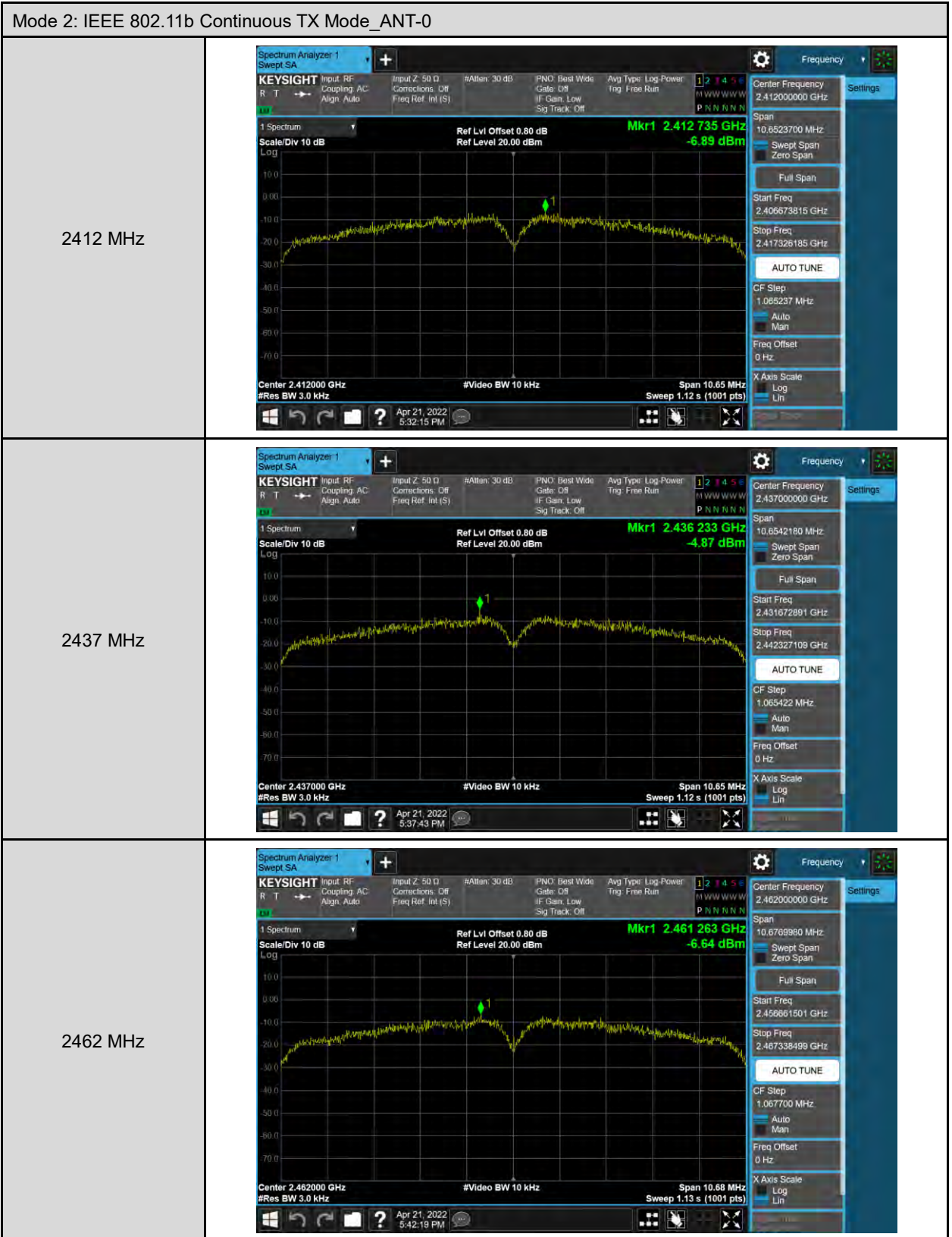

Mode 3: IEEE 802.11g Continuous TX Mode\_ANT-0

2412 MHz

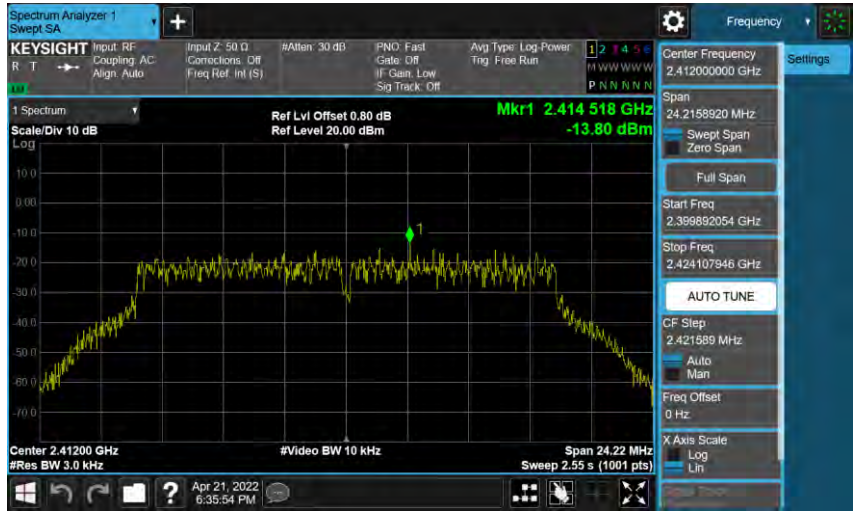

2437 MHz

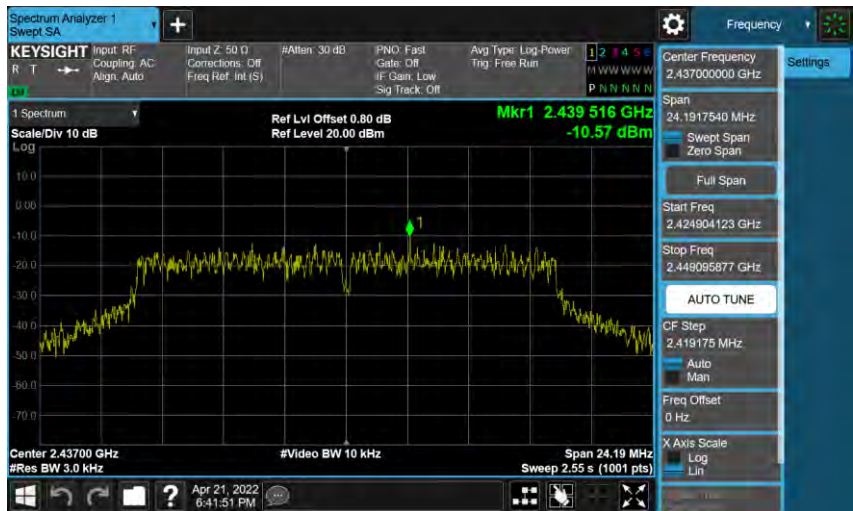

2462 MHz

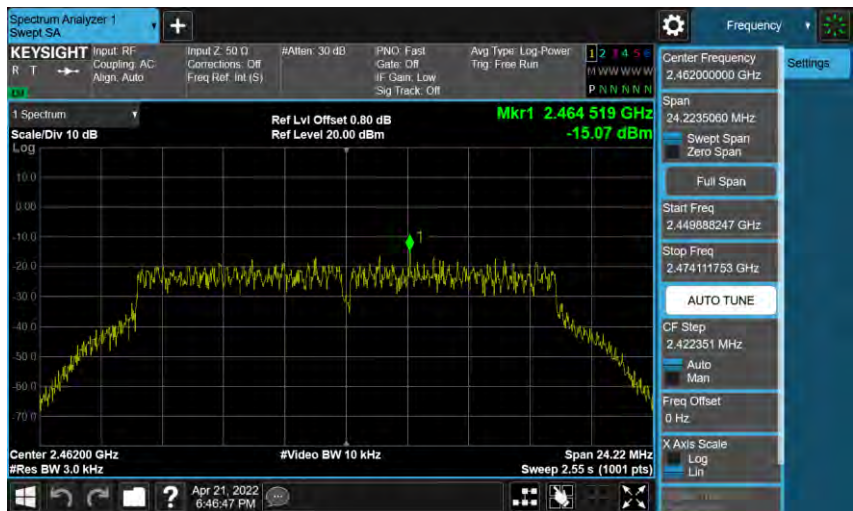

Mode 8: IEEE 802.11ax 2.4 GHz 20 MHz Continuous TX Mode\_ANT-0

2412 MHz

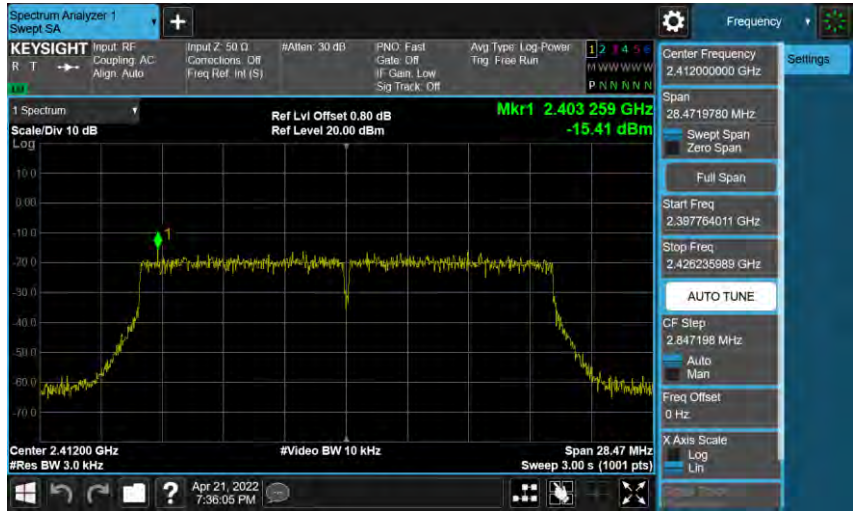

2437 MHz

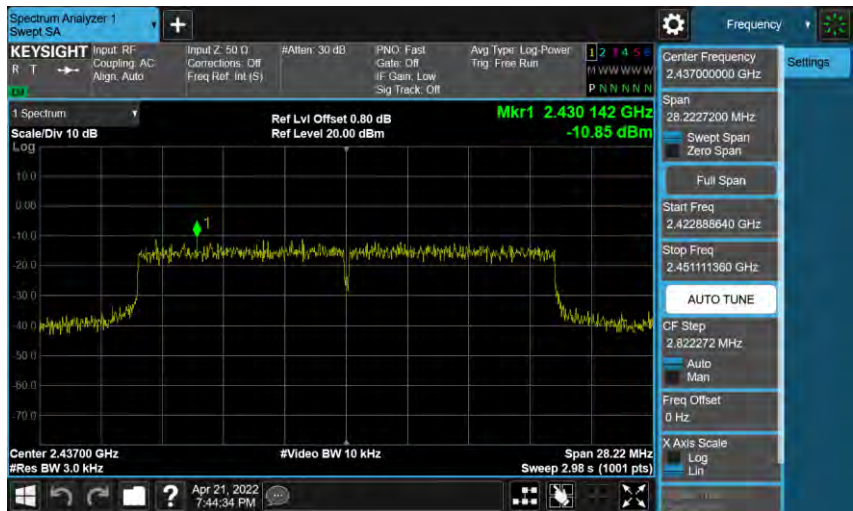

2462 MHz

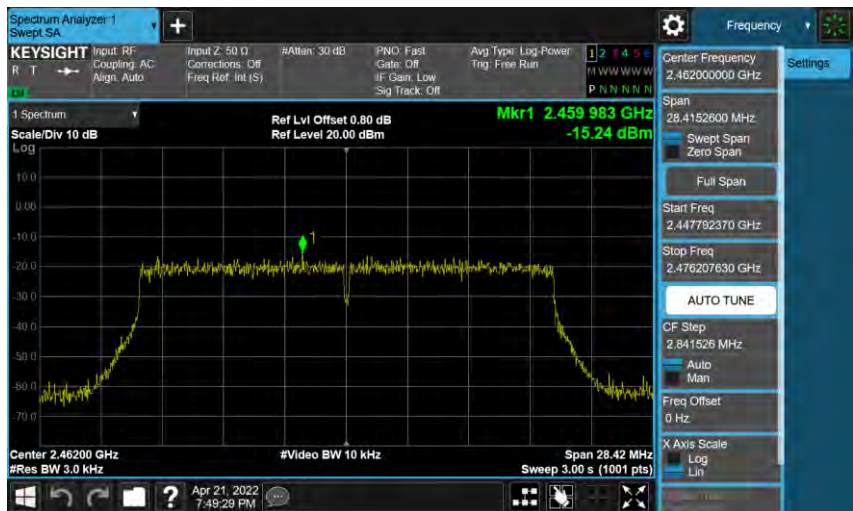



Mode 9: IEEE 802.11ax 2.4 GHz 40 MHz Continuous TX Mode\_ANT-0

2422 MHz

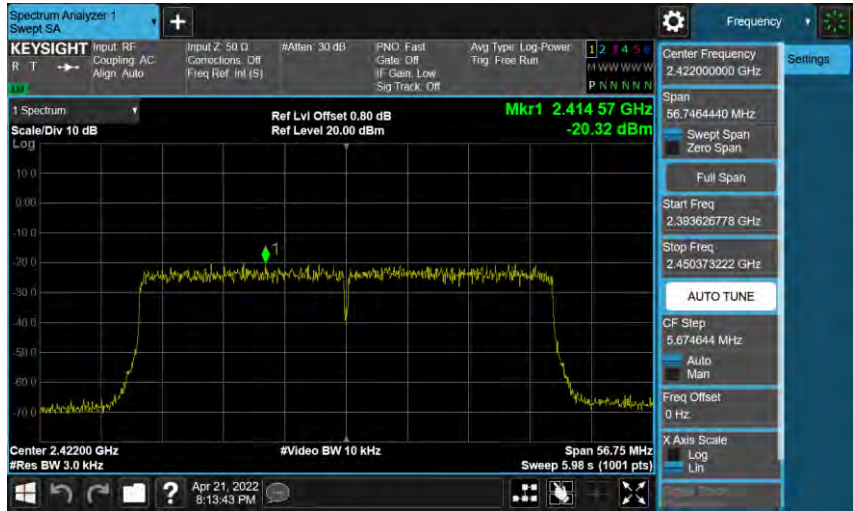

2437 MHz

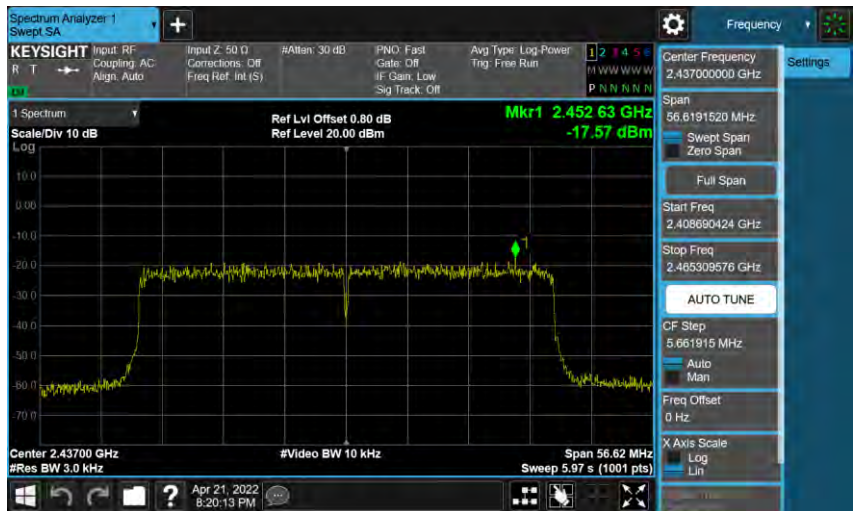

2452 MHz

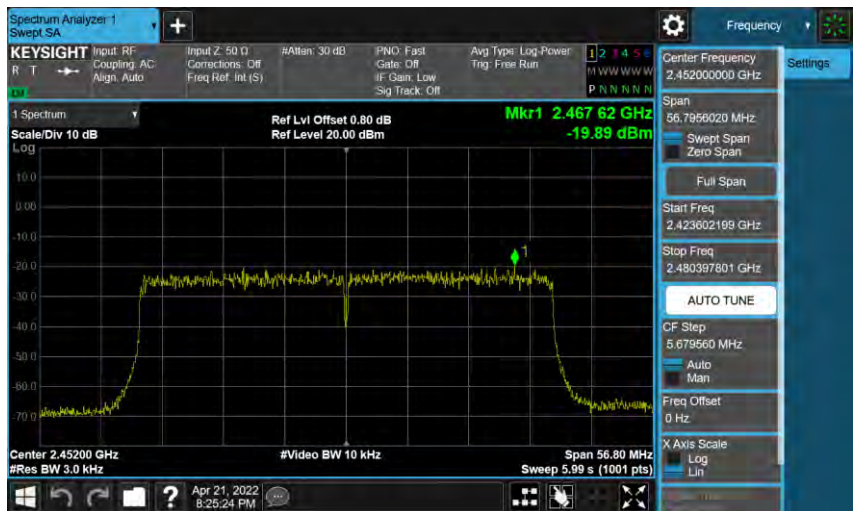

Mode 2: IEEE 802.11b Continuous TX Mode\_ANT-1

2412 MHz



2437 MHz

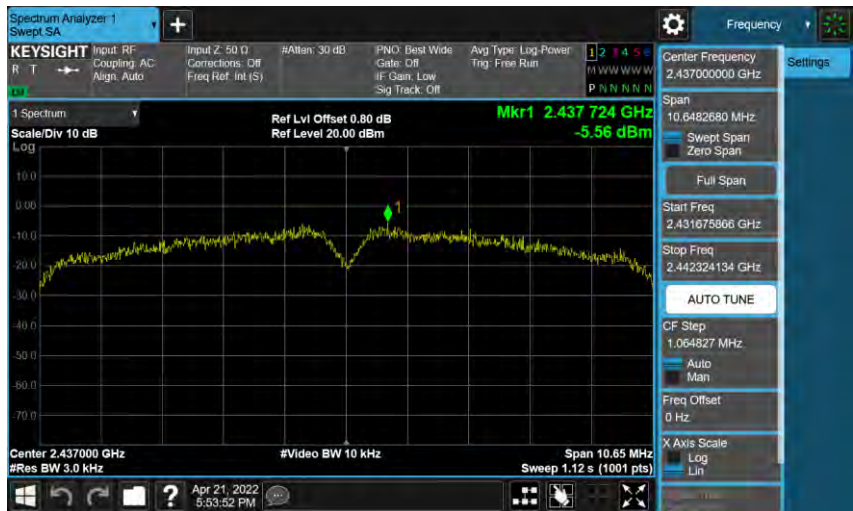

2462 MHz

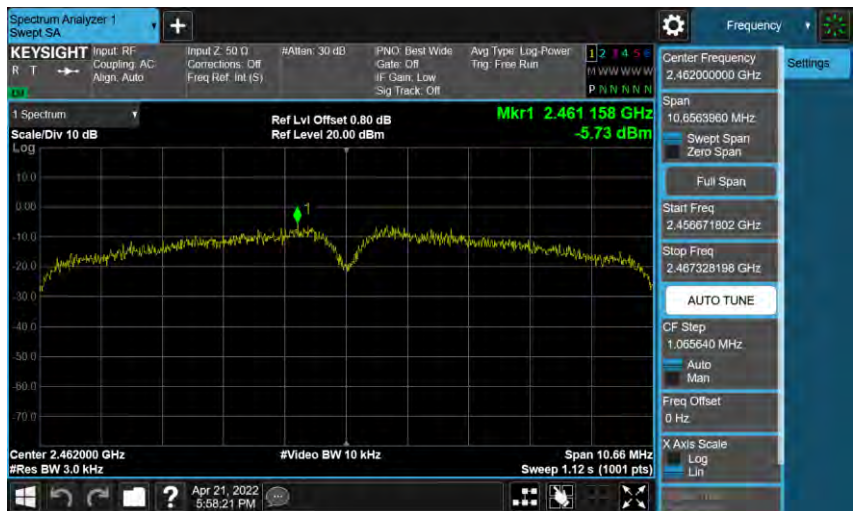

Mode 3: IEEE 802.11g Continuous TX Mode\_ANT-1

2412 MHz

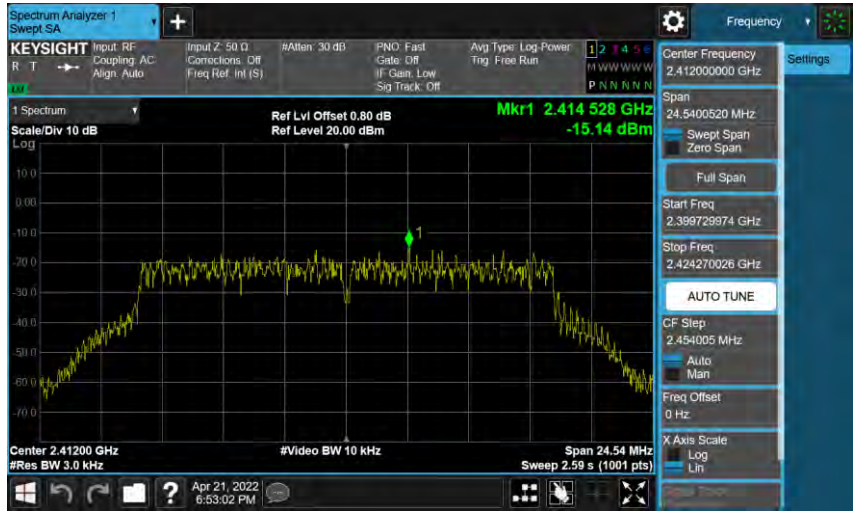

2437 MHz

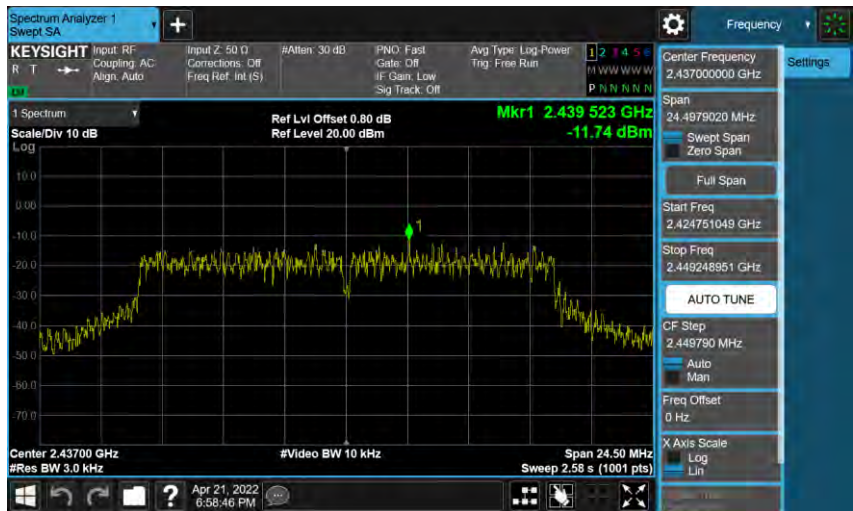

2462 MHz

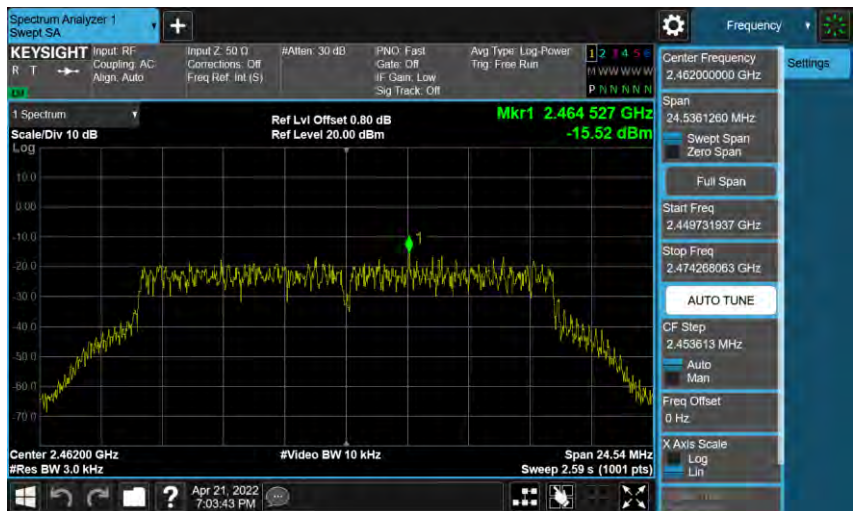

Mode 8: IEEE 802.11ax 2.4 GHz 20 MHz Continuous TX Mode\_ANT-1

2412 MHz

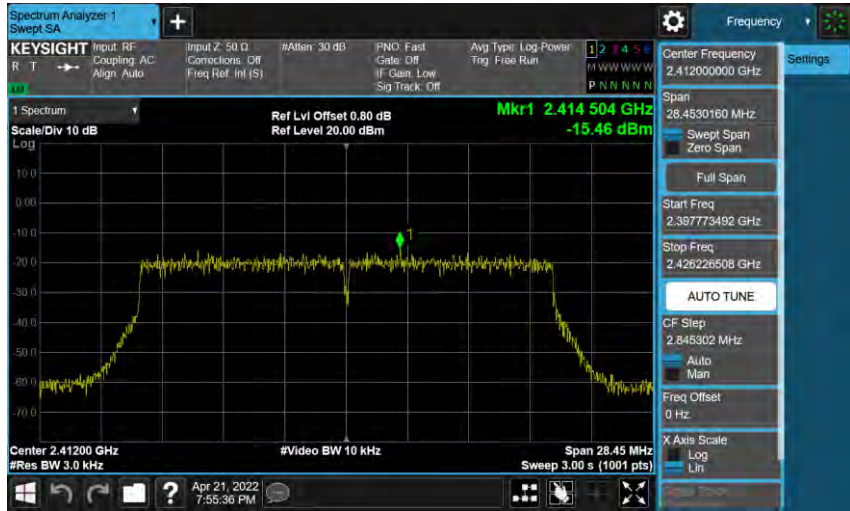

2437 MHz

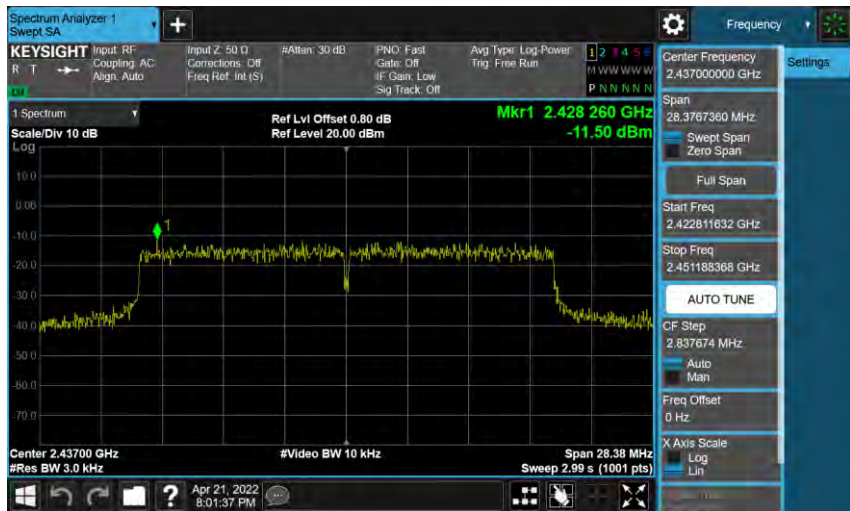

2462 MHz

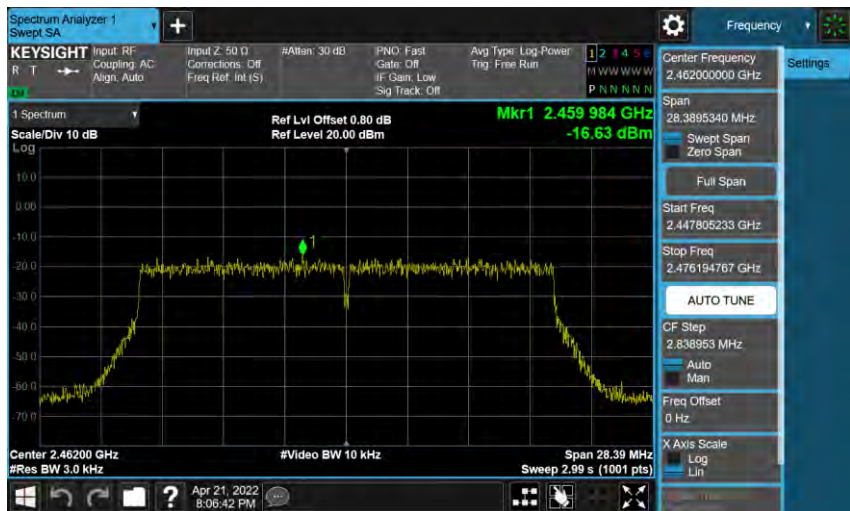

Mode 9: IEEE 802.11ax 2.4 GHz 40 MHz Continuous TX Mode\_ANT-1

2422 MHz



2437 MHz

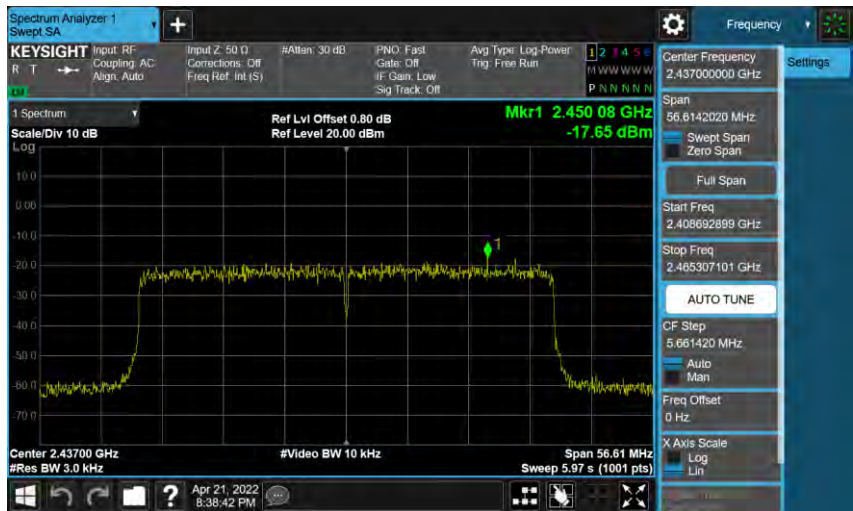

2452 MHz

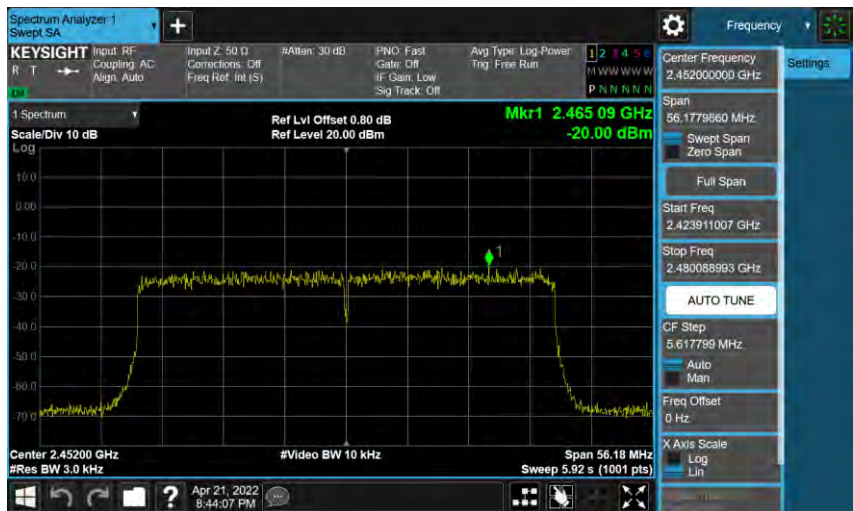

Out of Band Conducted Emissions Measurement

Reference level

Mode 2: IEEE 802.11b Continuous TX Mode_ANT-0	
2412 MHz	
2437 MHz	
2462 MHz	

Mode 3: IEEE 802.11g Continuous TX Mode\_ANT-0

2412 MHz



2437 MHz



2462 MHz

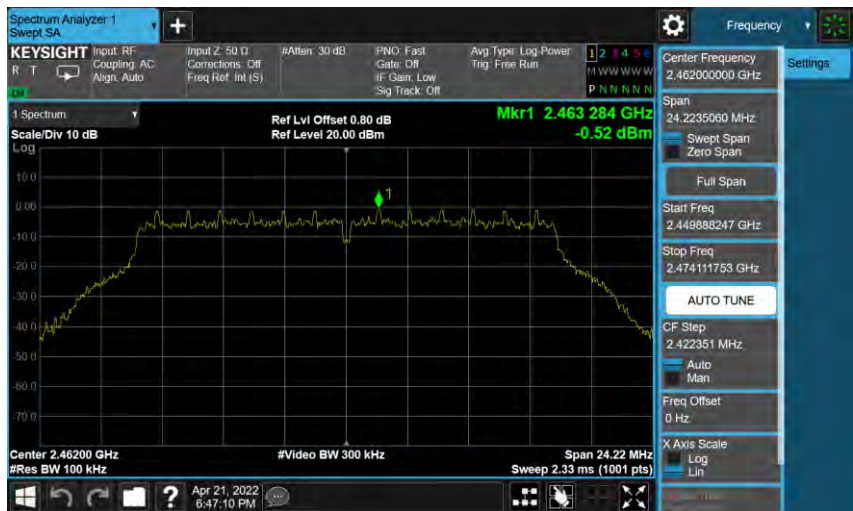

Mode 8: IEEE 802.11ax 2.4 GHz 20 MHz Continuous TX Mode\_ANT-0

2412 MHz

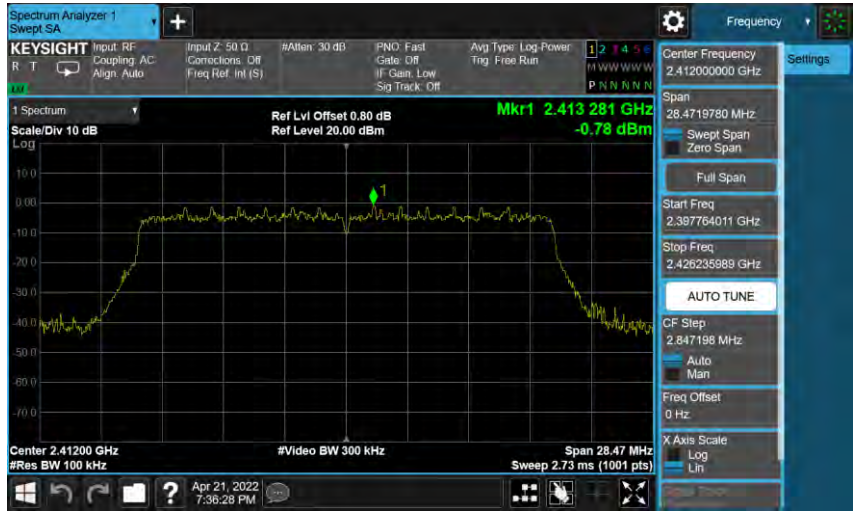

2437 MHz



2462 MHz





Mode 9: IEEE 802.11ax 2.4 GHz 40 MHz Continuous TX Mode\_ANT-0

2422 MHz



2437 MHz

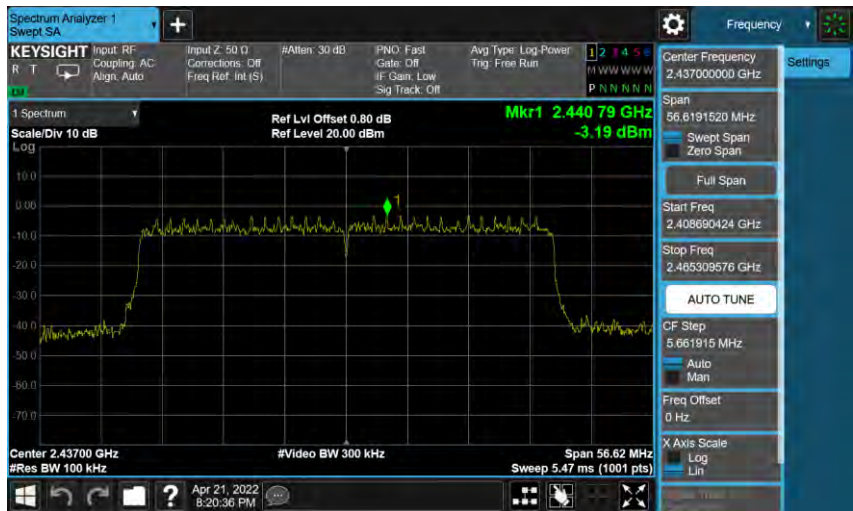

2452 MHz

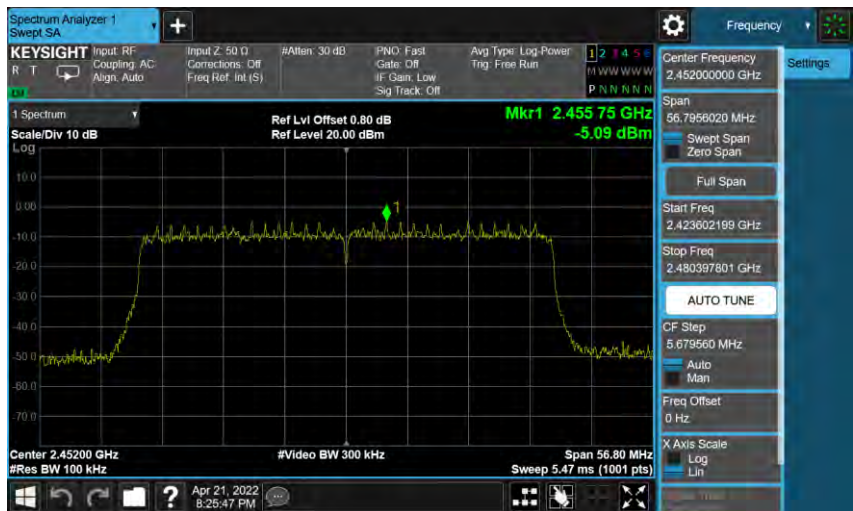

Mode 2: IEEE 802.11b Continuous TX Mode\_ANT-1

2412 MHz



2437 MHz



2462 MHz

