



# FCC RF Test Report

**APPLICANT** : Plume Design Inc  
**EQUIPMENT** : Plume Adaptive Wifi  
**BRAND NAME** : Plume Design Inc  
**MODEL NAME** : B1A  
**FCC ID** : 2AG7G-B1A  
**STANDARD** : FCC Part 15 Subpart E §15.407  
**CLASSIFICATION** : (NII) Unlicensed National Information Infrastructure

The product was received on Jan. 17, 2018 and testing was completed on Apr. 12, 2018. We, SPORTON INTERNATIONAL INC., would like to declare that the tested sample has been evaluated in accordance with the test procedures and has been in compliance with the applicable technical standards.

The test results in this report apply exclusively to the tested model / sample. Without written approval of SPORTON INTERNATIONAL INC., the test report shall not be reproduced except in full.

Reviewed by: Joseph Lin / Supervisor

Approved by: Jones Tsai / Manager



## **SPORTON INTERNATIONAL INC.**

**No. 52, Hwa Ya 1<sup>st</sup> Rd., Hwa Ya Technology Park, Kwei-Shan District, Tao Yuan City, Taiwan, R.O.C.**

SPORTON INTERNATIONAL INC.

TEL : 886-3-327-3456

FAX : 886-3-328-4978

FCC ID: 2AG7G-B1A

Page Number : 1 of 33

Report Issued Date : May 10, 2018

Report Version : Rev. 05

Report Template No.: BU5-FR15EWLAC MA Version 2.0



# TABLE OF CONTENTS

**REVISION HISTORY..... 3**

**SUMMARY OF TEST RESULT ..... 4**

**1 GENERAL DESCRIPTION ..... 5**

    1.1 Applicant ..... 5

    1.2 Manufacturer ..... 5

    1.3 Product Feature of Equipment Under Test ..... 5

    1.4 Modification of EUT ..... 5

    1.5 Testing Location ..... 6

    1.6 Applicable Standards ..... 6

**2 TEST CONFIGURATION OF EQUIPMENT UNDER TEST ..... 7**

    2.1 Carrier Frequency and Channel ..... 7

    2.2 Test Mode ..... 8

    2.3 Connection Diagram of Test System ..... 9

    2.4 Support Unit used in test configuration and system ..... 10

    2.5 EUT Operation Test Setup ..... 11

    2.6 Measurement Results Explanation Example ..... 11

**3 TEST RESULT ..... 12**

    3.1 26dB & 99% Occupied Bandwidth Measurement ..... 12

    3.2 Maximum Conducted Output Power Measurement ..... 15

    3.3 Power Spectral Density Measurement ..... 17

    3.4 Unwanted Emissions Measurement ..... 20

    3.5 AC Conducted Emission Measurement ..... 26

    3.6 Automatically Discontinue Transmission ..... 28

    3.7 Antenna Requirements ..... 29

**4 LIST OF MEASURING EQUIPMENT ..... 31**

**5 UNCERTAINTY OF EVALUATION ..... 33**

**APPENDIX A. CONDUCTED TEST RESULTS**

**APPENDIX B. AC CONDUCTED EMISSION TEST RESULT**

**APPENDIX C. RADIATED SPURIOUS EMISSION**

**APPENDIX D. RADIATED SPURIOUS EMISSION PLOTS**

**APPENDIX E. DUTY CYCLE PLOTS**

**APPENDIX F. SETUP PHOTOGRAPHS**





### SUMMARY OF TEST RESULT

| Report Section | FCC Rule           | Description                            | Limit                    | Result | Remark                                    |
|----------------|--------------------|--|--------------------------|--------|---|
| 3.1            | 2.1049 & 15.403(i) | 26dB & 99% Bandwidth                   | -                        | Pass   | -   |
| 3.2            | 15.407(a)          | Maximum Conducted Output Power         | ≤ 30 dBm for Band 1      | Pass   | -   |
| 3.3            | 15.407(a)          | Power Spectral Density                 | ≤ 17 dBm for Band 1      | Pass   | -   |
| 3.4            | 15.407(b)          | Unwanted Emissions                     | 15.407(b) & 15.209(a)    | Pass   | Under limit<br>10.46 dB at<br>0.692 MHz   |
| 3.5            | 15.207             | AC Conducted Emission                  | 15.207(a)                | Pass   | Under limit<br>1.12 dB at<br>5149.500 MHz |
| 3.6            | 15.407(c)          | Automatically Discontinue Transmission | Discontinue Transmission | Pass   | -   |
| 3.7            | 15.203 & 15.407(a) | Antenna Requirement                    | N/A                      | Pass   | -   |



# 1 General Description

## 1.1 Applicant

Plume Design Inc  
290 S California Ave, Palo Alto, CA94306

## 1.2 Manufacturer

Plume Design Inc  
290 S California Ave, Palo Alto, CA94306

## 1.3 Product Feature of Equipment Under Test

Bluetooth, Wi-Fi 2.4GHz 802.11b/g/n, and Wi-Fi 5GHz 802.11a/n/ac

| Product Specification subjective to this standard |  |
|---|--|
| Antenna Type                                      | <b>WLAN</b><br><For LB Ant.><br><Ant. 1>: IFA Antenna<br><Ant. 2>: IFA Antenna<br><For HB Ant.><br><Ant. 1>: PIFA Antenna<br><Ant. 2>: PIFA Antenna<br><Ant. 3>: IFA Antenna<br><Ant. 4>: IFA Antenna<br>Bluetooth: Slot Antenna |

## 1.4 Modification of EUT

No modifications are made to the EUT during all test items.



### 1.5 Testing Location

Sporton Lab is accredited to ISO 17025 by Taiwan Accreditation Foundation (TAF code : 1190) and the FCC designation No. TW1190 and TW0007 under the FCC 2.948(e) by Mutual Recognition Agreement (MRA) in FCC Test.

|                           |  |         |
|---------------------------|--|---------|
| <b>Test Site</b>          | SPORTON INTERNATIONAL INC.   |         |
| <b>Test Site Location</b> | No. 52, Hwa Ya 1 <sup>st</sup> Rd., Hwa Ya Technology Park,<br>Kwei-Shan District, Tao Yuan City, Taiwan, R.O.C.<br>TEL: +886-3-327-3456<br>FAX: +886-3-328-4978 |         |
| <b>Test Site No.</b>      | <b>Sporton Site No.</b>  |         |
|                           | TH05-HY  | CO05-HY |

**Note:** The test site complies with ANSI C63.4 2014 requirement.

|                           |  |  |
|---------------------------|--|--|
| <b>Test Site</b>          | SPORTON INTERNATIONAL INC.   |  |
| <b>Test Site Location</b> | No.58, Aly. 75, Ln. 564, Wenhua 3rd Rd. Guishan Dist,<br>Taoyuan City, Taiwan (R.O.C.)<br>TEL: +886-3-327-0868<br>FAX: +886-3-327-0855 |  |
| <b>Test Site No.</b>      | <b>Sporton Site No.</b>  |  |
|                           | 03CH11-HY  |  |

**Note:** The test site complies with ANSI C63.4 2014 requirement.

### 1.6 Applicable Standards

According to the specifications of the manufacturer, the EUT must comply with the requirements of the following standards:

- FCC Part 15 Subpart E
- FCC KDB 789033 D02 General UNII Test Procedures New Rules v02r01.
- FCC KDB 662911 D01 Multiple Transmitter Output v02r01.
- ANSI C63.10-2013

**Remark:**

1. All test items were verified and recorded according to the standards and without any deviation during the test.
2. This EUT has also been tested and complied with the requirements of FCC Part 15, Subpart B, recorded in a separate test report.



## 2 Test Configuration of Equipment Under Test

- a. The EUT has been associated with peripherals and configuration operated in a manner tended to maximize its emission characteristics in a typical application. Frequency range investigated: conduction emission (150 kHz to 30 MHz), radiation emission (9 kHz to the 10th harmonic of the highest fundamental frequency or to 40 GHz, whichever is lower). For radiated measurement, pre-scanned in three orthogonal panels, X, Y, Z. The worst cases (Z plane) were recorded in this report.
- b. AC power line Conducted Emission was tested under maximum output power.

### 2.1 Carrier Frequency and Channel

| Frequency Band                       | Channel | Freq. (MHz) | Channel | Freq. (MHz) |
|--------------------------------------|---------|-------------|---------|-------------|
| 5150-5250 MHz<br>Band 1<br>(U-NII-1) | 36      | 5180        | 44      | 5220        |
|                                      | 38*     | 5190        | 46*     | 5230        |
|                                      | 40      | 5200        | 48      | 5240        |
|                                      | 42#     | 5210        |         |             |

**Note:**

1. The above Frequency and Channel in "\*" were 802.11n HT40 and 802.11ac VHT40.
2. The above Frequency and Channel in "#" were 802.11ac VHT80.



## 2.2 Test Mode

Final test modes are considering the modulation and worse data rates as below table.

### Single Mode

| Modulation                      | Data Rate |
|---------------------------------|-----------|
| 802.11a                         | 6 Mbps    |
| 802.11n HT20 (Covered by VHT20) | MCS0      |
| 802.11n HT40 (Covered by VHT40) | MCS0      |
| 802.11ac VHT20                  | MCS0      |
| 802.11ac VHT40                  | MCS0      |
| 802.11ac VHT80                  | MCS0      |

### MIMO Mode

| Modulation                      | Data Rate |
|---------------------------------|-----------|
| 802.11a                         | 6 Mbps    |
| 802.11n HT20 (Covered by VHT20) | MCS0      |
| 802.11n HT40 (Covered by VHT40) | MCS0      |
| 802.11ac VHT20                  | MCS0      |
| 802.11ac VHT40                  | MCS0      |
| 802.11ac VHT80                  | MCS0      |

### TXBF Mode

| Modulation                      | Data Rate |
|---------------------------------|-----------|
| 802.11n HT20 (Covered by VHT20) | MCS0      |
| 802.11n HT40 (Covered by VHT40) | MCS0      |
| 802.11ac VHT20                  | MCS0      |
| 802.11ac VHT40                  | MCS0      |
| 802.11ac VHT80                  | MCS0      |

| Test Cases                  |  |
|-----------------------------|--|
| AC<br>Conducted<br>Emission | Mode 1 : WLAN (5GHz) Link + Bluetooth Idle + Lan 1 Link + Lan 2 Link |



| Ch. # |        | Band I : 5150-5250 MHz |                |                |                |
|-------|--------|------------------------|----------------|----------------|----------------|
|       |        | 802.11a                | 802.11ac VHT20 | 802.11ac VHT40 | 802.11ac VHT80 |
| L     | Low    | 36                     | 36             | 38             | -              |
| M     | Middle | 44                     | 44             | -              | 42             |
| H     | High   | 48                     | 48             | 46             | -              |

### 2.3 Connection Diagram of Test System

<AC Conducted Emission>

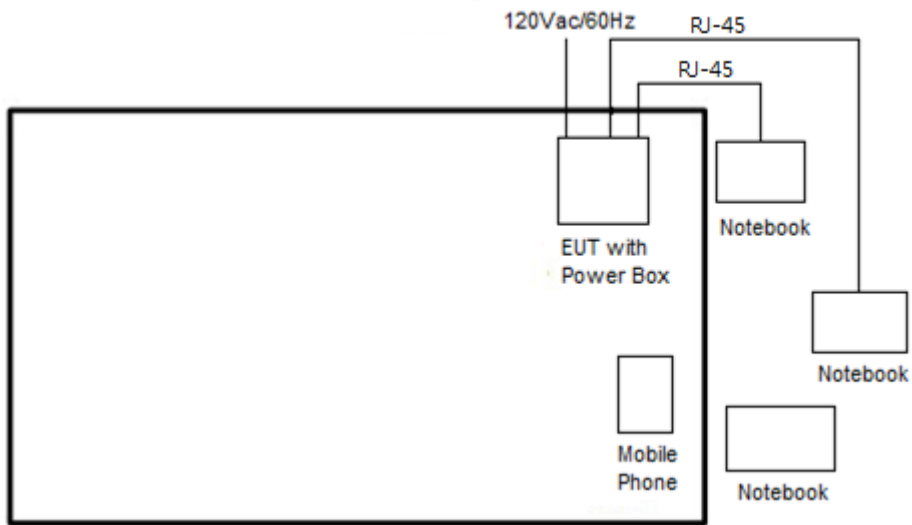

<Radiated Spurious Emission>

<CDD Mode>

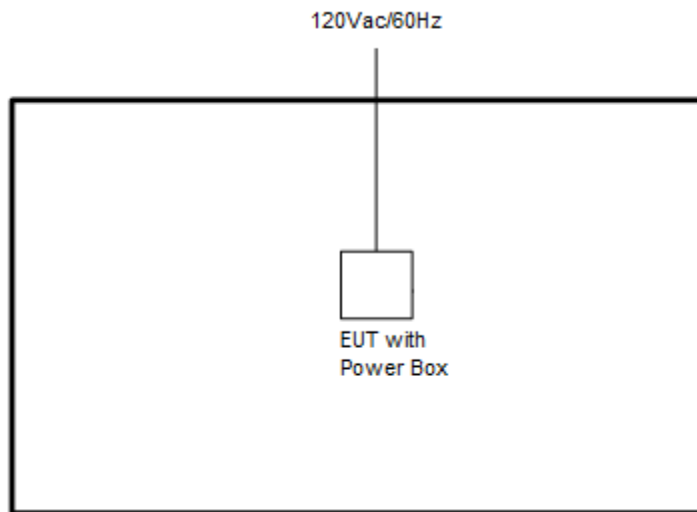

<TXBF Mode>

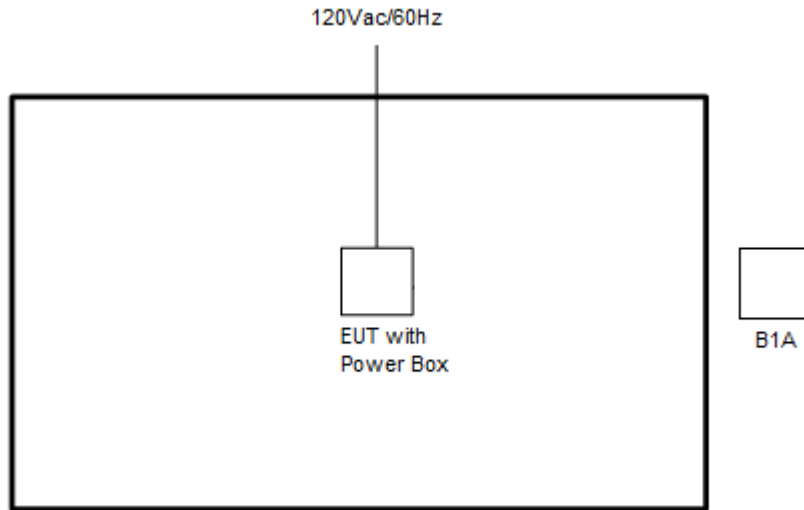

## 2.4 Support Unit used in test configuration and system

| Item | Equipment    | Trade Name | Model Name     | FCC ID                                       | Data Cable | Power Cord   |
|------|--------------|------------|----------------|--|------------|--|
| 1.   | Notebook     | DELL       | Latitude E6320 | FCC DoC/<br>Contains FCC ID:<br>QDS-BRCM1054 | N/A        | AC I/P:<br>Unshielded, 1.2 m<br>DC O/P:<br>Shielded, 1.8 m |
| 2.   | Notebook     | DELL       | Latitude E3340 | FCC DoC/<br>Contains FCC ID:<br>PD97260NGU   | N/A        | AC I/P:<br>Unshielded, 1.2 m<br>DC O/P:<br>Shielded, 1.8 m |
| 3.   | Mobile Phone | Apple      | A1687          | BCG-E2944A                                   | N/A        | N/A  |



## 2.5 EUT Operation Test Setup

The RF test items, utility “QSPR” was installed in Notebook which was programmed in order to make the EUT get into the engineering modes to provide channel selection, power level, data rate and the application type and for continuous transmitting signals.

For TXBF mode, the EUT was tested under normal operation and link to another EUT with power, modulation modes and data rates controlled by engineer mode command lines. The “QSPR” software tool was used to make EUT continuous transmitting signals.

## 2.6 Measurement Results Explanation Example

**For all conducted test items:**

The offset level is set in the spectrum analyzer to compensate the RF cable loss and attenuator factor between EUT conducted output port and spectrum analyzer. With the offset compensation, the spectrum analyzer reading level is exactly the EUT RF output level.

Example :

The spectrum analyzer offset is derived from RF cable loss and attenuator factor.

*Offset = RF cable loss + attenuator factor.*

Following shows an offset computation example with cable loss 4.2 dB and 10dB attenuator.

$$\begin{aligned} \text{Offset(dB)} &= \text{RF cable loss(dB)} + \text{attenuator factor(dB)}. \\ &= 4.2 + 10 = 14.2 \text{ (dB)} \end{aligned}$$

### 3 Test Result

#### 3.1 26dB & 99% Occupied Bandwidth Measurement

##### 3.1.1 Description of 26dB & 99% Occupied Bandwidth

This section is for reporting purpose only.

There is no restriction limits for bandwidth.

##### 3.1.2 Measuring Instruments

The measuring equipment is listed in the section 4 of this test report.

##### 3.1.3 Test Procedures

1. The testing follows FCC KDB 789033 D02 General UNII Test Procedures New Rules v02r01. Section C) Emission bandwidth
2. Set RBW = approximately 1% of the emission bandwidth.
3. Set the VBW > RBW.
4. Detector = Peak.
5. Trace mode = max hold
6. Measure the maximum width of the emission that is 26 dB down from the peak of the emission. Compare this with the RBW setting of the analyzer. Readjust RBW and repeat measurement as needed until the RBW/EBW ratio is approximately 1%.
7. For 99% Bandwidth Measurement, the spectrum analyzer's resolution bandwidth (RBW) is set 1MHz and set the Video bandwidth (VBW)  $\geq 3 * RBW$ .
8. Measure and record the results in the test report.

##### 3.1.4 Test Setup

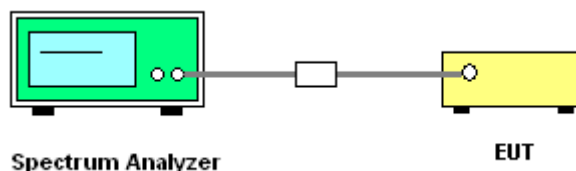

##### 3.1.5 Test Result of 26dB & 99% Occupied Bandwidth

Please refer to Appendix A.



<CDD Mode>

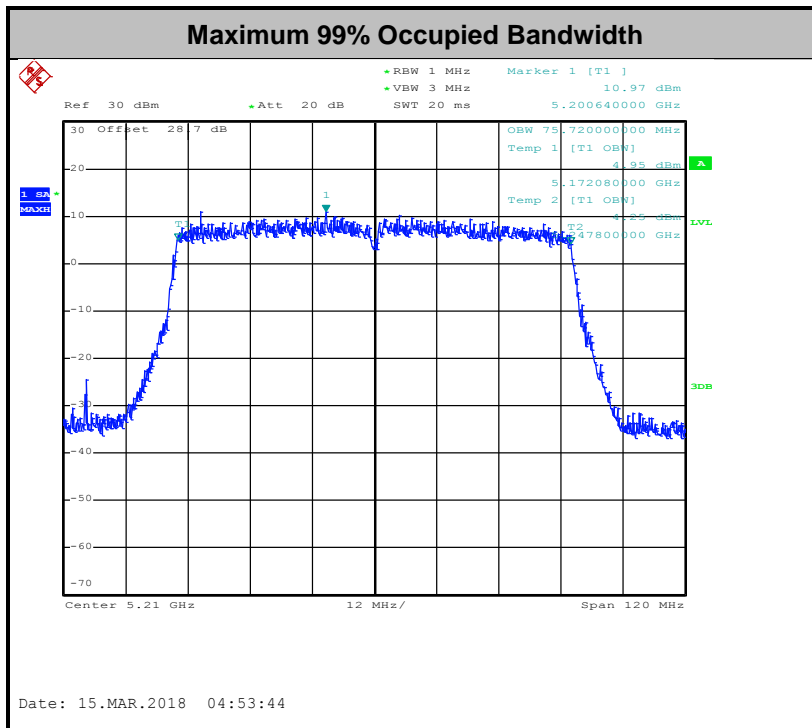
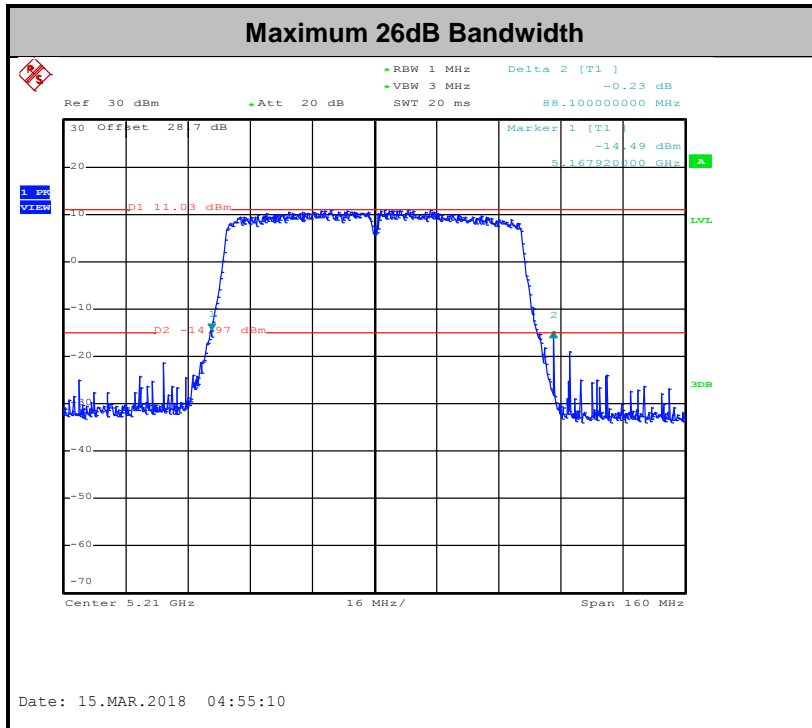

**Note:** The occupied channel bandwidth is maintained within the band of operation for all of the modulations.



<TXBF Modes>

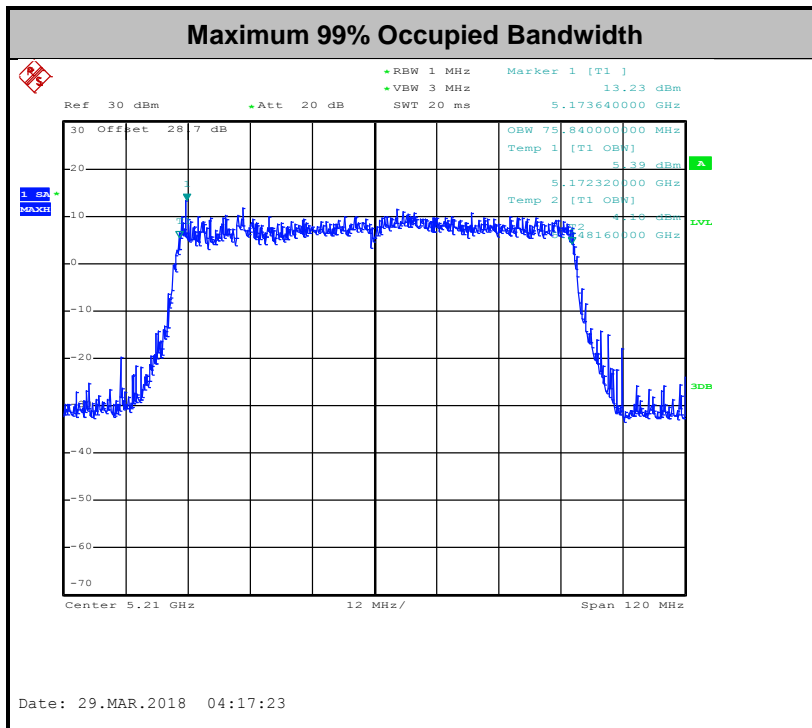
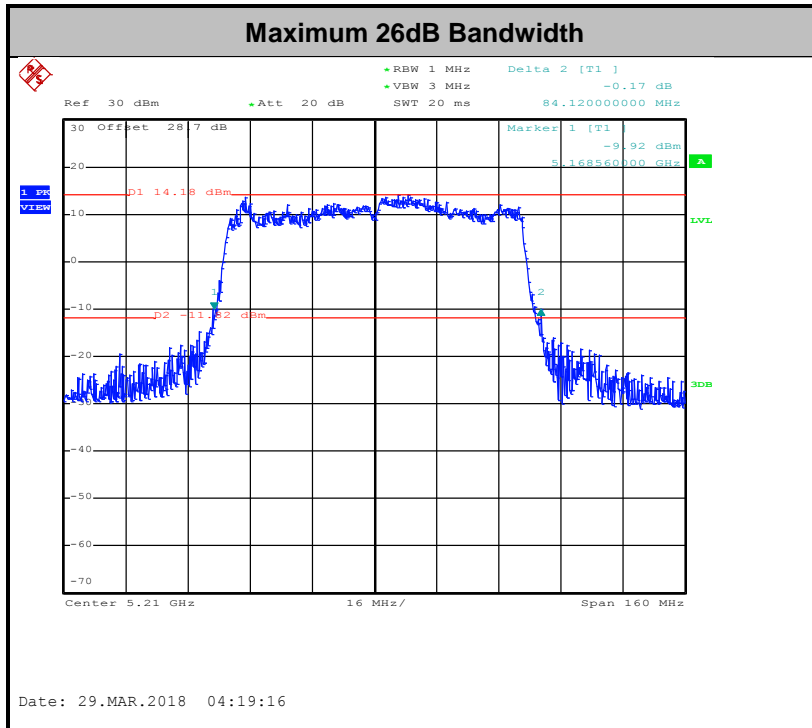

**Note:** The occupied channel bandwidth is maintained within the band of operation for all of the modulations.



## 3.2 Maximum Conducted Output Power Measurement

### 3.2.1 Limit of Maximum Conducted Output Power

#### <FCC 14-30 CFR 15.407>

For mobile and portable client devices in the 5.15–5.25 GHz band, the maximum conducted output power over the frequency band of operation shall not exceed 250 mW.

If transmitting antennas of directional gain greater than 6 dBi are used, the peak output power shall be reduced by the amount in dB that the directional gain of the antenna exceeds 6 dBi.

Note that U-NII-2 band, devices with a maximum e.i.r.p. greater than 500 mW shall implement TPC in order to have the capability to operate at least 6 dB below the maximum permitted e.i.r.p. of 1 W.

### 3.2.2 Measuring Instruments

The measuring equipment is listed in the section 4 of this test report.

### 3.2.3 Test Procedures

#### <CDD Modes>

The testing follows Method PM of FCC KDB 789033 D02 General UNII Test Procedures New Rules v02r01.

Method PM (Measurement using an RF average power meter):

1. Measurement is performed using a wideband RF power meter.
2. The EUT is configured to transmit continuously with a consistent duty cycle at its maximum power control level.
3. Measure the average power of the transmitter, and the average power is corrected with duty factor,  $10 \log(1/x)$ , where x is the duty cycle.

#### <TXBF Modes>

The testing follows Method PM-G of FCC KDB 789033 D02 General UNII Test Procedures New Rules v02r01 for TXBF modes.

Method PM-G (Measurement using a gated RF average power meter):

1. Measurement is performed using a wideband RF power meter.
2. The EUT is configured to transmit at its maximum power control level.
3. Measure the average power of the transmitter
4. Since the measurement is made only during the ON time of the transmitter, no duty cycle correction factor is required.

### 3.2.4 Test Setup

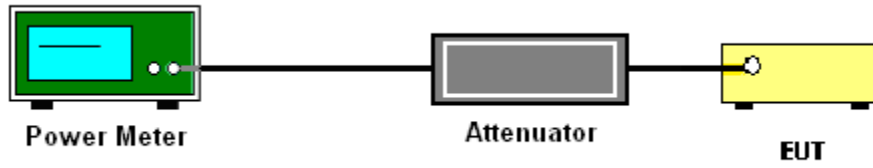

### 3.2.5 Test Result of Maximum Conducted Output Power

Please refer to Appendix A.





### 3.3 Power Spectral Density Measurement

#### 3.3.1 Limit of Power Spectral Density

For an indoor access point operating in the band 5.15-5.25 GHz, the maximum power spectral density shall not exceed 17 dBm in any 1 megahertz band.

If transmitting antennas of directional gain greater than 6 dBi are used, the peak output power shall be reduced by the amount in dB that the directional gain of the antenna exceeds 6 dBi.

#### 3.3.2 Measuring Instruments

The measuring equipment is listed in the section 4 of this test report.

#### 3.3.3 Test Procedures

The testing follows FCC KDB 789033 D02 General UNII Test Procedures New Rules v02r01. Section F) Maximum power spectral density.

##### <CDD Modes>

##### # Method SA-2 #

(trace averaging across on and off times of the EUT transmissions, followed by duty cycle correction).

- Measure the duty cycle.
- Set span to encompass the entire emission bandwidth (EBW) of the signal.
- Set RBW = 1 MHz.
- Set VBW  $\geq$  3 MHz.
- Number of points in sweep  $\geq$  2 Span / RBW.
- Sweep time = auto.
- Detector = RMS
- Trace average at least 100 traces in power averaging mode.
- Add  $10 \log(1/x)$ , where x is the duty cycle, to the measured power in order to compute the average power during the actual transmission times. For example, add  $10 \log(1/0.25) = 6$  dB if the duty cycle is 25 percent.

**<TXBF Modes>****# Method SA-3 #**

(power averaging (rms) detection with max hold):

- Set span to encompass the entire emission bandwidth (EBW) of the signal.
  - Set RBW = 1 MHz.
  - Set VBW  $\geq$  3 MHz
  - Number of points in sweep  $\geq$  2 Span / RBW.
  - Sweep time  $\leq$  (number of points in sweep)  $\times$  T, when duty cycle is less than 98 percent where T is the minimum transmission duration over which the transmitter is on and is transmitting at its maximum power control level for the tested mode of operation.
  - Detector = power averaging (rms).
  - Trace mode = max hold.
  - Allow max hold to run for at least 60 seconds, or longer as needed to allow the trace to stabilize.
1. The RF output of EUT was connected to the spectrum analyzer by a low loss cable.
  2. Each plot has already offset with cable loss, and attenuator loss. Measure the PPSD and record it.
  3. For MIMO mode, calculation method follows FCC KDB 662911 D01 Multiple Transmitter Output v02r01.

Method (a): Measure and sum the spectra across the outputs.

The total final Power Spectral Density is from a device with 2 transmitter outputs. The spectrum measurements of the individual outputs are all performed with the same span and number of points, the spectrum value in the first spectral bin of output 1 is summed with that in the first spectral bin of output 2 to obtain the value for the first frequency bin of the summed spectrum.

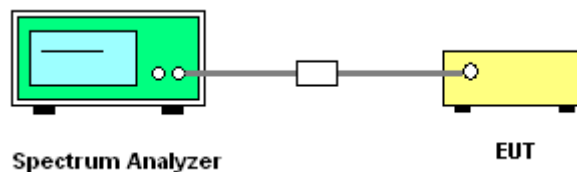
**3.3.4 Test Setup****3.3.5 Test Result of Power Spectral Density**

Please refer to Appendix A.



<CDD Modes>

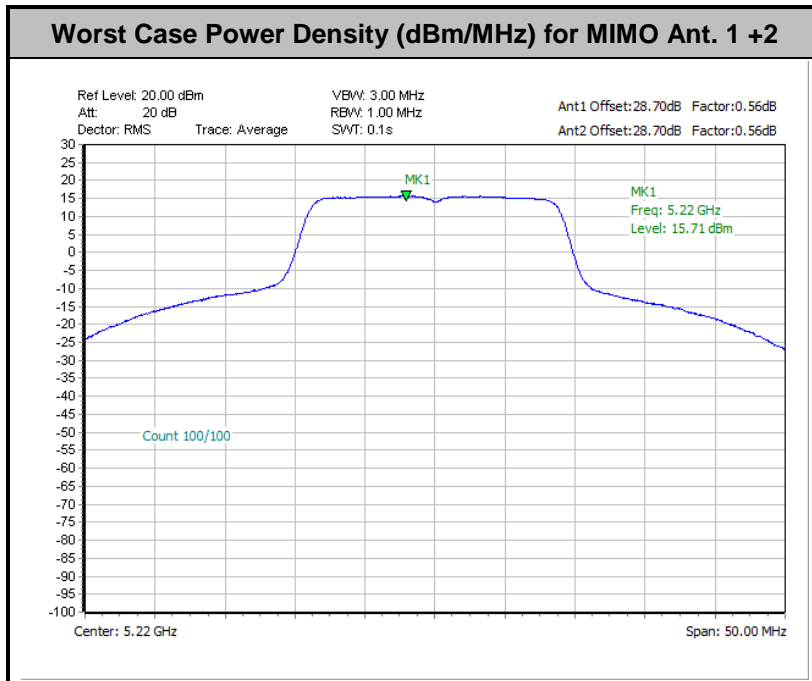

Note: Average Power Density (dB) = Measured value+ Duty Factor

<TXBF Modes>

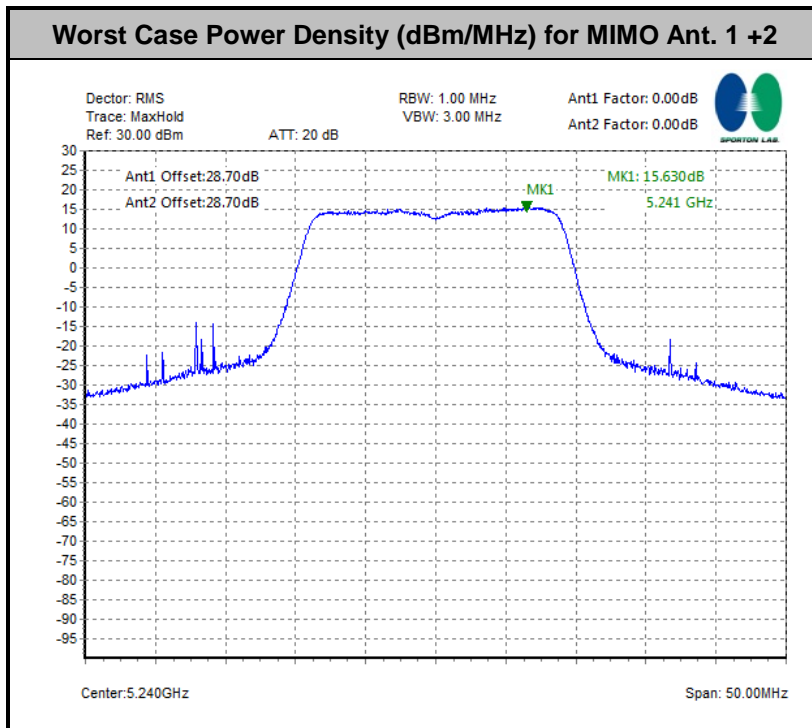

Note: Average Power Density (dB) = Measured value+ Duty Factor



### 3.4 Unwanted Emissions Measurement

This section is to measure unwanted emissions through radiated measurement for band edge spurious emissions and out of band emissions measurement.

#### 3.4.1 Limit of Unwanted Emissions

- (1) For transmitters operating in the 5150-5250 MHz band: all emissions outside of the 5150-5350 MHz band shall not exceed an EIRP of -27dBm/MHz.
- (2) Unwanted spurious emissions fallen in restricted bands shall comply with the general field strength limits as below table

| Frequency (MHz) | Field Strength (microvolts/meter) | Measurement Distance (meters) |
|-----------------|-----------------------------------|-------------------------------|
| 0.009 – 0.490   | 2400/F(kHz)                       | 300                           |
| 0.490 – 1.705   | 24000/F(kHz)                      | 30                            |
| 1.705 – 30.0    | 30                                | 30                            |
| 30 – 88         | 100                               | 3                             |
| 88 – 216        | 150                               | 3                             |
| 216 - 960       | 200                               | 3                             |
| Above 960       | 500                               | 3                             |

**Note:** The following formula is used to convert the EIRP to field strength.

$$E = \frac{1000000\sqrt{30P}}{3} \mu\text{V/m, where P is the eirp (Watts)}$$

| EIRP (dBm) | Field Strength at 3m (dBμV/m) |
|------------|-------------------------------|
| -17        | 78.3                          |
| - 27       | 68.3                          |



(3) KDB789033 D02 v02r01 G)2)c)

- (i) Section 15.407(b)(1) to (b)(3) specify the unwanted emission limits for the U-NII-1 and U-NII-2 bands. As specified, emissions above 1000 MHz that are outside of the restricted bands are subject to a peak emission limit of -27 dBm/MHz.<sup>3</sup>
- (ii) Section 15.407(b)(4) specifies the unwanted emission limit for the U-NII-3 band. A band emissions mask is specified in Section 15.407(b)(4)(i). The emission limits are in terms of a Peak detector. An alternative to the band emissions mask is specified in Section 15.407(b)(4)(ii). The alternative limits are based on the highest antenna gain specified in the filing. There are also marketing and importation restrictions for the devices using the alternative limit.<sup>4</sup>

**Note 3:** An out-of-band emission that complies with both the average and peak limits of Section 15.209 is not required to satisfy the -27 dBm/MHz peak emission limit.

**Note 4:** Only devices with antenna gains of 10 dBi or less may be approved using the emission limits specified in Section 15.247(d) till March 2, 2018; all other devices operating in this band must use the mask specified in Section 15.407(b)(4)(i).

### 3.4.2 Measuring Instruments

The measuring equipment is listed in the section 4 of this test report.



### 3.4.3 Test Procedures

1. The testing follows FCC KDB 789033 D02 General UNII Test Procedures New Rules v02r01. Section G) Unwanted emissions measurement.
  - (1) Procedure for Unwanted Emissions Measurements Below 1000MHz
    - RBW = 120 kHz
    - VBW = 300 kHz
    - Detector = Peak
    - Trace mode = max hold
  - (2) Procedure for Peak Unwanted Emissions Measurements Above 1000 MHz
    - RBW = 1 MHz
    - VBW  $\geq$  3 MHz
    - Detector = Peak
    - Sweep time = auto
    - Trace mode = max hold
  - (3) Procedures for Average Unwanted Emissions Measurements Above 1000MHz
    - RBW = 1 MHz
    - VBW = 10 Hz, when duty cycle is no less than 98 percent.
    - VBW  $\geq$  1/T, when duty cycle is less than 98 percent where T is the minimum transmission duration over which the transmitter is on and is transmitting at its maximum power control level for the tested mode of operation.
2. The EUT was placed on a turntable with 0.8 meter for frequency below 1GHz and 1.5 meter for frequency above 1GHz respectively above ground.
3. The EUT was set 3 meters from the interference receiving antenna which was mounted on the top of a variable height antenna tower.
4. The antenna is a broadband antenna and its height is adjusted between one meter and four meters above ground to find the maximum value of the field strength for both horizontal polarization and vertical polarization of the antenna.
5. For each suspected emission, the EUT was arranged to its worst case and then adjust the antenna tower (from 1 m to 4 m) and turntable (from 0 degree to 360 degrees) to find the maximum reading.
6. For testing below 1GHz, if the emission level of the EUT in peak mode was 3 dB lower than the limit specified, then peak values of EUT will be reported, otherwise, the emissions will be repeated one by one using the CISPR quasi-peak method and reported.

- 7. For testing above 1GHz, the emission level of the EUT in peak mode was 20dB lower than average limit (that means the emission level in average mode also complies with the limit in average mode), then peak values of EUT will be reported, otherwise, the emissions will be measured in average mode again and reported.

### 3.4.4 Test Setup

For radiated emissions below 30MHz

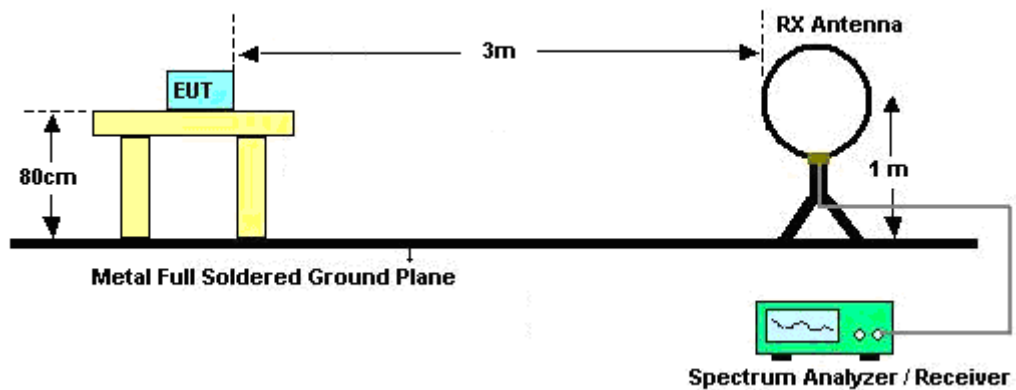

For radiated emissions from 30MHz to 1GHz

<CDD Mode>

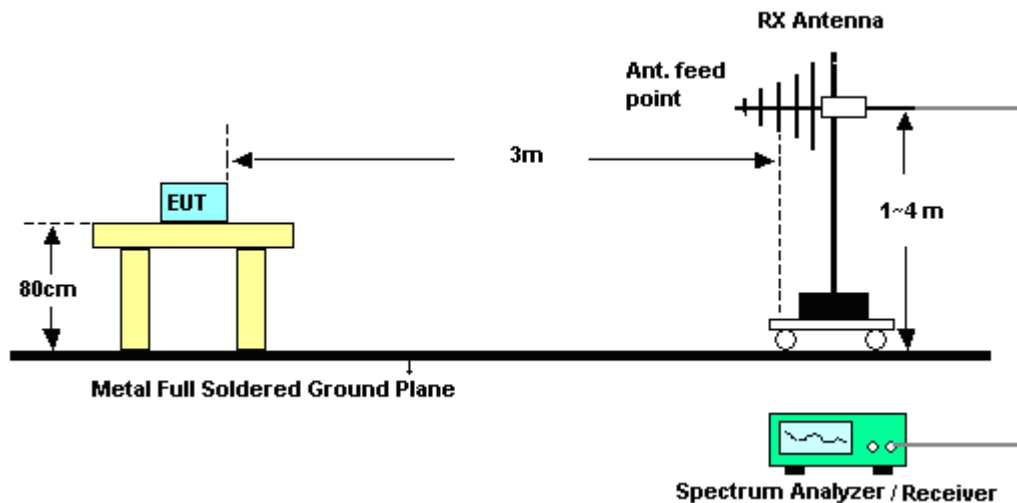

<TXBF Modes>

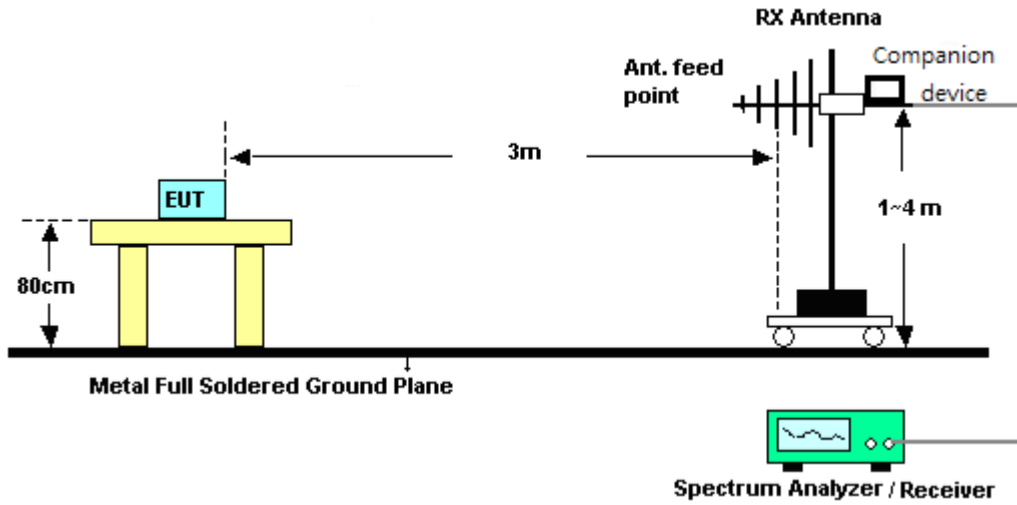

For radiated emissions above 1GHz

<CDD Mode>

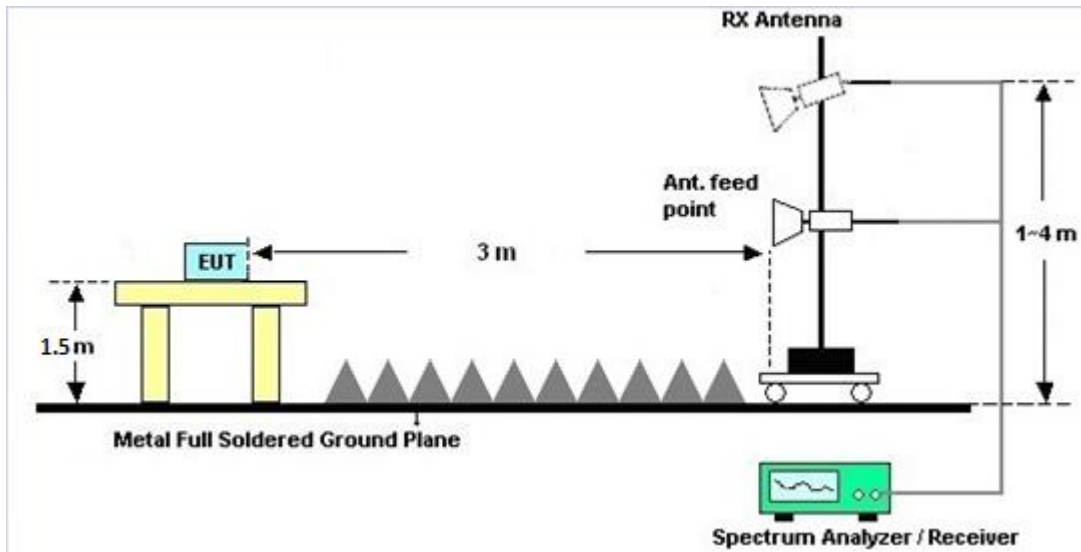

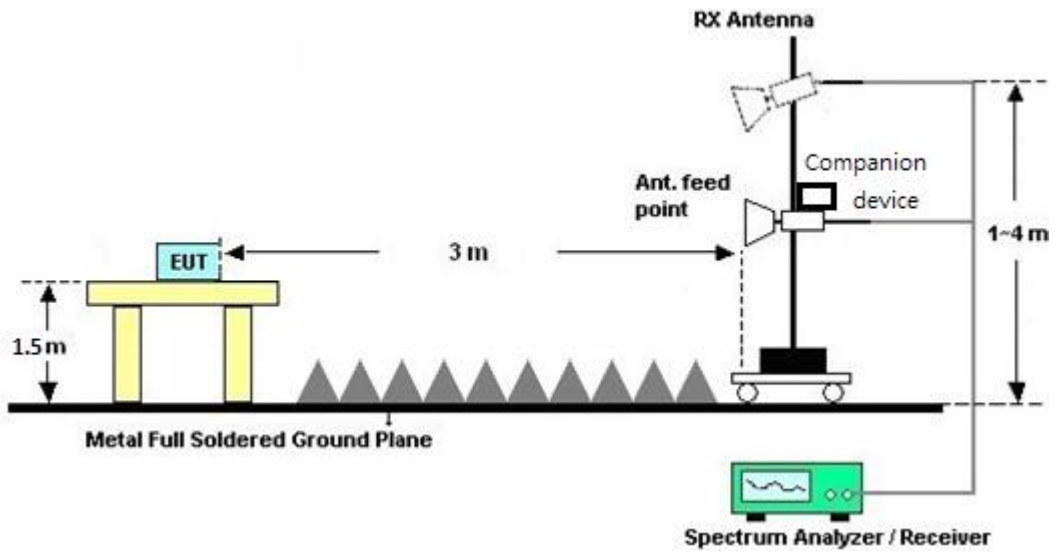

## &lt;TXBF Modes&gt;

**3.4.5 Test Results of Radiated Spurious Emissions (9 kHz ~ 30 MHz)**

The low frequency, which started from 9 kHz to 30MHz, was pre-scanned and the result which was 20dB lower than the limit line was not reported.

There is a comparison data of both open-field test site and semi-Anechoic chamber, and the result came out very similar.

**3.4.6 Test Result of Radiated Spurious at Band Edges**

Please refer to Appendix C and D.

**3.4.7 Duty Cycle**

Please refer to Appendix E.

**3.4.8 Test Result of Radiated Spurious Emissions (30MHz ~ 10th Harmonic)**

Please refer to Appendix C and D.



### 3.5 AC Conducted Emission Measurement

#### 3.5.1 Limit of AC Conducted Emission

For equipment that is designed to be connected to the public utility (AC) power line, the radio frequency voltage that is conducted back onto the AC power line on any frequency or frequencies within the band 150 kHz to 30 MHz shall not exceed the limits in the following table.

| Frequency of emission (MHz) | Conducted limit (dB $\mu$ V) |           |
|-----------------------------|------------------------------|-----------|
|                             | Quasi-peak                   | Average   |
| 0.15-0.5                    | 66 to 56*                    | 56 to 46* |
| 0.5-5                       | 56                           | 46        |
| 5-30                        | 60                           | 50        |

\*Decreases with the logarithm of the frequency.

#### 3.5.2 Measuring Instruments

The measuring equipment is listed in the section 4 of this test report.

#### 3.5.3 Test Procedures

1. The EUT was placed 0.4 meter from the conducting wall of the shielding room was kept at least 80 centimeters from any other grounded conducting surface.
2. Connect EUT to the power mains through a line impedance stabilization network (LISN).
3. All the support units are connecting to the other LISN.
4. The LISN provides 50 ohm coupling impedance for the measuring instrument.
5. The FCC states that a 50 ohm, 50 microhenry LISN should be used.
6. Both sides of AC line were checked for maximum conducted interference.
7. The frequency range from 150 kHz to 30 MHz was searched.
8. Set the test-receiver system to Peak Detect Function and specified bandwidth with Maximum Hold Mode.

### 3.5.4 Test Setup

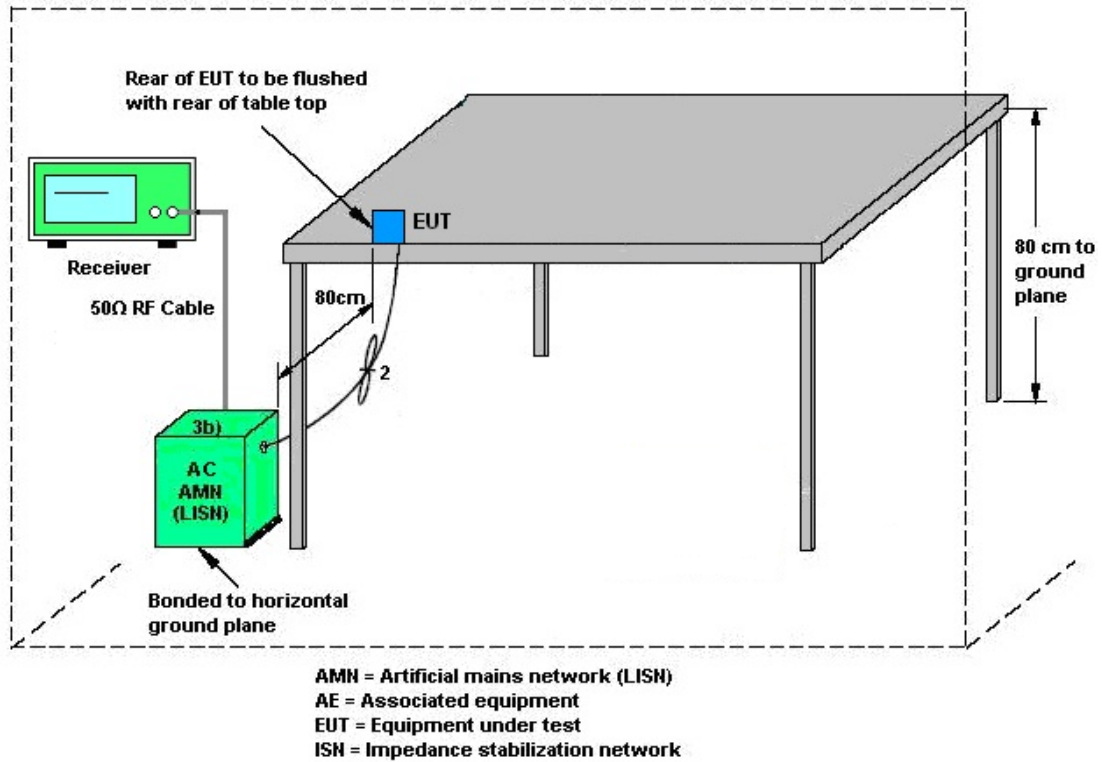

### 3.5.5 Test Result of AC Conducted Emission

Please refer to Appendix B.



## **3.6 Automatically Discontinue Transmission**

### **3.6.1 Limit of Automatically Discontinue Transmission**

The device shall automatically discontinue transmission in case of either absence of information to transmit or operational failure. These provisions are not intended to preclude the transmission of control or signaling information or the use of repetitive codes used by certain digital technologies to complete frame or burst intervals. Applicants shall include in their application for equipment authorization to describe how this requirement is met.

### **3.6.2 Measuring Instruments**

The measuring equipment is listed in the section 4 of this test report.

### **3.6.3 Test Result of Automatically Discontinue Transmission**

While the EUT is not transmitting any information, the EUT can automatically discontinue transmission and become standby mode for power saving. The EUT can detect the controlling signal of ACK message transmitting from remote device and verify whether it shall resend or discontinue transmission.



### 3.7 Antenna Requirements

#### 3.7.1 Standard Applicable

If transmitting antenna directional gain is greater than 6 dBi, both the peak transmit power and the peak power spectral density shall be reduced by the amount in dB that the directional gain of the antenna exceeds 6 dBi.

#### 3.7.2 Antenna Anti-Replacement Construction

An embedded-in antenna design is used.

#### 3.7.3 Antenna Gain

<CDD Modes >

FCC KDB 662911 D01 Multiple Transmitter Output v02r01

For CDD transmissions, directional gain is calculated as

Directional gain = GANT + Array Gain, where Array Gain is as follows.

For power spectral density (PSD) measurements on all devices,

Array Gain = 10 log(NANT/NSS=1) dB.

For power measurements on IEEE 802.11 devices,

Array Gain = 0 dB (i.e., no array gain) for NANT ≤ 4.

Directional gain may be calculated by using the formulas applicable to equal gain antennas with GANT set equal to the gain of the antenna having the highest gain;

The EUT supports CDD mode.

For power, the directional gain GANT is set equal to the antenna having the highest gain, i.e., F)2)f)i).

For PSD, the directional gain calculation is following F)2)f)ii) of KDB 662911 D01 v02r01.

The power and PSD limit should be modified if the directional gain of EUT is over 6 dBi,

The directional gain "DG" is calculated as following table.

| <b>&lt;CDD Modes&gt;</b> |               |               |              |              |                  |                  |
|--------------------------|---------------|---------------|--------------|--------------|------------------|------------------|
|                          |               |               | <b>DG</b>    | <b>DG</b>    | <b>Power</b>     | <b>PSD</b>       |
|                          |               |               | <b>for</b>   | <b>for</b>   | <b>Limit</b>     | <b>Limit</b>     |
|                          | <b>Ant. 1</b> | <b>Ant. 2</b> | <b>Power</b> | <b>PSD</b>   | <b>Reduction</b> | <b>Reduction</b> |
|                          | <b>(dBi)</b>  | <b>(dBi)</b>  | <b>(dBi)</b> | <b>(dBi)</b> | <b>(dB)</b>      | <b>(dB)</b>      |
| <b>Band I</b>            | 4.00          | 4.50          | 4.50         | 7.26         | 0.00             | 1.26             |

*Power limit reduction = Composite gain – 6dBi, ( min = 0 )*

*PSD limit reduction = Composite gain + PSD Array gain – 6dBi, ( min = 0 )*



**TXBF modes**

FCC KDB 662911 D01 Multiple Transmitter Output v02r01

For CDD transmissions, directional gain is calculated as

$$DirectionalGain = 10 \cdot \log \left[ \frac{\sum_{j=1}^{N_{SS}} \left\{ \sum_{k=1}^{N_{ANT}} g_{j,k} \right\}^2}{N_{ANT}} \right]$$

where

Each antenna is driven by no more than one spatial stream;

$N_{SS}$  = the number of independent spatial streams of data;

$N_{ANT}$  = the total number of antennas

$g_{j,k} = 10^{G_k / 20}$  if the  $k$ th antenna is being fed by spatial stream  $j$ , or zero if it is not;  
 $G_k$  is the gain in dBi of the  $k$ th antenna.

The EUT supports beamforming for 802.11ac modes.

The directional gain calculation is following F)2)e)ii) of KDB 662911 D01 v02r01.

The power and PSD limit should be modified if the directional gain of EUT is over 6 dBi,

The directional gain “DG” is calculated as following table.

|        |                |                | DG<br>for<br>Power<br>(dBi) | DG<br>for<br>PSD<br>(dBi) | Power<br>Limit<br>Reduction<br>(dB) | PSD<br>Limit<br>Reduction<br>(dB) |
|--------|----------------|----------------|-----------------------------|---------------------------|-------------------------------------|-----------------------------------|
|        | Ant 1<br>(dBi) | Ant 2<br>(dBi) |                             |                           |                                     |                                   |
| Band I | 4.00           | 4.50           | 7.26                        | 7.26                      | 1.26                                | 1.26                              |

$$Power\ Limit\ Reduction = DG(Power) - 6dBi, (min = 0)$$

$$PSD\ Limit\ Reduction = DG(PSD) - 6dBi, (min = 0)$$



## 4 List of Measuring Equipment

| Instrument            | Manufacturer    | Model No.       | Serial No.        | Characteristics   | Calibration Date | Test Date                       | Due Date      | Remark                  |
|-----------------------|-----------------|-----------------|-------------------|-------------------|------------------|---------------------------------|---------------|-------------------------|
| Power Meter           | Anritsu         | ML2495A         | 1240001           | N/A               | Sep. 07, 2017    | Feb. 03, 2018~<br>Mar. 31, 2018 | Sep. 06, 2018 | Conducted<br>(TH05-HY)  |
| Power Sensor          | Anritsu         | MA2411B         | 1207349           | 300MHz~40GHz<br>z | Sep. 07, 2017    | Feb. 03, 2018~<br>Mar. 31, 2018 | Sep. 06, 2018 | Conducted<br>(TH05-HY)  |
| Spectrum Analyzer     | Rohde & Schwarz | FSP40           | 100055            | 9kHz~40GHz        | Jun. 20, 2017    | Feb. 03, 2018~<br>Apr. 12, 2018 | Jun. 19, 2018 | Conducted<br>(TH05-HY)  |
| Switch Box & RF Cable | Burgeon         | ETF-058         | EC130048<br>4     | N/A               | Jan. 03, 2018    | Feb. 03, 2018~<br>Apr. 12, 2018 | Jan. 02, 2019 | Conducted<br>(TH05-HY)  |
| Switch Box & RF Cable | Burgeon         | ETF-058         | EC120838<br>1     | N/A               | Mar. 03, 2017    | Feb. 03, 2018~<br>Feb. 28, 2018 | Mar. 02, 2018 | Conducted<br>(TH05-HY)  |
| Switch Box & RF Cable | Burgeon         | ETF-058         | EC120838<br>1     | N/A               | Mar. 01, 2018    | Mar. 01, 2018~<br>Mar. 31, 2018 | Feb. 28, 2019 | Conducted<br>(TH05-HY)  |
| Power Sensor          | DARE            | RPR3006W        | 16I00054S<br>NO11 | 10MHz~6GHz        | Dec. 11, 2017    | Mar. 29, 2018~<br>Apr. 12, 2018 | Dec. 10, 2018 | Conducted<br>(TH05-HY)  |
| AC Power Source       | ChainTek        | APC-1000W       | N/A               | N/A               | N/A              | Mar. 27, 2018                   | N/A           | Conduction<br>(CO05-HY) |
| EMI Test Receiver     | Rohde & Schwarz | ESCI 7          | 100724            | 9kHz~7GHz         | Sep. 20, 2017    | Mar. 27, 2018                   | Sep. 19, 2018 | Conduction<br>(CO05-HY) |
| LISN                  | Rohde & Schwarz | ENV216          | 100080            | 9kHz~30MHz        | Nov. 30, 2017    | Mar. 27, 2018                   | Nov. 29, 2018 | Conduction<br>(CO05-HY) |
| LISN                  | Rohde & Schwarz | ENV216          | 100081            | 9kHz~30MHz        | Dec. 08, 2017    | Mar. 27, 2018                   | Dec. 07, 2018 | Conduction<br>(CO05-HY) |
| Software              | Rohde & Schwarz | EMC32<br>V10.30 | N/A               | N/A               | N/A              | Mar. 27, 2018                   | N/A           | Conduction<br>(CO05-HY) |



| Instrument           | Manufacturer       | Model No.                  | Serial No.         | Characteristics                     | Calibration Date | Test Date                       | Due Date      | Remark                   |
|----------------------|--------------------|----------------------------|--------------------|-------------------------------------|------------------|---------------------------------|---------------|--------------------------|
| Amplifier            | MITEQ              | TTA1840-35-HG              | 1871923            | 18GHz~40GHz,<br>VSWR : 2.5:1<br>max | Jul. 18, 2017    | Feb. 11, 2018~<br>Mar. 20, 2018 | Jul. 17, 2018 | Radiation<br>(03CH11-HY) |
| Amplifier            | SONOMA             | 310N                       | 187312             | 9kHz~1GHz                           | Nov. 10, 2016    | Feb. 11, 2018~<br>Mar. 20, 2018 | Nov. 09, 2018 | Radiation<br>(03CH11-HY) |
| Bilog Antenna        | TESEQ              | CBL<br>6111D&N-6-0<br>6    | 35414&AT-<br>N0602 | 30MHz~1GHz                          | Oct. 14, 2017    | Feb. 11, 2018~<br>Mar. 20, 2018 | Oct. 13, 2018 | Radiation<br>(03CH11-HY) |
| Horn Antenna         | SCHWARZBE<br>CK    | BBHA 9120 D                | 9120D-132<br>6     | 1GHz ~ 18GHz                        | Oct. 16, 2017    | Feb. 11, 2018~<br>Mar. 20, 2018 | Oct. 15, 2018 | Radiation<br>(03CH11-HY) |
| Loop Antenna         | Rohde &<br>Schwarz | HFH2-Z2                    | 100488             | 9 kHz~30 MHz                        | Nov. 23, 2017    | Feb. 11, 2018~<br>Mar. 20, 2018 | Nov. 22, 2019 | Radiation<br>(03CH11-HY) |
| Preamplifier         | Keysight           | 83017A                     | MY532700<br>80     | 1GHz~26.5GHz                        | Nov. 10, 2016    | Feb. 11, 2018~<br>Mar. 20, 2018 | Nov. 09, 2018 | Radiation<br>(03CH11-HY) |
| Spectrum Analyzer    | Keysight           | N9010A                     | MY542004<br>86     | 10Hz ~ 44GHz                        | Oct. 19, 2017    | Feb. 11, 2018~<br>Mar. 20, 2018 | Oct. 18, 2018 | Radiation<br>(03CH11-HY) |
| Antenna Mast         | EMEC               | AM-BS-4500-<br>B           | N/A                | 1~4m                                | N/A              | Feb. 11, 2018~<br>Mar. 20, 2018 | N/A           | Radiation<br>(03CH11-HY) |
| Turn Table           | EMEC               | TT 2000                    | N/A                | 0~360 Degree                        | N/A              | Feb. 11, 2018~<br>Mar. 20, 2018 | N/A           | Radiation<br>(03CH11-HY) |
| Preamplifier         | MITEQ              | AMF-7D-0010<br>1800-30-10P | 1590074            | 1GHz~18GHz                          | May 22, 2017     | Feb. 11, 2018~<br>Mar. 20, 2018 | May 21, 2018  | Radiation<br>(03CH11-HY) |
| Preamplifier         | MITEQ              | AMF-7D-0010<br>1800        | 2025787            | 1GHz~18GHz                          | Feb. 13,2017     | Feb. 11, 2018~<br>Mar. 20, 2018 | Feb. 12,2019  | Radiation<br>(03CH11-HY) |
| EMI Test Receiver    | Agilent            | N9038A<br>(MXE)            | MY532900<br>53     | 20Hz to<br>26.5GHz                  | Jan. 16, 2018    | Feb. 11, 2018~<br>Mar. 20, 2018 | Jan. 15, 2019 | Radiation<br>(03CH11-HY) |
| SHF-EHF Horn Antenna | SCHWARZBE<br>CK    | BBHA 9170                  | BBHA9170<br>584    | 18GHz- 40GHz                        | Nov. 27, 2017    | Feb. 11, 2018~<br>Mar. 20, 2018 | Nov. 26, 2018 | Radiation<br>(03CH11-HY) |
| Software             | Audix              | E3 6.2009-8-<br>24         | RK-00104<br>2      | NA                                  | NA               | Feb. 11, 2018~<br>Mar. 20, 2018 | NA            | Radiation<br>(03CH11-HY) |





## 5 Uncertainty of Evaluation

### Uncertainty of Conducted Emission Measurement (150kHz ~ 30MHz)

|   |     |
|---|-----|
| Measuring Uncertainty for a Level of Confidence of 95% ( $U = 2Uc(y)$ ) | 2.7 |
|---|-----|

### Uncertainty of Radiated Emission Measurement (30 MHz ~ 1000 MHz)

|   |     |
|---|-----|
| Measuring Uncertainty for a Level of Confidence of 95% ( $U = 2Uc(y)$ ) | 5.2 |
|---|-----|

### Uncertainty of Radiated Emission Measurement (1000 MHz ~ 18000 MHz)

|   |     |
|---|-----|
| Measuring Uncertainty for a Level of Confidence of 95% ( $U = 2Uc(y)$ ) | 5.5 |
|---|-----|

### Uncertainty of Radiated Emission Measurement (18000 MHz ~ 40000 MHz)

|   |     |
|---|-----|
| Measuring Uncertainty for a Level of Confidence of 95% ( $U = 2Uc(y)$ ) | 5.2 |
|---|-----|

**Appendix A. Test Result of Conducted Test Items****<For CDD Mode>**

|                |                         |                    |       |    |
|----------------|-------------------------|--------------------|-------|----|
| Test Engineer: | Kai Liao                | Temperature:       | 21~25 | °C |
| Test Date:     | 2018/03/09 ~ 2018/03/27 | Relative Humidity: | 51~54 | %  |

**TEST RESULTS DATA**  
**26dB and 99% OBW**

| Band I |           |     |     |             |                       |       |       |       |                     |       |       |       |                                   |       |       |       |
|--------|-----------|-----|-----|-------------|-----------------------|-------|-------|-------|---------------------|-------|-------|-------|-----------------------------------|-------|-------|-------|
| Mod.   | Data Rate | NTX | CH. | Freq. (MHz) | 26 dB Bandwidth (MHz) |       |       |       | 99% Bandwidth (MHz) |       |       |       | IC 99% Bandwidth EIRP Limit (dBm) |       |       |       |
|        |           |     |     |             | Ant 1                 | Ant 2 | Ant 3 | Ant 4 | Ant 1               | Ant 2 | Ant 3 | Ant 4 | Ant 1                             | Ant 2 | Ant 3 | Ant 4 |
| 11a    | 6Mbps     | 1   | 36  | 5180        | 21.1                  |       |       |       | 17.20               |       |       |       | 22.36                             |       |       |       |
| 11a    | 6Mbps     | 1   | 44  | 5220        | 39.45                 |       |       |       | 18.30               |       |       |       | 22.62                             |       |       |       |
| 11a    | 6Mbps     | 1   | 48  | 5240        | 42.8                  |       |       |       | 21.20               |       |       |       | 23.01                             |       |       |       |
| VHT20  | MCS0      | 1   | 36  | 5180        | 21.8                  |       |       |       | 18.25               |       |       |       | 22.61                             |       |       |       |
| VHT20  | MCS0      | 1   | 44  | 5220        | 39.35                 |       |       |       | 19.15               |       |       |       | 22.82                             |       |       |       |
| VHT20  | MCS0      | 1   | 48  | 5240        | 43.95                 |       |       |       | 21.10               |       |       |       | 23.01                             |       |       |       |
| VHT40  | MCS0      | 1   | 38  | 5190        | 40.32                 |       |       |       | 36.30               |       |       |       | 23.01                             |       |       |       |
| VHT40  | MCS0      | 1   | 46  | 5230        | 76.07                 |       |       |       | 37.30               |       |       |       | 23.01                             |       |       |       |
| VHT80  | MCS0      | 1   | 42  | 5210        | 83.75                 |       |       |       | 75.72               |       |       |       | 23.01                             |       |       |       |
| 11a    | 6Mbps     | 2   | 36  | 5180        | 21.1                  | 20.80 |       |       | 17.10               | 17.20 |       |       | 22.33                             | 22.36 |       |       |
| 11a    | 6Mbps     | 2   | 44  | 5220        | 32.15                 | 27.55 |       |       | 17.50               | 17.40 |       |       | 22.43                             | 22.41 |       |       |
| 11a    | 6Mbps     | 2   | 48  | 5240        | 43.35                 | 36.90 |       |       | 19.85               | 17.85 |       |       | 22.98                             | 22.52 |       |       |
| VHT20  | MCS0      | 2   | 36  | 5180        | 22                    | 21.60 |       |       | 18.30               | 18.25 |       |       | 22.62                             | 22.61 |       |       |
| VHT20  | MCS0      | 2   | 44  | 5220        | 36.1                  | 32.45 |       |       | 18.90               | 18.65 |       |       | 22.76                             | 22.71 |       |       |
| VHT20  | MCS0      | 2   | 48  | 5240        | 45.85                 | 37.90 |       |       | 22.25               | 19.55 |       |       | 23.01                             | 22.91 |       |       |
| VHT40  | MCS0      | 2   | 38  | 5190        | 40.5                  | 40.50 |       |       | 36.30               | 36.20 |       |       | 23.01                             | 23.01 |       |       |
| VHT40  | MCS0      | 2   | 46  | 5230        | 58.87                 | 46.50 |       |       | 36.40               | 36.40 |       |       | 23.01                             | 23.01 |       |       |
| VHT80  | MCS0      | 2   | 42  | 5210        | 88.1                  | 82.88 |       |       | 75.72               | 75.72 |       |       | 23.01                             | 23.01 |       |       |

**TEST RESULTS DATA**  
**Average Power Table**

| FCC Band I |           |     |     |             |     |  |       |       |       |       |                       |          |                      |                            |           |
|------------|-----------|-----|-----|-------------|-----|--|-------|-------|-------|-------|-----------------------|----------|----------------------|----------------------------|-----------|
| Mod.       | Data Rate | NTX | CH. | Freq. (MHz) | Ant | Average Conducted Power with duty factor (dBm) |       |       |       |       | FCC Power Limit (dBm) | DG (dBi) | FCC EIRP Power (dBm) | FCC EIRP Power Limit (dBm) | Pass/Fail |
|            |           |     |     |             |     | Ant 1  | Ant 2 | Ant 3 | Ant 4 | SUM   |                       |          |                      |                            |           |
| 11a        | 6Mbps     | 1   | 36  | 5180        | 1   | 22.77  |       |       |       | 22.77 | 30.00                 | 4.00     | 26.77                | -                          | Pass      |
| 11a        | 6Mbps     | 1   | 44  | 5220        | 1   | 25.74  |       |       |       | 25.74 | 30.00                 | 4.00     | 29.74                | -                          | Pass      |
| 11a        | 6Mbps     | 1   | 48  | 5240        | 1   | 24.95  |       |       |       | 24.95 | 30.00                 | 4.00     | 28.95                | -                          | Pass      |
| HT20       | MCS0      | 1   | 36  | 5180        | 1   | 22.66  |       |       |       | 22.66 | 30.00                 | 4.00     | 26.66                | -                          | Pass      |
| HT20       | MCS0      | 1   | 44  | 5220        | 1   | 25.10  |       |       |       | 25.10 | 30.00                 | 4.00     | 29.10                | -                          | Pass      |
| HT20       | MCS0      | 1   | 48  | 5240        | 1   | 24.90  |       |       |       | 24.90 | 30.00                 | 4.00     | 28.90                | -                          | Pass      |
| HT40       | MCS0      | 1   | 38  | 5190        | 1   | 21.06  |       |       |       | 21.06 | 30.00                 | 4.00     | 25.06                | -                          | Pass      |
| HT40       | MCS0      | 1   | 46  | 5230        | 1   | 24.67  |       |       |       | 24.67 | 30.00                 | 4.00     | 28.67                | -                          | Pass      |
| VHT20      | MCS0      | 1   | 36  | 5180        | 1   | 23.08  |       |       |       | 23.08 | 30.00                 | 4.00     | 27.08                | -                          | Pass      |
| VHT20      | MCS0      | 1   | 44  | 5220        | 1   | 25.67  |       |       |       | 25.67 | 30.00                 | 4.00     | 29.67                | -                          | Pass      |
| VHT20      | MCS0      | 1   | 48  | 5240        | 1   | 24.91  |       |       |       | 24.91 | 30.00                 | 4.00     | 28.91                | -                          | Pass      |
| VHT40      | MCS0      | 1   | 38  | 5190        | 1   | 21.24  |       |       |       | 21.24 | 30.00                 | 4.00     | 25.24                | -                          | Pass      |
| VHT40      | MCS0      | 1   | 46  | 5230        | 1   | 24.96  |       |       |       | 24.96 | 30.00                 | 4.00     | 28.96                | -                          | Pass      |
| VHT80      | MCS0      | 1   | 42  | 5210        | 1   | 21.74  |       |       |       | 21.74 | 30.00                 | 4.00     | 25.74                | -                          | Pass      |
| 11a        | 6Mbps     | 2   | 36  | 5180        | 1+2 | 22.77  | 22.93 |       |       | 25.86 | 30.00                 | 4.50     | 30.36                | -                          | Pass      |
| 11a        | 6Mbps     | 2   | 44  | 5220        | 1+2 | 24.35  | 24.08 |       |       | 27.23 | 30.00                 | 4.50     | 31.73                | -                          | Pass      |
| 11a        | 6Mbps     | 2   | 48  | 5240        | 1+2 | 24.34  | 23.99 |       |       | 27.18 | 30.00                 | 4.50     | 31.68                | -                          | Pass      |
| HT20       | MCS0      | 2   | 36  | 5180        | 1+2 | 22.23  | 22.58 |       |       | 25.42 | 30.00                 | 4.50     | 29.92                | -                          | Pass      |
| HT20       | MCS0      | 2   | 44  | 5220        | 1+2 | 24.82  | 24.57 |       |       | 27.71 | 30.00                 | 4.50     | 32.21                | -                          | Pass      |
| HT20       | MCS0      | 2   | 48  | 5240        | 1+2 | 24.73  | 24.50 |       |       | 27.62 | 30.00                 | 4.50     | 32.12                | -                          | Pass      |
| HT40       | MCS0      | 2   | 38  | 5190        | 1+2 | 20.03  | 20.12 |       |       | 23.09 | 30.00                 | 4.50     | 27.59                | -                          | Pass      |
| HT40       | MCS0      | 2   | 46  | 5230        | 1+2 | 22.91  | 23.06 |       |       | 26.00 | 30.00                 | 4.50     | 30.50                | -                          | Pass      |
| VHT20      | MCS0      | 2   | 36  | 5180        | 1+2 | 22.95  | 22.99 |       |       | 25.98 | 30.00                 | 4.50     | 30.48                | -                          | Pass      |
| VHT20      | MCS0      | 2   | 44  | 5220        | 1+2 | 25.21  | 25.08 |       |       | 28.15 | 30.00                 | 4.50     | 32.65                | -                          | Pass      |
| VHT20      | MCS0      | 2   | 48  | 5240        | 1+2 | 25.13  | 24.92 |       |       | 28.03 | 30.00                 | 4.50     | 32.53                | -                          | Pass      |
| VHT40      | MCS0      | 2   | 38  | 5190        | 1+2 | 20.26  | 20.32 |       |       | 23.30 | 30.00                 | 4.50     | 27.80                | -                          | Pass      |
| VHT40      | MCS0      | 2   | 46  | 5230        | 1+2 | 23.26  | 23.32 |       |       | 26.30 | 30.00                 | 4.50     | 30.80                | -                          | Pass      |
| VHT80      | MCS0      | 2   | 42  | 5210        | 1+2 | 20.07  | 19.81 |       |       | 22.95 | 30.00                 | 4.50     | 27.45                | -                          | Pass      |

**TEST RESULTS DATA**  
**Power Spectral Density**

| FCC Band I |           |     |     |             |     |                  |       |       |       |  |                     |          |  |            |
|------------|-----------|-----|-----|-------------|-----|------------------|-------|-------|-------|--|---------------------|----------|--|------------|
| Mod.       | Data Rate | NTX | CH. | Freq. (MHz) | Ant | Duty Factor (dB) |       |       |       | Average PSD with Duty Factor (dBm/MHz) | PSD Limit (dBm/MHz) | DG (dBi) |  | Pass /Fail |
|            |           |     |     |             |     | Ant 1            | Ant 2 | Ant 3 | Ant 4 |  |                     |          |  |            |
| 11a        | 6Mbps     | 1   | 36  | 5180        | 1   | 0.17             |       |       |       | 10.36                                  | 17.00               | 4.00     |  | Pass       |
| 11a        | 6Mbps     | 1   | 44  | 5220        | 1   | 0.17             |       |       |       | 13.77                                  | 17.00               | 4.00     |  | Pass       |
| 11a        | 6Mbps     | 1   | 48  | 5240        | 1   | 0.17             |       |       |       | 13.03                                  | 17.00               | 4.00     |  | Pass       |
| VHT20      | MCS0      | 1   | 36  | 5180        | 1   | 0.54             |       |       |       | 10.09                                  | 17.00               | 4.00     |  | Pass       |
| VHT20      | MCS0      | 1   | 44  | 5220        | 1   | 0.54             |       |       |       | 13.55                                  | 17.00               | 4.00     |  | Pass       |
| VHT20      | MCS0      | 1   | 48  | 5240        | 1   | 0.54             |       |       |       | 12.90                                  | 17.00               | 4.00     |  | Pass       |
| VHT40      | MCS0      | 1   | 38  | 5190        | 1   | 1.06             |       |       |       | 6.15                                   | 17.00               | 4.00     |  | Pass       |
| VHT40      | MCS0      | 1   | 46  | 5230        | 1   | 1.06             |       |       |       | 10.26                                  | 17.00               | 4.00     |  | Pass       |
| VHT80      | MCS0      | 1   | 42  | 5210        | 1   | 0.82             |       |       |       | 3.58                                   | 17.00               | 4.00     |  | Pass       |
| 11a        | 6Mbps     | 2   | 36  | 5180        | 1+2 | 0.17             | 0.17  |       |       | 13.74                                  | 15.74               | 7.26     |  | Pass       |
| 11a        | 6Mbps     | 2   | 44  | 5220        | 1+2 | 0.17             | 0.17  |       |       | 15.37                                  | 15.74               | 7.26     |  | Pass       |
| 11a        | 6Mbps     | 2   | 48  | 5240        | 1+2 | 0.17             | 0.17  |       |       | 15.24                                  | 15.74               | 7.26     |  | Pass       |
| VHT20      | MCS0      | 2   | 36  | 5180        | 1+2 | 0.56             | 0.56  |       |       | 13.49                                  | 15.74               | 7.26     |  | Pass       |
| VHT20      | MCS0      | 2   | 44  | 5220        | 1+2 | 0.56             | 0.56  |       |       | 15.71                                  | 15.74               | 7.26     |  | Pass       |
| VHT20      | MCS0      | 2   | 48  | 5240        | 1+2 | 0.56             | 0.56  |       |       | 15.58                                  | 15.74               | 7.26     |  | Pass       |
| VHT40      | MCS0      | 2   | 38  | 5190        | 1+2 | 1.06             | 1.06  |       |       | 8.24                                   | 15.74               | 7.26     |  | Pass       |
| VHT40      | MCS0      | 2   | 46  | 5230        | 1+2 | 1.06             | 1.06  |       |       | 11.43                                  | 15.74               | 7.26     |  | Pass       |
| VHT80      | MCS0      | 2   | 42  | 5210        | 1+2 | 0.81             | 0.81  |       |       | 5.13                                   | 15.74               | 7.26     |  | Pass       |

**<For TXBF Mode>**

|                |            |                    |       |    |
|----------------|------------|--------------------|-------|----|
| Test Engineer: | Kai Liao   | Temperature:       | 21~25 | °C |
| Test Date:     | 2018/03/29 | Relative Humidity: | 51~54 | %  |

**TEST RESULTS DATA**  
**26dB and 99% OBW**

| Band I |           |     |     |             |                       |       |       |       |                     |       |       |       |                                   |       |       |       |
|--------|-----------|-----|-----|-------------|-----------------------|-------|-------|-------|---------------------|-------|-------|-------|-----------------------------------|-------|-------|-------|
| Mod.   | Data Rate | NTX | CH. | Freq. (MHz) | 26 dB Bandwidth (MHz) |       |       |       | 99% Bandwidth (MHz) |       |       |       | IC 99% Bandwidth EIRP Limit (dBm) |       |       |       |
|        |           |     |     |             | Ant 1                 | Ant 2 | Ant 3 | Ant 4 | Ant 1               | Ant 2 | Ant 3 | Ant 4 | Ant 1                             | Ant 2 | Ant 3 | Ant 4 |
| VHT20  | MCS0      | 2   | 36  | 5180        | 21.8                  | 21.90 |       |       | 18.40               | 18.40 |       |       | 22.65                             | 22.65 |       |       |
| VHT20  | MCS0      | 2   | 44  | 5220        | 21.5                  | 21.90 |       |       | 18.15               | 18.50 |       |       | 22.59                             | 22.67 |       |       |
| VHT20  | MCS0      | 2   | 48  | 5240        | 21.8                  | 21.70 |       |       | 18.60               | 18.25 |       |       | 22.70                             | 22.61 |       |       |
| VHT40  | MCS0      | 2   | 38  | 5190        | 36.96                 | 40.32 |       |       | 36.20               | 36.30 |       |       | 23.01                             | 23.01 |       |       |
| VHT40  | MCS0      | 2   | 46  | 5230        | 45.72                 | 36.20 |       |       | 36.90               | 39.17 |       |       | 23.01                             | 23.01 |       |       |
| VHT80  | MCS0      | 2   | 42  | 5210        | 84.12                 | 82.16 |       |       | 75.84               | 75.48 |       |       | 23.01                             | 23.01 |       |       |

**TEST RESULTS DATA**  
**Average Power Table**

| FCC Band I |           |     |     |             |     |  |       |       |       |       |                       |          |                      |                            |           |
|------------|-----------|-----|-----|-------------|-----|--|-------|-------|-------|-------|-----------------------|----------|----------------------|----------------------------|-----------|
| Mod.       | Data Rate | NTX | CH. | Freq. (MHz) | Ant | Average Conducted Power with duty factor (dBm) |       |       |       |       | FCC Power Limit (dBm) | DG (dBi) | FCC EIRP Power (dBm) | FCC EIRP Power Limit (dBm) | Pass/Fail |
|            |           |     |     |             |     | Ant 1  | Ant 2 | Ant 3 | Ant 4 | SUM   |                       |          |                      |                            |           |
| HT20       | MCS0      | 2   | 36  | 5180        | 1+2 | 21.50  | 21.60 |       |       | 24.56 | 28.74                 | 7.26     | 31.82                | -                          | Pass      |
| HT20       | MCS0      | 2   | 44  | 5220        | 1+2 | 21.10  | 20.90 |       |       | 24.01 | 28.74                 | 7.26     | 31.28                | -                          | Pass      |
| HT20       | MCS0      | 2   | 48  | 5240        | 1+2 | 21.10  | 20.90 |       |       | 24.01 | 28.74                 | 7.26     | 31.28                | -                          | Pass      |
| HT40       | MCS0      | 2   | 38  | 5190        | 1+2 | 20.80  | 20.80 |       |       | 23.81 | 28.74                 | 7.26     | 31.07                | -                          | Pass      |
| HT40       | MCS0      | 2   | 46  | 5230        | 1+2 | 21.10  | 21.20 |       |       | 24.16 | 28.74                 | 7.26     | 31.42                | -                          | Pass      |
| VHT20      | MCS0      | 2   | 36  | 5180        | 1+2 | 21.70  | 21.70 |       |       | 24.71 | 28.74                 | 7.26     | 31.97                | -                          | Pass      |
| VHT20      | MCS0      | 2   | 44  | 5220        | 1+2 | 21.30  | 21.10 |       |       | 24.21 | 28.74                 | 7.26     | 31.48                | -                          | Pass      |
| VHT20      | MCS0      | 2   | 48  | 5240        | 1+2 | 21.20  | 21.10 |       |       | 24.16 | 28.74                 | 7.26     | 31.42                | -                          | Pass      |
| VHT40      | MCS0      | 2   | 38  | 5190        | 1+2 | 21.00  | 21.20 |       |       | 24.11 | 28.74                 | 7.26     | 31.38                | -                          | Pass      |
| VHT40      | MCS0      | 2   | 46  | 5230        | 1+2 | 21.50  | 21.50 |       |       | 24.51 | 28.74                 | 7.26     | 31.77                | -                          | Pass      |
| VHT80      | MCS0      | 2   | 42  | 5210        | 1+2 | 20.10  | 20.30 |       |       | 23.21 | 28.74                 | 7.26     | 30.48                | -                          | Pass      |



***TEST RESULTS DATA***  
***Power Spectral Density***

| FCC Band I |           |     |     |             |     |                  |       |       |       |  |                     |          |  |            |
|------------|-----------|-----|-----|-------------|-----|------------------|-------|-------|-------|--|---------------------|----------|--|------------|
| Mod.       | Data Rate | NTX | CH. | Freq. (MHz) | Ant | Duty Factor (dB) |       |       |       | Average PSD with Duty Factor (dBm/MHz) | PSD Limit (dBm/MHz) | DG (dBi) |  | Pass /Fail |
|            |           |     |     |             |     | Ant 1            | Ant 2 | Ant 3 | Ant 4 |  |                     |          |  |            |
| VHT20      | MCS0      | 2   | 36  | 5180        | 1+2 | 0.00             | 0.00  |       |       | 15.332                                 | 15.74               | 7.26     |  | Pass       |
| VHT20      | MCS0      | 2   | 44  | 5220        | 1+2 | 0.00             | 0.00  |       |       | 14.538                                 | 15.74               | 7.26     |  | Pass       |
| VHT20      | MCS0      | 2   | 48  | 5240        | 1+2 | 0.00             | 0.00  |       |       | 15.63                                  | 15.74               | 7.26     |  | Pass       |
| VHT40      | MCS0      | 2   | 38  | 5190        | 1+2 | 0.00             | 0.00  |       |       | 10.357                                 | 15.74               | 7.26     |  | Pass       |
| VHT40      | MCS0      | 2   | 46  | 5230        | 1+2 | 0.00             | 0.00  |       |       | 10.961                                 | 15.74               | 7.26     |  | Pass       |
| VHT80      | MCS0      | 2   | 42  | 5210        | 1+2 | 0.00             | 0.00  |       |       | 8.86                                   | 15.74               | 7.26     |  | Pass       |



## Appendix B. AC Conducted Emission Test Results

|                 |            |                     |         |
|-----------------|------------|---------------------|---------|
| Test Engineer : | Shareef Yu | Temperature :       | 22~24°C |
|                 |            | Relative Humidity : | 58~62%  |

## EUT Information

Report NO : 811726  
 Test Mode : Mode 1  
 Test Voltage : 120Vac/60Hz  
 Phase : Line

Full Spectrum

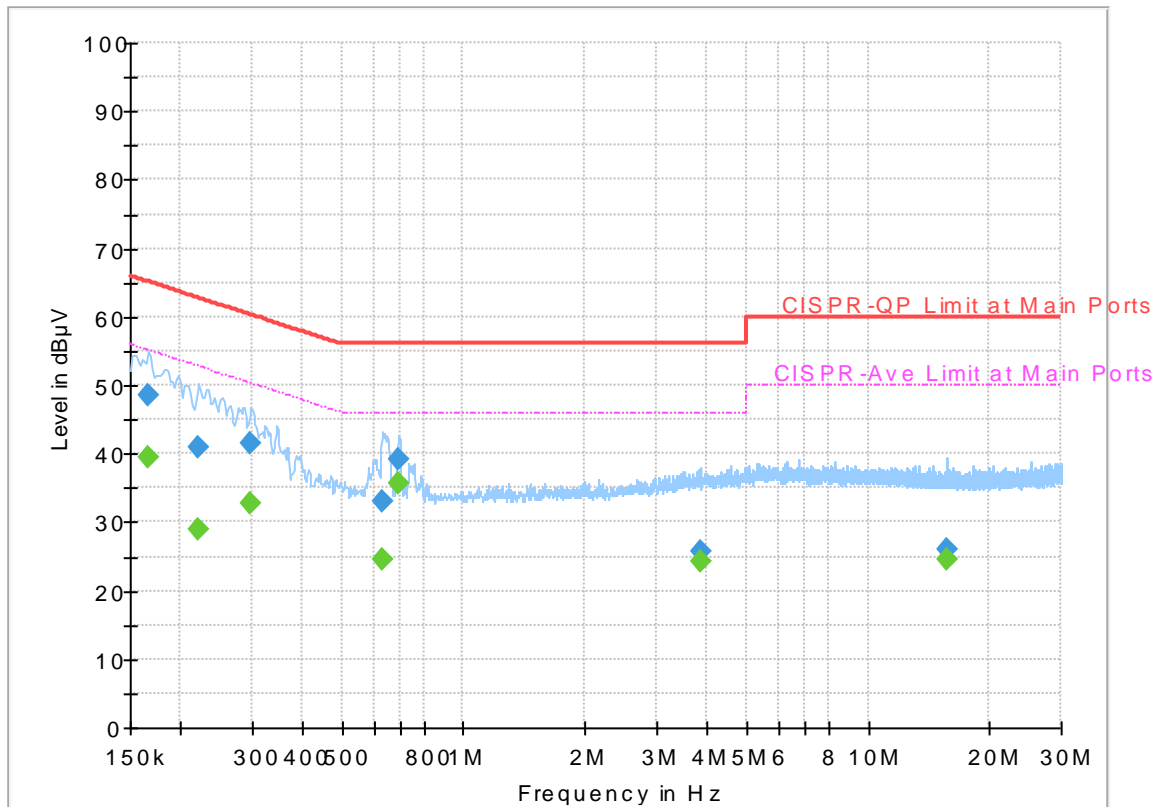

## Final\_Result

| Frequency (MHz) | QuasiPeak (dBµV) | Average (dBµV) | Limit (dBµV) | Margin (dB) | Line | Filter | Corr. (dB) |
|-----------------|------------------|----------------|--------------|-------------|------|--------|------------|
| 0.165750        | 48.49            | ---            | 65.17        | 16.68       | L1   | OFF    | 19.5       |
| 0.165750        | ---              | 39.49          | 55.17        | 15.68       | L1   | OFF    | 19.5       |
| 0.222000        | 40.84            | ---            | 62.74        | 21.90       | L1   | OFF    | 19.5       |
| 0.222000        | ---              | 28.85          | 52.74        | 23.89       | L1   | OFF    | 19.5       |
| 0.298500        | 41.54            | ---            | 60.28        | 18.74       | L1   | OFF    | 19.5       |
| 0.298500        | ---              | 32.70          | 50.28        | 17.58       | L1   | OFF    | 19.5       |
| 0.633750        | 32.91            | ---            | 56.00        | 23.09       | L1   | OFF    | 19.5       |
| 0.633750        | ---              | 24.52          | 46.00        | 21.48       | L1   | OFF    | 19.5       |
| 0.692250        | 39.32            | ---            | 56.00        | 16.68       | L1   | OFF    | 19.5       |
| 0.692250        | ---              | 35.54          | 46.00        | 10.46       | L1   | OFF    | 19.5       |
| 3.864750        | 25.71            | ---            | 56.00        | 30.29       | L1   | OFF    | 19.6       |
| 3.864750        | ---              | 24.29          | 46.00        | 21.71       | L1   | OFF    | 19.6       |
| 15.609750       | 26.16            | ---            | 60.00        | 33.84       | L1   | OFF    | 19.8       |
| 15.609750       | ---              | 24.57          | 50.00        | 25.43       | L1   | OFF    | 19.8       |

## EUT Information

Report NO : 811726  
 Test Mode : Mode 1  
 Test Voltage : 120Vac/60Hz  
 Phase : Neutral

Full Spectrum

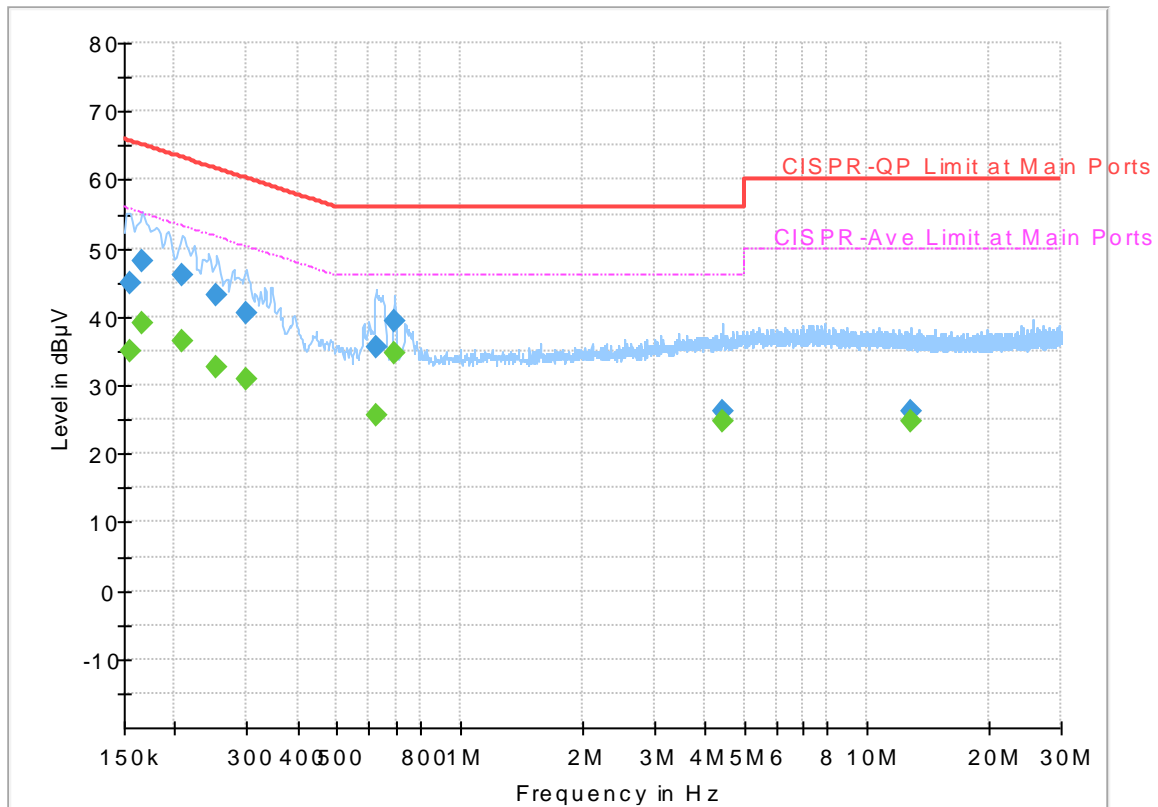

## Final\_Result

| Frequency (MHz) | QuasiPeak (dBµV) | Average (dBµV) | Limit (dBµV) | Margin (dB) | Line | Filter | Corr. (dB) |
|-----------------|------------------|----------------|--------------|-------------|------|--------|------------|
| 0.154500        | 44.98            | ---            | 65.75        | 20.77       | N    | OFF    | 19.5       |
| 0.154500        | ---              | 35.02          | 55.75        | 20.73       | N    | OFF    | 19.5       |
| 0.165750        | 48.03            | ---            | 65.17        | 17.14       | N    | OFF    | 19.5       |
| 0.165750        | ---              | 38.98          | 55.17        | 16.19       | N    | OFF    | 19.5       |
| 0.208500        | 45.95            | ---            | 63.27        | 17.32       | N    | OFF    | 19.5       |
| 0.208500        | ---              | 36.56          | 53.27        | 16.71       | N    | OFF    | 19.5       |
| 0.253500        | 43.10            | ---            | 61.64        | 18.54       | N    | OFF    | 19.5       |
| 0.253500        | ---              | 32.70          | 51.64        | 18.94       | N    | OFF    | 19.5       |
| 0.298500        | 40.41            | ---            | 60.28        | 19.87       | N    | OFF    | 19.5       |
| 0.298500        | ---              | 31.00          | 50.28        | 19.28       | N    | OFF    | 19.5       |
| 0.624750        | 35.63            | ---            | 56.00        | 20.37       | N    | OFF    | 19.5       |
| 0.624750        | ---              | 25.62          | 46.00        | 20.38       | N    | OFF    | 19.5       |
| 0.690000        | 39.34            | ---            | 56.00        | 16.66       | N    | OFF    | 19.5       |
| 0.690000        | ---              | 34.68          | 46.00        | 11.32       | N    | OFF    | 19.5       |
| 4.418250        | 26.14            | ---            | 56.00        | 29.86       | N    | OFF    | 19.6       |
| 4.418250        | ---              | 24.69          | 46.00        | 21.31       | N    | OFF    | 19.6       |
| 12.808500       | 26.24            | ---            | 60.00        | 33.76       | N    | OFF    | 19.8       |
| 12.808500       | ---              | 24.76          | 50.00        | 25.24       | N    | OFF    | 19.8       |



## Appendix C. Radiated Spurious Emission

|                 |                               |                     |         |
|-----------------|-------------------------------|---------------------|---------|
| Test Engineer : | Hao Hsu, Jacky Hung and KenWu | Temperature :       | 22~25°C |
|                 |                               | Relative Humidity : | 52~57%  |

<Single Mode>

### Band 1 - 5150~5250MHz

#### WIFI 802.11a (Band Edge @ 3m)

| WIFI Ant.                   | Note | Frequency ( MHz ) | Level ( dBμV/m ) | Over Limit ( dB ) | Limit Line ( dBμV/m ) | Read Level ( dBμV ) | Antenna Factor ( dB/m ) | Path Loss ( dB ) | Preamp Factor ( dB ) | Ant Pos ( cm ) | Table Pos ( deg ) | Peak Avg. ( P/A ) | Pol. ( H/V ) |   |
|-----------------------------|------|-------------------|------------------|-------------------|-----------------------|---------------------|-------------------------|------------------|----------------------|----------------|-------------------|-------------------|--------------|---|
| 802.11a<br>CH 36<br>5180MHz |      | 5148.46           | 55.74            | -18.26            | 74                    | 47.97               | 31.75                   | 9.05             | 33.03                | 388            | 161               | P                 | H            |   |
|                             |      | 5150              | 47.35            | -6.65             | 54                    | 39.58               | 31.75                   | 9.05             | 33.03                | 388            | 161               | A                 | H            |   |
|                             | *    | 5180              | 110.57           | -                 | -                     | 102.75              | 31.78                   | 9.07             | 33.03                | 388            | 161               | P                 | H            |   |
|                             | *    | 5180              | 101.05           | -                 | -                     | 93.23               | 31.78                   | 9.07             | 33.03                | 388            | 161               | A                 | H            |   |
|                             |      |                   |                  |                   |                       |                     |                         |                  |                      |                |                   |                   | H            |   |
|                             |      |                   |                  |                   |                       |                     |                         |                  |                      |                |                   |                   |              | H |
|                             |      |                   | 5149.5           | 61.04             | -12.96                | 74                  | 53.27                   | 31.75            | 9.05                 | 33.03          | 100               | 171               | P            | V |
|                             |      |                   | 5150             | 52.61             | -1.39                 | 54                  | 44.84                   | 31.75            | 9.05                 | 33.03          | 100               | 171               | A            | V |
|                             | *    |                   | 5180             | 116.12            | -                     | -                   | 108.3                   | 31.78            | 9.07                 | 33.03          | 100               | 171               | P            | V |
|                             | *    |                   | 5180             | 106.52            | -                     | -                   | 98.7                    | 31.78            | 9.07                 | 33.03          | 100               | 171               | A            | V |
| 802.11a<br>CH 44<br>5220MHz |      | 5129.48           | 50.14            | -23.86            | 74                    | 42.41               | 31.73                   | 9.03             | 33.03                | 100            | 159               | P                 | H            |   |
|                             |      | 5150              | 40.83            | -13.17            | 54                    | 33.06               | 31.75                   | 9.05             | 33.03                | 100            | 159               | A                 | H            |   |
|                             | *    | 5220              | 111.38           | -                 | -                     | 103.48              | 31.82                   | 9.11             | 33.03                | 100            | 159               | P                 | H            |   |
|                             | *    | 5220              | 101.97           | -                 | -                     | 94.07               | 31.82                   | 9.11             | 33.03                | 100            | 159               | A                 | H            |   |
|                             |      |                   | 5418.24          | 47.71             | -26.29                | 74                  | 39.49                   | 32.02            | 9.22                 | 33.02          | 100               | 159               | P            | H |
|                             |      |                   | 5452.32          | 39.14             | -14.86                | 54                  | 30.82                   | 32.05            | 9.29                 | 33.02          | 100               | 159               | A            | H |
|                             |      |                   | 5072.54          | 50.62             | -23.38                | 74                  | 42.99                   | 31.68            | 8.99                 | 33.04          | 249               | 227               | P            | V |
|                             |      |                   | 5135.98          | 42.37             | -11.63                | 54                  | 34.62                   | 31.73            | 9.05                 | 33.03          | 249               | 227               | A            | V |
|                             | *    |                   | 5220             | 119.2             | -                     | -                   | 111.3                   | 31.82            | 9.11                 | 33.03          | 249               | 227               | P            | V |
|                             | *    |                   | 5220             | 109.81            | -                     | -                   | 101.91                  | 31.82            | 9.11                 | 33.03          | 249               | 227               | A            | V |
|                             |      | 5419.68           | 47.18            | -26.82            | 74                    | 38.92               | 32.02                   | 9.26             | 33.02                | 249            | 227               | P                 | V            |   |
|                             |      | 5350.08           | 39.12            | -14.88            | 54                    | 31.01               | 31.95                   | 9.19             | 33.03                | 249            | 227               | A                 | V            |   |



|                                      |   |         |        |        |    |        |       |      |       |     |     |   |   |
|--------------------------------------|---|---------|--------|--------|----|--------|-------|------|-------|-----|-----|---|---|
| <b>802.11a<br/>CH 48<br/>5240MHz</b> |   | 5060.84 | 48.44  | -25.56 | 74 | 40.82  | 31.67 | 8.99 | 33.04 | 104 | 215 | P | H |
|                                      |   | 5085.8  | 40.12  | -13.88 | 54 | 32.47  | 31.68 | 9.01 | 33.04 | 104 | 215 | A | H |
|                                      | *   | 5240    | 112.43 | -      | -  | 104.51 | 31.83 | 9.12 | 33.03 | 104 | 215 | P | H |
|                                      | *   | 5240    | 102.78 | -      | -  | 94.86  | 31.83 | 9.12 | 33.03 | 104 | 215 | A | H |
|                                      |   | 5369.28 | 48.29  | -25.71 | 74 | 40.15  | 31.97 | 9.2  | 33.03 | 104 | 215 | P | H |
|                                      |   | 5352.72 | 39.15  | -14.85 | 54 | 31.04  | 31.95 | 9.19 | 33.03 | 104 | 215 | A | H |
|                                      |   | 5117.26 | 50.55  | -23.45 | 74 | 42.84  | 31.72 | 9.03 | 33.04 | 248 | 229 | P | V |
|                                      |   | 5135.98 | 42.21  | -11.79 | 54 | 34.46  | 31.73 | 9.05 | 33.03 | 248 | 229 | A | V |
|                                      | *   | 5240    | 118.22 | -      | -  | 110.3  | 31.83 | 9.12 | 33.03 | 248 | 229 | P | V |
|                                      | *   | 5240    | 108.9  | -      | -  | 100.98 | 31.83 | 9.12 | 33.03 | 248 | 229 | A | V |
|                                      |   | 5415.36 | 47.36  | -26.64 | 74 | 39.14  | 32.02 | 9.22 | 33.02 | 248 | 229 | P | V |
|                                      |   | 5352.96 | 38.98  | -15.02 | 54 | 30.87  | 31.95 | 9.19 | 33.03 | 248 | 229 | A | V |
| <b>Remark</b>                        | <ol style="list-style-type: none"> <li>1. No other spurious found.</li> <li>2. All results are PASS against Peak and Average limit line.</li> </ol> |         |        |        |    |        |       |      |       |     |     |   |   |



**Band 1 5150~5250MHz**  
**WIFI 802.11a (Harmonic @ 3m)**

| WIFI Ant. 1                 | Note  | Frequency ( MHz ) | Level ( dBμV/m ) | Over Limit ( dB ) | Limit Line ( dBμV/m ) | Read Level (dBμV) | Antenna Factor ( dB/m ) | Path Loss ( dB ) | Preamp Factor ( dB ) | Ant Pos ( cm ) | Table Pos ( deg ) | Peak Avg. (P/A) | Pol. (H/V) |
|-----------------------------|---|-------------------|------------------|-------------------|-----------------------|-------------------|-------------------------|------------------|----------------------|----------------|-------------------|-----------------|------------|
| 802.11a<br>CH 36<br>5180MHz |   | 10360             | 47.18            | -21.02            | 68.2                  | 57.93             | 39.51                   | 14.94            | 65.2                 | 100            | 0                 | P               | H          |
|                             |   | 15540             | 58.23            | -15.77            | 74                    | 65.87             | 38                      | 18.34            | 63.98                | 220            | 93                | P               | H          |
|                             |   | 15540             | 42.01            | -11.99            | 54                    | 49.65             | 38                      | 18.34            | 63.98                | 220            | 93                | A               | H          |
|                             |   |                   |                  |                   |                       |                   |                         |                  |                      |                |                   |                 | H          |
|                             |   | 10360             | 49.69            | -18.51            | 68.2                  | 60.44             | 39.51                   | 14.94            | 65.2                 | 100            | 0                 | P               | V          |
|                             |   | 15540             | 61.87            | -12.13            | 74                    | 69.51             | 38                      | 18.34            | 63.98                | 210            | 281               | P               | V          |
|                             |   | 15540             | 45.61            | -8.39             | 54                    | 53.25             | 38                      | 18.34            | 63.98                | 210            | 281               | A               | V          |
|                             |   |                   |                  |                   |                       |                   |                         |                  |                      |                |                   |                 | V          |
| 802.11a<br>CH 44<br>5220MHz |   | 10440             | 44.17            | -24.03            | 68.2                  | 54.77             | 39.61                   | 14.99            | 65.2                 | 100            | 0                 | P               | H          |
|                             |   | 15660             | 66.07            | -7.93             | 74                    | 74.23             | 37.67                   | 18.41            | 64.24                | 224            | 84                | P               | H          |
|                             |   | 15660             | 51.82            | -2.18             | 54                    | 59.98             | 37.67                   | 18.41            | 64.24                | 224            | 84                | A               | H          |
|                             |   |                   |                  |                   |                       |                   |                         |                  |                      |                |                   |                 | H          |
|                             |   | 10440             | 46.69            | -21.51            | 68.2                  | 57.29             | 39.61                   | 14.99            | 65.2                 | 100            | 0                 | P               | V          |
|                             |   | 15660             | 58.47            | -15.53            | 74                    | 66.63             | 37.67                   | 18.41            | 64.24                | 100            | 283               | P               | V          |
|                             |   | 15660             | 44.83            | -9.17             | 54                    | 52.99             | 37.67                   | 18.41            | 64.24                | 100            | 283               | A               | V          |
|                             |   |                   |                  |                   |                       |                   |                         |                  |                      |                |                   |                 | V          |
| 802.11a<br>CH 48<br>5240MHz |   | 10480             | 46.37            | -21.83            | 68.2                  | 56.86             | 39.68                   | 15.03            | 65.2                 | 100            | 0                 | P               | H          |
|                             |   | 15720             | 64.62            | -9.38             | 74                    | 73.11             | 37.47                   | 18.43            | 64.39                | 228            | 62                | P               | H          |
|                             |   | 15720             | 51.05            | -2.95             | 54                    | 59.54             | 37.47                   | 18.43            | 64.39                | 228            | 62                | A               | H          |
|                             |   |                   |                  |                   |                       |                   |                         |                  |                      |                |                   |                 | H          |
|                             |   | 10480             | 48.21            | -19.99            | 68.2                  | 58.7              | 39.68                   | 15.03            | 65.2                 | 100            | 0                 | P               | V          |
|                             |   | 15720             | 58.75            | -15.25            | 74                    | 67.24             | 37.47                   | 18.43            | 64.39                | 193            | 60                | P               | V          |
|                             |   | 15720             | 45.06            | -8.94             | 54                    | 53.55             | 37.47                   | 18.43            | 64.39                | 193            | 60                | A               | V          |
|                             |   |                   |                  |                   |                       |                   |                         |                  |                      |                |                   |                 | V          |
| <b>Remark</b>               | 1. No other spurious found.<br>2. All results are PASS against Peak and Average limit line. |                   |                  |                   |                       |                   |                         |                  |                      |                |                   |                 |            |



**Band 1 5150~5250MHz**  
**WIFI 802.11ac VHT20 (Band Edge @ 3m)**

| WIFI Ant. 1                  | Note | Frequency ( MHz ) | Level ( dBμV/m ) | Over Limit ( dB ) | Limit Line ( dBμV/m ) | Read Level ( dBμV ) | Antenna Factor ( dB/m ) | Path Loss ( dB ) | Preamp Factor ( dB ) | Ant Pos ( cm ) | Table Pos ( deg ) | Peak Avg. ( P/A ) | Pol. ( H/V ) |   |
|------------------------------|------|-------------------|------------------|-------------------|-----------------------|---------------------|-------------------------|------------------|----------------------|----------------|-------------------|-------------------|--------------|---|
| 802.11ac VHT20 CH 36 5180MHz |      | 5149.76           | 54.62            | -19.38            | 74                    | 46.85               | 31.75                   | 9.05             | 33.03                | 389            | 158               | P                 | H            |   |
|                              |      | 5150              | 46.39            | -7.61             | 54                    | 38.62               | 31.75                   | 9.05             | 33.03                | 389            | 158               | A                 | H            |   |
|                              | *    | 5180              | 110.67           | -                 | -                     | 102.85              | 31.78                   | 9.07             | 33.03                | 389            | 158               | P                 | H            |   |
|                              | *    | 5180              | 100.47           | -                 | -                     | 92.65               | 31.78                   | 9.07             | 33.03                | 389            | 158               | A                 | H            |   |
|                              |      |                   |                  |                   |                       |                     |                         |                  |                      |                |                   |                   | H            |   |
|                              |      |                   |                  |                   |                       |                     |                         |                  |                      |                |                   |                   |              | H |
|                              |      |                   | 5148.98          | 58.77             | -15.23                | 74                  | 51                      | 31.75            | 9.05                 | 33.03          | 100               | 172               | P            | V |
|                              |      |                   | 5149.5           | 51.16             | -2.84                 | 54                  | 43.39                   | 31.75            | 9.05                 | 33.03          | 100               | 172               | A            | V |
|                              |      | *                 | 5180             | 116.18            | -                     | -                   | 108.36                  | 31.78            | 9.07                 | 33.03          | 100               | 172               | P            | V |
|                              |      | *                 | 5180             | 105.97            | -                     | -                   | 98.15                   | 31.78            | 9.07                 | 33.03          | 100               | 172               | A            | V |
|                              |      |                   |                  |                   |                       |                     |                         |                  |                      |                |                   |                   | V            |   |
|                              |      |                   |                  |                   |                       |                     |                         |                  |                      |                |                   |                   | V            |   |
| 802.11ac VHT20 CH 44 5220MHz |      | 5138.06           | 48.65            | -25.35            | 74                    | 40.9                | 31.73                   | 9.05             | 33.03                | 100            | 210               | P                 | H            |   |
|                              |      | 5097.24           | 39.74            | -14.26            | 54                    | 32.07               | 31.7                    | 9.01             | 33.04                | 100            | 210               | A                 | H            |   |
|                              |      | * 5220            | 113.92           | -                 | -                     | 106.02              | 31.82                   | 9.11             | 33.03                | 100            | 210               | P                 | H            |   |
|                              |      | * 5220            | 103.86           | -                 | -                     | 95.96               | 31.82                   | 9.11             | 33.03                | 100            | 210               | A                 | H            |   |
|                              |      |                   | 5351.28          | 48.4              | -25.6                 | 74                  | 40.29                   | 31.95            | 9.19                 | 33.03          | 100               | 210               | P            | H |
|                              |      |                   | 5350.08          | 39.08             | -14.92                | 54                  | 30.97                   | 31.95            | 9.19                 | 33.03          | 100               | 210               | A            | H |
|                              |      |                   | 5111.02          | 50.11             | -23.89                | 74                  | 42.4                    | 31.72            | 9.03                 | 33.04          | 105               | 187               | P            | V |
|                              |      |                   | 5149.76          | 41.97             | -12.03                | 54                  | 34.2                    | 31.75            | 9.05                 | 33.03          | 105               | 187               | A            | V |
|                              |      | *                 | 5220             | 118.68            | -                     | -                   | 110.78                  | 31.82            | 9.11                 | 33.03          | 105               | 187               | P            | V |
|                              |      | *                 | 5220             | 108.72            | -                     | -                   | 100.82                  | 31.82            | 9.11                 | 33.03          | 105               | 187               | A            | V |
|                              |      | 5455.92           | 48.97            | -25.03            | 74                    | 40.65               | 32.05                   | 9.29             | 33.02                | 105            | 187               | P                 | V            |   |
|                              |      | 5352.24           | 39.38            | -14.62            | 54                    | 31.27               | 31.95                   | 9.19             | 33.03                | 105            | 187               | A                 | V            |   |





|   |   |         |        |        |    |        |       |      |       |     |     |   |   |
|---|---|---------|--------|--------|----|--------|-------|------|-------|-----|-----|---|---|
| <b>802.11ac</b><br><br><b>VHT20</b><br><br><b>CH 48</b><br><br><b>5240MHz</b> |   | 5074.1  | 49.62  | -24.38 | 74 | 41.99  | 31.68 | 8.99 | 33.04 | 100 | 210 | P | H |
|   |   | 5073.06 | 39.75  | -14.25 | 54 | 32.12  | 31.68 | 8.99 | 33.04 | 100 | 210 | A | H |
|   | *   | 5240    | 113.68 | -      | -  | 105.76 | 31.83 | 9.12 | 33.03 | 100 | 210 | P | H |
|   | *   | 5240    | 103.77 | -      | -  | 95.85  | 31.83 | 9.12 | 33.03 | 100 | 210 | A | H |
|   |   | 5373.12 | 48.03  | -25.97 | 74 | 39.89  | 31.97 | 9.2  | 33.03 | 100 | 210 | P | H |
|   |   | 5356.32 | 39.17  | -14.83 | 54 | 31.06  | 31.95 | 9.19 | 33.03 | 100 | 210 | A | H |
|   |   | 5102.44 | 53.54  | -20.46 | 74 | 45.87  | 31.7  | 9.01 | 33.04 | 100 | 177 | P | V |
|   |   | 5135.98 | 41.82  | -12.18 | 54 | 34.07  | 31.73 | 9.05 | 33.03 | 100 | 177 | A | V |
|   | *   | 5240    | 119    | -      | -  | 111.08 | 31.83 | 9.12 | 33.03 | 100 | 177 | P | V |
|   | *   | 5240    | 109.16 | -      | -  | 101.24 | 31.83 | 9.12 | 33.03 | 100 | 177 | A | V |
|   |   | 5376    | 48.41  | -25.59 | 74 | 40.26  | 31.97 | 9.2  | 33.02 | 100 | 177 | P | V |
|   |   | 5350.08 | 39.49  | -14.51 | 54 | 31.38  | 31.95 | 9.19 | 33.03 | 100 | 177 | A | V |
| <b>Remark</b>   | 1. No other spurious found.<br>2. All results are PASS against Peak and Average limit line. |         |        |        |    |        |       |      |       |     |     |   |   |



**Band 1 5150~5250MHz**  
**WIFI 802.11ac VHT20 (Harmonic @ 3m)**

| WIFI Ant. 1                  | Note  | Frequency ( MHz ) | Level ( dBμV/m ) | Over Limit ( dB ) | Limit Line ( dBμV/m ) | Read Level ( dBμV ) | Antenna Factor ( dB/m ) | Path Loss ( dB ) | Preamp Factor ( dB ) | Ant Pos ( cm ) | Table Pos ( deg ) | Peak Avg. ( P/A ) | Pol. ( H/V ) |   |
|------------------------------|---|-------------------|------------------|-------------------|-----------------------|---------------------|-------------------------|------------------|----------------------|----------------|-------------------|-------------------|--------------|---|
| 802.11ac VHT20 CH 36 5180MHz |   | 10360             | 45.95            | -22.25            | 68.2                  | 56.7                | 39.51                   | 14.94            | 65.2                 | 100            | 0                 | P                 | H            |   |
|                              |   | 15540             | 49.77            | -24.23            | 74                    | 57.41               | 38                      | 18.34            | 63.98                | 100            | 0                 | P                 | H            |   |
|                              |   |                   |                  |                   |                       |                     |                         |                  |                      |                |                   |                   | H            |   |
|                              |   |                   |                  |                   |                       |                     |                         |                  |                      |                |                   |                   | H            |   |
|                              |   |                   | 10360            | 46.89             | -21.31                | 68.2                | 57.64                   | 39.51            | 14.94                | 65.2           | 100               | 0                 | P            | V |
|                              |   |                   | 15540            | 60.76             | -13.24                | 74                  | 68.4                    | 38               | 18.34                | 63.98          | 211               | 278               | P            | V |
|                              |   |                   | 15540            | 43.27             | -10.73                | 54                  | 50.91                   | 38               | 18.34                | 63.98          | 211               | 278               | A            | V |
| 802.11ac VHT20 CH 44 5220MHz |   | 10440             | 45.27            | -22.93            | 68.2                  | 55.87               | 39.61                   | 14.99            | 65.2                 | 100            | 0                 | P                 | H            |   |
|                              |   | 15660             | 66.84            | -7.16             | 74                    | 75                  | 37.67                   | 18.41            | 64.24                | 224            | 92                | P                 | H            |   |
|                              |   | 15660             | 51.39            | -2.61             | 54                    | 59.55               | 37.67                   | 18.41            | 64.24                | 224            | 92                | A                 | H            |   |
|                              |   |                   |                  |                   |                       |                     |                         |                  |                      |                |                   |                   | H            |   |
|                              |   |                   | 10440            | 47.34             | -20.86                | 68.2                | 57.94                   | 39.61            | 14.99                | 65.2           | 100               | 0                 | P            | V |
|                              |   |                   | 15660            | 62.39             | -11.61                | 74                  | 70.55                   | 37.67            | 18.41                | 64.24          | 211               | 286               | P            | V |
|                              |   |                   | 15660            | 47.34             | -6.66                 | 54                  | 55.5                    | 37.67            | 18.41                | 64.24          | 211               | 286               | A            | V |
| 802.11ac VHT20 CH 48 5240MHz |   | 10480             | 45.86            | -22.34            | 68.2                  | 56.35               | 39.68                   | 15.03            | 65.2                 | 100            | 0                 | P                 | H            |   |
|                              |   | 15720             | 66.51            | -7.49             | 74                    | 75                  | 37.47                   | 18.43            | 64.39                | 181            | 27                | P                 | H            |   |
|                              |   | 15720             | 52.24            | -1.76             | 54                    | 60.73               | 37.47                   | 18.43            | 64.39                | 181            | 27                | A                 | H            |   |
|                              |   |                   |                  |                   |                       |                     |                         |                  |                      |                |                   |                   | H            |   |
|                              |   |                   | 10480            | 50.09             | -18.11                | 68.2                | 60.58                   | 39.68            | 15.03                | 65.2           | 100               | 0                 | P            | V |
|                              |   |                   | 15720            | 60.71             | -13.29                | 74                  | 69.2                    | 37.47            | 18.43                | 64.39          | 100               | 183               | P            | V |
|                              |   |                   | 15720            | 44.91             | -9.09                 | 54                  | 53.4                    | 37.47            | 18.43                | 64.39          | 100               | 183               | A            | V |
|                              |   |                   |                  |                   |                       |                     |                         |                  |                      |                |                   |                   | V            |   |
| <b>Remark</b>                | 1. No other spurious found.<br>2. All results are PASS against Peak and Average limit line. |                   |                  |                   |                       |                     |                         |                  |                      |                |                   |                   |              |   |



**Band 1 5150~5250MHz**  
**WIFI 802.11ac VHT40 (Band Edge @ 3m)**

| WIFI Ant. 1                  | Note  | Frequency ( MHz ) | Level ( dBμV/m ) | Over Limit ( dB ) | Limit Line ( dBμV/m ) | Read Level ( dBμV ) | Antenna Factor ( dB/m ) | Path Loss ( dB ) | Preamp Factor ( dB ) | Ant Pos ( cm ) | Table Pos ( deg ) | Peak Avg. ( P/A ) | Pol. ( H/V ) |
|------------------------------|---|-------------------|------------------|-------------------|-----------------------|---------------------|-------------------------|------------------|----------------------|----------------|-------------------|-------------------|--------------|
| 802.11ac VHT40 CH 38 5190MHz |   | 5145.34           | 52.5             | -21.5             | 74                    | 44.73               | 31.75                   | 9.05             | 33.03                | 102            | 161               | P                 | H            |
|                              |   | 5150              | 46.63            | -7.37             | 54                    | 38.86               | 31.75                   | 9.05             | 33.03                | 102            | 161               | A                 | H            |
|                              | *   | 5190              | 104.05           | -                 | -                     | 96.21               | 31.78                   | 9.09             | 33.03                | 102            | 161               | P                 | H            |
|                              | *   | 5190              | 95.02            | -                 | -                     | 87.18               | 31.78                   | 9.09             | 33.03                | 102            | 161               | A                 | H            |
|                              |   | 5411.84           | 47.18            | -26.82            | 74                    | 38.96               | 32.02                   | 9.22             | 33.02                | 102            | 161               | P                 | H            |
|                              |   | 5456.92           | 39.1             | -14.9             | 54                    | 30.78               | 32.05                   | 9.29             | 33.02                | 102            | 161               | A                 | H            |
|                              |   | 5150              | 57.08            | -16.92            | 74                    | 49.31               | 31.75                   | 9.05             | 33.03                | 247            | 208               | P                 | V            |
|                              |   | 5149.5            | 50.2             | -3.8              | 54                    | 42.43               | 31.75                   | 9.05             | 33.03                | 247            | 208               | A                 | V            |
|                              | *   | 5190              | 111.26           | -                 | -                     | 103.42              | 31.78                   | 9.09             | 33.03                | 247            | 208               | P                 | V            |
|                              | *   | 5190              | 101.92           | -                 | -                     | 94.08               | 31.78                   | 9.09             | 33.03                | 247            | 208               | A                 | V            |
|                              |   | 5432.28           | 48.36            | -25.64            | 74                    | 40.09               | 32.03                   | 9.26             | 33.02                | 247            | 208               | P                 | V            |
|                              |   | 5438.44           | 38.95            | -15.05            | 54                    | 30.68               | 32.03                   | 9.26             | 33.02                | 247            | 208               | A                 | V            |
| 802.11ac VHT40 CH 46 5230MHz |   | 5112.84           | 49.4             | -24.6             | 74                    | 41.69               | 31.72                   | 9.03             | 33.04                | 111            | 215               | P                 | H            |
|                              |   | 5149.76           | 40.89            | -13.11            | 54                    | 33.12               | 31.75                   | 9.05             | 33.03                | 111            | 215               | A                 | H            |
|                              | *   | 5230              | 108.81           | -                 | -                     | 100.9               | 31.83                   | 9.11             | 33.03                | 111            | 215               | P                 | H            |
|                              | *   | 5230              | 99.54            | -                 | -                     | 91.63               | 31.83                   | 9.11             | 33.03                | 111            | 215               | A                 | H            |
|                              |   | 5400.72           | 47.48            | -26.52            | 74                    | 39.28               | 32                      | 9.22             | 33.02                | 111            | 215               | P                 | H            |
|                              |   | 5350.32           | 39.45            | -14.55            | 54                    | 31.34               | 31.95                   | 9.19             | 33.03                | 111            | 215               | A                 | H            |
|                              |   | 5142.74           | 59.28            | -14.72            | 74                    | 51.51               | 31.75                   | 9.05             | 33.03                | 248            | 226               | P                 | V            |
|                              |   | 5147.94           | 50.71            | -3.29             | 54                    | 42.94               | 31.75                   | 9.05             | 33.03                | 248            | 226               | A                 | V            |
|                              | *   | 5230              | 115.34           | -                 | -                     | 107.43              | 31.83                   | 9.11             | 33.03                | 248            | 226               | P                 | V            |
|                              | *   | 5230              | 105.5            | -                 | -                     | 97.59               | 31.83                   | 9.11             | 33.03                | 248            | 226               | A                 | V            |
|                              | 5436.48   | 47.72             | -26.28           | 74                | 39.45                 | 32.03               | 9.26                    | 33.02            | 248                  | 226            | P                 | V                 |              |
|                              | 5350.56   | 40                | -14              | 54                | 31.89                 | 31.95               | 9.19                    | 33.03            | 248                  | 226            | A                 | V                 |              |
| Remark                       | 1. No other spurious found.<br>2. All results are PASS against Peak and Average limit line. |                   |                  |                   |                       |                     |                         |                  |                      |                |                   |                   |              |



**Band 1 5150~5250MHz**  
**WIFI 802.11ac VHT40 (Harmonic @ 3m)**

| WIFI Ant. 1                  | Note  | Frequency ( MHz ) | Level ( dBμV/m ) | Over Limit ( dB ) | Limit Line ( dBμV/m ) | Read Level ( dBμV ) | Antenna Factor ( dB/m ) | Path Loss ( dB ) | Preamp Factor ( dB ) | Ant Pos ( cm ) | Table Pos ( deg ) | Peak Avg. ( P/A ) | Pol. ( H/V ) |   |
|------------------------------|---|-------------------|------------------|-------------------|-----------------------|---------------------|-------------------------|------------------|----------------------|----------------|-------------------|-------------------|--------------|---|
| 802.11ac VHT40 CH 38 5190MHz |   | 10380             | 44.45            | -23.75            | 68.2                  | 55.16               | 39.54                   | 14.95            | 65.2                 | 100            | 0                 | P                 | H            |   |
|                              |   | 15570             | 44.37            | -29.63            | 74                    | 52.15               | 37.91                   | 18.36            | 64.05                | 100            | 0                 | P                 | H            |   |
|                              |   |                   |                  |                   |                       |                     |                         |                  |                      |                |                   |                   | H            |   |
|                              |   |                   |                  |                   |                       |                     |                         |                  |                      |                |                   |                   | H            |   |
|                              |   |                   | 10380            | 46.34             | -21.86                | 68.2                | 57.05                   | 39.54            | 14.95                | 65.2           | 100               | 0                 | P            | V |
|                              |   |                   | 15570            | 44.15             | -29.85                | 74                  | 51.93                   | 37.91            | 18.36                | 64.05          | 100               | 0                 | P            | V |
|                              |   |                   |                  |                   |                       |                     |                         |                  |                      |                |                   |                   |              | V |
| 802.11ac VHT40 CH 46 5230MHz |   | 10460             | 44.98            | -23.22            | 68.2                  | 55.55               | 39.63                   | 15               | 65.2                 | 100            | 0                 | P                 | H            |   |
|                              |   | 15690             | 58.13            | -15.87            | 74                    | 66.47               | 37.57                   | 18.41            | 64.32                | 224            | 92                | P                 | H            |   |
|                              |   | 15690             | 46.36            | -7.64             | 54                    | 54.7                | 37.57                   | 18.41            | 64.32                | 224            | 92                | A                 | H            |   |
|                              |   |                   |                  |                   |                       |                     |                         |                  |                      |                |                   |                   | H            |   |
|                              |   |                   | 10460            | 45.85             | -22.35                | 68.2                | 56.42                   | 39.63            | 15                   | 65.2           | 100               | 0                 | P            | V |
|                              |   |                   | 15690            | 53.24             | -20.76                | 74                  | 61.58                   | 37.57            | 18.41                | 64.32          | 100               | 182               | P            | V |
|                              |   |                   | 15690            | 41.68             | -12.32                | 54                  | 50.02                   | 37.57            | 18.41                | 64.32          | 100               | 182               | A            | V |
|                              |   |                   |                  |                   |                       |                     |                         |                  |                      |                |                   |                   | V            |   |
| <b>Remark</b>                | 1. No other spurious found.<br>2. All results are PASS against Peak and Average limit line. |                   |                  |                   |                       |                     |                         |                  |                      |                |                   |                   |              |   |



Band 1 5150~5250MHz
WIFI 802.11ac VHT80 (Band Edge @ 3m)

Table with 14 columns: WIFI Ant. 1, Note, Frequency (MHz), Level (dBµV/m), Over Limit (dB), Limit Line (dBµV/m), Read Level (dBµV), Antenna Factor (dB/m), Path Loss (dB), Preamp Factor (dB), Ant Pos (cm), Table Pos (deg), Peak Avg. (P/A), Pol. (H/V). Rows include test results for 802.11ac VHT80 CH 42 5210MHz and a Remark section.



**Band 1 5150~5250MHz**  
**WIFI 802.11ac VHT80 (Harmonic @ 3m)**

| WIFI Ant. 1                  | Note  | Frequency ( MHz ) | Level ( dBμV/m ) | Over Limit ( dB ) | Limit Line ( dBμV/m ) | Read Level (dBμV) | Antenna Factor ( dB/m ) | Path Loss ( dB ) | Preamp Factor ( dB ) | Ant Pos ( cm ) | Table Pos ( deg ) | Peak Avg. (P/A) | Pol. (H/V) |   |
|------------------------------|---|-------------------|------------------|-------------------|-----------------------|-------------------|-------------------------|------------------|----------------------|----------------|-------------------|-----------------|------------|---|
| 802.11ac VHT80 CH 42 5210MHz |   | 10420             | 44.28            | -23.92            | 68.2                  | 54.92             | 39.58                   | 14.98            | 65.2                 | 100            | 0                 | P               | H          |   |
|                              |   | 15630             | 44.48            | -29.52            | 74                    | 52.58             | 37.71                   | 18.39            | 64.2                 | 100            | 0                 | P               | H          |   |
|                              |   |                   |                  |                   |                       |                   |                         |                  |                      |                |                   |                 | H          |   |
|                              |   |                   |                  |                   |                       |                   |                         |                  |                      |                |                   |                 | H          |   |
|                              |   |                   | 10420            | 43.63             | -24.57                | 68.2              | 54.27                   | 39.58            | 14.98                | 65.2           | 100               | 0               | P          | V |
|                              |   |                   | 15630            | 43.53             | -30.47                | 74                | 51.63                   | 37.71            | 18.39                | 64.2           | 100               | 0               | P          | V |
|                              |   |                   |                  |                   |                       |                   |                         |                  |                      |                |                   |                 |            | V |
|                              |   |                   |                  |                   |                       |                   |                         |                  |                      |                |                   |                 | V          |   |
| <b>Remark</b>                | 1. No other spurious found.<br>2. All results are PASS against Peak and Average limit line. |                   |                  |                   |                       |                   |                         |                  |                      |                |                   |                 |            |   |



Emission below 1GHz

WIFI 802.11a (LF @ 3m)

| WIFI          | Note   | Frequency | Level      | Over   | Limit      | Read     | Antenna  | Path   | Preamp | Ant    | Table   | Peak    | Pol.    |   |
|---------------|--|-----------|------------|--------|------------|----------|----------|--------|--------|--------|---------|---------|---------|---|
| Ant.          |  |           |            | Limit  | Line       | Level    | Factor   | Loss   | Factor | Pos    | Pos     | Avg.    |         |   |
| 1             |  | ( MHz )   | ( dBμV/m ) | ( dB ) | ( dBμV/m ) | ( dBμV ) | ( dB/m ) | ( dB ) | ( dB ) | ( cm ) | ( deg ) | ( P/A ) | ( H/V ) |   |
| 802.11a<br>LF |  | 46.47     | 28.63      | -11.37 | 40         | 44.38    | 15.72    | 1.02   | 32.49  | 100    | 0       | P       | H       |   |
|               |  | 131.52    | 28.16      | -15.34 | 43.5       | 41.77    | 17.28    | 1.51   | 32.45  | -      | -       | P       | H       |   |
|               |  | 180.66    | 26.12      | -17.38 | 43.5       | 42       | 14.75    | 1.69   | 32.41  | -      | -       | P       | H       |   |
|               |  | 738.9     | 32.94      | -13.06 | 46         | 34.09    | 27.68    | 3.4    | 32.36  | -      | -       | P       | H       |   |
|               |  | 885.9     | 34.6       | -11.4  | 46         | 33.37    | 29.07    | 3.73   | 31.73  | -      | -       | P       | H       |   |
|               |  | 926.5     | 33.23      | -12.77 | 46         | 31.11    | 29.55    | 3.82   | 31.42  | -      | -       | P       | H       |   |
|               |  |           |            |        |            |          |          |        |        |        |         |         |         | H |
|               |  |           |            |        |            |          |          |        |        |        |         |         |         | H |
|               |  |           |            |        |            |          |          |        |        |        |         |         |         | H |
|               |  |           |            |        |            |          |          |        |        |        |         |         |         | H |
|               |  |           |            |        |            |          |          |        |        |        |         |         |         | H |
|               |  |           |            |        |            |          |          |        |        |        |         |         |         | H |
|               |  |           | 40.53      | 32     | -8         | 40       | 44.98    | 18.68  | 0.82   | 32.49  | -       | -       | P       | V |
|               |  |           | 45.93      | 33.13  | -6.87      | 40       | 48.46    | 16.14  | 1.02   | 32.49  | 100     | 0       | P       | V |
|               |  |           | 53.49      | 29.32  | -10.68     | 40       | 47.8     | 12.98  | 1.02   | 32.49  | -       | -       | P       | V |
|               |  |           | 696.9      | 27.93  | -18.07     | 46       | 30.53    | 26.39  | 3.35   | 32.47  | -       | -       | P       | V |
|               |  |           | 746.6      | 36.68  | -9.32      | 46       | 37.66    | 27.78  | 3.44   | 32.33  | -       | -       | P       | V |
|               |  |           | 940.5      | 32.89  | -13.11     | 46       | 30.09    | 30.1   | 3.82   | 31.29  | -       | -       | P       | V |
|               |  |           |            |        |            |          |          |        |        |        |         |         | V       |   |
|               |  |           |            |        |            |          |          |        |        |        |         |         | V       |   |
|               |  |           |            |        |            |          |          |        |        |        |         |         | V       |   |
|               |  |           |            |        |            |          |          |        |        |        |         |         | V       |   |
|               |  |           |            |        |            |          |          |        |        |        |         |         | V       |   |
|               |  |           |            |        |            |          |          |        |        |        |         |         | V       |   |
| Remark        | 1. No other spurious found.<br>2. All results are PASS against limit line. |           |            |        |            |          |          |        |        |        |         |         |         |   |



<CDD Mode>

**Band 1 - 5150~5250MHz**  
**WIFI 802.11a (Band Edge @ 3m)**

| WIFI Ant.                   | Note | Frequency | Level      | Over Limit | Limit Line | Read Level | Antenna Factor | Path Loss | Preamp Factor | Ant Pos | Table Pos | Peak Avg. | Pol.    |   |
|-----------------------------|------|-----------|------------|------------|------------|------------|----------------|-----------|---------------|---------|-----------|-----------|---------|---|
| 1+2                         |      | ( MHz )   | ( dBμV/m ) | ( dB )     | ( dBμV/m ) | ( dBμV )   | ( dB/m )       | ( dB )    | ( dB )        | ( cm )  | ( deg )   | ( P/A )   | ( H/V ) |   |
| 802.11a<br>CH 36<br>5180MHz |      | 5150      | 55.87      | -18.13     | 74         | 48.1       | 31.75          | 9.05      | 33.03         | 348     | 160       | P         | H       |   |
|                             |      | 5150      | 49.23      | -4.77      | 54         | 41.46      | 31.75          | 9.05      | 33.03         | 348     | 160       | A         | H       |   |
|                             | *    | 5180      | 114.63     | -          | -          | 106.81     | 31.78          | 9.07      | 33.03         | 348     | 160       | P         | H       |   |
|                             | *    | 5180      | 105.47     | -          | -          | 97.65      | 31.78          | 9.07      | 33.03         | 348     | 160       | A         | H       |   |
|                             |      |           |            |            |            |            |                |           |               |         |           |           | H       |   |
|                             |      |           |            |            |            |            |                |           |               |         |           |           | H       |   |
|                             |      |           | 5149.76    | 58.9       | -15.1      | 74         | 51.13          | 31.75     | 9.05          | 33.03   | 123       | 162       | P       | V |
|                             |      |           | 5149.5     | 52.88      | -1.12      | 54         | 45.11          | 31.75     | 9.05          | 33.03   | 123       | 162       | A       | V |
|                             | *    |           | 5180       | 118.71     | -          | -          | 110.89         | 31.78     | 9.07          | 33.03   | 123       | 162       | P       | V |
|                             | *    |           | 5180       | 109.41     | -          | -          | 101.59         | 31.78     | 9.07          | 33.03   | 123       | 162       | A       | V |
|                             |      |           |            |            |            |            |                |           |               |         |           |           | V       |   |
|                             |      |           |            |            |            |            |                |           |               |         |           |           | V       |   |
| 802.11a<br>CH 44<br>5220MHz |      | 5089.7    | 50.7       | -23.3      | 74         | 43.03      | 31.7           | 9.01      | 33.04         | 384     | 155       | P         | H       |   |
|                             |      | 5119.86   | 41.62      | -12.38     | 54         | 33.9       | 31.72          | 9.03      | 33.03         | 384     | 155       | A         | H       |   |
|                             | *    | 5220      | 116.44     | -          | -          | 108.54     | 31.82          | 9.11      | 33.03         | 384     | 155       | P         | H       |   |
|                             | *    | 5220      | 107.79     | -          | -          | 99.89      | 31.82          | 9.11      | 33.03         | 384     | 155       | A         | H       |   |
|                             |      |           | 5370.72    | 48.97      | -25.03     | 74         | 40.83          | 31.97     | 9.2           | 33.03   | 384       | 155       | P       | H |
|                             |      |           | 5445.36    | 39.58      | -14.42     | 54         | 31.28          | 32.03     | 9.29          | 33.02   | 384       | 155       | A       | H |
|                             |      |           | 5082.42    | 53.22      | -20.78     | 74         | 45.57          | 31.68     | 9.01          | 33.04   | 246       | 172       | P       | V |
|                             |      |           | 5150       | 43.69      | -10.31     | 54         | 35.92          | 31.75     | 9.05          | 33.03   | 246       | 172       | A       | V |
|                             | *    |           | 5220       | 122.15     | -          | -          | 114.25         | 31.82     | 9.11          | 33.03   | 246       | 172       | P       | V |
|                             | *    |           | 5220       | 113.08     | -          | -          | 105.18         | 31.82     | 9.11          | 33.03   | 246       | 172       | A       | V |
|                             |      |           | 5442.72    | 48.71      | -25.29     | 74         | 40.44          | 32.03     | 9.26          | 33.02   | 246       | 172       | P       | V |
|                             |      |           | 5351.28    | 39.84      | -14.16     | 54         | 31.73          | 31.95     | 9.19          | 33.03   | 246       | 172       | A       | V |





|                                      |   |         |        |        |    |        |       |      |       |     |     |   |   |
|--------------------------------------|---|---------|--------|--------|----|--------|-------|------|-------|-----|-----|---|---|
| <b>802.11a<br/>CH 48<br/>5240MHz</b> |   | 5114.92 | 51.49  | -22.51 | 74 | 43.78  | 31.72 | 9.03 | 33.04 | 386 | 140 | P | H |
|                                      |   | 5148.72 | 42.17  | -11.83 | 54 | 34.4   | 31.75 | 9.05 | 33.03 | 386 | 140 | A | H |
|                                      | *   | 5240    | 117.34 | -      | -  | 109.42 | 31.83 | 9.12 | 33.03 | 386 | 140 | P | H |
|                                      | *   | 5240    | 107.85 | -      | -  | 99.93  | 31.83 | 9.12 | 33.03 | 386 | 140 | A | H |
|                                      |   | 5415.12 | 48.37  | -25.63 | 74 | 40.15  | 32.02 | 9.22 | 33.02 | 386 | 140 | P | H |
|                                      |   | 5350.32 | 39.85  | -14.15 | 54 | 31.74  | 31.95 | 9.19 | 33.03 | 386 | 140 | A | H |
|                                      |   | 5134.16 | 54.25  | -19.75 | 74 | 46.5   | 31.73 | 9.05 | 33.03 | 243 | 172 | P | V |
|                                      |   | 5149.5  | 44.29  | -9.71  | 54 | 36.52  | 31.75 | 9.05 | 33.03 | 243 | 172 | A | V |
|                                      | *   | 5240    | 122.7  | -      | -  | 114.78 | 31.83 | 9.12 | 33.03 | 243 | 172 | P | V |
|                                      | *   | 5240    | 113.38 | -      | -  | 105.46 | 31.83 | 9.12 | 33.03 | 243 | 172 | A | V |
|                                      |   | 5392.8  | 48.1   | -25.9  | 74 | 39.94  | 31.98 | 9.2  | 33.02 | 243 | 172 | P | V |
|                                      |   | 5350.32 | 40.79  | -13.21 | 54 | 32.68  | 31.95 | 9.19 | 33.03 | 243 | 172 | A | V |
| <b>Remark</b>                        | 3. No other spurious found.<br>4. All results are PASS against Peak and Average limit line. |         |        |        |    |        |       |      |       |     |     |   |   |



**Band 1 5150~5250MHz**  
**WIFI 802.11a (Harmonic @ 3m)**

| WIFI Ant. 1+2               | Note  | Frequency ( MHz ) | Level ( dBμV/m ) | Over Limit ( dB ) | Limit Line ( dBμV/m ) | Read Level ( dBμV ) | Antenna Factor ( dB/m ) | Path Loss ( dB ) | Preamp Factor ( dB ) | Ant Pos ( cm ) | Table Pos ( deg ) | Peak Avg. ( P/A ) | Pol. ( H/V ) |   |
|-----------------------------|---|-------------------|------------------|-------------------|-----------------------|---------------------|-------------------------|------------------|----------------------|----------------|-------------------|-------------------|--------------|---|
| 802.11a<br>CH 36<br>5180MHz |   | 10360             | 46.63            | -21.57            | 68.2                  | 57.38               | 39.51                   | 14.94            | 65.2                 | 100            | 0                 | P                 | H            |   |
|                             |   | 15540             | 55.5             | -18.5             | 74                    | 63.14               | 38                      | 18.34            | 63.98                | 100            | 181               | P                 | H            |   |
|                             |   | 15540             | 39.97            | -14.03            | 54                    | 47.61               | 38                      | 18.34            | 63.98                | 100            | 181               | A                 | H            |   |
|                             |   |                   |                  |                   |                       |                     |                         |                  |                      |                |                   |                   | H            |   |
|                             |   |                   | 10360            | 48.81             | -19.39                | 68.2                | 59.56                   | 39.51            | 14.94                | 65.2           | 100               | 0                 | P            | V |
|                             |   |                   | 15540            | 59.51             | -14.49                | 74                  | 67.15                   | 38               | 18.34                | 63.98          | 211               | 252               | P            | V |
|                             |   |                   | 15540            | 43.43             | -10.57                | 54                  | 51.07                   | 38               | 18.34                | 63.98          | 211               | 252               | A            | V |
| 802.11a<br>CH 44<br>5220MHz |   | 10440             | 46.38            | -21.82            | 68.2                  | 56.98               | 39.61                   | 14.99            | 65.2                 | 100            | 0                 | P                 | H            |   |
|                             |   | 15660             | 62.65            | -11.35            | 74                    | 70.81               | 37.67                   | 18.41            | 64.24                | 226            | 87                | P                 | H            |   |
|                             |   | 15660             | 50.01            | -3.99             | 54                    | 58.17               | 37.67                   | 18.41            | 64.24                | 226            | 87                | A                 | H            |   |
|                             |   |                   |                  |                   |                       |                     |                         |                  |                      |                |                   |                   | H            |   |
|                             |   |                   | 10440            | 49.22             | -18.98                | 68.2                | 59.82                   | 39.61            | 14.99                | 65.2           | 100               | 0                 | P            | V |
|                             |   |                   | 15660            | 61.11             | -12.89                | 74                  | 69.27                   | 37.67            | 18.41                | 64.24          | 400               | 177               | P            | V |
|                             |   |                   | 15660            | 47.05             | -6.95                 | 54                  | 55.21                   | 37.67            | 18.41                | 64.24          | 400               | 177               | A            | V |
| 802.11a<br>CH 48<br>5240MHz |   | 10480             | 48.53            | -19.67            | 68.2                  | 59.02               | 39.68                   | 15.03            | 65.2                 | 100            | 0                 | P                 | H            |   |
|                             |   | 15720             | 63.71            | -10.29            | 74                    | 72.2                | 37.47                   | 18.43            | 64.39                | 149            | 22                | P                 | H            |   |
|                             |   | 15720             | 51.03            | -2.97             | 54                    | 59.52               | 37.47                   | 18.43            | 64.39                | 149            | 22                | A                 | H            |   |
|                             |   |                   |                  |                   |                       |                     |                         |                  |                      |                |                   |                   | H            |   |
|                             |   |                   | 10480            | 52.86             | -15.34                | 68.2                | 63.35                   | 39.68            | 15.03                | 65.2           | 100               | 0                 | P            | V |
|                             |   |                   | 15720            | 60.53             | -13.47                | 74                  | 69.02                   | 37.47            | 18.43                | 64.39          | 100               | 182               | P            | V |
|                             |   |                   | 15720            | 48.04             | -5.96                 | 54                  | 56.53                   | 37.47            | 18.43                | 64.39          | 100               | 182               | A            | V |
|                             |   |                   |                  |                   |                       |                     |                         |                  |                      |                |                   |                   | V            |   |
| Remark                      | 3. No other spurious found.<br>4. All results are PASS against Peak and Average limit line. |                   |                  |                   |                       |                     |                         |                  |                      |                |                   |                   |              |   |



**Band 1 5150~5250MHz**  
**WIFI 802.11ac VHT20 (Band Edge @ 3m)**

| WIFI Ant. 1+2                | Note | Frequency ( MHz ) | Level ( dBμV/m ) | Over Limit ( dB ) | Limit Line ( dBμV/m ) | Read Level ( dBμV ) | Antenna Factor ( dB/m ) | Path Loss ( dB ) | Preamp Factor ( dB ) | Ant Pos ( cm ) | Table Pos ( deg ) | Peak Avg. ( P/A ) | Pol. ( H/V ) |   |
|------------------------------|------|-------------------|------------------|-------------------|-----------------------|---------------------|-------------------------|------------------|----------------------|----------------|-------------------|-------------------|--------------|---|
| 802.11ac VHT20 CH 36 5180MHz |      | 5147.42           | 53.36            | -20.64            | 74                    | 45.59               | 31.75                   | 9.05             | 33.03                | 350            | 161               | P                 | H            |   |
|                              |      | 5146.12           | 44.75            | -9.25             | 54                    | 36.98               | 31.75                   | 9.05             | 33.03                | 350            | 161               | A                 | H            |   |
|                              | *    | 5180              | 115              | -                 | -                     | 107.18              | 31.78                   | 9.07             | 33.03                | 350            | 161               | P                 | H            |   |
|                              | *    | 5180              | 105.21           | -                 | -                     | 97.39               | 31.78                   | 9.07             | 33.03                | 350            | 161               | A                 | H            |   |
|                              |      |                   |                  |                   |                       |                     |                         |                  |                      |                |                   |                   | H            |   |
|                              |      |                   |                  |                   |                       |                     |                         |                  |                      |                |                   |                   |              | H |
|                              |      |                   | 5150             | 56.11             | -17.89                | 74                  | 48.34                   | 31.75            | 9.05                 | 33.03          | 247               | 174               | P            | V |
|                              |      |                   | 5150             | 49.5              | -4.5                  | 54                  | 41.73                   | 31.75            | 9.05                 | 33.03          | 247               | 174               | A            | V |
|                              |      | *                 | 5180             | 119.77            | -                     | -                   | 111.95                  | 31.78            | 9.07                 | 33.03          | 247               | 174               | P            | V |
|                              |      | *                 | 5180             | 109.72            | -                     | -                   | 101.9                   | 31.78            | 9.07                 | 33.03          | 247               | 174               | A            | V |
|                              |      |                   |                  |                   |                       |                     |                         |                  |                      |                |                   |                   | V            |   |
|                              |      |                   |                  |                   |                       |                     |                         |                  |                      |                |                   |                   | V            |   |
| 802.11ac VHT20 CH 44 5220MHz |      | 5150              | 51.37            | -22.63            | 74                    | 43.6                | 31.75                   | 9.05             | 33.03                | 384            | 150               | P                 | H            |   |
|                              |      | 5150              | 43.58            | -10.42            | 54                    | 35.81               | 31.75                   | 9.05             | 33.03                | 384            | 150               | A                 | H            |   |
|                              |      | *                 | 5220             | 118.35            | -                     | -                   | 110.45                  | 31.82            | 9.11                 | 33.03          | 384               | 150               | P            | H |
|                              |      | *                 | 5220             | 108.46            | -                     | -                   | 100.56                  | 31.82            | 9.11                 | 33.03          | 384               | 150               | A            | H |
|                              |      |                   | 5429.76          | 47.8              | -26.2                 | 74                  | 39.53                   | 32.03            | 9.26                 | 33.02          | 384               | 150               | P            | H |
|                              |      |                   | 5459.28          | 39.16             | -14.84                | 54                  | 30.84                   | 32.05            | 9.29                 | 33.02          | 384               | 150               | A            | H |
|                              |      |                   | 5149.5           | 54.6              | -19.4                 | 74                  | 46.83                   | 31.75            | 9.05                 | 33.03          | 246               | 170               | P            | V |
|                              |      |                   | 5150             | 46.7              | -7.3                  | 54                  | 38.93                   | 31.75            | 9.05                 | 33.03          | 246               | 170               | A            | V |
|                              |      | *                 | 5220             | 123.51            | -                     | -                   | 115.61                  | 31.82            | 9.11                 | 33.03          | 246               | 170               | P            | V |
|                              |      | *                 | 5220             | 113.91            | -                     | -                   | 106.01                  | 31.82            | 9.11                 | 33.03          | 246               | 170               | A            | V |
|                              |      | 5358.24           | 48.15            | -25.85            | 74                    | 40.04               | 31.95                   | 9.19             | 33.03                | 246            | 170               | P                 | V            |   |
|                              |      | 5350.8            | 39.12            | -14.88            | 54                    | 31.01               | 31.95                   | 9.19             | 33.03                | 246            | 170               | A                 | V            |   |



|   |   |         |        |        |    |        |       |      |       |     |     |   |   |
|---|---|---------|--------|--------|----|--------|-------|------|-------|-----|-----|---|---|
| <b>802.11ac</b><br><b>VHT20</b><br><b>CH 48</b><br><b>5240MHz</b> |   | 5115.18 | 50.74  | -23.26 | 74 | 43.03  | 31.72 | 9.03 | 33.04 | 362 | 149 | P | H |
|   |   | 5150    | 41.03  | -12.97 | 54 | 33.26  | 31.75 | 9.05 | 33.03 | 362 | 149 | A | H |
|   | *   | 5240    | 117.7  | -      | -  | 109.78 | 31.83 | 9.12 | 33.03 | 362 | 149 | P | H |
|   | *   | 5240    | 108.2  | -      | -  | 100.28 | 31.83 | 9.12 | 33.03 | 362 | 149 | A | H |
|   |   | 5373.12 | 48.19  | -25.81 | 74 | 40.05  | 31.97 | 9.2  | 33.03 | 362 | 149 | P | H |
|   |   | 5355.36 | 39.38  | -14.62 | 54 | 31.27  | 31.95 | 9.19 | 33.03 | 362 | 149 | A | H |
|   |   | 5140.92 | 51.56  | -22.44 | 74 | 43.79  | 31.75 | 9.05 | 33.03 | 229 | 178 | P | V |
|   |   | 5150    | 42.56  | -11.44 | 54 | 34.79  | 31.75 | 9.05 | 33.03 | 229 | 178 | A | V |
|   | *   | 5240    | 123.26 | -      | -  | 115.34 | 31.83 | 9.12 | 33.03 | 229 | 178 | P | V |
|   | *   | 5240    | 113.45 | -      | -  | 105.53 | 31.83 | 9.12 | 33.03 | 229 | 178 | A | V |
|   |   | 5353.68 | 49.19  | -24.81 | 74 | 41.08  | 31.95 | 9.19 | 33.03 | 229 | 178 | P | V |
|   |   | 5354.88 | 40.16  | -13.84 | 54 | 32.05  | 31.95 | 9.19 | 33.03 | 229 | 178 | A | V |
| <b>Remark</b>   | 3. No other spurious found.<br>4. All results are PASS against Peak and Average limit line. |         |        |        |    |        |       |      |       |     |     |   |   |



**Band 1 5150~5250MHz**  
**WIFI 802.11ac VHT20 (Harmonic @ 3m)**

| WIFI Ant. 1+2                   | Note  | Frequency ( MHz ) | Level ( dBμV/m ) | Over Limit ( dB ) | Limit Line ( dBμV/m ) | Read Level ( dBμV ) | Antenna Factor ( dB/m ) | Path Loss ( dB ) | Preamp Factor ( dB ) | Ant Pos ( cm ) | Table Pos ( deg ) | Peak Avg. ( P/A ) | Pol. ( H/V ) |   |
|---------------------------------|---|-------------------|------------------|-------------------|-----------------------|---------------------|-------------------------|------------------|----------------------|----------------|-------------------|-------------------|--------------|---|
| 802.11ac VHT20 CH 36<br>5180MHz |   | 10360             | 47.35            | -20.85            | 68.2                  | 58.1                | 39.51                   | 14.94            | 65.2                 | 100            | 0                 | P                 | H            |   |
|                                 |   | 15540             | 55.9             | -18.1             | 74                    | 63.54               | 38                      | 18.34            | 63.98                | 100            | 190               | P                 | H            |   |
|                                 |   | 15540             | 38.9             | -15.1             | 54                    | 46.54               | 38                      | 18.34            | 63.98                | 100            | 190               | A                 | H            |   |
|                                 |   |                   |                  |                   |                       |                     |                         |                  |                      |                |                   |                   | H            |   |
|                                 |   |                   | 10360            | 49.8              | -18.4                 | 68.2                | 60.55                   | 39.51            | 14.94                | 65.2           | 100               | 0                 | P            | V |
|                                 |   |                   | 15540            | 60.32             | -13.68                | 74                  | 67.96                   | 38               | 18.34                | 63.98          | 211               | 280               | P            | V |
|                                 |   |                   | 15540            | 42.26             | -11.74                | 54                  | 49.9                    | 38               | 18.34                | 63.98          | 211               | 280               | A            | V |
|                                 |   |                   |                  |                   |                       |                     |                         |                  |                      |                |                   |                   | V            |   |
| 802.11ac VHT20 CH 44<br>5220MHz |   | 10440             | 47.33            | -20.87            | 68.2                  | 57.93               | 39.61                   | 14.99            | 65.2                 | 100            | 0                 | P                 | H            |   |
|                                 |   | 15660             | 64.49            | -9.51             | 74                    | 72.65               | 37.67                   | 18.41            | 64.24                | 186            | 28                | P                 | H            |   |
|                                 |   | 15660             | 51.61            | -2.39             | 54                    | 59.77               | 37.67                   | 18.41            | 64.24                | 186            | 28                | A                 | H            |   |
|                                 |   |                   |                  |                   |                       |                     |                         |                  |                      |                |                   |                   | H            |   |
|                                 |   |                   | 10440            | 51.46             | -16.74                | 68.2                | 62.06                   | 39.61            | 14.99                | 65.2           | 100               | 0                 | P            | V |
|                                 |   |                   | 15660            | 61.36             | -12.64                | 74                  | 69.52                   | 37.67            | 18.41                | 64.24          | 211               | 283               | P            | V |
|                                 |   |                   | 15660            | 46.77             | -7.23                 | 54                  | 54.93                   | 37.67            | 18.41                | 64.24          | 211               | 283               | A            | V |
|                                 |   |                   |                  |                   |                       |                     |                         |                  |                      |                |                   |                   | V            |   |
| 802.11ac VHT20 CH 48<br>5240MHz |   | 10480             | 50.18            | -18.02            | 68.2                  | 60.67               | 39.68                   | 15.03            | 65.2                 | 100            | 0                 | P                 | H            |   |
|                                 |   | 15720             | 64.68            | -9.32             | 74                    | 73.17               | 37.47                   | 18.43            | 64.39                | 237            | 22                | P                 | H            |   |
|                                 |   | 15720             | 51.9             | -2.1              | 54                    | 60.39               | 37.47                   | 18.43            | 64.39                | 237            | 22                | A                 | H            |   |
|                                 |   |                   |                  |                   |                       |                     |                         |                  |                      |                |                   |                   | H            |   |
|                                 |   |                   | 10480            | 52.58             | -15.62                | 68.2                | 63.07                   | 39.68            | 15.03                | 65.2           | 100               | 0                 | P            | V |
|                                 |   |                   | 15720            | 59.54             | -14.46                | 74                  | 68.03                   | 37.47            | 18.43                | 64.39          | 155               | 182               | P            | V |
|                                 |   |                   | 15720            | 46.43             | -7.57                 | 54                  | 54.92                   | 37.47            | 18.43                | 64.39          | 155               | 182               | A            | V |
|                                 |   |                   |                  |                   |                       |                     |                         |                  |                      |                |                   |                   | V            |   |
| Remark                          | 3. No other spurious found.<br>4. All results are PASS against Peak and Average limit line. |                   |                  |                   |                       |                     |                         |                  |                      |                |                   |                   |              |   |



**Band 1 5150~5250MHz**  
**WIFI 802.11ac VHT40 (Band Edge @ 3m)**

| WIFI Ant. 1+2                | Note  | Frequency ( MHz ) | Level ( dBμV/m ) | Over Limit ( dB ) | Limit Line ( dBμV/m ) | Read Level (dBμV) | Antenna Factor ( dB/m ) | Path Loss ( dB ) | Preamp Factor ( dB ) | Ant Pos ( cm ) | Table Pos ( deg ) | Peak Avg. (P/A) | Pol. (H/V) |
|------------------------------|---|-------------------|------------------|-------------------|-----------------------|-------------------|-------------------------|------------------|----------------------|----------------|-------------------|-----------------|------------|
| 802.11ac VHT40 CH 38 5190MHz |   | 5149.76           | 54.45            | -19.55            | 74                    | 46.68             | 31.75                   | 9.05             | 33.03                | 389            | 159               | P               | H          |
|                              |   | 5150              | 47.47            | -6.53             | 54                    | 39.7              | 31.75                   | 9.05             | 33.03                | 389            | 159               | A               | H          |
|                              | *   | 5190              | 109.08           | -                 | -                     | 101.24            | 31.78                   | 9.09             | 33.03                | 389            | 159               | P               | H          |
|                              | *   | 5190              | 100.53           | -                 | -                     | 92.69             | 31.78                   | 9.09             | 33.03                | 389            | 159               | A               | H          |
|                              |   | 5378.8            | 49.18            | -24.82            | 74                    | 41.02             | 31.98                   | 9.2              | 33.02                | 389            | 159               | P               | H          |
|                              |   | 5449.64           | 39.65            | -14.35            | 54                    | 31.33             | 32.05                   | 9.29             | 33.02                | 389            | 159               | A               | H          |
|                              |   | 5146.64           | 60.03            | -13.97            | 74                    | 52.26             | 31.75                   | 9.05             | 33.03                | 248            | 175               | P               | V          |
|                              |   | 5150              | 51.8             | -2.2              | 54                    | 44.03             | 31.75                   | 9.05             | 33.03                | 248            | 175               | A               | V          |
|                              | *   | 5190              | 113.51           | -                 | -                     | 105.67            | 31.78                   | 9.09             | 33.03                | 248            | 175               | P               | V          |
|                              | *   | 5190              | 104.67           | -                 | -                     | 96.83             | 31.78                   | 9.09             | 33.03                | 248            | 175               | A               | V          |
|                              |   | 5352.2            | 48.41            | -25.59            | 74                    | 40.3              | 31.95                   | 9.19             | 33.03                | 248            | 175               | P               | V          |
|                              |   | 5350              | 39.95            | -14.05            | 54                    | 31.84             | 31.95                   | 9.19             | 33.03                | 248            | 175               | A               | V          |
| 802.11ac VHT40 CH 46 5230MHz |   | 5148.98           | 55.37            | -18.63            | 74                    | 47.6              | 31.75                   | 9.05             | 33.03                | 365            | 147               | P               | H          |
|                              |   | 5149.24           | 46.17            | -7.83             | 54                    | 38.4              | 31.75                   | 9.05             | 33.03                | 365            | 147               | A               | H          |
|                              | *   | 5230              | 112.81           | -                 | -                     | 104.9             | 31.83                   | 9.11             | 33.03                | 365            | 147               | P               | H          |
|                              | *   | 5230              | 103.36           | -                 | -                     | 95.45             | 31.83                   | 9.11             | 33.03                | 365            | 147               | A               | H          |
|                              |   | 5430.24           | 48.6             | -25.4             | 74                    | 40.33             | 32.03                   | 9.26             | 33.02                | 365            | 147               | P               | H          |
|                              |   | 5352.24           | 39.89            | -14.11            | 54                    | 31.78             | 31.95                   | 9.19             | 33.03                | 365            | 147               | A               | H          |
|                              |   | 5150              | 61.03            | -12.97            | 74                    | 53.26             | 31.75                   | 9.05             | 33.03                | 243            | 172               | P               | V          |
|                              |   | 5147.94           | 50.01            | -3.99             | 54                    | 42.24             | 31.75                   | 9.05             | 33.03                | 243            | 172               | A               | V          |
|                              | *   | 5230              | 117.56           | -                 | -                     | 109.65            | 31.83                   | 9.11             | 33.03                | 243            | 172               | P               | V          |
|                              | *   | 5230              | 108.58           | -                 | -                     | 100.67            | 31.83                   | 9.11             | 33.03                | 243            | 172               | A               | V          |
|                              | 5397.12   | 48.46             | -25.54           | 74                | 40.26                 | 32                | 9.22                    | 33.02            | 243                  | 172            | P                 | V               |            |
|                              | 5350.8  | 40.72             | -13.28           | 54                | 32.61                 | 31.95             | 9.19                    | 33.03            | 243                  | 172            | A                 | V               |            |
| <b>Remark</b>                | 3. No other spurious found.<br>4. All results are PASS against Peak and Average limit line. |                   |                  |                   |                       |                   |                         |                  |                      |                |                   |                 |            |



**Band 1 5150~5250MHz**  
**WIFI 802.11ac VHT40 (Harmonic @ 3m)**

| WIFI Ant. 1+2                | Note   | Frequency ( MHz ) | Level ( dBμV/m ) | Over Limit ( dB ) | Limit Line ( dBμV/m ) | Read Level (dBμV) | Antenna Factor ( dB/m ) | Path Loss ( dB ) | Preamp Factor ( dB ) | Ant Pos ( cm ) | Table Pos ( deg ) | Peak Avg. (P/A) | Pol. (H/V) |   |
|------------------------------|--|-------------------|------------------|-------------------|-----------------------|-------------------|-------------------------|------------------|----------------------|----------------|-------------------|-----------------|------------|---|
| 802.11ac VHT40 CH 38 5190MHz |  | 10380             | 45.62            | -22.58            | 68.2                  | 56.33             | 39.54                   | 14.95            | 65.2                 | 100            | 0                 | P               | H          |   |
|                              |  | 15570             | 44.37            | -29.63            | 74                    | 52.15             | 37.91                   | 18.36            | 64.05                | 100            | 0                 | P               | H          |   |
|                              |  |                   |                  |                   |                       |                   |                         |                  |                      |                |                   |                 | H          |   |
|                              |  |                   |                  |                   |                       |                   |                         |                  |                      |                |                   |                 | H          |   |
|                              |  |                   | 10380            | 45.45             | -22.75                | 68.2              | 56.16                   | 39.54            | 14.95                | 65.2           | 100               | 0               | P          | V |
|                              |  |                   | 15570            | 44.02             | -29.98                | 74                | 51.8                    | 37.91            | 18.36                | 64.05          | 100               | 0               | P          | V |
|                              |  |                   |                  |                   |                       |                   |                         |                  |                      |                |                   |                 |            | V |
| 802.11ac VHT40 CH 46 5230MHz |  | 10460             | 43.91            | -24.29            | 68.2                  | 54.48             | 39.63                   | 15               | 65.2                 | 100            | 0                 | P               | H          |   |
|                              |  | 15690             | 48.83            | -25.17            | 74                    | 57.17             | 37.57                   | 18.41            | 64.32                | 100            | 0                 | P               | H          |   |
|                              |  |                   |                  |                   |                       |                   |                         |                  |                      |                |                   |                 | H          |   |
|                              |  |                   |                  |                   |                       |                   |                         |                  |                      |                |                   |                 | H          |   |
|                              |  |                   | 10460            | 44.74             | -23.46                | 68.2              | 55.31                   | 39.63            | 15                   | 65.2           | 100               | 0               | P          | V |
|                              |  |                   | 15690            | 44.08             | -29.92                | 74                | 52.42                   | 37.57            | 18.41                | 64.32          | 100               | 0               | P          | V |
|                              |  |                   |                  |                   |                       |                   |                         |                  |                      |                |                   |                 |            | V |
| Remark                       | 3. No other spurious found.                                  |                   |                  |                   |                       |                   |                         |                  |                      |                |                   |                 |            |   |
|                              | 4. All results are PASS against Peak and Average limit line. |                   |                  |                   |                       |                   |                         |                  |                      |                |                   |                 |            |   |



**Band 1 5150~5250MHz**  
**WIFI 802.11ac VHT80 (Band Edge @ 3m)**

| WIFI Ant. 1+2                | Note  | Frequency ( MHz ) | Level ( dBμV/m ) | Over Limit ( dB ) | Limit Line ( dBμV/m ) | Read Level ( dBμV ) | Antenna Factor ( dB/m ) | Path Loss ( dB ) | Preamp Factor ( dB ) | Ant Pos ( cm ) | Table Pos ( deg ) | Peak Avg. ( P/A ) | Pol. ( H/V ) |
|------------------------------|---|-------------------|------------------|-------------------|-----------------------|---------------------|-------------------------|------------------|----------------------|----------------|-------------------|-------------------|--------------|
| 802.11ac VHT80 CH 42 5210MHz |   | 5133.12           | 55.29            | -18.71            | 74                    | 47.54               | 31.73                   | 9.05             | 33.03                | 386            | 159               | P                 | H            |
|                              |   | 5149.5            | 46.92            | -7.08             | 54                    | 39.15               | 31.75                   | 9.05             | 33.03                | 386            | 159               | A                 | H            |
|                              | *   | 5210              | 105.62           | -                 | -                     | 97.74               | 31.82                   | 9.09             | 33.03                | 386            | 159               | P                 | H            |
|                              | *   | 5210              | 96.67            | -                 | -                     | 88.79               | 31.82                   | 9.09             | 33.03                | 386            | 159               | A                 | H            |
|                              |   | 5437.68           | 48.81            | -25.19            | 74                    | 40.54               | 32.03                   | 9.26             | 33.02                | 386            | 159               | P                 | H            |
|                              |   | 5352.24           | 39.9             | -14.1             | 54                    | 31.79               | 31.95                   | 9.19             | 33.03                | 386            | 159               | A                 | H            |
|                              |   | 5130              | 59.31            | -14.69            | 74                    | 51.58               | 31.73                   | 9.03             | 33.03                | 259            | 177               | P                 | V            |
|                              |   | 5148.72           | 52.51            | -1.49             | 54                    | 44.74               | 31.75                   | 9.05             | 33.03                | 259            | 177               | A                 | V            |
|                              | *   | 5210              | 110.53           | -                 | -                     | 102.65              | 31.82                   | 9.09             | 33.03                | 259            | 177               | P                 | V            |
|                              | *   | 5210              | 101.54           | -                 | -                     | 93.66               | 31.82                   | 9.09             | 33.03                | 259            | 177               | A                 | V            |
|                              |   | 5358.48           | 48.81            | -25.19            | 74                    | 40.7                | 31.95                   | 9.19             | 33.03                | 259            | 177               | P                 | V            |
|                              | 5350.08   | 41.28             | -12.72           | 54                | 33.17                 | 31.95               | 9.19                    | 33.03            | 259                  | 177            | A                 | V                 |              |
| Remark                       | 3. No other spurious found.<br>4. All results are PASS against Peak and Average limit line. |                   |                  |                   |                       |                     |                         |                  |                      |                |                   |                   |              |





**Band 1 5150~5250MHz**  
**WIFI 802.11ac VHT80 (Harmonic @ 3m)**

| WIFI Ant. 1+2                | Note   | Frequency ( MHz ) | Level ( dBμV/m ) | Over Limit ( dB ) | Limit Line ( dBμV/m ) | Read Level (dBμV) | Antenna Factor ( dB/m ) | Path Loss ( dB ) | Preamp Factor ( dB ) | Ant Pos ( cm ) | Table Pos ( deg ) | Peak Avg. (P/A) | Pol. (H/V) |   |
|------------------------------|--|-------------------|------------------|-------------------|-----------------------|-------------------|-------------------------|------------------|----------------------|----------------|-------------------|-----------------|------------|---|
| 802.11ac VHT80 CH 42 5210MHz |  | 10420             | 44.69            | -23.51            | 68.2                  | 55.33             | 39.58                   | 14.98            | 65.2                 | 100            | 0                 | P               | H          |   |
|                              |  | 15630             | 43.84            | -30.16            | 74                    | 51.94             | 37.71                   | 18.39            | 64.2                 | 100            | 0                 | P               | H          |   |
|                              |  |                   |                  |                   |                       |                   |                         |                  |                      |                |                   |                 | H          |   |
|                              |  |                   |                  |                   |                       |                   |                         |                  |                      |                |                   |                 | H          |   |
|                              |  |                   | 10420            | 43.77             | -24.43                | 68.2              | 54.41                   | 39.58            | 14.98                | 65.2           | 100               | 0               | P          | V |
|                              |  |                   | 15630            | 44.9              | -29.1                 | 74                | 53                      | 37.71            | 18.39                | 64.2           | 100               | 0               | P          | V |
|                              |  |                   |                  |                   |                       |                   |                         |                  |                      |                |                   |                 |            | V |
| Remark                       | 3. No other spurious found.                                  |                   |                  |                   |                       |                   |                         |                  |                      |                |                   |                 |            |   |
|                              | 4. All results are PASS against Peak and Average limit line. |                   |                  |                   |                       |                   |                         |                  |                      |                |                   |                 |            |   |





<TXBF Mode>

Band 1 - 5150~5250MHz

WIFI 802.11ac VHT20 (Band Edge @ 3m)

| WIFI Ant.                             | Note | Frequency | Level      | Over Limit | Limit Line | Read Level | Antenna Factor | Cable Loss | Preamp Factor | Ant Pos | Table Pos | Peak Avg. | Pol.    |   |
|---------------------------------------|------|-----------|------------|------------|------------|------------|----------------|------------|---------------|---------|-----------|-----------|---------|---|
| 1+2                                   |      | ( MHz )   | ( dBμV/m ) | ( dB )     | ( dBμV/m ) | ( dBμV )   | ( dB/m )       | ( dB )     | ( dB )        | ( cm )  | ( deg )   | ( P/A )   | ( H/V ) |   |
| 802.11ac<br>VHT20<br>CH 36<br>5180MHz |      | 5142.22   | 59.53      | -14.47     | 74         | 51.76      | 31.75          | 9.05       | 33.03         | 355     | 148       | P         | H       |   |
|                                       |      | 5150      | 45.85      | -8.15      | 54         | 38.08      | 31.75          | 9.05       | 33.03         | 355     | 148       | A         | H       |   |
|                                       | *    | 5180      | 113.82     | -          | -          | 106        | 31.78          | 9.07       | 33.03         | 355     | 148       | P         | H       |   |
|                                       | *    | 5180      | 105.37     | -          | -          | 97.55      | 31.78          | 9.07       | 33.03         | 355     | 148       | A         | H       |   |
|                                       |      |           |            |            |            |            |                |            |               |         |           |           | H       |   |
|                                       |      |           |            |            |            |            |                |            |               |         |           |           |         | H |
|                                       |      |           | 5141.44    | 60.21      | -13.79     | 74         | 52.44          | 31.75      | 9.05          | 33.03   | 354       | 214       | P       | V |
|                                       |      |           | 5149.76    | 48.26      | -5.74      | 54         | 40.49          | 31.75      | 9.05          | 33.03   | 354       | 214       | A       | V |
|                                       |      | *         | 5180       | 119.04     | -          | -          | 111.22         | 31.78      | 9.07          | 33.03   | 354       | 214       | P       | V |
|                                       |      | *         | 5180       | 111.1      | -          | -          | 103.28         | 31.78      | 9.07          | 33.03   | 354       | 214       | A       | V |
|                                       |      |           |            |            |            |            |                |            |               |         |           |           | V       |   |
|                                       |      |           |            |            |            |            |                |            |               |         |           |           | V       |   |
| 802.11ac<br>VHT20<br>CH 44<br>5220MHz |      | 5008.84   | 49.91      | -24.09     | 74         | 42.38      | 31.62          | 8.95       | 33.04         | 100     | 244       | P         | H       |   |
|                                       |      | 5149.24   | 40.43      | -13.57     | 54         | 32.66      | 31.75          | 9.05       | 33.03         | 100     | 244       | A         | H       |   |
|                                       | *    | 5220      | 112.28     | -          | -          | 104.38     | 31.82          | 9.11       | 33.03         | 100     | 244       | P         | H       |   |
|                                       | *    | 5220      | 104.49     | -          | -          | 96.59      | 31.82          | 9.11       | 33.03         | 100     | 244       | A         | H       |   |
|                                       |      |           | 5394.72    | 49.35      | -24.65     | 74         | 41.15          | 32         | 9.22          | 33.02   | 100       | 244       | P       | H |
|                                       |      |           | 5352.96    | 39.62      | -14.38     | 54         | 31.51          | 31.95      | 9.19          | 33.03   | 100       | 244       | A       | H |
|                                       |      |           | 5120.64    | 57.31      | -16.69     | 74         | 49.59          | 31.72      | 9.03          | 33.03   | 118       | 160       | P       | V |
|                                       |      |           | 5135.98    | 43.48      | -10.52     | 54         | 35.73          | 31.73      | 9.05          | 33.03   | 118       | 160       | A       | V |
|                                       |      | *         | 5220       | 118.66     | -          | -          | 110.76         | 31.82      | 9.11          | 33.03   | 118       | 160       | P       | V |
|                                       |      | *         | 5220       | 110        | -          | -          | 102.1          | 31.82      | 9.11          | 33.03   | 118       | 160       | A       | V |
|                                       |      | 5353.44   | 50.05      | -23.95     | 74         | 41.94      | 31.95          | 9.19       | 33.03         | 118     | 160       | P         | V       |   |
|                                       |      | 5353.44   | 39.86      | -14.14     | 54         | 31.75      | 31.95          | 9.19       | 33.03         | 118     | 160       | A         | V       |   |



|   |   |         |        |        |    |        |       |      |       |     |     |   |   |
|---|---|---------|--------|--------|----|--------|-------|------|-------|-----|-----|---|---|
| <b>802.11ac</b><br><br><b>VHT20</b><br><br><b>CH 48</b><br><br><b>5240MHz</b> |   | 5029.64 | 50.6   | -23.4  | 74 | 43.04  | 31.63 | 8.97 | 33.04 | 100 | 219 | P | H |
|   |   | 5145.34 | 40.14  | -13.86 | 54 | 32.37  | 31.75 | 9.05 | 33.03 | 100 | 219 | A | H |
|   | *   | 5240    | 112.79 | -      | -  | 104.87 | 31.83 | 9.12 | 33.03 | 100 | 219 | P | H |
|   | *   | 5240    | 104.26 | -      | -  | 96.34  | 31.83 | 9.12 | 33.03 | 100 | 219 | A | H |
|   |   | 5358    | 49.09  | -24.91 | 74 | 40.98  | 31.95 | 9.19 | 33.03 | 100 | 219 | P | H |
|   |   | 5351.04 | 39.76  | -14.24 | 54 | 31.65  | 31.95 | 9.19 | 33.03 | 100 | 219 | A | H |
|   |   | 5122.98 | 59.14  | -14.86 | 74 | 51.41  | 31.73 | 9.03 | 33.03 | 366 | 207 | P | V |
|   |   | 5135.98 | 42.87  | -11.13 | 54 | 35.12  | 31.73 | 9.05 | 33.03 | 366 | 207 | A | V |
|   | *   | 5240    | 118.19 | -      | -  | 110.27 | 31.83 | 9.12 | 33.03 | 366 | 207 | P | V |
|   | *   | 5240    | 111.47 | -      | -  | 103.55 | 31.83 | 9.12 | 33.03 | 366 | 207 | A | V |
|   |   | 5355.6  | 49.47  | -24.53 | 74 | 41.36  | 31.95 | 9.19 | 33.03 | 366 | 207 | P | V |
|   |   | 5352.24 | 40.39  | -13.61 | 54 | 32.28  | 31.95 | 9.19 | 33.03 | 366 | 207 | A | V |
| <b>Remark</b>   | 5. No other spurious found.<br>6. All results are PASS against Peak and Average limit line. |         |        |        |    |        |       |      |       |     |     |   |   |



**Band 1 5150~5250MHz**  
**WIFI 802.11ac VHT20 (Harmonic @ 3m)**

| WIFI Ant. 1+2                   | Note   | Frequency ( MHz ) | Level ( dBμV/m ) | Over Limit ( dB ) | Limit Line ( dBμV/m ) | Read Level (dBμV) | Antenna Factor ( dB/m ) | Cable Loss ( dB ) | Preamp Factor ( dB ) | Ant Pos ( cm ) | Table Pos ( deg ) | Peak Avg. (P/A) | Pol. (H/V) |   |
|---------------------------------|--|-------------------|------------------|-------------------|-----------------------|-------------------|-------------------------|-------------------|----------------------|----------------|-------------------|-----------------|------------|---|
| 802.11ac VHT20 CH 36<br>5180MHz |  | 10360             | 46.32            | -27.68            | 74                    | 57.07             | 39.51                   | 14.94             | 65.2                 | 100            | 0                 | P               | H          |   |
|                                 |  | 15540             | 48.52            | -25.48            | 74                    | 56.16             | 38                      | 18.34             | 63.98                | 100            | 0                 | P               | H          |   |
|                                 |  |                   |                  |                   |                       |                   |                         |                   |                      |                |                   |                 | H          |   |
|                                 |  |                   |                  |                   |                       |                   |                         |                   |                      |                |                   |                 | H          |   |
|                                 |  |                   | 10360            | 46.81             | -27.19                | 74                | 57.56                   | 39.51             | 14.94                | 65.2           | 100               | 0               | P          | V |
|                                 |  |                   | 15540            | 57.68             | -16.32                | 74                | 65.32                   | 38                | 18.34                | 63.98          | 212               | 250             | P          | V |
|                                 |  |                   | 15540            | 40.11             | -13.89                | 54                | 47.75                   | 38                | 18.34                | 63.98          | 212               | 250             | A          | V |
| 802.11ac VHT20 CH 44<br>5220MHz |  |                   |                  |                   |                       |                   |                         |                   |                      |                |                   |                 | V          |   |
|                                 |  |                   |                  |                   |                       |                   |                         |                   |                      |                |                   |                 | V          |   |
|                                 |  |                   | 10440            | 46.59             | -27.41                | 74                | 57.19                   | 39.61             | 14.99                | 65.2           | 100               | 0               | P          | H |
|                                 |  |                   | 15660            | 44.14             | -29.86                | 74                | 52.3                    | 37.67             | 18.41                | 64.24          | 100               | 0               | P          | H |
|                                 |  |                   |                  |                   |                       |                   |                         |                   |                      |                |                   |                 | H          |   |
|                                 |  |                   |                  |                   |                       |                   |                         |                   |                      |                |                   |                 | H          |   |
|                                 |  |                   | 10440            | 47.69             | -26.31                | 74                | 58.29                   | 39.61             | 14.99                | 65.2           | 100               | 0               | P          | V |
| 802.11ac VHT20 CH 48<br>5240MHz |  |                   |                  |                   |                       |                   |                         |                   |                      |                |                   |                 | V          |   |
|                                 |  |                   |                  |                   |                       |                   |                         |                   |                      |                |                   |                 | V          |   |
|                                 |  |                   | 10480            | 46.38             | -27.62                | 74                | 56.87                   | 39.68             | 15.03                | 65.2           | 100               | 0               | P          | H |
|                                 |  |                   | 15720            | 46.09             | -27.91                | 74                | 54.58                   | 37.47             | 18.43                | 64.39          | 100               | 0               | P          | H |
|                                 |  |                   |                  |                   |                       |                   |                         |                   |                      |                |                   |                 | H          |   |
|                                 |  |                   |                  |                   |                       |                   |                         |                   |                      |                |                   |                 | H          |   |
|                                 |  |                   | 10480            | 46.75             | -27.25                | 74                | 57.24                   | 39.68             | 15.03                | 65.2           | 100               | 0               | P          | V |
| Remark                          | 5. No other spurious found.                                  |                   |                  |                   |                       |                   |                         |                   |                      |                |                   |                 |            |   |
|                                 | 6. All results are PASS against Peak and Average limit line. |                   |                  |                   |                       |                   |                         |                   |                      |                |                   |                 |            |   |
|                                 |  |                   |                  |                   |                       |                   |                         |                   |                      |                |                   |                 |            |   |



**Band 1 5150~5250MHz**  
**WIFI 802.11ac VHT40 (Band Edge @ 3m)**

| WIFI Ant. 1+2                | Note   | Frequency ( MHz ) | Level ( dBμV/m ) | Over Limit ( dB ) | Limit Line ( dBμV/m ) | Read Level ( dBμV ) | Antenna Factor ( dB/m ) | Cable Loss ( dB ) | Preamp Factor ( dB ) | Ant Pos ( cm ) | Table Pos ( deg ) | Peak Avg. ( P/A ) | Pol. ( H/V ) |   |
|------------------------------|--|-------------------|------------------|-------------------|-----------------------|---------------------|-------------------------|-------------------|----------------------|----------------|-------------------|-------------------|--------------|---|
| 802.11ac VHT40 CH 38 5190MHz |  | 5146.38           | 53.84            | -20.16            | 74                    | 46.07               | 31.75                   | 9.05              | 33.03                | 266            | 155               | P                 | H            |   |
|                              |  | 5146.9            | 48.52            | -5.48             | 54                    | 40.75               | 31.75                   | 9.05              | 33.03                | 266            | 155               | A                 | H            |   |
|                              | *  | 5190              | 109              | -                 | -                     | 101.16              | 31.78                   | 9.09              | 33.03                | 266            | 155               | P                 | H            |   |
|                              | *  | 5190              | 100.58           | -                 | -                     | 92.74               | 31.78                   | 9.09              | 33.03                | 266            | 155               | A                 | H            |   |
|                              |  | 5459.72           | 39.35            | -14.65            | 54                    | 31.03               | 32.05                   | 9.29              | 33.02                | 266            | 155               | P                 | H            |   |
|                              |  |                   |                  |                   |                       |                     |                         |                   |                      |                |                   |                   |              | H |
|                              |  | 5142.74           | 57.77            | -16.23            | 74                    | 50                  | 31.75                   | 9.05              | 33.03                | 300            | 209               | P                 | V            |   |
|                              |  | 5150              | 50.44            | -3.56             | 54                    | 42.67               | 31.75                   | 9.05              | 33.03                | 300            | 209               | A                 | V            |   |
|                              | *  | 5190              | 115.04           | -                 | -                     | 107.2               | 31.78                   | 9.09              | 33.03                | 300            | 209               | P                 | V            |   |
|                              | *  | 5190              | 106.64           | -                 | -                     | 98.8                | 31.78                   | 9.09              | 33.03                | 300            | 209               | A                 | V            |   |
|                              |  | 5363.12           | 48.33            | -25.67            | 74                    | 40.2                | 31.97                   | 9.19              | 33.03                | 300            | 209               | P                 | V            |   |
|                              |  | 5351.08           | 39.37            | -14.63            | 54                    | 31.26               | 31.95                   | 9.19              | 33.03                | 300            | 209               | P                 | V            |   |
| 802.11ac VHT40 CH 46 5230MHz |  | 5132.86           | 57.27            | -16.73            | 74                    | 49.54               | 31.73                   | 9.03              | 33.03                | 282            | 140               | P                 | H            |   |
|                              |  | 5148.72           | 42.6             | -11.4             | 54                    | 34.83               | 31.75                   | 9.05              | 33.03                | 282            | 140               | A                 | H            |   |
|                              | *  | 5230              | 110.63           | -                 | -                     | 102.72              | 31.83                   | 9.11              | 33.03                | 282            | 140               | P                 | H            |   |
|                              | *  | 5230              | 102.21           | -                 | -                     | 94.3                | 31.83                   | 9.11              | 33.03                | 282            | 140               | A                 | H            |   |
|                              |  | 5402.32           | 48.75            | -25.25            | 74                    | 40.55               | 32                      | 9.22              | 33.02                | 282            | 140               | P                 | H            |   |
|                              |  |                   |                  |                   |                       |                     |                         |                   |                      |                |                   |                   |              | H |
|                              |  | 5125.84           | 56.93            | -17.07            | 74                    | 49.2                | 31.73                   | 9.03              | 33.03                | 300            | 143               | P                 | V            |   |
|                              |  | 5150              | 44.09            | -9.91             | 54                    | 36.32               | 31.75                   | 9.05              | 33.03                | 300            | 143               | A                 | V            |   |
|                              | *  | 5230              | 113.94           | -                 | -                     | 106.03              | 31.83                   | 9.11              | 33.03                | 300            | 143               | P                 | V            |   |
|                              | *  | 5230              | 105.31           | -                 | -                     | 97.4                | 31.83                   | 9.11              | 33.03                | 300            | 143               | A                 | V            |   |
|                              | 5363.4   | 49.44             | -24.56           | 74                | 41.31                 | 31.97               | 9.19                    | 33.03             | 300                  | 143            | P                 | V                 |              |   |
|                              | 5351.08  | 40.46             | -13.54           | 54                | 32.35                 | 31.95               | 9.19                    | 33.03             | 300                  | 143            | A                 | V                 |              |   |
| Remark                       | 5. No other spurious found.                                  |                   |                  |                   |                       |                     |                         |                   |                      |                |                   |                   |              |   |
|                              | 6. All results are PASS against Peak and Average limit line. |                   |                  |                   |                       |                     |                         |                   |                      |                |                   |                   |              |   |



**Band 1 5150~5250MHz**  
**WIFI 802.11ac VHT40 (Harmonic @ 3m)**

| WIFI Ant. 1+2                | Note   | Frequency ( MHz ) | Level ( dBμV/m ) | Over Limit ( dB ) | Limit Line ( dBμV/m ) | Read Level (dBμV) | Antenna Factor ( dB/m ) | Cable Loss ( dB ) | Preamp Factor ( dB ) | Ant Pos ( cm ) | Table Pos ( deg ) | Peak Avg. (P/A) | Pol. (H/V) |   |
|------------------------------|--|-------------------|------------------|-------------------|-----------------------|-------------------|-------------------------|-------------------|----------------------|----------------|-------------------|-----------------|------------|---|
| 802.11ac VHT40 CH 38 5190MHz |  | 10380             | 45.32            | -28.68            | 74                    | 56.03             | 39.54                   | 14.95             | 65.2                 | 100            | 0                 | P               | H          |   |
|                              |  | 15570             | 45.02            | -28.98            | 74                    | 52.8              | 37.91                   | 18.36             | 64.05                | 100            | 0                 | P               | H          |   |
|                              |  |                   |                  |                   |                       |                   |                         |                   |                      |                |                   |                 | H          |   |
|                              |  |                   |                  |                   |                       |                   |                         |                   |                      |                |                   |                 | H          |   |
|                              |  |                   | 10380            | 45.89             | -28.11                | 74                | 56.6                    | 39.54             | 14.95                | 65.2           | 100               | 0               | P          | V |
|                              |  |                   | 15570            | 45.54             | -28.46                | 74                | 53.32                   | 37.91             | 18.36                | 64.05          | 100               | 0               | P          | V |
|                              |  |                   |                  |                   |                       |                   |                         |                   |                      |                |                   |                 |            | V |
| 802.11ac VHT40 CH 46 5230MHz |  | 10460             | 46.29            | -27.71            | 74                    | 56.86             | 39.63                   | 15                | 65.2                 | 100            | 0                 | P               | H          |   |
|                              |  | 15690             | 43.91            | -30.09            | 74                    | 52.25             | 37.57                   | 18.41             | 64.32                | 100            | 0                 | P               | H          |   |
|                              |  |                   |                  |                   |                       |                   |                         |                   |                      |                |                   |                 | H          |   |
|                              |  |                   |                  |                   |                       |                   |                         |                   |                      |                |                   |                 | H          |   |
|                              |  |                   | 10460            | 45.79             | -28.21                | 74                | 56.36                   | 39.63             | 15                   | 65.2           | 100               | 0               | P          | V |
|                              |  |                   | 15690            | 44.05             | -29.95                | 74                | 52.39                   | 37.57             | 18.41                | 64.32          | 100               | 0               | P          | V |
|                              |  |                   |                  |                   |                       |                   |                         |                   |                      |                |                   |                 |            | V |
| Remark                       | 5. No other spurious found.                                  |                   |                  |                   |                       |                   |                         |                   |                      |                |                   |                 |            |   |
|                              | 6. All results are PASS against Peak and Average limit line. |                   |                  |                   |                       |                   |                         |                   |                      |                |                   |                 |            |   |



**Band 1 5150~5250MHz**  
**WIFI 802.11ac VHT80 (Band Edge @ 3m)**

| WIFI Ant. 1+2                       | Note  | Frequency ( MHz ) | Level ( dBμV/m ) | Over Limit ( dB ) | Limit Line ( dBμV/m ) | Read Level ( dBμV ) | Antenna Factor ( dB/m ) | Cable Loss ( dB ) | Preamp Factor ( dB ) | Ant Pos ( cm ) | Table Pos ( deg ) | Peak Avg. ( P/A ) | Pol. ( H/V ) |
|-------------------------------------|---|-------------------|------------------|-------------------|-----------------------|---------------------|-------------------------|-------------------|----------------------|----------------|-------------------|-------------------|--------------|
| <b>802.11ac VHT80 CH 42 5210MHz</b> |   | 5147.94           | 54.47            | -19.53            | 74                    | 46.7                | 31.75                   | 9.05              | 33.03                | 311            | 160               | P                 | H            |
|                                     |   | 5149.24           | 49.53            | -4.47             | 54                    | 41.76               | 31.75                   | 9.05              | 33.03                | 311            | 160               | A                 | H            |
|                                     | *   | 5210              | 106.76           | -                 | -                     | 98.88               | 31.82                   | 9.09              | 33.03                | 311            | 160               | P                 | H            |
|                                     | *   | 5210              | 99.01            | -                 | -                     | 91.13               | 31.82                   | 9.09              | 33.03                | 311            | 160               | A                 | H            |
|                                     |   | 5451.32           | 48.8             | -25.2             | 74                    | 40.48               | 32.05                   | 9.29              | 33.02                | 311            | 160               | P                 | H            |
|                                     |   | 5351.08           | 39.87            | -14.13            | 54                    | 31.76               | 31.95                   | 9.19              | 33.03                | 311            | 160               | A                 | H            |
|                                     |   | 5113.1            | 60.13            | -13.87            | 74                    | 52.42               | 31.72                   | 9.03              | 33.04                | 300            | 212               | P                 | V            |
|                                     |   | 5145.08           | 51.85            | -2.15             | 54                    | 44.08               | 31.75                   | 9.05              | 33.03                | 300            | 212               | P                 | V            |
|                                     | *   | 5210              | 109.5            | -                 | -                     | 101.62              | 31.82                   | 9.09              | 33.03                | 300            | 212               | P                 | V            |
|                                     | *   | 5210              | 101.27           | -                 | -                     | 93.39               | 31.82                   | 9.09              | 33.03                | 300            | 212               | A                 | V            |
|                                     |   | 5388.04           | 48.88            | -25.12            | 74                    | 40.72               | 31.98                   | 9.2               | 33.02                | 300            | 212               | P                 | V            |
|                                     |   | 5350.52           | 40.35            | -13.65            | 54                    | 32.24               | 31.95                   | 9.19              | 33.03                | 300            | 212               | P                 | V            |
| <b>Remark</b>                       | 5. No other spurious found.<br>6. All results are PASS against Peak and Average limit line. |                   |                  |                   |                       |                     |                         |                   |                      |                |                   |                   |              |





**Band 1 5150~5250MHz**  
**WIFI 802.11ac VHT80 (Harmonic @ 3m)**

| WIFI Ant. 1+2                | Note   | Frequency ( MHz ) | Level ( dBμV/m ) | Over Limit ( dB ) | Limit Line ( dBμV/m ) | Read Level (dBμV) | Antenna Factor ( dB/m ) | Cable Loss ( dB ) | Preamp Factor ( dB ) | Ant Pos ( cm ) | Table Pos ( deg ) | Peak Avg. (P/A) | Pol. (H/V) |   |
|------------------------------|--|-------------------|------------------|-------------------|-----------------------|-------------------|-------------------------|-------------------|----------------------|----------------|-------------------|-----------------|------------|---|
| 802.11ac VHT80 CH 42 5210MHz |  | 10420             | 46.82            | -27.18            | 74                    | 57.46             | 39.58                   | 14.98             | 65.2                 | 100            | 0                 | P               | H          |   |
|                              |  | 15630             | 44.27            | -29.73            | 74                    | 52.37             | 37.71                   | 18.39             | 64.2                 | 100            | 0                 | P               | H          |   |
|                              |  |                   |                  |                   |                       |                   |                         |                   |                      |                |                   |                 | H          |   |
|                              |  |                   |                  |                   |                       |                   |                         |                   |                      |                |                   |                 | H          |   |
|                              |  |                   | 10420            | 46.46             | -27.54                | 74                | 57.1                    | 39.58             | 14.98                | 65.2           | 100               | 0               | P          | V |
|                              |  |                   | 15630            | 44.2              | -29.8                 | 74                | 52.3                    | 37.71             | 18.39                | 64.2           | 100               | 0               | P          | V |
|                              |  |                   |                  |                   |                       |                   |                         |                   |                      |                |                   |                 |            | V |
| Remark                       | 5. No other spurious found.                                  |                   |                  |                   |                       |                   |                         |                   |                      |                |                   |                 |            |   |
|                              | 6. All results are PASS against Peak and Average limit line. |                   |                  |                   |                       |                   |                         |                   |                      |                |                   |                 |            |   |



**Note symbol**

|     |  |
|-----|--|
| *   | <b>Fundamental Frequency</b> which can be ignored. However, the level of any unwanted emissions shall not exceed the level of the fundamental frequency. |
| !   | Test result is <b>over limit</b> line.   |
| P/A | <b>Peak</b> or <b>Average</b>  |
| H/V | <b>Horizontal</b> or <b>Vertical</b>   |



A calculation example for radiated spurious emission is shown as below:

| WIFI    | Note | Frequency | Level      | Over   | Limit      | Read     | Antenna  | Cable  | Preamp | Ant    | Table   | Peak    | Pol.    |
|---------|------|-----------|------------|--------|------------|----------|----------|--------|--------|--------|---------|---------|---------|
| Ant.    |      |           |            | Limit  | Line       | Level    | Factor   | Loss   | Factor | Pos    | Pos     | Avg.    |         |
| 1+2     |      | ( MHz )   | ( dBμV/m ) | ( dB ) | ( dBμV/m ) | ( dBμV ) | ( dB/m ) | ( dB ) | ( dB ) | ( cm ) | ( deg ) | ( P/A ) | ( H/V ) |
| 802.11b |      | 2390      | 55.45      | -18.55 | 74         | 54.51    | 32.22    | 4.58   | 35.86  | 103    | 308     | P       | H       |
| CH 01   |      |           |            |        |            |          |          |        |        |        |         |         |         |
| 2412MHz |      | 2390      | 43.54      | -10.46 | 54         | 42.6     | 32.22    | 4.58   | 35.86  | 103    | 308     | A       | H       |

- Level(dBμV/m) =  
Antenna Factor(dB/m) + Cable Loss(dB) + Read Level(dBμV) - Preamp Factor(dB)
- Over Limit(dB) = Level(dBμV/m) – Limit Line(dBμV/m)

**For Peak Limit @ 2390MHz:**

- Level(dBμV/m)  
= Antenna Factor(dB/m) + Cable Loss(dB) + Read Level(dBμV) - Preamp Factor(dB)  
= 32.22(dB/m) + 4.58(dB) + 54.51(dBμV) – 35.86 (dB)  
= 55.45 (dBμV/m)
- Over Limit(dB)  
= Level(dBμV/m) – Limit Line(dBμV/m)  
= 55.45(dBμV/m) – 74(dBμV/m)  
= -18.55(dB)

**For Average Limit @ 2390MHz:**

- Level(dBμV/m)  
= Antenna Factor(dB/m) + Cable Loss(dB) + Read Level(dBμV) - Preamp Factor(dB)  
= 32.22(dB/m) + 4.58(dB) + 42.6(dBμV) – 35.86 (dB)  
= 43.54 (dBμV/m)
- Over Limit(dB)  
= Level(dBμV/m) – Limit Line(dBμV/m)  
= 43.54(dBμV/m) – 54(dBμV/m)  
= -10.46(dB)

Both peak and average measured complies with the limit line, so test result is “PASS”.



## Appendix D. Radiated Spurious Emission

|                 |                               |                     |         |
|-----------------|-------------------------------|---------------------|---------|
| Test Engineer : | Hao Hsu, Jacky Hung and KenWu | Temperature :       | 22~25°C |
|                 |                               | Relative Humidity : | 52~57%  |

### Note symbol

|    |                       |
|----|-----------------------|
| -L | Low channel location  |
| -R | High channel location |



<Single Mode>

**Band 1 - 5150~5250MHz**  
**WIFI 802.11a (Band Edge @ 3m)**

| WIFI        | Band 1 5150~5250MHz Band Edge @ 3m  |   |
|-------------|---|---|
| ANT         | 802.11a CH36 5180MHz  |   |
| 1           | Horizontal  | Fundamental   |
| <b>Peak</b> | <p>Site : 03CH11-HY<br/>Condition : PEAK_BE_74 3m HORN 91200-HF HORIZONTAL<br/>RBW:1000.000KHz VBW:3000.000KHz SWT:Auto<br/>Detector : Peak<br/>Project : 811726<br/>Setting : Z2</p> | <p>Site : 03CH11-HY<br/>Condition : PEAK(LINE) 3m HORN 91200-HF HORIZONTAL<br/>RBW:1000.000KHz VBW:3000.000KHz SWT:Auto<br/>Detector : Peak<br/>Project : 811726<br/>Setting : Z2</p> |
| <b>Avg.</b> | <p>Site : 03CH11-HY<br/>Condition : AVG_BE_54 3m HORN 91200-HF HORIZONTAL<br/>RBW:1000.000KHz VBW:1000KHz SWT:Auto<br/>Detector : Peak<br/>Project : 811726<br/>Setting : Z2</p>      | <b>Left blank</b>   |

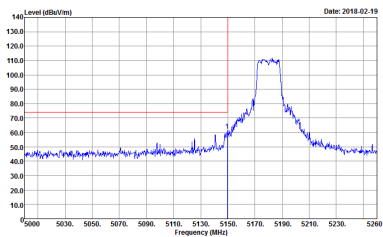
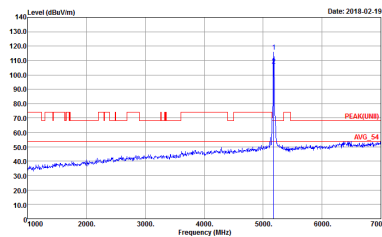
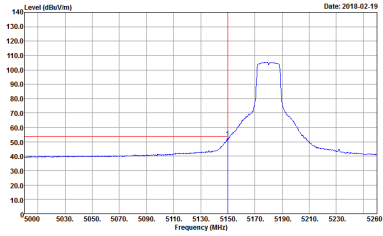

| WIFI               | Band 1 5150~5250MHz Band Edge @ 3m  |   |
|--------------------|---|---|
| ANT                | 802.11a CH36 5180MHz  |   |
| 1                  | Vertical  | Fundamental   |
| <p><b>Peak</b></p> |  <p>Site : 03CH11-HY<br/>           Condition : PEAK_BE_74 3m HORN 9120D-HF VERTICAL<br/>           Detector : Peak<br/>           Project : 811726<br/>           Setting : Z2</p>  |  <p>Site : 03CH11-HY<br/>           Condition : PEAK(UNII) 3m HORN 9120D-HF VERTICAL<br/>           Detector : Peak<br/>           Project : 811726<br/>           Setting : Z2</p> |
| <p><b>Avg.</b></p> |  <p>Site : 03CH11-HY<br/>           Condition : AVG_BE_54 3m HORN 9120D-HF VERTICAL<br/>           Detector : Peak<br/>           Project : 811726<br/>           Setting : Z2</p> | <p><b>Left blank</b></p>  |

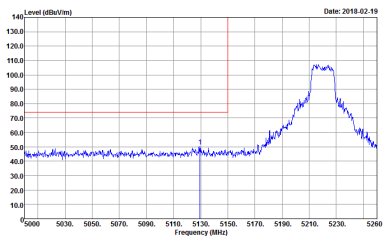
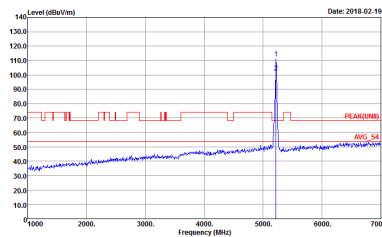
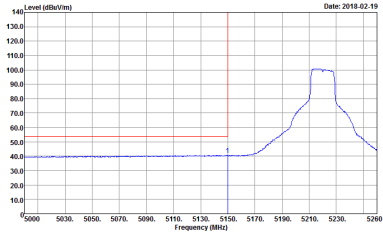

| WIFI               | Band 1 5150~5250MHz Band Edge @ 3m   |   |
|--------------------|--|---|
| ANT                | 802.11a CH44 5220MHz - L   |   |
| 1                  | Horizontal   | Fundamental   |
| <p><b>Peak</b></p> |  <p>Date: 2018.02.19</p> <p>Site : 03CH11-HY<br/>           Condition : PEAK_BE_74 3m HORN 9120D-HF HORIZONTAL<br/>           RBW:1000.000KHz VBW:3000.000KHz SWT:Auto<br/>           Detector : Peak<br/>           Project : 811726</p> |  <p>Date: 2018.02.19</p> <p>Site : 03CH11-HY<br/>           Condition : PEAKUNII 3m HORN 9120D-HF HORIZONTAL<br/>           RBW:1000.000KHz VBW:3000.000KHz SWT:Auto<br/>           Detector : Peak<br/>           Project : 811726</p> |
| <p><b>Avg.</b></p> |  <p>Date: 2018.02.19</p> <p>Site : 03CH11-HY<br/>           Condition : AVG_BE_54 3m HORN 9120D-HF HORIZONTAL<br/>           RBW:1000.000KHz VBW:1000KHz SWT:Auto<br/>           Detector : Peak<br/>           Project : 811726</p>    | <p><b>Left blank</b></p>  |

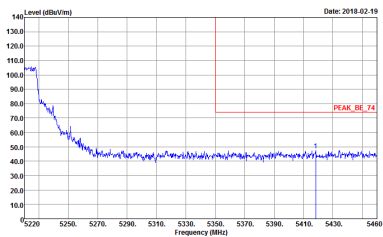
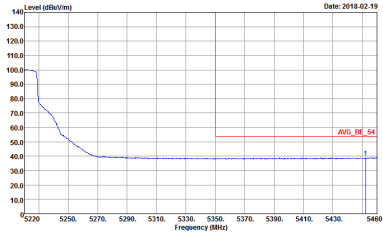

| WIFI               | Band 1 5150~5250MHz Band Edge @ 3m  |                   |
|--------------------|---|-------------------|
| ANT                | 802.11a CH44 5220MHz - R  |                   |
| 1                  | Horizontal  | Fundamental       |
| <p><b>Peak</b></p> |  <p>Site : 03CH11-HY<br/>           Condition : PEAK_BE_74 3m HORN 91200-HF HORIZONTAL<br/>           Detector : Peak<br/>           Project : 811726</p>  | <p>Left blank</p> |
| <p><b>Avg.</b></p> |  <p>Site : 03CH11-HY<br/>           Condition : AVG_BE_54 3m HORN 91200-HF HORIZONTAL<br/>           Detector : Peak<br/>           Project : 811726</p> | <p>Left blank</p> |





| WIFI               | Band 1 5150~5250MHz Band Edge @ 3m   |  |
|--------------------|--|--|
| ANT                | 802.11a CH44 5220MHz - L   |  |
| 1                  | Vertical   | Fundamental  |
| <p><b>Peak</b></p> | <p>Site : 03CH11-HY<br/>           Condition : PEAK_BE_74 3m HORN 9120D-HF VERTICAL<br/>           Detector : Peak<br/>           Project : 811726</p> | <p>Site : 03CH11-HY<br/>           Condition : PEAK(UNII) 3m HORN 9120D-HF VERTICAL<br/>           Detector : Peak<br/>           Project : 811726</p> |
| <p><b>Avg.</b></p> | <p>Site : 03CH11-HY<br/>           Condition : AVG_BE_54 3m HORN 9120D-HF VERTICAL<br/>           Detector : Peak<br/>           Project : 811726</p>  | <p><b>Left blank</b></p>   |

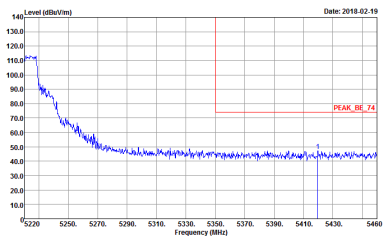
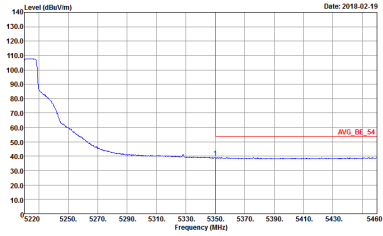

| WIFI               | Band 1 5150~5250MHz Band Edge @ 3m  |                   |
|--------------------|---|-------------------|
| ANT                | 802.11a CH44 5220MHz - R  |                   |
| 1                  | Vertical  | Fundamental       |
| <p><b>Peak</b></p> |  <p>Site : 03CH11-HY<br/>           Condition : PEAK_BE_74 3m HORN 91200-HF VERTICAL<br/>           Detector : Peak<br/>           Project : 811726</p>  | <p>Left blank</p> |
| <p><b>Avg.</b></p> |  <p>Site : 03CH11-HY<br/>           Condition : AVG_BE_54 3m HORN 91200-HF VERTICAL<br/>           Detector : Peak<br/>           Project : 811726</p> | <p>Left blank</p> |

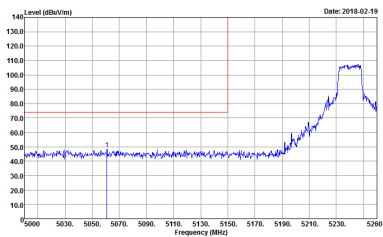
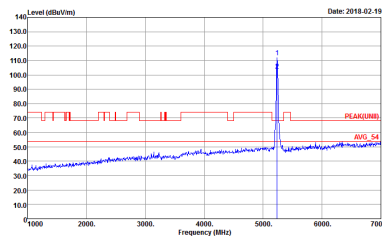
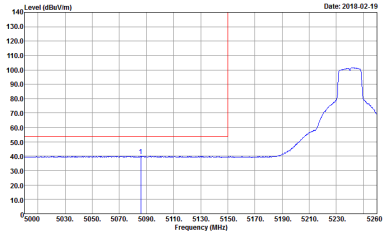

| WIFI               | Band 1 5150~5250MHz Band Edge @ 3m  |   |
|--------------------|---|---|
| ANT                | 802.11a CH48 5240MHz - L  |   |
| 1                  | Horizontal  | Fundamental   |
| <p><b>Peak</b></p> |  <p>Site : 03CH11-HY<br/>           Condition : PEAK_BE_74 3m HORN 91200-HF HORIZONTAL<br/>           Detector : Peak<br/>           Project : 811726</p>  |  <p>Site : 03CH11-HY<br/>           Condition : PEAK(LINB) 3m HORN 91200-HF HORIZONTAL<br/>           Detector : Peak<br/>           Project : 811726</p> |
| <p><b>Avg.</b></p> |  <p>Site : 03CH11-HY<br/>           Condition : AVG_BE_54 3m HORN 91200-HF HORIZONTAL<br/>           Detector : Peak<br/>           Project : 811726</p> | <p><b>Left blank</b></p>  |

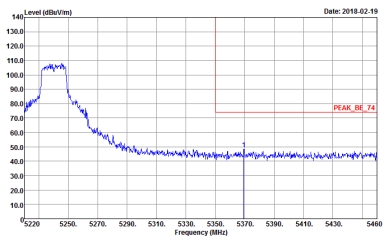
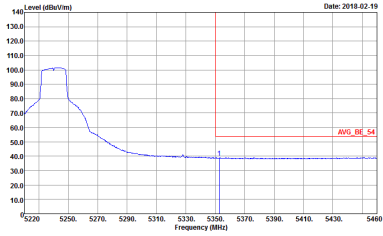

| WIFI               | Band 1 5150~5250MHz Band Edge @ 3m  |                   |
|--------------------|---|-------------------|
| ANT                | 802.11a CH48 5240MHz - R  |                   |
| 1                  | Horizontal  | Fundamental       |
| <p><b>Peak</b></p> |  <p>Site : 03CH11-HY<br/>           Condition : PEAK_BE_74 3m HORN 91200-HF HORIZONTAL<br/>           Detector : Peak<br/>           Project : 811726</p>  | <p>Left blank</p> |
| <p><b>Avg.</b></p> |  <p>Site : 03CH11-HY<br/>           Condition : AVG_BE_54 3m HORN 91200-HF HORIZONTAL<br/>           Detector : Peak<br/>           Project : 811726</p> | <p>Left blank</p> |



| WIFI               | Band 1 5150~5250MHz Band Edge @ 3m   |   |
|--------------------|--|---|
| ANT                | 802.11a CH48 5240MHz - L   |   |
| 1                  | Vertical   | Fundamental   |
| <p><b>Peak</b></p> | <p>Date: 2018.02.19</p> <p>Site : 03CH11-HY<br/>           Condition : PEAK_BE_74 3m HORN 9120D-HF VERTICAL<br/>           Detector : Peak<br/>           Project : 811726</p> | <p>Date: 2018.02.19</p> <p>Site : 03CH11-HY<br/>           Condition : PEAK(LMB) 3m HORN 9120D-HF VERTICAL<br/>           Detector : Peak<br/>           Project : 811726</p> |
| <p><b>Avg.</b></p> | <p>Date: 2018.02.19</p> <p>Site : 03CH11-HY<br/>           Condition : AVG_BE_54 3m HORN 9120D-HF VERTICAL<br/>           Detector : Peak<br/>           Project : 811726</p>  | <p><b>Left blank</b></p>  |

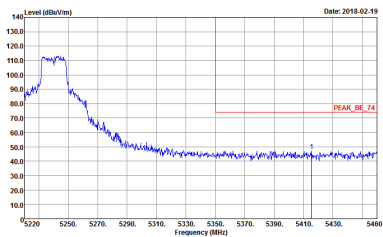
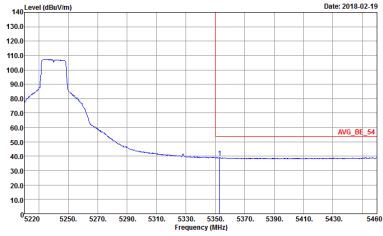

| WIFI               | Band 1 5150~5250MHz Band Edge @ 3m   |                   |
|--------------------|--|-------------------|
| ANT                | 802.11a CH48 5240MHz - R   |                   |
| 1                  | Vertical   | Fundamental       |
| <p><b>Peak</b></p> |  <p>Site : 03CH11-HY<br/>           Condition : PEAK_BE_74 3m HORN 91200-HF VERTICAL<br/>           RBW:1000.000KHz VBW:3000.000KHz SWT:Auto<br/>           Detector : Peak<br/>           Project : 811726</p> | <p>Left blank</p> |
| <p><b>Avg.</b></p> |  <p>Site : 03CH11-HY<br/>           Condition : AVG_BE_54 3m HORN 91200-HF VERTICAL<br/>           RBW:1000.000KHz VBW:1000KHz SWT:Auto<br/>           Detector : Peak<br/>           Project : 811726</p>    | <p>Left blank</p> |



**Band 1 5150~5250MHz**  
**WIFI 802.11ac VHT20 (Band Edge @ 3m)**

| WIFI        | Band 1 5150~5250MHz Band Edge @ 3m   |  |
|-------------|--|--|
| ANT         | 802.11ac VHT20 CH36 5180MHz  |  |
| 1           | Horizontal   | Fundamental  |
| <b>Peak</b> | <p>Site : 03CH11-HY<br/>           Condition : PEAK_BE_74 3m HORN 9120D-HF HORIZONTAL<br/>           Detector : Peak<br/>           Project : 811726<br/>           Setting : ZZ</p> | <p>Site : 03CH11-HY<br/>           Condition : PEAK(UNIT) 3m HORN 9120D-HF HORIZONTAL<br/>           Detector : Peak<br/>           Project : 811726<br/>           Setting : ZZ</p> |
| <b>Avg.</b> | <p>Site : 03CH11-HY<br/>           Condition : AVG_BE_54 3m HORN 9120D-HF HORIZONTAL<br/>           Detector : Peak<br/>           Project : 811726<br/>           Setting : ZZ</p>  | <b>Left blank</b>  |

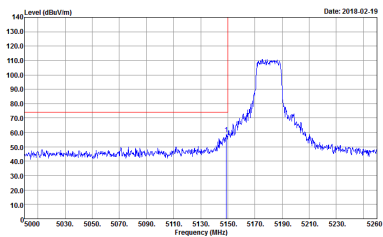
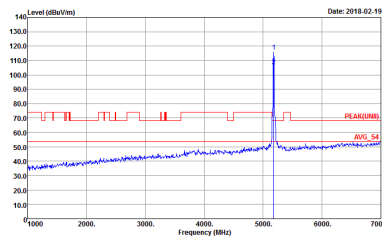
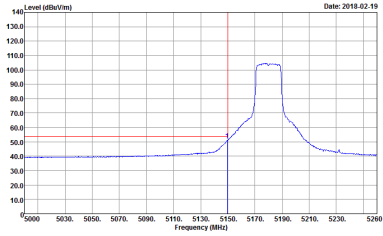

| WIFI               | Band 1 5150~5250MHz Band Edge @ 3m  |   |
|--------------------|---|---|
| ANT                | 802.11ac VHT20 CH36 5180MHz   |   |
| 1                  | Vertical  | Fundamental   |
| <p><b>Peak</b></p> |  <p>Site : 03CH11-HY<br/>           Condition : PEAK_BE_74 3m HORN 91200-HF VERTICAL<br/>           Detector : Peak<br/>           Project : 811726<br/>           Setting : Z2</p>  |  <p>Site : 03CH11-HY<br/>           Condition : PEAK(UNII) 3m HORN 91200-HF VERTICAL<br/>           Detector : Peak<br/>           Project : 811726<br/>           Setting : Z2</p> |
| <p><b>Avg.</b></p> |  <p>Site : 03CH11-HY<br/>           Condition : AVG_BE_54 3m HORN 91200-HF VERTICAL<br/>           Detector : Peak<br/>           Project : 811726<br/>           Setting : Z2</p> | <p><b>Left blank</b></p>  |





| WIFI        | Band 1 5150~5250MHz Band Edge @ 3m   |  |
|-------------|--|--|
| ANT         | 802.11ac VHT20 CH44 5220MHz - L  |  |
| 1           | Horizontal   | Fundamental  |
| <b>Peak</b> | <p>Site : 03CH11-HY<br/>           Condition : PEAK_BE_74 3m HORN 91200-HF HORIZONTAL<br/>           Detector : Peak<br/>           Project : 811726</p> | <p>Site : 03CH11-HY<br/>           Condition : PEAK(UNII) 3m HORN 91200-HF HORIZONTAL<br/>           Detector : Peak<br/>           Project : 811726</p> |
| <b>Avg.</b> | <p>Site : 03CH11-HY<br/>           Condition : AVG_BE_54 3m HORN 91200-HF HORIZONTAL<br/>           Detector : Peak<br/>           Project : 811726</p>  | <b>Left blank</b>  |

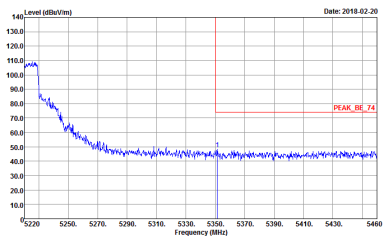
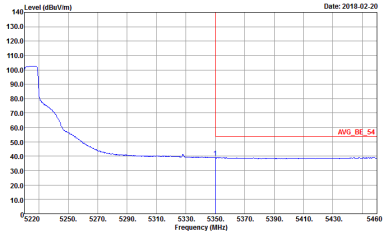

| WIFI               | Band 1 5150~5250MHz Band Edge @ 3m  |                   |
|--------------------|---|-------------------|
| ANT                | 802.11ac VHT20 CH44 5220MHz - R   |                   |
| 1                  | Horizontal  | Fundamental       |
| <p><b>Peak</b></p> |  <p>Site : 03CH11-HY<br/>           Condition : PEAK_BE_74 3m HORN 91200-HF HORIZONTAL<br/>           Detector : Peak<br/>           Project : 811726</p>  | <p>Left blank</p> |
| <p><b>Avg.</b></p> |  <p>Site : 03CH11-HY<br/>           Condition : AVG_BE_54 3m HORN 91200-HF HORIZONTAL<br/>           Detector : Peak<br/>           Project : 811726</p> | <p>Left blank</p> |



| WIFI        | Band 1 5150~5250MHz Band Edge @ 3m   |  |
|-------------|--|--|
| ANT         | 802.11ac VHT20 CH44 5220MHz - L  |  |
| 1           | Vertical   | Fundamental  |
| <b>Peak</b> | <p>Site : 03CH11-HY<br/>           Condition : PEAK_BE_74 3m HORN 91200-HF VERTICAL<br/>           Detector : Peak<br/>           Project : 811726</p> | <p>Site : 03CH11-HY<br/>           Condition : PEAKUNII 3m HORN 91200-HF VERTICAL<br/>           Detector : Peak<br/>           Project : 811726</p> |
| <b>Avg.</b> | <p>Site : 03CH11-HY<br/>           Condition : AVG_BE_54 3m HORN 91200-HF VERTICAL<br/>           Detector : Peak<br/>           Project : 811726</p>  | <b>Left blank</b>  |



| WIFI | Band 1 5150~5250MHz Band Edge @ 3m   |             |
|------|--|-------------|
| ANT  | 802.11ac VHT20 CH44 5220MHz - R  |             |
| 1    | Vertical   | Fundamental |
| Peak | <p>Site : 03CH11-HY<br/>Condition : PEAK_BE_74 3m HORN 91200-HF VERTICAL<br/>RBW:1000.000KHz VBW:3000.000KHz SWT:Auto<br/>Detector : Peak<br/>Project : 811726</p> | Left blank  |
| Avg. | <p>Site : 03CH11-HY<br/>Condition : AVG_BE_54 3m HORN 91200-HF VERTICAL<br/>RBW:1000.000KHz VBW:3.000KHz SWT:Auto<br/>Detector : Peak<br/>Project : 811726</p>     | Left blank  |

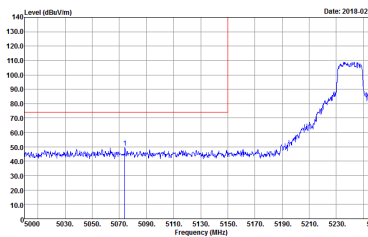
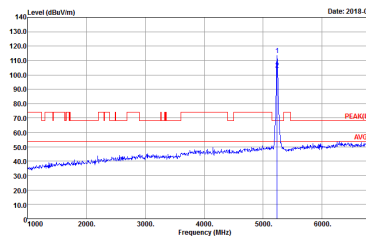
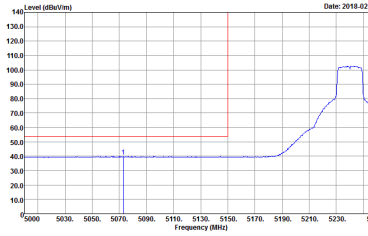

| WIFI | Band 1 5150~5250MHz Band Edge @ 3m  |   |
|------|---|---|
| ANT  | 802.11ac VHT20 CH48 5240MHz - L   |   |
| 1    | Horizontal  | Fundamental   |
| Peak |  <p>Date: 2018.02.20</p> <p>Site : 03CH11-HY<br/>           Condition : PEAK_BE_74 3m HORN 91200-HF HORIZONTAL<br/>           Detector : Peak<br/>           Project : 811726</p>  |  <p>Date: 2018.02.20</p> <p>Site : 03CH11-HY<br/>           Condition : PEAK(UNII) 3m HORN 91200-HF HORIZONTAL<br/>           Detector : Peak<br/>           Project : 811726</p> |
| Avg. |  <p>Date: 2018.02.20</p> <p>Site : 03CH11-HY<br/>           Condition : AVG_BE_54 3m HORN 91200-HF HORIZONTAL<br/>           Detector : Peak<br/>           Project : 811726</p> | Left blank  |

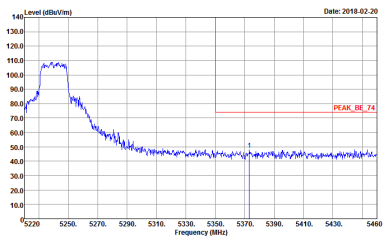
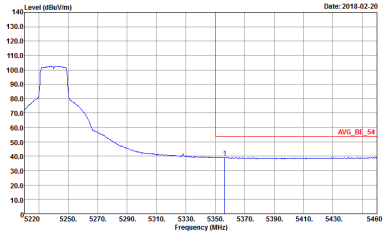

| WIFI               | Band 1 5150~5250MHz Band Edge @ 3m  |                   |
|--------------------|---|-------------------|
| ANT                | 802.11ac VHT20 CH48 5240MHz - R   |                   |
| 1                  | Horizontal  | Fundamental       |
| <p><b>Peak</b></p> |  <p>Site : 03CH11-HY<br/>           Condition : PEAK_BE_74 3m HORN 91200-HF HORIZONTAL<br/>           Detector : Peak<br/>           Project : 811726</p>  | <p>Left blank</p> |
| <p><b>Avg.</b></p> |  <p>Site : 03CH11-HY<br/>           Condition : AVG_BE_54 3m HORN 91200-HF HORIZONTAL<br/>           Detector : Peak<br/>           Project : 811726</p> | <p>Left blank</p> |



| WIFI | Band 1 5150~5250MHz Band Edge @ 3m   |   |
|------|--|---|
| ANT  | 802.11ac VHT20 CH48 5240MHz - L  |   |
| 1    | Vertical   | Fundamental   |
| Peak | <p>Site : 03CH11-HY<br/>           Condition : PEAK_BE_74 3m HORN 91200-HF VERTICAL<br/>           Detector : Peak<br/>           Project : 811726</p> | <p>Site : 03CH11-HY<br/>           Condition : PEAK(LINII) 3m HORN 91200-HF VERTICAL<br/>           Detector : Peak<br/>           Project : 811726</p> |
| Avg. | <p>Site : 03CH11-HY<br/>           Condition : AVG_BE_54 3m HORN 91200-HF VERTICAL<br/>           Detector : Peak<br/>           Project : 811726</p>  | Left blank  |

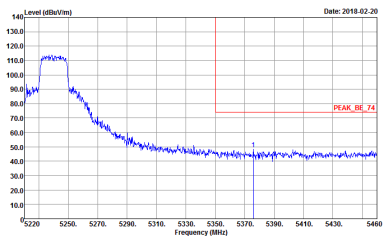
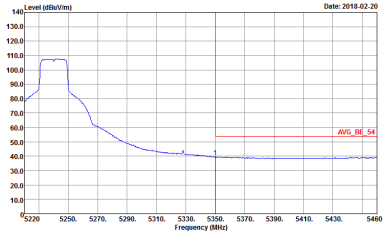

| WIFI               | Band 1 5150~5250MHz Band Edge @ 3m   |                   |
|--------------------|--|-------------------|
| ANT                | 802.11ac VHT20 CH48 5240MHz - R  |                   |
| 1                  | Vertical   | Fundamental       |
| <p><b>Peak</b></p> |  <p>Site : 03CH11-HY<br/>           Condition : PEAK_BE_74 3m HORN 91200-HF VERTICAL<br/>           : RBW:1000.000KHz VBW:3000.000KHz SWT:Auto<br/>           Detector : Peak<br/>           Project : 811726</p> | <p>Left blank</p> |
| <p><b>Avg.</b></p> |  <p>Site : 03CH11-HY<br/>           Condition : AVG_BE_54 3m HORN 91200-HF VERTICAL<br/>           : RBW:1000.000KHz VBW:3.000KHz SWT:Auto<br/>           Detector : Peak<br/>           Project : 811726</p>   | <p>Left blank</p> |



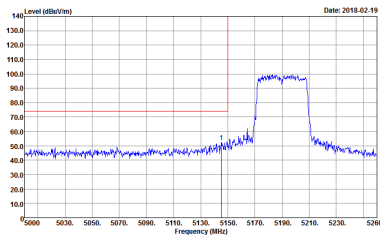
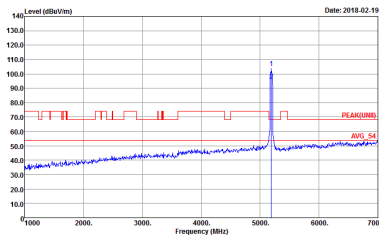
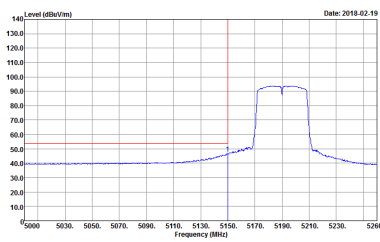

**Band 1 5150~5250MHz**  
**WIFI 802.11ac VHT40 (Band Edge @ 3m)**

| WIFI               | Band 1 5150~5250MHz Band Edge @ 3m  |   |
|--------------------|---|---|
| ANT                | 802.11ac VHT40 CH38 5190MHz - L   |   |
| 1                  | Horizontal  | Fundamental   |
| <p><b>Peak</b></p> |  <p>Site : 03CH11-HY<br/>           Condition : PEAK_BE_74 3m HORN 9120D-HF HORIZONTAL<br/>           Detector : Peak<br/>           Project : 811726<br/>           Setting : Z1</p>  |  <p>Site : 03CH11-HY<br/>           Condition : PEAK(UNIT) 3m HORN 9120D-HF HORIZONTAL<br/>           Detector : Peak<br/>           Project : 811726<br/>           Setting : Z1</p> |
| <p><b>Avg.</b></p> |  <p>Site : 03CH11-HY<br/>           Condition : AVG_BE_54 3m HORN 9120D-HF HORIZONTAL<br/>           Detector : Peak<br/>           Project : 811726<br/>           Setting : Z1</p> | <p><b>Left blank</b></p>  |

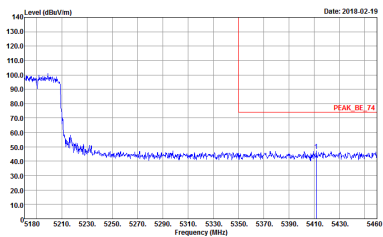
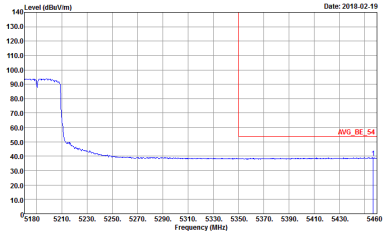

| WIFI               | Band 1 5150~5250MHz Band Edge @ 3m  |                   |
|--------------------|---|-------------------|
| ANT                | 802.11ac VHT40 CH38 5190MHz - R   |                   |
| 1                  | Horizontal  | Fundamental       |
| <p><b>Peak</b></p> |  <p>Site : 03CH11-HY<br/>           Condition : PEAK_BE_74 3m HORN 91200-HF HORIZONTAL<br/>           Detector : Peak<br/>           Project : 811726<br/>           Setting : Z1</p>  | <p>Left blank</p> |
| <p><b>Avg.</b></p> |  <p>Site : 03CH11-HY<br/>           Condition : AVG_BE_54 3m HORN 91200-HF HORIZONTAL<br/>           Detector : Peak<br/>           Project : 811726<br/>           Setting : Z1</p> | <p>Left blank</p> |



| WIFI        | Band 1 5150~5250MHz Band Edge @ 3m   |  |
|-------------|--|--|
| ANT         | 802.11ac VHT40 CH38 5190MHz - L  |  |
| 1           | Vertical   | Fundamental  |
| <b>Peak</b> | <p>Site : 03CH11-HY<br/>           Condition : PEAK_BE_74 3m HORN 9120D-HF VERTICAL<br/>           Detector : Peak<br/>           Project : 811726<br/>           Setting : Z1</p> | <p>Site : 03CH11-HY<br/>           Condition : PEAK(UNII) 3m HORN 9120D-HF VERTICAL<br/>           Detector : Peak<br/>           Project : 811726<br/>           Setting : Z1</p> |
| <b>Avg.</b> | <p>Site : 03CH11-HY<br/>           Condition : AVG_BE_54 3m HORN 9120D-HF VERTICAL<br/>           Detector : Peak<br/>           Project : 811726<br/>           Setting : Z1</p>  | <b>Left blank</b>  |



| WIFI | Band 1 5150~5250MHz Band Edge @ 3m   |             |
|------|--|-------------|
| ANT  | 802.11ac VHT40 CH38 5190MHz - R  |             |
| 1    | Vertical   | Fundamental |
| Peak | <p>Site : 03CH11-HY<br/>           Condition : PEAK_BE_74 3m HORN 91200-HF VERTICAL<br/>           : RBW:1000.000KHz VBW:3000.000KHz SWT:Auto<br/>           Detector : Peak<br/>           Project : 811726<br/>           Setting : Z1</p> | Left blank  |
| Avg. | <p>Site : 03CH11-HY<br/>           Condition : AVG_BE_54 3m HORN 91200-HF VERTICAL<br/>           : RBW:1000.000KHz VBW:1000KHz SWT:Auto<br/>           Detector : Peak<br/>           Project : 811726<br/>           Setting : Z1</p>      | Left blank  |

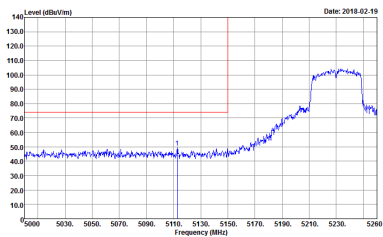
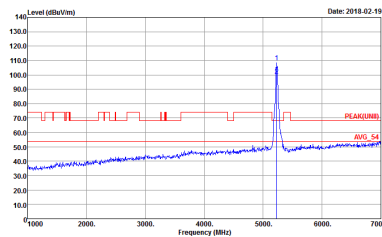
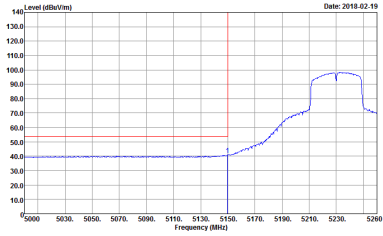

| WIFI | Band 1 5150~5250MHz Band Edge @ 3m  |   |
|------|---|---|
| ANT  | 802.11ac VHT40 CH46 5230MHz - L   |   |
| 1    | Horizontal  | Fundamental   |
| Peak |  <p>Site : 03CH11-HY<br/>           Condition : PEAK_BE_74 3m HORN 91200-HF HORIZONTAL<br/>           Detector : Peak<br/>           Project : 811726<br/>           Setting : Z5</p>  |  <p>Site : 03CH11-HY<br/>           Condition : PEAKUNII 3m HORN 91200-HF HORIZONTAL<br/>           Detector : Peak<br/>           Project : 811726<br/>           Setting : Z5</p> |
| Avg. |  <p>Site : 03CH11-HY<br/>           Condition : AVG_BE_54 3m HORN 91200-HF HORIZONTAL<br/>           Detector : Peak<br/>           Project : 811726<br/>           Setting : Z5</p> | Left blank  |

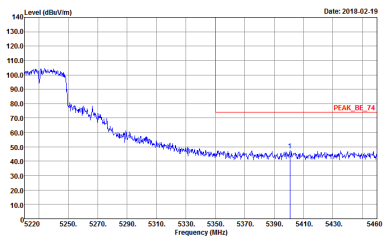
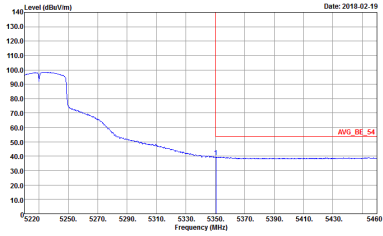

| WIFI | Band 1 5150~5250MHz Band Edge @ 3m   |             |
|------|--|-------------|
| ANT  | 802.11ac VHT40 CH46 5230MHz - R  |             |
| 1    | Horizontal   | Fundamental |
| Peak |  <p>Site : 03CH11-HY<br/> Condition : PEAK_BE_74 3m HORN 91200-HF HORIZONTAL<br/> : RBW:1000.000KHz VBW:3000.000KHz SWT:Auto<br/> Detector : Peak<br/> Project : 811726<br/> Setting : Z5</p> | Left blank  |
| Avg. |  <p>Site : 03CH11-HY<br/> Condition : AVG_BE_54 3m HORN 91200-HF HORIZONTAL<br/> : RBW:1000.000KHz VBW:1000KHz SWT:Auto<br/> Detector : Peak<br/> Project : 811726<br/> Setting : Z5</p>    | Left blank  |



| WIFI        | Band 1 5150~5250MHz Band Edge @ 3m   |  |
|-------------|--|--|
| ANT         | 802.11ac VHT40 CH46 5230MHz - L  |  |
| 1           | Vertical   | Fundamental  |
| <b>Peak</b> | <p>Site : 03CH11-HY<br/>           Condition : PEAK_BE_74 3m HORN 9120D-HF VERTICAL<br/>           : RBW:1000.000KHz VBW:3000.000KHz SWT:Auto<br/>           Detector : Peak<br/>           Project : 811726<br/>           Setting : Z5</p> | <p>Site : 03CH11-HY<br/>           Condition : PEAK(UNII) 3m HORN 9120D-HF VERTICAL<br/>           : RBW:1000.000KHz VBW:3000.000KHz SWT:Auto<br/>           Detector : Peak<br/>           Project : 811726<br/>           Setting : Z5</p> |
| <b>Avg.</b> | <p>Site : 03CH11-HY<br/>           Condition : AVG_BE_54 3m HORN 9120D-HF VERTICAL<br/>           : RBW:1000.000KHz VBW:1000KHz SWT:Auto<br/>           Detector : Peak<br/>           Project : 811726<br/>           Setting : Z5</p>      | <b>Left blank</b>  |

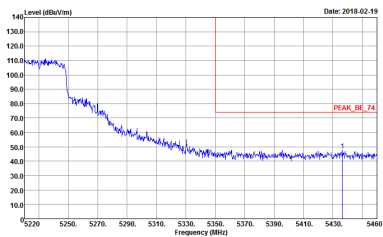
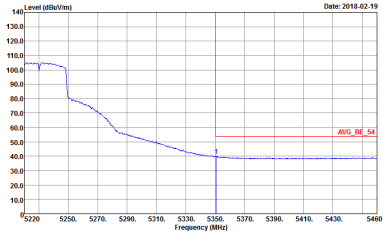

| WIFI               | Band 1 5150~5250MHz Band Edge @ 3m  |                   |
|--------------------|---|-------------------|
| ANT                | 802.11ac VHT40 CH46 5230MHz - R   |                   |
| 1                  | Vertical  | Fundamental       |
| <p><b>Peak</b></p> |  <p>Site : 03CH11-HY<br/>           Condition : PEAK_BE_74 3m HORN 91200-HF VERTICAL<br/>           Detector : Peak<br/>           Project : 811726<br/>           Setting : Z5</p>  | <p>Left blank</p> |
| <p><b>Avg.</b></p> |  <p>Site : 03CH11-HY<br/>           Condition : AVG_BE_54 3m HORN 91200-HF VERTICAL<br/>           Detector : Peak<br/>           Project : 811726<br/>           Setting : Z5</p> | <p>Left blank</p> |



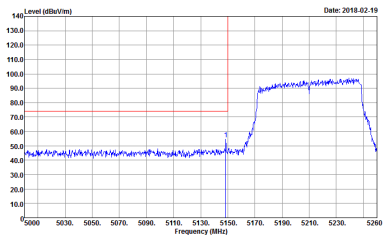
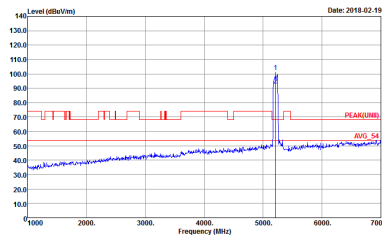
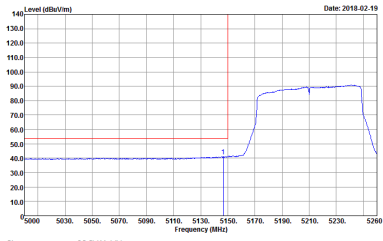

**Band 1 5150~5250MHz**  
**WIFI 802.11ac VHT80 (Band Edge @ 3m)**

| WIFI        | Band 1 5150~5250MHz Band Edge @ 3m   |  |
|-------------|--|--|
| ANT         | 802.11ac VHT80 CH42 5210MHz - L  |  |
| 1           | Horizontal   | Fundamental  |
| <b>Peak</b> |  <p>Site : 03CH11-HY<br/>           Condition : PEAK_BE_74 3m HORN 9120D-HF HORIZONTAL<br/>           Detector : Peak<br/>           Project : 811726<br/>           Setting : 215</p>  |  <p>Site : 03CH11-HY<br/>           Condition : PEAK(UNIT) 3m HORN 9120D-HF HORIZONTAL<br/>           Detector : Peak<br/>           Project : 811726<br/>           Setting : 215</p> |
| <b>Avg.</b> |  <p>Site : 03CH11-HY<br/>           Condition : AVG_BE_54 3m HORN 9120D-HF HORIZONTAL<br/>           Detector : Peak<br/>           Project : 811726<br/>           Setting : 215</p> | <b>Left blank</b>  |

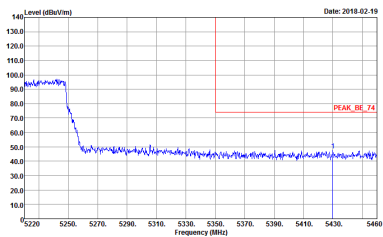
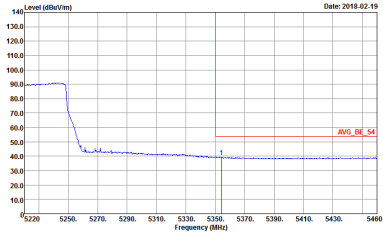

| WIFI               | Band 1 5150~5250MHz Band Edge @ 3m  |                   |
|--------------------|---|-------------------|
| ANT                | 802.11ac VHT80 CH42 5210MHz - R   |                   |
| 1                  | Horizontal  | Fundamental       |
| <p><b>Peak</b></p> |  <p>Site : 03CH11-HY<br/>           Condition : PEAK_BE_74 3m HORN 91200-HF HORIZONTAL<br/>           Detector : Peak<br/>           Project : 811726<br/>           Setting : 21.5</p>  | <p>Left blank</p> |
| <p><b>Avg.</b></p> |  <p>Site : 03CH11-HY<br/>           Condition : AVG_BE_54 3m HORN 91200-HF HORIZONTAL<br/>           Detector : Peak<br/>           Project : 811726<br/>           Setting : 21.5</p> | <p>Left blank</p> |

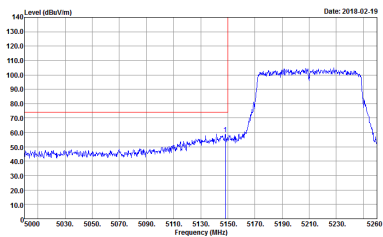
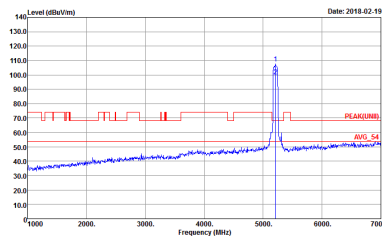
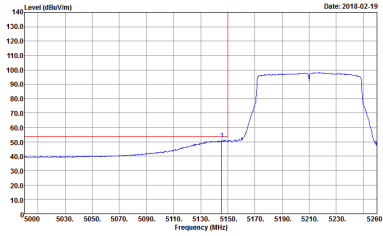

| WIFI               | Band 1 5150~5250MHz Band Edge @ 3m   |  |
|--------------------|--|--|
| ANT                | 802.11ac VHT80 CH42 5210MHz - L  |  |
| 1                  | Vertical   | Fundamental  |
| <p><b>Peak</b></p> |  <p>Site : 03CH11-HY<br/>           Condition : PEAK_BE_74 3m HORN 9120D-HF VERTICAL<br/>           Detector : Peak<br/>           Project : 811726<br/>           Setting : 215</p>  |  <p>Site : 03CH11-HY<br/>           Condition : PEAK(UNII) 3m HORN 9120D-HF VERTICAL<br/>           Detector : Peak<br/>           Project : 811726<br/>           Setting : 215</p> |
| <p><b>Avg.</b></p> |  <p>Site : 03CH11-HY<br/>           Condition : AVG_BE_54 3m HORN 9120D-HF VERTICAL<br/>           Detector : Peak<br/>           Project : 811726<br/>           Setting : 215</p> | <p><b>Left blank</b></p>   |

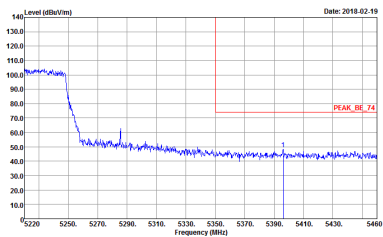
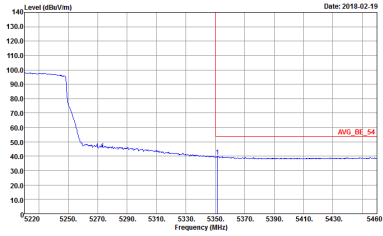

| WIFI               | Band 1 5150~5250MHz Band Edge @ 3m   |                   |
|--------------------|--|-------------------|
| ANT                | 802.11ac VHT80 CH42 5210MHz - R  |                   |
| 1                  | Vertical   | Fundamental       |
| <p><b>Peak</b></p> |  <p>Site : 03CH11-HY<br/>           Condition : PEAK_BE_74 3m HORN 91200-HF VERTICAL<br/>           : RBW:1000.000KHz VBW:3000.000KHz SWT:Auto<br/>           Detector : Peak<br/>           Project : 811726<br/>           Setting : 21.5</p> | <p>Left blank</p> |
| <p><b>Avg.</b></p> |  <p>Site : 03CH11-HY<br/>           Condition : AVG_BE_54 3m HORN 91200-HF VERTICAL<br/>           : RBW:1000.000KHz VBW:1000KHz SWT:Auto<br/>           Detector : Peak<br/>           Project : 811726<br/>           Setting : 21.5</p>    | <p>Left blank</p> |



**Band 1 - 5150~5250MHz**  
**WIFI 802.11a (Harmonic @ 3m)**

|                            |   |   |
|----------------------------|---|---|
| <b>WIFI</b>                | <b>Band 1 5150~5250MHz Harmonic @ 3m</b>  |   |
| <b>ANT</b>                 | <b>802.11a CH36 5180MHz</b>   |   |
| <b>1</b>                   | <b>Horizontal</b>   | <b>Vertical</b>   |
| <b>Peak</b><br><b>Avg.</b> | <p>Site : 03CH11-HY<br/>         Condition : PEAK(LINE) 3m HORN 9120D-HF HORIZONTAL<br/>         Project : 811726</p> | <p>Site : 03CH11-HY<br/>         Condition : PEAK(LINE) 3m HORN 9120D-HF VERTICAL<br/>         Project : 811726</p> |

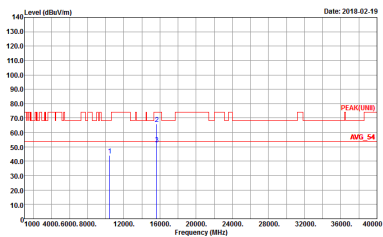
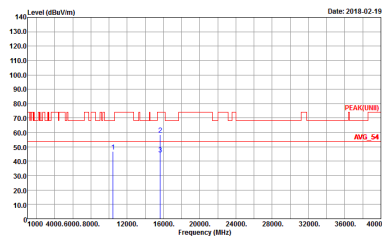

|                         |   |  |
|-------------------------|---|--|
| WIFI                    | Band 1 5150~5250MHz Harmonic @ 3m   |  |
| ANT                     | 802.11a CH44 5220MHz  |  |
| 1                       | Horizontal  | Vertical   |
| <p>Peak</p> <p>Avg.</p> |  <p>Site : 03CH11-11Y<br/>         Condition : PEAK[UNL1] 3m HORN 9120D-1HF HORIZONTAL<br/>         Project : 811726<br/>         Setting : 25</p> |  <p>Site : 03CH11-11Y<br/>         Condition : PEAK[UNL1] 3m HORN 9120D-1HF VERTICAL<br/>         Project : 811726<br/>         Setting : 25</p> |

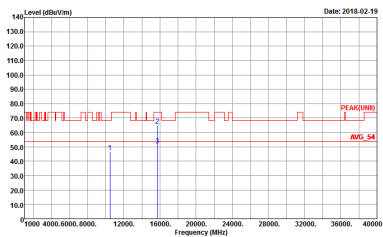
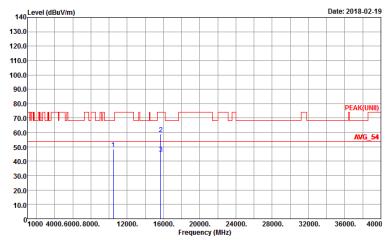

|                         |   |  |
|-------------------------|---|--|
| WIFI                    | Band 1 5150~5250MHz Harmonic @ 3m   |  |
| ANT                     | 802.11a CH48 5240MHz  |  |
| 1                       | Horizontal  | Vertical   |
| <p>Peak</p> <p>Avg.</p> |  <p>Site : 03CH11-11Y<br/>         Condition : PEAK[UNL1] 3m HORN 9120D-HF HORIZONTAL<br/>         Project : 811726<br/>         Setting : 245</p> |  <p>Site : 03CH11-11Y<br/>         Condition : PEAK[UNL1] 3m HORN 9120D-HF VERTICAL<br/>         Project : 811726<br/>         Setting : 245</p> |



**Band 1 5150~5250MHz  
WIFI 802.11ac VHT20 (Harmonic @ 3m)**

| WIFI                                  | Band 1 5150~5250MHz Harmonic @ 3m   |   |
|---------------------------------------|---|---|
| ANT                                   | 802.11ac VHT20 CH36 5180MHz   |   |
| 1                                     | Horizontal  | Vertical  |
| <p><b>Peak</b></p> <p><b>Avg.</b></p> | <p>Site : 03CH11-HY<br/>Condition : PEAK(UNIT) 3m HORN 9120D-HF HORIZONTAL<br/>Project : 811726</p> | <p>Site : 03CH11-HY<br/>Condition : PEAK(UNIT) 3m HORN 9120D-HF VERTICAL<br/>Project : 811726</p> |





| WIFI         | Band 1 5150~5250MHz Harmonic @ 3m   |   |
|--------------|---|---|
| ANT          | 802.11ac VHT20 CH44 5220MHz   |   |
| 1            | Horizontal  | Vertical  |
| Peak<br>Avg. | <p>Site : 03CH11-11Y<br/>Condition : PEAK[UNL1] 3m HORN 9120D-HF HORIZONTAL<br/>Project : 811726<br/>Setting : 25</p> | <p>Site : 03CH11-11Y<br/>Condition : PEAK[UNL1] 3m HORN 9120D-HF VERTICAL<br/>Project : 811726<br/>Setting : 25</p> |



| WIFI         | Band 1 5150~5250MHz Harmonic @ 3m  |  |
|--------------|--|--|
| ANT          | 802.11ac VHT20 CH48 5240MHz  |  |
| 1            | Horizontal   | Vertical   |
| Peak<br>Avg. | <p>Site : 03CH11-11Y<br/>Condition : PEAK[UNL1] 3m HORN 9120D-1HF HORIZONTAL<br/>Project : 811726<br/>Setting : 24.5</p> | <p>Site : 03CH11-11Y<br/>Condition : PEAK[UNL1] 3m HORN 9120D-1HF VERTICAL<br/>Project : 811726<br/>Setting : 24.5</p> |



**Band 1 5150~5250MHz  
WIFI 802.11ac VHT40 (Harmonic @ 3m)**

| WIFI                                  | Band 1 5150~5250MHz Harmonic @ 3m   |   |
|---------------------------------------|---|---|
| ANT                                   | 802.11ac VHT40 CH38 5190MHz   |   |
| 1                                     | Horizontal  | Vertical  |
| <p><b>Peak</b></p> <p><b>Avg.</b></p> | <p>Site : 03CH11-HY<br/>Condition : PEAK(UNIT) 3m HORN 9120D-HF HORIZONTAL<br/>Project : 811726</p> | <p>Site : 03CH11-HY<br/>Condition : PEAK(UNIT) 3m HORN 9120D-HF VERTICAL<br/>Project : 811726</p> |

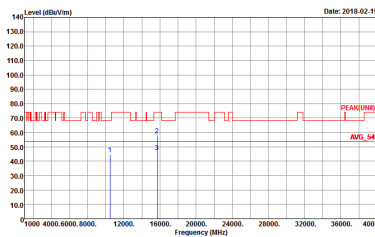
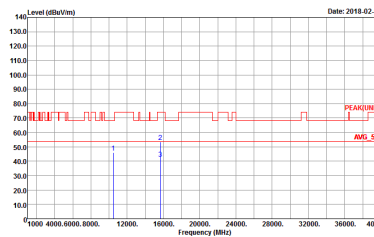

|                         |  |   |
|-------------------------|--|---|
| WIFI                    | Band 1 5150~5250MHz Harmonic @ 3m  |   |
| ANT                     | 802.11ac VHT40 CH46 5230MHz  |   |
| 1                       | Horizontal   | Vertical  |
| <p>Peak</p> <p>Avg.</p> |  <p>Date: 2018.02.19</p> <p>Site : 03CH11-11Y<br/>Condition : PEAK[UNL1] 3m HORN 9120D-HF HORIZONTAL<br/>Project : 811726</p> |  <p>Date: 2018.02.19</p> <p>Site : 03CH11-11Y<br/>Condition : PEAK[UNL1] 3m HORN 9120D-HF VERTICAL<br/>Project : 811726</p> |



**Band 1 5150~5250MHz  
WIFI 802.11ac VHT80 (Harmonic @ 3m)**

| WIFI                                  | Band 1 5150~5250MHz Harmonic @ 3m   |   |
|---------------------------------------|---|---|
| ANT                                   | 802.11ac VHT80 CH42 5210MHz   |   |
| 1                                     | Horizontal  | Vertical  |
| <p><b>Peak</b></p> <p><b>Avg.</b></p> | <p>Site : 03CH11-HY<br/>Condition : PEAK(UNIT) 3m HORN 9120D-HF HORIZONTAL<br/>Project : 811726</p> | <p>Site : 03CH11-HY<br/>Condition : PEAK(UNIT) 3m HORN 9120D-HF VERTICAL<br/>Project : 811726</p> |



Emission below 1GHz  
5GHz WIFI 802.11a (LF)

| WIFI         | 5GHz WIFI   |   |
|--------------|---|---|
| ANT          | 802.11a LF  |   |
| 1            | Horizontal  | Vertical  |
| QP /<br>Peak | <p>Site : 03CH11-HY<br/>Condition : QP 3m BE-LOG-6111D-LF_ETC HORIZONTAL<br/>Detector : Peak<br/>Project : 811726</p> | <p>Site : 03CH11-HY<br/>Condition : QP 3m BE-LOG-6111D-LF_ETC VERTICAL<br/>Detector : Peak<br/>Project : 811726</p> |



<CDD Mode>

Band 1 - 5150~5250MHz  
WIFI 802.11a (Band Edge @ 3m)

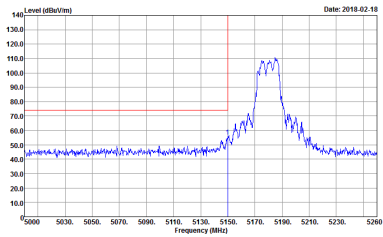
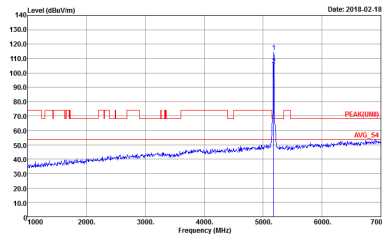
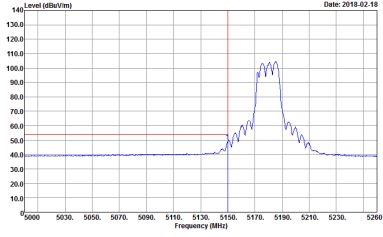
| WIFI | Band 1 5150~5250MHz Band Edge @ 3m  |   |
|------|---|---|
| ANT  | 802.11a CH36 5180MHz  |   |
| 1+2  | Horizontal  | Fundamental   |
| Peak |  <p>Site : 03CH11-HY<br/>Condition : PEAK_BE_74 3m HORN 9120D-HF HORIZONTAL<br/>Detector : Peak<br/>Project : 811726<br/>Setting : Z2</p>  |  <p>Site : 03CH11-HY<br/>Condition : PEAK(LINE) 3m HORN 9120D-HF HORIZONTAL<br/>Detector : Peak<br/>Project : 811726<br/>Setting : Z2</p> |
| Avg. |  <p>Site : 03CH11-HY<br/>Condition : AV6_BE_54 3m HORN 9120D-HF HORIZONTAL<br/>Detector : Peak<br/>Project : 811726<br/>Setting : Z2</p> | Left blank  |

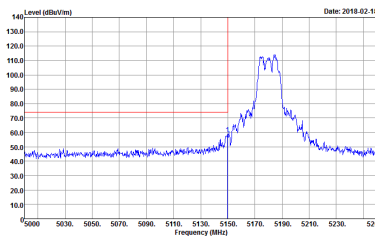
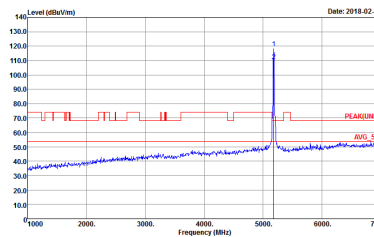
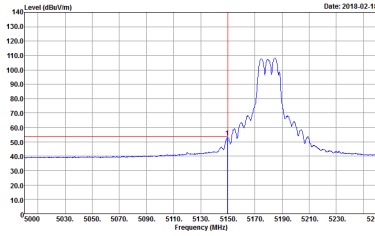

| WIFI               | Band 1 5150~5250MHz Band Edge @ 3m  |   |
|--------------------|---|---|
| ANT                | 802.11a CH36 5180MHz  |   |
| 1+2                | Vertical  | Fundamental   |
| <p><b>Peak</b></p> |  <p>Date: 2018.02.18</p> <p>Site : 03CH11-HY<br/>           Condition : PEAK_BE_74 3m HORN 9120D-HF VERTICAL<br/>           Detector : Peak<br/>           Project : 811726<br/>           Setting : Z2</p>  |  <p>Date: 2018.02.18</p> <p>Site : 03CH11-HY<br/>           Condition : PEAK(UM) 3m HORN 9120D-HF VERTICAL<br/>           Detector : Peak<br/>           Project : 811726<br/>           Setting : Z2</p> |
| <p><b>Avg.</b></p> |  <p>Date: 2018.02.18</p> <p>Site : 03CH11-HY<br/>           Condition : AVG_BE_54 3m HORN 9120D-HF VERTICAL<br/>           Detector : Peak<br/>           Project : 811726<br/>           Setting : Z2</p> | <p><b>Left blank</b></p>  |





| WIFI               | Band 1 5150~5250MHz Band Edge @ 3m   |  |
|--------------------|--|--|
| ANT                | 802.11a CH44 5220MHz - L   |  |
| 1+2                | Horizontal   | Fundamental  |
| <p><b>Peak</b></p> | <p>Site : 03CH11-HY<br/>           Condition : PEAK_BE_74 3m HORN 91200-HF HORIZONTAL<br/>           Detector : Peak<br/>           Project : 811726<br/>           Setting : Z5</p> | <p>Site : 03CH11-HY<br/>           Condition : PEAK(LIMB) 3m HORN 91200-HF HORIZONTAL<br/>           Detector : Peak<br/>           Project : 811726<br/>           Setting : Z5</p> |
| <p><b>Avg.</b></p> | <p>Site : 03CH11-HY<br/>           Condition : AVG_BE_54 3m HORN 91200-HF HORIZONTAL<br/>           Detector : Peak<br/>           Project : 811726<br/>           Setting : Z5</p>  | <p><b>Left blank</b></p>   |

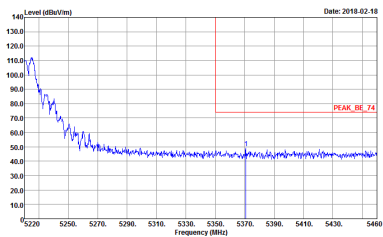
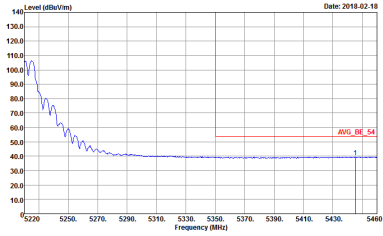

| WIFI               | Band 1 5150~5250MHz Band Edge @ 3m  |                   |
|--------------------|---|-------------------|
| ANT                | 802.11a CH44 5220MHz - R  |                   |
| 1+2                | Horizontal  | Fundamental       |
| <p><b>Peak</b></p> |  <p>Site : 03CH11-HY<br/>           Condition : PEAK_BE_74 3m HORN 91200-HF HORIZONTAL<br/>           Detector : Peak<br/>           Project : 811726<br/>           Setting : Z5</p>  | <p>Left blank</p> |
| <p><b>Avg.</b></p> |  <p>Site : 03CH11-HY<br/>           Condition : AVG_BE_54 3m HORN 91200-HF HORIZONTAL<br/>           Detector : Peak<br/>           Project : 811726<br/>           Setting : Z5</p> | <p>Left blank</p> |

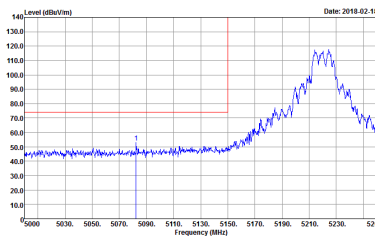
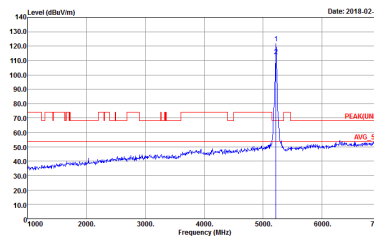
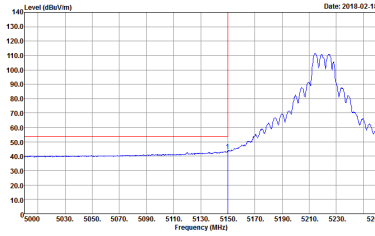

| WIFI               | Band 1 5150~5250MHz Band Edge @ 3m   |   |
|--------------------|--|---|
| ANT                | 802.11a CH44 5220MHz - L   |   |
| 1+2                | Vertical   | Fundamental   |
| <p><b>Peak</b></p> |  <p>Date: 2018.02.18</p> <p>Site : 03CH11-HY<br/>           Condition : PEAK_BE_74 3m HORN 9120D-HF VERTICAL<br/>           RBW:1000.000KHz VBW:3000.000KHz SWT:Auto<br/>           Detector : Peak<br/>           Project : 811726<br/>           Setting : Z5</p> |  <p>Date: 2018.02.18</p> <p>Site : 03CH11-HY<br/>           Condition : PEAK(UNII) 3m HORN 9120D-HF VERTICAL<br/>           RBW:1000.000KHz VBW:3000.000KHz SWT:Auto<br/>           Detector : Peak<br/>           Project : 811726<br/>           Setting : Z5</p> |
| <p><b>Avg.</b></p> |  <p>Date: 2018.02.18</p> <p>Site : 03CH11-HY<br/>           Condition : AVG_BE_54 3m HORN 9120D-HF VERTICAL<br/>           RBW:1000.000KHz VBW:1000KHz SWT:Auto<br/>           Detector : Peak<br/>           Project : 811726<br/>           Setting : Z5</p>    | <p><b>Left blank</b></p>  |

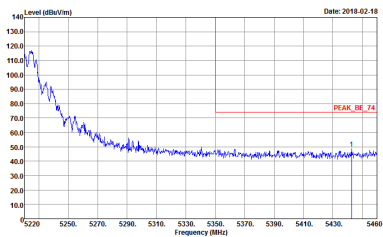
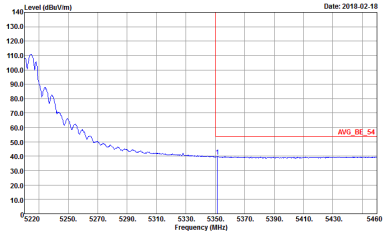

| WIFI               | Band 1 5150~5250MHz Band Edge @ 3m   |                   |
|--------------------|--|-------------------|
| ANT                | 802.11a CH44 5220MHz - R   |                   |
| 1+2                | Vertical   | Fundamental       |
| <p><b>Peak</b></p> |  <p>Site : 03CH11-HY<br/>           Condition : PEAK_BE_74 3m HORN 91200-HF VERTICAL<br/>           : RBW:1000.000KHz VBW:3000.000KHz SWT:Auto<br/>           Detector : Peak<br/>           Project : 811726<br/>           Setting : Z5</p> | <p>Left blank</p> |
| <p><b>Avg.</b></p> |  <p>Site : 03CH11-HY<br/>           Condition : AVG_BE_54 3m HORN 91200-HF VERTICAL<br/>           : RBW:1000.000KHz VBW:1000KHz SWT:Auto<br/>           Detector : Peak<br/>           Project : 811726<br/>           Setting : Z5</p>    | <p>Left blank</p> |

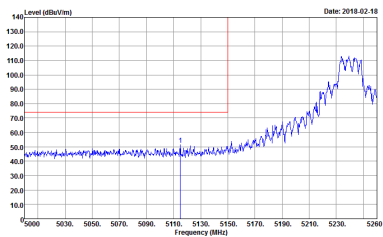
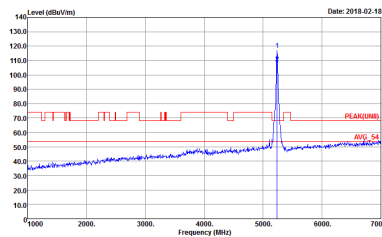
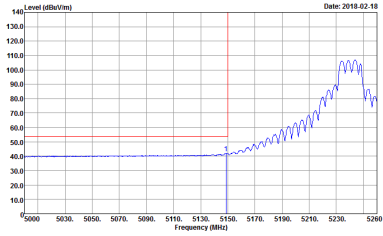

| WIFI               | Band 1 5150~5250MHz Band Edge @ 3m  |   |
|--------------------|---|---|
| ANT                | 802.11a CH48 5240MHz - L  |   |
| 1+2                | Horizontal  | Fundamental   |
| <p><b>Peak</b></p> |  <p>Date: 2018.02.18</p> <p>Site : 03CH11-HY<br/>           Condition : PEAK_BE_74 3m HORN 91200-HF HORIZONTAL<br/>           Detector : Peak<br/>           Project : 811726<br/>           Setting : Z6</p>  |  <p>Date: 2018.02.18</p> <p>Site : 03CH11-HY<br/>           Condition : PEAKUNII 3m HORN 91200-HF HORIZONTAL<br/>           Detector : Peak<br/>           Project : 811726<br/>           Setting : Z6</p> |
| <p><b>Avg.</b></p> |  <p>Date: 2018.02.18</p> <p>Site : 03CH11-HY<br/>           Condition : AVG_BE_54 3m HORN 91200-HF HORIZONTAL<br/>           Detector : Peak<br/>           Project : 811726<br/>           Setting : Z6</p> | <p><b>Left blank</b></p>  |

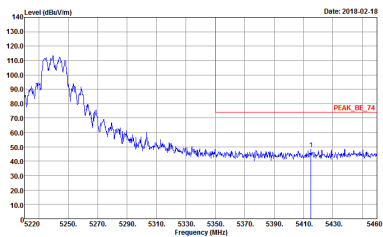
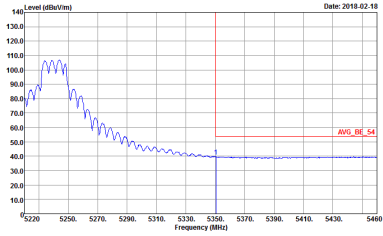

| WIFI               | Band 1 5150~5250MHz Band Edge @ 3m  |                   |
|--------------------|---|-------------------|
| ANT                | 802.11a CH48 5240MHz - R  |                   |
| 1+2                | Horizontal  | Fundamental       |
| <p><b>Peak</b></p> |  <p>Site : 03CH11-HY<br/>           Condition : PEAK_BE_74 3m HORN 91200-HF HORIZONTAL<br/>           Detector : Peak<br/>           Project : 811726<br/>           Setting : 26</p>  | <p>Left blank</p> |
| <p><b>Avg.</b></p> |  <p>Site : 03CH11-HY<br/>           Condition : AVG_BE_54 3m HORN 91200-HF HORIZONTAL<br/>           Detector : Peak<br/>           Project : 811726<br/>           Setting : 26</p> | <p>Left blank</p> |

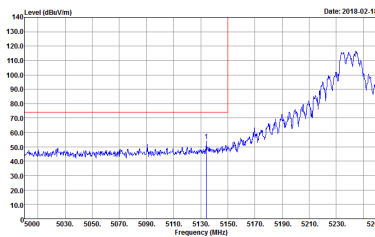
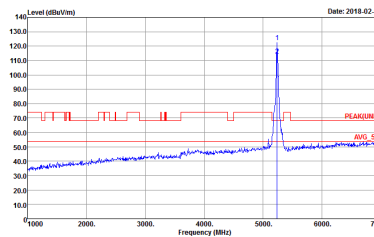
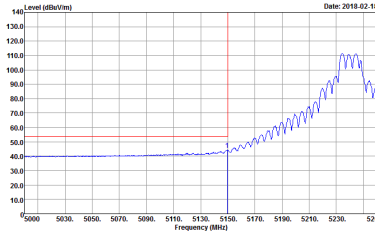

| WIFI               | Band 1 5150~5250MHz Band Edge @ 3m  |   |
|--------------------|---|---|
| ANT                | 802.11a CH48 5240MHz - L  |   |
| 1+2                | Vertical  | Fundamental   |
| <p><b>Peak</b></p> |  <p>Site : 03CH11-HY<br/>           Condition : PEAK_BE_74 3m HORN 9120D-HF VERTICAL<br/>           Detector : Peak<br/>           Project : 811726<br/>           Setting : Z6</p>  |  <p>Site : 03CH11-HY<br/>           Condition : PEAKUNII 3m HORN 9120D-HF VERTICAL<br/>           Detector : Peak<br/>           Project : 811726<br/>           Setting : Z6</p> |
| <p><b>Avg.</b></p> |  <p>Site : 03CH11-HY<br/>           Condition : AVG_BE_54 3m HORN 9120D-HF VERTICAL<br/>           Detector : Peak<br/>           Project : 811726<br/>           Setting : Z6</p> | <p>Left blank</p>   |



| WIFI               | Band 1 5150~5250MHz Band Edge @ 3m |                   |
|--------------------|------------------------------------|-------------------|
| ANT                | 802.11a CH48 5240MHz - R           |                   |
| 1+2                | Vertical                           | Fundamental       |
| <p><b>Peak</b></p> |                                    | <p>Left blank</p> |
| <p><b>Avg.</b></p> |                                    | <p>Left blank</p> |





**Band 1 5150~5250MHz**  
**WIFI 802.11ac VHT20 (Band Edge @ 3m)**

| WIFI        | Band 1 5150~5250MHz Band Edge @ 3m   |   |
|-------------|--|---|
| ANT         | 802.11ac VHT20 CH36 5180MHz  |   |
| 1+2         | Horizontal   | Fundamental   |
| <b>Peak</b> | <p>Site : 03CH11-HY<br/>           Condition : PEAK_BE_74 3m HORN 9120D-JF HORIZONTAL<br/>           Detector : Peak<br/>           Project : 811726<br/>           Setting : ZZ</p> | <p>Site : 03CH11-HY<br/>           Condition : PEAK_74 3m HORN 9120D-JF HORIZONTAL<br/>           Detector : Peak<br/>           Project : 811726<br/>           Setting : ZZ</p> |
| <b>Avg.</b> | <p>Site : 03CH11-HY<br/>           Condition : AVG_BE_54 3m HORN 9120D-JF HORIZONTAL<br/>           Detector : Peak<br/>           Project : 811726<br/>           Setting : ZZ</p>  | <b>Left blank</b>   |

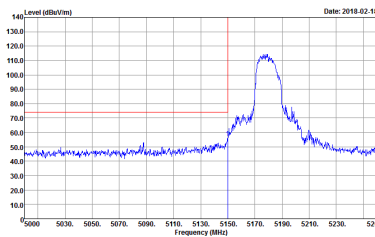
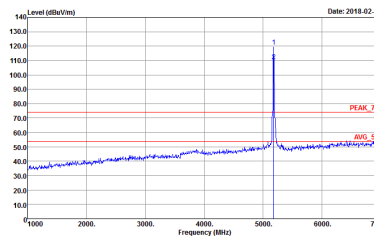
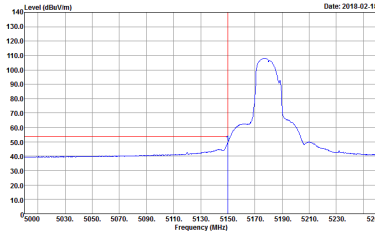

| WIFI               | Band 1 5150~5250MHz Band Edge @ 3m  |  |
|--------------------|---|--|
| ANT                | 802.11ac VHT20 CH36 5180MHz   |  |
| 1+2                | Vertical  | Fundamental  |
| <p><b>Peak</b></p> |  <p>Site : 03CH11-HY<br/>           Condition : PEAK_BE_74 3m HORN 91200-HF VERTICAL<br/>           Detector : Peak<br/>           Project : 811726<br/>           Setting : Z2</p>  |  <p>Site : 03CH11-HY<br/>           Condition : PEAK_74 3m HORN 91200-HF VERTICAL<br/>           Detector : Peak<br/>           Project : 811726<br/>           Setting : Z2</p> |
| <p><b>Avg.</b></p> |  <p>Site : 03CH11-HY<br/>           Condition : AVG_BE_54 3m HORN 91200-HF VERTICAL<br/>           Detector : Peak<br/>           Project : 811726<br/>           Setting : Z2</p> | <p><b>Left blank</b></p>   |

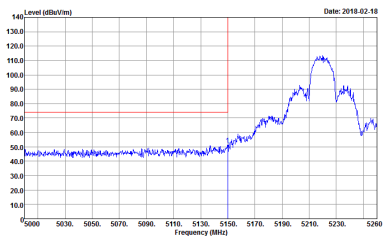
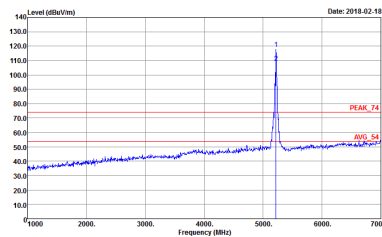
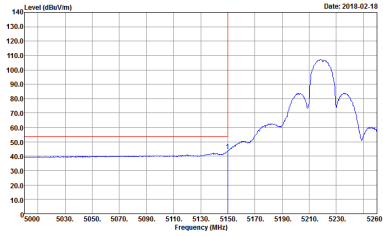

| WIFI               | Band 1 5150~5250MHz Band Edge @ 3m  |  |
|--------------------|---|--|
| ANT                | 802.11ac VHT20 CH44 5220MHz - L   |  |
| 1+2                | Horizontal  | Fundamental  |
| <p><b>Peak</b></p> |  <p>Site : 03CH11-HY<br/>           Condition : PEAK_BE_74 3m HORN 91200-HF HORIZONTAL<br/>           Detector : Peak<br/>           Project : 811726<br/>           Setting : 25.5</p>  |  <p>Site : 03CH11-HY<br/>           Condition : PEAK_74 3m HORN 91200-HF HORIZONTAL<br/>           Detector : Peak<br/>           Project : 811726<br/>           Setting : 25.5</p> |
| <p><b>Avg.</b></p> |  <p>Site : 03CH11-HY<br/>           Condition : AVG_BE_54 3m HORN 91200-HF HORIZONTAL<br/>           Detector : Peak<br/>           Project : 811726<br/>           Setting : 25.5</p> | <p><b>Left blank</b></p>   |

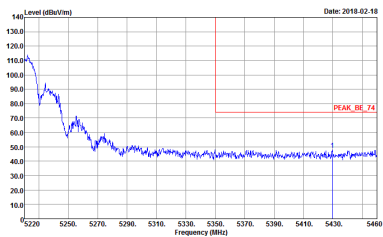
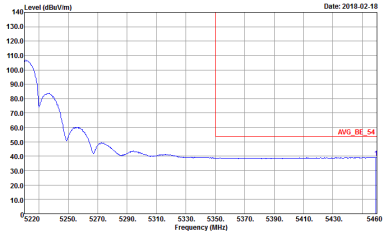

| WIFI               | Band 1 5150~5250MHz Band Edge @ 3m  |                   |
|--------------------|---|-------------------|
| ANT                | 802.11ac VHT20 CH44 5220MHz - R   |                   |
| 1+2                | Horizontal  | Fundamental       |
| <p><b>Peak</b></p> |  <p>Site : 03CH11-HY<br/>           Condition : PEAK_BE_74 3m HORN 91200-HF HORIZONTAL<br/>           Detector : Peak<br/>           Project : 811726<br/>           Setting : 25.5</p>  | <p>Left blank</p> |
| <p><b>Avg.</b></p> |  <p>Site : 03CH11-HY<br/>           Condition : AVG_BE_54 3m HORN 91200-HF HORIZONTAL<br/>           Detector : Peak<br/>           Project : 811726<br/>           Setting : 25.5</p> | <p>Left blank</p> |



| WIFI               | Band 1 5150~5250MHz Band Edge @ 3m |                          |
|--------------------|------------------------------------|--------------------------|
| ANT                | 802.11ac VHT20 CH44 5220MHz - L    |                          |
| 1+2                | Vertical                           | Fundamental              |
| <p><b>Peak</b></p> |                                    |                          |
| <p><b>Avg.</b></p> |                                    | <p><b>Left blank</b></p> |

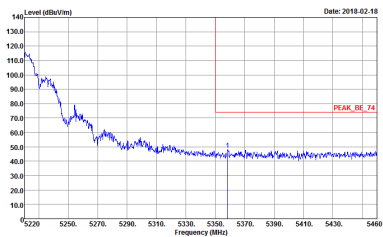
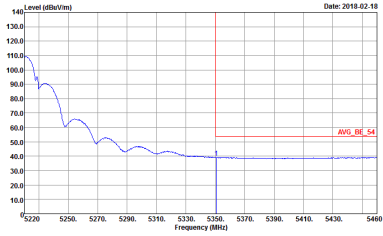

| WIFI               | Band 1 5150~5250MHz Band Edge @ 3m  |                   |
|--------------------|---|-------------------|
| ANT                | 802.11ac VHT20 CH44 5220MHz - R   |                   |
| 1+2                | Vertical  | Fundamental       |
| <p><b>Peak</b></p> |  <p>Site : 03CH11-HY<br/>           Condition : PEAK_BE_74 3m HORN 91200-HF VERTICAL<br/>           Detector : Peak<br/>           Project : 811726<br/>           Setting : 25.5</p>  | <p>Left blank</p> |
| <p><b>Avg.</b></p> |  <p>Site : 03CH11-HY<br/>           Condition : AVG_BE_54 3m HORN 91200-HF VERTICAL<br/>           Detector : Peak<br/>           Project : 811726<br/>           Setting : 25.5</p> | <p>Left blank</p> |



| WIFI               | Band 1 5150~5250MHz Band Edge @ 3m   |  |
|--------------------|--|--|
| ANT                | 802.11ac VHT20 CH48 5240MHz - L  |  |
| 1+2                | Horizontal   | Fundamental  |
| <p><b>Peak</b></p> | <p>Site : 03CH11-HY<br/>           Condition : PEAK_BE_74 3m HORN 91200-HF HORIZONTAL<br/>           Detector : Peak<br/>           Project : 811726<br/>           Setting : 25.5</p> | <p>Site : 03CH11-HY<br/>           Condition : PEAK(LIMB) 3m HORN 91200-HF HORIZONTAL<br/>           Detector : Peak<br/>           Project : 811726<br/>           Setting : 25.5</p> |
| <p><b>Avg.</b></p> | <p>Site : 03CH11-HY<br/>           Condition : AVG_BE_54 3m HORN 91200-HF HORIZONTAL<br/>           Detector : Peak<br/>           Project : 811726<br/>           Setting : 25.5</p>  | <p><b>Left blank</b></p>   |

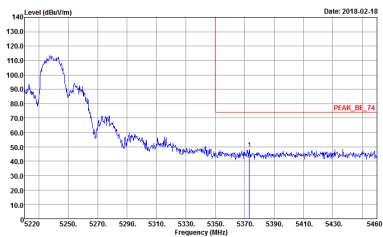
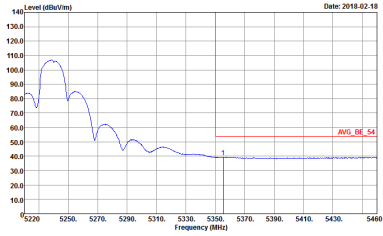

| WIFI               | Band 1 5150~5250MHz Band Edge @ 3m  |                   |
|--------------------|---|-------------------|
| ANT                | 802.11ac VHT20 CH48 5240MHz - R   |                   |
| 1+2                | Horizontal  | Fundamental       |
| <p><b>Peak</b></p> |  <p>Site : 03CH11-HY<br/>           Condition : PEAK_BE_74 3m HORN 91200-HF HORIZONTAL<br/>           Detector : Peak<br/>           Project : 811726<br/>           Setting : 25.5</p>  | <p>Left blank</p> |
| <p><b>Avg.</b></p> |  <p>Site : 03CH11-HY<br/>           Condition : AVG_BE_54 3m HORN 91200-HF HORIZONTAL<br/>           Detector : Peak<br/>           Project : 811726<br/>           Setting : 25.5</p> | <p>Left blank</p> |





| WIFI               | Band 1 5150~5250MHz Band Edge @ 3m   |  |
|--------------------|--|--|
| ANT                | 802.11ac VHT20 CH48 5240MHz - L  |  |
| 1+2                | Vertical   | Fundamental  |
| <p><b>Peak</b></p> | <p>Site : 03CH11-HY<br/>           Condition : PEAK_BE_74 3m HORN 91200-HF VERTICAL<br/>           Detector : Peak<br/>           Project : 811726<br/>           Setting : 25.5</p> | <p>Site : 03CH11-HY<br/>           Condition : PEAK(UNII) 3m HORN 91200-HF VERTICAL<br/>           Detector : Peak<br/>           Project : 811726<br/>           Setting : 25.5</p> |
| <p><b>Avg.</b></p> | <p>Site : 03CH11-HY<br/>           Condition : AVG_BE_54 3m HORN 91200-HF VERTICAL<br/>           Detector : Peak<br/>           Project : 811726<br/>           Setting : 25.5</p>  | <p><b>Left blank</b></p>   |



| WIFI | Band 1 5150~5250MHz Band Edge @ 3m   |             |
|------|--|-------------|
| ANT  | 802.11ac VHT20 CH48 5240MHz - R  |             |
| 1+2  | Vertical   | Fundamental |
| Peak | <p>Site : 03CH11-HY<br/>           Condition : PEAK_BE_74 3m HORN 91200-HF VERTICAL<br/>           Detector : Peak<br/>           Project : 811726<br/>           Setting : 25.5</p> | Left blank  |
| Avg. | <p>Site : 03CH11-HY<br/>           Condition : AVG_BE_54 3m HORN 91200-HF VERTICAL<br/>           Detector : Peak<br/>           Project : 811726<br/>           Setting : 25.5</p>  | Left blank  |

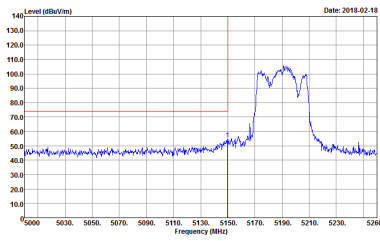
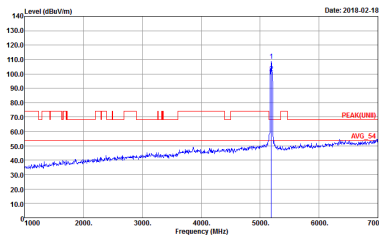
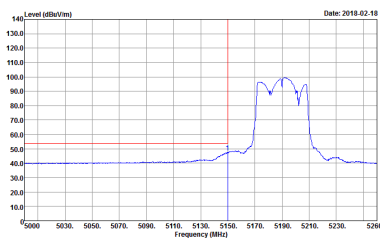

**Band 1 5150~5250MHz**  
**WIFI 802.11ac VHT40 (Band Edge @ 3m)**

| WIFI               | Band 1 5150~5250MHz Band Edge @ 3m  |   |
|--------------------|---|---|
| ANT                | 802.11ac VHT40 CH38 5190MHz - L   |   |
| 1+2                | Horizontal  | Fundamental   |
| <p><b>Peak</b></p> |  <p>Site : 03CH11-HY<br/>           Condition : PEAK_BE_74 3m HORN 9120D-HF HORIZONTAL<br/>           Detector : Peak<br/>           Project : 811726<br/>           Setting : 20</p>  |  <p>Site : 03CH11-HY<br/>           Condition : PEAK(UNIT) 3m HORN 9120D-HF HORIZONTAL<br/>           Detector : Peak<br/>           Project : 811726<br/>           Setting : 20</p> |
| <p><b>Avg.</b></p> |  <p>Site : 03CH11-HY<br/>           Condition : AVG_BE_54 3m HORN 9120D-HF HORIZONTAL<br/>           Detector : Peak<br/>           Project : 811726<br/>           Setting : 20</p> | <p><b>Left blank</b></p>  |

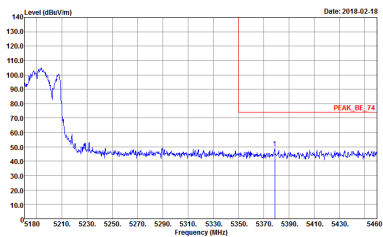
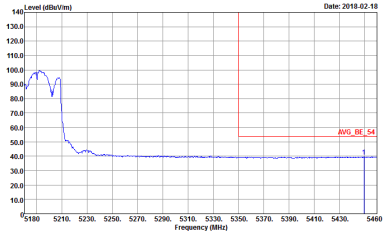

| WIFI               | Band 1 5150~5250MHz Band Edge @ 3m  |                   |
|--------------------|---|-------------------|
| ANT                | 802.11ac VHT40 CH38 5190MHz - R   |                   |
| 1+2                | Horizontal  | Fundamental       |
| <p><b>Peak</b></p> |  <p>Site : 03CH11-HY<br/>           Condition : PEAK_BE_74 3m HORN 91200-HF HORIZONTAL<br/>           Detector : Peak<br/>           Project : 811726<br/>           Setting : Z0</p>  | <p>Left blank</p> |
| <p><b>Avg.</b></p> |  <p>Site : 03CH11-HY<br/>           Condition : AVG_BE_54 3m HORN 91200-HF HORIZONTAL<br/>           Detector : Peak<br/>           Project : 811726<br/>           Setting : Z0</p> | <p>Left blank</p> |



| WIFI | Band 1 5150~5250MHz Band Edge @ 3m   |  |
|------|--|--|
| ANT  | 802.11ac VHT40 CH38 5190MHz - L  |  |
| 1+2  | Vertical   | Fundamental  |
| Peak | <p>Site : 03CH11-HY<br/>           Condition : PEAK_BE_74 3m HORN 9120D-HF VERTICAL<br/>           : RBW:1000.000KHz VBW:3000.000KHz SWT:Auto<br/>           Detector : Peak<br/>           Project : 811726<br/>           Setting : Z0</p> | <p>Site : 03CH11-HY<br/>           Condition : PEAK(UNII) 3m HORN 9120D-HF VERTICAL<br/>           : RBW:1000.000KHz VBW:3000.000KHz SWT:Auto<br/>           Detector : Peak<br/>           Project : 811726<br/>           Setting : Z0</p> |
| Avg. | <p>Site : 03CH11-HY<br/>           Condition : AVG_BE_54 3m HORN 9120D-HF VERTICAL<br/>           : RBW:1000.000KHz VBW:1000KHz SWT:Auto<br/>           Detector : Peak<br/>           Project : 811726<br/>           Setting : Z0</p>      | Left blank   |

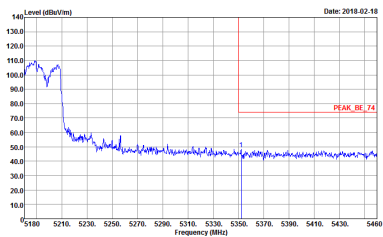
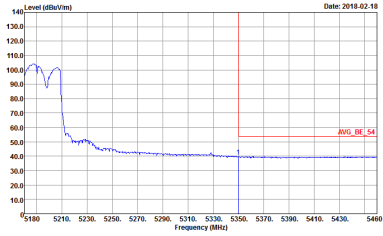

| WIFI               | Band 1 5150~5250MHz Band Edge @ 3m  |                   |
|--------------------|---|-------------------|
| ANT                | 802.11ac VHT40 CH38 5190MHz - R   |                   |
| 1+2                | Vertical  | Fundamental       |
| <p><b>Peak</b></p> |  <p>Site : 03CH11-HY<br/>           Condition : PEAK_BE_74 3m HORN 91200-HF VERTICAL<br/>           Detector : Peak<br/>           Project : 811726<br/>           Setting : Z0</p>  | <p>Left blank</p> |
| <p><b>Avg.</b></p> |  <p>Site : 03CH11-HY<br/>           Condition : AVG_BE_54 3m HORN 91200-HF VERTICAL<br/>           Detector : Peak<br/>           Project : 811726<br/>           Setting : Z0</p> | <p>Left blank</p> |

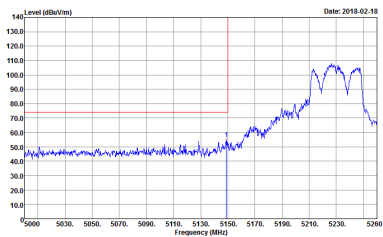
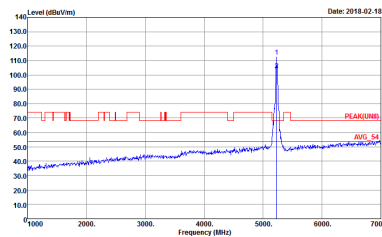
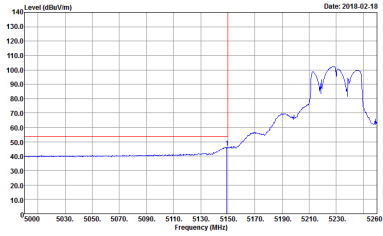

| WIFI               | Band 1 5150~5250MHz Band Edge @ 3m  |   |
|--------------------|---|---|
| ANT                | 802.11ac VHT40 CH46 5230MHz - L   |   |
| 1+2                | Horizontal  | Fundamental   |
| <p><b>Peak</b></p> |  <p>Site : 03CH11-HY<br/>           Condition : PEAK_BE_74 3m HORN 91200-HF HORIZONTAL<br/>           Detector : Peak<br/>           Project : 811726<br/>           Setting : 23.5</p>  |  <p>Site : 03CH11-HY<br/>           Condition : PEAK(UNII) 3m HORN 91200-HF HORIZONTAL<br/>           Detector : Peak<br/>           Project : 811726<br/>           Setting : 23.5</p> |
| <p><b>Avg.</b></p> |  <p>Site : 03CH11-HY<br/>           Condition : AVG_BE_54 3m HORN 91200-HF HORIZONTAL<br/>           Detector : Peak<br/>           Project : 811726<br/>           Setting : 23.5</p> | <p><b>Left blank</b></p>  |

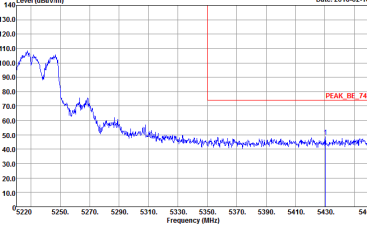
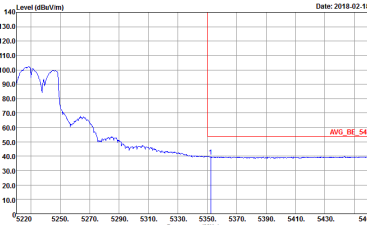

| WIFI               | Band 1 5150~5250MHz Band Edge @ 3m  |                   |
|--------------------|---|-------------------|
| ANT                | 802.11ac VHT40 CH46 5230MHz - R   |                   |
| 1+2                | Horizontal  | Fundamental       |
| <p><b>Peak</b></p> |  <p>Site : 03CH11-HY<br/>           Condition : PEAK_BE_74 3m HORN 91200-HF HORIZONTAL<br/>           Detector : Peak<br/>           Project : 811726<br/>           Setting : 23.5</p>  | <p>Left blank</p> |
| <p><b>Avg.</b></p> |  <p>Site : 03CH11-HY<br/>           Condition : AVG_BE_54 3m HORN 91200-HF HORIZONTAL<br/>           Detector : Peak<br/>           Project : 811726<br/>           Setting : 23.5</p> | <p>Left blank</p> |





| WIFI               | Band 1 5150~5250MHz Band Edge @ 3m |                          |
|--------------------|------------------------------------|--------------------------|
| ANT                | 802.11ac VHT40 CH46 5230MHz - L    |                          |
| 1+2                | Vertical                           | Fundamental              |
| <p><b>Peak</b></p> |                                    |                          |
| <p><b>Avg.</b></p> |                                    | <p><b>Left blank</b></p> |



| WIFI | Band 1 5150~5250MHz Band Edge @ 3m   |             |
|------|--|-------------|
| ANT  | 802.11ac VHT40 CH46 5230MHz - R  |             |
| 1+2  | Vertical   | Fundamental |
| Peak | <p>Site : 03CH11-HY<br/>Condition : PEAK_BE_74 3m HORN 91200-HF VERTICAL<br/>Detector : Peak<br/>Project : 811726<br/>Setting : 23.5</p> | Left blank  |
| Avg. | <p>Site : 03CH11-HY<br/>Condition : AVG_BE_54 3m HORN 91200-HF VERTICAL<br/>Detector : Peak<br/>Project : 811726<br/>Setting : 23.5</p>  | Left blank  |

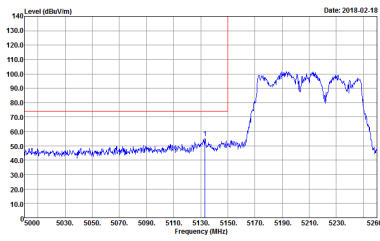
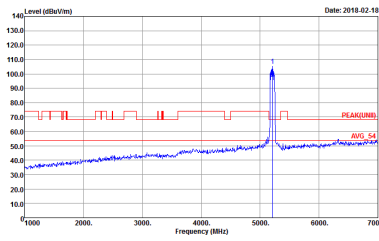
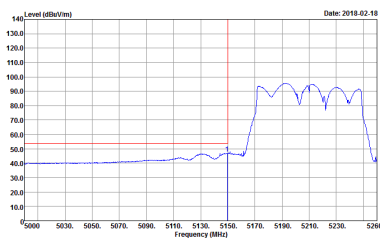

**Band 1 5150~5250MHz**  
**WIFI 802.11ac VHT80 (Band Edge @ 3m)**

| WIFI                              | Band 1 5150~5250MHz Band Edge @ 3m  |   |
|-----------------------------------|---|---|
| ANT                               | 802.11ac VHT80 CH42 5210MHz - L   |   |
| 1+2                               | Horizontal  | Fundamental   |
| <p align="center"><b>Peak</b></p> |  <p>Site : 03CH11-HY<br/>           Condition : PEAK_BE_74 3m HORN 91200-HF HORIZONTAL<br/>           Detector : Peak<br/>           Project : 811726<br/>           Setting : 20</p>  |  <p>Site : 03CH11-HY<br/>           Condition : PEAK(UNIT) 3m HORN 91200-HF HORIZONTAL<br/>           Detector : Peak<br/>           Project : 811726<br/>           Setting : 20</p> |
| <p align="center"><b>Avg.</b></p> |  <p>Site : 03CH11-HY<br/>           Condition : AVG_BE_54 3m HORN 91200-HF HORIZONTAL<br/>           Detector : Peak<br/>           Project : 811726<br/>           Setting : 20</p> | <p align="center"><b>Left blank</b></p>   |

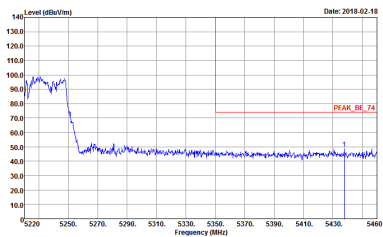
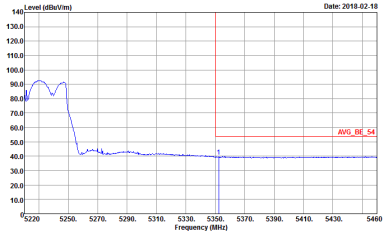

| WIFI               | Band 1 5150~5250MHz Band Edge @ 3m   |                   |
|--------------------|--|-------------------|
| ANT                | 802.11ac VHT80 CH42 5210MHz - R  |                   |
| 1+2                | Horizontal   | Fundamental       |
| <p><b>Peak</b></p> |  <p>Site : 03CH11-HY<br/>           Condition : PEAK_BE_74 3m HORN 91200-HF HORIZONTAL<br/>           : RBW:1000.000KHz VBW:3000.000KHz SWT:Auto<br/>           Detector : Peak<br/>           Project : 811726<br/>           Setting : Z0</p> | <p>Left blank</p> |
| <p><b>Avg.</b></p> |  <p>Site : 03CH11-HY<br/>           Condition : AVG_BE_54 3m HORN 91200-HF HORIZONTAL<br/>           : RBW:1000.000KHz VBW:1000KHz SWT:Auto<br/>           Detector : Peak<br/>           Project : 811726<br/>           Setting : Z0</p>    | <p>Left blank</p> |



| WIFI               | Band 1 5150~5250MHz Band Edge @ 3m   |  |
|--------------------|--|--|
| ANT                | 802.11ac VHT80 CH42 5210MHz - L  |  |
| 1+2                | Vertical   | Fundamental  |
| <p><b>Peak</b></p> | <p>Site : 03CH11-HY<br/>           Condition : PEAK_BE_74 3m HORN 9120D-HF VERTICAL<br/>           Detector : Peak<br/>           Project : 811726<br/>           Setting : Z0</p> | <p>Site : 03CH11-HY<br/>           Condition : PEAK(LIMB) 3m HORN 9120D-HF VERTICAL<br/>           Detector : Peak<br/>           Project : 811726<br/>           Setting : Z0</p> |
| <p><b>Avg.</b></p> | <p>Site : 03CH11-HY<br/>           Condition : AVG_BE_54 3m HORN 9120D-HF VERTICAL<br/>           Detector : Peak<br/>           Project : 811726<br/>           Setting : Z0</p>  | <p><b>Left blank</b></p>   |



| WIFI | Band 1 5150~5250MHz Band Edge @ 3m   |             |
|------|--|-------------|
| ANT  | 802.11ac VHT80 CH42 5210MHz - R  |             |
| 1+2  | Vertical   | Fundamental |
| Peak | <p>Site : 03CH11-HY<br/>Condition : PEAK_BE_74 3m HORN 91200-HF VERTICAL<br/>Detector : Peak<br/>Project : 811726<br/>Setting : Z0</p> | Left blank  |
| Avg. | <p>Site : 03CH11-HY<br/>Condition : AVG_BE_54 3m HORN 91200-HF VERTICAL<br/>Detector : Peak<br/>Project : 811726<br/>Setting : Z0</p>  | Left blank  |



**Band 1 - 5150~5250MHz**  
**WIFI 802.11a (Harmonic @ 3m)**

|                            |   |   |
|----------------------------|---|---|
| <b>WIFI</b>                | <b>Band 1 5150~5250MHz Harmonic @ 3m</b>  |   |
| <b>ANT</b>                 | <b>802.11a CH36 5180MHz</b>   |   |
| <b>1+2</b>                 | <b>Horizontal</b>   | <b>Vertical</b>   |
| <b>Peak</b><br><b>Avg.</b> | <p>Site : 03CH11-HY<br/>         Condition : PEAK(UM) 3m HORN 9120D-HF HORIZONTAL<br/>         Project : 811726</p> | <p>Site : 03CH11-HY<br/>         Condition : PEAK(UM) 3m HORN 9120D-HF VERTICAL<br/>         Project : 811726</p> |

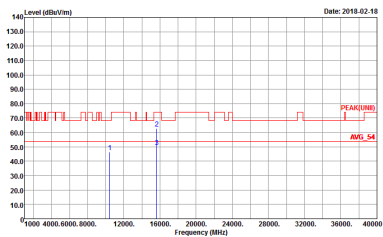
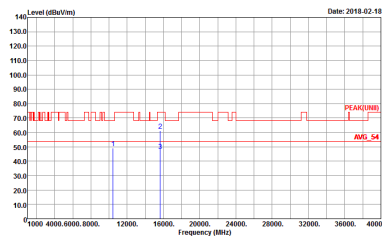

|                         |  |   |
|-------------------------|--|---|
| WIFI                    | Band 1 5150~5250MHz Harmonic @ 3m  |   |
| ANT                     | 802.11a CH44 5220MHz   |   |
| 1+2                     | Horizontal   | Vertical  |
| <p>Peak</p> <p>Avg.</p> |  <p>Site : 03CH11-11Y<br/>         Condition : PEAK[UNL1] 3m HORN 9120D-HF HORIZONTAL<br/>         Project : 811726<br/>         Setting : 25</p> |  <p>Site : 03CH11-11Y<br/>         Condition : PEAK[UNL1] 3m HORN 9120D-HF VERTICAL<br/>         Project : 811726<br/>         Setting : 25</p> |



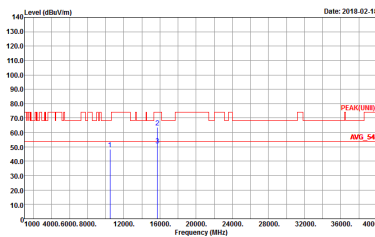
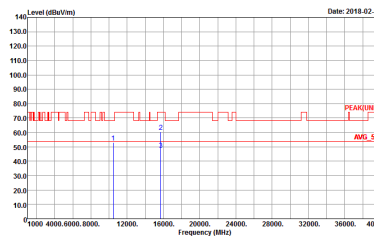

|                         |  |   |
|-------------------------|--|---|
| WIFI                    | Band 1 5150~5250MHz Harmonic @ 3m  |   |
| ANT                     | 802.11a CH48 5240MHz   |   |
| 1+2                     | Horizontal   | Vertical  |
| <p>Peak</p> <p>Avg.</p> |  <p>Site : 03CH11-11Y<br/>Condition : PEAK(UNII) 3m HORN 9120D-HF HORIZONTAL<br/>Project : 811726</p> |  <p>Site : 03CH11-11Y<br/>Condition : PEAK(UNII) 3m HORN 9120D-HF VERTICAL<br/>Project : 811726</p> |



**Band 1 5150~5250MHz  
WIFI 802.11ac VHT20 (Harmonic @ 3m)**

| WIFI                                  | Band 1 5150~5250MHz Harmonic @ 3m   |   |
|---------------------------------------|---|---|
| ANT                                   | 802.11ac VHT20 CH36 5180MHz   |   |
| 1+2                                   | Horizontal  | Vertical  |
| <p><b>Peak</b></p> <p><b>Avg.</b></p> | <p>Date: 2018-02-19</p> <p>Site : 03CH11-HY<br/>Condition : PEAK(UNIT) 3m HORN 9120D-HF HORIZONTAL<br/>Project : 811726</p> | <p>Date: 2018-02-19</p> <p>Site : 03CH11-HY<br/>Condition : PEAK(UNIT) 3m HORN 9120D-HF VERTICAL<br/>Project : 811726</p> |



|                            |   |   |
|----------------------------|---|---|
| <b>WIFI</b>                | <b>Band 1 5150~5250MHz Harmonic @ 3m</b>  |   |
| <b>ANT</b>                 | <b>802.11ac VHT20 CH44 5220MHz</b>  |   |
| <b>1+2</b>                 | <b>Horizontal</b>   | <b>Vertical</b>   |
| <b>Peak</b><br><b>Avg.</b> | <p>Site : 03CH11-11Y<br/>Condition : PEAK(UNII) 3m HORN 9120D-HF HORIZONTAL<br/>Project : 811726<br/>Setting : 25.5</p> | <p>Site : 03CH11-11Y<br/>Condition : PEAK(UNII) 3m HORN 9120D-HF VERTICAL<br/>Project : 811726<br/>Setting : 25.5</p> |



|                            |   |   |
|----------------------------|---|---|
| <b>WIFI</b>                | <b>Band 1 5150~5250MHz Harmonic @ 3m</b>  |   |
| <b>ANT</b>                 | <b>802.11ac VHT20 CH48 5240MHz</b>  |   |
| <b>1+2</b>                 | <b>Horizontal</b>   | <b>Vertical</b>   |
| <b>Peak</b><br><b>Avg.</b> | <p>Site : 03CH11-11Y<br/>Condition : PEAK[UNL1] 3m HORN 9120D-HF HORIZONTAL<br/>Project : 811726<br/>Setting : 25.5</p> | <p>Site : 03CH11-11Y<br/>Condition : PEAK[UNL1] 3m HORN 9120D-HF VERTICAL<br/>Project : 811726<br/>Setting : 25.5</p> |

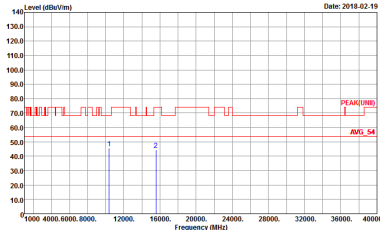
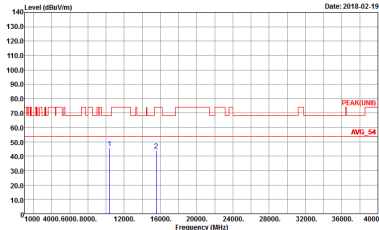

**Band 1 5150~5250MHz**  
**WIFI 802.11ac VHT40 (Harmonic @ 3m)**

| WIFI                                  | Band 1 5150~5250MHz Harmonic @ 3m   |  |
|---------------------------------------|---|--|
| ANT                                   | 802.11ac VHT40 CH38 5190MHz   |  |
| 1+2                                   | Horizontal  | Vertical   |
| <p><b>Peak</b></p> <p><b>Avg.</b></p> |  <p>Site : 03CH11-HY<br/>           Condition : PEAK(UNIT) 3m HORN 9120D-HF HORIZONTAL<br/>           Project : 811726</p> |  <p>Site : 03CH11-HY<br/>           Condition : PEAK(UNIT) 3m HORN 9120D-HF VERTICAL<br/>           Project : 811726</p> |

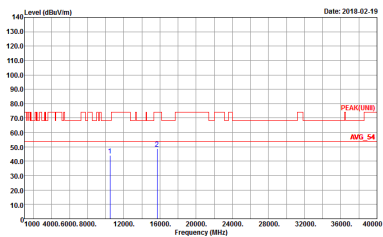
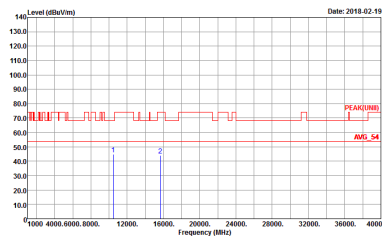

|                         |  |   |
|-------------------------|--|---|
| WIFI                    | Band 1 5150~5250MHz Harmonic @ 3m  |   |
| ANT                     | 802.11ac VHT40 CH46 5230MHz  |   |
| 1+2                     | Horizontal   | Vertical  |
| <p>Peak</p> <p>Avg.</p> |  <p>Site : 03CH11-11Y<br/>         Condition : PEAK(UNII) 3m HORN 9120D-HF HORIZONTAL<br/>         Project : 811726</p> |  <p>Site : 03CH11-11Y<br/>         Condition : PEAK(UNII) 3m HORN 9120D-HF VERTICAL<br/>         Project : 811726</p> |

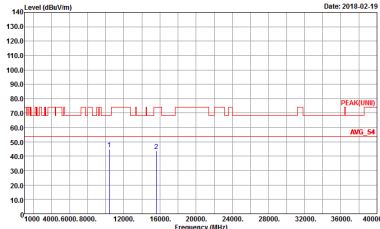
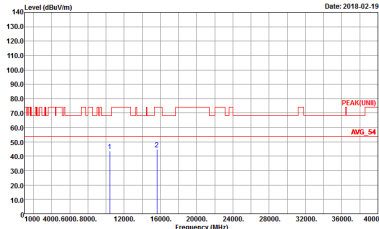

**Band 1 5150~5250MHz  
WIFI 802.11ac VHT80 (Harmonic @ 3m)**

| WIFI                                  | Band 1 5150~5250MHz Harmonic @ 3m   |  |
|---------------------------------------|---|--|
| ANT                                   | 802.11ac VHT80 CH42 5210MHz   |  |
| 1+2                                   | Horizontal  | Vertical   |
| <p><b>Peak</b></p> <p><b>Avg.</b></p> |  <p>Site : 03CH11-HY<br/>Condition : PEAK(UNIT) 3m HORN 9120D-HF HORIZONTAL<br/>Project : 811726</p> |  <p>Site : 03CH11-HY<br/>Condition : PEAK(UNIT) 3m HORN 9120D-HF VERTICAL<br/>Project : 811726</p> |



Emission below 1GHz  
5GHz WIFI 802.11a (LF)

| WIFI         | 5GHz WIFI   |   |
|--------------|---|---|
| ANT          | 802.11a LF  |   |
| 1+2          | Horizontal  | Vertical  |
| QP /<br>Peak | <p>Site : 03CH11-HY<br/>Condition : QP 3m BE-LOG-6111D-LF_ETC HORIZONTAL<br/>Detector : Peak<br/>Project : 811726</p> | <p>Site : 03CH11-HY<br/>Condition : QP 3m BE-LOG-6111D-LF_ETC VERTICAL<br/>Detector : Peak<br/>Project : 811726</p> |





<TXBF Mode>

**Band 1 - 5150~5250MHz**  
**WIFI 802.11ac VHT20 (Band Edge @ 3m)**

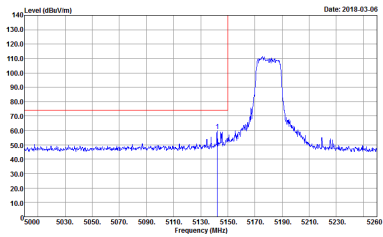
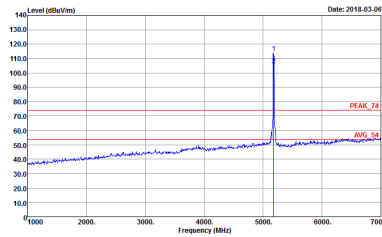
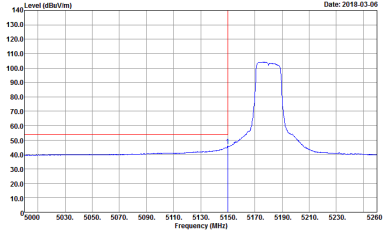
| WIFI        | Band 1 5150~5250MHz Band Edge @ 3m  |  |
|-------------|---|--|
| ANT         | 802.11ac VHT20 CH36 5180MHz   |  |
| 1+2         | Horizontal  | Fundamental  |
| <b>Peak</b> |  <p>Site : 03CH11-HY<br/>           Condition : PEAK_BE_74 3m HORN 91200-HF HORIZONTAL<br/>           Detector : Peak<br/>           Project : 811726<br/>           Setting : 25</p>  |  <p>Site : 03CH11-HY<br/>           Condition : PEAK_74 3m HORN 91200-HF HORIZONTAL<br/>           Detector : Peak<br/>           Project : 811726<br/>           Setting : 25</p> |
| <b>Avg.</b> |  <p>Site : 03CH11-HY<br/>           Condition : AV6_BE_54 3m HORN 91200-HF HORIZONTAL<br/>           Detector : Peak<br/>           Project : 811726<br/>           Setting : 25</p> | <b>Left blank</b>  |



| WIFI               | Band 1 5150~5250MHz Band Edge @ 3m   |   |
|--------------------|--|---|
| ANT                | 802.11ac VHT20 CH36 5180MHz  |   |
| 1+2                | Vertical   | Fundamental   |
| <p><b>Peak</b></p> | <p>Site : 03CH11-HY<br/>           Condition : PEAK_BE_74 3m HORN 91200-HF VERTICAL<br/>           Detector : Peak<br/>           Project : 811726<br/>           Setting : Z5</p> | <p>Site : 03CH11-HY<br/>           Condition : PEAK_74 3m HORN 91200-HF VERTICAL<br/>           Detector : Peak<br/>           Project : 811726<br/>           Setting : Z5</p> |
| <p><b>Avg.</b></p> | <p>Site : 03CH11-HY<br/>           Condition : AVG_BE_54 3m HORN 91200-HF VERTICAL<br/>           Detector : Peak<br/>           Project : 811726<br/>           Setting : Z5</p>  | <p><b>Left blank</b></p>  |

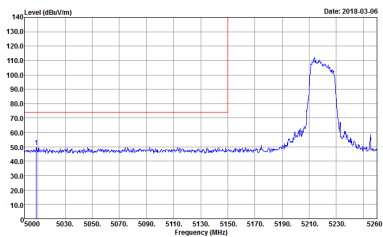
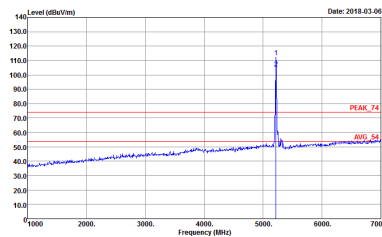
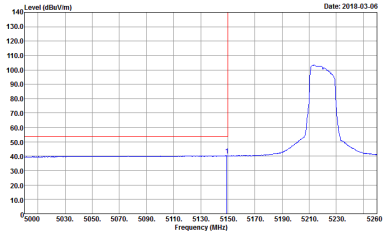

| WIFI               | Band 1 5150~5250MHz Band Edge @ 3m   |  |
|--------------------|--|--|
| ANT                | 802.11ac VHT20 CH44 5220MHz - L  |  |
| 1+2                | Horizontal   | Fundamental  |
| <p><b>Peak</b></p> |  <p>Site : 03CH11-HY<br/>           Condition : PEAK_BE_74 3m HORN 91200-HF HORIZONTAL<br/>           RBW:1000.000KHz VBW:3000.000KHz SWT:Auto<br/>           Detector : Peak<br/>           Project : 811726<br/>           Setting : Z5</p> |  <p>Site : 03CH11-HY<br/>           Condition : PEAK_74 3m HORN 91200-HF HORIZONTAL<br/>           RBW:1000.000KHz VBW:3000.000KHz SWT:Auto<br/>           Detector : Peak<br/>           Project : 811726<br/>           Setting : Z5</p> |
| <p><b>Avg.</b></p> |  <p>Site : 03CH11-HY<br/>           Condition : AVG_BE_54 3m HORN 91200-HF HORIZONTAL<br/>           RBW:1000.000KHz VBW:0.300KHz SWT:Auto<br/>           Detector : Peak<br/>           Project : 811726<br/>           Setting : Z5</p>   | <p><b>Left blank</b></p>   |

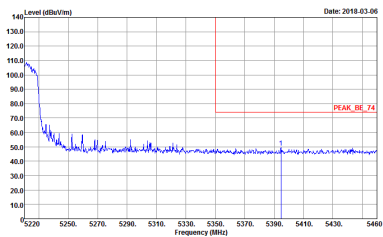
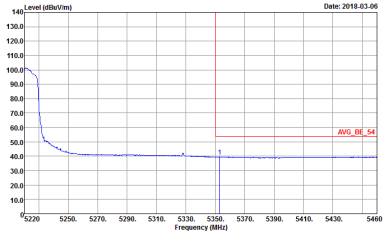

| WIFI               | Band 1 5150~5250MHz Band Edge @ 3m  |                   |
|--------------------|---|-------------------|
| ANT                | 802.11ac VHT20 CH44 5220MHz - R   |                   |
| 1+2                | Horizontal  | Fundamental       |
| <p><b>Peak</b></p> |  <p>Site : 03CH11-HY<br/>           Condition : PEAK_BE_74 3m HORN 91200-HF HORIZONTAL<br/>           Detector : Peak<br/>           Project : 811726<br/>           Setting : Z5</p>  | <p>Left blank</p> |
| <p><b>Avg.</b></p> |  <p>Site : 03CH11-HY<br/>           Condition : AVG_BE_54 3m HORN 91200-HF HORIZONTAL<br/>           Detector : Peak<br/>           Project : 811726<br/>           Setting : Z5</p> | <p>Left blank</p> |

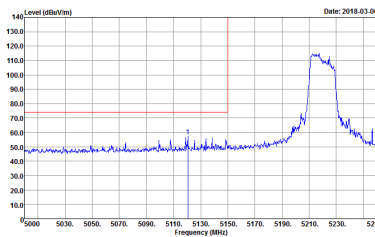
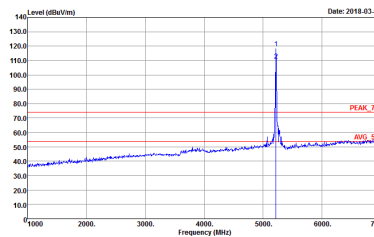
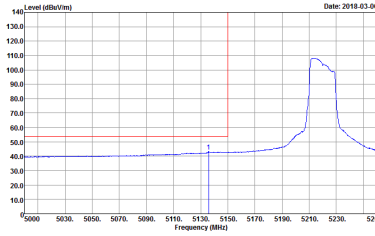

| WIFI               | Band 1 5150~5250MHz Band Edge @ 3m  |  |
|--------------------|---|--|
| ANT                | 802.11ac VHT20 CH44 5220MHz - L   |  |
| 1+2                | Vertical  | Fundamental  |
| <p><b>Peak</b></p> |  <p>Site : 03CH11-HY<br/>           Condition : PEAK_BE_74 3m HORN 91200-HF VERTICAL<br/>           Detector : Peak<br/>           Project : 811726<br/>           Setting : Z5</p>  |  <p>Site : 03CH11-HY<br/>           Condition : PEAK_74 3m HORN 91200-HF VERTICAL<br/>           Detector : Peak<br/>           Project : 811726<br/>           Setting : Z5</p> |
| <p><b>Avg.</b></p> |  <p>Site : 03CH11-HY<br/>           Condition : AVG_BE_54 3m HORN 91200-HF VERTICAL<br/>           Detector : Peak<br/>           Project : 811726<br/>           Setting : Z5</p> | <p><b>Left blank</b></p>   |

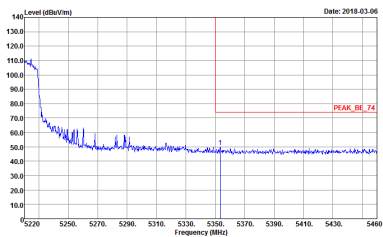
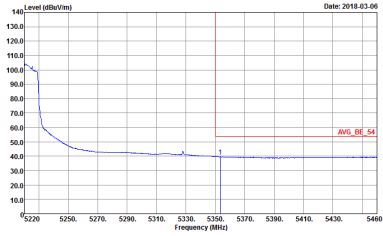

| WIFI | Band 1 5150~5250MHz Band Edge @ 3m   |             |
|------|--|-------------|
| ANT  | 802.11ac VHT20 CH44 5220MHz - R  |             |
| 1+2  | Vertical   | Fundamental |
| Peak |  <p>Date: 2018.03.06</p> <p>Site : 03CH11-HY<br/> Condition : PEAK_BE_74 3m HORN 91200-HF VERTICAL<br/> : RBW:1000.000KHz VBW:3000.000KHz SWT:Auto<br/> Detector : Peak<br/> Project : 811726<br/> Setting : Z5</p> | Left blank  |
| Avg. |  <p>Date: 2018.03.06</p> <p>Site : 03CH11-HY<br/> Condition : AVG_BE_54 3m HORN 91200-HF VERTICAL<br/> : RBW:1000.000KHz VBW:3.000KHz SWT:Auto<br/> Detector : Peak<br/> Project : 811726<br/> Setting : Z5</p>   | Left blank  |

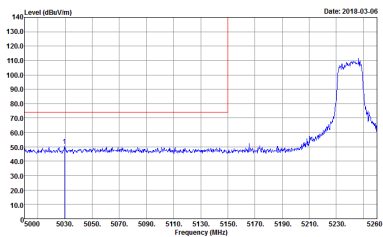
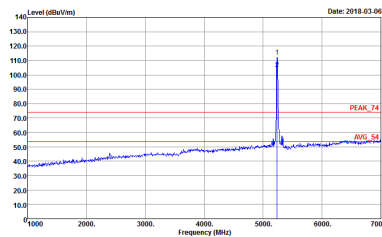
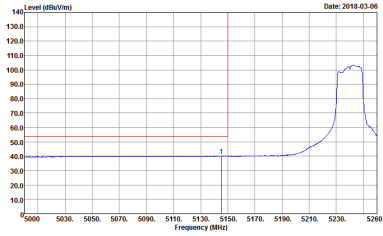

| WIFI               | Band 1 5150~5250MHz Band Edge @ 3m   |   |
|--------------------|--|---|
| ANT                | 802.11ac VHT20 CH48 5240MHz - L  |   |
| 1+2                | Horizontal   | Fundamental   |
| <p><b>Peak</b></p> |  <p>Level (dBm/100MHz) vs Frequency (MHz) plot showing a peak at 5240 MHz. The y-axis ranges from 10.0 to 140.0 dBm/100MHz, and the x-axis ranges from 5000 to 5260 MHz. A red vertical line marks the peak at 5240 MHz.</p> <p>Site : 03CH11-HY<br/>           Condition : PEAK_BE_74 3m HORN 91200-HF HORIZONTAL<br/>           : RBW:1000.000KHz VBW:3000.000KHz SWT:Auto<br/>           Detector : Peak<br/>           Project : 811726<br/>           Setting : Z5</p> |  <p>Level (dBm/100MHz) vs Frequency (MHz) plot showing a peak at 5240 MHz. The y-axis ranges from 10.0 to 140.0 dBm/100MHz, and the x-axis ranges from 4000 to 7000 MHz. A red vertical line marks the peak at 5240 MHz. Labels 'PEAK 74' and 'AVG 51' are present.</p> <p>Site : 03CH11-HY<br/>           Condition : PEAK_74 3m HORN 91200-HF HORIZONTAL<br/>           : RBW:1000.000KHz VBW:3000.000KHz SWT:Auto<br/>           Detector : Peak<br/>           Project : 811726<br/>           Setting : Z5</p> |
| <p><b>Avg.</b></p> |  <p>Level (dBm/100MHz) vs Frequency (MHz) plot showing a peak at 5240 MHz. The y-axis ranges from 10.0 to 140.0 dBm/100MHz, and the x-axis ranges from 5000 to 5260 MHz. A red vertical line marks the peak at 5240 MHz.</p> <p>Site : 03CH11-HY<br/>           Condition : AVG_BE_54 3m HORN 91200-HF HORIZONTAL<br/>           : RBW:1000.000KHz VBW:0.300KHz SWT:Auto<br/>           Detector : Peak<br/>           Project : 811726<br/>           Setting : Z5</p>   | <p><b>Left blank</b></p>  |

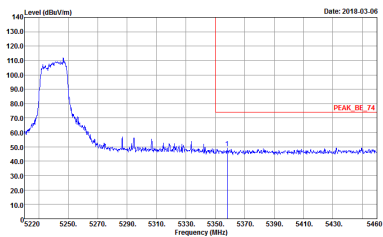
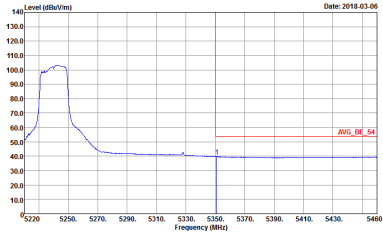

| WIFI               | Band 1 5150~5250MHz Band Edge @ 3m  |                   |
|--------------------|---|-------------------|
| ANT                | 802.11ac VHT20 CH48 5240MHz - R   |                   |
| 1+2                | Horizontal  | Fundamental       |
| <p><b>Peak</b></p> |  <p>Site : 03CH11-HY<br/>           Condition : PEAK_BE_74 3m HORN 91200-HF HORIZONTAL<br/>           Detector : Peak<br/>           Project : 811726<br/>           Setting : Z5</p>  | <p>Left blank</p> |
| <p><b>Avg.</b></p> |  <p>Site : 03CH11-HY<br/>           Condition : AVG_BE_54 3m HORN 91200-HF HORIZONTAL<br/>           Detector : Peak<br/>           Project : 811726<br/>           Setting : Z5</p> | <p>Left blank</p> |





| WIFI        | Band 1 5150~5250MHz Band Edge @ 3m   |   |
|-------------|--|---|
| ANT         | 802.11ac VHT20 CH48 5240MHz - L  |   |
| 1+2         | Vertical   | Fundamental   |
| <b>Peak</b> | <p>           Site : 03CH11-HY<br/>           Condition : PEAK_BE_74 3m HORN 91200-HF VERTICAL<br/>           Detector : Peak<br/>           Project : 811726<br/>           Setting : Z5         </p> | <p>           Site : 03CH11-HY<br/>           Condition : PEAK_74 3m HORN 91200-HF VERTICAL<br/>           Detector : Peak<br/>           Project : 811726<br/>           Setting : Z5         </p> |
| <b>Avg.</b> | <p>           Site : 03CH11-HY<br/>           Condition : AVG_BE_54 3m HORN 91200-HF VERTICAL<br/>           Detector : Peak<br/>           Project : 811726<br/>           Setting : Z5         </p>  | <b>Left blank</b>   |

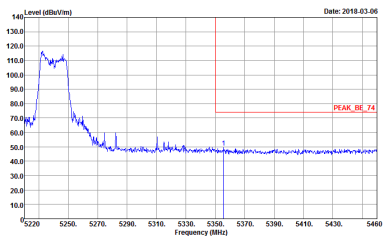
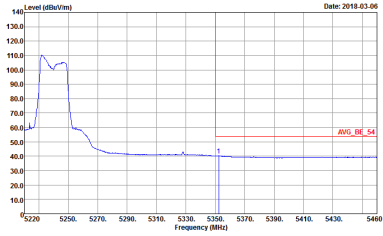

| WIFI               | Band 1 5150~5250MHz Band Edge @ 3m  |                   |
|--------------------|---|-------------------|
| ANT                | 802.11ac VHT20 CH48 5240MHz - R   |                   |
| 1+2                | Vertical  | Fundamental       |
| <p><b>Peak</b></p> |  <p>Site : 03CH11-HY<br/>           Condition : PEAK_BE_74 3m HORN 91200-HF VERTICAL<br/>           Detector : Peak<br/>           Project : 811726<br/>           Setting : Z5</p>  | <p>Left blank</p> |
| <p><b>Avg.</b></p> |  <p>Site : 03CH11-HY<br/>           Condition : AVG_BE_54 3m HORN 91200-HF VERTICAL<br/>           Detector : Peak<br/>           Project : 811726<br/>           Setting : Z5</p> | <p>Left blank</p> |



**Band 1 5150~5250MHz**  
**WIFI 802.11ac VHT40 (Band Edge @ 3m)**

| WIFI        | Band 1 5150~5250MHz Band Edge @ 3m   |   |
|-------------|--|---|
| ANT         | 802.11ac VHT40 CH38 5190MHz - L  |   |
| 1+2         | Horizontal   | Fundamental   |
| <b>Peak</b> | <p>Site : 03CHI1-HY<br/>           Condition : PEAK_BE_74 3m HORN 9120D-HF HORIZONTAL<br/>           RBW:1000.000KHz VBW:3000.000KHz SWT:Auto<br/>           Detector : Peak<br/>           Project : 811726<br/>           Setting : 23.5</p> | <p>Site : 03CHI1-HY<br/>           Condition : PEAK_74 3m HORN 9120D-HF HORIZONTAL<br/>           RBW:1000.000KHz VBW:3000.000KHz SWT:Auto<br/>           Detector : Peak<br/>           Project : 811726<br/>           Setting : 23.5</p> |
| <b>Avg.</b> | <p>Site : 03CHI1-HY<br/>           Condition : AVG_BE_54 3m HORN 9120D-HF HORIZONTAL<br/>           RBW:1000.000KHz VBW:1.000KHz SWT:Auto<br/>           Detector : Peak<br/>           Project : 811726<br/>           Setting : 23.5</p>     | <b>Left blank</b>   |

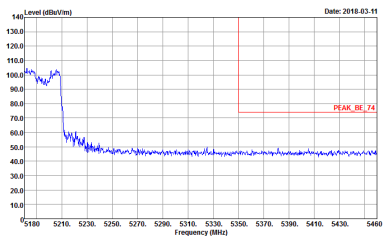
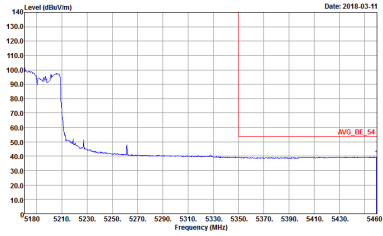

| WIFI               | Band 1 5150~5250MHz Band Edge @ 3m  |                   |
|--------------------|---|-------------------|
| ANT                | 802.11ac VHT40 CH38 5190MHz - R   |                   |
| 1+2                | Horizontal  | Fundamental       |
| <p><b>Peak</b></p> |  <p>Site : 03CH11-HY<br/>           Condition : PEAK_BE_74 3m HORN 91200-HF HORIZONTAL<br/>           Detector : Peak<br/>           Project : 811726<br/>           Setting : 23.5</p>  | <p>Left blank</p> |
| <p><b>Avg.</b></p> |  <p>Site : 03CH11-HY<br/>           Condition : AVG_BE_54 3m HORN 91200-HF HORIZONTAL<br/>           Detector : Peak<br/>           Project : 811726<br/>           Setting : 23.5</p> | <p>Left blank</p> |

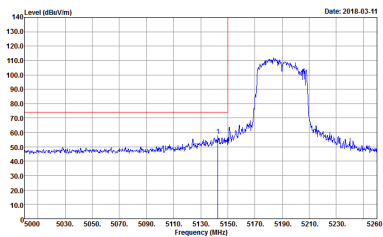
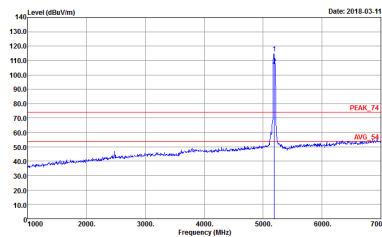
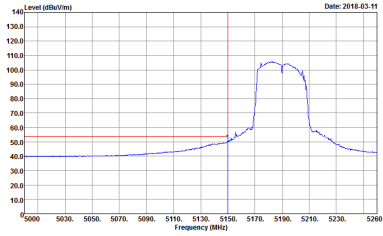

| WIFI               | Band 1 5150~5250MHz Band Edge @ 3m  |  |
|--------------------|---|--|
| ANT                | 802.11ac VHT40 CH38 5190MHz - L   |  |
| 1+2                | Vertical  | Fundamental  |
| <p><b>Peak</b></p> |  <p>Site : 03CH11-HY<br/>           Condition : PEAK_BE_74 3m HORN 91200-HF VERTICAL<br/>           Detector : Peak<br/>           Project : 811726<br/>           Setting : 23.5</p>  |  <p>Site : 03CH11-HY<br/>           Condition : PEAK_74 3m HORN 91200-HF VERTICAL<br/>           Detector : Peak<br/>           Project : 811726<br/>           Setting : 23.5</p> |
| <p><b>Avg.</b></p> |  <p>Site : 03CH11-HY<br/>           Condition : AVG_BE_54 3m HORN 91200-HF VERTICAL<br/>           Detector : Peak<br/>           Project : 811726<br/>           Setting : 23.5</p> | <p><b>Left blank</b></p>   |

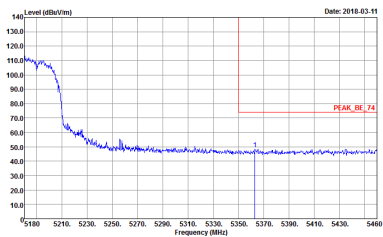
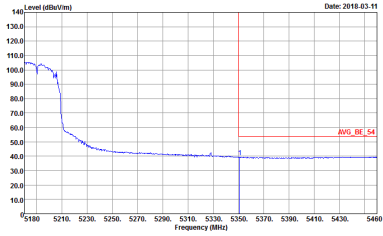

| WIFI               | Band 1 5150~5250MHz Band Edge @ 3m  |                   |
|--------------------|---|-------------------|
| ANT                | 802.11ac VHT40 CH38 5190MHz - R   |                   |
| 1+2                | Vertical  | Fundamental       |
| <p><b>Peak</b></p> |  <p>Site : 03CH11-HY<br/>           Condition : PEAK_BE_74 3m HORN 91200-HF VERTICAL<br/>           Detector : Peak<br/>           Project : 811726<br/>           Setting : 23.5</p>  | <p>Left blank</p> |
| <p><b>Avg.</b></p> |  <p>Site : 03CH11-HY<br/>           Condition : AVG_BE_54 3m HORN 91200-HF VERTICAL<br/>           Detector : Peak<br/>           Project : 811726<br/>           Setting : 23.5</p> | <p>Left blank</p> |

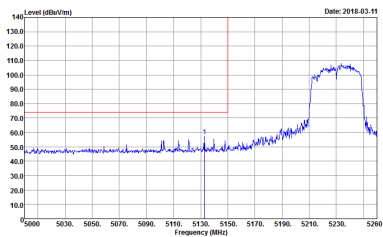
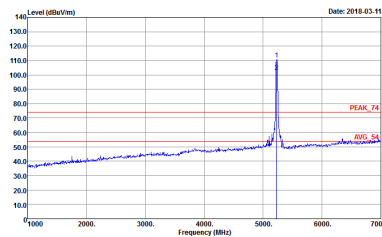
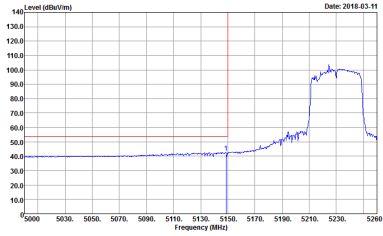

| WIFI               | Band 1 5150~5250MHz Band Edge @ 3m  |  |
|--------------------|---|--|
| ANT                | 802.11ac VHT40 CH46 5230MHz - L   |  |
| 1+2                | Horizontal  | Fundamental  |
| <p><b>Peak</b></p> |  <p>Site : 03CH11-HY<br/>           Condition : PEAK_BE_74 3m HORN 9120D-HF HORIZONTAL<br/>           Detector : Peak<br/>           Project : 811726<br/>           Setting : Z4</p>  |  <p>Site : 03CH11-HY<br/>           Condition : PEAK_74 3m HORN 9120D-HF HORIZONTAL<br/>           Detector : Peak<br/>           Project : 811726<br/>           Setting : Z4</p> |
| <p><b>Avg.</b></p> |  <p>Site : 03CH11-HY<br/>           Condition : AVG_BE_54 3m HORN 9120D-HF HORIZONTAL<br/>           Detector : Peak<br/>           Project : 811726<br/>           Setting : Z4</p> | <p><b>Left blank</b></p>   |

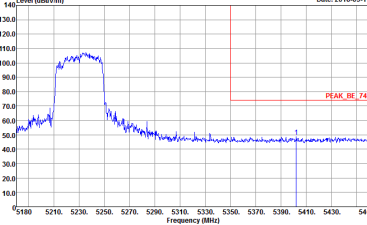
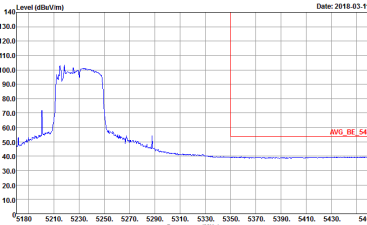

| WIFI               | Band 1 5150~5250MHz Band Edge @ 3m   |                   |
|--------------------|--|-------------------|
| ANT                | 802.11ac VHT40 CH46 5230MHz - R  |                   |
| 1+2                | Horizontal   | Fundamental       |
| <p><b>Peak</b></p> |  <p>Site : 03CH11-HY<br/>           Condition : PEAK_BE_74 3m HORN 91200-HF HORIZONTAL<br/>           : RBW:1000.000KHz VBW:3000.000KHz SWT:Auto<br/>           Detector : Peak<br/>           Project : 811726<br/>           Setting : 24</p> | <p>Left blank</p> |
| <p><b>Avg.</b></p> |  <p>Site : 03CH11-HY<br/>           Condition : AVG_BE_54 3m HORN 91200-HF HORIZONTAL<br/>           : RBW:1000.000KHz VBW:1000KHz SWT:Auto<br/>           Detector : Peak<br/>           Project : 811726<br/>           Setting : 24</p>    | <p>Left blank</p> |





| WIFI               | Band 1 5150~5250MHz Band Edge @ 3m   |   |
|--------------------|--|---|
| ANT                | 802.11ac VHT40 CH46 5230MHz - L  |   |
| 1+2                | Vertical   | Fundamental   |
| <p><b>Peak</b></p> | <p>Site : 03CH11-HY<br/>           Condition : PEAK_BE_74 3m HORN 9120D-HF VERTICAL<br/>           Detector : Peak<br/>           Project : 811726<br/>           Setting : 24</p> | <p>Site : 03CH11-HY<br/>           Condition : PEAK_74 3m HORN 9120D-HF VERTICAL<br/>           Detector : Peak<br/>           Project : 811726<br/>           Setting : 24</p> |
| <p><b>Avg.</b></p> | <p>Site : 03CH11-HY<br/>           Condition : AVG_BE_54 3m HORN 9120D-HF VERTICAL<br/>           Detector : Peak<br/>           Project : 811726<br/>           Setting : 24</p>  | <p><b>Left blank</b></p>  |



| WIFI | Band 1 5150~5250MHz Band Edge @ 3m   |             |
|------|--|-------------|
| ANT  | 802.11ac VHT40 CH46 5230MHz - R  |             |
| 1+2  | Vertical   | Fundamental |
| Peak | <p>Site : 03CH11-HY<br/>Condition : PEAK_BE_74 3m HORN 91200-HF VERTICAL<br/>Detector : Peak<br/>Project : 811726<br/>Setting : 24</p> | Left blank  |
| Avg. | <p>Site : 03CH11-HY<br/>Condition : AVG_BE_54 3m HORN 91200-HF VERTICAL<br/>Detector : Peak<br/>Project : 811726<br/>Setting : 24</p>  | Left blank  |



**Band 1 5150~5250MHz**  
**WIFI 802.11ac VHT80 (Band Edge @ 3m)**

| WIFI        | Band 1 5150~5250MHz Band Edge @ 3m   |   |
|-------------|--|---|
| ANT         | 802.11ac VHT80 CH42 5210MHz - L  |   |
| 1+2         | Horizontal   | Fundamental   |
| <b>Peak</b> | <p>Site : 03CH11-HY<br/>           Condition : PEAK_BE_74 3m HORN 9120D-HF HORIZONTAL<br/>           RBW:1000.000KHz VBW:3000.000KHz SWT:Auto<br/>           Detector : Peak<br/>           Project : 811726<br/>           Setting : Z2.5</p> | <p>Site : 03CH11-HY<br/>           Condition : PEAK_74 3m HORN 9120D-HF HORIZONTAL<br/>           RBW:1000.000KHz VBW:3000.000KHz SWT:Auto<br/>           Detector : Peak<br/>           Project : 811726<br/>           Setting : Z2.5</p> |
| <b>Avg.</b> | <p>Site : 03CH11-HY<br/>           Condition : AVG_BE_54 3m HORN 9120D-HF HORIZONTAL<br/>           RBW:1000.000KHz VBW:1.000KHz SWT:Auto<br/>           Detector : Peak<br/>           Project : 811726<br/>           Setting : Z2.5</p>     | Left blank  |

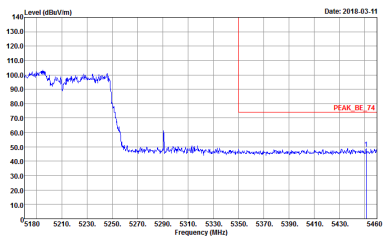
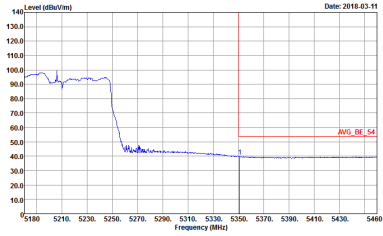

| WIFI               | Band 1 5150~5250MHz Band Edge @ 3m  |                   |
|--------------------|---|-------------------|
| ANT                | 802.11ac VHT80 CH42 5210MHz - R   |                   |
| 1+2                | Horizontal  | Fundamental       |
| <p><b>Peak</b></p> |  <p>Site : 03CH11-HY<br/>           Condition : PEAK_BE_74 3m HORN 91200-HF HORIZONTAL<br/>           Detector : Peak<br/>           Project : 811726<br/>           Setting : Z2.5</p>  | <p>Left blank</p> |
| <p><b>Avg.</b></p> |  <p>Site : 03CH11-HY<br/>           Condition : AVG_BE_54 3m HORN 91200-HF HORIZONTAL<br/>           Detector : Peak<br/>           Project : 811726<br/>           Setting : Z2.5</p> | <p>Left blank</p> |

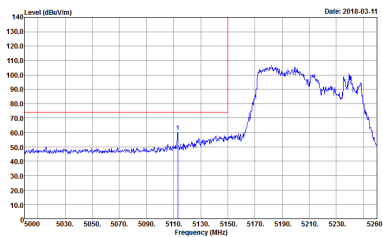
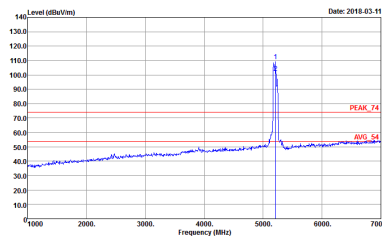
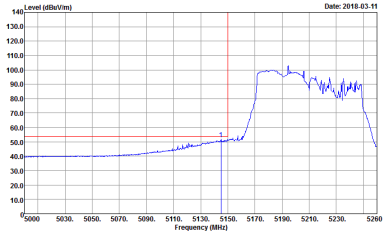

| WIFI               | Band 1 5150~5250MHz Band Edge @ 3m   |  |
|--------------------|--|--|
| ANT                | 802.11ac VHT80 CH42 5210MHz - L  |  |
| 1+2                | Vertical   | Fundamental  |
| <p><b>Peak</b></p> |  <p>Site : 03CH11-HY<br/>           Condition : PEAK_BE_74 3m HORN 9120D-HF VERTICAL<br/>           : RBW:1000.000KHz VBW:3000.000KHz SWT:Auto<br/>           Detector : Peak<br/>           Project : 811726<br/>           Setting : Z2.5</p> |  <p>Site : 03CH11-HY<br/>           Condition : PEAK_74 3m HORN 9120D-HF VERTICAL<br/>           : RBW:1000.000KHz VBW:3000.000KHz SWT:Auto<br/>           Detector : Peak<br/>           Project : 811726<br/>           Setting : Z2.5</p> |
| <p><b>Avg.</b></p> |  <p>Site : 03CH11-HY<br/>           Condition : AVG_BE_54 3m HORN 9120D-HF VERTICAL<br/>           : RBW:1000.000KHz VBW:1000KHz SWT:Auto<br/>           Detector : Peak<br/>           Project : 811726<br/>           Setting : Z2.5</p>    | <p><b>Left blank</b></p>   |

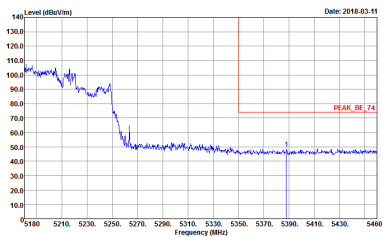
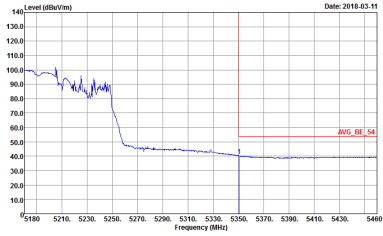

| WIFI               | Band 1 5150~5250MHz Band Edge @ 3m   |                   |
|--------------------|--|-------------------|
| ANT                | 802.11ac VHT80 CH42 5210MHz - R  |                   |
| 1+2                | Vertical   | Fundamental       |
| <p><b>Peak</b></p> |  <p>Site : 03CH11-HY<br/>           Condition : PEAK_BE_74 3m HORN 91200-HF VERTICAL<br/>           : RBW:1000.000KHz VBW:3000.000KHz SWT:Auto<br/>           Detector : Peak<br/>           Project : 811726<br/>           Setting : Z2.5</p> | <p>Left blank</p> |
| <p><b>Avg.</b></p> |  <p>Site : 03CH11-HY<br/>           Condition : AVG_BE_54 3m HORN 91200-HF VERTICAL<br/>           : RBW:1000.000KHz VBW:1000KHz SWT:Auto<br/>           Detector : Peak<br/>           Project : 811726<br/>           Setting : Z2.5</p>    | <p>Left blank</p> |



**Band 1 - 5150~5250MHz**  
**WIFI 802.11ac VHT20 (Harmonic @ 3m)**

|                            |   |   |
|----------------------------|---|---|
| <b>WIFI</b>                | <b>Band 1 5150~5250MHz Harmonic @ 3m</b>  |   |
| <b>ANT</b>                 | <b>802.11ac VHT20 CH36 5180MHz</b>  |   |
| <b>1+2</b>                 | <b>Horizontal</b>   | <b>Vertical</b>   |
| <b>Peak</b><br><b>Avg.</b> | <p>Site : 03SCH11-HY<br/>         Condition : PEAK_74 3m HORN 9120D-HF HORIZONTAL<br/>         Project : 811726</p> | <p>Site : 03SCH11-HY<br/>         Condition : PEAK_74 3m HORN 9120D-HF VERTICAL<br/>         Project : 811726</p> |

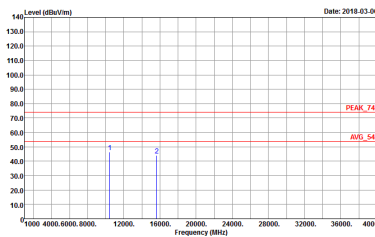
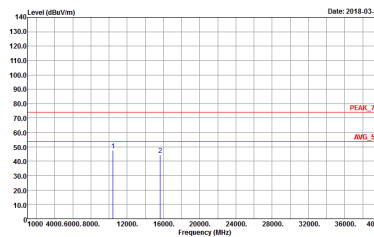

|                         |  |   |
|-------------------------|--|---|
| WIFI                    | Band 1 5150~5250MHz Harmonic @ 3m  |   |
| ANT                     | 802.11ac VHT20 CH44 5220MHz  |   |
| 1+2                     | Horizontal   | Vertical  |
| <p>Peak</p> <p>Avg.</p> |  <p>Site : 03CH11-11Y<br/>         Condition : PEAK_74 3m HORN 91200-HF HORIZONTAL<br/>         Detector : Peak<br/>         Project : 811726<br/>         Setting : 25</p> |  <p>Site : 03CH11-11Y<br/>         Condition : PEAK_74 3m HORN 91200-HF VERTICAL<br/>         Detector : Peak<br/>         Project : 811726<br/>         Setting : 25</p> |





|              |  |  |
|--------------|--|--|
| WIFI         | Band 1 5150~5250MHz Harmonic @ 3m  |  |
| ANT          | 802.11ac VHT20 CH48 5240MHz  |  |
| 1+2          | Horizontal   | Vertical   |
| Peak<br>Avg. | <p>Site : 03CH11-14Y<br/>Condition : PEAK_74 3m HORN 91200-HF HORIZONTAL<br/>Detector : Peak<br/>Project : 811726<br/>Setting : 25</p> | <p>Site : 03CH11-14Y<br/>Condition : PEAK_74 3m HORN 91200-HF VERTICAL<br/>Detector : Peak<br/>Project : 811726<br/>Setting : 25</p> |

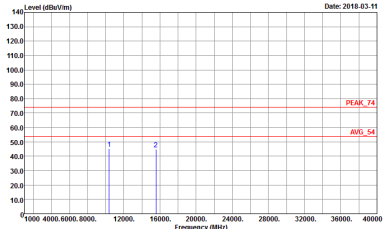
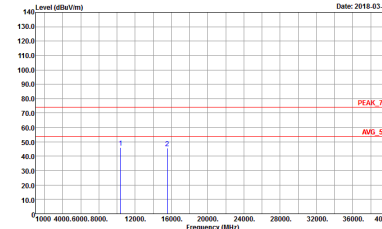

**Band 1 5150~5250MHz  
WIFI 802.11ac VHT40 (Harmonic @ 3m)**

|             |   |  |
|-------------|---|--|
| <b>WIFI</b> | <b>Band 1 5150~5250MHz Harmonic @ 3m</b>  |  |
| <b>ANT</b>  | <b>802.11ac VHT40 CH38 5190MHz</b>  |  |
| <b>1+2</b>  | <b>Horizontal</b>   | <b>Vertical</b>  |
| <b>Peak</b> |  <p>Site : 03CH11-HY<br/>Condition : PEAK_74 3m HORN 9120D-HF HORIZONTAL<br/>Detector : Peak<br/>Project : 811726<br/>Setting : 23.5</p> |  <p>Site : 03CH11-HY<br/>Condition : PEAK_74 3m HORN 9120D-HF VERTICAL<br/>Detector : Peak<br/>Project : 811726<br/>Setting : 23.5</p> |
| <b>Avg.</b> |   |  |

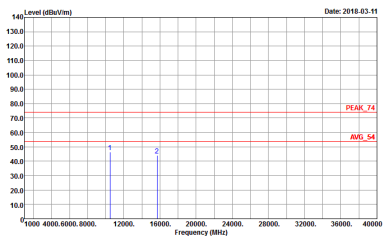
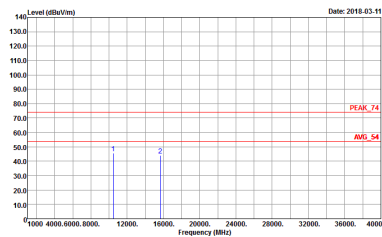

|                         |  |   |
|-------------------------|--|---|
| WIFI                    | Band 1 5150~5250MHz Harmonic @ 3m  |   |
| ANT                     | 802.11ac VHT40 CH46 5230MHz  |   |
| 1+2                     | Horizontal   | Vertical  |
| <p>Peak</p> <p>Avg.</p> |  <p>Site : 03CH11-11Y<br/>         Condition : PEAK_74 3m HORN 91200-HF HORIZONTAL<br/>         Detector : Peak<br/>         Project : 811726<br/>         Setting : 24</p> |  <p>Site : 03CH11-11Y<br/>         Condition : PEAK_74 3m HORN 91200-HF VERTICAL<br/>         Detector : Peak<br/>         Project : 811726<br/>         Setting : 24</p> |

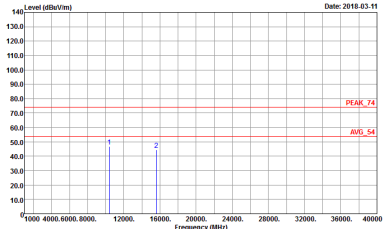
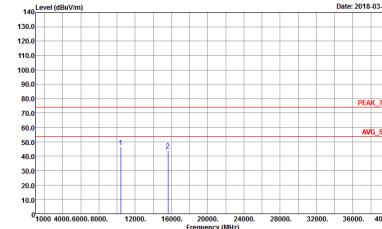

**Band 1 5150~5250MHz  
WIFI 802.11ac VHT80 (Harmonic @ 3m)**

|             |   |  |
|-------------|---|--|
| <b>WIFI</b> | <b>Band 1 5150~5250MHz Harmonic @ 3m</b>  |  |
| <b>ANT</b>  | <b>802.11ac VHT80 CH42 5210MHz</b>  |  |
| <b>1+2</b>  | <b>Horizontal</b>   | <b>Vertical</b>  |
| <b>Peak</b> |  <p>Site : 03CH11-HY<br/>Condition : PEAK_74 3m HORN 9120D-HF HORIZONTAL<br/>Detector : Peak<br/>Project : 811726<br/>Setting : 22.5</p> |  <p>Site : 03CH11-HY<br/>Condition : PEAK_74 3m HORN 9120D-HF VERTICAL<br/>Detector : Peak<br/>Project : 811726<br/>Setting : 22.5</p> |
| <b>Avg.</b> |   |  |



### Appendix E. Duty Cycle Plots

| Antenna | Band                              | Duty Cycle (%) | T(us)   | 1/T(kHz) | VBW Setting | Duty Factor (dB) |
|---------|-----------------------------------|----------------|---------|----------|-------------|------------------|
| 1       | 802.11a_LB                        | 96.23          | 2040.00 | 0.49     | 1kHz        | 0.17             |
| 1+2     | 802.11a_LB for Ant. 1             | 96.19          | 2020.00 | 0.50     | 1kHz        | 0.17             |
| 1+2     | 802.11a_LB for Ant. 2             | 96.19          | 2020.00 | 0.50     | 1kHz        | 0.17             |
| 1       | 5GHz 802.11n HT20_LB              | 97.62          | 4920.00 | 0.20     | 300Hz       | 0.10             |
| 1+2     | 5GHz 802.11n HT20_LB for Ant. 1   | 98.22          | -       | -        | 10Hz        | 0.08             |
| 1+2     | 5GHz 802.11n HT20_LB for Ant. 2   | 98.22          | -       | -        | 10Hz        | 0.08             |
| 1       | 5GHz 802.11n HT40_LB              | 96.39          | 2400.00 | 0.42     | 1kHz        | 0.16             |
| 1+2     | 5GHz 802.11n HT40_LB for Ant. 1   | 96.39          | 2400.00 | 0.42     | 1kHz        | 0.16             |
| 1+2     | 5GHz 802.11n HT40_LB for Ant. 2   | 95.24          | 2400.00 | 0.42     | 1kHz        | 0.21             |
| 1       | 5GHz 802.11ac VHT20_LB            | 88.39          | 4950.00 | 0.20     | 300Hz       | 0.54             |
| 1+2     | 5GHz 802.11ac VHT20_LB for Ant. 1 | 87.94          | 4960.00 | 0.20     | 300Hz       | 0.56             |
| 1+2     | 5GHz 802.11ac VHT20_LB for Ant. 2 | 87.94          | 4960.00 | 0.20     | 300Hz       | 0.56             |
| 1       | 5GHz 802.11ac VHT40_LB            | 78.43          | 2400.00 | 0.42     | 1kHz        | 1.06             |
| 1+2     | 5GHz 802.11ac VHT40_LB for Ant. 1 | 78.43          | 2400.00 | 0.42     | 1kHz        | 1.06             |
| 1+2     | 5GHz 802.11ac VHT40_LB for Ant. 2 | 78.43          | 2400.00 | 0.42     | 1kHz        | 1.06             |
| 1       | 5GHz 802.11ac VHT80_LB            | 82.83          | 3280.00 | 0.30     | 1kHz        | 0.85             |
| 1+2     | 5GHz 802.11ac VHT80_LB for Ant. 1 | 83.00          | 3320.00 | 0.30     | 1kHz        | 0.81             |
| 1+2     | 5GHz 802.11ac VHT80_LB for Ant. 2 | 83.00          | 3320.00 | 0.30     | 1kHz        | 0.81             |



<Ant. 1>

802.11a

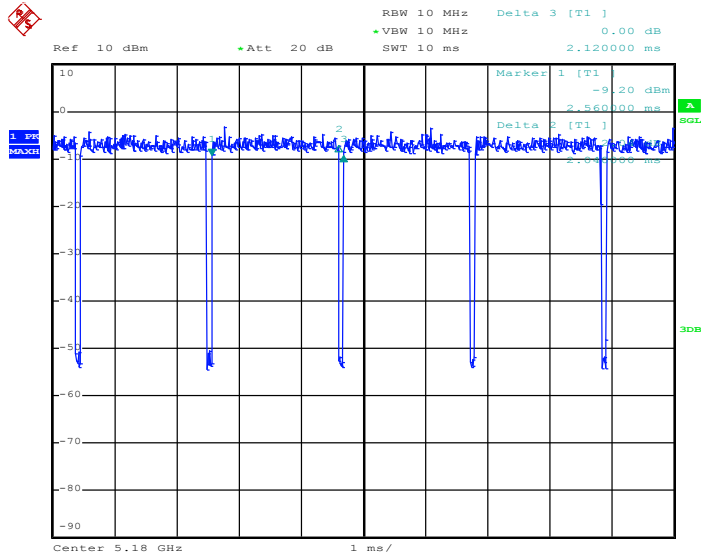

Date: 3.FEB.2018 21:29:17

802.11n HT20

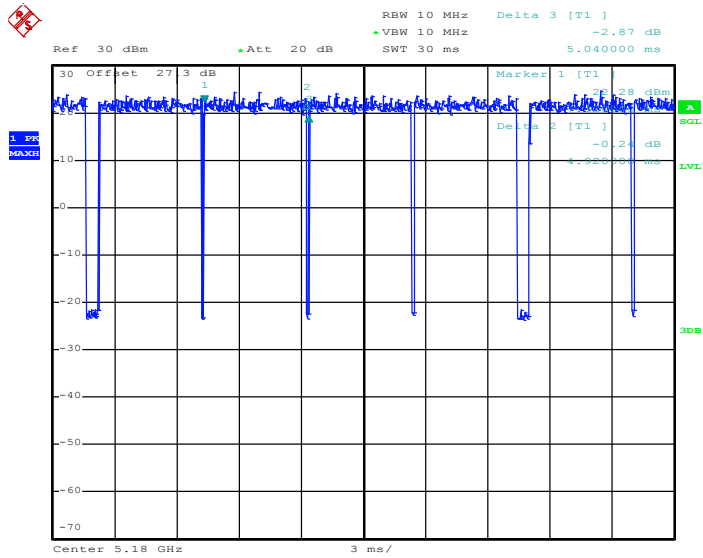

Date: 5.FEB.2018 21:44:40



802.11n HT40

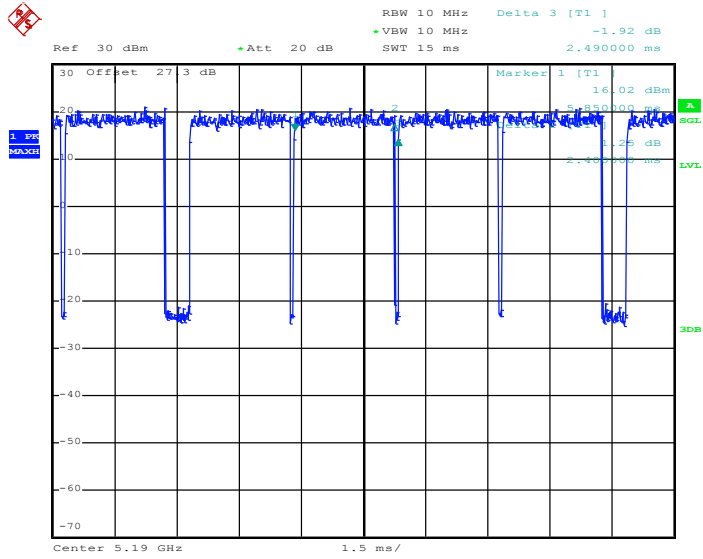

Date: 5.FEB.2018 22:03:19

802.11ac VHT20

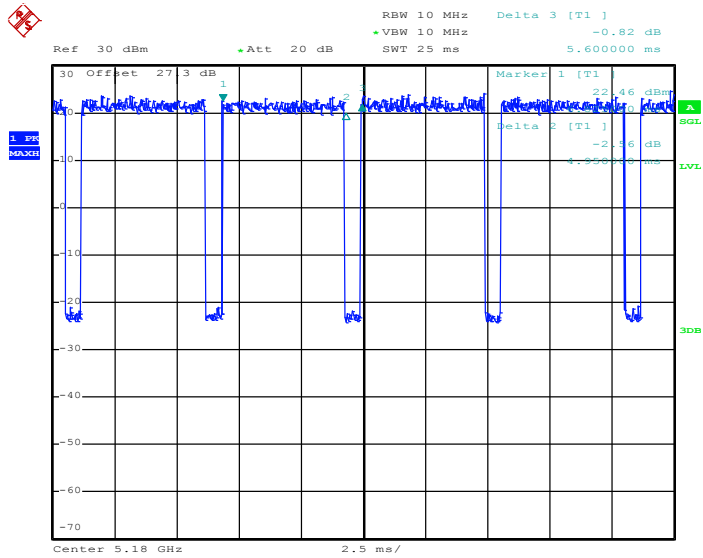

Date: 5.FEB.2018 21:51:18



802.11ac VHT40

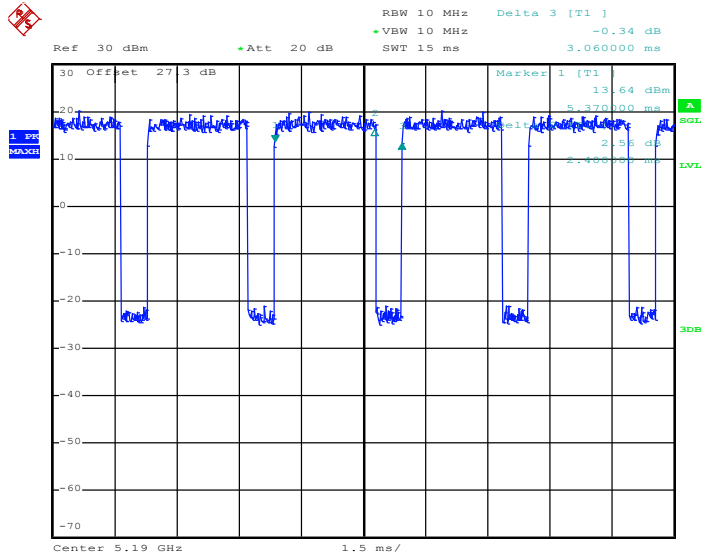

Date: 5.FEB.2018 21:58:59

802.11ac VHT80

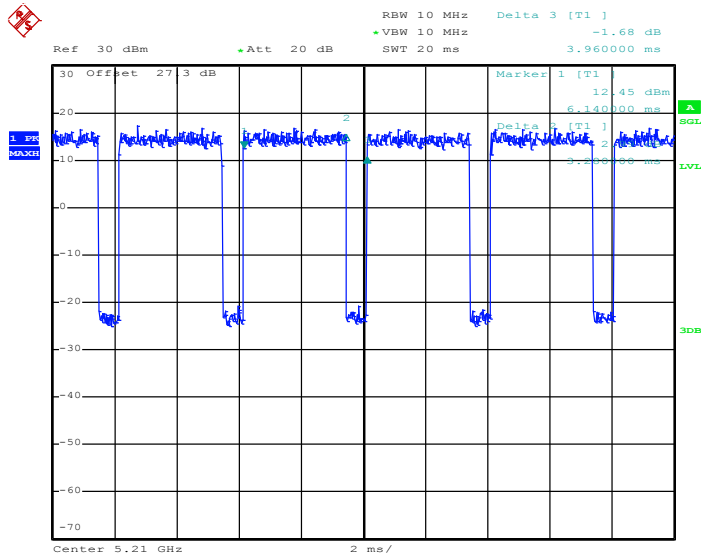

Date: 5.FEB.2018 22:05:06





MIMO <Ant. 1>

802.11a

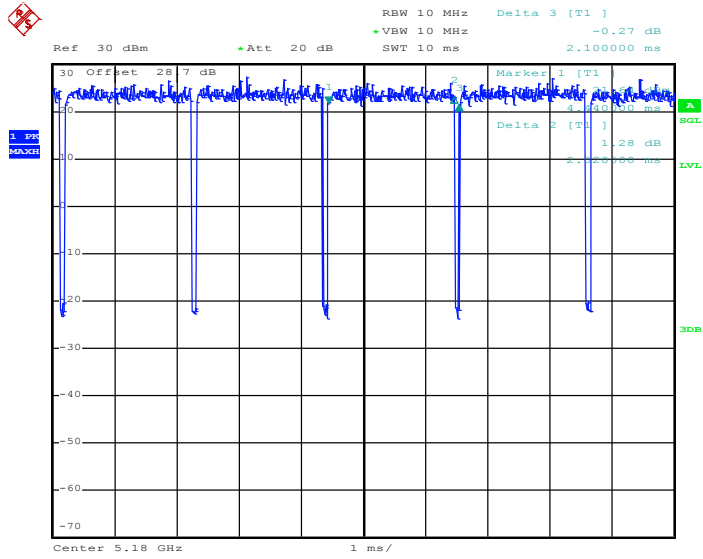

Date: 7.FEB.2018 00:55:02

802.11n HT20

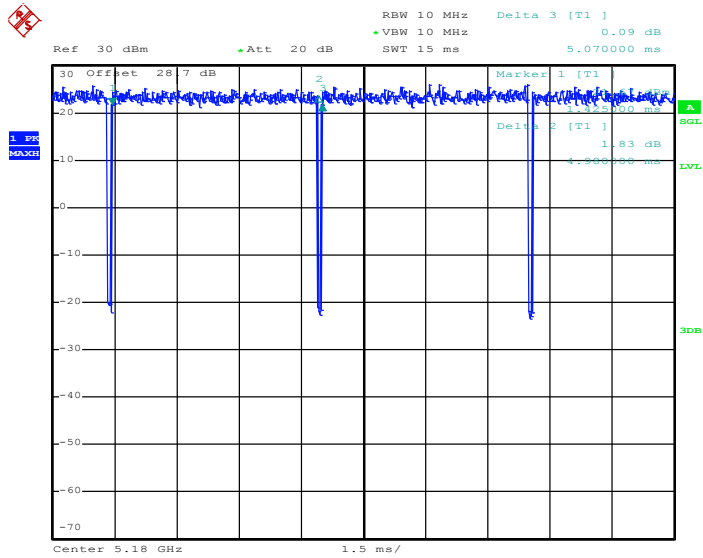

Date: 7.FEB.2018 00:51:01



802.11n HT40

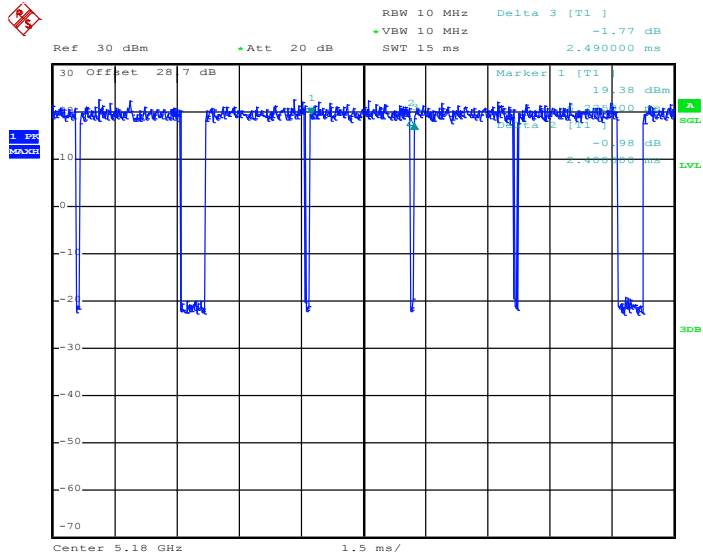

Date: 6.FEB.2018 20:05:47

802.11ac VHT20

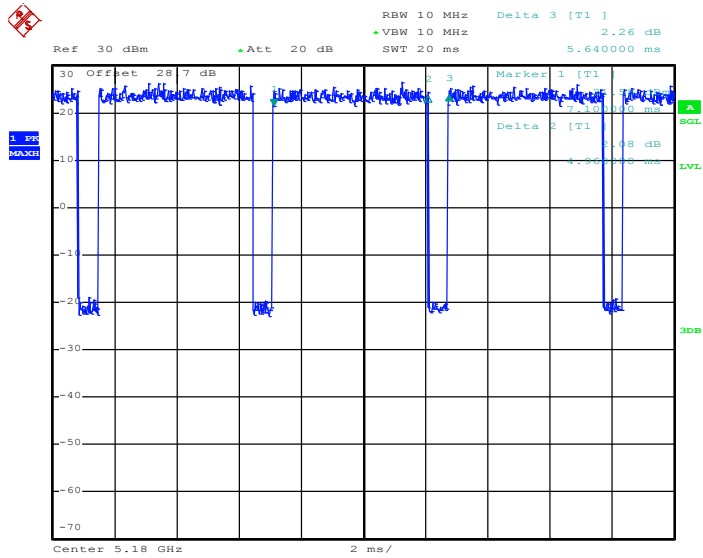

Date: 6.FEB.2018 19:51:08



802.11ac VHT40

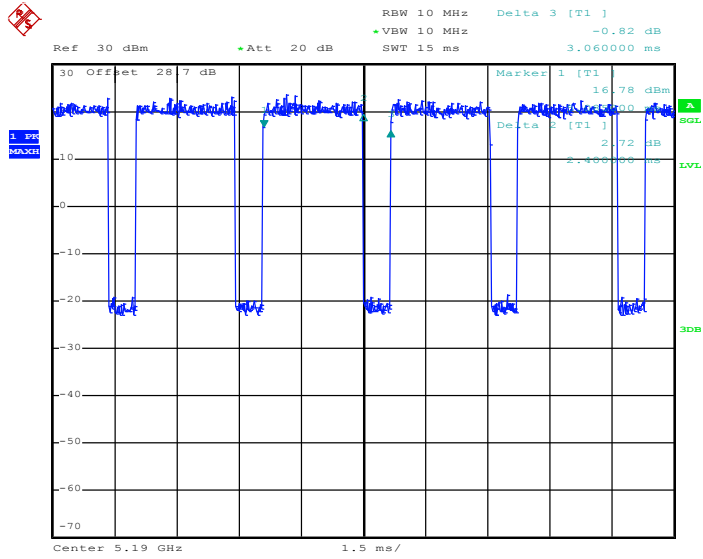

Date: 6.FEB.2018 19:54:28

802.11ac VHT80

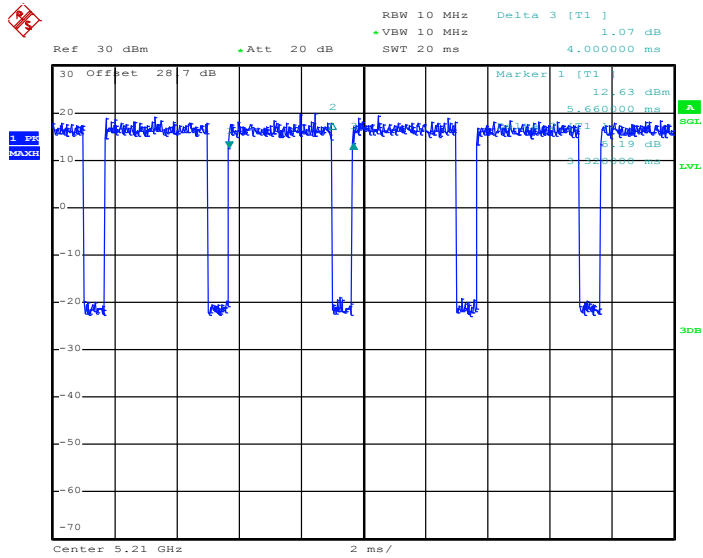

Date: 6.FEB.2018 19:56:19



MIMO <Ant. 2>

802.11a

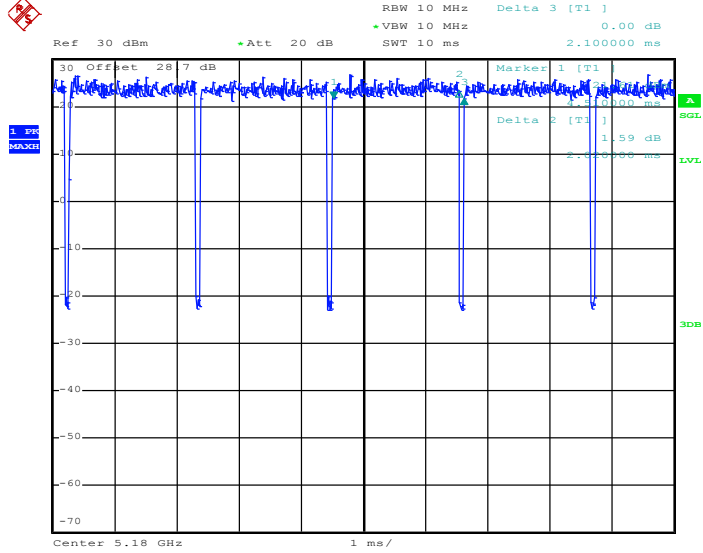

Date: 7.FEB.2018 00:54:04

802.11n HT20

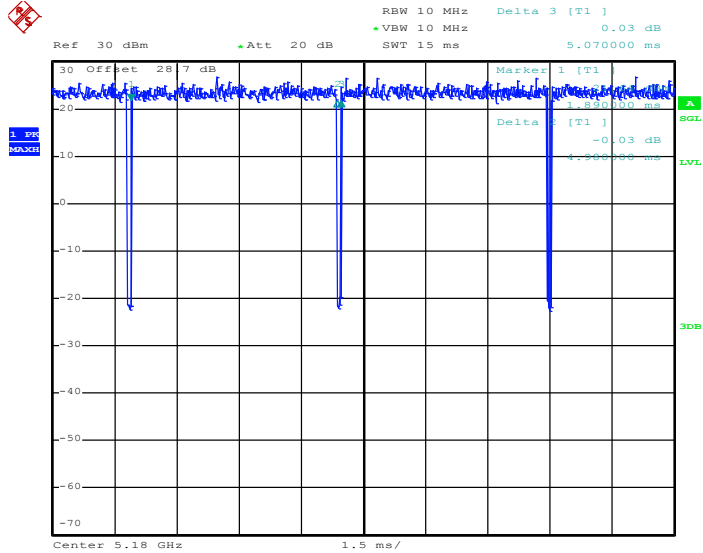

Date: 7.FEB.2018 00:53:10



802.11n HT40

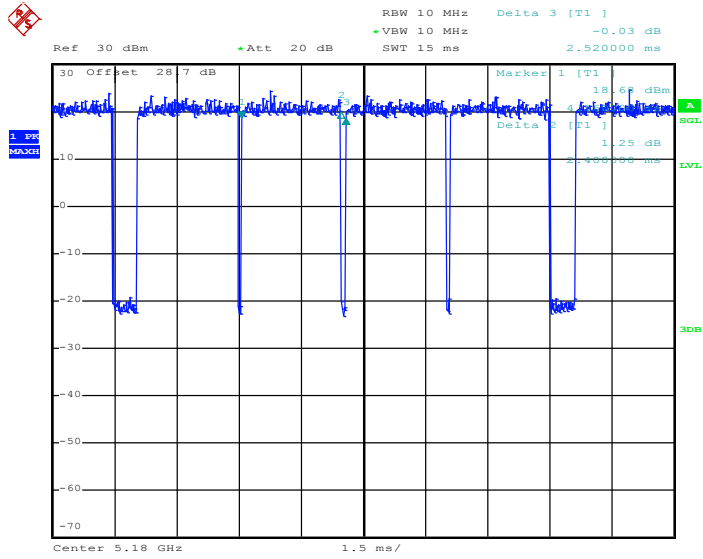

Date: 6.FEB.2018 20:06:36

802.11ac VHT20

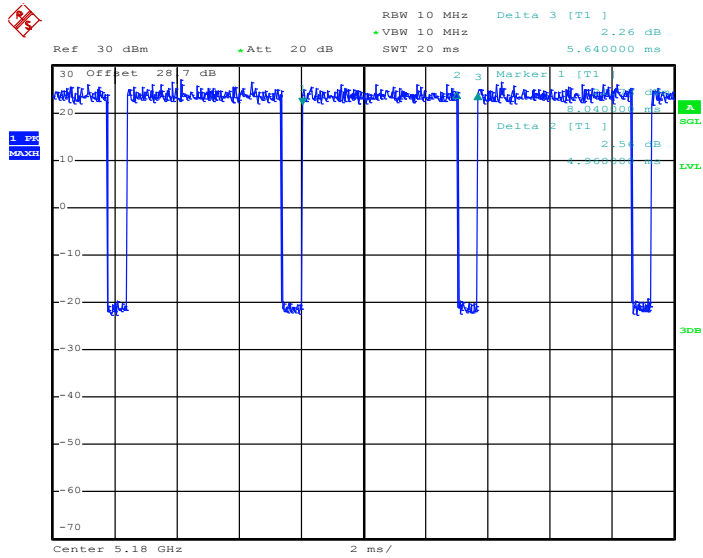

Date: 6.FEB.2018 19:51:51



802.11ac VHT40

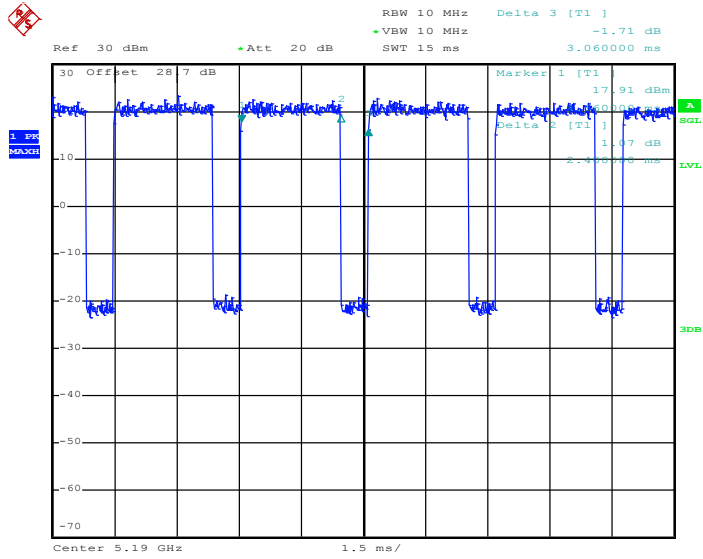

Date: 6.FEB.2018 19:53:13

802.11ac VHT80

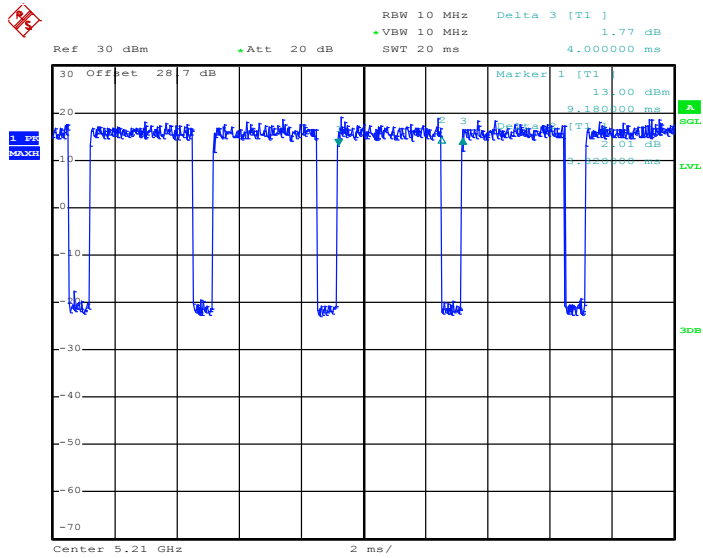

Date: 6.FEB.2018 19:56:58