



FCC RF Test Report

APPLICANT : Plume Design Inc
EQUIPMENT : Plume Adaptive Wifi
BRAND NAME : Plume Design Inc
MODEL NAME : B1A
FCC ID : 2AG7G-B1A
STANDARD : FCC Part 15 Subpart E §15.407
CLASSIFICATION : (NII) Unlicensed National Information Infrastructure

The product was received on Jan. 17, 2018 and testing was completed on Apr. 12, 2018. We, SPORTON INTERNATIONAL INC., would like to declare that the tested sample has been evaluated in accordance with the test procedures and has been in compliance with the applicable technical standards.

The test results in this report apply exclusively to the tested model / sample. Without written approval of SPORTON INTERNATIONAL INC., the test report shall not be reproduced except in full.

Reviewed by: Joseph Lin / Supervisor

Approved by: Jones Tsai / Manager



SPORTON INTERNATIONAL INC.

No. 52, Hwa Ya 1st Rd., Hwa Ya Technology Park, Kwei-Shan District, Tao Yuan City, Taiwan, R.O.C.

SPORTON INTERNATIONAL INC.

TEL : 886-3-327-3456

FAX : 886-3-328-4978

FCC ID: 2AG7G-B1A

Page Number : 1 of 33

Report Issued Date : Apr. 17, 2018

Report Version : Rev. 03

Report Template No.: BU5-FR15EWLAC MA Version 2.0



TABLE OF CONTENTS

REVISION HISTORY..... 3

SUMMARY OF TEST RESULT 4

1 GENERAL DESCRIPTION 5

 1.1 Applicant 5

 1.2 Manufacturer 5

 1.3 Product Feature of Equipment Under Test 5

 1.4 Modification of EUT 5

 1.5 Testing Location 6

 1.6 Applicable Standards 6

2 TEST CONFIGURATION OF EQUIPMENT UNDER TEST 7

 2.1 Carrier Frequency and Channel 7

 2.2 Test Mode 8

 2.3 Connection Diagram of Test System 9

 2.4 Support Unit used in test configuration and system 10

 2.5 EUT Operation Test Setup 11

 2.6 Measurement Results Explanation Example 11

3 TEST RESULT 12

 3.1 26dB & 99% Occupied Bandwidth Measurement 12

 3.2 Maximum Conducted Output Power Measurement 15

 3.3 Power Spectral Density Measurement 17

 3.4 Unwanted Emissions Measurement 20

 3.5 AC Conducted Emission Measurement 26

 3.6 Automatically Discontinue Transmission 28

 3.7 Antenna Requirements 29

4 LIST OF MEASURING EQUIPMENT 31

5 UNCERTAINTY OF EVALUATION 33

APPENDIX A. CONDUCTED TEST RESULTS

APPENDIX B. AC CONDUCTED EMISSION TEST RESULT

APPENDIX C. RADIATED SPURIOUS EMISSION

APPENDIX D. RADIATED SPURIOUS EMISSION PLOTS

APPENDIX E. DUTY CYCLE PLOTS

APPENDIX F. SETUP PHOTOGRAPHS



REVISION HISTORY

REPORT NO.	VERSION	DESCRIPTION	ISSUED DATE
FR811726C	Rev. 01	Initial issue of report	Apr. 06, 2018
FR811726C	Rev. 02	Revising antenna gain in section 3.7.3 and appendix a	Apr. 12, 2018
FR811726C	Rev. 03	Revising connection diagram of test system in section 2.3	Apr. 17, 2018



SUMMARY OF TEST RESULT

Report Section	FCC Rule	Description	Limit	Result	Remark
3.1	2.1049 & 15.403(i)	26dB & 99% Bandwidth	-	Pass	-
3.2	15.407(a)	Maximum Conducted Output Power	≤ 30 dBm for Band 1	Pass	-
3.3	15.407(a)	Power Spectral Density	≤ 17 dBm for Band 1	Pass	-
3.4	15.407(b)	Unwanted Emissions	15.407(b) & 15.209(a)	Pass	Under limit 10.46 dB at 0.692 MHz
3.5	15.207	AC Conducted Emission	15.207(a)	Pass	Under limit 1.12 dB at 5149.500 MHz
3.6	15.407(c)	Automatically Discontinue Transmission	Discontinue Transmission	Pass	-
3.7	15.203 & 15.407(a)	Antenna Requirement	N/A	Pass	-



1 General Description

1.1 Applicant

Plume Design Inc
290 S California Ave, Palo Alto, CA94306

1.2 Manufacturer

Plume Design Inc
290 S California Ave, Palo Alto, CA94306

1.3 Product Feature of Equipment Under Test

Bluetooth, Wi-Fi 2.4GHz 802.11b/g/n, and Wi-Fi 5GHz 802.11a/n/ac

Product Specification subjective to this standard	
Antenna Type	WLAN <Ant. 1>: IFA Antenna <Ant. 2>: IFA Antenna <Ant. 3>: PIFA Antenna <Ant. 4>: PIFA Antenna <Ant. 5>: IFA Antenna <Ant. 6>: IFA Antenna Bluetooth: Slot Antenna

1.4 Modification of EUT

No modifications are made to the EUT during all test items.



1.5 Testing Location

Sporton Lab is accredited to ISO 17025 by Taiwan Accreditation Foundation (TAF code : 1190) and the FCC designation No. TW1190 and TW0007 under the FCC 2.948(e) by Mutual Recognition Agreement (MRA) in FCC Test.

Test Site	SPORTON INTERNATIONAL INC.	
Test Site Location	No. 52, Hwa Ya 1 st Rd., Hwa Ya Technology Park, Kwei-Shan District, Tao Yuan City, Taiwan, R.O.C. TEL: +886-3-327-3456 FAX: +886-3-328-4978	
Test Site No.	Sporton Site No.	
	TH05-HY	CO05-HY

Note: The test site complies with ANSI C63.4 2014 requirement.

Test Site	SPORTON INTERNATIONAL INC.	
Test Site Location	No.58, Aly. 75, Ln. 564, Wenhua 3rd Rd. Guishan Dist, Taoyuan City, Taiwan (R.O.C.) TEL: +886-3-327-0868 FAX: +886-3-327-0855	
Test Site No.	Sporton Site No.	
	03CH11-HY	

Note: The test site complies with ANSI C63.4 2014 requirement.

1.6 Applicable Standards

According to the specifications of the manufacturer, the EUT must comply with the requirements of the following standards:

- FCC Part 15 Subpart E
- FCC KDB 789033 D02 General UNII Test Procedures New Rules v02r01.
- FCC KDB 662911 D01 Multiple Transmitter Output v02r01.
- ANSI C63.10-2013

Remark:

1. All test items were verified and recorded according to the standards and without any deviation during the test.
2. This EUT has also been tested and complied with the requirements of FCC Part 15, Subpart B, recorded in a separate test report.



2 Test Configuration of Equipment Under Test

- a. The EUT has been associated with peripherals and configuration operated in a manner tended to maximize its emission characteristics in a typical application. Frequency range investigated: conduction emission (150 kHz to 30 MHz), radiation emission (9 kHz to the 10th harmonic of the highest fundamental frequency or to 40 GHz, whichever is lower). For radiated measurement, pre-scanned in three orthogonal panels, X, Y, Z. The worst cases (Z plane) were recorded in this report.
- b. AC power line Conducted Emission was tested under maximum output power.

2.1 Carrier Frequency and Channel

Frequency Band	Channel	Freq. (MHz)	Channel	Freq. (MHz)
5150-5250 MHz Band 1 (U-NII-1)	36	5180	44	5220
	38*	5190	46*	5230
	40	5200	48	5240
	42#	5210		

Note:

1. The above Frequency and Channel in "*" were 802.11n HT40 and 802.11ac VHT40.
2. The above Frequency and Channel in "#" were 802.11ac VHT80.



2.2 Test Mode

Final test modes are considering the modulation and worse data rates as below table.

Single Mode

Modulation	Data Rate
802.11a	6 Mbps
802.11n HT20 (Covered by VHT20)	MCS0
802.11n HT40 (Covered by VHT40)	MCS0
802.11ac VHT20	MCS0
802.11ac VHT40	MCS0
802.11ac VHT80	MCS0

MIMO Mode

Modulation	Data Rate
802.11a	6 Mbps
802.11n HT20 (Covered by VHT20)	MCS0
802.11n HT40 (Covered by VHT40)	MCS0
802.11ac VHT20	MCS0
802.11ac VHT40	MCS0
802.11ac VHT80	MCS0

TXBF Mode

Modulation	Data Rate
802.11n HT20 (Covered by VHT20)	MCS0
802.11n HT40 (Covered by VHT40)	MCS0
802.11ac VHT20	MCS0
802.11ac VHT40	MCS0
802.11ac VHT80	MCS0

Test Cases	
AC Conducted Emission	Mode 1 : WLAN (5GHz) Link + Bluetooth Idle + Lan 1 Link + Lan 2 Link

Ch. #		Band I : 5150-5250 MHz			
		802.11a	802.11ac VHT20	802.11ac VHT40	802.11ac VHT80
L	Low	36	36	38	-
M	Middle	44	44	-	42
H	High	48	48	46	-

2.3 Connection Diagram of Test System

<AC Conducted Emission>

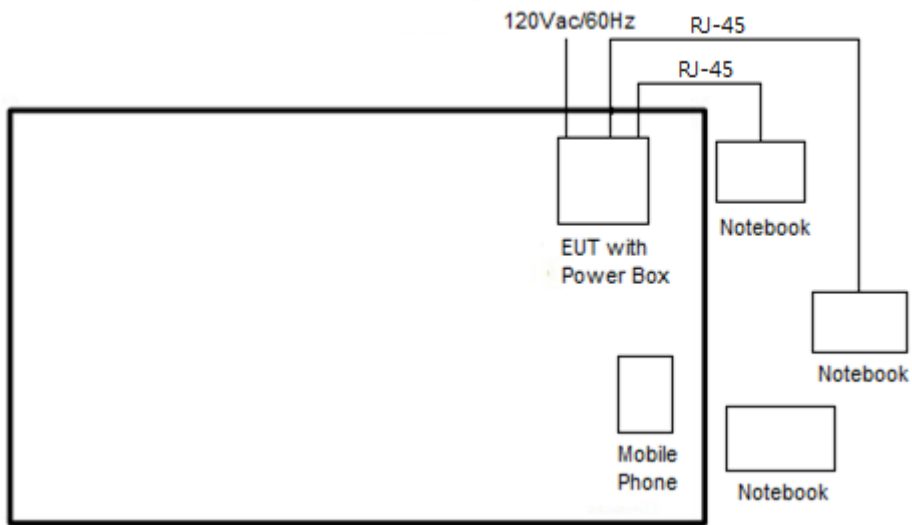

<Radiated Spurious Emission>

<CDD Mode>

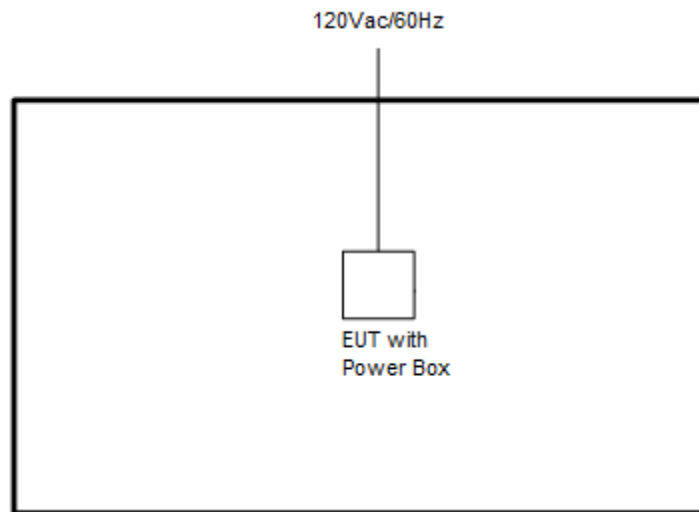

<TXBF Mode>

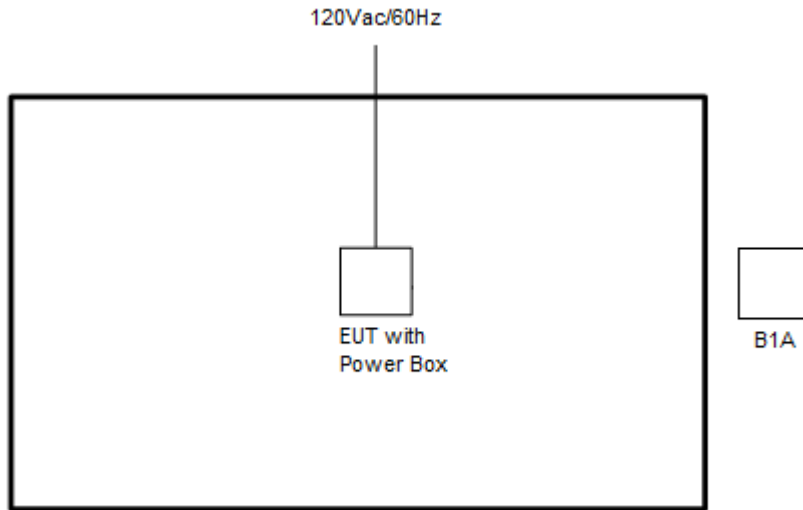

2.4 Support Unit used in test configuration and system

Item	Equipment	Trade Name	Model Name	FCC ID	Data Cable	Power Cord
1.	Notebook	DELL	Latitude E6320	FCC DoC/ Contains FCC ID: QDS-BRCM1054	N/A	AC I/P: Unshielded, 1.2 m DC O/P: Shielded, 1.8 m
2.	Notebook	DELL	Latitude E3340	FCC DoC/ Contains FCC ID: PD97260NGU	N/A	AC I/P: Unshielded, 1.2 m DC O/P: Shielded, 1.8 m
3.	Mobile Phone	Apple	A1687	BCG-E2944A	N/A	N/A



2.5 EUT Operation Test Setup

The RF test items, utility “QSPR” was installed in Notebook which was programmed in order to make the EUT get into the engineering modes to provide channel selection, power level, data rate and the application type and for continuous transmitting signals.

For TXBF mode, the EUT was tested under normal operation and link to another EUT with power, modulation modes and data rates controlled by engineer mode command lines. The “QSPR” software tool was used to make EUT continuous transmitting signals.

2.6 Measurement Results Explanation Example

For all conducted test items:

The offset level is set in the spectrum analyzer to compensate the RF cable loss and attenuator factor between EUT conducted output port and spectrum analyzer. With the offset compensation, the spectrum analyzer reading level is exactly the EUT RF output level.

Example :

The spectrum analyzer offset is derived from RF cable loss and attenuator factor.

Offset = RF cable loss + attenuator factor.

Following shows an offset computation example with cable loss 4.2 dB and 10dB attenuator.

$$\begin{aligned} \text{Offset(dB)} &= \text{RF cable loss(dB)} + \text{attenuator factor(dB)}. \\ &= 4.2 + 10 = 14.2 \text{ (dB)} \end{aligned}$$

3 Test Result

3.1 26dB & 99% Occupied Bandwidth Measurement

3.1.1 Description of 26dB & 99% Occupied Bandwidth

This section is for reporting purpose only.

There is no restriction limits for bandwidth.

3.1.2 Measuring Instruments

The measuring equipment is listed in the section 4 of this test report.

3.1.3 Test Procedures

1. The testing follows FCC KDB 789033 D02 General UNII Test Procedures New Rules v02r01. Section C) Emission bandwidth
2. Set RBW = approximately 1% of the emission bandwidth.
3. Set the VBW > RBW.
4. Detector = Peak.
5. Trace mode = max hold
6. Measure the maximum width of the emission that is 26 dB down from the peak of the emission. Compare this with the RBW setting of the analyzer. Readjust RBW and repeat measurement as needed until the RBW/EBW ratio is approximately 1%.
7. For 99% Bandwidth Measurement, the spectrum analyzer's resolution bandwidth (RBW) is set 1MHz and set the Video bandwidth (VBW) $\geq 3 * RBW$.
8. Measure and record the results in the test report.

3.1.4 Test Setup

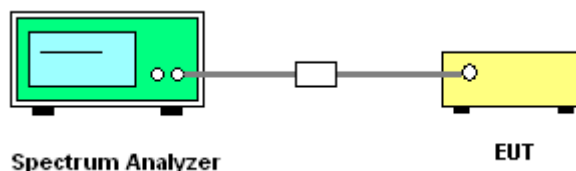

3.1.5 Test Result of 26dB & 99% Occupied Bandwidth

Please refer to Appendix A.



<CDD Mode>

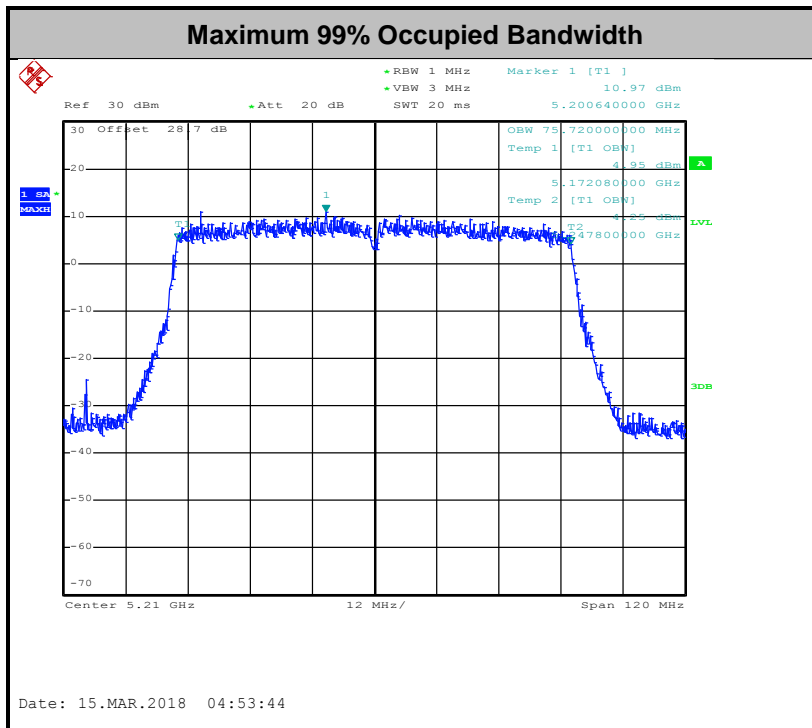
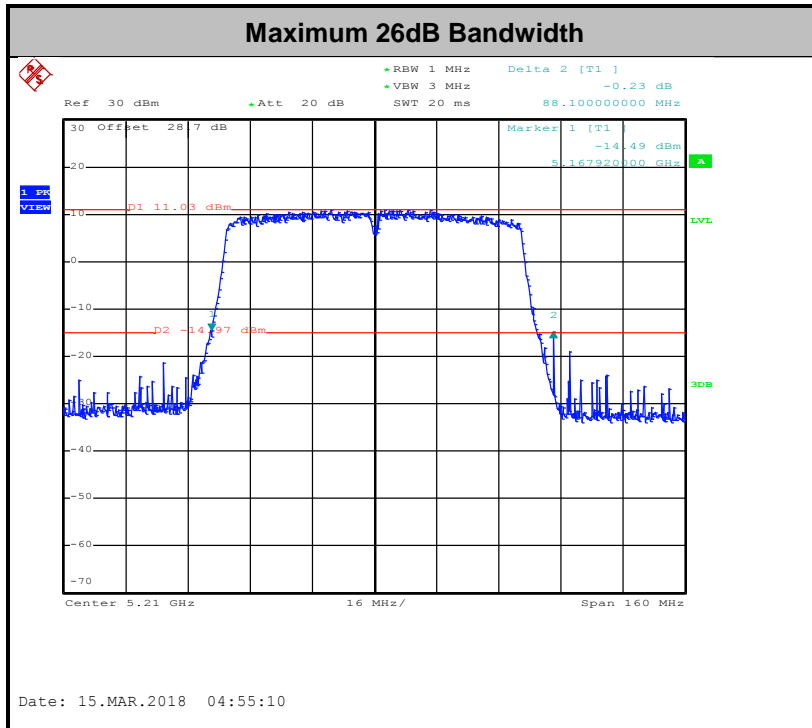

Note: The occupied channel bandwidth is maintained within the band of operation for all of the modulations.



<TXBF Modes>

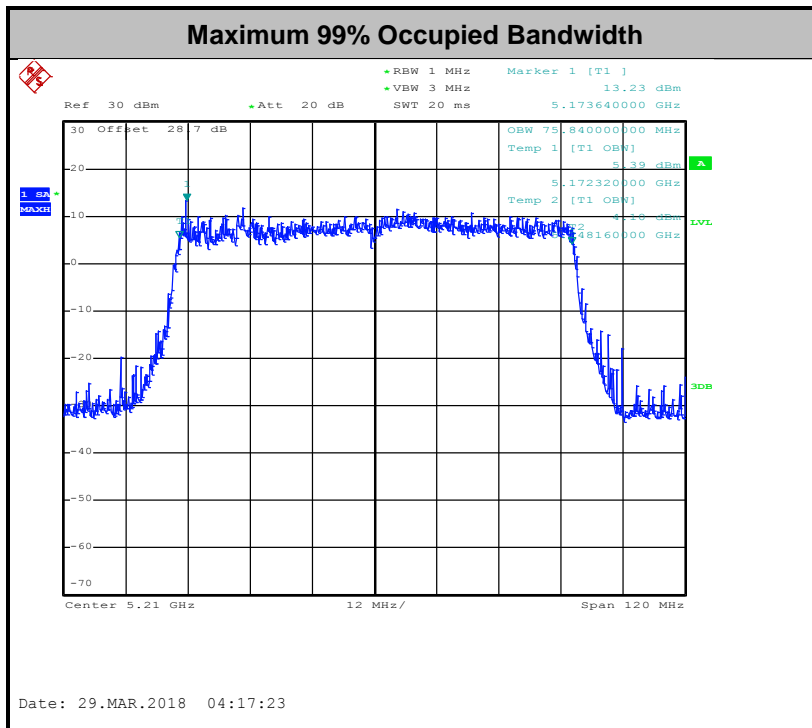
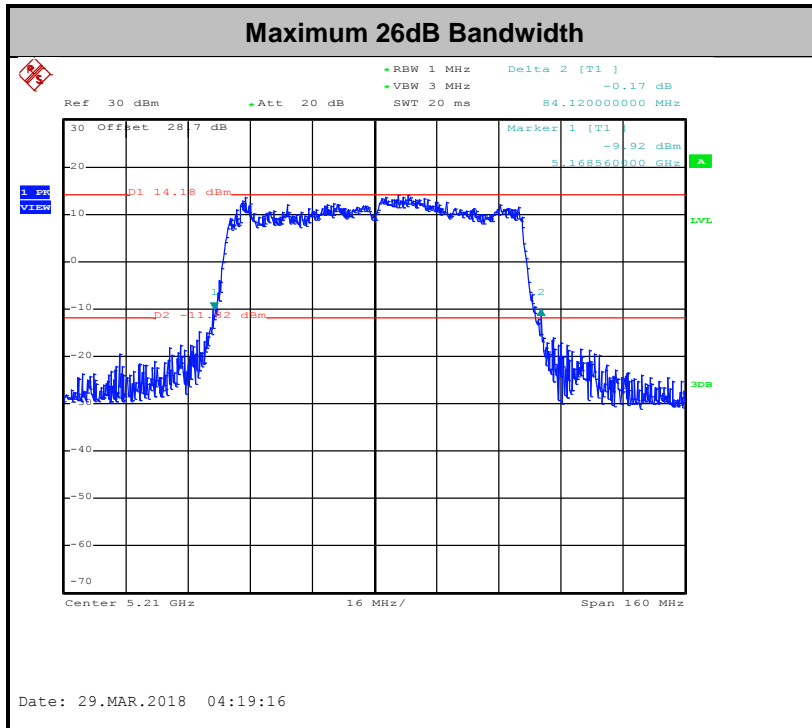

Note: The occupied channel bandwidth is maintained within the band of operation for all of the modulations.



3.2 Maximum Conducted Output Power Measurement

3.2.1 Limit of Maximum Conducted Output Power

<FCC 14-30 CFR 15.407>

For mobile and portable client devices in the 5.15–5.25 GHz band, the maximum conducted output power over the frequency band of operation shall not exceed 250 mW.

If transmitting antennas of directional gain greater than 6 dBi are used, the peak output power shall be reduced by the amount in dB that the directional gain of the antenna exceeds 6 dBi.

Note that U-NII-2 band, devices with a maximum e.i.r.p. greater than 500 mW shall implement TPC in order to have the capability to operate at least 6 dB below the maximum permitted e.i.r.p. of 1 W.

3.2.2 Measuring Instruments

The measuring equipment is listed in the section 4 of this test report.

3.2.3 Test Procedures

<CDD Modes>

The testing follows Method PM of FCC KDB 789033 D02 General UNII Test Procedures New Rules v02r01.

Method PM (Measurement using an RF average power meter):

1. Measurement is performed using a wideband RF power meter.
2. The EUT is configured to transmit continuously with a consistent duty cycle at its maximum power control level.
3. Measure the average power of the transmitter, and the average power is corrected with duty factor, $10 \log(1/x)$, where x is the duty cycle.

<TXBF Modes>

The testing follows Method PM-G of FCC KDB 789033 D02 General UNII Test Procedures New Rules v02r01 for TXBF modes.

Method PM-G (Measurement using a gated RF average power meter):

1. Measurement is performed using a wideband RF power meter.
2. The EUT is configured to transmit at its maximum power control level.
3. Measure the average power of the transmitter
4. Since the measurement is made only during the ON time of the transmitter, no duty cycle correction factor is required.

3.2.4 Test Setup

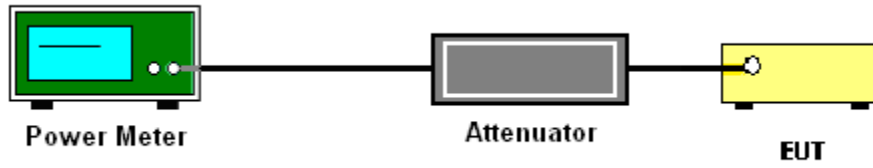

3.2.5 Test Result of Maximum Conducted Output Power

Please refer to Appendix A.



3.3 Power Spectral Density Measurement

3.3.1 Limit of Power Spectral Density

For an indoor access point operating in the band 5.15-5.25 GHz, the maximum power spectral density shall not exceed 17 dBm in any 1 megahertz band.

If transmitting antennas of directional gain greater than 6 dBi are used, the peak output power shall be reduced by the amount in dB that the directional gain of the antenna exceeds 6 dBi.

3.3.2 Measuring Instruments

The measuring equipment is listed in the section 4 of this test report.

3.3.3 Test Procedures

The testing follows FCC KDB 789033 D02 General UNII Test Procedures New Rules v02r01. Section F) Maximum power spectral density.

<CDD Modes>

Method SA-2

(trace averaging across on and off times of the EUT transmissions, followed by duty cycle correction).

- Measure the duty cycle.
- Set span to encompass the entire emission bandwidth (EBW) of the signal.
- Set RBW = 1 MHz.
- Set VBW \geq 3 MHz.
- Number of points in sweep \geq 2 Span / RBW.
- Sweep time = auto.
- Detector = RMS
- Trace average at least 100 traces in power averaging mode.
- Add $10 \log(1/x)$, where x is the duty cycle, to the measured power in order to compute the average power during the actual transmission times. For example, add $10 \log(1/0.25) = 6$ dB if the duty cycle is 25 percent.

<TXBF Modes>**# Method SA-3 #**

(power averaging (rms) detection with max hold):

- Set span to encompass the entire emission bandwidth (EBW) of the signal.
 - Set RBW = 1 MHz.
 - Set VBW \geq 3 MHz
 - Number of points in sweep \geq 2 Span / RBW.
 - Sweep time \leq (number of points in sweep) \times T, when duty cycle is less than 98 percent where T is the minimum transmission duration over which the transmitter is on and is transmitting at its maximum power control level for the tested mode of operation.
 - Detector = power averaging (rms).
 - Trace mode = max hold.
 - Allow max hold to run for at least 60 seconds, or longer as needed to allow the trace to stabilize.
1. The RF output of EUT was connected to the spectrum analyzer by a low loss cable.
 2. Each plot has already offset with cable loss, and attenuator loss. Measure the PPSD and record it.
 3. For MIMO mode, calculation method follows FCC KDB 662911 D01 Multiple Transmitter Output v02r01.

Method (a): Measure and sum the spectra across the outputs.

The total final Power Spectral Density is from a device with 2 transmitter outputs. The spectrum measurements of the individual outputs are all performed with the same span and number of points, the spectrum value in the first spectral bin of output 1 is summed with that in the first spectral bin of output 2 to obtain the value for the first frequency bin of the summed spectrum.

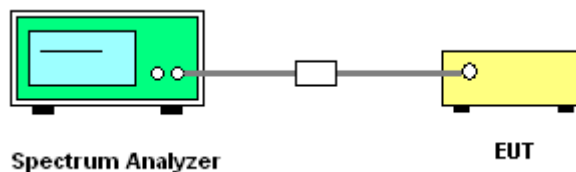
3.3.4 Test Setup**3.3.5 Test Result of Power Spectral Density**

Please refer to Appendix A.



<CDD Modes>

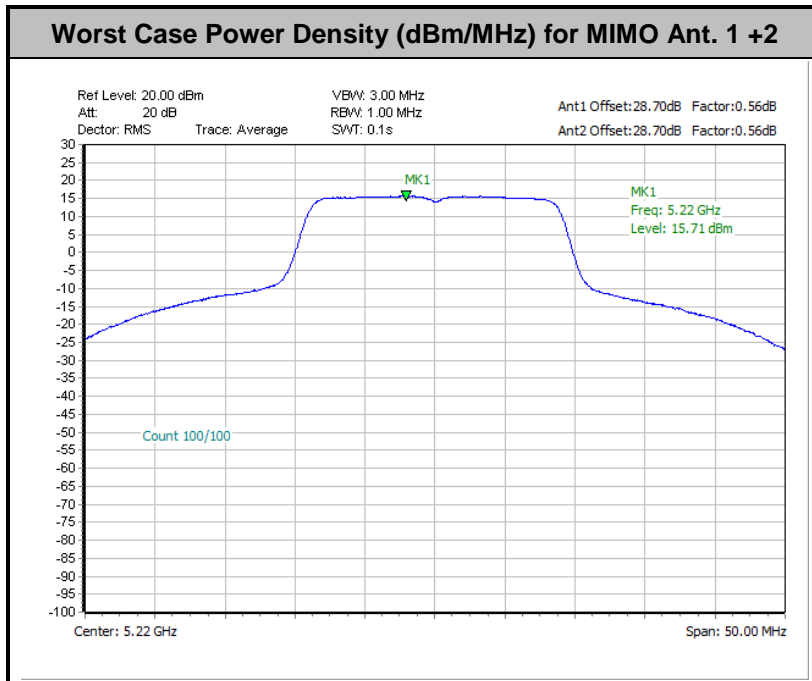

Note: Average Power Density (dB) = Measured value+ Duty Factor

<TXBF Modes>

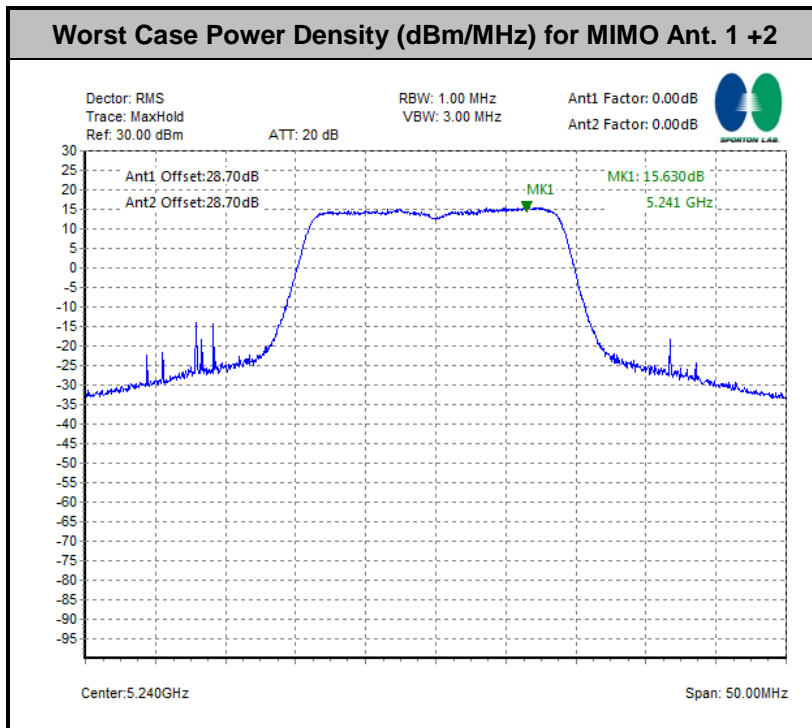

Note: Average Power Density (dB) = Measured value+ Duty Factor



3.4 Unwanted Emissions Measurement

This section is to measure unwanted emissions through radiated measurement for band edge spurious emissions and out of band emissions measurement.

3.4.1 Limit of Unwanted Emissions

- (1) For transmitters operating in the 5150-5250 MHz band: all emissions outside of the 5150-5350 MHz band shall not exceed an EIRP of -27dBm/MHz.
- (2) Unwanted spurious emissions fallen in restricted bands shall comply with the general field strength limits as below table

Frequency (MHz)	Field Strength (microvolts/meter)	Measurement Distance (meters)
0.009 – 0.490	2400/F(kHz)	300
0.490 – 1.705	24000/F(kHz)	30
1.705 – 30.0	30	30
30 – 88	100	3
88 – 216	150	3
216 - 960	200	3
Above 960	500	3

Note: The following formula is used to convert the EIRP to field strength.

$$E = \frac{1000000\sqrt{30P}}{3} \text{ } \mu\text{V/m, where P is the eirp (Watts)}$$

EIRP (dBm)	Field Strength at 3m (dBμV/m)
-17	78.3
- 27	68.3



(3) KDB789033 D02 v02r01 G)2)c)

- (i) Section 15.407(b)(1) to (b)(3) specify the unwanted emission limits for the U-NII-1 and U-NII-2 bands. As specified, emissions above 1000 MHz that are outside of the restricted bands are subject to a peak emission limit of -27 dBm/MHz.³
- (ii) Section 15.407(b)(4) specifies the unwanted emission limit for the U-NII-3 band. A band emissions mask is specified in Section 15.407(b)(4)(i). The emission limits are in terms of a Peak detector. An alternative to the band emissions mask is specified in Section 15.407(b)(4)(ii). The alternative limits are based on the highest antenna gain specified in the filing. There are also marketing and importation restrictions for the devices using the alternative limit.⁴

Note 3: An out-of-band emission that complies with both the average and peak limits of Section 15.209 is not required to satisfy the -27 dBm/MHz peak emission limit.

Note 4: Only devices with antenna gains of 10 dBi or less may be approved using the emission limits specified in Section 15.247(d) till March 2, 2018; all other devices operating in this band must use the mask specified in Section 15.407(b)(4)(i).

3.4.2 Measuring Instruments

The measuring equipment is listed in the section 4 of this test report.



3.4.3 Test Procedures

1. The testing follows FCC KDB 789033 D02 General UNII Test Procedures New Rules v02r01. Section G) Unwanted emissions measurement.
 - (1) Procedure for Unwanted Emissions Measurements Below 1000MHz
 - RBW = 120 kHz
 - VBW = 300 kHz
 - Detector = Peak
 - Trace mode = max hold
 - (2) Procedure for Peak Unwanted Emissions Measurements Above 1000 MHz
 - RBW = 1 MHz
 - VBW \geq 3 MHz
 - Detector = Peak
 - Sweep time = auto
 - Trace mode = max hold
 - (3) Procedures for Average Unwanted Emissions Measurements Above 1000MHz
 - RBW = 1 MHz
 - VBW = 10 Hz, when duty cycle is no less than 98 percent.
 - VBW \geq 1/T, when duty cycle is less than 98 percent where T is the minimum transmission duration over which the transmitter is on and is transmitting at its maximum power control level for the tested mode of operation.
2. The EUT was placed on a turntable with 0.8 meter for frequency below 1GHz and 1.5 meter for frequency above 1GHz respectively above ground.
3. The EUT was set 3 meters from the interference receiving antenna which was mounted on the top of a variable height antenna tower.
4. The antenna is a broadband antenna and its height is adjusted between one meter and four meters above ground to find the maximum value of the field strength for both horizontal polarization and vertical polarization of the antenna.
5. For each suspected emission, the EUT was arranged to its worst case and then adjust the antenna tower (from 1 m to 4 m) and turntable (from 0 degree to 360 degrees) to find the maximum reading.
6. For testing below 1GHz, if the emission level of the EUT in peak mode was 3 dB lower than the limit specified, then peak values of EUT will be reported, otherwise, the emissions will be repeated one by one using the CISPR quasi-peak method and reported.

- 7. For testing above 1GHz, the emission level of the EUT in peak mode was 20dB lower than average limit (that means the emission level in average mode also complies with the limit in average mode), then peak values of EUT will be reported, otherwise, the emissions will be measured in average mode again and reported.

3.4.4 Test Setup

For radiated emissions below 30MHz

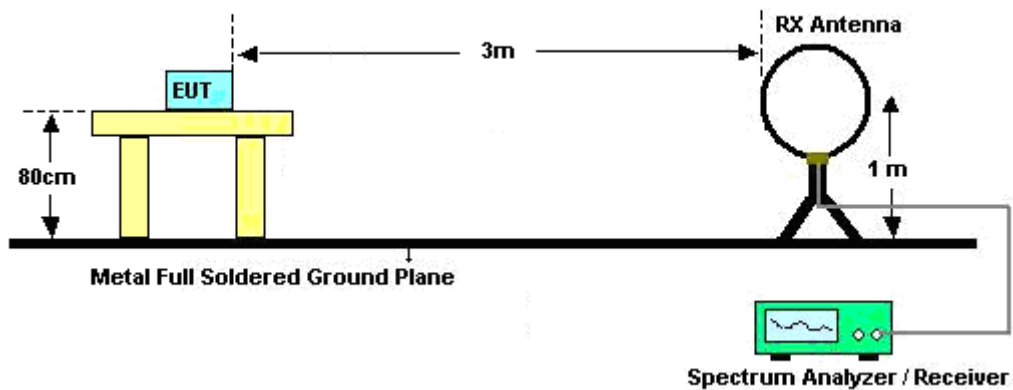

For radiated emissions from 30MHz to 1GHz

<CDD Mode>

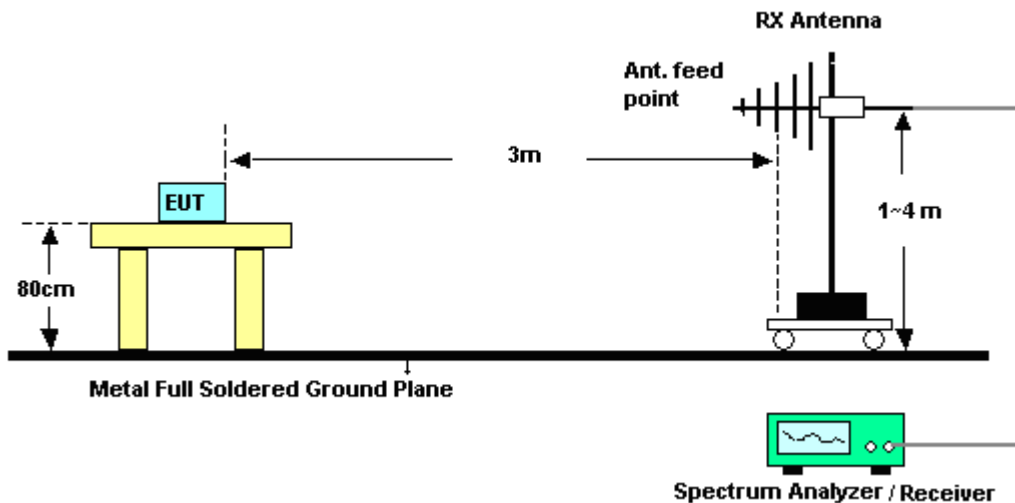

<TXBF Modes>

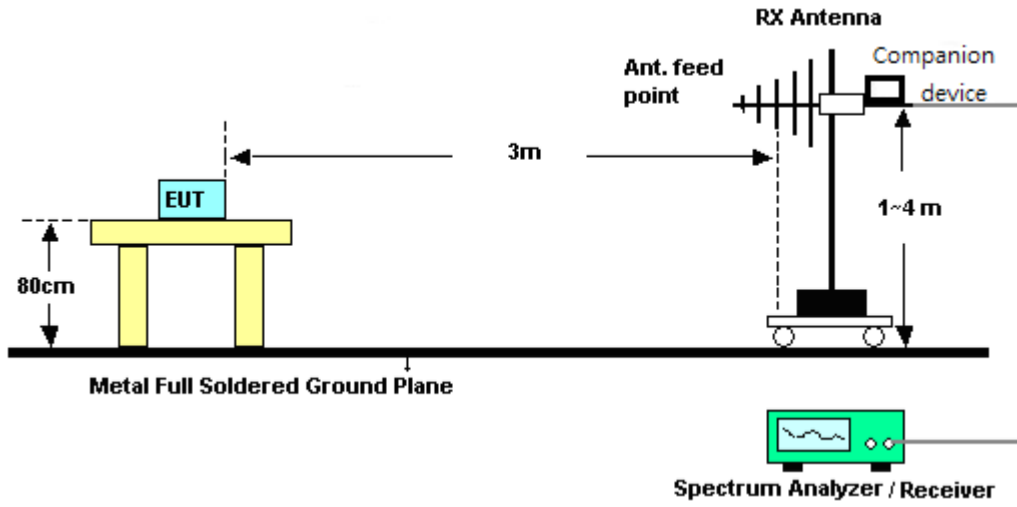

For radiated emissions above 1GHz

<CDD Mode>

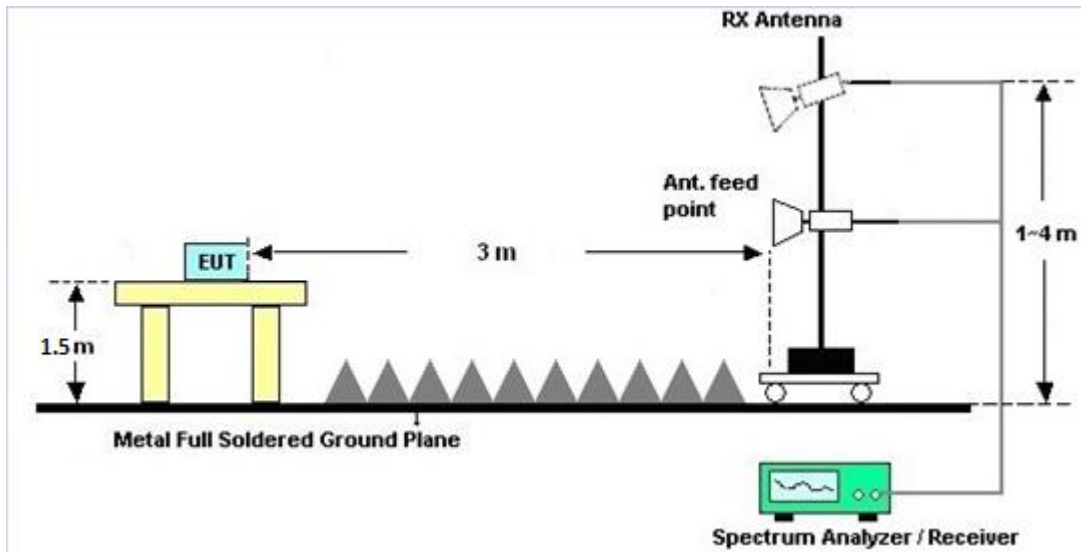

<TXBF Modes>

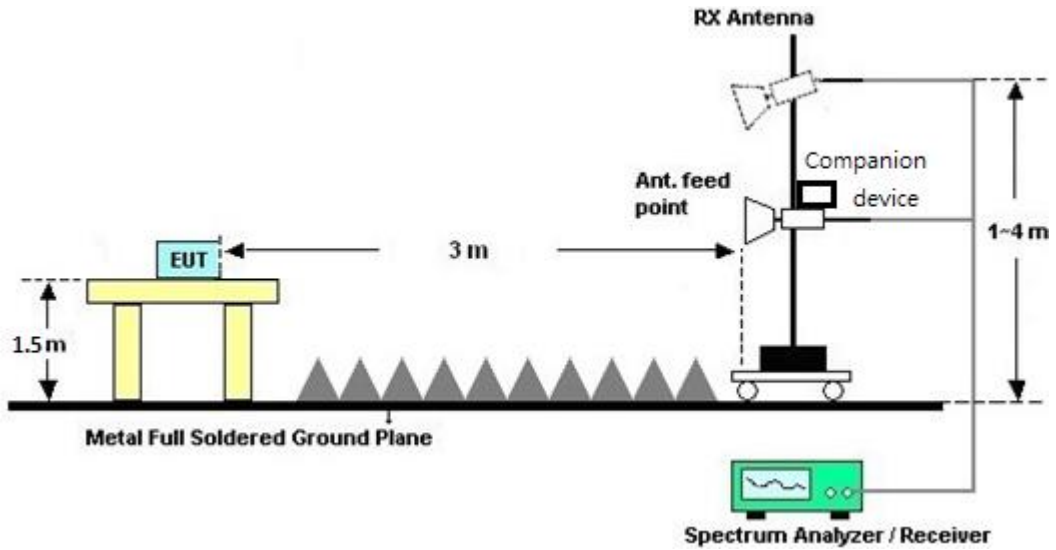

3.4.5 Test Results of Radiated Spurious Emissions (9 kHz ~ 30 MHz)

The low frequency, which started from 9 kHz to 30MHz, was pre-scanned and the result which was 20dB lower than the limit line was not reported.

There is a comparison data of both open-field test site and semi-Anechoic chamber, and the result came out very similar.

3.4.6 Test Result of Radiated Spurious at Band Edges

Please refer to Appendix C and D.

3.4.7 Duty Cycle

Please refer to Appendix E.

3.4.8 Test Result of Radiated Spurious Emissions (30MHz ~ 10th Harmonic)

Please refer to Appendix C and D.



3.5 AC Conducted Emission Measurement

3.5.1 Limit of AC Conducted Emission

For equipment that is designed to be connected to the public utility (AC) power line, the radio frequency voltage that is conducted back onto the AC power line on any frequency or frequencies within the band 150 kHz to 30 MHz shall not exceed the limits in the following table.

Frequency of emission (MHz)	Conducted limit (dB μ V)	
	Quasi-peak	Average
0.15-0.5	66 to 56*	56 to 46*
0.5-5	56	46
5-30	60	50

*Decreases with the logarithm of the frequency.

3.5.2 Measuring Instruments

The measuring equipment is listed in the section 4 of this test report.

3.5.3 Test Procedures

1. The EUT was placed 0.4 meter from the conducting wall of the shielding room was kept at least 80 centimeters from any other grounded conducting surface.
2. Connect EUT to the power mains through a line impedance stabilization network (LISN).
3. All the support units are connecting to the other LISN.
4. The LISN provides 50 ohm coupling impedance for the measuring instrument.
5. The FCC states that a 50 ohm, 50 microhenry LISN should be used.
6. Both sides of AC line were checked for maximum conducted interference.
7. The frequency range from 150 kHz to 30 MHz was searched.
8. Set the test-receiver system to Peak Detect Function and specified bandwidth with Maximum Hold Mode.

3.5.4 Test Setup

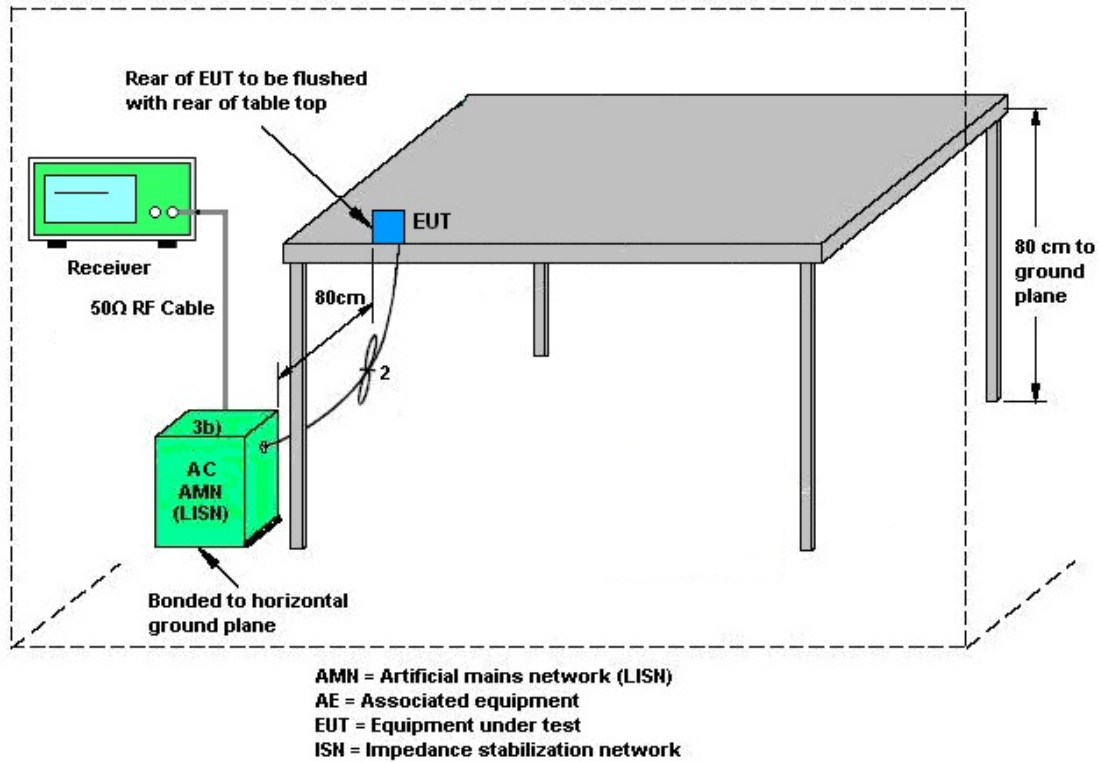

3.5.5 Test Result of AC Conducted Emission

Please refer to Appendix B.



3.6 Automatically Discontinue Transmission

3.6.1 Limit of Automatically Discontinue Transmission

The device shall automatically discontinue transmission in case of either absence of information to transmit or operational failure. These provisions are not intended to preclude the transmission of control or signaling information or the use of repetitive codes used by certain digital technologies to complete frame or burst intervals. Applicants shall include in their application for equipment authorization to describe how this requirement is met.

3.6.2 Measuring Instruments

The measuring equipment is listed in the section 4 of this test report.

3.6.3 Test Result of Automatically Discontinue Transmission

While the EUT is not transmitting any information, the EUT can automatically discontinue transmission and become standby mode for power saving. The EUT can detect the controlling signal of ACK message transmitting from remote device and verify whether it shall resend or discontinue transmission.



3.7 Antenna Requirements

3.7.1 Standard Applicable

If transmitting antenna directional gain is greater than 6 dBi, both the peak transmit power and the peak power spectral density shall be reduced by the amount in dB that the directional gain of the antenna exceeds 6 dBi.

3.7.2 Antenna Anti-Replacement Construction

An embedded-in antenna design is used.

3.7.3 Antenna Gain

<CDD Modes >

FCC KDB 662911 D01 Multiple Transmitter Output v02r01

For CDD transmissions, directional gain is calculated as

Directional gain = GANT + Array Gain, where Array Gain is as follows.

For power spectral density (PSD) measurements on all devices,

Array Gain = 10 log(NANT/NSS=1) dB.

For power measurements on IEEE 802.11 devices,

Array Gain = 0 dB (i.e., no array gain) for NANT ≤ 4.

Directional gain may be calculated by using the formulas applicable to equal gain antennas with GANT set equal to the gain of the antenna having the highest gain;

The EUT supports CDD mode.

For power, the directional gain GANT is set equal to the antenna having the highest gain, i.e., F)2)f)i).

For PSD, the directional gain calculation is following F)2)f)ii) of KDB 662911 D01 v02r01.

The power and PSD limit should be modified if the directional gain of EUT is over 6 dBi,

The directional gain "DG" is calculated as following table.

<CDD Modes>						
			DG	DG	Power	PSD
			for	for	Limit	Limit
	Ant. 1	Ant. 2	Power	PSD	Reduction	Reduction
	(dBi)	(dBi)	(dBi)	(dBi)	(dB)	(dB)
Band I	4.00	4.50	4.50	7.26	0.00	1.26

Power limit reduction = Composite gain – 6dBi, (min = 0)

PSD limit reduction = Composite gain + PSD Array gain – 6dBi, (min = 0)

TXBF modes

FCC KDB 662911 D01 Multiple Transmitter Output v02r01

For CDD transmissions, directional gain is calculated as

$$DirectionalGain = 10 \cdot \log \left[\frac{\sum_{j=1}^{N_{SS}} \left\{ \sum_{k=1}^{N_{ANT}} g_{j,k} \right\}^2}{N_{ANT}} \right]$$

where

Each antenna is driven by no more than one spatial stream;

N_{SS} = the number of independent spatial streams of data;

N_{ANT} = the total number of antennas

$g_{j,k} = 10^{G_k / 20}$ if the k th antenna is being fed by spatial stream j , or zero if it is not;
 G_k is the gain in dBi of the k th antenna.

The EUT supports beamforming for 802.11ac modes.

The directional gain calculation is following F)2)e)ii) of KDB 662911 D01 v02r01.

The power and PSD limit should be modified if the directional gain of EUT is over 6 dBi,

The directional gain “DG” is calculated as following table.

			DG	DG	Power	PSD
			for	for	Limit	Limit
	Ant 1	Ant 2	Power	PSD	Reduction	Reduction
	(dBi)	(dBi)	(dBi)	(dBi)	(dB)	(dB)
Band I	4.00	4.50	7.26	7.26	1.26	1.26

$Power\ Limit\ Reduction = DG(Power) - 6dBi, (min = 0)$

$PSD\ Limit\ Reduction = DG(PSD) - 6dBi, (min = 0)$



4 List of Measuring Equipment

Instrument	Manufacturer	Model No.	Serial No.	Characteristics	Calibration Date	Test Date	Due Date	Remark
Power Meter	Anritsu	ML2495A	1240001	N/A	Sep. 07, 2017	Feb. 03, 2018~ Mar. 31, 2018	Sep. 06, 2018	Conducted (TH05-HY)
Power Sensor	Anritsu	MA2411B	1207349	300MHz~40GHz z	Sep. 07, 2017	Feb. 03, 2018~ Mar. 31, 2018	Sep. 06, 2018	Conducted (TH05-HY)
Spectrum Analyzer	Rohde & Schwarz	FSP40	100055	9kHz~40GHz	Jun. 20, 2017	Feb. 03, 2018~ Apr. 12, 2018	Jun. 19, 2018	Conducted (TH05-HY)
Switch Box & RF Cable	Burgeon	ETF-058	EC130048 4	N/A	Jan. 03, 2018	Feb. 03, 2018~ Apr. 12, 2018	Jan. 02, 2019	Conducted (TH05-HY)
Switch Box & RF Cable	Burgeon	ETF-058	EC120838 1	N/A	Mar. 03, 2017	Feb. 03, 2018~ Feb. 28, 2018	Mar. 02, 2018	Conducted (TH05-HY)
Switch Box & RF Cable	Burgeon	ETF-058	EC120838 1	N/A	Mar. 01, 2018	Mar. 01, 2018~ Mar. 31, 2018	Feb. 28, 2019	Conducted (TH05-HY)
Power Sensor	DARE	RPR3006W	16I00054S NO11	10MHz~6GHz	Dec. 11, 2017	Mar. 29, 2018~ Apr. 12, 2018	Dec. 10, 2018	Conducted (TH05-HY)
AC Power Source	ChainTek	APC-1000W	N/A	N/A	N/A	Mar. 27, 2018	N/A	Conduction (CO05-HY)
EMI Test Receiver	Rohde & Schwarz	ESCI 7	100724	9kHz~7GHz	Sep. 20, 2017	Mar. 27, 2018	Sep. 19, 2018	Conduction (CO05-HY)
LISN	Rohde & Schwarz	ENV216	100080	9kHz~30MHz	Nov. 30, 2017	Mar. 27, 2018	Nov. 29, 2018	Conduction (CO05-HY)
LISN	Rohde & Schwarz	ENV216	100081	9kHz~30MHz	Dec. 08, 2017	Mar. 27, 2018	Dec. 07, 2018	Conduction (CO05-HY)
Software	Rohde & Schwarz	EMC32 V10.30	N/A	N/A	N/A	Mar. 27, 2018	N/A	Conduction (CO05-HY)



Instrument	Manufacturer	Model No.	Serial No.	Characteristics	Calibration Date	Test Date	Due Date	Remark
Amplifier	MITEQ	TTA1840-35-HG	1871923	18GHz~40GHz, VSWR : 2.5:1 max	Jul. 18, 2017	Feb. 11, 2018~ Mar. 20, 2018	Jul. 17, 2018	Radiation (03CH11-HY)
Amplifier	SONOMA	310N	187312	9kHz~1GHz	Nov. 10, 2016	Feb. 11, 2018~ Mar. 20, 2018	Nov. 09, 2018	Radiation (03CH11-HY)
Bilog Antenna	TESEQ	CBL 6111D&N-6-0 6	35414&AT- N0602	30MHz~1GHz	Oct. 14, 2017	Feb. 11, 2018~ Mar. 20, 2018	Oct. 13, 2018	Radiation (03CH11-HY)
Horn Antenna	SCHWARZBE CK	BBHA 9120 D	9120D-132 6	1GHz ~ 18GHz	Oct. 16, 2017	Feb. 11, 2018~ Mar. 20, 2018	Oct. 15, 2018	Radiation (03CH11-HY)
Loop Antenna	Rohde & Schwarz	HFH2-Z2	100488	9 kHz~30 MHz	Nov. 23, 2017	Feb. 11, 2018~ Mar. 20, 2018	Nov. 22, 2019	Radiation (03CH11-HY)
Preamplifier	Keysight	83017A	MY532700 80	1GHz~26.5GHz	Nov. 10, 2016	Feb. 11, 2018~ Mar. 20, 2018	Nov. 09, 2018	Radiation (03CH11-HY)
Spectrum Analyzer	Keysight	N9010A	MY542004 86	10Hz ~ 44GHz	Oct. 19, 2017	Feb. 11, 2018~ Mar. 20, 2018	Oct. 18, 2018	Radiation (03CH11-HY)
Antenna Mast	EMEC	AM-BS-4500- B	N/A	1~4m	N/A	Feb. 11, 2018~ Mar. 20, 2018	N/A	Radiation (03CH11-HY)
Turn Table	EMEC	TT 2000	N/A	0~360 Degree	N/A	Feb. 11, 2018~ Mar. 20, 2018	N/A	Radiation (03CH11-HY)
Preamplifier	MITEQ	AMF-7D-0010 1800-30-10P	1590074	1GHz~18GHz	May 22, 2017	Feb. 11, 2018~ Mar. 20, 2018	May 21, 2018	Radiation (03CH11-HY)
Preamplifier	MITEQ	AMF-7D-0010 1800	2025787	1GHz~18GHz	Feb. 13,2017	Feb. 11, 2018~ Mar. 20, 2018	Feb. 12,2019	Radiation (03CH11-HY)
EMI Test Receiver	Agilent	N9038A (MXE)	MY532900 53	20Hz to 26.5GHz	Jan. 16, 2018	Feb. 11, 2018~ Mar. 20, 2018	Jan. 15, 2019	Radiation (03CH11-HY)
SHF-EHF Horn Antenna	SCHWARZBE CK	BBHA 9170	BBHA9170 584	18GHz- 40GHz	Nov. 27, 2017	Feb. 11, 2018~ Mar. 20, 2018	Nov. 26, 2018	Radiation (03CH11-HY)
Software	Audix	E3 6.2009-8- 24	RK-00104 2	NA	NA	Feb. 11, 2018~ Mar. 20, 2018	NA	Radiation (03CH11-HY)



5 Uncertainty of Evaluation

Uncertainty of Conducted Emission Measurement (150kHz ~ 30MHz)

Measuring Uncertainty for a Level of Confidence of 95% ($U = 2Uc(y)$)	2.7
-------------------------------------------------------------------------	-----

Uncertainty of Radiated Emission Measurement (30 MHz ~ 1000 MHz)

Measuring Uncertainty for a Level of Confidence of 95% ($U = 2Uc(y)$)	5.2
-------------------------------------------------------------------------	-----

Uncertainty of Radiated Emission Measurement (1000 MHz ~ 18000 MHz)

Measuring Uncertainty for a Level of Confidence of 95% ($U = 2Uc(y)$)	5.5
-------------------------------------------------------------------------	-----

Uncertainty of Radiated Emission Measurement (18000 MHz ~ 40000 MHz)

Measuring Uncertainty for a Level of Confidence of 95% ($U = 2Uc(y)$)	5.2
-------------------------------------------------------------------------	-----

Appendix A. Test Result of Conducted Test Items**<For CDD Mode>**

Test Engineer:	Kai Liao	Temperature:	21~25	°C
Test Date:	2018/03/09 ~ 2018/03/27	Relative Humidity:	51~54	%

TEST RESULTS DATA
26dB and 99% OBW

Band I																
Mod.	Data Rate	NTX	CH.	Freq. (MHz)	26 dB Bandwidth (MHz)				99% Bandwidth (MHz)				IC 99% Bandwidth EIRP Limit (dBm)			
					Ant 1	Ant 2	Ant 3	Ant 4	Ant 1	Ant 2	Ant 3	Ant 4	Ant 1	Ant 2	Ant 3	Ant 4
11a	6Mbps	1	36	5180	21.1				17.20				22.36			
11a	6Mbps	1	44	5220	39.45				18.30				22.62			
11a	6Mbps	1	48	5240	42.8				21.20				23.01			
VHT20	MCS0	1	36	5180	21.8				18.25				22.61			
VHT20	MCS0	1	44	5220	39.35				19.15				22.82			
VHT20	MCS0	1	48	5240	43.95				21.10				23.01			
VHT40	MCS0	1	38	5190	40.32				36.30				23.01			
VHT40	MCS0	1	46	5230	76.07				37.30				23.01			
VHT80	MCS0	1	42	5210	83.75				75.72				23.01			
11a	6Mbps	2	36	5180	21.1	20.80			17.10	17.20			22.33	22.36		
11a	6Mbps	2	44	5220	32.15	27.55			17.50	17.40			22.43	22.41		
11a	6Mbps	2	48	5240	43.35	36.90			19.85	17.85			22.98	22.52		
VHT20	MCS0	2	36	5180	22	21.60			18.30	18.25			22.62	22.61		
VHT20	MCS0	2	44	5220	36.1	32.45			18.90	18.65			22.76	22.71		
VHT20	MCS0	2	48	5240	45.85	37.90			22.25	19.55			23.01	22.91		
VHT40	MCS0	2	38	5190	40.5	40.50			36.30	36.20			23.01	23.01		
VHT40	MCS0	2	46	5230	58.87	46.50			36.40	36.40			23.01	23.01		
VHT80	MCS0	2	42	5210	88.1	82.88			75.72	75.72			23.01	23.01		

TEST RESULTS DATA
Average Power Table

FCC Band I															
Mod.	Data Rate	NTX	CH.	Freq. (MHz)	Ant	Average Conducted Power with duty factor (dBm)					FCC Power Limit (dBm)	DG (dBi)	FCC EIRP Power (dBm)	FCC EIRP Power Limit (dBm)	Pass/Fail
						Ant 1	Ant 2	Ant 3	Ant 4	SUM					
11a	6Mbps	1	36	5180	1	22.77				22.77	30.00	4.00	26.77	-	Pass
11a	6Mbps	1	44	5220	1	25.74				25.74	30.00	4.00	29.74	-	Pass
11a	6Mbps	1	48	5240	1	24.95				24.95	30.00	4.00	28.95	-	Pass
HT20	MCS0	1	36	5180	1	22.66				22.66	30.00	4.00	26.66	-	Pass
HT20	MCS0	1	44	5220	1	25.10				25.10	30.00	4.00	29.10	-	Pass
HT20	MCS0	1	48	5240	1	24.90				24.90	30.00	4.00	28.90	-	Pass
HT40	MCS0	1	38	5190	1	21.06				21.06	30.00	4.00	25.06	-	Pass
HT40	MCS0	1	46	5230	1	24.67				24.67	30.00	4.00	28.67	-	Pass
VHT20	MCS0	1	36	5180	1	23.08				23.08	30.00	4.00	27.08	-	Pass
VHT20	MCS0	1	44	5220	1	25.67				25.67	30.00	4.00	29.67	-	Pass
VHT20	MCS0	1	48	5240	1	24.91				24.91	30.00	4.00	28.91	-	Pass
VHT40	MCS0	1	38	5190	1	21.24				21.24	30.00	4.00	25.24	-	Pass
VHT40	MCS0	1	46	5230	1	24.96				24.96	30.00	4.00	28.96	-	Pass
VHT80	MCS0	1	42	5210	1	21.74				21.74	30.00	4.00	25.74	-	Pass
11a	6Mbps	2	36	5180	1+2	22.77	22.93			25.86	30.00	4.50	30.36	-	Pass
11a	6Mbps	2	44	5220	1+2	24.35	24.08			27.23	30.00	4.50	31.73	-	Pass
11a	6Mbps	2	48	5240	1+2	24.34	23.99			27.18	30.00	4.50	31.68	-	Pass
HT20	MCS0	2	36	5180	1+2	22.23	22.58			25.42	30.00	4.50	29.92	-	Pass
HT20	MCS0	2	44	5220	1+2	24.82	24.57			27.71	30.00	4.50	32.21	-	Pass
HT20	MCS0	2	48	5240	1+2	24.73	24.50			27.62	30.00	4.50	32.12	-	Pass
HT40	MCS0	2	38	5190	1+2	20.03	20.12			23.09	30.00	4.50	27.59	-	Pass
HT40	MCS0	2	46	5230	1+2	22.91	23.06			26.00	30.00	4.50	30.50	-	Pass
VHT20	MCS0	2	36	5180	1+2	22.95	22.99			25.98	30.00	4.50	30.48	-	Pass
VHT20	MCS0	2	44	5220	1+2	25.21	25.08			28.15	30.00	4.50	32.65	-	Pass
VHT20	MCS0	2	48	5240	1+2	25.13	24.92			28.03	30.00	4.50	32.53	-	Pass
VHT40	MCS0	2	38	5190	1+2	20.26	20.32			23.30	30.00	4.50	27.80	-	Pass
VHT40	MCS0	2	46	5230	1+2	23.26	23.32			26.30	30.00	4.50	30.80	-	Pass
VHT80	MCS0	2	42	5210	1+2	20.07	19.81			22.95	30.00	4.50	27.45	-	Pass

TEST RESULTS DATA
Power Spectral Density

FCC Band I														
Mod.	Data Rate	NTX	CH.	Freq. (MHz)	Ant	Duty Factor (dB)				Average PSD with Duty Factor (dBm/MHz)	PSD Limit (dBm/MHz)	DG (dBi)		Pass /Fail
						Ant 1	Ant 2	Ant 3	Ant 4					
11a	6Mbps	1	36	5180	1	0.17				10.36	17.00	4.00		Pass
11a	6Mbps	1	44	5220	1	0.17				13.77	17.00	4.00		Pass
11a	6Mbps	1	48	5240	1	0.17				13.03	17.00	4.00		Pass
VHT20	MCS0	1	36	5180	1	0.54				10.09	17.00	4.00		Pass
VHT20	MCS0	1	44	5220	1	0.54				13.55	17.00	4.00		Pass
VHT20	MCS0	1	48	5240	1	0.54				12.90	17.00	4.00		Pass
VHT40	MCS0	1	38	5190	1	1.06				6.15	17.00	4.00		Pass
VHT40	MCS0	1	46	5230	1	1.06				10.26	17.00	4.00		Pass
VHT80	MCS0	1	42	5210	1	0.82				3.58	17.00	4.00		Pass
11a	6Mbps	2	36	5180	1+2	0.17	0.17			13.74	15.74	7.26		Pass
11a	6Mbps	2	44	5220	1+2	0.17	0.17			15.37	15.74	7.26		Pass
11a	6Mbps	2	48	5240	1+2	0.17	0.17			15.24	15.74	7.26		Pass
VHT20	MCS0	2	36	5180	1+2	0.56	0.56			13.49	15.74	7.26		Pass
VHT20	MCS0	2	44	5220	1+2	0.56	0.56			15.71	15.74	7.26		Pass
VHT20	MCS0	2	48	5240	1+2	0.56	0.56			15.58	15.74	7.26		Pass
VHT40	MCS0	2	38	5190	1+2	1.06	1.06			8.24	15.74	7.26		Pass
VHT40	MCS0	2	46	5230	1+2	1.06	1.06			11.43	15.74	7.26		Pass
VHT80	MCS0	2	42	5210	1+2	0.81	0.81			5.13	15.74	7.26		Pass

<For TXBF Mode>

Test Engineer:	Kai Liao	Temperature:	21~25	°C
Test Date:	2018/03/29	Relative Humidity:	51~54	%

TEST RESULTS DATA
26dB and 99% OBW

Band I																
Mod.	Data Rate	NTX	CH.	Freq. (MHz)	26 dB Bandwidth (MHz)				99% Bandwidth (MHz)				IC 99% Bandwidth EIRP Limit (dBm)			
					Ant 1	Ant 2	Ant 3	Ant 4	Ant 1	Ant 2	Ant 3	Ant 4	Ant 1	Ant 2	Ant 3	Ant 4
VHT20	MCS0	2	36	5180	21.8	21.90			18.40	18.40			22.65	22.65		
VHT20	MCS0	2	44	5220	21.5	21.90			18.15	18.50			22.59	22.67		
VHT20	MCS0	2	48	5240	21.8	21.70			18.60	18.25			22.70	22.61		
VHT40	MCS0	2	38	5190	36.96	40.32			36.20	36.30			23.01	23.01		
VHT40	MCS0	2	46	5230	45.72	36.20			36.90	39.17			23.01	23.01		
VHT80	MCS0	2	42	5210	84.12	82.16			75.84	75.48			23.01	23.01		

TEST RESULTS DATA
Average Power Table

FCC Band I															
Mod.	Data Rate	NTX	CH.	Freq. (MHz)	Ant	Average Conducted Power with duty factor (dBm)					FCC Power Limit (dBm)	DG (dBi)	FCC EIRP Power (dBm)	FCC EIRP Power Limit (dBm)	Pass/Fail
						Ant 1	Ant 2	Ant 3	Ant 4	SUM					
HT20	MCS0	2	36	5180	1+2	21.50	21.60			24.56	28.74	7.26	31.82	-	Pass
HT20	MCS0	2	44	5220	1+2	21.10	20.90			24.01	28.74	7.26	31.28	-	Pass
HT20	MCS0	2	48	5240	1+2	21.10	20.90			24.01	28.74	7.26	31.28	-	Pass
HT40	MCS0	2	38	5190	1+2	20.80	20.80			23.81	28.74	7.26	31.07	-	Pass
HT40	MCS0	2	46	5230	1+2	21.10	21.20			24.16	28.74	7.26	31.42	-	Pass
VHT20	MCS0	2	36	5180	1+2	21.70	21.70			24.71	28.74	7.26	31.97	-	Pass
VHT20	MCS0	2	44	5220	1+2	21.30	21.10			24.21	28.74	7.26	31.48	-	Pass
VHT20	MCS0	2	48	5240	1+2	21.20	21.10			24.16	28.74	7.26	31.42	-	Pass
VHT40	MCS0	2	38	5190	1+2	21.00	21.20			24.11	28.74	7.26	31.38	-	Pass
VHT40	MCS0	2	46	5230	1+2	21.50	21.50			24.51	28.74	7.26	31.77	-	Pass
VHT80	MCS0	2	42	5210	1+2	20.10	20.30			23.21	28.74	7.26	30.48	-	Pass

TEST RESULTS DATA
Power Spectral Density

FCC Band I														
Mod.	Data Rate	NTX	CH.	Freq. (MHz)	Ant	Duty Factor (dB)				Average PSD with Duty Factor (dBm/MHz)	PSD Limit (dBm/MHz)	DG (dBi)		Pass /Fail
						Ant 1	Ant 2	Ant 3	Ant 4					
VHT20	MCS0	2	36	5180	1+2	0.00	0.00			15.332	15.74	7.26		Pass
VHT20	MCS0	2	44	5220	1+2	0.00	0.00			14.538	15.74	7.26		Pass
VHT20	MCS0	2	48	5240	1+2	0.00	0.00			15.63	15.74	7.26		Pass
VHT40	MCS0	2	38	5190	1+2	0.00	0.00			10.357	15.74	7.26		Pass
VHT40	MCS0	2	46	5230	1+2	0.00	0.00			10.961	15.74	7.26		Pass
VHT80	MCS0	2	42	5210	1+2	0.00	0.00			8.86	15.74	7.26		Pass



Appendix B. AC Conducted Emission Test Results

Test Engineer :	Shareef Yu	Temperature :	22~24°C
		Relative Humidity :	58~62%

EUT Information

Report NO : 811726
 Test Mode : Mode 1
 Test Voltage : 120Vac/60Hz
 Phase : Line

Full Spectrum

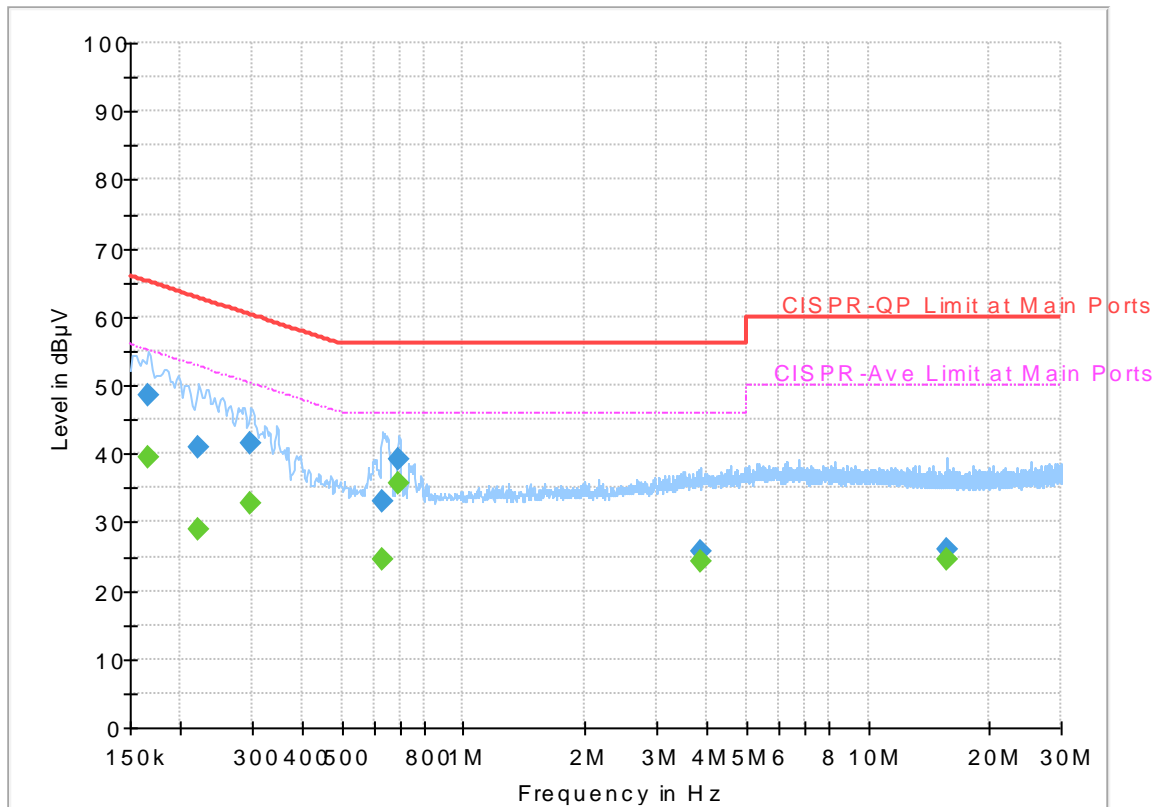

Final_Result

Frequency (MHz)	QuasiPeak (dBµV)	Average (dBµV)	Limit (dBµV)	Margin (dB)	Line	Filter	Corr. (dB)
0.165750	48.49	---	65.17	16.68	L1	OFF	19.5
0.165750	---	39.49	55.17	15.68	L1	OFF	19.5
0.222000	40.84	---	62.74	21.90	L1	OFF	19.5
0.222000	---	28.85	52.74	23.89	L1	OFF	19.5
0.298500	41.54	---	60.28	18.74	L1	OFF	19.5
0.298500	---	32.70	50.28	17.58	L1	OFF	19.5
0.633750	32.91	---	56.00	23.09	L1	OFF	19.5
0.633750	---	24.52	46.00	21.48	L1	OFF	19.5
0.692250	39.32	---	56.00	16.68	L1	OFF	19.5
0.692250	---	35.54	46.00	10.46	L1	OFF	19.5
3.864750	25.71	---	56.00	30.29	L1	OFF	19.6
3.864750	---	24.29	46.00	21.71	L1	OFF	19.6
15.609750	26.16	---	60.00	33.84	L1	OFF	19.8
15.609750	---	24.57	50.00	25.43	L1	OFF	19.8

EUT Information

Report NO : 811726
 Test Mode : Mode 1
 Test Voltage : 120Vac/60Hz
 Phase : Neutral

Full Spectrum

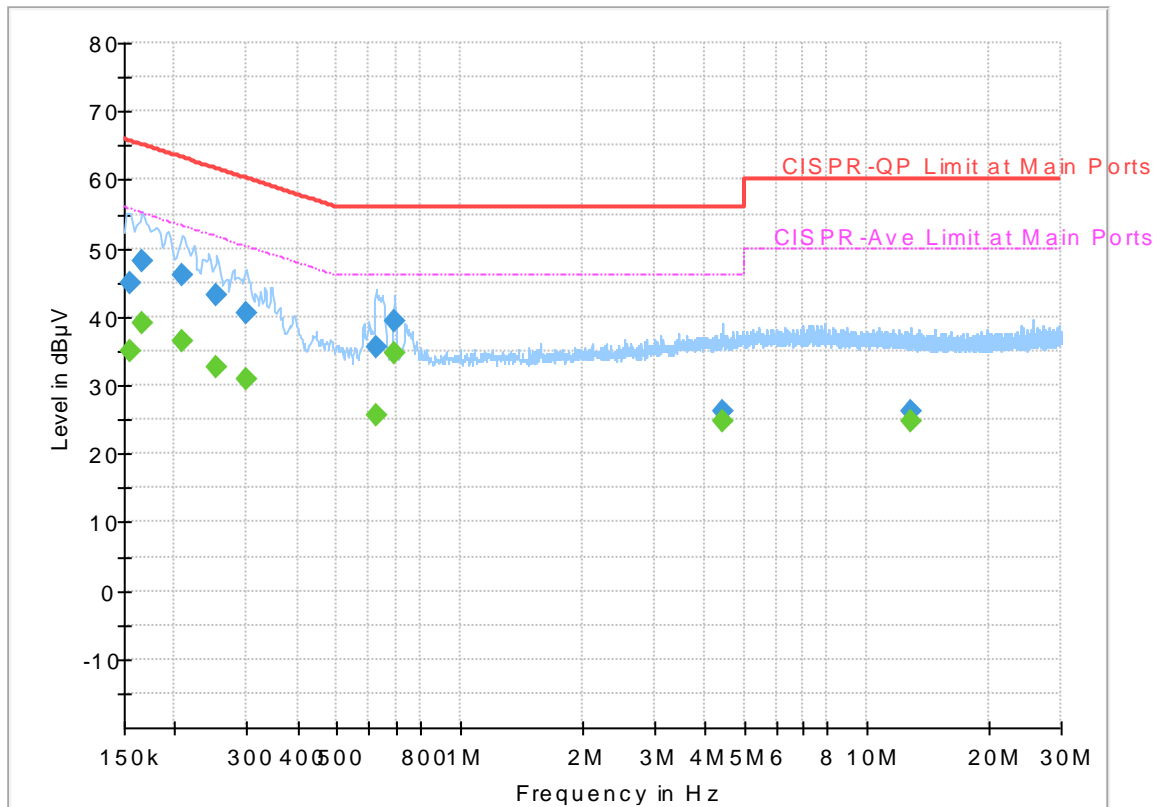

Final_Result

Frequency (MHz)	QuasiPeak (dBµV)	Average (dBµV)	Limit (dBµV)	Margin (dB)	Line	Filter	Corr. (dB)
0.154500	44.98	---	65.75	20.77	N	OFF	19.5
0.154500	---	35.02	55.75	20.73	N	OFF	19.5
0.165750	48.03	---	65.17	17.14	N	OFF	19.5
0.165750	---	38.98	55.17	16.19	N	OFF	19.5
0.208500	45.95	---	63.27	17.32	N	OFF	19.5
0.208500	---	36.56	53.27	16.71	N	OFF	19.5
0.253500	43.10	---	61.64	18.54	N	OFF	19.5
0.253500	---	32.70	51.64	18.94	N	OFF	19.5
0.298500	40.41	---	60.28	19.87	N	OFF	19.5
0.298500	---	31.00	50.28	19.28	N	OFF	19.5
0.624750	35.63	---	56.00	20.37	N	OFF	19.5
0.624750	---	25.62	46.00	20.38	N	OFF	19.5
0.690000	39.34	---	56.00	16.66	N	OFF	19.5
0.690000	---	34.68	46.00	11.32	N	OFF	19.5
4.418250	26.14	---	56.00	29.86	N	OFF	19.6
4.418250	---	24.69	46.00	21.31	N	OFF	19.6
12.808500	26.24	---	60.00	33.76	N	OFF	19.8
12.808500	---	24.76	50.00	25.24	N	OFF	19.8



Appendix C. Radiated Spurious Emission

Test Engineer :	Hao Hsu, Jacky Hung and KenWu	Temperature :	22~25°C
		Relative Humidity :	52~57%

<Single Mode>

Band 1 - 5150~5250MHz
WIFI 802.11a (Band Edge @ 3m)

WIFI Ant.	Note	Frequency (MHz)	Level (dBμV/m)	Over Limit (dB)	Limit Line (dBμV/m)	Read Level (dBμV)	Antenna Factor (dB/m)	Path Loss (dB)	Preamp Factor (dB)	Ant Pos (cm)	Table Pos (deg)	Peak Avg. (P/A)	Pol. (H/V)	
802.11a CH 36 5180MHz		5148.46	55.74	-18.26	74	47.97	31.75	9.05	33.03	388	161	P	H	
		5150	47.35	-6.65	54	39.58	31.75	9.05	33.03	388	161	A	H	
	*	5180	110.57	-	-	102.75	31.78	9.07	33.03	388	161	P	H	
	*	5180	101.05	-	-	93.23	31.78	9.07	33.03	388	161	A	H	
													H	
														H
			5149.5	61.04	-12.96	74	53.27	31.75	9.05	33.03	100	171	P	V
			5150	52.61	-1.39	54	44.84	31.75	9.05	33.03	100	171	A	V
	*		5180	116.12	-	-	108.3	31.78	9.07	33.03	100	171	P	V
	*		5180	106.52	-	-	98.7	31.78	9.07	33.03	100	171	A	V
802.11a CH 44 5220MHz		5129.48	50.14	-23.86	74	42.41	31.73	9.03	33.03	100	159	P	H	
		5150	40.83	-13.17	54	33.06	31.75	9.05	33.03	100	159	A	H	
	*	5220	111.38	-	-	103.48	31.82	9.11	33.03	100	159	P	H	
	*	5220	101.97	-	-	94.07	31.82	9.11	33.03	100	159	A	H	
			5418.24	47.71	-26.29	74	39.49	32.02	9.22	33.02	100	159	P	H
			5452.32	39.14	-14.86	54	30.82	32.05	9.29	33.02	100	159	A	H
			5072.54	50.62	-23.38	74	42.99	31.68	8.99	33.04	249	227	P	V
			5135.98	42.37	-11.63	54	34.62	31.73	9.05	33.03	249	227	A	V
	*		5220	119.2	-	-	111.3	31.82	9.11	33.03	249	227	P	V
	*		5220	109.81	-	-	101.91	31.82	9.11	33.03	249	227	A	V
			5419.68	47.18	-26.82	74	38.92	32.02	9.26	33.02	249	227	P	V
			5350.08	39.12	-14.88	54	31.01	31.95	9.19	33.03	249	227	A	V



802.11a CH 48 5240MHz		5060.84	48.44	-25.56	74	40.82	31.67	8.99	33.04	104	215	P	H
		5085.8	40.12	-13.88	54	32.47	31.68	9.01	33.04	104	215	A	H
	*	5240	112.43	-	-	104.51	31.83	9.12	33.03	104	215	P	H
	*	5240	102.78	-	-	94.86	31.83	9.12	33.03	104	215	A	H
		5369.28	48.29	-25.71	74	40.15	31.97	9.2	33.03	104	215	P	H
		5352.72	39.15	-14.85	54	31.04	31.95	9.19	33.03	104	215	A	H
		5117.26	50.55	-23.45	74	42.84	31.72	9.03	33.04	248	229	P	V
		5135.98	42.21	-11.79	54	34.46	31.73	9.05	33.03	248	229	A	V
	*	5240	118.22	-	-	110.3	31.83	9.12	33.03	248	229	P	V
	*	5240	108.9	-	-	100.98	31.83	9.12	33.03	248	229	A	V
		5415.36	47.36	-26.64	74	39.14	32.02	9.22	33.02	248	229	P	V
		5352.96	38.98	-15.02	54	30.87	31.95	9.19	33.03	248	229	A	V
Remark	<ol style="list-style-type: none"> 1. No other spurious found. 2. All results are PASS against Peak and Average limit line. 												



Band 1 5150~5250MHz
WIFI 802.11a (Harmonic @ 3m)

WIFI Ant. 1	Note	Frequency (MHz)	Level (dBμV/m)	Over Limit (dB)	Limit Line (dBμV/m)	Read Level (dBμV)	Antenna Factor (dB/m)	Path Loss (dB)	Preamp Factor (dB)	Ant Pos (cm)	Table Pos (deg)	Peak Avg. (P/A)	Pol. (H/V)
802.11a CH 36 5180MHz		10360	47.18	-21.02	68.2	57.93	39.51	14.94	65.2	100	0	P	H
		15540	58.23	-15.77	74	65.87	38	18.34	63.98	220	93	P	H
		15540	42.01	-11.99	54	49.65	38	18.34	63.98	220	93	A	H
													H
		10360	49.69	-18.51	68.2	60.44	39.51	14.94	65.2	100	0	P	V
		15540	61.87	-12.13	74	69.51	38	18.34	63.98	210	281	P	V
		15540	45.61	-8.39	54	53.25	38	18.34	63.98	210	281	A	V
													V
802.11a CH 44 5220MHz		10440	44.17	-24.03	68.2	54.77	39.61	14.99	65.2	100	0	P	H
		15660	66.07	-7.93	74	74.23	37.67	18.41	64.24	224	84	P	H
		15660	51.82	-2.18	54	59.98	37.67	18.41	64.24	224	84	A	H
													H
		10440	46.69	-21.51	68.2	57.29	39.61	14.99	65.2	100	0	P	V
		15660	58.47	-15.53	74	66.63	37.67	18.41	64.24	100	283	P	V
		15660	44.83	-9.17	54	52.99	37.67	18.41	64.24	100	283	A	V
													V
802.11a CH 48 5240MHz		10480	46.37	-21.83	68.2	56.86	39.68	15.03	65.2	100	0	P	H
		15720	64.62	-9.38	74	73.11	37.47	18.43	64.39	228	62	P	H
		15720	51.05	-2.95	54	59.54	37.47	18.43	64.39	228	62	A	H
													H
		10480	48.21	-19.99	68.2	58.7	39.68	15.03	65.2	100	0	P	V
		15720	58.75	-15.25	74	67.24	37.47	18.43	64.39	193	60	P	V
		15720	45.06	-8.94	54	53.55	37.47	18.43	64.39	193	60	A	V
													V
Remark	1. No other spurious found. 2. All results are PASS against Peak and Average limit line.												



Band 1 5150~5250MHz
WIFI 802.11ac VHT20 (Band Edge @ 3m)

WIFI Ant. 1	Note	Frequency (MHz)	Level (dBμV/m)	Over Limit (dB)	Limit Line (dBμV/m)	Read Level (dBμV)	Antenna Factor (dB/m)	Path Loss (dB)	Preamp Factor (dB)	Ant Pos (cm)	Table Pos (deg)	Peak Avg. (P/A)	Pol. (H/V)	
802.11ac VHT20 CH 36 5180MHz		5149.76	54.62	-19.38	74	46.85	31.75	9.05	33.03	389	158	P	H	
		5150	46.39	-7.61	54	38.62	31.75	9.05	33.03	389	158	A	H	
	*	5180	110.67	-	-	102.85	31.78	9.07	33.03	389	158	P	H	
	*	5180	100.47	-	-	92.65	31.78	9.07	33.03	389	158	A	H	
													H	
														H
			5148.98	58.77	-15.23	74	51	31.75	9.05	33.03	100	172	P	V
			5149.5	51.16	-2.84	54	43.39	31.75	9.05	33.03	100	172	A	V
		*	5180	116.18	-	-	108.36	31.78	9.07	33.03	100	172	P	V
		*	5180	105.97	-	-	98.15	31.78	9.07	33.03	100	172	A	V
													V	
													V	
802.11ac VHT20 CH 44 5220MHz		5138.06	48.65	-25.35	74	40.9	31.73	9.05	33.03	100	210	P	H	
		5097.24	39.74	-14.26	54	32.07	31.7	9.01	33.04	100	210	A	H	
		* 5220	113.92	-	-	106.02	31.82	9.11	33.03	100	210	P	H	
		* 5220	103.86	-	-	95.96	31.82	9.11	33.03	100	210	A	H	
			5351.28	48.4	-25.6	74	40.29	31.95	9.19	33.03	100	210	P	H
			5350.08	39.08	-14.92	54	30.97	31.95	9.19	33.03	100	210	A	H
			5111.02	50.11	-23.89	74	42.4	31.72	9.03	33.04	105	187	P	V
			5149.76	41.97	-12.03	54	34.2	31.75	9.05	33.03	105	187	A	V
		*	5220	118.68	-	-	110.78	31.82	9.11	33.03	105	187	P	V
		*	5220	108.72	-	-	100.82	31.82	9.11	33.03	105	187	A	V
		5455.92	48.97	-25.03	74	40.65	32.05	9.29	33.02	105	187	P	V	
		5352.24	39.38	-14.62	54	31.27	31.95	9.19	33.03	105	187	A	V	



802.11ac VHT20 CH 48 5240MHz		5074.1	49.62	-24.38	74	41.99	31.68	8.99	33.04	100	210	P	H
		5073.06	39.75	-14.25	54	32.12	31.68	8.99	33.04	100	210	A	H
	*	5240	113.68	-	-	105.76	31.83	9.12	33.03	100	210	P	H
	*	5240	103.77	-	-	95.85	31.83	9.12	33.03	100	210	A	H
		5373.12	48.03	-25.97	74	39.89	31.97	9.2	33.03	100	210	P	H
		5356.32	39.17	-14.83	54	31.06	31.95	9.19	33.03	100	210	A	H
		5102.44	53.54	-20.46	74	45.87	31.7	9.01	33.04	100	177	P	V
		5135.98	41.82	-12.18	54	34.07	31.73	9.05	33.03	100	177	A	V
	*	5240	119	-	-	111.08	31.83	9.12	33.03	100	177	P	V
	*	5240	109.16	-	-	101.24	31.83	9.12	33.03	100	177	A	V
		5376	48.41	-25.59	74	40.26	31.97	9.2	33.02	100	177	P	V
		5350.08	39.49	-14.51	54	31.38	31.95	9.19	33.03	100	177	A	V
Remark	1. No other spurious found. 2. All results are PASS against Peak and Average limit line.												



Band 1 5150~5250MHz
WIFI 802.11ac VHT20 (Harmonic @ 3m)

WIFI Ant. 1	Note	Frequency (MHz)	Level (dBμV/m)	Over Limit (dB)	Limit Line (dBμV/m)	Read Level (dBμV)	Antenna Factor (dB/m)	Path Loss (dB)	Preamp Factor (dB)	Ant Pos (cm)	Table Pos (deg)	Peak Avg. (P/A)	Pol. (H/V)	
802.11ac VHT20 CH 36 5180MHz		10360	45.95	-22.25	68.2	56.7	39.51	14.94	65.2	100	0	P	H	
		15540	49.77	-24.23	74	57.41	38	18.34	63.98	100	0	P	H	
													H	
													H	
			10360	46.89	-21.31	68.2	57.64	39.51	14.94	65.2	100	0	P	V
			15540	60.76	-13.24	74	68.4	38	18.34	63.98	211	278	P	V
			15540	43.27	-10.73	54	50.91	38	18.34	63.98	211	278	A	V
802.11ac VHT20 CH 44 5220MHz		10440	45.27	-22.93	68.2	55.87	39.61	14.99	65.2	100	0	P	H	
		15660	66.84	-7.16	74	75	37.67	18.41	64.24	224	92	P	H	
		15660	51.39	-2.61	54	59.55	37.67	18.41	64.24	224	92	A	H	
													H	
			10440	47.34	-20.86	68.2	57.94	39.61	14.99	65.2	100	0	P	V
			15660	62.39	-11.61	74	70.55	37.67	18.41	64.24	211	286	P	V
			15660	47.34	-6.66	54	55.5	37.67	18.41	64.24	211	286	A	V
802.11ac VHT20 CH 48 5240MHz		10480	45.86	-22.34	68.2	56.35	39.68	15.03	65.2	100	0	P	H	
		15720	66.51	-7.49	74	75	37.47	18.43	64.39	181	27	P	H	
		15720	52.24	-1.76	54	60.73	37.47	18.43	64.39	181	27	A	H	
													H	
			10480	50.09	-18.11	68.2	60.58	39.68	15.03	65.2	100	0	P	V
			15720	60.71	-13.29	74	69.2	37.47	18.43	64.39	100	183	P	V
			15720	44.91	-9.09	54	53.4	37.47	18.43	64.39	100	183	A	V
													V	
Remark	1. No other spurious found. 2. All results are PASS against Peak and Average limit line.													



Band 1 5150~5250MHz
WIFI 802.11ac VHT40 (Band Edge @ 3m)

WIFI Ant. 1	Note	Frequency (MHz)	Level (dBμV/m)	Over Limit (dB)	Limit Line (dBμV/m)	Read Level (dBμV)	Antenna Factor (dB/m)	Path Loss (dB)	Preamp Factor (dB)	Ant Pos (cm)	Table Pos (deg)	Peak Avg. (P/A)	Pol. (H/V)
802.11ac VHT40 CH 38 5190MHz		5145.34	52.5	-21.5	74	44.73	31.75	9.05	33.03	102	161	P	H
		5150	46.63	-7.37	54	38.86	31.75	9.05	33.03	102	161	A	H
	*	5190	104.05	-	-	96.21	31.78	9.09	33.03	102	161	P	H
	*	5190	95.02	-	-	87.18	31.78	9.09	33.03	102	161	A	H
		5411.84	47.18	-26.82	74	38.96	32.02	9.22	33.02	102	161	P	H
		5456.92	39.1	-14.9	54	30.78	32.05	9.29	33.02	102	161	A	H
		5150	57.08	-16.92	74	49.31	31.75	9.05	33.03	247	208	P	V
		5149.5	50.2	-3.8	54	42.43	31.75	9.05	33.03	247	208	A	V
	*	5190	111.26	-	-	103.42	31.78	9.09	33.03	247	208	P	V
	*	5190	101.92	-	-	94.08	31.78	9.09	33.03	247	208	A	V
		5432.28	48.36	-25.64	74	40.09	32.03	9.26	33.02	247	208	P	V
		5438.44	38.95	-15.05	54	30.68	32.03	9.26	33.02	247	208	A	V
	802.11ac VHT40 CH 46 5230MHz		5112.84	49.4	-24.6	74	41.69	31.72	9.03	33.04	111	215	P
		5149.76	40.89	-13.11	54	33.12	31.75	9.05	33.03	111	215	A	H
*		5230	108.81	-	-	100.9	31.83	9.11	33.03	111	215	P	H
*		5230	99.54	-	-	91.63	31.83	9.11	33.03	111	215	A	H
		5400.72	47.48	-26.52	74	39.28	32	9.22	33.02	111	215	P	H
		5350.32	39.45	-14.55	54	31.34	31.95	9.19	33.03	111	215	A	H
		5142.74	59.28	-14.72	74	51.51	31.75	9.05	33.03	248	226	P	V
		5147.94	50.71	-3.29	54	42.94	31.75	9.05	33.03	248	226	A	V
*		5230	115.34	-	-	107.43	31.83	9.11	33.03	248	226	P	V
*		5230	105.5	-	-	97.59	31.83	9.11	33.03	248	226	A	V
	5436.48	47.72	-26.28	74	39.45	32.03	9.26	33.02	248	226	P	V	
	5350.56	40	-14	54	31.89	31.95	9.19	33.03	248	226	A	V	
Remark	1. No other spurious found. 2. All results are PASS against Peak and Average limit line.												



Band 1 5150~5250MHz
WIFI 802.11ac VHT40 (Harmonic @ 3m)

WIFI Ant. 1	Note	Frequency (MHz)	Level (dBμV/m)	Over Limit (dB)	Limit Line (dBμV/m)	Read Level (dBμV)	Antenna Factor (dB/m)	Path Loss (dB)	Preamp Factor (dB)	Ant Pos (cm)	Table Pos (deg)	Peak Avg. (P/A)	Pol. (H/V)	
802.11ac VHT40 CH 38 5190MHz		10380	44.45	-23.75	68.2	55.16	39.54	14.95	65.2	100	0	P	H	
		15570	44.37	-29.63	74	52.15	37.91	18.36	64.05	100	0	P	H	
													H	
													H	
			10380	46.34	-21.86	68.2	57.05	39.54	14.95	65.2	100	0	P	V
			15570	44.15	-29.85	74	51.93	37.91	18.36	64.05	100	0	P	V
														V
802.11ac VHT40 CH 46 5230MHz		10460	44.98	-23.22	68.2	55.55	39.63	15	65.2	100	0	P	H	
		15690	58.13	-15.87	74	66.47	37.57	18.41	64.32	224	92	P	H	
		15690	46.36	-7.64	54	54.7	37.57	18.41	64.32	224	92	A	H	
													H	
			10460	45.85	-22.35	68.2	56.42	39.63	15	65.2	100	0	P	V
			15690	53.24	-20.76	74	61.58	37.57	18.41	64.32	100	182	P	V
			15690	41.68	-12.32	54	50.02	37.57	18.41	64.32	100	182	A	V
													V	
Remark	1. No other spurious found. 2. All results are PASS against Peak and Average limit line.													



Band 1 5150~5250MHz
WIFI 802.11ac VHT80 (Band Edge @ 3m)

WIFI Ant. 1	Note	Frequency (MHz)	Level (dBμV/m)	Over Limit (dB)	Limit Line (dBμV/m)	Read Level (dBμV)	Antenna Factor (dB/m)	Path Loss (dB)	Preamp Factor (dB)	Ant Pos (cm)	Table Pos (deg)	Peak Avg. (P/A)	Pol. (H/V)
802.11ac VHT80 CH 42 5210MHz		5148.46	54.7	-19.3	74	46.93	31.75	9.05	33.03	104	214	P	H
		5146.64	41.24	-12.76	54	33.47	31.75	9.05	33.03	104	214	A	H
	*	5210	101.46	-	-	93.58	31.82	9.09	33.03	104	214	P	H
	*	5210	92.13	-	-	84.25	31.82	9.09	33.03	104	214	A	H
		5430	47.64	-26.36	74	39.37	32.03	9.26	33.02	104	214	P	H
		5354.16	39.39	-14.61	54	31.28	31.95	9.19	33.03	104	214	A	H
		5148.2	58.95	-15.05	74	51.18	31.75	9.05	33.03	248	228	P	V
		5145.6	51.54	-2.46	54	43.77	31.75	9.05	33.03	248	228	A	V
	*	5210	108.06	-	-	100.18	31.82	9.09	33.03	248	228	P	V
	*	5210	99.15	-	-	91.27	31.82	9.09	33.03	248	228	A	V
		5396.16	48.34	-25.66	74	40.14	32	9.22	33.02	248	228	P	V
	5351.28	39.85	-14.15	54	31.74	31.95	9.19	33.03	248	228	A	V	
Remark	1. No other spurious found. 2. All results are PASS against Peak and Average limit line.												



Band 1 5150~5250MHz
WIFI 802.11ac VHT80 (Harmonic @ 3m)

WIFI Ant. 1	Note	Frequency (MHz)	Level (dBμV/m)	Over Limit (dB)	Limit Line (dBμV/m)	Read Level (dBμV)	Antenna Factor (dB/m)	Path Loss (dB)	Preamp Factor (dB)	Ant Pos (cm)	Table Pos (deg)	Peak Avg. (P/A)	Pol. (H/V)	
802.11ac VHT80 CH 42 5210MHz		10420	44.28	-23.92	68.2	54.92	39.58	14.98	65.2	100	0	P	H	
		15630	44.48	-29.52	74	52.58	37.71	18.39	64.2	100	0	P	H	
													H	
													H	
			10420	43.63	-24.57	68.2	54.27	39.58	14.98	65.2	100	0	P	V
			15630	43.53	-30.47	74	51.63	37.71	18.39	64.2	100	0	P	V
														V
Remark	1. No other spurious found.													
	2. All results are PASS against Peak and Average limit line.													



Emission below 1GHz

WIFI 802.11a (LF @ 3m)

WIFI	Note	Frequency	Level	Over	Limit	Read	Antenna	Path	Preamp	Ant	Table	Peak	Pol.	
Ant.				Limit	Line	Level	Factor	Loss	Factor	Pos	Pos	Avg.		
1		(MHz)	(dBμV/m)	(dB)	(dBμV/m)	(dBμV)	(dB/m)	(dB)	(dB)	(cm)	(deg)	(P/A)	(H/V)	
802.11a LF		46.47	28.63	-11.37	40	44.38	15.72	1.02	32.49	100	0	P	H	
		131.52	28.16	-15.34	43.5	41.77	17.28	1.51	32.45	-	-	P	H	
		180.66	26.12	-17.38	43.5	42	14.75	1.69	32.41	-	-	P	H	
		738.9	32.94	-13.06	46	34.09	27.68	3.4	32.36	-	-	P	H	
		885.9	34.6	-11.4	46	33.37	29.07	3.73	31.73	-	-	P	H	
		926.5	33.23	-12.77	46	31.11	29.55	3.82	31.42	-	-	P	H	
														H
														H
														H
														H
														H
														H
			40.53	32	-8	40	44.98	18.68	0.82	32.49	-	-	P	V
			45.93	33.13	-6.87	40	48.46	16.14	1.02	32.49	100	0	P	V
			53.49	29.32	-10.68	40	47.8	12.98	1.02	32.49	-	-	P	V
			696.9	27.93	-18.07	46	30.53	26.39	3.35	32.47	-	-	P	V
			746.6	36.68	-9.32	46	37.66	27.78	3.44	32.33	-	-	P	V
			940.5	32.89	-13.11	46	30.09	30.1	3.82	31.29	-	-	P	V
													V	
													V	
													V	
													V	
													V	
													V	
Remark	1. No other spurious found. 2. All results are PASS against limit line.													



<CDD Mode>

Band 1 - 5150~5250MHz
WIFI 802.11a (Band Edge @ 3m)

WIFI Ant.	Note	Frequency	Level	Over Limit	Limit Line	Read Level	Antenna Factor	Path Loss	Preamp Factor	Ant Pos	Table Pos	Peak Avg.	Pol.	
1+2		(MHz)	(dBμV/m)	(dB)	(dBμV/m)	(dBμV)	(dB/m)	(dB)	(dB)	(cm)	(deg)	(P/A)	(H/V)	
802.11a CH 36 5180MHz		5150	55.87	-18.13	74	48.1	31.75	9.05	33.03	348	160	P	H	
		5150	49.23	-4.77	54	41.46	31.75	9.05	33.03	348	160	A	H	
	*	5180	114.63	-	-	106.81	31.78	9.07	33.03	348	160	P	H	
	*	5180	105.47	-	-	97.65	31.78	9.07	33.03	348	160	A	H	
													H	
													H	
			5149.76	58.9	-15.1	74	51.13	31.75	9.05	33.03	123	162	P	V
			5149.5	52.88	-1.12	54	45.11	31.75	9.05	33.03	123	162	A	V
	*		5180	118.71	-	-	110.89	31.78	9.07	33.03	123	162	P	V
	*		5180	109.41	-	-	101.59	31.78	9.07	33.03	123	162	A	V
													V	
													V	
802.11a CH 44 5220MHz		5089.7	50.7	-23.3	74	43.03	31.7	9.01	33.04	384	155	P	H	
		5119.86	41.62	-12.38	54	33.9	31.72	9.03	33.03	384	155	A	H	
	*	5220	116.44	-	-	108.54	31.82	9.11	33.03	384	155	P	H	
	*	5220	107.79	-	-	99.89	31.82	9.11	33.03	384	155	A	H	
			5370.72	48.97	-25.03	74	40.83	31.97	9.2	33.03	384	155	P	H
			5445.36	39.58	-14.42	54	31.28	32.03	9.29	33.02	384	155	A	H
			5082.42	53.22	-20.78	74	45.57	31.68	9.01	33.04	246	172	P	V
			5150	43.69	-10.31	54	35.92	31.75	9.05	33.03	246	172	A	V
	*		5220	122.15	-	-	114.25	31.82	9.11	33.03	246	172	P	V
	*		5220	113.08	-	-	105.18	31.82	9.11	33.03	246	172	A	V
			5442.72	48.71	-25.29	74	40.44	32.03	9.26	33.02	246	172	P	V
			5351.28	39.84	-14.16	54	31.73	31.95	9.19	33.03	246	172	A	V



802.11a CH 48 5240MHz		5114.92	51.49	-22.51	74	43.78	31.72	9.03	33.04	386	140	P	H
		5148.72	42.17	-11.83	54	34.4	31.75	9.05	33.03	386	140	A	H
	*	5240	117.34	-	-	109.42	31.83	9.12	33.03	386	140	P	H
	*	5240	107.85	-	-	99.93	31.83	9.12	33.03	386	140	A	H
		5415.12	48.37	-25.63	74	40.15	32.02	9.22	33.02	386	140	P	H
		5350.32	39.85	-14.15	54	31.74	31.95	9.19	33.03	386	140	A	H
		5134.16	54.25	-19.75	74	46.5	31.73	9.05	33.03	243	172	P	V
		5149.5	44.29	-9.71	54	36.52	31.75	9.05	33.03	243	172	A	V
	*	5240	122.7	-	-	114.78	31.83	9.12	33.03	243	172	P	V
	*	5240	113.38	-	-	105.46	31.83	9.12	33.03	243	172	A	V
		5392.8	48.1	-25.9	74	39.94	31.98	9.2	33.02	243	172	P	V
		5350.32	40.79	-13.21	54	32.68	31.95	9.19	33.03	243	172	A	V
Remark	3. No other spurious found. 4. All results are PASS against Peak and Average limit line.												



Band 1 5150~5250MHz
WIFI 802.11a (Harmonic @ 3m)

WIFI Ant. 1+2	Note	Frequency (MHz)	Level (dBμV/m)	Over Limit (dB)	Limit Line (dBμV/m)	Read Level (dBμV)	Antenna Factor (dB/m)	Path Loss (dB)	Preamp Factor (dB)	Ant Pos (cm)	Table Pos (deg)	Peak Avg. (P/A)	Pol. (H/V)	
802.11a CH 36 5180MHz		10360	46.63	-21.57	68.2	57.38	39.51	14.94	65.2	100	0	P	H	
		15540	55.5	-18.5	74	63.14	38	18.34	63.98	100	181	P	H	
		15540	39.97	-14.03	54	47.61	38	18.34	63.98	100	181	A	H	
													H	
			10360	48.81	-19.39	68.2	59.56	39.51	14.94	65.2	100	0	P	V
			15540	59.51	-14.49	74	67.15	38	18.34	63.98	211	252	P	V
			15540	43.43	-10.57	54	51.07	38	18.34	63.98	211	252	A	V
802.11a CH 44 5220MHz		10440	46.38	-21.82	68.2	56.98	39.61	14.99	65.2	100	0	P	H	
		15660	62.65	-11.35	74	70.81	37.67	18.41	64.24	226	87	P	H	
		15660	50.01	-3.99	54	58.17	37.67	18.41	64.24	226	87	A	H	
													H	
			10440	49.22	-18.98	68.2	59.82	39.61	14.99	65.2	100	0	P	V
			15660	61.11	-12.89	74	69.27	37.67	18.41	64.24	400	177	P	V
			15660	47.05	-6.95	54	55.21	37.67	18.41	64.24	400	177	A	V
802.11a CH 48 5240MHz		10480	48.53	-19.67	68.2	59.02	39.68	15.03	65.2	100	0	P	H	
		15720	63.71	-10.29	74	72.2	37.47	18.43	64.39	149	22	P	H	
		15720	51.03	-2.97	54	59.52	37.47	18.43	64.39	149	22	A	H	
													H	
			10480	52.86	-15.34	68.2	63.35	39.68	15.03	65.2	100	0	P	V
			15720	60.53	-13.47	74	69.02	37.47	18.43	64.39	100	182	P	V
			15720	48.04	-5.96	54	56.53	37.47	18.43	64.39	100	182	A	V
													V	
Remark	3. No other spurious found. 4. All results are PASS against Peak and Average limit line.													



Band 1 5150~5250MHz
WIFI 802.11ac VHT20 (Band Edge @ 3m)

WIFI Ant. 1+2	Note	Frequency (MHz)	Level (dBμV/m)	Over Limit (dB)	Limit Line (dBμV/m)	Read Level (dBμV)	Antenna Factor (dB/m)	Path Loss (dB)	Preamp Factor (dB)	Ant Pos (cm)	Table Pos (deg)	Peak Avg. (P/A)	Pol. (H/V)	
802.11ac VHT20 CH 36 5180MHz		5147.42	53.36	-20.64	74	45.59	31.75	9.05	33.03	350	161	P	H	
		5146.12	44.75	-9.25	54	36.98	31.75	9.05	33.03	350	161	A	H	
	*	5180	115	-	-	107.18	31.78	9.07	33.03	350	161	P	H	
	*	5180	105.21	-	-	97.39	31.78	9.07	33.03	350	161	A	H	
													H	
														H
			5150	56.11	-17.89	74	48.34	31.75	9.05	33.03	247	174	P	V
			5150	49.5	-4.5	54	41.73	31.75	9.05	33.03	247	174	A	V
		*	5180	119.77	-	-	111.95	31.78	9.07	33.03	247	174	P	V
		*	5180	109.72	-	-	101.9	31.78	9.07	33.03	247	174	A	V
													V	
													V	
802.11ac VHT20 CH 44 5220MHz		5150	51.37	-22.63	74	43.6	31.75	9.05	33.03	384	150	P	H	
		5150	43.58	-10.42	54	35.81	31.75	9.05	33.03	384	150	A	H	
		*	5220	118.35	-	-	110.45	31.82	9.11	33.03	384	150	P	H
		*	5220	108.46	-	-	100.56	31.82	9.11	33.03	384	150	A	H
			5429.76	47.8	-26.2	74	39.53	32.03	9.26	33.02	384	150	P	H
			5459.28	39.16	-14.84	54	30.84	32.05	9.29	33.02	384	150	A	H
			5149.5	54.6	-19.4	74	46.83	31.75	9.05	33.03	246	170	P	V
			5150	46.7	-7.3	54	38.93	31.75	9.05	33.03	246	170	A	V
		*	5220	123.51	-	-	115.61	31.82	9.11	33.03	246	170	P	V
		*	5220	113.91	-	-	106.01	31.82	9.11	33.03	246	170	A	V
		5358.24	48.15	-25.85	74	40.04	31.95	9.19	33.03	246	170	P	V	
		5350.8	39.12	-14.88	54	31.01	31.95	9.19	33.03	246	170	A	V	



802.11ac VHT20 CH 48 5240MHz		5115.18	50.74	-23.26	74	43.03	31.72	9.03	33.04	362	149	P	H
		5150	41.03	-12.97	54	33.26	31.75	9.05	33.03	362	149	A	H
	*	5240	117.7	-	-	109.78	31.83	9.12	33.03	362	149	P	H
	*	5240	108.2	-	-	100.28	31.83	9.12	33.03	362	149	A	H
		5373.12	48.19	-25.81	74	40.05	31.97	9.2	33.03	362	149	P	H
		5355.36	39.38	-14.62	54	31.27	31.95	9.19	33.03	362	149	A	H
		5140.92	51.56	-22.44	74	43.79	31.75	9.05	33.03	229	178	P	V
		5150	42.56	-11.44	54	34.79	31.75	9.05	33.03	229	178	A	V
	*	5240	123.26	-	-	115.34	31.83	9.12	33.03	229	178	P	V
	*	5240	113.45	-	-	105.53	31.83	9.12	33.03	229	178	A	V
		5353.68	49.19	-24.81	74	41.08	31.95	9.19	33.03	229	178	P	V
		5354.88	40.16	-13.84	54	32.05	31.95	9.19	33.03	229	178	A	V
Remark	3. No other spurious found. 4. All results are PASS against Peak and Average limit line.												



Band 1 5150~5250MHz
WIFI 802.11ac VHT20 (Harmonic @ 3m)

WIFI Ant. 1+2	Note	Frequency (MHz)	Level (dBμV/m)	Over Limit (dB)	Limit Line (dBμV/m)	Read Level (dBμV)	Antenna Factor (dB/m)	Path Loss (dB)	Preamp Factor (dB)	Ant Pos (cm)	Table Pos (deg)	Peak Avg. (P/A)	Pol. (H/V)	
802.11ac VHT20 CH 36 5180MHz		10360	47.35	-20.85	68.2	58.1	39.51	14.94	65.2	100	0	P	H	
		15540	55.9	-18.1	74	63.54	38	18.34	63.98	100	190	P	H	
		15540	38.9	-15.1	54	46.54	38	18.34	63.98	100	190	A	H	
													H	
			10360	49.8	-18.4	68.2	60.55	39.51	14.94	65.2	100	0	P	V
			15540	60.32	-13.68	74	67.96	38	18.34	63.98	211	280	P	V
			15540	42.26	-11.74	54	49.9	38	18.34	63.98	211	280	A	V
802.11ac VHT20 CH 44 5220MHz		10440	47.33	-20.87	68.2	57.93	39.61	14.99	65.2	100	0	P	H	
		15660	64.49	-9.51	74	72.65	37.67	18.41	64.24	186	28	P	H	
		15660	51.61	-2.39	54	59.77	37.67	18.41	64.24	186	28	A	H	
													H	
			10440	51.46	-16.74	68.2	62.06	39.61	14.99	65.2	100	0	P	V
			15660	61.36	-12.64	74	69.52	37.67	18.41	64.24	211	283	P	V
			15660	46.77	-7.23	54	54.93	37.67	18.41	64.24	211	283	A	V
802.11ac VHT20 CH 48 5240MHz		10480	50.18	-18.02	68.2	60.67	39.68	15.03	65.2	100	0	P	H	
		15720	64.68	-9.32	74	73.17	37.47	18.43	64.39	237	22	P	H	
		15720	51.9	-2.1	54	60.39	37.47	18.43	64.39	237	22	A	H	
													H	
			10480	52.58	-15.62	68.2	63.07	39.68	15.03	65.2	100	0	P	V
			15720	59.54	-14.46	74	68.03	37.47	18.43	64.39	155	182	P	V
			15720	46.43	-7.57	54	54.92	37.47	18.43	64.39	155	182	A	V
Remark	3. No other spurious found.													
	4. All results are PASS against Peak and Average limit line.													



Band 1 5150~5250MHz
WIFI 802.11ac VHT40 (Band Edge @ 3m)

WIFI Ant. 1+2	Note	Frequency (MHz)	Level (dBμV/m)	Over Limit (dB)	Limit Line (dBμV/m)	Read Level (dBμV)	Antenna Factor (dB/m)	Path Loss (dB)	Preamp Factor (dB)	Ant Pos (cm)	Table Pos (deg)	Peak Avg. (P/A)	Pol. (H/V)
802.11ac VHT40 CH 38 5190MHz		5149.76	54.45	-19.55	74	46.68	31.75	9.05	33.03	389	159	P	H
		5150	47.47	-6.53	54	39.7	31.75	9.05	33.03	389	159	A	H
	*	5190	109.08	-	-	101.24	31.78	9.09	33.03	389	159	P	H
	*	5190	100.53	-	-	92.69	31.78	9.09	33.03	389	159	A	H
		5378.8	49.18	-24.82	74	41.02	31.98	9.2	33.02	389	159	P	H
		5449.64	39.65	-14.35	54	31.33	32.05	9.29	33.02	389	159	A	H
		5146.64	60.03	-13.97	74	52.26	31.75	9.05	33.03	248	175	P	V
		5150	51.8	-2.2	54	44.03	31.75	9.05	33.03	248	175	A	V
	*	5190	113.51	-	-	105.67	31.78	9.09	33.03	248	175	P	V
	*	5190	104.67	-	-	96.83	31.78	9.09	33.03	248	175	A	V
		5352.2	48.41	-25.59	74	40.3	31.95	9.19	33.03	248	175	P	V
		5350	39.95	-14.05	54	31.84	31.95	9.19	33.03	248	175	A	V
802.11ac VHT40 CH 46 5230MHz		5148.98	55.37	-18.63	74	47.6	31.75	9.05	33.03	365	147	P	H
		5149.24	46.17	-7.83	54	38.4	31.75	9.05	33.03	365	147	A	H
	*	5230	112.81	-	-	104.9	31.83	9.11	33.03	365	147	P	H
	*	5230	103.36	-	-	95.45	31.83	9.11	33.03	365	147	A	H
		5430.24	48.6	-25.4	74	40.33	32.03	9.26	33.02	365	147	P	H
		5352.24	39.89	-14.11	54	31.78	31.95	9.19	33.03	365	147	A	H
		5150	61.03	-12.97	74	53.26	31.75	9.05	33.03	243	172	P	V
		5147.94	50.01	-3.99	54	42.24	31.75	9.05	33.03	243	172	A	V
	*	5230	117.56	-	-	109.65	31.83	9.11	33.03	243	172	P	V
	*	5230	108.58	-	-	100.67	31.83	9.11	33.03	243	172	A	V
	5397.12	48.46	-25.54	74	40.26	32	9.22	33.02	243	172	P	V	
	5350.8	40.72	-13.28	54	32.61	31.95	9.19	33.03	243	172	A	V	
Remark	3. No other spurious found. 4. All results are PASS against Peak and Average limit line.												



Band 1 5150~5250MHz
WIFI 802.11ac VHT40 (Harmonic @ 3m)

WIFI Ant. 1+2	Note	Frequency (MHz)	Level (dBμV/m)	Over Limit (dB)	Limit Line (dBμV/m)	Read Level (dBμV)	Antenna Factor (dB/m)	Path Loss (dB)	Preamp Factor (dB)	Ant Pos (cm)	Table Pos (deg)	Peak Avg. (P/A)	Pol. (H/V)	
802.11ac VHT40 CH 38 5190MHz		10380	45.62	-22.58	68.2	56.33	39.54	14.95	65.2	100	0	P	H	
		15570	44.37	-29.63	74	52.15	37.91	18.36	64.05	100	0	P	H	
													H	
													H	
			10380	45.45	-22.75	68.2	56.16	39.54	14.95	65.2	100	0	P	V
			15570	44.02	-29.98	74	51.8	37.91	18.36	64.05	100	0	P	V
														V
802.11ac VHT40 CH 46 5230MHz		10460	43.91	-24.29	68.2	54.48	39.63	15	65.2	100	0	P	H	
		15690	48.83	-25.17	74	57.17	37.57	18.41	64.32	100	0	P	H	
													H	
													H	
			10460	44.74	-23.46	68.2	55.31	39.63	15	65.2	100	0	P	V
			15690	44.08	-29.92	74	52.42	37.57	18.41	64.32	100	0	P	V
														V
Remark	3. No other spurious found.													
	4. All results are PASS against Peak and Average limit line.													



Band 1 5150~5250MHz
WIFI 802.11ac VHT80 (Band Edge @ 3m)

WIFI Ant. 1+2	Note	Frequency (MHz)	Level (dBμV/m)	Over Limit (dB)	Limit Line (dBμV/m)	Read Level (dBμV)	Antenna Factor (dB/m)	Path Loss (dB)	Preamp Factor (dB)	Ant Pos (cm)	Table Pos (deg)	Peak Avg. (P/A)	Pol. (H/V)
802.11ac VHT80 CH 42 5210MHz		5133.12	55.29	-18.71	74	47.54	31.73	9.05	33.03	386	159	P	H
		5149.5	46.92	-7.08	54	39.15	31.75	9.05	33.03	386	159	A	H
	*	5210	105.62	-	-	97.74	31.82	9.09	33.03	386	159	P	H
	*	5210	96.67	-	-	88.79	31.82	9.09	33.03	386	159	A	H
		5437.68	48.81	-25.19	74	40.54	32.03	9.26	33.02	386	159	P	H
		5352.24	39.9	-14.1	54	31.79	31.95	9.19	33.03	386	159	A	H
		5130	59.31	-14.69	74	51.58	31.73	9.03	33.03	259	177	P	V
		5148.72	52.51	-1.49	54	44.74	31.75	9.05	33.03	259	177	A	V
	*	5210	110.53	-	-	102.65	31.82	9.09	33.03	259	177	P	V
	*	5210	101.54	-	-	93.66	31.82	9.09	33.03	259	177	A	V
		5358.48	48.81	-25.19	74	40.7	31.95	9.19	33.03	259	177	P	V
	5350.08	41.28	-12.72	54	33.17	31.95	9.19	33.03	259	177	A	V	
Remark	3. No other spurious found. 4. All results are PASS against Peak and Average limit line.												



Band 1 5150~5250MHz
WIFI 802.11ac VHT80 (Harmonic @ 3m)

WIFI Ant. 1+2	Note	Frequency (MHz)	Level (dBμV/m)	Over Limit (dB)	Limit Line (dBμV/m)	Read Level (dBμV)	Antenna Factor (dB/m)	Path Loss (dB)	Preamp Factor (dB)	Ant Pos (cm)	Table Pos (deg)	Peak Avg. (P/A)	Pol. (H/V)	
802.11ac VHT80 CH 42 5210MHz		10420	44.69	-23.51	68.2	55.33	39.58	14.98	65.2	100	0	P	H	
		15630	43.84	-30.16	74	51.94	37.71	18.39	64.2	100	0	P	H	
													H	
													H	
			10420	43.77	-24.43	68.2	54.41	39.58	14.98	65.2	100	0	P	V
			15630	44.9	-29.1	74	53	37.71	18.39	64.2	100	0	P	V
														V
Remark	3. No other spurious found.													
	4. All results are PASS against Peak and Average limit line.													



Emission below 1GHz

WIFI 802.11a (LF @ 3m)

WIFI	Note	Frequency	Level	Over	Limit	Read	Antenna	Path	Preamp	Ant	Table	Peak	Pol.	
Ant.				Limit	Line	Level	Factor	Loss	Factor	Pos	Pos	Avg.		
1+2		(MHz)	(dBμV/m)	(dB)	(dBμV/m)	(dBμV)	(dB/m)	(dB)	(dB)	(cm)	(deg)	(P/A)	(H/V)	
802.11a LF		46.47	27.89	-12.11	40	43.64	15.72	1.02	32.49	100	0	P	H	
		132.6	27.15	-16.35	43.5	40.81	17.23	1.51	32.45	-	-	P	H	
		159.87	24.52	-18.98	43.5	38.96	16.28	1.61	32.43	-	-	P	H	
		783	30.8	-15.2	46	31.37	28.02	3.49	32.23	-	-	P	H	
		851.6	32.14	-13.86	46	31.41	28.82	3.67	31.91	-	-	P	H	
		936.3	32.65	-13.35	46	30.08	29.91	3.82	31.33	-	-	P	H	
														H
														H
														H
														H
														H
														H
			47.28	32.24	-7.76	40	48.4	15.31	1.02	32.49	100	0	P	V
			62.4	28.1	-11.9	40	47.96	11.59	1.02	32.49	-	-	P	V
			122.88	24.05	-19.45	43.5	37.7	17.26	1.51	32.46	-	-	P	V
			804	30.9	-15.1	46	31.31	28.06	3.53	32.16	-	-	P	V
			874	31.42	-14.58	46	30.31	29.09	3.67	31.8	-	-	P	V
			951	33.35	-12.65	46	29.94	30.61	3.82	31.19	-	-	P	V
														V
													V	
													V	
													V	
													V	
													V	
Remark	3. No other spurious found. 4. All results are PASS against limit line.													



<TXBF Mode>

Band 1 - 5150~5250MHz

WIFI 802.11ac VHT20 (Band Edge @ 3m)

WIFI Ant.	Note	Frequency	Level	Over Limit	Limit Line	Read Level	Antenna Factor	Cable Loss	Preamp Factor	Ant Pos	Table Pos	Peak Avg.	Pol.	
1+2		(MHz)	(dBμV/m)	(dB)	(dBμV/m)	(dBμV)	(dB/m)	(dB)	(dB)	(cm)	(deg)	(P/A)	(H/V)	
802.11ac VHT20 CH 36 5180MHz		5142.22	59.53	-14.47	74	51.76	31.75	9.05	33.03	355	148	P	H	
		5150	45.85	-8.15	54	38.08	31.75	9.05	33.03	355	148	A	H	
	*	5180	113.82	-	-	106	31.78	9.07	33.03	355	148	P	H	
	*	5180	105.37	-	-	97.55	31.78	9.07	33.03	355	148	A	H	
													H	
													H	
			5141.44	60.21	-13.79	74	52.44	31.75	9.05	33.03	354	214	P	V
			5149.76	48.26	-5.74	54	40.49	31.75	9.05	33.03	354	214	A	V
		*	5180	119.04	-	-	111.22	31.78	9.07	33.03	354	214	P	V
		*	5180	111.1	-	-	103.28	31.78	9.07	33.03	354	214	A	V
													V	
													V	
802.11ac VHT20 CH 44 5220MHz		5008.84	49.91	-24.09	74	42.38	31.62	8.95	33.04	100	244	P	H	
		5149.24	40.43	-13.57	54	32.66	31.75	9.05	33.03	100	244	A	H	
	*	5220	112.28	-	-	104.38	31.82	9.11	33.03	100	244	P	H	
	*	5220	104.49	-	-	96.59	31.82	9.11	33.03	100	244	A	H	
			5394.72	49.35	-24.65	74	41.15	32	9.22	33.02	100	244	P	H
			5352.96	39.62	-14.38	54	31.51	31.95	9.19	33.03	100	244	A	H
			5120.64	57.31	-16.69	74	49.59	31.72	9.03	33.03	118	160	P	V
			5135.98	43.48	-10.52	54	35.73	31.73	9.05	33.03	118	160	A	V
		*	5220	118.66	-	-	110.76	31.82	9.11	33.03	118	160	P	V
		*	5220	110	-	-	102.1	31.82	9.11	33.03	118	160	A	V
		5353.44	50.05	-23.95	74	41.94	31.95	9.19	33.03	118	160	P	V	
		5353.44	39.86	-14.14	54	31.75	31.95	9.19	33.03	118	160	A	V	



802.11ac VHT20 CH 48 5240MHz		5029.64	50.6	-23.4	74	43.04	31.63	8.97	33.04	100	219	P	H
		5145.34	40.14	-13.86	54	32.37	31.75	9.05	33.03	100	219	A	H
	*	5240	112.79	-	-	104.87	31.83	9.12	33.03	100	219	P	H
	*	5240	104.26	-	-	96.34	31.83	9.12	33.03	100	219	A	H
		5358	49.09	-24.91	74	40.98	31.95	9.19	33.03	100	219	P	H
		5351.04	39.76	-14.24	54	31.65	31.95	9.19	33.03	100	219	A	H
		5122.98	59.14	-14.86	74	51.41	31.73	9.03	33.03	366	207	P	V
		5135.98	42.87	-11.13	54	35.12	31.73	9.05	33.03	366	207	A	V
	*	5240	118.19	-	-	110.27	31.83	9.12	33.03	366	207	P	V
	*	5240	111.47	-	-	103.55	31.83	9.12	33.03	366	207	A	V
		5355.6	49.47	-24.53	74	41.36	31.95	9.19	33.03	366	207	P	V
		5352.24	40.39	-13.61	54	32.28	31.95	9.19	33.03	366	207	A	V
Remark	5. No other spurious found. 6. All results are PASS against Peak and Average limit line.												



Band 1 5150~5250MHz
WIFI 802.11ac VHT20 (Harmonic @ 3m)

WIFI Ant. 1+2	Note	Frequency (MHz)	Level (dBµV/m)	Over Limit (dB)	Limit Line (dBµV/m)	Read Level (dBµV)	Antenna Factor (dB/m)	Cable Loss (dB)	Preamp Factor (dB)	Ant Pos (cm)	Table Pos (deg)	Peak Avg. (P/A)	Pol. (H/V)	
802.11ac VHT20 CH 36 5180MHz		10360	46.32	-27.68	74	57.07	39.51	14.94	65.2	100	0	P	H	
		15540	48.52	-25.48	74	56.16	38	18.34	63.98	100	0	P	H	
													H	
													H	
			10360	46.81	-27.19	74	57.56	39.51	14.94	65.2	100	0	P	V
			15540	57.68	-16.32	74	65.32	38	18.34	63.98	212	250	P	V
			15540	40.11	-13.89	54	47.75	38	18.34	63.98	212	250	A	V
802.11ac VHT20 CH 44 5220MHz													V	
													V	
			10440	46.59	-27.41	74	57.19	39.61	14.99	65.2	100	0	P	H
			15660	44.14	-29.86	74	52.3	37.67	18.41	64.24	100	0	P	H
													H	
													H	
			10440	47.69	-26.31	74	58.29	39.61	14.99	65.2	100	0	P	V
802.11ac VHT20 CH 48 5240MHz													V	
													V	
			10480	46.38	-27.62	74	56.87	39.68	15.03	65.2	100	0	P	H
			15720	46.09	-27.91	74	54.58	37.47	18.43	64.39	100	0	P	H
													H	
													H	
			10480	46.75	-27.25	74	57.24	39.68	15.03	65.2	100	0	P	V
Remark	5. No other spurious found.													
	6. All results are PASS against Peak and Average limit line.													



Band 1 5150~5250MHz
WIFI 802.11ac VHT40 (Band Edge @ 3m)

WIFI Ant. 1+2	Note	Frequency (MHz)	Level (dBμV/m)	Over Limit (dB)	Limit Line (dBμV/m)	Read Level (dBμV)	Antenna Factor (dB/m)	Cable Loss (dB)	Preamp Factor (dB)	Ant Pos (cm)	Table Pos (deg)	Peak Avg. (P/A)	Pol. (H/V)	
802.11ac VHT40 CH 38 5190MHz		5146.38	53.84	-20.16	74	46.07	31.75	9.05	33.03	266	155	P	H	
		5146.9	48.52	-5.48	54	40.75	31.75	9.05	33.03	266	155	A	H	
	*	5190	109	-	-	101.16	31.78	9.09	33.03	266	155	P	H	
	*	5190	100.58	-	-	92.74	31.78	9.09	33.03	266	155	A	H	
		5459.72	39.35	-14.65	54	31.03	32.05	9.29	33.02	266	155	P	H	
														H
		5142.74	57.77	-16.23	74	50	31.75	9.05	33.03	300	209	P	V	
		5150	50.44	-3.56	54	42.67	31.75	9.05	33.03	300	209	A	V	
	*	5190	115.04	-	-	107.2	31.78	9.09	33.03	300	209	P	V	
	*	5190	106.64	-	-	98.8	31.78	9.09	33.03	300	209	A	V	
		5363.12	48.33	-25.67	74	40.2	31.97	9.19	33.03	300	209	P	V	
		5351.08	39.37	-14.63	54	31.26	31.95	9.19	33.03	300	209	P	V	
802.11ac VHT40 CH 46 5230MHz		5132.86	57.27	-16.73	74	49.54	31.73	9.03	33.03	282	140	P	H	
		5148.72	42.6	-11.4	54	34.83	31.75	9.05	33.03	282	140	A	H	
	*	5230	110.63	-	-	102.72	31.83	9.11	33.03	282	140	P	H	
	*	5230	102.21	-	-	94.3	31.83	9.11	33.03	282	140	A	H	
		5402.32	48.75	-25.25	74	40.55	32	9.22	33.02	282	140	P	H	
														H
		5125.84	56.93	-17.07	74	49.2	31.73	9.03	33.03	300	143	P	V	
		5150	44.09	-9.91	54	36.32	31.75	9.05	33.03	300	143	A	V	
	*	5230	113.94	-	-	106.03	31.83	9.11	33.03	300	143	P	V	
	*	5230	105.31	-	-	97.4	31.83	9.11	33.03	300	143	A	V	
	5363.4	49.44	-24.56	74	41.31	31.97	9.19	33.03	300	143	P	V		
	5351.08	40.46	-13.54	54	32.35	31.95	9.19	33.03	300	143	A	V		
Remark	5. No other spurious found. 6. All results are PASS against Peak and Average limit line.													



Band 1 5150~5250MHz
WIFI 802.11ac VHT40 (Harmonic @ 3m)

WIFI Ant. 1+2	Note	Frequency (MHz)	Level (dBμV/m)	Over Limit (dB)	Limit Line (dBμV/m)	Read Level (dBμV)	Antenna Factor (dB/m)	Cable Loss (dB)	Preamp Factor (dB)	Ant Pos (cm)	Table Pos (deg)	Peak Avg. (P/A)	Pol. (H/V)	
802.11ac VHT40 CH 38 5190MHz		10380	45.32	-28.68	74	56.03	39.54	14.95	65.2	100	0	P	H	
		15570	45.02	-28.98	74	52.8	37.91	18.36	64.05	100	0	P	H	
													H	
													H	
			10380	45.89	-28.11	74	56.6	39.54	14.95	65.2	100	0	P	V
			15570	45.54	-28.46	74	53.32	37.91	18.36	64.05	100	0	P	V
														V
802.11ac VHT40 CH 46 5230MHz		10460	46.29	-27.71	74	56.86	39.63	15	65.2	100	0	P	H	
		15690	43.91	-30.09	74	52.25	37.57	18.41	64.32	100	0	P	H	
													H	
													H	
			10460	45.79	-28.21	74	56.36	39.63	15	65.2	100	0	P	V
			15690	44.05	-29.95	74	52.39	37.57	18.41	64.32	100	0	P	V
														V
Remark	5. No other spurious found.													
	6. All results are PASS against Peak and Average limit line.													



Band 1 5150~5250MHz
WIFI 802.11ac VHT80 (Band Edge @ 3m)

WIFI Ant. 1+2	Note	Frequency (MHz)	Level (dBμV/m)	Over Limit (dB)	Limit Line (dBμV/m)	Read Level (dBμV)	Antenna Factor (dB/m)	Cable Loss (dB)	Preamp Factor (dB)	Ant Pos (cm)	Table Pos (deg)	Peak Avg. (P/A)	Pol. (H/V)
802.11ac VHT80 CH 42 5210MHz		5147.94	54.47	-19.53	74	46.7	31.75	9.05	33.03	311	160	P	H
		5149.24	49.53	-4.47	54	41.76	31.75	9.05	33.03	311	160	A	H
	*	5210	106.76	-	-	98.88	31.82	9.09	33.03	311	160	P	H
	*	5210	99.01	-	-	91.13	31.82	9.09	33.03	311	160	A	H
		5451.32	48.8	-25.2	74	40.48	32.05	9.29	33.02	311	160	P	H
		5351.08	39.87	-14.13	54	31.76	31.95	9.19	33.03	311	160	A	H
		5113.1	60.13	-13.87	74	52.42	31.72	9.03	33.04	300	212	P	V
		5145.08	51.85	-2.15	54	44.08	31.75	9.05	33.03	300	212	P	V
	*	5210	109.5	-	-	101.62	31.82	9.09	33.03	300	212	P	V
	*	5210	101.27	-	-	93.39	31.82	9.09	33.03	300	212	A	V
		5388.04	48.88	-25.12	74	40.72	31.98	9.2	33.02	300	212	P	V
	5350.52	40.35	-13.65	54	32.24	31.95	9.19	33.03	300	212	P	V	
Remark	5. No other spurious found. 6. All results are PASS against Peak and Average limit line.												



Band 1 5150~5250MHz
WIFI 802.11ac VHT80 (Harmonic @ 3m)

WIFI Ant. 1+2	Note	Frequency (MHz)	Level (dBμV/m)	Over Limit (dB)	Limit Line (dBμV/m)	Read Level (dBμV)	Antenna Factor (dB/m)	Cable Loss (dB)	Preamp Factor (dB)	Ant Pos (cm)	Table Pos (deg)	Peak Avg. (P/A)	Pol. (H/V)	
802.11ac VHT80 CH 42 5210MHz		10420	46.82	-27.18	74	57.46	39.58	14.98	65.2	100	0	P	H	
		15630	44.27	-29.73	74	52.37	37.71	18.39	64.2	100	0	P	H	
													H	
													H	
			10420	46.46	-27.54	74	57.1	39.58	14.98	65.2	100	0	P	V
			15630	44.2	-29.8	74	52.3	37.71	18.39	64.2	100	0	P	V
														V
Remark	5. No other spurious found.													
	6. All results are PASS against Peak and Average limit line.													



Note symbol

*	Fundamental Frequency which can be ignored. However, the level of any unwanted emissions shall not exceed the level of the fundamental frequency.
!	Test result is over limit line.
P/A	Peak or Average
H/V	Horizontal or Vertical



A calculation example for radiated spurious emission is shown as below:

WIFI	Note	Frequency	Level	Over	Limit	Read	Antenna	Cable	Preamp	Ant	Table	Peak	Pol.
Ant.				Limit	Line	Level	Factor	Loss	Factor	Pos	Pos	Avg.	
1+2		(MHz)	(dBμV/m)	(dB)	(dBμV/m)	(dBμV)	(dB/m)	(dB)	(dB)	(cm)	(deg)	(P/A)	(H/V)
802.11b		2390	55.45	-18.55	74	54.51	32.22	4.58	35.86	103	308	P	H
CH 01													
2412MHz		2390	43.54	-10.46	54	42.6	32.22	4.58	35.86	103	308	A	H

- Level(dBμV/m) =
Antenna Factor(dB/m) + Cable Loss(dB) + Read Level(dBμV) - Preamp Factor(dB)
- Over Limit(dB) = Level(dBμV/m) – Limit Line(dBμV/m)

For Peak Limit @ 2390MHz:

- Level(dBμV/m)
= Antenna Factor(dB/m) + Cable Loss(dB) + Read Level(dBμV) - Preamp Factor(dB)
= 32.22(dB/m) + 4.58(dB) + 54.51(dBμV) – 35.86 (dB)
= 55.45 (dBμV/m)
- Over Limit(dB)
= Level(dBμV/m) – Limit Line(dBμV/m)
= 55.45(dBμV/m) – 74(dBμV/m)
= -18.55(dB)

For Average Limit @ 2390MHz:

- Level(dBμV/m)
= Antenna Factor(dB/m) + Cable Loss(dB) + Read Level(dBμV) - Preamp Factor(dB)
= 32.22(dB/m) + 4.58(dB) + 42.6(dBμV) – 35.86 (dB)
= 43.54 (dBμV/m)
- Over Limit(dB)
= Level(dBμV/m) – Limit Line(dBμV/m)
= 43.54(dBμV/m) – 54(dBμV/m)
= -10.46(dB)

Both peak and average measured complies with the limit line, so test result is “PASS”.



Appendix D. Radiated Spurious Emission

Test Engineer :	Hao Hsu, Jacky Hung and KenWu	Temperature :	22~25°C
		Relative Humidity :	52~57%

Note symbol

-L	Low channel location
-R	High channel location



<Single Mode>

Band 1 - 5150~5250MHz
WIFI 802.11a (Band Edge @ 3m)

WIFI	Band 1 5150~5250MHz Band Edge @ 3m	
ANT	802.11a CH36 5180MHz	
1	Horizontal	Fundamental
Peak	<p>Site : 03CH11-HY Condition : PEAK_BE_74 3m HORN 91200-HF HORIZONTAL RBW:1000.000KHz VBW:3000.000KHz SWT:Auto Detector : Peak Project : 811726 Setting : Z2</p>	<p>Site : 03CH11-HY Condition : PEAK(LINE) 3m HORN 91200-HF HORIZONTAL RBW:1000.000KHz VBW:3000.000KHz SWT:Auto Detector : Peak Project : 811726 Setting : Z2</p>
Avg.	<p>Site : 03CH11-HY Condition : AVG_BE_54 3m HORN 91200-HF HORIZONTAL RBW:1000.000KHz VBW:1000KHz SWT:Auto Detector : Peak Project : 811726 Setting : Z2</p>	Left blank

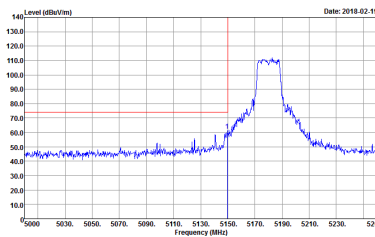
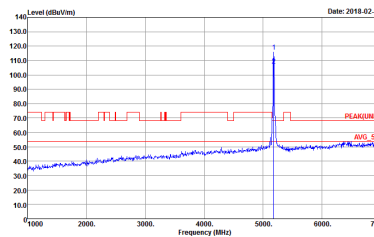
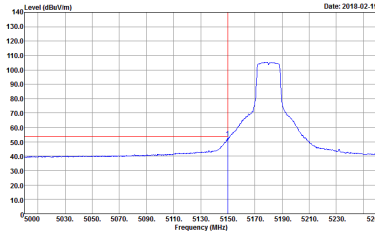

WIFI	Band 1 5150~5250MHz Band Edge @ 3m	
ANT	802.11a CH36 5180MHz	
1	Vertical	Fundamental
<p>Peak</p>	 <p>Date: 2018.02.19</p> <p>Site : 03CH11-HY Condition : PEAK_BE_74 3m HORN 9120D-HF VERTICAL Detector : Peak Project : 811726 Setting : Z2</p>	 <p>Date: 2018.02.19</p> <p>Site : 03CH11-HY Condition : PEAK(LINB) 3m HORN 9120D-HF VERTICAL Detector : Peak Project : 811726 Setting : Z2</p>
<p>Avg.</p>	 <p>Date: 2018.02.19</p> <p>Site : 03CH11-HY Condition : AVG_BE_54 3m HORN 9120D-HF VERTICAL Detector : Peak Project : 811726 Setting : Z2</p>	<p>Left blank</p>

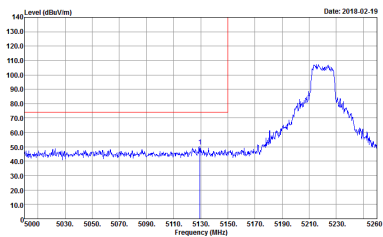
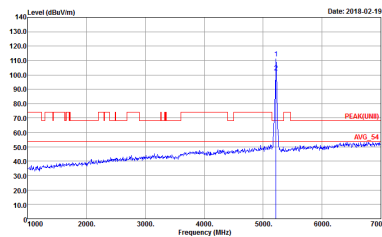
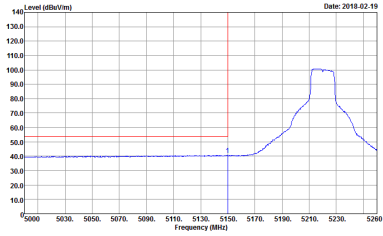

WIFI	Band 1 5150~5250MHz Band Edge @ 3m	
ANT	802.11a CH44 5220MHz - L	
1	Horizontal	Fundamental
<p>Peak</p>	 <p>Date: 2018.02.19</p> <p>Site : 03CH11-HY Condition : PEAK_BE_74 3m HORN 91200-HF HORIZONTAL RBW:1000.000KHz VBW:3000.000KHz SWT:Auto Detector : Peak Project : 811726</p>	 <p>Date: 2018.02.19</p> <p>Site : 03CH11-HY Condition : PEAKUNII 3m HORN 91200-HF HORIZONTAL RBW:1000.000KHz VBW:3000.000KHz SWT:Auto Detector : Peak Project : 811726</p>
<p>Avg.</p>	 <p>Date: 2018.02.19</p> <p>Site : 03CH11-HY Condition : AVG_BE_54 3m HORN 91200-HF HORIZONTAL RBW:1000.000KHz VBW:1000KHz SWT:Auto Detector : Peak Project : 811726</p>	<p>Left blank</p>

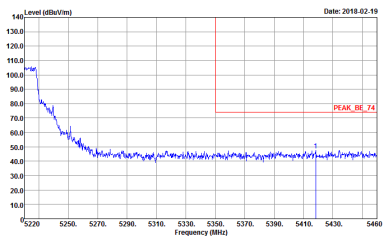
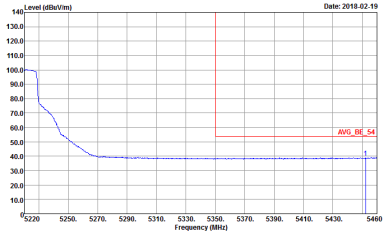

WIFI	Band 1 5150~5250MHz Band Edge @ 3m	
ANT	802.11a CH44 5220MHz - R	
1	Horizontal	Fundamental
<p>Peak</p>	 <p>Site : 03CH11-HY Condition : PEAK_BE_74 3m HORN 91200-HF HORIZONTAL Detector : Peak Project : 811726</p>	<p>Left blank</p>
<p>Avg.</p>	 <p>Site : 03CH11-HY Condition : AVG_BE_54 3m HORN 91200-HF HORIZONTAL Detector : Peak Project : 811726</p>	<p>Left blank</p>

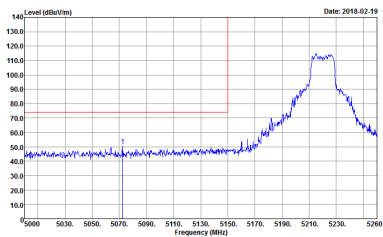
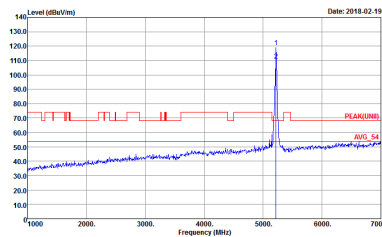
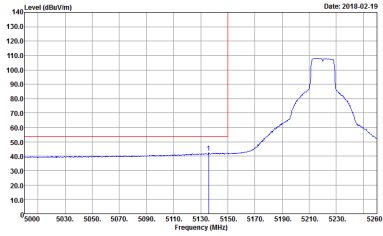

WIFI	Band 1 5150~5250MHz Band Edge @ 3m	
ANT	802.11a CH44 5220MHz - L	
1	Vertical	Fundamental
<p>Peak</p>	 <p>Site : 03CH11-HY Condition : PEAK_BE_74 3m HORN 9120D-HF VERTICAL Detector : Peak Project : 811726</p>	 <p>Site : 03CH11-HY Condition : PEAK(UNII) 3m HORN 9120D-HF VERTICAL Detector : Peak Project : 811726</p>
<p>Avg.</p>	 <p>Site : 03CH11-HY Condition : AVG_BE_54 3m HORN 9120D-HF VERTICAL Detector : Peak Project : 811726</p>	<p>Left blank</p>

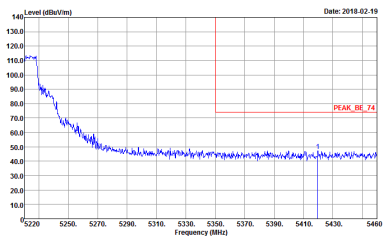
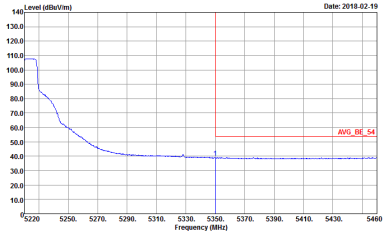

WIFI	Band 1 5150~5250MHz Band Edge @ 3m	
ANT	802.11a CH44 5220MHz - R	
1	Vertical	Fundamental
<p>Peak</p>	 <p>Site : 03CH11-HY Condition : PEAK_BE_74 3m HORN 91200-HF VERTICAL : RBW:1000.000KHz VBW:3000.000KHz SWT:Auto Detector : Peak Project : 811726</p>	<p>Left blank</p>
<p>Avg.</p>	 <p>Site : 03CH11-HY Condition : AVG_BE_54 3m HORN 91200-HF VERTICAL : RBW:1000.000KHz VBW:1000KHz SWT:Auto Detector : Peak Project : 811726</p>	<p>Left blank</p>

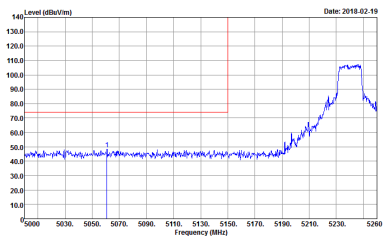
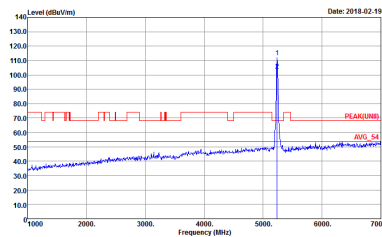
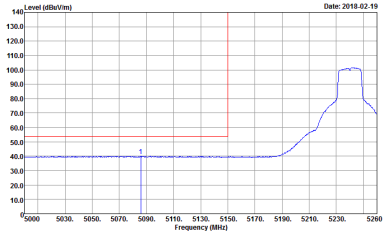

WIFI	Band 1 5150~5250MHz Band Edge @ 3m	
ANT	802.11a CH48 5240MHz - L	
1	Horizontal	Fundamental
Peak	 <p>Date: 2018.02.19</p> <p>Site : 03CH11-HY Condition : PEAK_BE_74 3m HORN 91200-HF HORIZONTAL RBW:1000.000KHz VBW:3000.000KHz SWT:Auto Detector : Peak Project : 811726</p>	 <p>Date: 2018.02.19</p> <p>Site : 03CH11-HY Condition : PEAK(UNII) 3m HORN 91200-HF HORIZONTAL RBW:1000.000KHz VBW:3000.000KHz SWT:Auto Detector : Peak Project : 811726</p>
Avg.	 <p>Date: 2018.02.19</p> <p>Site : 03CH11-HY Condition : AVG_BE_54 3m HORN 91200-HF HORIZONTAL RBW:1000.000KHz VBW:1000KHz SWT:Auto Detector : Peak Project : 811726</p>	Left blank

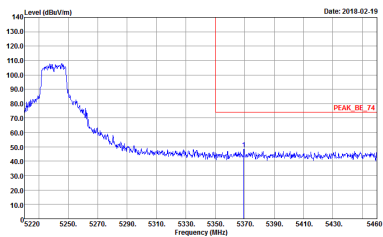
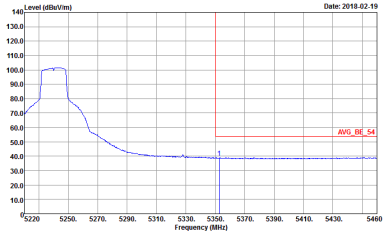

WIFI	Band 1 5150~5250MHz Band Edge @ 3m	
ANT	802.11a CH48 5240MHz - R	
1	Horizontal	Fundamental
<p>Peak</p>	 <p>Site : 03CH11-HY Condition : PEAK_BE_74 3m HORN 91200-HF HORIZONTAL Detector : Peak Project : 811726</p>	<p>Left blank</p>
<p>Avg.</p>	 <p>Site : 03CH11-HY Condition : AVG_BE_54 3m HORN 91200-HF HORIZONTAL Detector : Peak Project : 811726</p>	<p>Left blank</p>

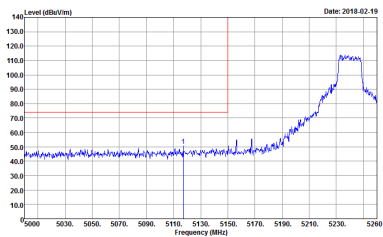
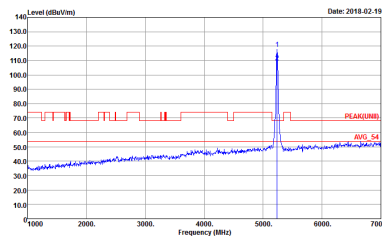
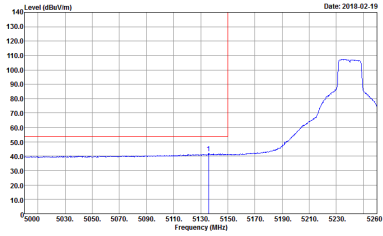

WIFI	Band 1 5150~5250MHz Band Edge @ 3m	
ANT	802.11a CH48 5240MHz - L	
1	Vertical	Fundamental
Peak	 <p>Date: 2018.02.19</p> <p>Site : 03CH11-HY Condition : PEAK_BE_74 3m HORN 9120D-HF VERTICAL RBW:1000.000KHz VBW:3000.000KHz SWT:Auto Detector : Peak Project : 811726</p>	 <p>Date: 2018.02.19</p> <p>Site : 03CH11-HY Condition : PEAKUNII 3m HORN 9120D-HF VERTICAL RBW:1000.000KHz VBW:3000.000KHz SWT:Auto Detector : Peak Project : 811726</p>
Avg.	 <p>Date: 2018.02.19</p> <p>Site : 03CH11-HY Condition : AVG_BE_54 3m HORN 9120D-HF VERTICAL RBW:1000.000KHz VBW:1000KHz SWT:Auto Detector : Peak Project : 811726</p>	Left blank

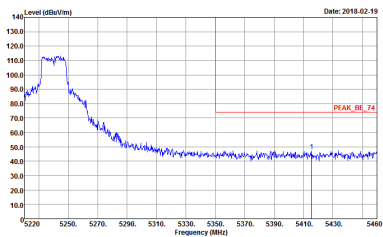
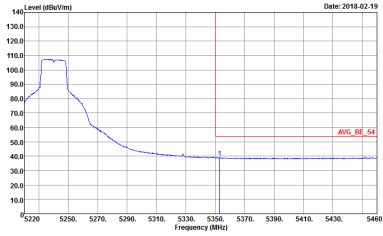

WIFI	Band 1 5150~5250MHz Band Edge @ 3m	
ANT	802.11a CH48 5240MHz - R	
1	Vertical	Fundamental
<p>Peak</p>	 <p>Site : 03CH11-HY Condition : PEAK_BE_74 3m HORN 91200-HF VERTICAL RBW:1000.000KHz VBW:3000.000KHz SWT:Auto Detector : Peak Project : 811726</p>	<p>Left blank</p>
<p>Avg.</p>	 <p>Site : 03CH11-HY Condition : AVG_BE_54 3m HORN 91200-HF VERTICAL RBW:1000.000KHz VBW:1000KHz SWT:Auto Detector : Peak Project : 811726</p>	<p>Left blank</p>



**Band 1 5150~5250MHz
WIFI 802.11ac VHT20 (Band Edge @ 3m)**

WIFI	Band 1 5150~5250MHz Band Edge @ 3m	
ANT	802.11ac VHT20 CH36 5180MHz	
1	Horizontal	Fundamental
Peak	<p>Site : 03CHI1-HY Condition : PEAK_BE_74 3m HORN 9120D-HF HORIZONTAL Detector : Peak Project : 811726 Setting : ZZ</p>	<p>Site : 03CHI1-HY Condition : PEAK(UNIT) 3m HORN 9120D-HF HORIZONTAL Detector : Peak Project : 811726 Setting : ZZ</p>
Avg.	<p>Site : 03CHI1-HY Condition : AVG_BE_54 3m HORN 9120D-HF HORIZONTAL Detector : Peak Project : 811726 Setting : ZZ</p>	Left blank

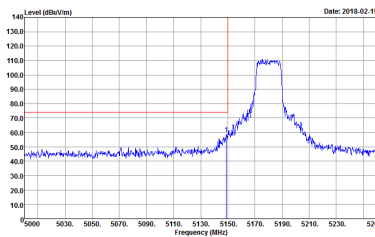
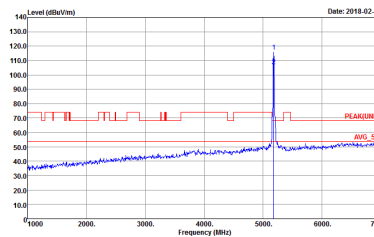
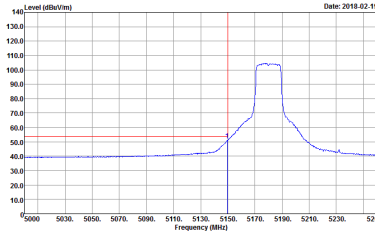

WIFI	Band 1 5150~5250MHz Band Edge @ 3m	
ANT	802.11ac VHT20 CH36 5180MHz	
1	Vertical	Fundamental
<p>Peak</p>	 <p>Site : 03CH11-HY Condition : PEAK_BE_74 3m HORN 91200-HF VERTICAL Detector : Peak Project : 811726 Setting : Z2</p>	 <p>Site : 03CH11-HY Condition : PEAK(UNII) 3m HORN 91200-HF VERTICAL Detector : Peak Project : 811726 Setting : Z2</p>
<p>Avg.</p>	 <p>Site : 03CH11-HY Condition : AVG_BE_54 3m HORN 91200-HF VERTICAL Detector : Peak Project : 811726 Setting : Z2</p>	<p>Left blank</p>

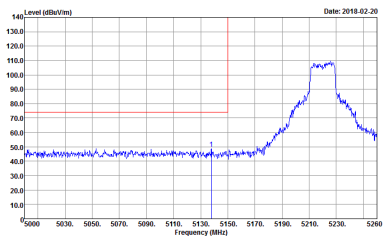
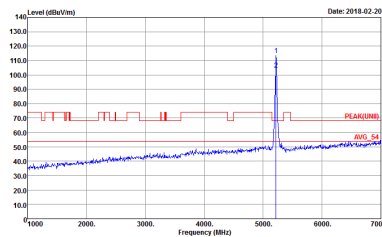
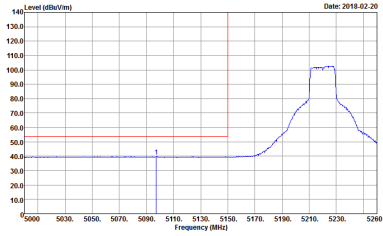

WIFI	Band 1 5150~5250MHz Band Edge @ 3m	
ANT	802.11ac VHT20 CH44 5220MHz - L	
1	Horizontal	Fundamental
Peak	 <p>Date: 2018.02.20</p> <p>Site : 03CH11-HY Condition : PEAK_BE_74 3m HORN 91200-HF HORIZONTAL RBW:1000.000KHz VBW:3000.000KHz SWT:Auto Detector : Peak Project : 811726</p>	 <p>Date: 2018.02.20</p> <p>Site : 03CH11-HY Condition : PEAK(UNII) 3m HORN 91200-HF HORIZONTAL RBW:1000.000KHz VBW:3000.000KHz SWT:Auto Detector : Peak Project : 811726</p>
Avg.	 <p>Date: 2018.02.20</p> <p>Site : 03CH11-HY Condition : AVG_BE_54 3m HORN 91200-HF HORIZONTAL RBW:1000.000KHz VBW:3000KHz SWT:Auto Detector : Peak Project : 811726</p>	Left blank

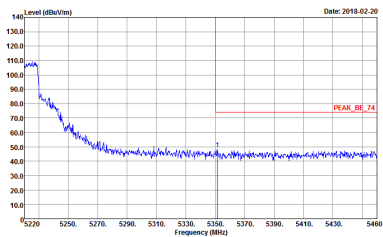
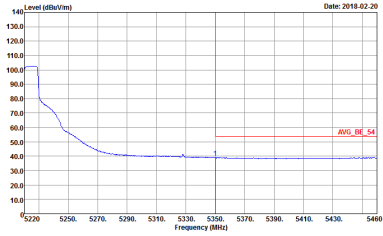

WIFI	Band 1 5150~5250MHz Band Edge @ 3m	
ANT	802.11ac VHT20 CH44 5220MHz - R	
1	Horizontal	Fundamental
<p>Peak</p>	 <p>Site : 03CH11-HY Condition : PEAK_BE_74 3m HORN 91200-HF HORIZONTAL Detector : Peak Project : 811726</p>	<p>Left blank</p>
<p>Avg.</p>	 <p>Site : 03CH11-HY Condition : AVG_BE_54 3m HORN 91200-HF HORIZONTAL Detector : Peak Project : 811726</p>	<p>Left blank</p>



WIFI	Band 1 5150~5250MHz Band Edge @ 3m	
ANT	802.11ac VHT20 CH44 5220MHz - L	
1	Vertical	Fundamental
Peak	<p>Site : 03CH11-HY Condition : PEAK_BE_74 3m HORN 91200-HF VERTICAL Detector : Peak Project : 811726</p>	<p>Site : 03CH11-HY Condition : PEAK(UNII) 3m HORN 91200-HF VERTICAL Detector : Peak Project : 811726</p>
Avg.	<p>Site : 03CH11-HY Condition : AVG_BE_54 3m HORN 91200-HF VERTICAL Detector : Peak Project : 811726</p>	Left blank

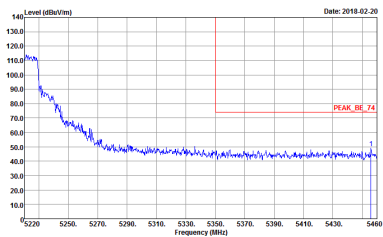
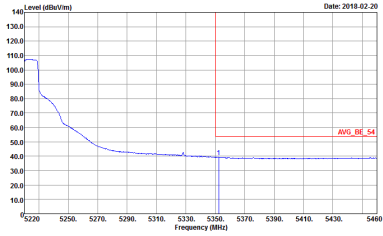

WIFI	Band 1 5150~5250MHz Band Edge @ 3m	
ANT	802.11ac VHT20 CH44 5220MHz - R	
1	Vertical	Fundamental
<p>Peak</p>	 <p>Site : 03CH11-HY Condition : PEAK_BE_74 3m HORN 91200-HF VERTICAL RBW:1000.000KHz VBW:3000.000KHz SWT:Auto Detector : Peak Project : 811726</p>	<p>Left blank</p>
<p>Avg.</p>	 <p>Site : 03CH11-HY Condition : AVG_BE_54 3m HORN 91200-HF VERTICAL RBW:1000.000KHz VBW:3.000KHz SWT:Auto Detector : Peak Project : 811726</p>	<p>Left blank</p>

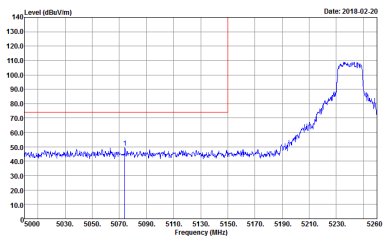
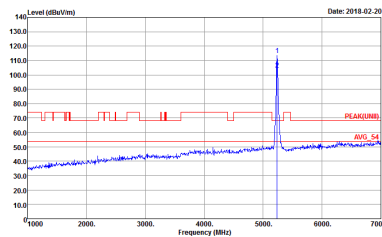
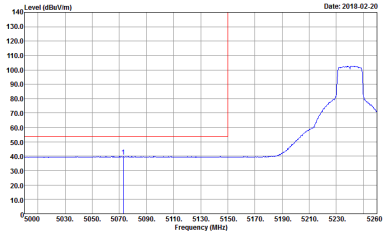

WIFI	Band 1 5150~5250MHz Band Edge @ 3m	
ANT	802.11ac VHT20 CH48 5240MHz - L	
1	Horizontal	Fundamental
<p>Peak</p>	 <p>Date: 2018.02.20</p> <p>Site : 03CH11-HY Condition : PEAK_BE_74 3m HORN 91200-HF HORIZONTAL RBW:1000.000KHz VBW:3000.000KHz SWT:Auto Detector : Peak Project : 811726</p>	 <p>Date: 2018.02.20</p> <p>Site : 03CH11-HY Condition : PEAK(UNII) 3m HORN 91200-HF HORIZONTAL RBW:1000.000KHz VBW:3000.000KHz SWT:Auto Detector : Peak Project : 811726</p>
<p>Avg.</p>	 <p>Date: 2018.02.20</p> <p>Site : 03CH11-HY Condition : AVG_BE_54 3m HORN 91200-HF HORIZONTAL RBW:1000.000KHz VBW:3000.000KHz SWT:Auto Detector : Peak Project : 811726</p>	<p>Left blank</p>

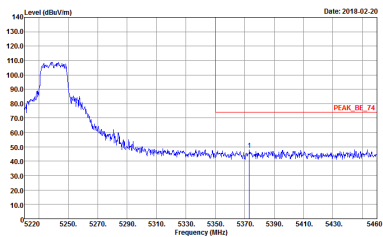
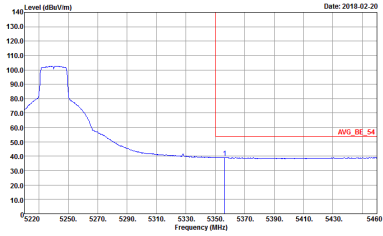

WIFI	Band 1 5150~5250MHz Band Edge @ 3m	
ANT	802.11ac VHT20 CH48 5240MHz - R	
1	Horizontal	Fundamental
<p>Peak</p>	 <p>Site : 03CH11-HY Condition : PEAK_BE_74 3m HORN 91200-HF HORIZONTAL RBW:1000.000KHz VBW:3000.000KHz SWT:Auto Detector : Peak Project : 811726</p>	<p>Left blank</p>
<p>Avg.</p>	 <p>Site : 03CH11-HY Condition : AVG_BE_54 3m HORN 91200-HF HORIZONTAL RBW:1000.000KHz VBW:3.000KHz SWT:Auto Detector : Peak Project : 811726</p>	<p>Left blank</p>



WIFI	Band 1 5150~5250MHz Band Edge @ 3m	
ANT	802.11ac VHT20 CH48 5240MHz - L	
1	Vertical	Fundamental
Peak	<p>Site : 03CH11-HY Condition : PEAK_BE_74 3m HORN 91200-HF VERTICAL Detector : Peak Project : 811726</p>	<p>Site : 03CH11-HY Condition : PEAK(UNII) 3m HORN 91200-HF VERTICAL Detector : Peak Project : 811726</p>
Avg.	<p>Site : 03CH11-HY Condition : AVG_BE_54 3m HORN 91200-HF VERTICAL Detector : Peak Project : 811726</p>	Left blank

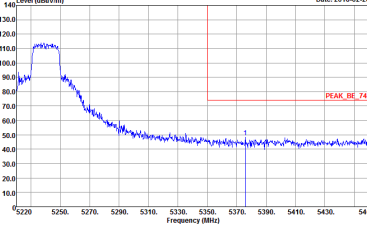
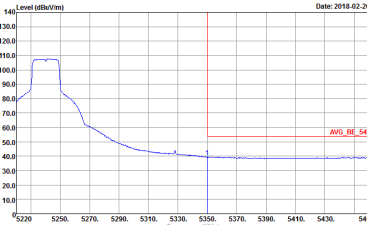

WIFI	Band 1 5150~5250MHz Band Edge @ 3m	
ANT	802.11ac VHT20 CH48 5240MHz - R	
1	Vertical	Fundamental
<p>Peak</p>	 <p>Site : 03CH11-HY Condition : PEAK_BE_74 3m HORN 91200-HF VERTICAL : RBW:1000.000KHz VBW:3000.000KHz SWT:Auto Detector : Peak Project : 811726</p>	<p>Left blank</p>
<p>Avg.</p>	 <p>Site : 03CH11-HY Condition : AVG_BE_54 3m HORN 91200-HF VERTICAL : RBW:1000.000KHz VBW:3.000KHz SWT:Auto Detector : Peak Project : 811726</p>	<p>Left blank</p>

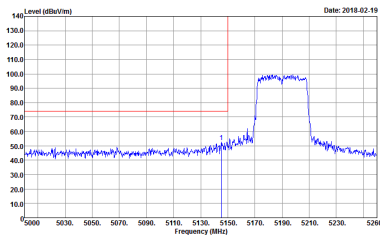
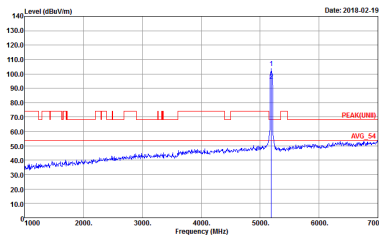
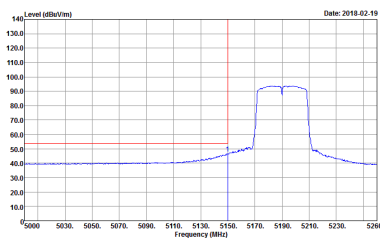

**Band 1 5150~5250MHz
WIFI 802.11ac VHT40 (Band Edge @ 3m)**

WIFI	Band 1 5150~5250MHz Band Edge @ 3m	
ANT	802.11ac VHT40 CH38 5190MHz - L	
1	Horizontal	Fundamental
Peak	 <p>Site : 03CH11-HY Condition : PEAK_BE_74 3m HORN 9120D-HF HORIZONTAL Detector : Peak Project : 811726 Setting : Z1</p>	 <p>Site : 03CH11-HY Condition : PEAK(UNIT) 3m HORN 9120D-HF HORIZONTAL Detector : Peak Project : 811726 Setting : Z1</p>
Avg.	 <p>Site : 03CH11-HY Condition : AVG_BE_54 3m HORN 9120D-HF HORIZONTAL Detector : Peak Project : 811726 Setting : Z1</p>	Left blank

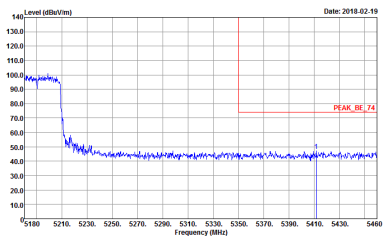
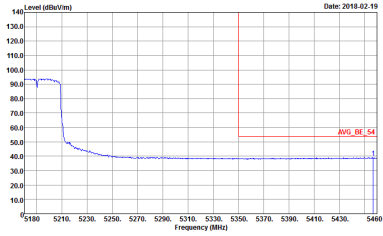

WIFI	Band 1 5150~5250MHz Band Edge @ 3m	
ANT	802.11ac VHT40 CH38 5190MHz - R	
1	Horizontal	Fundamental
<p>Peak</p>	 <p>Site : 03CH11-HY Condition : PEAK_BE_74 3m HORN 91200-HF HORIZONTAL Detector : Peak Project : 811726 Setting : Z1</p>	<p>Left blank</p>
<p>Avg.</p>	 <p>Site : 03CH11-HY Condition : AVG_BE_54 3m HORN 91200-HF HORIZONTAL Detector : Peak Project : 811726 Setting : Z1</p>	<p>Left blank</p>

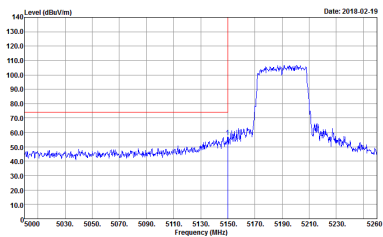
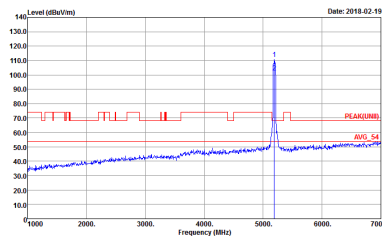
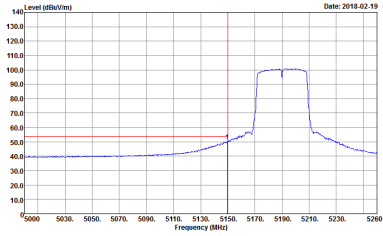

WIFI	Band 1 5150~5250MHz Band Edge @ 3m	
ANT	802.11ac VHT40 CH38 5190MHz - L	
1	Vertical	Fundamental
<p>Peak</p>	 <p>Site : 03CH11-HY Condition : PEAK_BE_74 3m HORN 9120D-HF VERTICAL Detector : Peak Project : 811726 Setting : Z1</p>	 <p>Site : 03CH11-HY Condition : PEAK(UNII) 3m HORN 9120D-HF VERTICAL Detector : Peak Project : 811726 Setting : Z1</p>
<p>Avg.</p>	 <p>Site : 03CH11-HY Condition : AVG_BE_54 3m HORN 9120D-HF VERTICAL Detector : Peak Project : 811726 Setting : Z1</p>	<p>Left blank</p>

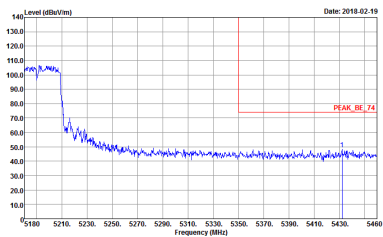
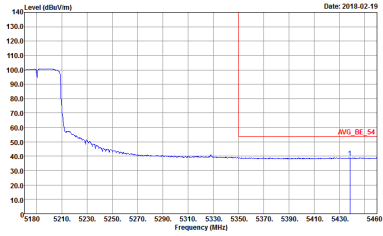

WIFI	Band 1 5150~5250MHz Band Edge @ 3m	
ANT	802.11ac VHT40 CH38 5190MHz - R	
1	Vertical	Fundamental
<p>Peak</p>	 <p>Site : 03CH11-HY Condition : PEAK_BE_74 3m HORN 91200-HF VERTICAL : RBW:1000.000KHz VBW:3000.000KHz SWT:Auto Detector : Peak Project : 811726 Setting : Z1</p>	<p>Left blank</p>
<p>Avg.</p>	 <p>Site : 03CH11-HY Condition : AVG_BE_54 3m HORN 91200-HF VERTICAL : RBW:1000.000KHz VBW:1000KHz SWT:Auto Detector : Peak Project : 811726 Setting : Z1</p>	<p>Left blank</p>

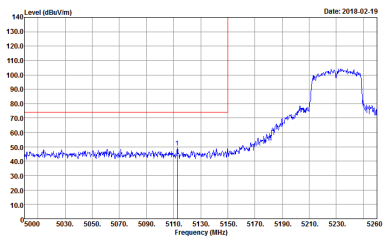
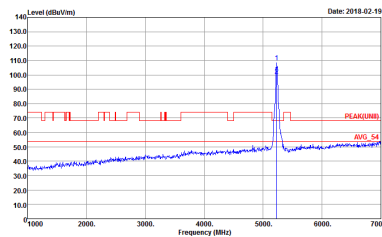
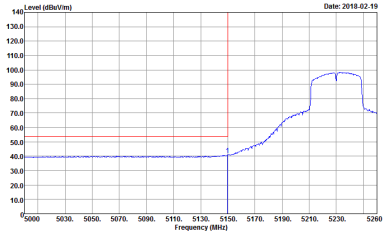

WIFI	Band 1 5150~5250MHz Band Edge @ 3m	
ANT	802.11ac VHT40 CH46 5230MHz - L	
1	Horizontal	Fundamental
<p>Peak</p>	 <p>Site : 03CH11-HY Condition : PEAK_BE_74 3m HORN 9120D-HF HORIZONTAL Detector : Peak Project : 811726 Setting : Z5</p>	 <p>Site : 03CH11-HY Condition : PEAKUNII 3m HORN 9120D-HF HORIZONTAL Detector : Peak Project : 811726 Setting : Z5</p>
<p>Avg.</p>	 <p>Site : 03CH11-HY Condition : AVG_BE_54 3m HORN 9120D-HF HORIZONTAL Detector : Peak Project : 811726 Setting : Z5</p>	<p>Left blank</p>

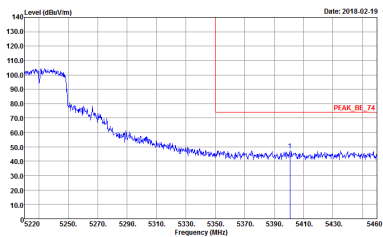
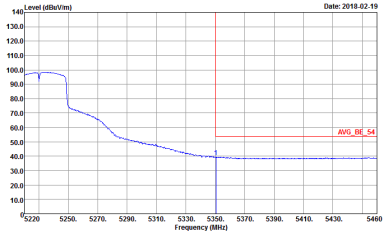

WIFI	Band 1 5150~5250MHz Band Edge @ 3m	
ANT	802.11ac VHT40 CH46 5230MHz - R	
1	Horizontal	Fundamental
<p>Peak</p>	 <p>Site : 03CH11-HY Condition : PEAK_BE_74 3m HORN 91200-HF HORIZONTAL Detector : Peak Project : 811726 Setting : Z5</p>	<p>Left blank</p>
<p>Avg.</p>	 <p>Site : 03CH11-HY Condition : AVG_BE_54 3m HORN 91200-HF HORIZONTAL Detector : Peak Project : 811726 Setting : Z5</p>	<p>Left blank</p>



WIFI	Band 1 5150~5250MHz Band Edge @ 3m	
ANT	802.11ac VHT40 CH46 5230MHz - L	
1	Vertical	Fundamental
Peak	<p>Site : 03CH11-HY Condition : PEAK_BE_74 3m HORN 9120D-HF VERTICAL : RBW:1000.000KHz VBW:3000.000KHz SWT:Auto Detector : Peak Project : 811726 Setting : Z5</p>	<p>Site : 03CH11-HY Condition : PEAK(UNII) 3m HORN 9120D-HF VERTICAL : RBW:1000.000KHz VBW:3000.000KHz SWT:Auto Detector : Peak Project : 811726 Setting : Z5</p>
Avg.	<p>Site : 03CH11-HY Condition : AVG_BE_54 3m HORN 9120D-HF VERTICAL : RBW:1000.000KHz VBW:1000KHz SWT:Auto Detector : Peak Project : 811726 Setting : Z5</p>	Left blank



WIFI	Band 1 5150~5250MHz Band Edge @ 3m	
ANT	802.11ac VHT40 CH46 5230MHz - R	
1	Vertical	Fundamental
Peak	<p>Site : 03CH11-HY Condition : PEAK_BE_74 3m HORN 91200-HF VERTICAL : RBW:1000.000KHz VBW:3000.000KHz SWT:Auto Detector : Peak Project : 811726 Setting : Z5</p>	Left blank
Avg.	<p>Site : 03CH11-HY Condition : AVG_BE_54 3m HORN 91200-HF VERTICAL : RBW:1000.000KHz VBW:1000KHz SWT:Auto Detector : Peak Project : 811726 Setting : Z5</p>	Left blank



Band 1 5150~5250MHz
WIFI 802.11ac VHT80 (Band Edge @ 3m)

WIFI	Band 1 5150~5250MHz Band Edge @ 3m	
ANT	802.11ac VHT80 CH42 5210MHz - L	
1	Horizontal	Fundamental
<p align="center">Peak</p>	<p>Site : 03CH11-HY Condition : PEAK_BE_74 3m HORN 9120D-HF HORIZONTAL Detector : Peak Project : 811726 Setting : 21.5</p>	<p>Site : 03CH11-HY Condition : PEAK(UNIT) 3m HORN 9120D-HF HORIZONTAL Detector : Peak Project : 811726 Setting : 21.5</p>
<p align="center">Avg.</p>	<p>Site : 03CH11-HY Condition : AVG_BE_54 3m HORN 9120D-HF HORIZONTAL Detector : Peak Project : 811726 Setting : 21.5</p>	<p align="center">Left blank</p>

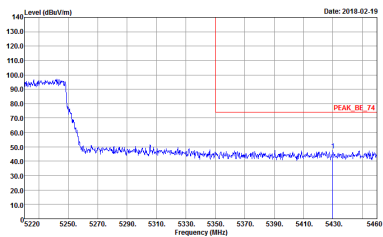
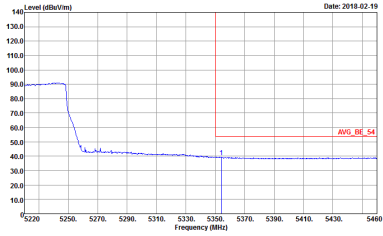

WIFI	Band 1 5150~5250MHz Band Edge @ 3m	
ANT	802.11ac VHT80 CH42 5210MHz - R	
1	Horizontal	Fundamental
Peak	 <p>Site : 03CH11-HY Condition : PEAK_BE_74 3m HORN 91200-HF HORIZONTAL Detector : Peak Project : 811726 Setting : 21.5</p>	Left blank
Avg.	 <p>Site : 03CH11-HY Condition : AVG_BE_54 3m HORN 91200-HF HORIZONTAL Detector : Peak Project : 811726 Setting : 21.5</p>	Left blank



WIFI	Band 1 5150~5250MHz Band Edge @ 3m	
ANT	802.11ac VHT80 CH42 5210MHz - L	
1	Vertical	Fundamental
Peak	<p>Site : 03CH11-HY Condition : PEAK_BE_74 3m HORN 91200-HF VERTICAL RBW:1000.000KHz VBW:3000.000KHz SWT:Auto Detector : Peak Project : 811726 Setting : 215</p>	<p>Site : 03CH11-HY Condition : PEAK(UNII) 3m HORN 91200-HF VERTICAL RBW:1000.000KHz VBW:3000.000KHz SWT:Auto Detector : Peak Project : 811726 Setting : 215</p>
Avg.	<p>Site : 03CH11-HY Condition : AVG_BE_54 3m HORN 91200-HF VERTICAL RBW:1000.000KHz VBW:1000KHz SWT:Auto Detector : Peak Project : 811726 Setting : 215</p>	Left blank



WIFI	Band 1 5150~5250MHz Band Edge @ 3m	
ANT	802.11ac VHT80 CH42 5210MHz - R	
1	Vertical	Fundamental
Peak	<p>Site : 03CH11-HY Condition : PEAK_BE_74 3m HORN 91200-HF VERTICAL : RBW:1000.000KHz VBW:3000.000KHz SWT:Auto Detector : Peak Project : 811726 Setting : 21.5</p>	Left blank
Avg.	<p>Site : 03CH11-HY Condition : AVG_BE_54 3m HORN 91200-HF VERTICAL : RBW:1000.000KHz VBW:1000KHz SWT:Auto Detector : Peak Project : 811726 Setting : 21.5</p>	Left blank



Band 1 - 5150~5250MHz
WIFI 802.11a (Harmonic @ 3m)

WIFI	Band 1 5150~5250MHz Harmonic @ 3m	
ANT	802.11a CH36 5180MHz	
1	Horizontal	Vertical
Peak Avg.	<p>Site : 03CH11-HY Condition : PEAK(LINE) 3m HORN 9120D-HF HORIZONTAL Project : 811726</p>	<p>Site : 03CH11-HY Condition : PEAK(LINE) 3m HORN 9120D-HF VERTICAL Project : 811726</p>



WIFI	Band 1 5150~5250MHz Harmonic @ 3m	
ANT	802.11a CH44 5220MHz	
1	Horizontal	Vertical
<p>Peak</p> <p>Avg.</p>		

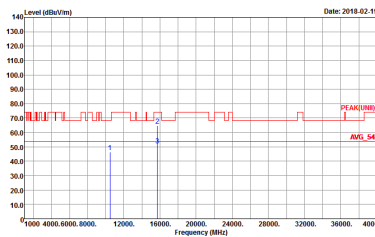
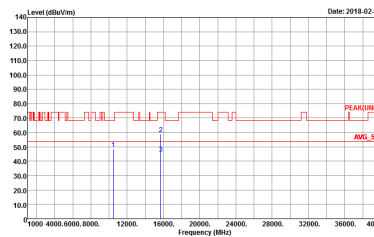

WIFI	Band 1 5150~5250MHz Harmonic @ 3m	
ANT	802.11a CH48 5240MHz	
1	Horizontal	Vertical
<p>Peak</p> <p>Avg.</p>	 <p>Date: 2018.02.19</p> <p>Site : 03CH11-11Y Condition : PEAK[UNL1] 3m HORN 9120D-HF HORIZONTAL Project : 811726 Setting : 24.5</p>	 <p>Date: 2018.02.19</p> <p>Site : 03CH11-11Y Condition : PEAK[UNL1] 3m HORN 9120D-HF VERTICAL Project : 811726 Setting : 24.5</p>



Band 1 5150~5250MHz
WIFI 802.11ac VHT20 (Harmonic @ 3m)

WIFI	Band 1 5150~5250MHz Harmonic @ 3m	
ANT	802.11ac VHT20 CH36 5180MHz	
1	Horizontal	Vertical
<p>Peak</p> <p>Avg.</p>	<p>Site : 03CH11-HY Condition : PEAK(UNIT) 3m HORN 9120D-HF HORIZONTAL Project : 811726</p>	<p>Site : 03CH11-HY Condition : PEAK(UNIT) 3m HORN 9120D-HF VERTICAL Project : 811726</p>

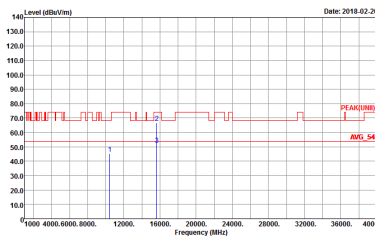
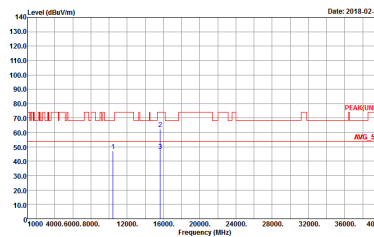

WIFI	Band 1 5150~5250MHz Harmonic @ 3m	
ANT	802.11ac VHT20 CH44 5220MHz	
1	Horizontal	Vertical
Peak Avg.	 <p>Site : 03CH11-11Y Condition : PEAK[UNL1] 3m HORN 9120D-HF HORIZONTAL Project : 811726 Setting : 25</p>	 <p>Site : 03CH11-11Y Condition : PEAK[UNL1] 3m HORN 9120D-HF VERTICAL Project : 811726 Setting : 25</p>

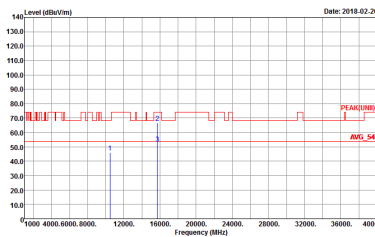
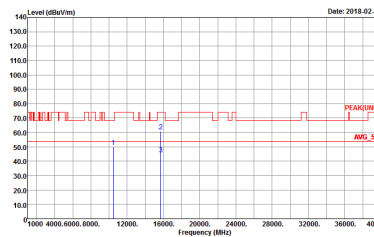

WIFI	Band 1 5150~5250MHz Harmonic @ 3m	
ANT	802.11ac VHT20 CH48 5240MHz	
1	Horizontal	Vertical
<p>Peak</p> <p>Avg.</p>	 <p>Site : 03CH11-11Y Condition : PEAK[UNL1] 3m HORN 9120D-HF HORIZONTAL Project : 811726 Setting : 245</p>	 <p>Site : 03CH11-11Y Condition : PEAK[UNL1] 3m HORN 9120D-HF VERTICAL Project : 811726 Setting : 245</p>



Band 1 5150~5250MHz
WIFI 802.11ac VHT40 (Harmonic @ 3m)

Table with 2 columns: Horizontal and Vertical. Each column contains a spectral plot showing Level (dBm/100MHz) vs Frequency (MHz) with peak and average markers. Includes site and condition details for each plot.

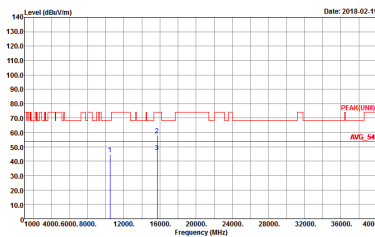
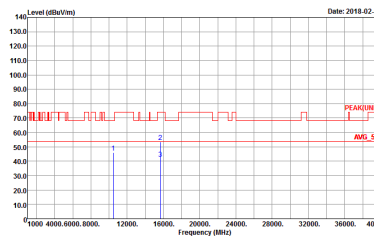

WIFI	Band 1 5150~5250MHz Harmonic @ 3m	
ANT	802.11ac VHT40 CH46 5230MHz	
1	Horizontal	Vertical
<p>Peak</p> <p>Avg.</p>	 <p>Site : 03CH11-11Y Condition : PEAK(UNII) 3m HORN 9120D-HF HORIZONTAL Project : 811726</p>	 <p>Site : 03CH11-11Y Condition : PEAK(UNII) 3m HORN 9120D-HF VERTICAL Project : 811726</p>



**Band 1 5150~5250MHz
WIFI 802.11ac VHT80 (Harmonic @ 3m)**

WIFI	Band 1 5150~5250MHz Harmonic @ 3m	
ANT	802.11ac VHT80 CH42 5210MHz	
1	Horizontal	Vertical
<p>Peak</p> <p>Avg.</p>	<p>Site : 03CH11-HY Condition : PEAK(UNIT) 3m HORN 9120D-HF HORIZONTAL Project : 811726</p>	<p>Site : 03CH11-HY Condition : PEAK(UNIT) 3m HORN 9120D-HF VERTICAL Project : 811726</p>



Emission below 1GHz
5GHz WIFI 802.11a (LF)

WIFI	5GHz WIFI	
ANT	802.11a LF	
1	Horizontal	Vertical
QP / Peak	<p>Site : 03CH11-HY Condition : QP 3m BE-LOG-6111D-LF_ETC HORIZONTAL Detector : Peak Project : 811726</p>	<p>Site : 03CH11-HY Condition : QP 3m BE-LOG-6111D-LF_ETC VERTICAL Detector : Peak Project : 811726</p>



<CDD Mode>

Band 1 - 5150~5250MHz
WIFI 802.11a (Band Edge @ 3m)

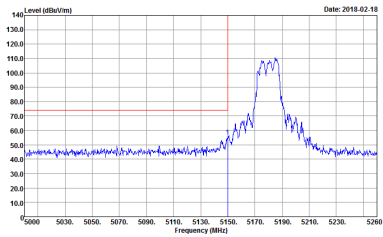
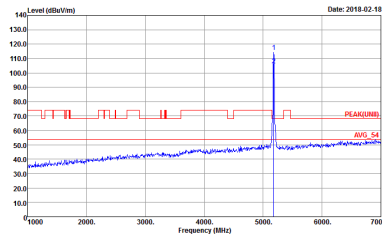
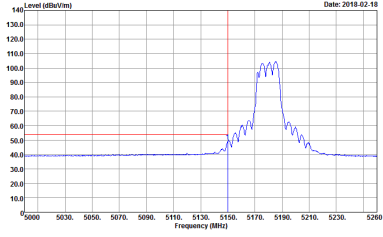
WIFI	Band 1 5150~5250MHz Band Edge @ 3m	
ANT	802.11a CH36 5180MHz	
1+2	Horizontal	Fundamental
Peak	 <p>Site : 03CH11-HY Condition : PEAK_BE_74 3m HORN 9120D-HF HORIZONTAL Detector : Peak Project : 811726 Setting : Z2</p>	 <p>Site : 03CH11-HY Condition : PEAK(LINE) 3m HORN 9120D-HF HORIZONTAL Detector : Peak Project : 811726 Setting : Z2</p>
Avg.	 <p>Site : 03CH11-HY Condition : AV6_BE_54 3m HORN 9120D-HF HORIZONTAL Detector : Peak Project : 811726 Setting : Z2</p>	Left blank

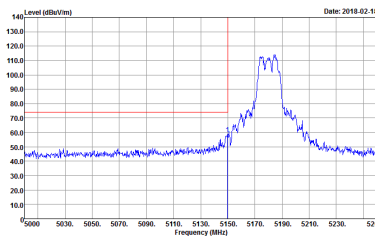
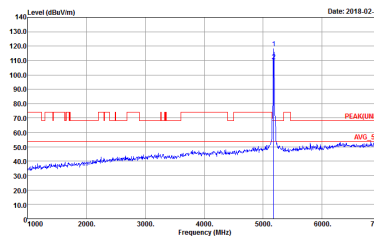
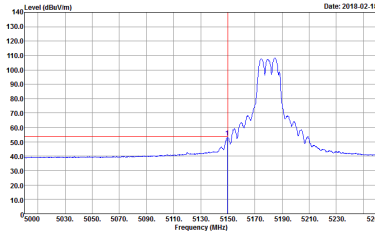

WIFI	Band 1 5150~5250MHz Band Edge @ 3m	
ANT	802.11a CH36 5180MHz	
1+2	Vertical	Fundamental
Peak	 <p>Site : 03CH11-HY Condition : PEAK_BE_74 3m HORN 9120D-HF VERTICAL Detector : Peak Project : 811726 Setting : Z2</p>	 <p>Site : 03CH11-HY Condition : PEAK(UNII) 3m HORN 9120D-HF VERTICAL Detector : Peak Project : 811726 Setting : Z2</p>
Avg.	 <p>Site : 03CH11-HY Condition : AVG_BE_54 3m HORN 9120D-HF VERTICAL Detector : Peak Project : 811726 Setting : Z2</p>	Left blank

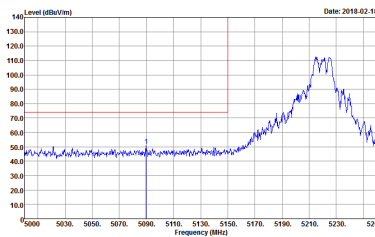
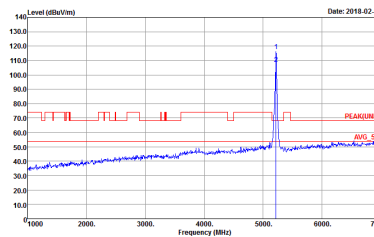
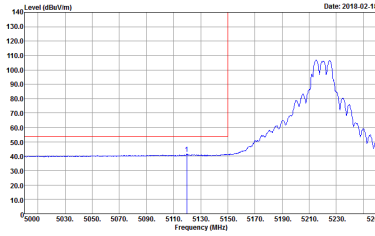

WIFI	Band 1 5150~5250MHz Band Edge @ 3m	
ANT	802.11a CH44 5220MHz - L	
1+2	Horizontal	Fundamental
<p>Peak</p>	 <p>Date: 2018.02.18</p> <p>Site : 03CH11-HY Condition : PEAK_BE_74 3m HORN 9120D-HF HORIZONTAL RBW:1000.000KHz VBW:3000.000KHz SWT:Auto Detector : Peak Project : 811726 Setting : Z5</p>	 <p>Date: 2018.02.18</p> <p>Site : 03CH11-HY Condition : PEAK(UNII) 3m HORN 9120D-HF HORIZONTAL RBW:1000.000KHz VBW:3000.000KHz SWT:Auto Detector : Peak Project : 811726 Setting : Z5</p>
<p>Avg.</p>	 <p>Date: 2018.02.18</p> <p>Site : 03CH11-HY Condition : AVG_BE_54 3m HORN 9120D-HF HORIZONTAL RBW:1000.000KHz VBW:1000KHz SWT:Auto Detector : Peak Project : 811726 Setting : Z5</p>	<p>Left blank</p>

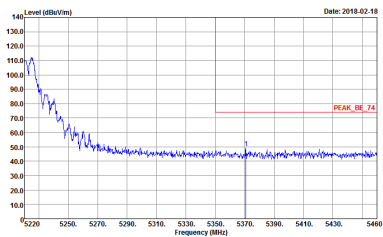
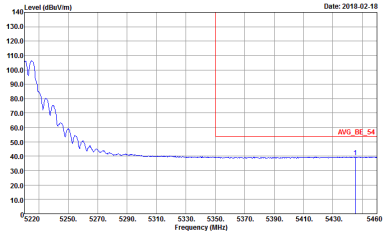

WIFI	Band 1 5150~5250MHz Band Edge @ 3m	
ANT	802.11a CH44 5220MHz - R	
1+2	Horizontal	Fundamental
<p>Peak</p>	 <p>Site : 03CH11-HY Condition : PEAK_BE_74 3m HORN 91200-HF HORIZONTAL Detector : Peak Project : 811726 Setting : Z5</p>	<p>Left blank</p>
<p>Avg.</p>	 <p>Site : 03CH11-HY Condition : AVG_BE_54 3m HORN 91200-HF HORIZONTAL Detector : Peak Project : 811726 Setting : Z5</p>	<p>Left blank</p>

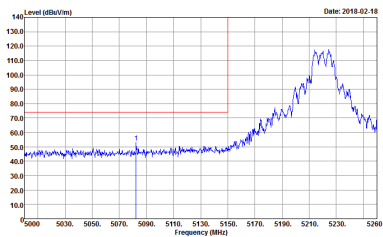
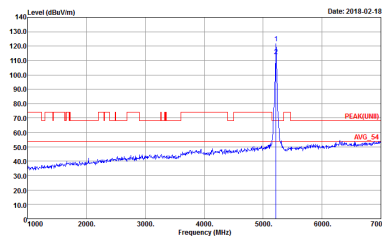
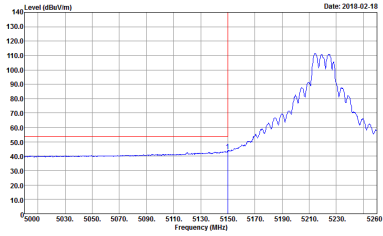

WIFI	Band 1 5150~5250MHz Band Edge @ 3m	
ANT	802.11a CH44 5220MHz - L	
1+2	Vertical	Fundamental
Peak	 <p>Site : 03CH11-HY Condition : PEAK_BE_74 3m HORN 9120D-HF VERTICAL Detector : Peak Project : 811726 Setting : Z5</p>	 <p>Site : 03CH11-HY Condition : PEAKUNII 3m HORN 9120D-HF VERTICAL Detector : Peak Project : 811726 Setting : Z5</p>
Avg.	 <p>Site : 03CH11-HY Condition : AVG_BE_54 3m HORN 9120D-HF VERTICAL Detector : Peak Project : 811726 Setting : Z5</p>	Left blank

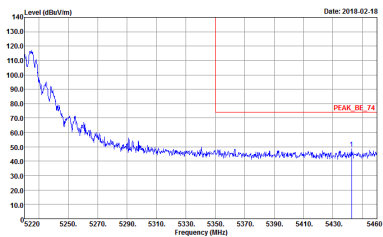
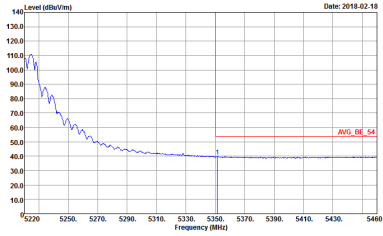

WIFI	Band 1 5150~5250MHz Band Edge @ 3m	
ANT	802.11a CH44 5220MHz - R	
1+2	Vertical	Fundamental
<p>Peak</p>	 <p>Site : 03CH11-HY Condition : PEAK_BE_74 3m HORN 91200-HF VERTICAL Detector : Peak Project : 811726 Setting : Z5</p>	<p>Left blank</p>
<p>Avg.</p>	 <p>Site : 03CH11-HY Condition : AVG_BE_54 3m HORN 91200-HF VERTICAL Detector : Peak Project : 811726 Setting : Z5</p>	<p>Left blank</p>



WIFI	Band 1 5150~5250MHz Band Edge @ 3m	
ANT	802.11a CH48 5240MHz - L	
1+2	Horizontal	Fundamental
<p>Peak</p>	<p>Site : 03CH11-HY Condition : PEAK_BE_74 3m HORN 91200-HF HORIZONTAL Detector : Peak Project : 811726 Setting : Z6</p>	<p>Site : 03CH11-HY Condition : PEAK(UNII) 3m HORN 91200-HF HORIZONTAL Detector : Peak Project : 811726 Setting : Z6</p>
<p>Avg.</p>	<p>Site : 03CH11-HY Condition : AVG_BE_54 3m HORN 91200-HF HORIZONTAL Detector : Peak Project : 811726 Setting : Z6</p>	<p>Left blank</p>

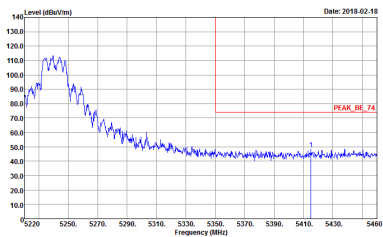
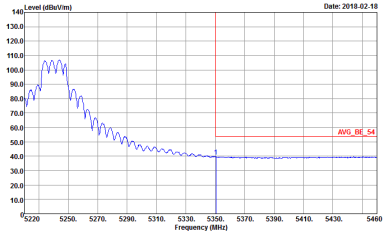

WIFI	Band 1 5150~5250MHz Band Edge @ 3m	
ANT	802.11a CH48 5240MHz - R	
1+2	Horizontal	Fundamental
<p>Peak</p>	 <p>Site : 03CH11-HY Condition : PEAK_BE_74 3m HORN 91200-HF HORIZONTAL Detector : Peak Project : 811726 Setting : Z6</p>	<p>Left blank</p>
<p>Avg.</p>	 <p>Site : 03CH11-HY Condition : AVG_BE_54 3m HORN 91200-HF HORIZONTAL Detector : Peak Project : 811726 Setting : Z6</p>	<p>Left blank</p>

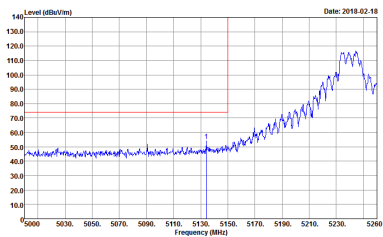
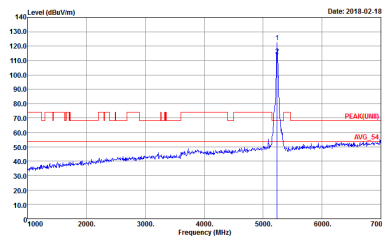
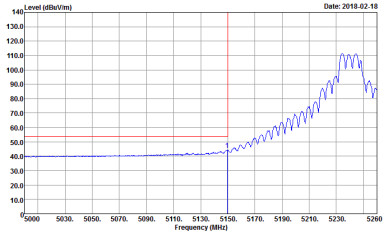

WIFI	Band 1 5150~5250MHz Band Edge @ 3m	
ANT	802.11a CH48 5240MHz - L	
1+2	Vertical	Fundamental
Peak	 <p>Site : 03CH11-HY Condition : PEAK_BE_74 3m HORN 91200-HF VERTICAL Detector : Peak Project : 811726 Setting : Z6</p>	 <p>Site : 03CH11-HY Condition : PEAK(UNII) 3m HORN 91200-HF VERTICAL Detector : Peak Project : 811726 Setting : Z6</p>
Avg.	 <p>Site : 03CH11-HY Condition : AVG_BE_54 3m HORN 91200-HF VERTICAL Detector : Peak Project : 811726 Setting : Z6</p>	Left blank

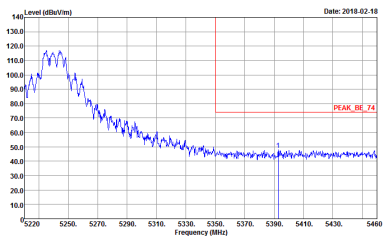
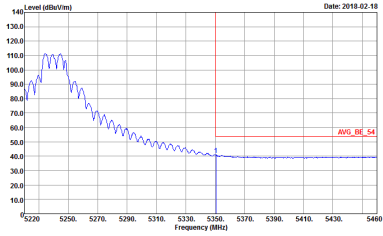

WIFI	Band 1 5150~5250MHz Band Edge @ 3m	
ANT	802.11a CH48 5240MHz - R	
1+2	Vertical	Fundamental
<p>Peak</p>	 <p>Site : 03CH11-HY Condition : PEAK_BE_74 3m HORN 91200-HF VERTICAL : RBW:1000.000KHz VBW:3000.000KHz SWT:Auto Detector : Peak Project : 811726 Setting : 26</p>	<p>Left blank</p>
<p>Avg.</p>	 <p>Site : 03CH11-HY Condition : AVG_BE_54 3m HORN 91200-HF VERTICAL : RBW:1000.000KHz VBW:1000KHz SWT:Auto Detector : Peak Project : 811726 Setting : 26</p>	<p>Left blank</p>



Band 1 5150~5250MHz
WIFI 802.11ac VHT20 (Band Edge @ 3m)

WIFI	Band 1 5150~5250MHz Band Edge @ 3m	
ANT	802.11ac VHT20 CH36 5180MHz	
1+2	Horizontal	Fundamental
Peak	<p>Site : 03CH11-HY Condition : PEAK_BE_74 3m HORN 9120D-JF HORIZONTAL Detector : Peak Project : 811726 Setting : ZZ</p>	<p>Site : 03CH11-HY Condition : PEAK_74 3m HORN 9120D-JF HORIZONTAL Detector : Peak Project : 811726 Setting : ZZ</p>
Avg.	<p>Site : 03CH11-HY Condition : AVG_BE_54 3m HORN 9120D-JF HORIZONTAL Detector : Peak Project : 811726 Setting : ZZ</p>	Left blank

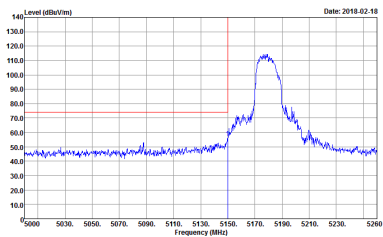
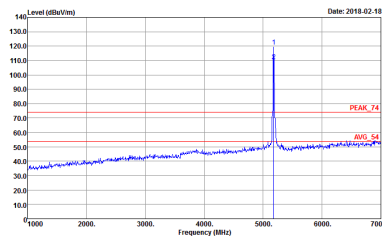
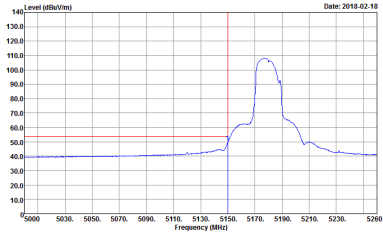

WIFI	Band 1 5150~5250MHz Band Edge @ 3m	
ANT	802.11ac VHT20 CH36 5180MHz	
1+2	Vertical	Fundamental
Peak	 <p>Site : 03CH11-HY Condition : PEAK_BE_74 3m HORN 91200-HF VERTICAL Detector : Peak Project : 811726 Setting : Z2</p>	 <p>Site : 03CH11-HY Condition : PEAK_74 3m HORN 91200-HF VERTICAL Detector : Peak Project : 811726 Setting : Z2</p>
Avg.	 <p>Site : 03CH11-HY Condition : AVG_BE_54 3m HORN 91200-HF VERTICAL Detector : Peak Project : 811726 Setting : Z2</p>	Left blank

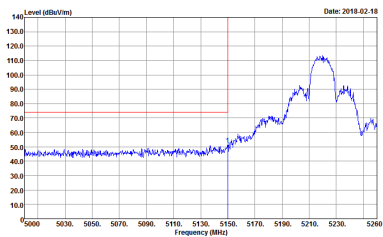
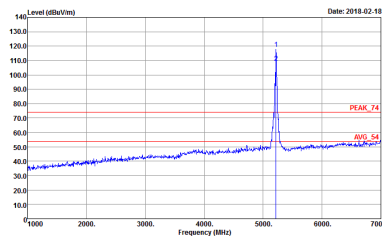
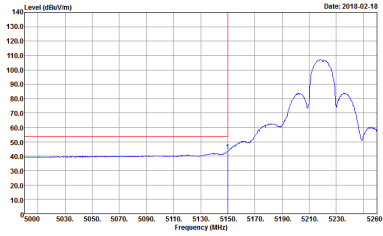

WIFI	Band 1 5150~5250MHz Band Edge @ 3m	
ANT	802.11ac VHT20 CH44 5220MHz - L	
1+2	Horizontal	Fundamental
<p>Peak</p>	 <p>Site : 03CH11-HY Condition : PEAK_BE_74 3m HORN 91200-HF HORIZONTAL Detector : Peak Project : 811726 Setting : 25.5</p>	 <p>Site : 03CH11-HY Condition : PEAK_74 3m HORN 91200-HF HORIZONTAL Detector : Peak Project : 811726 Setting : 25.5</p>
<p>Avg.</p>	 <p>Site : 03CH11-HY Condition : AVG_BE_54 3m HORN 91200-HF HORIZONTAL Detector : Peak Project : 811726 Setting : 25.5</p>	<p>Left blank</p>

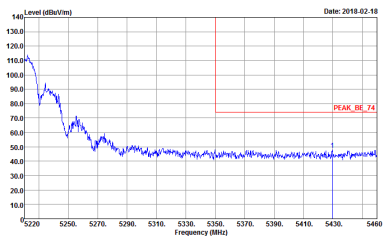
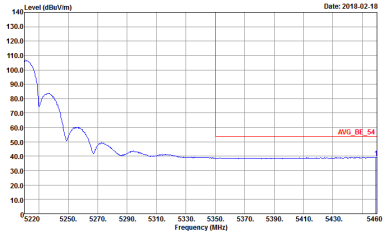

WIFI	Band 1 5150~5250MHz Band Edge @ 3m	
ANT	802.11ac VHT20 CH44 5220MHz - R	
1+2	Horizontal	Fundamental
<p>Peak</p>	 <p>Site : 03CH11-HY Condition : PEAK_BE_74 3m HORN 91200-HF HORIZONTAL Detector : Peak Project : 811726 Setting : 25.5</p>	<p>Left blank</p>
<p>Avg.</p>	 <p>Site : 03CH11-HY Condition : AVG_BE_54 3m HORN 91200-HF HORIZONTAL Detector : Peak Project : 811726 Setting : 25.5</p>	<p>Left blank</p>



WIFI	Band 1 5150~5250MHz Band Edge @ 3m	
ANT	802.11ac VHT20 CH44 5220MHz - L	
1+2	Vertical	Fundamental
<p>Peak</p>	<p>Site : 03CH11-HY Condition : PEAK_BE_74 3m HORN 91200-HF VERTICAL Detector : Peak Project : 811726 Setting : 25.5</p>	<p>Site : 03CH11-HY Condition : PEAK_74 3m HORN 91200-HF VERTICAL Detector : Peak Project : 811726 Setting : 25.5</p>
<p>Avg.</p>	<p>Site : 03CH11-HY Condition : AVG_BE_54 3m HORN 91200-HF VERTICAL Detector : Peak Project : 811726 Setting : 25.5</p>	<p>Left blank</p>



WIFI	Band 1 5150~5250MHz Band Edge @ 3m	
ANT	802.11ac VHT20 CH44 5220MHz - R	
1+2	Vertical	Fundamental
<p>Peak</p>	<p>Site : 03CH11-HY Condition : PEAK_BE_74 3m HORN 91200-HF VERTICAL Detector : Peak Project : 811726 Setting : 25.5</p>	<p>Left blank</p>
<p>Avg.</p>	<p>Site : 03CH11-HY Condition : AVG_BE_54 3m HORN 91200-HF VERTICAL Detector : Peak Project : 811726 Setting : 25.5</p>	<p>Left blank</p>



WIFI	Band 1 5150~5250MHz Band Edge @ 3m	
ANT	802.11ac VHT20 CH48 5240MHz - L	
1+2	Horizontal	Fundamental
<p>Peak</p>	<p>Site : 03CH11-HY Condition : PEAK_BE_74 3m HORN 91200-HF HORIZONTAL Detector : Peak Project : 811726 Setting : 25.5</p>	<p>Site : 03CH11-HY Condition : PEAK(UNII) 3m HORN 91200-HF HORIZONTAL Detector : Peak Project : 811726 Setting : 25.5</p>
<p>Avg.</p>	<p>Site : 03CH11-HY Condition : AVG_BE_54 3m HORN 91200-HF HORIZONTAL Detector : Peak Project : 811726 Setting : 25.5</p>	<p>Left blank</p>

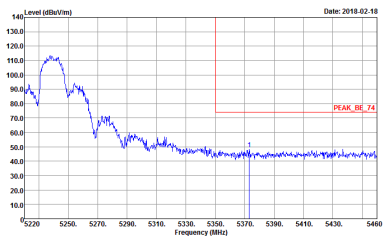
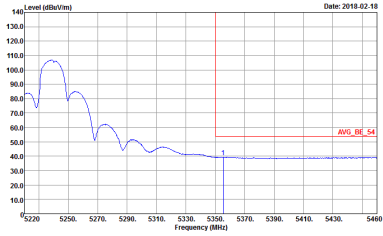

WIFI	Band 1 5150~5250MHz Band Edge @ 3m	
ANT	802.11ac VHT20 CH48 5240MHz - R	
1+2	Horizontal	Fundamental
<p>Peak</p>	 <p>Site : 03CH11-HY Condition : PEAK_BE_74 3m HORN 91200-HF HORIZONTAL Detector : Peak Project : 811726 Setting : 25.5</p>	<p>Left blank</p>
<p>Avg.</p>	 <p>Site : 03CH11-HY Condition : AVG_BE_54 3m HORN 91200-HF HORIZONTAL Detector : Peak Project : 811726 Setting : 25.5</p>	<p>Left blank</p>



WIFI	Band 1 5150~5250MHz Band Edge @ 3m	
ANT	802.11ac VHT20 CH48 5240MHz - L	
1+2	Vertical	Fundamental
<p>Peak</p>	<p>Site : 03CH11-HY Condition : PEAK_BE_74 3m HORN 91200-HF VERTICAL Detector : Peak Project : 811726 Setting : 25.5</p>	<p>Site : 03CH11-HY Condition : PEAK(LIMB) 3m HORN 91200-HF VERTICAL Detector : Peak Project : 811726 Setting : 25.5</p>
<p>Avg.</p>	<p>Site : 03CH11-HY Condition : AVG_BE_54 3m HORN 91200-HF VERTICAL Detector : Peak Project : 811726 Setting : 25.5</p>	<p>Left blank</p>

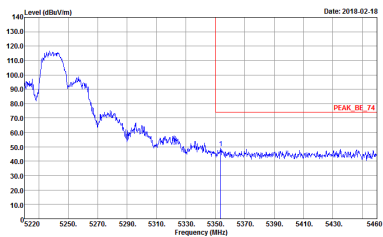
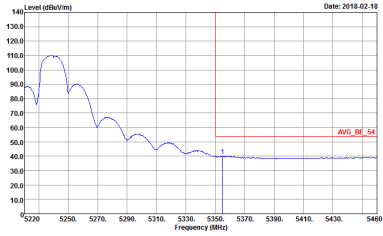

WIFI	Band 1 5150~5250MHz Band Edge @ 3m	
ANT	802.11ac VHT20 CH48 5240MHz - R	
1+2	Vertical	Fundamental
<p>Peak</p>	 <p>Site : 03CH11-HY Condition : PEAK_BE_74 3m HORN 91200-HF VERTICAL Detector : Peak Project : 811726 Setting : 25.5</p>	<p>Left blank</p>
<p>Avg.</p>	 <p>Site : 03CH11-HY Condition : AVG_BE_54 3m HORN 91200-HF VERTICAL Detector : Peak Project : 811726 Setting : 25.5</p>	<p>Left blank</p>



Band 1 5150~5250MHz
WIFI 802.11ac VHT40 (Band Edge @ 3m)

WIFI	Band 1 5150~5250MHz Band Edge @ 3m	
ANT	802.11ac VHT40 CH38 5190MHz - L	
1+2	Horizontal	Fundamental
Peak	<p>Site : 03CH11-HY Condition : PEAK_BE_74 3m HORN 9120D-HF HORIZONTAL RBW:1000.000KHz VBW:3000.000KHz SWT:Auto Detector : Peak Project : 811726 Setting : 20</p>	<p>Site : 03CH11-HY Condition : PEAK(UNIT) 3m HORN 9120D-HF HORIZONTAL RBW:1000.000KHz VBW:3000.000KHz SWT:Auto Detector : Peak Project : 811726 Setting : 20</p>
Avg.	<p>Site : 03CH11-HY Condition : AVG_BE_54 3m HORN 9120D-HF HORIZONTAL RBW:1000.000KHz VBW:1.000KHz SWT:Auto Detector : Peak Project : 811726 Setting : 20</p>	<p>Left blank</p>

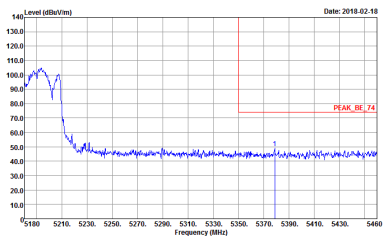
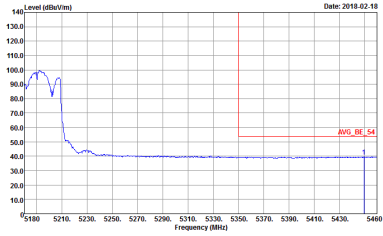

WIFI	Band 1 5150~5250MHz Band Edge @ 3m	
ANT	802.11ac VHT40 CH38 5190MHz - R	
1+2	Horizontal	Fundamental
<p>Peak</p>	 <p>Site : 03CH11-HY Condition : PEAK_BE_74 3m HORN 91200-HF HORIZONTAL Detector : Peak Project : 811726 Setting : Z0</p>	<p>Left blank</p>
<p>Avg.</p>	 <p>Site : 03CH11-HY Condition : AVG_BE_54 3m HORN 91200-HF HORIZONTAL Detector : Peak Project : 811726 Setting : Z0</p>	<p>Left blank</p>

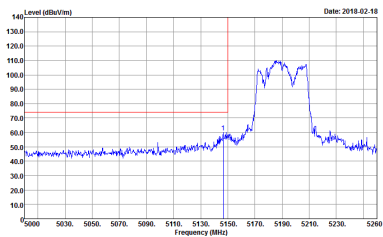
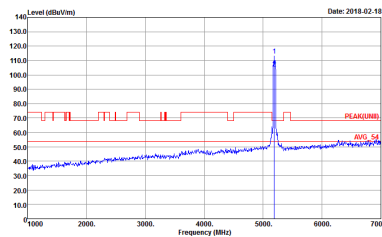
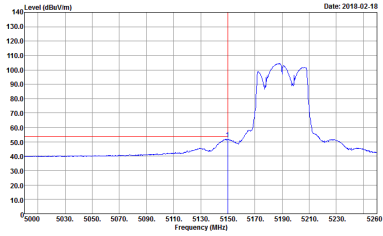

WIFI	Band 1 5150~5250MHz Band Edge @ 3m	
ANT	802.11ac VHT40 CH38 5190MHz - L	
1+2	Vertical	Fundamental
<p>Peak</p>	 <p>Date: 2018.02.18</p> <p>Site : 03CH11-HY Condition : PEAK_BE_74 3m HORN 9120D-HF VERTICAL : RBW:1000.000KHz VBW:3000.000KHz SWT:Auto Detector : Peak Project : 811726 Setting : Z0</p>	 <p>Date: 2018.02.18</p> <p>Site : 03CH11-HY Condition : PEAK(UNII) 3m HORN 9120D-HF VERTICAL : RBW:1000.000KHz VBW:3000.000KHz SWT:Auto Detector : Peak Project : 811726 Setting : Z0</p>
<p>Avg.</p>	 <p>Date: 2018.02.18</p> <p>Site : 03CH11-HY Condition : AVG_BE_54 3m HORN 9120D-HF VERTICAL : RBW:1000.000KHz VBW:1000KHz SWT:Auto Detector : Peak Project : 811726 Setting : Z0</p>	<p>Left blank</p>

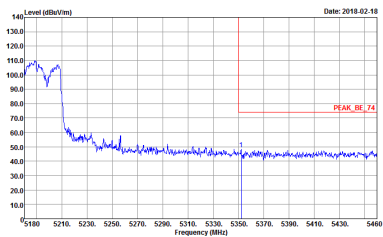
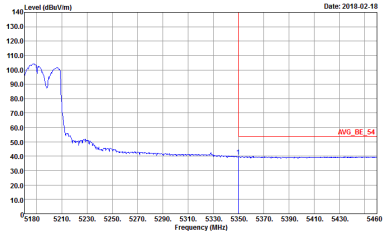

WIFI	Band 1 5150~5250MHz Band Edge @ 3m	
ANT	802.11ac VHT40 CH38 5190MHz - R	
1+2	Vertical	Fundamental
<p>Peak</p>	 <p>Site : 03CH11-HY Condition : PEAK_BE_74 3m HORN 91200-HF VERTICAL Detector : Peak Project : 811726 Setting : Z0</p>	<p>Left blank</p>
<p>Avg.</p>	 <p>Site : 03CH11-HY Condition : AVG_BE_54 3m HORN 91200-HF VERTICAL Detector : Peak Project : 811726 Setting : Z0</p>	<p>Left blank</p>

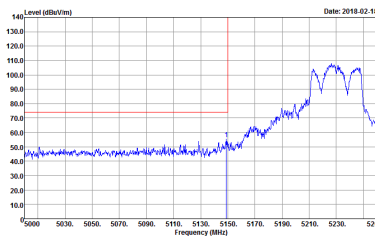
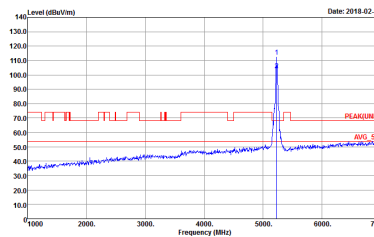
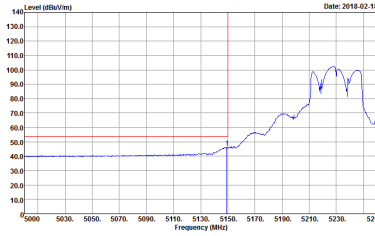

WIFI	Band 1 5150~5250MHz Band Edge @ 3m	
ANT	802.11ac VHT40 CH46 5230MHz - L	
1+2	Horizontal	Fundamental
<p>Peak</p>	 <p>Site : 03CH11-HY Condition : PEAK_BE_74 3m HORN 9120D-HF HORIZONTAL Detector : Peak Project : 811726 Setting : 23.5</p>	 <p>Site : 03CH11-HY Condition : PEAK(UNII) 3m HORN 9120D-HF HORIZONTAL Detector : Peak Project : 811726 Setting : 23.5</p>
<p>Avg.</p>	 <p>Site : 03CH11-HY Condition : AVG_BE_54 3m HORN 9120D-HF HORIZONTAL Detector : Peak Project : 811726 Setting : 23.5</p>	<p>Left blank</p>

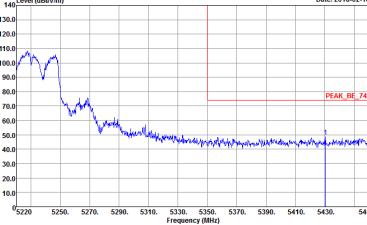
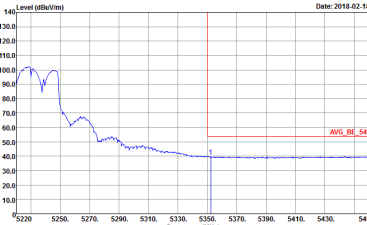

WIFI	Band 1 5150~5250MHz Band Edge @ 3m	
ANT	802.11ac VHT40 CH46 5230MHz - R	
1+2	Horizontal	Fundamental
<p>Peak</p>	 <p>Site : 03CH11-HY Condition : PEAK_BE_74 3m HORN 91200-HF HORIZONTAL Detector : Peak Project : 811726 Setting : 23.5</p>	<p>Left blank</p>
<p>Avg.</p>	 <p>Site : 03CH11-HY Condition : AVG_BE_54 3m HORN 91200-HF HORIZONTAL Detector : Peak Project : 811726 Setting : 23.5</p>	<p>Left blank</p>



WIFI	Band 1 5150~5250MHz Band Edge @ 3m	
ANT	802.11ac VHT40 CH46 5230MHz - L	
1+2	Vertical	Fundamental
<p>Peak</p>		
<p>Avg.</p>		<p>Left blank</p>



WIFI	Band 1 5150~5250MHz Band Edge @ 3m	
ANT	802.11ac VHT40 CH46 5230MHz - R	
1+2	Vertical	Fundamental
<p>Peak</p>	<p>Site : 03CH11-HY Condition : PEAK_BE_74 3m HORN 91200-HF VERTICAL Detector : Peak Project : 811726 Setting : 23.5</p>	<p>Left blank</p>
<p>Avg.</p>	<p>Site : 03CH11-HY Condition : AVG_BE_54 3m HORN 91200-HF VERTICAL Detector : Peak Project : 811726 Setting : 23.5</p>	<p>Left blank</p>

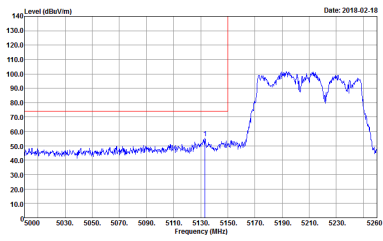
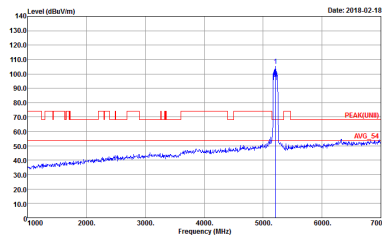
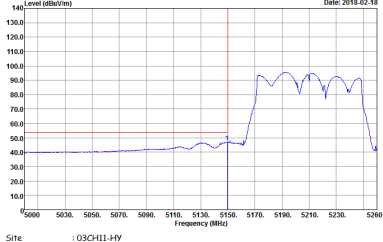

Band 1 5150~5250MHz
WIFI 802.11ac VHT80 (Band Edge @ 3m)

WIFI	Band 1 5150~5250MHz Band Edge @ 3m	
ANT	802.11ac VHT80 CH42 5210MHz - L	
1+2	Horizontal	Fundamental
Peak	 <p>Site : 03CH11-HY Condition : PEAK_BE_74 3m HORN 91200-HF HORIZONTAL Detector : Peak Project : 811726 Setting : 20</p>	 <p>Site : 03CH11-HY Condition : PEAK(UNIT) 3m HORN 91200-HF HORIZONTAL Detector : Peak Project : 811726 Setting : 20</p>
Avg.	 <p>Site : 03CH11-HY Condition : AVG_BE_54 3m HORN 91200-HF HORIZONTAL Detector : Peak Project : 811726 Setting : 20</p>	Left blank

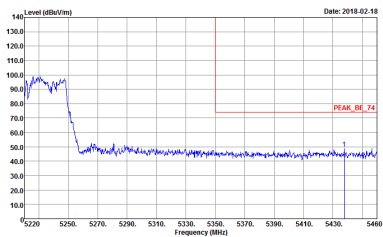
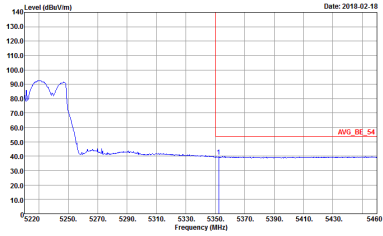

WIFI	Band 1 5150~5250MHz Band Edge @ 3m	
ANT	802.11ac VHT80 CH42 5210MHz - R	
1+2	Horizontal	Fundamental
<p>Peak</p>	 <p>Site : 03CH11-HY Condition : PEAK_BE_74 3m HORN 91200-HF HORIZONTAL Detector : Peak Project : 811726 Setting : Z0</p>	<p>Left blank</p>
<p>Avg.</p>	 <p>Site : 03CH11-HY Condition : AVG_BE_54 3m HORN 91200-HF HORIZONTAL Detector : Peak Project : 811726 Setting : Z0</p>	<p>Left blank</p>



WIFI	Band 1 5150~5250MHz Band Edge @ 3m	
ANT	802.11ac VHT80 CH42 5210MHz - L	
1+2	Vertical	Fundamental
<p>Peak</p>	<p>Site : 03CH11-HY Condition : PEAK_BE_74 3m HORN 9120D-HF VERTICAL Detector : Peak Project : 811726 Setting : Z0</p>	<p>Site : 03CH11-HY Condition : PEAK(LIMB) 3m HORN 9120D-HF VERTICAL Detector : Peak Project : 811726 Setting : Z0</p>
<p>Avg.</p>	<p>Site : 03CH11-HY Condition : AVG_BE_54 3m HORN 9120D-HF VERTICAL Detector : Peak Project : 811726 Setting : Z0</p>	<p>Left blank</p>



WIFI	Band 1 5150~5250MHz Band Edge @ 3m	
ANT	802.11ac VHT80 CH42 5210MHz - R	
1+2	Vertical	Fundamental
<p>Peak</p>	<p>Site : 03CH11-HY Condition : PEAK_BE_74 3m HORN 91200-HF VERTICAL : RBW:1000.000KHz VBW:3000.000KHz SWT:Auto Detector : Peak Project : 811726 Setting : Z0</p>	<p>Left blank</p>
<p>Avg.</p>	<p>Site : 03CH11-HY Condition : AVG_BE_54 3m HORN 91200-HF VERTICAL : RBW:1000.000KHz VBW:1000KHz SWT:Auto Detector : Peak Project : 811726 Setting : Z0</p>	<p>Left blank</p>



Band 1 - 5150~5250MHz
WIFI 802.11a (Harmonic @ 3m)

WIFI	Band 1 5150~5250MHz Harmonic @ 3m	
ANT	802.11a CH36 5180MHz	
1+2	Horizontal	Vertical
Peak Avg.	<p>Site : 03CH11-HY Condition : PEAK(LINE) 3m HORN 9120D-HF HORIZONTAL Project : 811726</p>	<p>Site : 03CH11-HY Condition : PEAK(LINE) 3m HORN 9120D-HF VERTICAL Project : 811726</p>

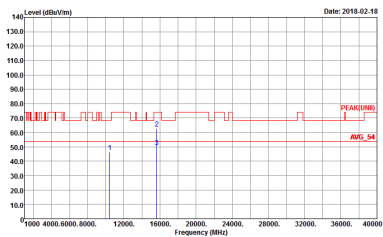
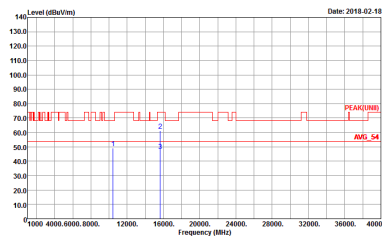

WIFI	Band 1 5150~5250MHz Harmonic @ 3m	
ANT	802.11a CH44 5220MHz	
1+2	Horizontal	Vertical
<p>Peak</p> <p>Avg.</p>	 <p>Site : 03CH11-11Y Condition : PEAK[UNL1] 3m HORN 9120D-HF HORIZONTAL Project : 811726 Setting : 25</p>	 <p>Site : 03CH11-11Y Condition : PEAK[UNL1] 3m HORN 9120D-HF VERTICAL Project : 811726 Setting : 25</p>

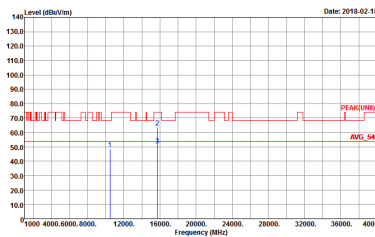
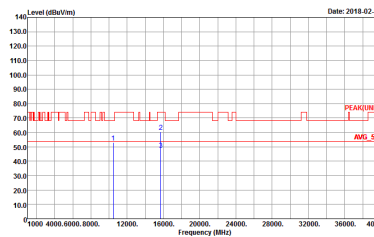

WIFI	Band 1 5150~5250MHz Harmonic @ 3m	
ANT	802.11a CH48 5240MHz	
1+2	Horizontal	Vertical
<p>Peak</p> <p>Avg.</p>	 <p>Site : 03CH11-11Y Condition : PEAK(UNII) 3m HORN 9120D-HF HORIZONTAL Project : 811726</p>	 <p>Site : 03CH11-11Y Condition : PEAK(UNII) 3m HORN 9120D-HF VERTICAL Project : 811726</p>

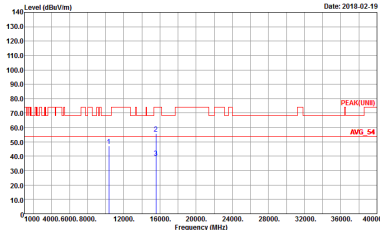
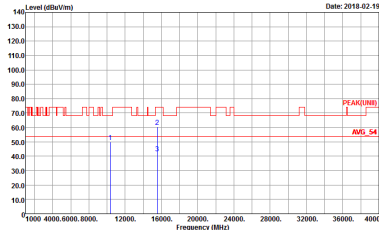

**Band 1 5150~5250MHz
WIFI 802.11ac VHT20 (Harmonic @ 3m)**

WIFI	Band 1 5150~5250MHz Harmonic @ 3m	
ANT	802.11ac VHT20 CH36 5180MHz	
1+2	Horizontal	Vertical
<p>Peak</p> <p>Avg.</p>	 <p>Site : 03CH11-HY Condition : PEAK(UNIT) 3m HORN 9120D-HF HORIZONTAL Project : 811726</p>	 <p>Site : 03CH11-HY Condition : PEAK(UNIT) 3m HORN 9120D-HF VERTICAL Project : 811726</p>

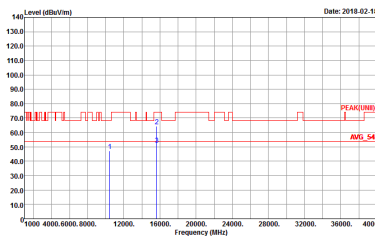
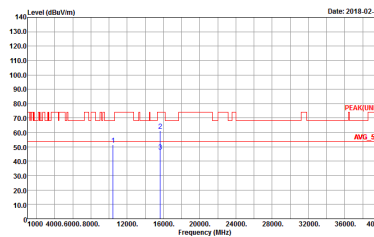

WIFI	Band 1 5150~5250MHz Harmonic @ 3m	
ANT	802.11ac VHT20 CH44 5220MHz	
1+2	Horizontal	Vertical
<p>Peak</p> <p>Avg.</p>	 <p>Site : 03CH11-11Y Condition : PEAK(UNII) 3m HORN 9120D-HF HORIZONTAL Project : 811726 Setting : 25.5</p>	 <p>Site : 03CH11-11Y Condition : PEAK(UNII) 3m HORN 9120D-HF VERTICAL Project : 811726 Setting : 25.5</p>

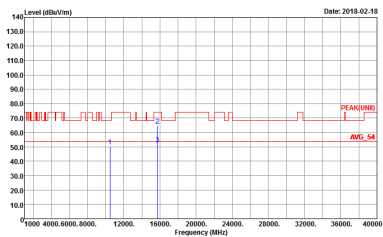
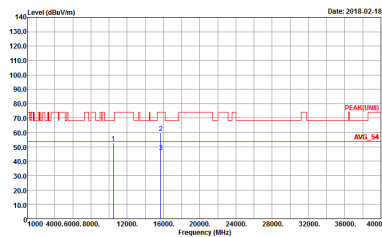

WIFI	Band 1 5150~5250MHz Harmonic @ 3m	
ANT	802.11ac VHT20 CH48 5240MHz	
1+2	Horizontal	Vertical
<p>Peak</p> <p>Avg.</p>	 <p>Site : 03CH11-4Y Condition : PEAK[UNL1] 3m HORN 9120D-HF HORIZONTAL Project : 811726 Setting : 25.5</p>	 <p>Site : 03CH11-4Y Condition : PEAK[UNL1] 3m HORN 9120D-HF VERTICAL Project : 811726 Setting : 25.5</p>



Band 1 5150~5250MHz
WIFI 802.11ac VHT40 (Harmonic @ 3m)

Table with 4 columns: WIFI, ANT, 1+2, and two sub-columns for Horizontal and Vertical. It contains two spectral plots showing Level (dBm/100MHz) vs Frequency (MHz) with peak and average markers.

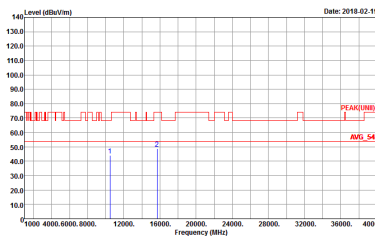
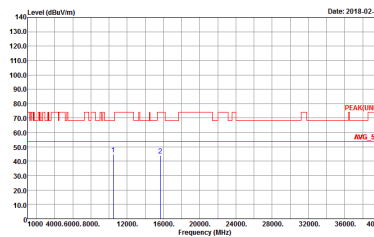

WIFI	Band 1 5150~5250MHz Harmonic @ 3m	
ANT	802.11ac VHT40 CH46 5230MHz	
1+2	Horizontal	Vertical
<p>Peak</p> <p>Avg.</p>	 <p>Site : 03CH11-11Y Condition : PEAK(UNL1) 3m HORN 9120D-HF HORIZONTAL Project : 811726</p>	 <p>Site : 03CH11-11Y Condition : PEAK(UNL1) 3m HORN 9120D-HF VERTICAL Project : 811726</p>



**Band 1 5150~5250MHz
WIFI 802.11ac VHT80 (Harmonic @ 3m)**

WIFI	Band 1 5150~5250MHz Harmonic @ 3m	
ANT	802.11ac VHT80 CH42 5210MHz	
1+2	Horizontal	Vertical
<p>Peak</p> <p>Avg.</p>	<p>Site : 03CH11-HY Condition : PEAK(UNIT) 3m HORN 9120D-HF HORIZONTAL Project : 811726</p>	<p>Site : 03CH11-HY Condition : PEAK(UNIT) 3m HORN 9120D-HF VERTICAL Project : 811726</p>



Emission below 1GHz
5GHz WIFI 802.11a (LF)

WIFI	5GHz WIFI	
ANT	802.11a LF	
1+2	Horizontal	Vertical
QP / Peak	<p>Site : 03CH11-HY Condition : QP 3m BE-LOG-6111D-LF_ETC HORIZONTAL Detector : Peak Project : 811726</p>	<p>Site : 03CH11-HY Condition : QP 3m BE-LOG-6111D-LF_ETC VERTICAL Detector : Peak Project : 811726</p>



<TXBF Mode>

Band 1 - 5150~5250MHz
WIFI 802.11ac VHT20 (Band Edge @ 3m)

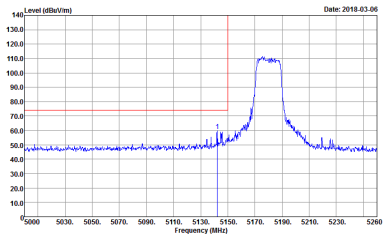
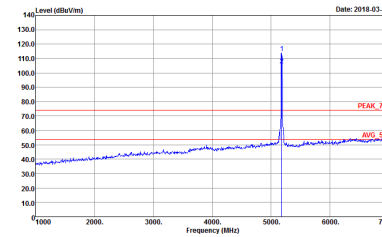
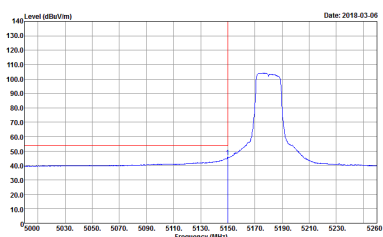
WIFI	Band 1 5150~5250MHz Band Edge @ 3m	
ANT	802.11ac VHT20 CH36 5180MHz	
1+2	Horizontal	Fundamental
Peak	 <p>Site : 03CH11-HY Condition : PEAK_BE_74 3m HORN 91200-HF HORIZONTAL : RBW:1000.000KHz VBW:3000.000KHz SWT:Auto Detector : Peak Project : 811726 Setting : Z5</p>	 <p>Site : 03CH11-HY Condition : PEAK_74 3m HORN 91200-HF HORIZONTAL : RBW:1000.000KHz VBW:3000.000KHz SWT:Auto Detector : Peak Project : 811726 Setting : Z5</p>
Avg.	 <p>Site : 03CH11-HY Condition : AV6_BE_54 3m HORN 91200-HF HORIZONTAL : RBW:1000.000KHz VBW:0.300KHz SWT:Auto Detector : Peak Project : 811726 Setting : Z5</p>	Left blank



WIFI	Band 1 5150~5250MHz Band Edge @ 3m	
ANT	802.11ac VHT20 CH36 5180MHz	
1+2	Vertical	Fundamental
<p>Peak</p>	<p>Date: 2018-03-06</p> <p>Site : 03CH11-HY Condition : PEAK_BE_74 3m HORN 91200-HF VERTICAL : RBW:1000.000KHz VBW:3000.000KHz SWT:Auto Detector : Peak Project : 811726 Setting : Z5</p>	<p>Date: 2018-03-06</p> <p>Site : 03CH11-HY Condition : PEAK_74 3m HORN 91200-HF VERTICAL : RBW:1000.000KHz VBW:3000.000KHz SWT:Auto Detector : Peak Project : 811726 Setting : Z5</p>
<p>Avg.</p>	<p>Date: 2018-03-06</p> <p>Site : 03CH11-HY Condition : AVG_BE_54 3m HORN 91200-HF VERTICAL : RBW:1000.000KHz VBW:3.000KHz SWT:Auto Detector : Peak Project : 811726 Setting : Z5</p>	<p>Left blank</p>

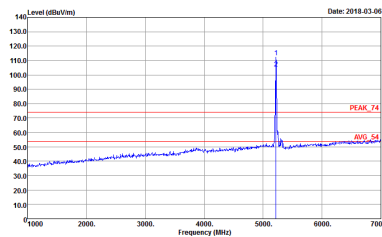
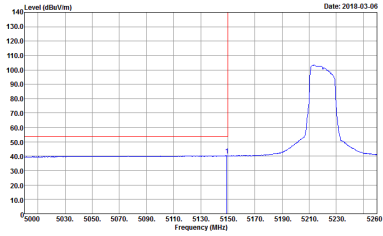

WIFI	Band 1 5150~5250MHz Band Edge @ 3m	
ANT	802.11ac VHT20 CH44 5220MHz - L	
1+2	Horizontal	Fundamental
<p>Peak</p>	 <p>Site : 03CH11-HY Condition : PEAK_BE_74 3m HORN 91200-HF HORIZONTAL Detector : Peak Project : 811726 Setting : Z5</p>	 <p>Site : 03CH11-HY Condition : PEAK_74 3m HORN 91200-HF HORIZONTAL Detector : Peak Project : 811726 Setting : Z5</p>
<p>Avg.</p>	 <p>Site : 03CH11-HY Condition : AVG_BE_54 3m HORN 91200-HF HORIZONTAL Detector : Peak Project : 811726 Setting : Z5</p>	<p>Left blank</p>



WIFI	Band 1 5150~5250MHz Band Edge @ 3m	
ANT	802.11ac VHT20 CH44 5220MHz - R	
1+2	Horizontal	Fundamental
<p>Peak</p>		<p>Left blank</p>
<p>Avg.</p>		<p>Left blank</p>



WIFI	Band 1 5150~5250MHz Band Edge @ 3m	
ANT	802.11ac VHT20 CH44 5220MHz - L	
1+2	Vertical	Fundamental
Peak	<p> Site : 03CH11-HY Condition : PEAK_BE_74 3m HORN 91200-HF VERTICAL Detector : Peak Project : 811726 Setting : Z5 </p>	<p> Site : 03CH11-HY Condition : PEAK_74 3m HORN 91200-HF VERTICAL Detector : Peak Project : 811726 Setting : Z5 </p>
Avg.	<p> Site : 03CH11-HY Condition : AVG_BE_54 3m HORN 91200-HF VERTICAL Detector : Peak Project : 811726 Setting : Z5 </p>	Left blank

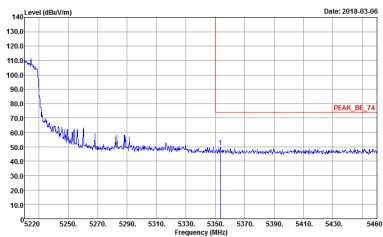
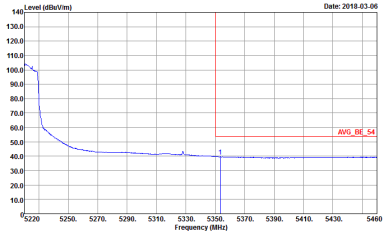

WIFI	Band 1 5150~5250MHz Band Edge @ 3m	
ANT	802.11ac VHT20 CH44 5220MHz - R	
1+2	Vertical	Fundamental
Peak	 <p>Date: 2018.03.06</p> <p>Site : 03CH11-HY Condition : PEAK_BE_74 3m HORN 91200-HF VERTICAL : RBW:1000.000KHz VBW:3000.000KHz SWT:Auto Detector : Peak Project : 811726 Setting : Z5</p>	Left blank
Avg.	 <p>Date: 2018.03.06</p> <p>Site : 03CH11-HY Condition : AVG_BE_54 3m HORN 91200-HF VERTICAL : RBW:1000.000KHz VBW:0.300KHz SWT:Auto Detector : Peak Project : 811726 Setting : Z5</p>	Left blank



WIFI	Band 1 5150~5250MHz Band Edge @ 3m	
ANT	802.11ac VHT20 CH48 5240MHz - L	
1+2	Horizontal	Fundamental
Peak	<p> Site : 03CH11-HY Condition : PEAK_BE_74 3m HORN 91200-HF HORIZONTAL : RBW:1000.000KHz VBW:3000.000KHz SWT:Auto Detector : Peak Project : 811726 Setting : Z5 </p>	<p> Site : 03CH11-HY Condition : PEAK_74 3m HORN 91200-HF HORIZONTAL : RBW:1000.000KHz VBW:3000.000KHz SWT:Auto Detector : Peak Project : 811726 Setting : Z5 </p>
Avg.	<p> Site : 03CH11-HY Condition : AVG_BE_54 3m HORN 91200-HF HORIZONTAL : RBW:1000.000KHz VBW:3.000KHz SWT:Auto Detector : Peak Project : 811726 Setting : Z5 </p>	Left blank

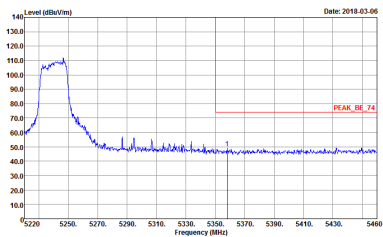
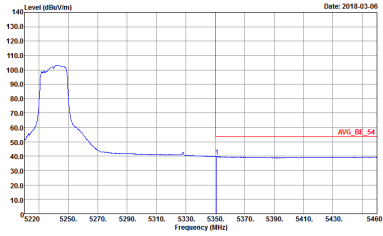

WIFI	Band 1 5150~5250MHz Band Edge @ 3m	
ANT	802.11ac VHT20 CH48 5240MHz - R	
1+2	Horizontal	Fundamental
<p>Peak</p>	 <p>Site : 03CH11-HY Condition : PEAK_BE_74 3m HORN 91200-HF HORIZONTAL Detector : Peak Project : 811726 Setting : Z5</p>	<p>Left blank</p>
<p>Avg.</p>	 <p>Site : 03CH11-HY Condition : AVG_BE_54 3m HORN 91200-HF HORIZONTAL Detector : Peak Project : 811726 Setting : Z5</p>	<p>Left blank</p>



WIFI	Band 1 5150~5250MHz Band Edge @ 3m	
ANT	802.11ac VHT20 CH48 5240MHz - L	
1+2	Vertical	Fundamental
Peak	<p>Site : 03CH11-HY Condition : PEAK_BE_74 3m HORN 91200-HF VERTICAL Detector : Peak Project : 811726 Setting : Z5</p>	<p>Site : 03CH11-HY Condition : PEAK_74 3m HORN 91200-HF VERTICAL Detector : Peak Project : 811726 Setting : Z5</p>
Avg.	<p>Site : 03CH11-HY Condition : AVG_BE_54 3m HORN 91200-HF VERTICAL Detector : Peak Project : 811726 Setting : Z5</p>	Left blank



WIFI	Band 1 5150~5250MHz Band Edge @ 3m	
ANT	802.11ac VHT20 CH48 5240MHz - R	
1+2	Vertical	Fundamental
Peak	<p>Site : 03CH11-HY Condition : PEAK_BE_74 3m HORN 91200-HF VERTICAL : RBW:1000.000KHz VBW:3000.000KHz SWT:Auto Detector : Peak Project : 811726 Setting : Z5</p>	Left blank
Avg.	<p>Site : 03CH11-HY Condition : AVG_BE_54 3m HORN 91200-HF VERTICAL : RBW:1000.000KHz VBW:3.000KHz SWT:Auto Detector : Peak Project : 811726 Setting : Z5</p>	Left blank



Band 1 5150~5250MHz
WIFI 802.11ac VHT40 (Band Edge @ 3m)

WIFI	Band 1 5150~5250MHz Band Edge @ 3m	
ANT	802.11ac VHT40 CH38 5190MHz - L	
1+2	Horizontal	Fundamental
Peak	<p>Date: 2018-03-11</p> <p>Site : 03CHI1-HY Condition : PEAK_BE_74 3m HORN 9120D-HF HORIZONTAL Detector : Peak Project : 811726 Setting : 23.5</p>	<p>Date: 2018-03-11</p> <p>Site : 03CHI1-HY Condition : PEAK_74 3m HORN 9120D-HF HORIZONTAL Detector : Peak Project : 811726 Setting : 23.5</p>
Avg.	<p>Date: 2018-03-11</p> <p>Site : 03CHI1-HY Condition : AVG_BE_54 3m HORN 9120D-HF HORIZONTAL Detector : Peak Project : 811726 Setting : 23.5</p>	Left blank

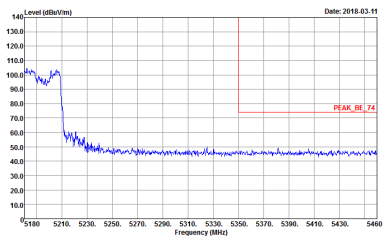
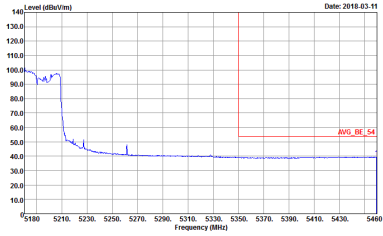

WIFI	Band 1 5150~5250MHz Band Edge @ 3m	
ANT	802.11ac VHT40 CH38 5190MHz - R	
1+2	Horizontal	Fundamental
<p>Peak</p>	 <p>Site : 03CH11-HY Condition : PEAK_BE_74 3m HORN 91200-HF HORIZONTAL Detector : Peak Project : 811726 Setting : 23.5</p>	<p>Left blank</p>
<p>Avg.</p>	 <p>Site : 03CH11-HY Condition : AVG_BE_54 3m HORN 91200-HF HORIZONTAL Detector : Peak Project : 811726 Setting : 23.5</p>	<p>Left blank</p>



WIFI	Band 1 5150~5250MHz Band Edge @ 3m	
ANT	802.11ac VHT40 CH38 5190MHz - L	
1+2	Vertical	Fundamental
Peak	<p>Site : 03CH11-HY Condition : PEAK_BE_74 3m HORN 91200-HF VERTICAL : RBW:1000.000KHz VBW:3000.000KHz SWT:Auto Detector : Peak Project : 811726 Setting : 23.5</p>	<p>Site : 03CH11-HY Condition : PEAK_74 3m HORN 91200-HF VERTICAL : RBW:1000.000KHz VBW:3000.000KHz SWT:Auto Detector : Peak Project : 811726 Setting : 23.5</p>
Avg.	<p>Site : 03CH11-HY Condition : AVG_BE_54 3m HORN 91200-HF VERTICAL : RBW:1000.000KHz VBW:1000KHz SWT:Auto Detector : Peak Project : 811726 Setting : 23.5</p>	Left blank

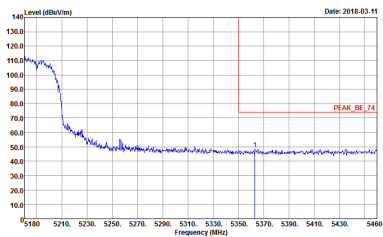
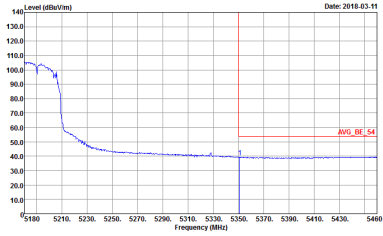

WIFI	Band 1 5150~5250MHz Band Edge @ 3m	
ANT	802.11ac VHT40 CH38 5190MHz - R	
1+2	Vertical	Fundamental
<p>Peak</p>	 <p>Site : 03CH11-HY Condition : PEAK_BE_74 3m HORN 91200-HF VERTICAL Detector : Peak Project : 811726 Setting : 23.5</p>	<p>Left blank</p>
<p>Avg.</p>	 <p>Site : 03CH11-HY Condition : AVG_BE_54 3m HORN 91200-HF VERTICAL Detector : Peak Project : 811726 Setting : 23.5</p>	<p>Left blank</p>

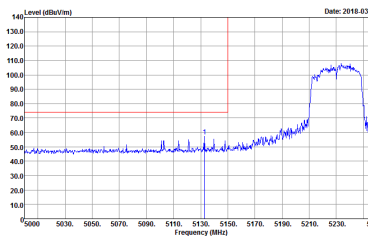
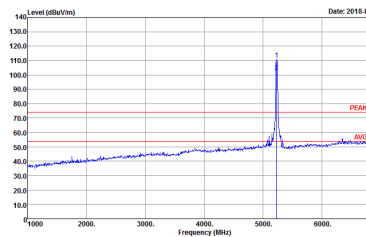
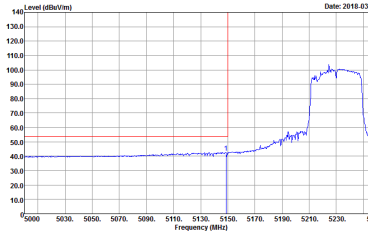

WIFI	Band 1 5150~5250MHz Band Edge @ 3m	
ANT	802.11ac VHT40 CH46 5230MHz - L	
1+2	Horizontal	Fundamental
Peak	 <p>Site : 03CH11-HY Condition : PEAK_BE_74 3m HORN 9120D-HF HORIZONTAL Detector : Peak Project : 811726 Setting : Z4</p>	 <p>Site : 03CH11-HY Condition : PEAK_74 3m HORN 9120D-HF HORIZONTAL Detector : Peak Project : 811726 Setting : Z4</p>
Avg.	 <p>Site : 03CH11-HY Condition : AVG_BE_54 3m HORN 9120D-HF HORIZONTAL Detector : Peak Project : 811726 Setting : Z4</p>	Left blank

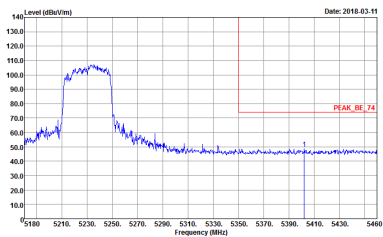
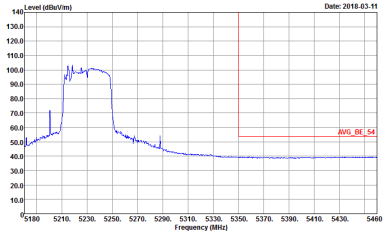

WIFI	Band 1 5150~5250MHz Band Edge @ 3m	
ANT	802.11ac VHT40 CH46 5230MHz - R	
1+2	Horizontal	Fundamental
<p>Peak</p>	 <p>Site : 03CH11-HY Condition : PEAK_BE_74 3m HORN 91200-HF HORIZONTAL : RBW:1000.000KHz VBW:3000.000KHz SWT:Auto Detector : Peak Project : 811726 Setting : 24</p>	<p>Left blank</p>
<p>Avg.</p>	 <p>Site : 03CH11-HY Condition : AVG_BE_54 3m HORN 91200-HF HORIZONTAL : RBW:1000.000KHz VBW:1000KHz SWT:Auto Detector : Peak Project : 811726 Setting : 24</p>	<p>Left blank</p>



WIFI	Band 1 5150~5250MHz Band Edge @ 3m	
ANT	802.11ac VHT40 CH46 5230MHz - L	
1+2	Vertical	Fundamental
<p>Peak</p>	<p>Date: 2018-03-11</p> <p>Site : 03CH11-HY Condition : PEAK_BE_74 3m HORN 9120D-HF VERTICAL : RBW:1000.000KHz VBW:3000.000KHz SWT:Auto Detector : Peak Project : 811726 Setting : 24</p>	<p>Date: 2018-03-11</p> <p>Site : 03CH11-HY Condition : PEAK_74 3m HORN 9120D-HF VERTICAL : RBW:1000.000KHz VBW:3000.000KHz SWT:Auto Detector : Peak Project : 811726 Setting : 24</p>
<p>Avg.</p>	<p>Date: 2018-03-11</p> <p>Site : 03CH11-HY Condition : AVG_BE_54 3m HORN 9120D-HF VERTICAL : RBW:1000.000KHz VBW:1000KHz SWT:Auto Detector : Peak Project : 811726 Setting : 24</p>	<p>Left blank</p>

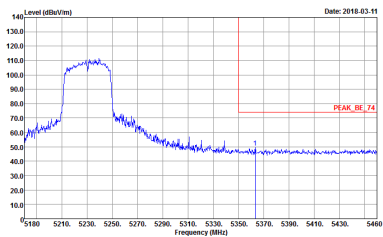
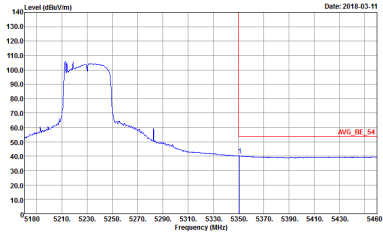

WIFI	Band 1 5150~5250MHz Band Edge @ 3m	
ANT	802.11ac VHT40 CH46 5230MHz - R	
1+2	Vertical	Fundamental
<p>Peak</p>	 <p>Site : 03CH11-HY Condition : PEAK_BE_74 3m HORN 91200-HF VERTICAL : RBW:1000.000KHz VBW:3000.000KHz SWT:Auto Detector : Peak Project : 811726 Setting : 24</p>	<p>Left blank</p>
<p>Avg.</p>	 <p>Site : 03CH11-HY Condition : AVG_BE_54 3m HORN 91200-HF VERTICAL : RBW:1000.000KHz VBW:1000KHz SWT:Auto Detector : Peak Project : 811726 Setting : 24</p>	<p>Left blank</p>



Band 1 5150~5250MHz
WIFI 802.11ac VHT80 (Band Edge @ 3m)

WIFI	Band 1 5150~5250MHz Band Edge @ 3m	
ANT	802.11ac VHT80 CH42 5210MHz - L	
1+2	Horizontal	Fundamental
Peak	<p>Site : 03CH11-HY Condition : PEAK_BE_74 3m HORN 9120D-JF HORIZONTAL RBW:1000.000KHz VBW:3000.000KHz SWT:Auto Detector : Peak Project : 811726 Setting : Z2.5</p>	<p>Site : 03CH11-HY Condition : PEAK_74 3m HORN 9120D-JF HORIZONTAL RBW:1000.000KHz VBW:3000.000KHz SWT:Auto Detector : Peak Project : 811726 Setting : Z2.5</p>
Avg.	<p>Site : 03CH11-HY Condition : AVG_BE_54 3m HORN 9120D-JF HORIZONTAL RBW:1000.000KHz VBW:1.000KHz SWT:Auto Detector : Peak Project : 811726 Setting : Z2.5</p>	Left blank



WIFI	Band 1 5150~5250MHz Band Edge @ 3m	
ANT	802.11ac VHT80 CH42 5210MHz - R	
1+2	Horizontal	Fundamental
<p>Peak</p>		<p>Left blank</p>
<p>Avg.</p>		<p>Left blank</p>



WIFI	Band 1 5150~5250MHz Band Edge @ 3m	
ANT	802.11ac VHT80 CH42 5210MHz - L	
1+2	Vertical	Fundamental
Peak	<p>Site : 03CH11-HY Condition : PEAK_BE_74 3m HORN 9120D-HF VERTICAL : RBW:1000.000KHz VBW:3000.000KHz SWT:Auto Detector : Peak Project : 811726 Setting : Z2.5</p>	<p>Site : 03CH11-HY Condition : PEAK_74 3m HORN 9120D-HF VERTICAL : RBW:1000.000KHz VBW:3000.000KHz SWT:Auto Detector : Peak Project : 811726 Setting : Z2.5</p>
Avg.	<p>Site : 03CH11-HY Condition : AVG_BE_54 3m HORN 9120D-HF VERTICAL : RBW:1000.000KHz VBW:1000KHz SWT:Auto Detector : Peak Project : 811726 Setting : Z2.5</p>	Left blank

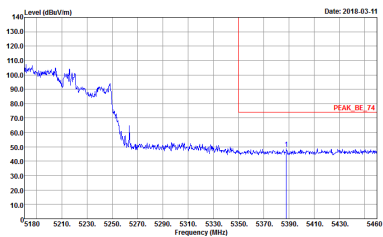
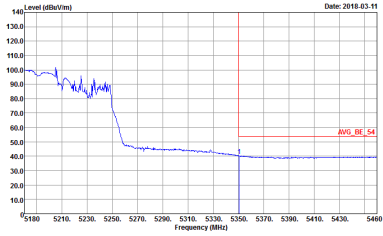

WIFI	Band 1 5150~5250MHz Band Edge @ 3m	
ANT	802.11ac VHT80 CH42 5210MHz - R	
1+2	Vertical	Fundamental
<p>Peak</p>	 <p>Site : 03CH11-HY Condition : PEAK_BE_74 3m HORN 91200-HF VERTICAL : RBW:1000.000KHz VBW:3000.000KHz SWT:Auto Detector : Peak Project : 811726 Setting : Z2.5</p>	<p>Left blank</p>
<p>Avg.</p>	 <p>Site : 03CH11-HY Condition : AVG_BE_54 3m HORN 91200-HF VERTICAL : RBW:1000.000KHz VBW:1000KHz SWT:Auto Detector : Peak Project : 811726 Setting : Z2.5</p>	<p>Left blank</p>



Band 1 - 5150~5250MHz
WIFI 802.11ac VHT20 (Harmonic @ 3m)

Table with 2 columns: Horizontal and Vertical. Each column contains a graph of Level (dBuV/m) vs Frequency (MHz) with Peak and Avg values. Includes site and condition details.

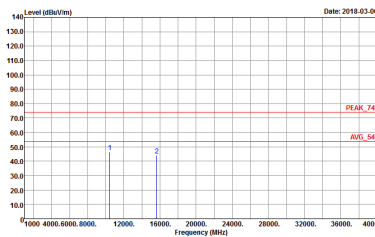
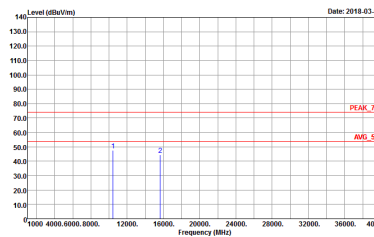

WIFI	Band 1 5150~5250MHz Harmonic @ 3m	
ANT	802.11ac VHT20 CH44 5220MHz	
1+2	Horizontal	Vertical
<p>Peak</p> <p>Avg.</p>	 <p>Site : 03CH11-11Y Condition : PEAK_74 3m HORN 91200-HF HORIZONTAL Detector : Peak Project : 811726 Setting : 25</p>	 <p>Site : 03CH11-11Y Condition : PEAK_74 3m HORN 91200-HF VERTICAL Detector : Peak Project : 811726 Setting : 25</p>



WIFI	Band 1 5150~5250MHz Harmonic @ 3m	
ANT	802.11ac VHT20 CH48 5240MHz	
1+2	Horizontal	Vertical
Peak Avg.	<p>Site : 03CH11-14Y Condition : PEAK_74 3m HORN 91200-HF HORIZONTAL Detector : Peak Project : 811726 Setting : 25</p>	<p>Site : 03CH11-14Y Condition : PEAK_74 3m HORN 91200-HF VERTICAL Detector : Peak Project : 811726 Setting : 25</p>

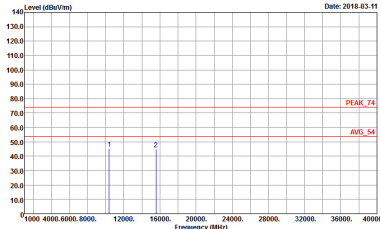
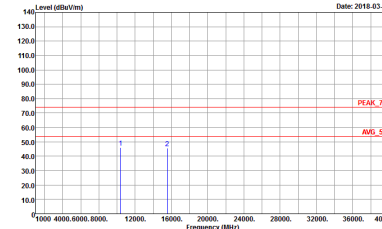

**Band 1 5150~5250MHz
WIFI 802.11ac VHT40 (Harmonic @ 3m)**

WIFI	Band 1 5150~5250MHz Harmonic @ 3m	
ANT	802.11ac VHT40 CH38 5190MHz	
1+2	Horizontal	Vertical
Peak	 <p>Site : 03CH11-HY Condition : PEAK_74 3m HORN 9120D-HF HORIZONTAL Detector : Peak Project : 811726 Setting : 23.5</p>	 <p>Site : 03CH11-HY Condition : PEAK_74 3m HORN 9120D-HF VERTICAL Detector : Peak Project : 811726 Setting : 23.5</p>
Avg.		

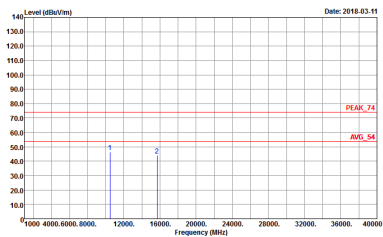
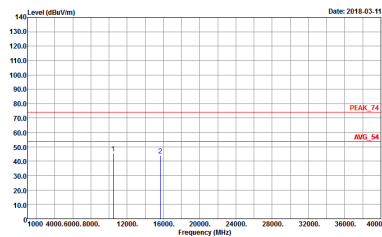

WIFI	Band 1 5150~5250MHz Harmonic @ 3m	
ANT	802.11ac VHT40 CH46 5230MHz	
1+2	Horizontal	Vertical
<p>Peak</p> <p>Avg.</p>	 <p>Site : 03CH11-14Y Condition : PEAK_74 3m HORN 91200-HF HORIZONTAL Detector : Peak Project : 811726 Setting : 24</p>	 <p>Site : 03CH11-14Y Condition : PEAK_74 3m HORN 91200-HF VERTICAL Detector : Peak Project : 811726 Setting : 24</p>

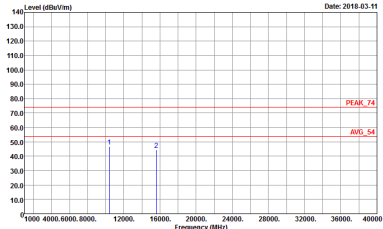
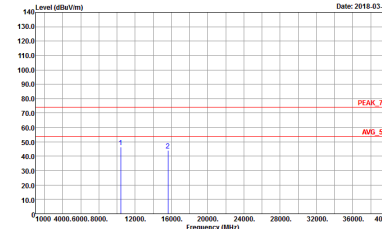

**Band 1 5150~5250MHz
WIFI 802.11ac VHT80 (Harmonic @ 3m)**

WIFI	Band 1 5150~5250MHz Harmonic @ 3m	
ANT	802.11ac VHT80 CH42 5210MHz	
1+2	Horizontal	Vertical
Peak	 <p>Site : 03CH11-HY Condition : PEAK_74 3m HORN 9120D-HF HORIZONTAL Detector : Peak Project : 811726 Setting : 22.5</p>	 <p>Site : 03CH11-HY Condition : PEAK_74 3m HORN 9120D-HF VERTICAL Detector : Peak Project : 811726 Setting : 22.5</p>
Avg.		



Appendix E. Duty Cycle Plots

Antenna	Band	Duty Cycle (%)	T(us)	1/T(kHz)	VBW Setting	Duty Factor (dB)
1	802.11a_LB	96.23	2040.00	0.49	1kHz	0.17
1+2	802.11a_LB for Ant. 1	96.19	2020.00	0.50	1kHz	0.17
1+2	802.11a_LB for Ant. 2	96.19	2020.00	0.50	1kHz	0.17
1	5GHz 802.11n HT20_LB	97.62	4920.00	0.20	300Hz	0.10
1+2	5GHz 802.11n HT20_LB for Ant. 1	98.22	-	-	10Hz	0.08
1+2	5GHz 802.11n HT20_LB for Ant. 2	98.22	-	-	10Hz	0.08
1	5GHz 802.11n HT40_LB	96.39	2400.00	0.42	1kHz	0.16
1+2	5GHz 802.11n HT40_LB for Ant. 1	96.39	2400.00	0.42	1kHz	0.16
1+2	5GHz 802.11n HT40_LB for Ant. 2	95.24	2400.00	0.42	1kHz	0.21
1	5GHz 802.11ac VHT20_LB	88.39	4950.00	0.20	300Hz	0.54
1+2	5GHz 802.11ac VHT20_LB for Ant. 1	87.94	4960.00	0.20	300Hz	0.56
1+2	5GHz 802.11ac VHT20_LB for Ant. 2	87.94	4960.00	0.20	300Hz	0.56
1	5GHz 802.11ac VHT40_LB	78.43	2400.00	0.42	1kHz	1.06
1+2	5GHz 802.11ac VHT40_LB for Ant. 1	78.43	2400.00	0.42	1kHz	1.06
1+2	5GHz 802.11ac VHT40_LB for Ant. 2	78.43	2400.00	0.42	1kHz	1.06
1	5GHz 802.11ac VHT80_LB	82.83	3280.00	0.30	1kHz	0.85
1+2	5GHz 802.11ac VHT80_LB for Ant. 1	83.00	3320.00	0.30	1kHz	0.81
1+2	5GHz 802.11ac VHT80_LB for Ant. 2	83.00	3320.00	0.30	1kHz	0.81



<Ant. 1>

802.11a

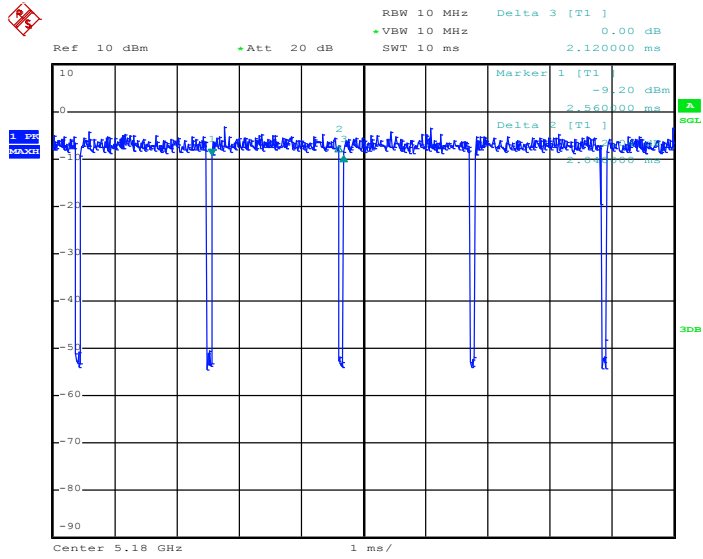

Date: 3.FEB.2018 21:29:17

802.11n HT20

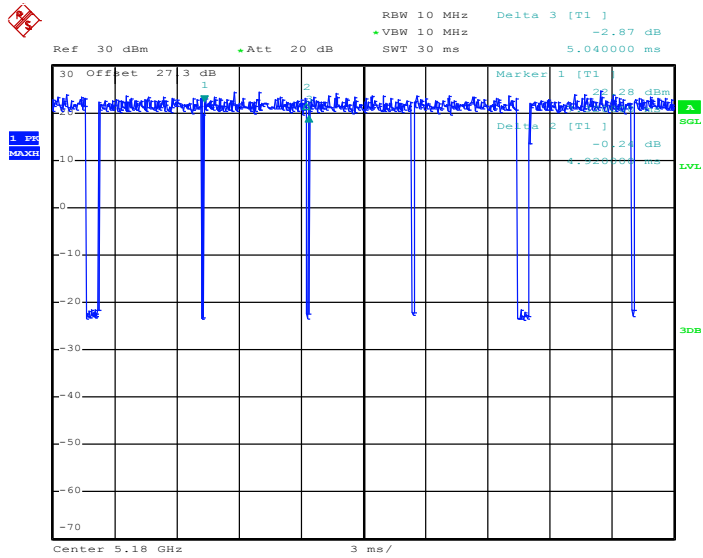

Date: 5.FEB.2018 21:44:40



802.11n HT40

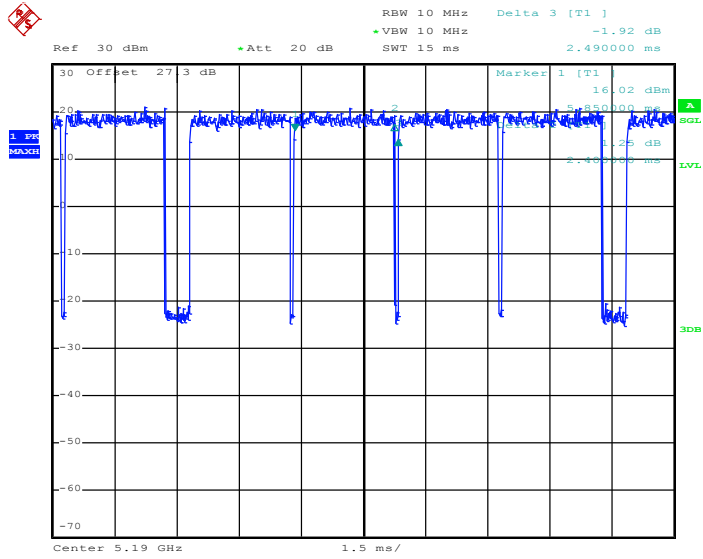

Date: 5.FEB.2018 22:03:19

802.11ac VHT20

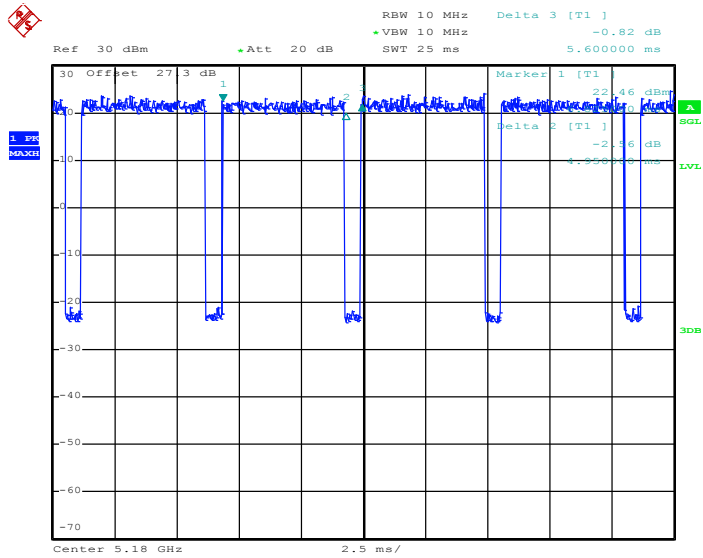

Date: 5.FEB.2018 21:51:18



802.11ac VHT40

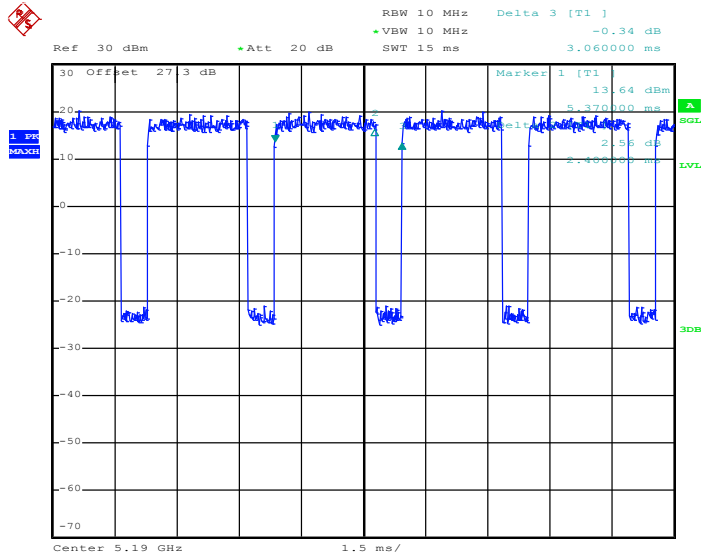

Date: 5.FEB.2018 21:58:59

802.11ac VHT80

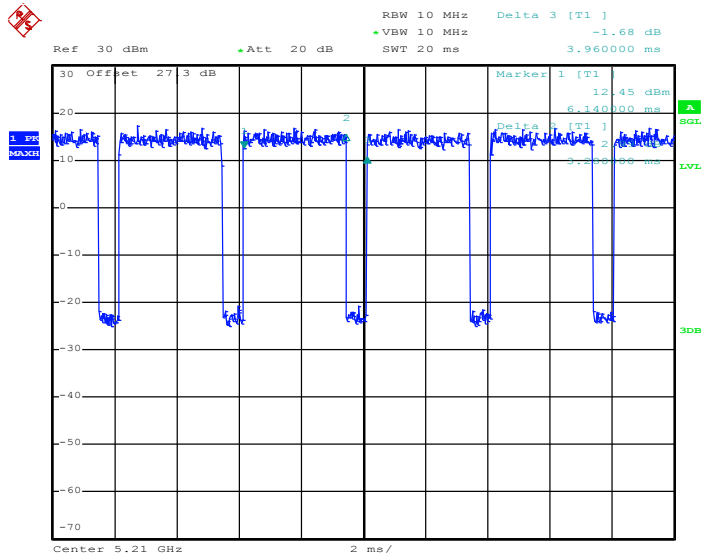

Date: 5.FEB.2018 22:05:06



MIMO <Ant. 1>

802.11a

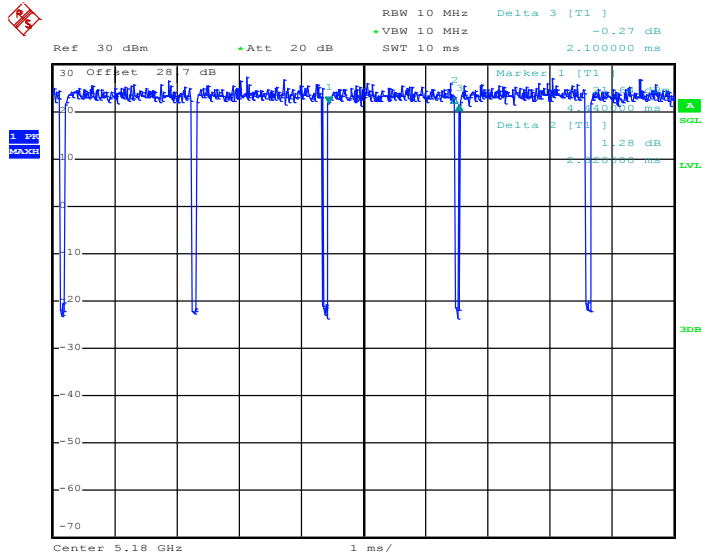

Date: 7.FEB.2018 00:55:02

802.11n HT20

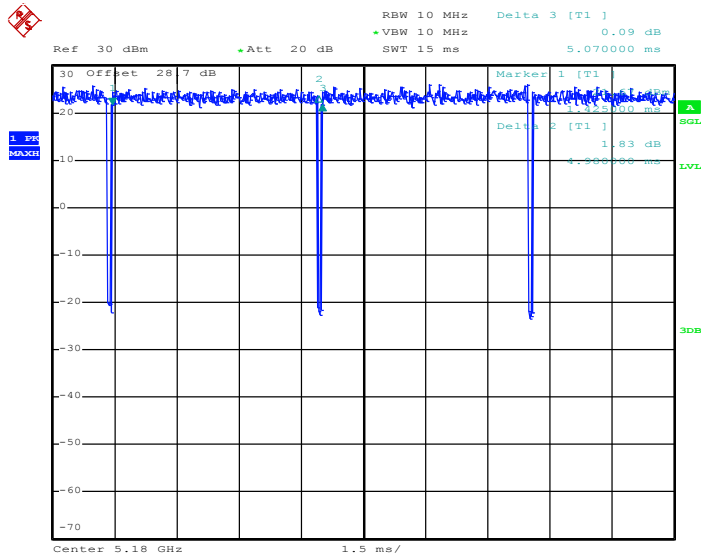

Date: 7.FEB.2018 00:51:01



802.11n HT40

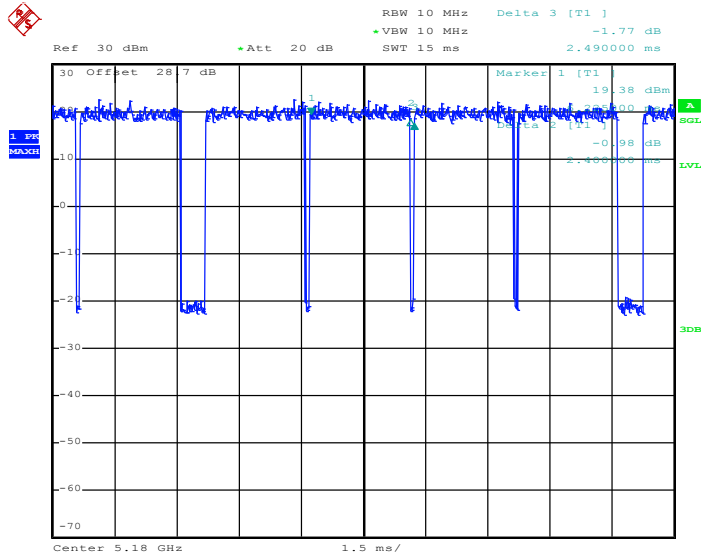

Date: 6.FEB.2018 20:05:47

802.11ac VHT20

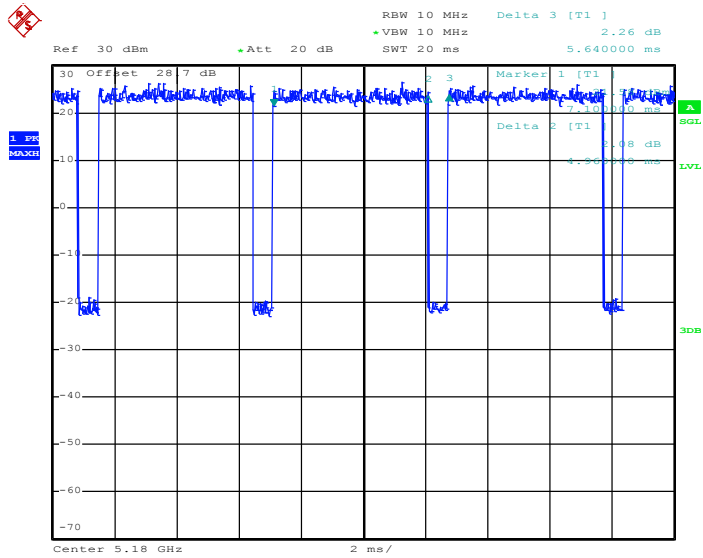

Date: 6.FEB.2018 19:51:08



802.11ac VHT40

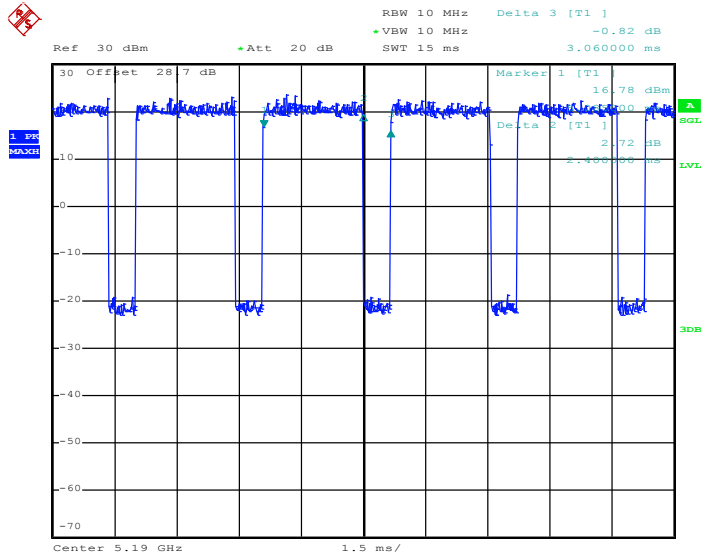

Date: 6.FEB.2018 19:54:28

802.11ac VHT80

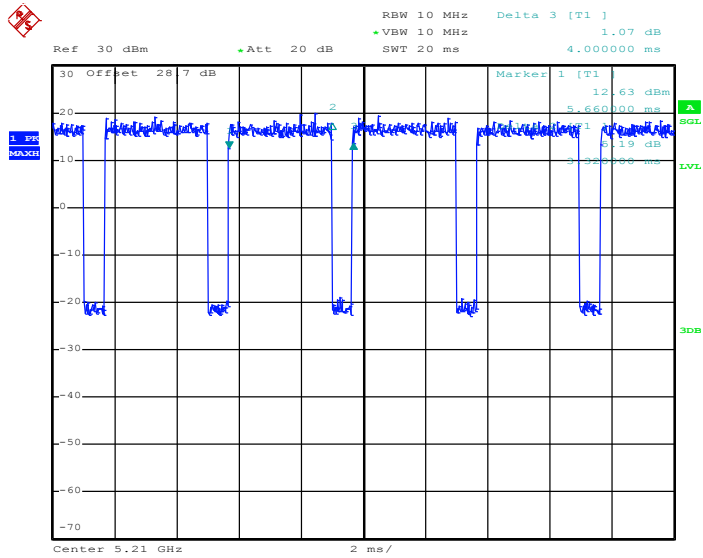

Date: 6.FEB.2018 19:56:19



MIMO <Ant. 2>

802.11a

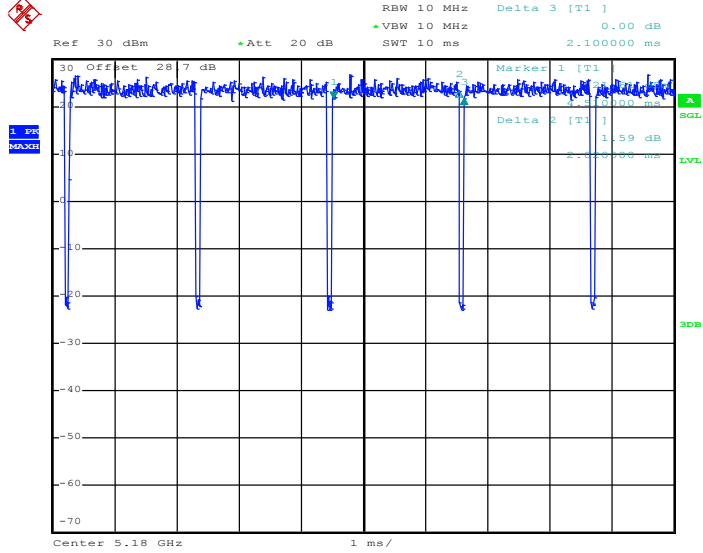

Date: 7.FEB.2018 00:54:04

802.11n HT20

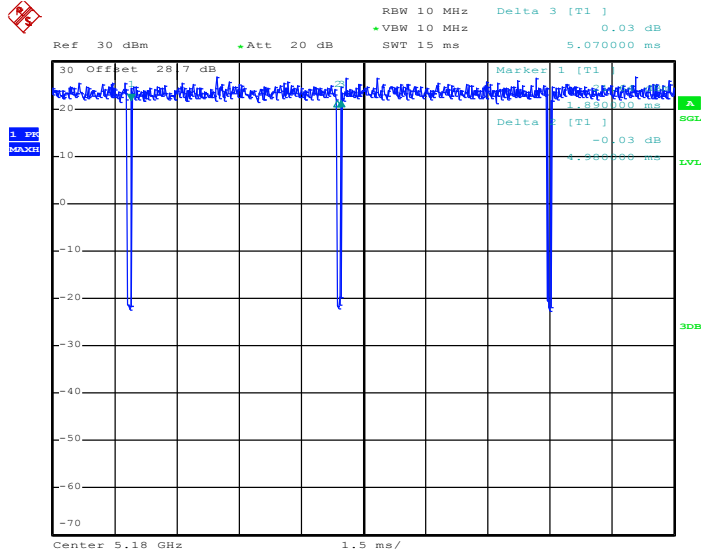

Date: 7.FEB.2018 00:53:10



802.11n HT40

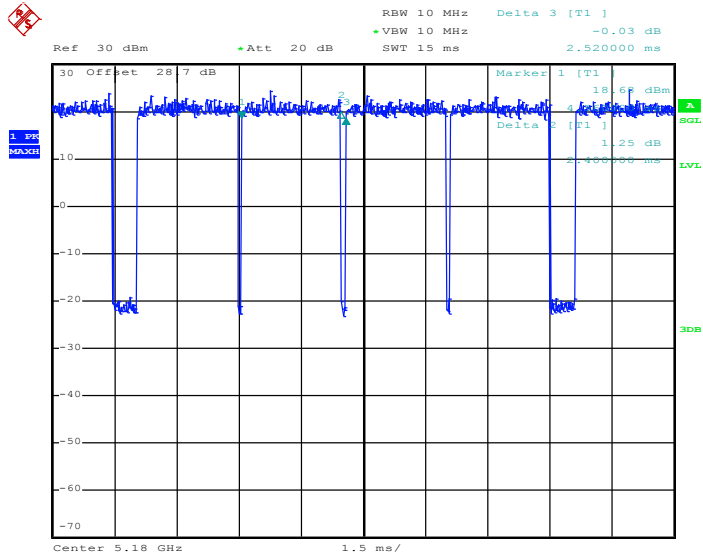

Date: 6.FEB.2018 20:06:36

802.11ac VHT20

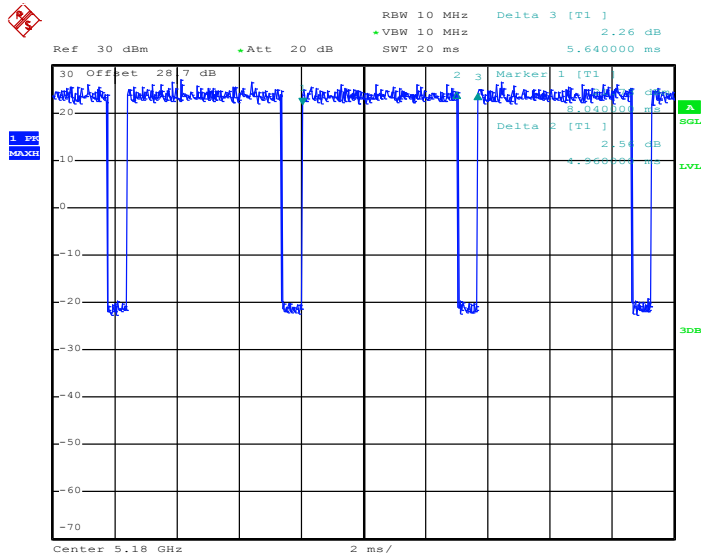

Date: 6.FEB.2018 19:51:51



802.11ac VHT40

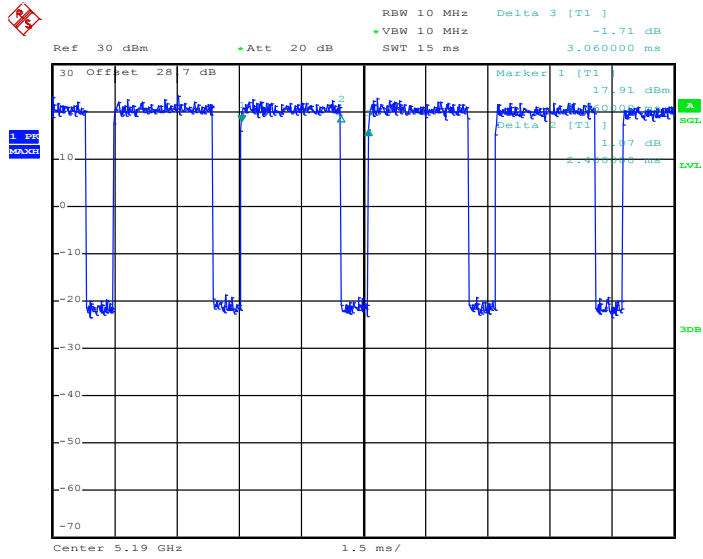

Date: 6.FEB.2018 19:53:13

802.11ac VHT80

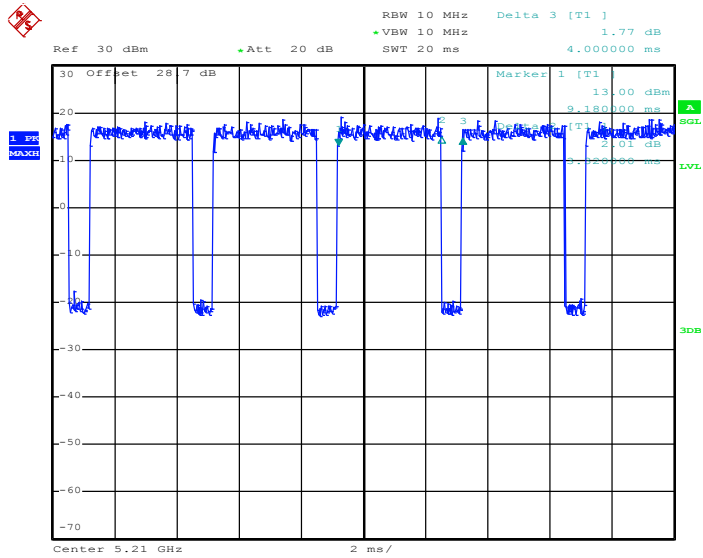

Date: 6.FEB.2018 19:56:58