



FCC RF Test Report

APPLICANT : Plume Design Inc
EQUIPMENT : Plume Adaptive Wifi
BRAND NAME : Plume Design Inc
MODEL NAME : B1A
FCC ID : 2AG7G-B1A
STANDARD : FCC Part 15 Subpart C §15.247
CLASSIFICATION : (DTS) Digital Transmission System

The product was received on Jan. 17, 2018 and testing was completed on Apr. 22, 2018. We, SPORTON INTERNATIONAL INC., would like to declare that the tested sample has been evaluated in accordance with the test procedures and has been in compliance with the applicable technical standards.

The test results in this report apply exclusively to the tested model / sample. Without written approval of SPORTON INTERNATIONAL INC., the test report shall not be reproduced except in full.

Reviewed by: Joseph Lin / Supervisor

Approved by: Jones Tsai / Manager



SPORTON INTERNATIONAL INC.

No. 52, Hwa Ya 1st Rd., Hwa Ya Technology Park, Kwei-Shan District, Tao Yuan City, Taiwan, R.O.C.

SPORTON INTERNATIONAL INC.

TEL : 886-3-327-3456

FAX : 886-3-328-4978

FCC ID: 2AG7G-B1A

Page Number : 1 of 81

Report Issued Date : Apr. 23, 2018

Report Version : Rev. 04

Report Template No.: BU5-FR15CWLAC MA Version 2.0



TABLE OF CONTENTS

REVISION HISTORY..... 3

SUMMARY OF TEST RESULT 4

1 GENERAL DESCRIPTION 5

 1.1 Applicant 5

 1.2 Manufacturer 5

 1.3 Product Feature of Equipment Under Test 5

 1.4 Modification of EUT 5

 1.5 Testing Location 6

 1.6 Applicable Standards 6

2 TEST CONFIGURATION OF EQUIPMENT UNDER TEST 7

 2.1 Carrier Frequency and Channel 7

 2.2 Test Mode 8

 2.3 Connection Diagram of Test System 9

 2.4 Support Unit used in test configuration and system 11

 2.5 EUT Operation Test Setup 12

 2.6 Measurement Results Explanation Example 12

3 TEST RESULT 13

 3.1 6dB and 99% Bandwidth Measurement 13

 3.2 Output Power Measurement 15

 3.3 Power Spectral Density Measurement 17

 3.4 Conducted Band Edges and Spurious Emission Measurement 21

 3.5 Radiated Band Edges and Spurious Emission Measurement 70

 3.6 AC Conducted Emission Measurement 75

 3.7 Antenna Requirements 77

4 LIST OF MEASURING EQUIPMENT 79

5 UNCERTAINTY OF EVALUATION 81

APPENDIX A. CONDUCTED TEST RESULTS

APPENDIX B. AC CONDUCTED EMISSION TEST RESULT

APPENDIX C. RADIATED SPURIOUS EMISSION

APPENDIX D. RADIATED SPURIOUS EMISSION PLOTS

APPENDIX E. DUTY CYCLE PLOTS

APPENDIX F. SETUP PHOTOGRAPHS



SUMMARY OF TEST RESULT

Report Section	FCC Rule	Description	Limit	Result	Remark
3.1	15.247(a)(2)	6dB Bandwidth	$\geq 0.5\text{MHz}$	Pass	-
3.1	-	99% Bandwidth	-	Pass	-
3.2	15.247(b)	Power Output Measurement	$\leq 30\text{dBm}$	Pass	-
3.3	15.247(e)	Power Spectral Density	$\leq 8\text{dBm}/3\text{kHz}$	Pass	-
3.4	15.247(d)	Conducted Band Edges	$\leq 30\text{dBc}$	Pass	-
		Conducted Spurious Emission		Pass	-
3.5	15.247(d)	Radiated Band Edges and Radiated Spurious Emission	15.209(a) & 15.247(d)	Pass	Under limit 1.09 dB at 2483.640 MHz
3.6	15.207	AC Conducted Emission	15.207(a)	Pass	Under limit 12.01 dB at 0.694 MHz
3.7	15.203 & 15.247(b)	Antenna Requirement	N/A	Pass	-



1 General Description

1.1 Applicant

Plume Design Inc
290 S California Ave, Palo Alto, CA94306

1.2 Manufacturer

Plume Design Inc
290 S California Ave, Palo Alto, CA94306

1.3 Product Feature of Equipment Under Test

Bluetooth, Wi-Fi 2.4GHz 802.11b/g/n, and Wi-Fi 5GHz 802.11a/n/ac

Product Specification subjective to this standard	
Antenna Type	WLAN <Ant. 1>: IFA Antenna <Ant. 2>: IFA Antenna <Ant. 3>: PIFA Antenna <Ant. 4>: PIFA Antenna <Ant. 5>: IFA Antenna <Ant. 6>: IFA Antenna Bluetooth: Slot Antenna

1.4 Modification of EUT

No modifications are made to the EUT during all test items.



1.5 Testing Location

Sporton Lab is accredited to ISO 17025 by Taiwan Accreditation Foundation (TAF code : 1190) and the FCC designation No. TW1190 and TW0007 under the FCC 2.948(e) by Mutual Recognition Agreement (MRA) in FCC Test.

Test Site	SPORTON INTERNATIONAL INC.	
Test Site Location	No. 52, Hwa Ya 1 st Rd., Hwa Ya Technology Park, Kwei-Shan District, Tao Yuan City, Taiwan, R.O.C. TEL: +886-3-327-3456 FAX: +886-3-328-4978	
Test Site No.	Sporton Site No.	
	TH05-HY	CO05-HY

Note: The test site complies with ANSI C63.4 2014 requirement.

Test Site	SPORTON INTERNATIONAL INC.	
Test Site Location	No.58, Aly. 75, Ln. 564, Wenhua 3rd Rd. Guishan Dist, Taoyuan City, Taiwan (R.O.C.) TEL: +886-3-327-0868 FAX: +886-3-327-0855	
Test Site No.	Sporton Site No.	
	03CH11-HY	

Note: The test site complies with ANSI C63.4 2014 requirement.

1.6 Applicable Standards

According to the specifications of the manufacturer, the EUT must comply with the requirements of the following standards:

- ♦ FCC Part 15 Subpart C §15.247
- ♦ FCC KDB Publication No. 558074 D01 DTS Meas. Guidance v04
- ♦ FCC KDB 662911 D01 Multiple Transmitter Output v02r01.
- ♦ ANSI C63.10-2013

Remark:

1. All test items were verified and recorded according to the standards and without any deviation during the test.
2. This EUT has also been tested and complied with the requirements of FCC Part 15, Subpart B, recorded in a separate test report.



2 Test Configuration of Equipment Under Test

- a. The EUT has been associated with peripherals and configuration operated in a manner tended to maximize its emission characteristics in a typical application. Frequency range investigated: conduction emission (150 kHz to 30 MHz), radiation emission (9 kHz to the 10th harmonic of the highest fundamental frequency or to 40 GHz, whichever is lower). For radiated measurement, pre-scanned in three orthogonal panels, X, Y, Z. The worst cases (Z plane) were recorded in this report.

- b. AC power line Conducted Emission was tested under maximum output power.

2.1 Carrier Frequency and Channel

Frequency Band	Channel	Freq. (MHz)	Channel	Freq. (MHz)
2400-2483.5 MHz	1	2412	7	2442
	2	2417	8	2447
	3	2422	9	2452
	4	2427	10	2457
	5	2432	11	2462
	6	2437		



2.2 Test Mode

Final test modes are considering the modulation and worse data rates as below table.

Single Mode

Modulation	Data Rate
802.11b	1 Mbps
802.11g	6 Mbps
802.11n HT20 (Covered by VHT20)	MCS0
802.11n HT40 (Covered by VHT40)	MCS0
802.11ac VHT20	MCS0
802.11ac VHT40	MCS0

MIMO Mode

Modulation	Data Rate
802.11b	1 Mbps
802.11g	6 Mbps
802.11n HT20 (Covered by VHT20)	MCS0
802.11n HT40 (Covered by VHT40)	MCS0
802.11ac VHT20	MCS0
802.11ac VHT40	MCS0

TXBF Mode

Modulation	Data Rate
802.11n HT20 (Covered by VHT20)	MCS0
802.11n HT40 (Covered by VHT40)	MCS0
802.11ac VHT20	MCS0
802.11ac VHT40	MCS0

Test Cases	
AC Conducted Emission	Mode 1 : WLAN (2.4GHz) Link + Bluetooth Idle + Lan 1 Link + Lan 2 Link

2.3 Connection Diagram of Test System

<AC Conducted Emission>

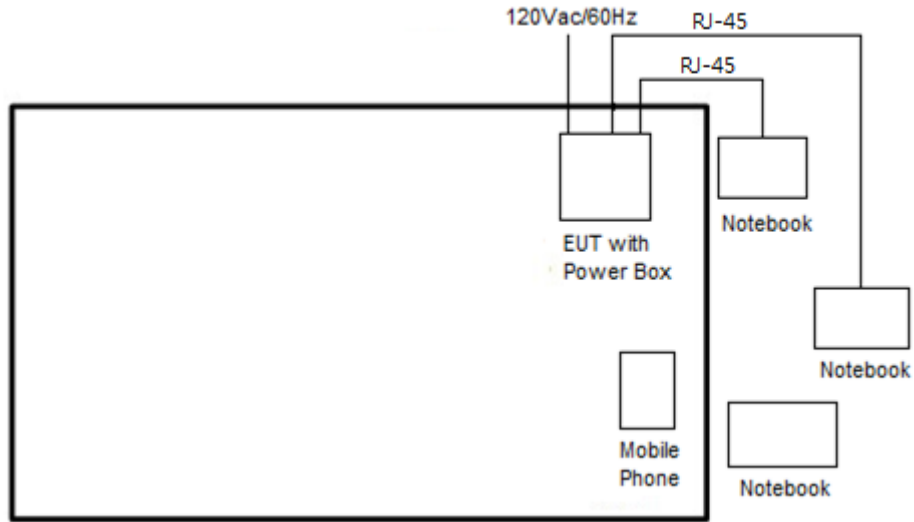

<Radiated Spurious Emission>

<CDD Mode>

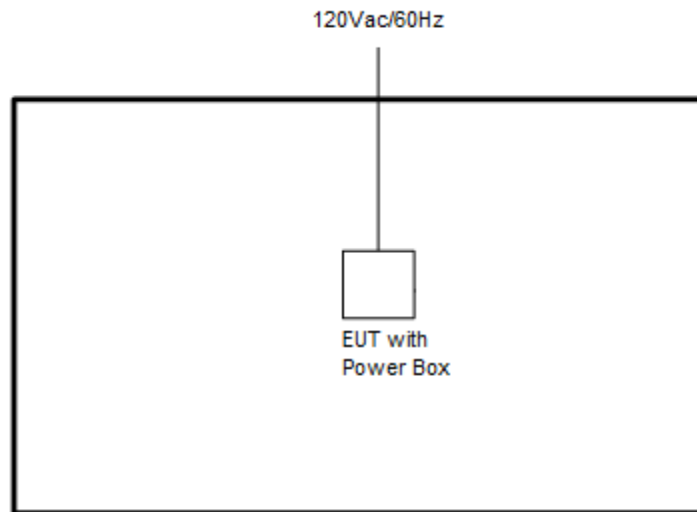

<CDD with RJ-45 Mode>

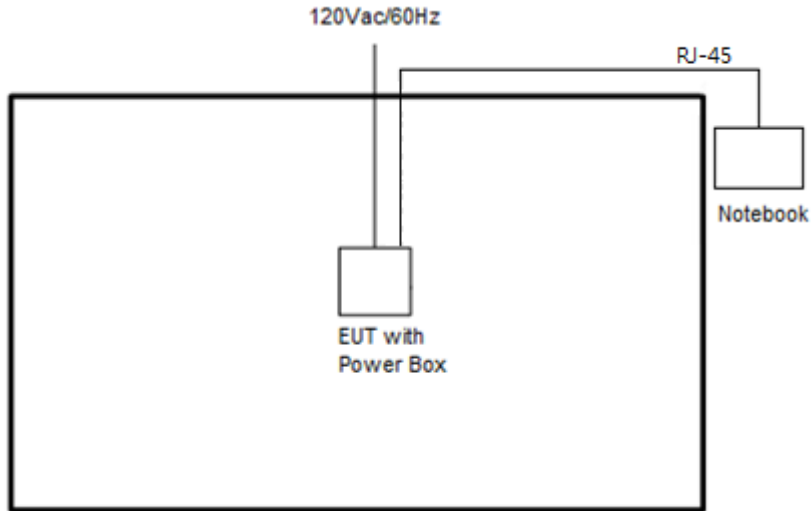

<TXBF Mode>

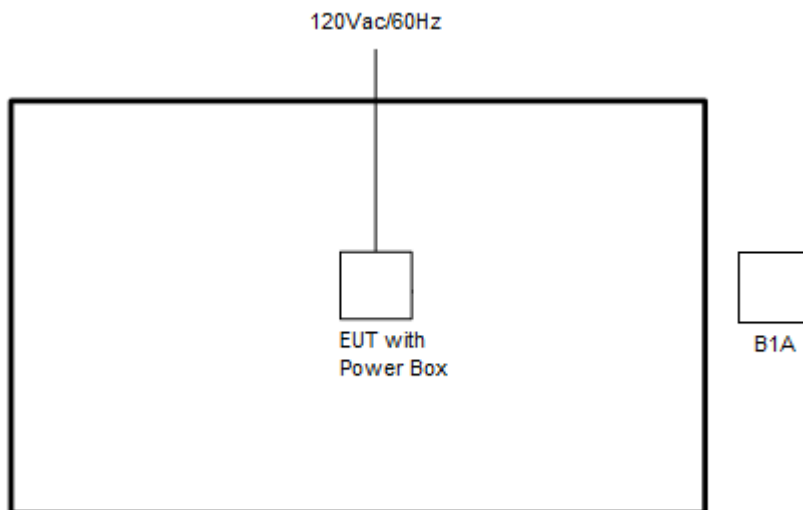

<TXBF with RJ-45 Mode>

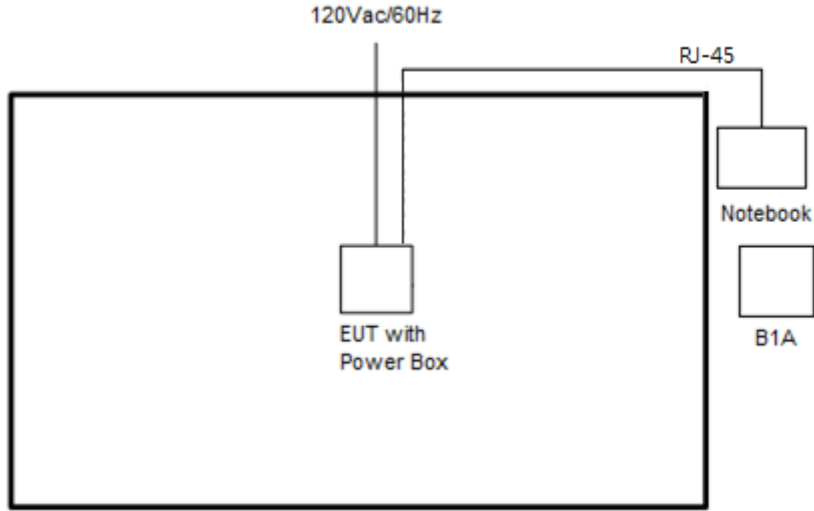

2.4 Support Unit used in test configuration and system

Item	Equipment	Trade Name	Model Name	FCC ID	Data Cable	Power Cord
1.	Notebook	DELL	Latitude E6320	FCC DoC/ Contains FCC ID: QDS-BRCM1054	N/A	AC I/P: Unshielded, 1.2 m DC O/P: Shielded, 1.8 m
2.	Notebook	DELL	Latitude E3340	FCC DoC/ Contains FCC ID: PD97260NGU	N/A	AC I/P: Unshielded, 1.2 m DC O/P: Shielded, 1.8 m
3.	Mobile Phone	Apple	A1687	BCG-E2944A	N/A	N/A



2.5 EUT Operation Test Setup

The RF test items, utility “QSPR” was installed in Notebook which was programmed in order to make the EUT get into the engineering modes to provide channel selection, power level, data rate and the application type and for continuous transmitting signals.

For TXBF mode, the EUT was tested under normal operation and link to another EUT with power, modulation modes and data rates controlled by engineer mode command lines. The “QSPR” software tool was used to make EUT continuous transmitting signals.

2.6 Measurement Results Explanation Example

For all conducted test items:

The offset level is set in the spectrum analyzer to compensate the RF cable loss and attenuator factor between EUT conducted output port and spectrum analyzer. With the offset compensation, the spectrum analyzer reading level is exactly the EUT RF output level.

Example:

The spectrum analyzer offset is derived from RF cable loss and attenuator factor.

Offset = RF cable loss + attenuator factor.

Following shows an offset computation example with cable loss 4.2 dB and 10dB attenuator.

$$\begin{aligned} \text{Offset(dB)} &= \text{RF cable loss(dB)} + \text{attenuator factor(dB)}. \\ &= 4.2 + 10 = 14.2 \text{ (dB)} \end{aligned}$$

3 Test Result

3.1 6dB and 99% Bandwidth Measurement

3.1.1 Limit of 6dB and 99% Bandwidth

The minimum 6 dB bandwidth shall be at least 500 kHz.

3.1.2 Measuring Instruments

The measuring equipment is listed in the section 4 of this test report.

3.1.3 Test Procedures

1. The testing follows FCC KDB Publication No. 558074 DTS D01 Meas. Guidance v04.
2. The RF output of EUT was connected to the spectrum analyzer by RF cable and attenuator. The path loss was compensated to the results for each measurement.
3. Set to the maximum power setting and enable the EUT transmit continuously.
4. Make the measurement with the spectrum analyzer's resolution bandwidth (RBW) = 100 kHz. Set the Video bandwidth (VBW) = 300 kHz. In order to make an accurate measurement. The 6 dB bandwidth must be greater than 500 kHz.
5. For 99% Bandwidth Measurement, the spectrum analyzer's resolution bandwidth (RBW) = 1MHz and set the Video bandwidth (VBW) = 3MHz.
6. Measure and record the results in the test report.

3.1.4 Test Setup





3.1.5 Test Result of 6dB and 99% Occupied Bandwidth

Please refer to Appendix A.

<CDD Mode>

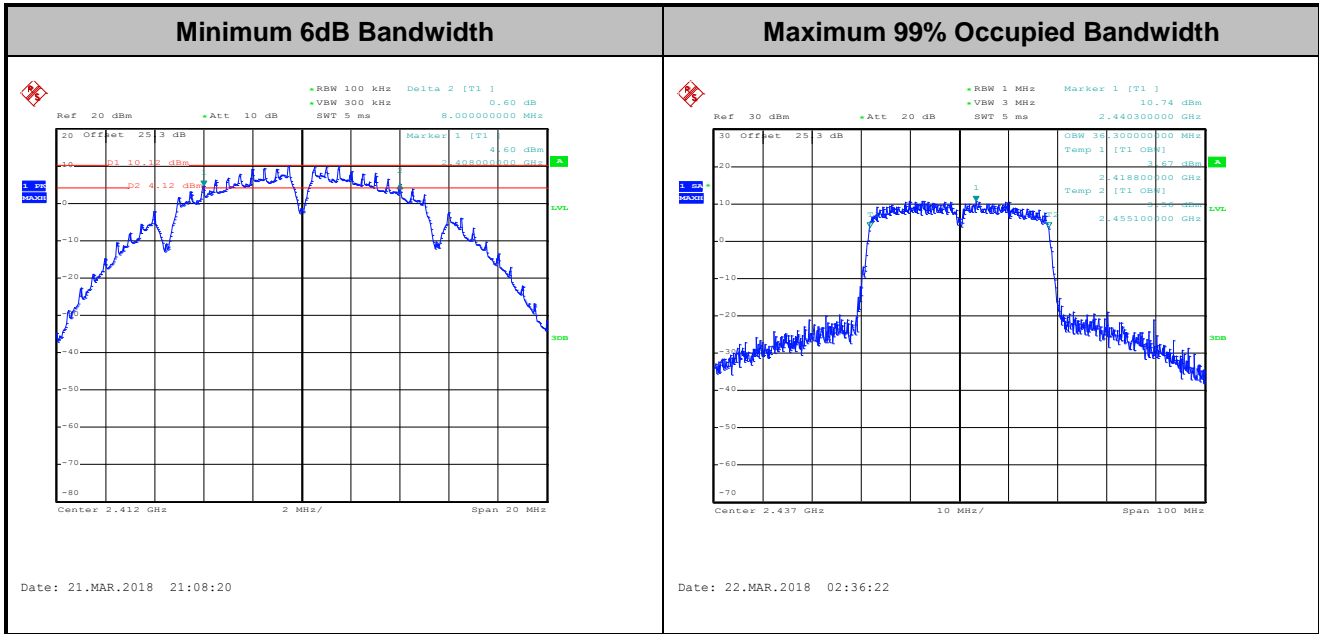

Note : The occupied channel bandwidth is maintained within the band of operation for all of the modulations.

<TXBF Modes>

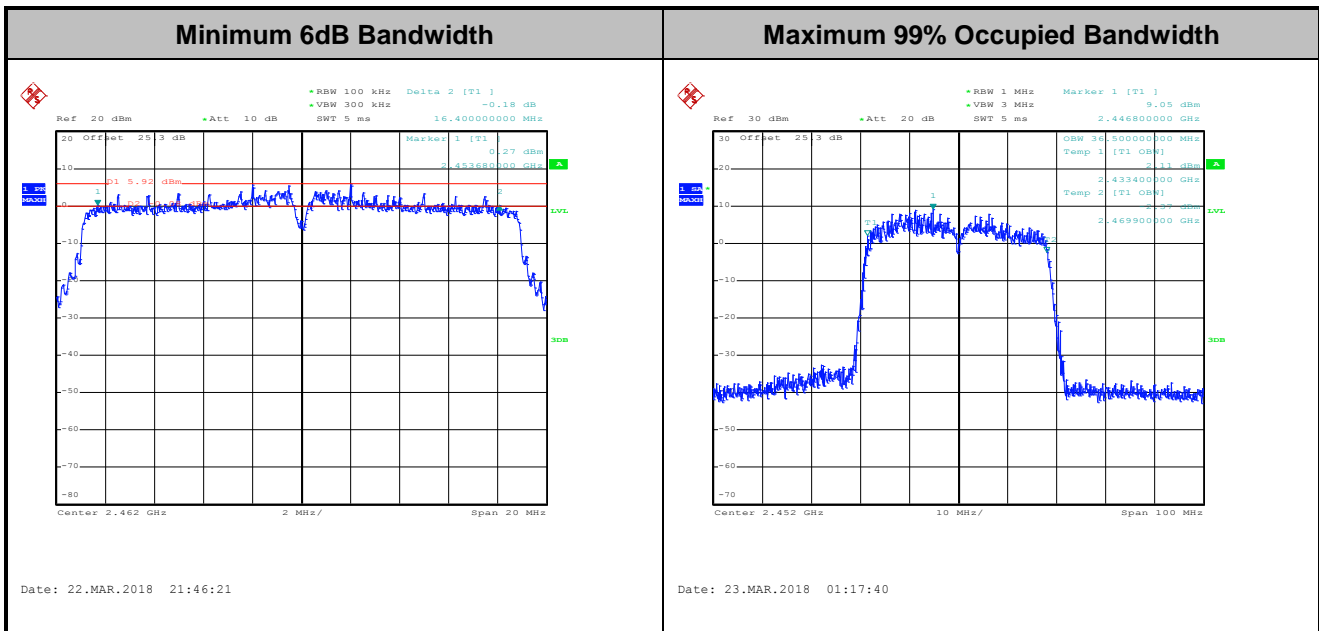

Note : The occupied channel bandwidth is maintained within the band of operation for all of the modulations.



3.2 Output Power Measurement

3.2.1 Limit of Output Power

For systems using digital modulation in the 2400-2483.5MHz, the limit for output power is 30dBm. If transmitting antenna with directional gain greater than 6dBi is used, the output power from the intentional radiator shall be reduced below the above stated value by the amount in dB that the directional gain of the antenna exceeds 6 dBi. In case of point-to-point operation, the limit has to be reduced by 1dB for every 3dB that the directional gain of the antenna exceeds 6dBi.

3.2.2 Measuring Instruments

The measuring equipment is listed in the section 4 of this test report.

3.2.3 Test Procedures

<CDD Modes>

1. The testing follows the Measurement Procedure of FCC KDB No. 558074 DTS D01 Meas. Guidance v04 section 9.2.3.1 Method AVGPM.
2. The RF output of EUT was connected to the power meter by RF cable and attenuator. The path loss was compensated to the results for each measurement.
3. Set to the maximum power setting and enable the EUT transmit continuously.
4. Measure the conducted output power and record the results in the test report.
5. For MIMO mode, calculation method follows FCC KDB 662911 D01 Multiple Transmitter Output v02r01.

<TXBF Modes>

1. The testing follows the Measurement Procedure of FCC KDB No. 558074 DTS D01 Meas. Guidance v04 section 9.2.3.2 Method AVGPM-G.
2. The RF output of EUT was connected to the power meter by RF cable and attenuator. The path loss was compensated to the results for each measurement.
3. Set to the maximum power setting and enable the EUT transmit continuously.
4. Measure the conducted output power and record the results in the test report.
5. For MIMO mode, calculation method follows FCC KDB 662911 D01 Multiple Transmitter Output v02r01.

3.2.4 Test Setup

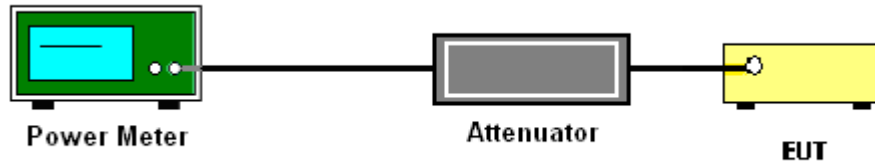

3.2.5 Test Result of Peak Output Power (Reporting Only)

Please refer to Appendix A.

3.2.6 Test Result of Average output Power

Please refer to Appendix A.



3.3 Power Spectral Density Measurement

3.3.1 Limit of Power Spectral Density

The peak power spectral density shall not be greater than 8dBm in any 3kHz band at any time interval of continuous transmission.

3.3.2 Measuring Instruments

The measuring equipment is listed in the section 4 of this test report.

3.3.3 Test Procedures

<CDD Modes>

Method AVGPSD-2

1. The testing follows Measurement Procedure 10.5 Method AVGPSD-2 of FCC KDB Publication No. 558074 D01 DTS Meas. Guidance v04.
2. The RF output of EUT was connected to the spectrum analyzer by RF cable and attenuator. The path loss was compensated to the results for each measurement.
3. Set to the maximum power setting and enable the EUT transmit continuously.
4. Make the measurement with the spectrum analyzer's resolution bandwidth (RBW) = 10 kHz. Video bandwidth VBW = 30 kHz In order to make an accurate measurement, set the span to 1.5 times DTS Channel Bandwidth. (6dB BW).
5. Number of points in sweep ≥ 2 Span / RBW. (This ensures that bin-to-bin spacing is \leq RBW/2, so that narrowband signals are not lost between frequency bins).
6. Detector = RMS, Sweep time = auto couple.
7. Trace average at least 100 traces in power averaging mode.
8. Add $10 \log(1/x)$, where x is the duty cycle, to the measured power in order to compute the average power during the actual transmission times. For example, add $10 \log(1/0.25) = 6$ dB if the duty cycle is 25 percent.
9. Measure and record the results in the test report. For MIMO mode, calculation method follows FCC KDB 662911 D01 Multiple Transmitter Output v02r01.

Method (c): Measure and add $10 \log(N_{\text{ANT}})$ dB.

With this technique, spectrum measurements are performed at each output of the device, but rather than summing the spectra or the spectral peaks across the outputs, the quantity $10 \log(N_{\text{ANT}})$ dB is added to each spectrum value before comparing to the emission limit. The addition of $10 \log(N_{\text{ANT}})$ dB serves to apportion the emission limit among the N_{ANT} outputs so that each output is permitted to contribute no more than $1/N_{\text{ANT}}^{\text{th}}$ of the PSD limit .

<TXBF Modes>**Method AVGPSD-3**

1. The testing follows Measurement Procedure 10.7 Method AVGPSD-3 of FCC KDB Publication No. 558074 D01 DTS Meas. Guidance v04.
2. The RF output of EUT was connected to the spectrum analyzer by RF cable and attenuator. The path loss was compensated to the results for each measurement.
3. Set to the maximum power setting and enable the EUT transmit continuously.
4. Make the measurement with the spectrum analyzer's resolution bandwidth (RBW) = 10 kHz. Video bandwidth VBW = 30 kHz In order to make an accurate measurement, set the span to 1.5 times DTS Channel Bandwidth. (6dB BW).
5. Number of points in sweep ≥ 2 Span / RBW. (This ensures that bin-to-bin spacing is \leq RBW/2, so that narrowband signals are not lost between frequency bins).
6. Detector = RMS, Sweep time = auto couple.
7. Trace mode = max hold.
8. Allow max hold to run for at least 60 seconds, or longer as needed to allow the trace to stabilize.
9. Measure and record the results in the test report. For MIMO mode, calculation method follows FCC KDB 662911 D01 Multiple Transmitter Output v02r01.

Method (c): Measure and add $10 \log(N_{\text{ANT}})$ dB.

With this technique, spectrum measurements are performed at each output of the device, but rather than summing the spectra or the spectral peaks across the outputs, the quantity $10 \log(N_{\text{ANT}})$ dB is added to each spectrum value before comparing to the emission limit. The addition of $10 \log(N_{\text{ANT}})$ dB serves to apportion the emission limit among the N_{ANT} outputs so that each output is permitted to contribute no more than $1/N_{\text{ANT}}^{\text{th}}$ of the PSD limit .

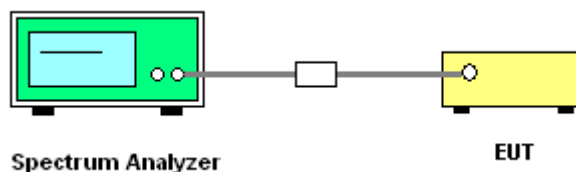
3.3.4 Test Setup



3.3.5 Test Result of Power Spectral Density

Please refer to Appendix A.

<CDD Modes>

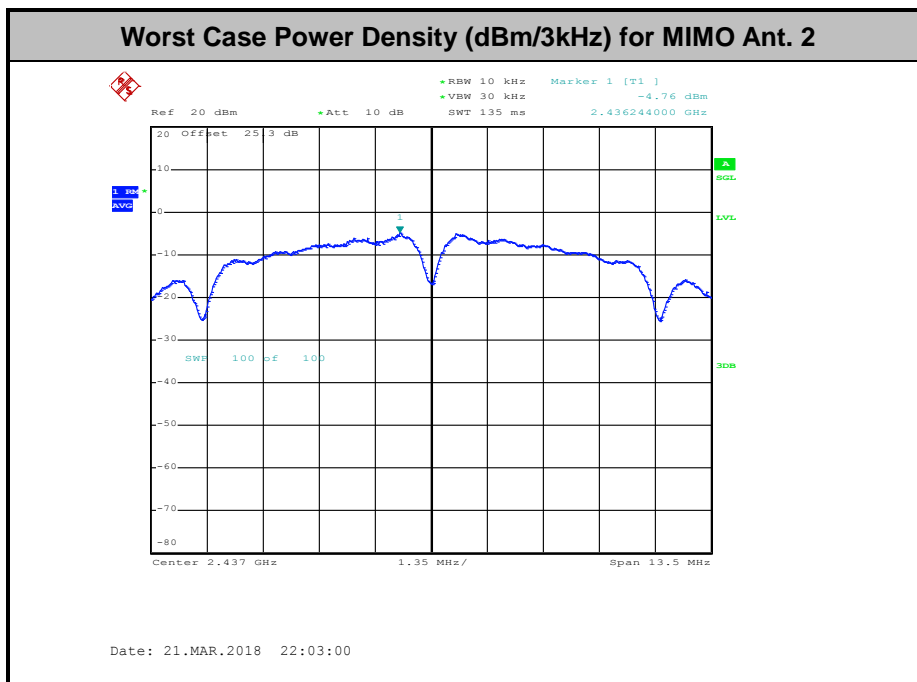
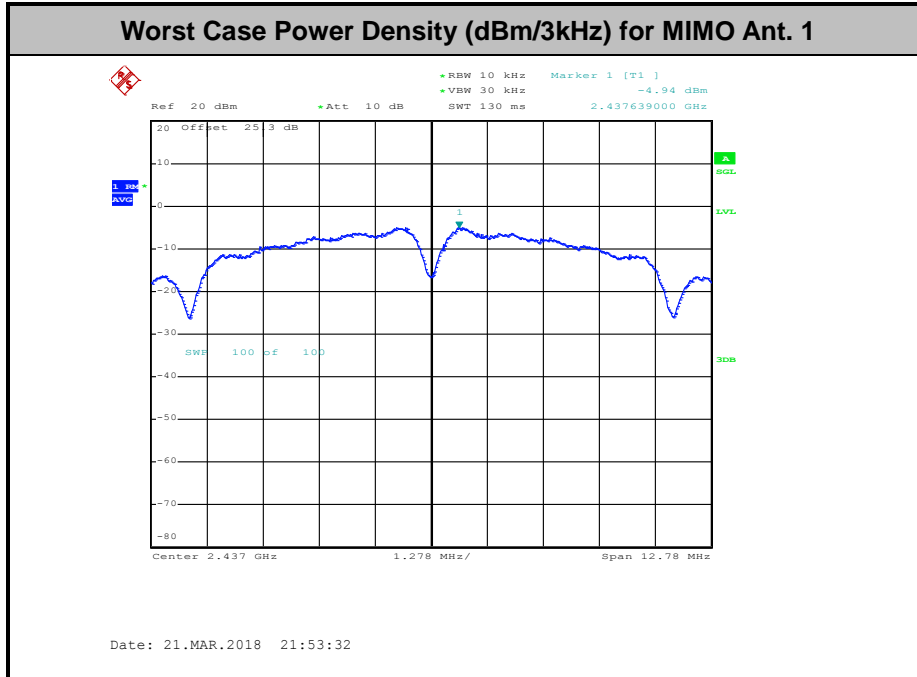



<TXBF Modes>

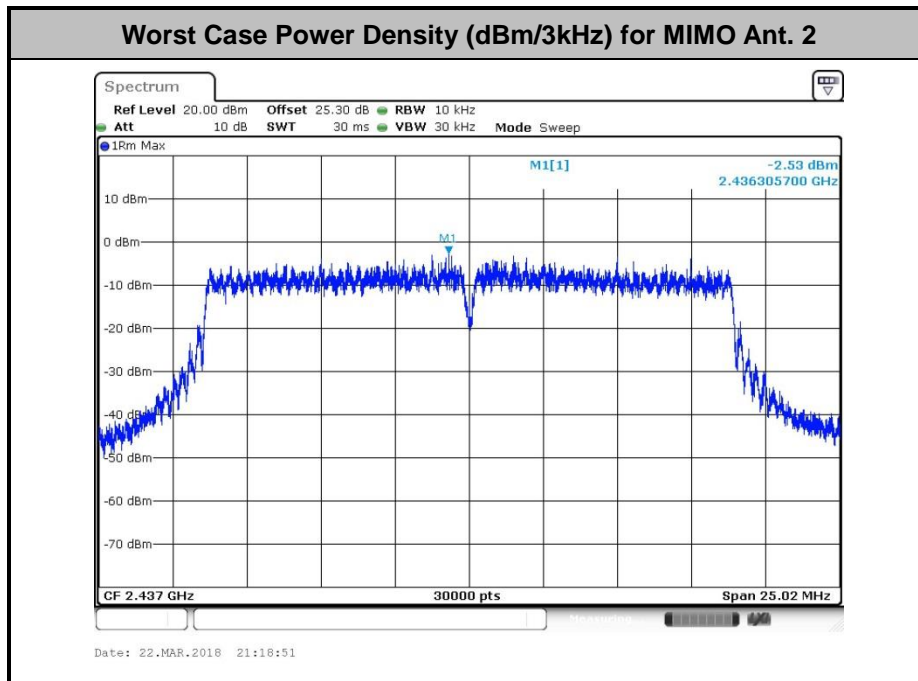
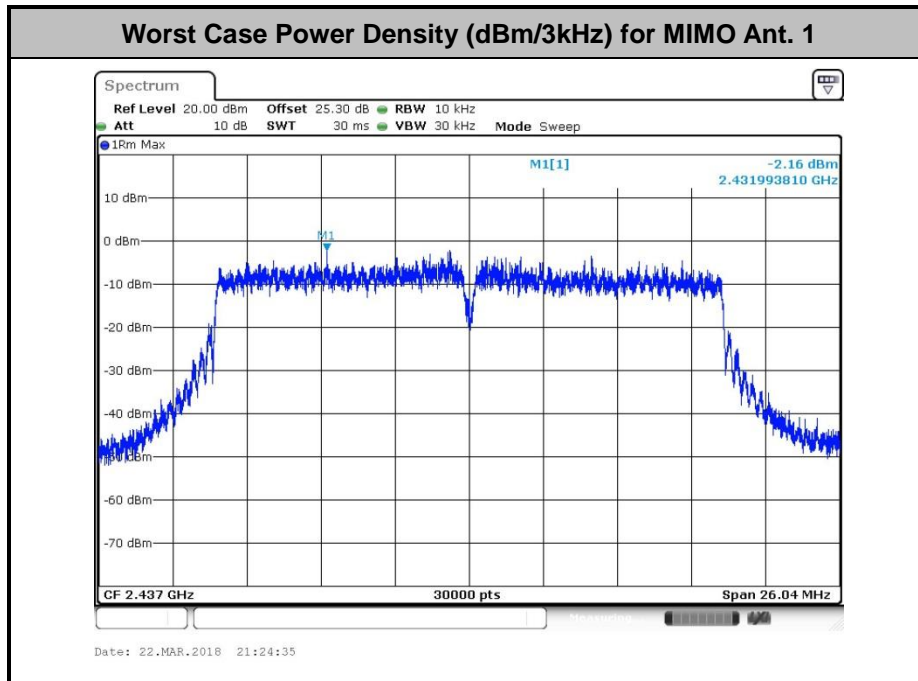

3.4 Conducted Band Edges and Spurious Emission Measurement

3.4.1 Limit of Conducted Band Edges and Spurious Emission Measurement

In any 100 kHz bandwidth outside of the authorized frequency band, the emissions which fall in the non-restricted bands shall be attenuated at least 20 dB / 30dB relative to the maximum PSD level in 100 kHz by RF conducted measurement.

3.4.2 Measuring Instruments

The measuring equipment is listed in the section 4 of this test report.

3.4.3 Test Procedures

1. The testing follows FCC KDB Publication No. 558074 D01 DTS Meas. Guidance v04.
2. The RF output of EUT was connected to the spectrum analyzer by RF cable and attenuator. The path loss was compensated to the results for each measurement.
3. Set to the maximum power setting and enable the EUT transmit continuously.
4. Set RBW = 100 kHz, VBW=300 kHz, Peak Detector. Unwanted Emissions measured in any 100 kHz bandwidth outside of the authorized frequency band shall be attenuated by at least 20 dB relative to the maximum in-band peak PSD level in 100 kHz when maximum peak conducted output power procedure is used. If the transmitter complies with the conducted power limits based on the use of RMS averaging over a time interval, the attenuation required under this paragraph shall be 30 dB instead of 20 dB per 15.247(d).
5. Measure and record the results in the test report.
6. The RF fundamental frequency should be excluded against the limit line in the operating frequency band.

3.4.4 Test Setup

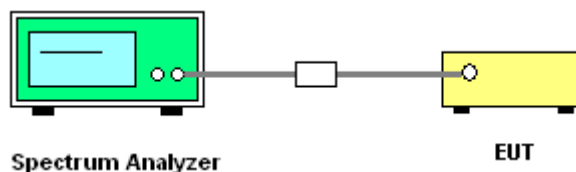



3.4.5 Test Result of Conducted Band Edges and Spurious Emission

Test Engineer : Kai Liao	Temperature :	21~25°C
	Relative Humidity :	51~54%

Number of TX = 1, Ant. 1 (Measured)

Test Mode :	802.11b	Test Channel :	01
-------------	---------	----------------	----

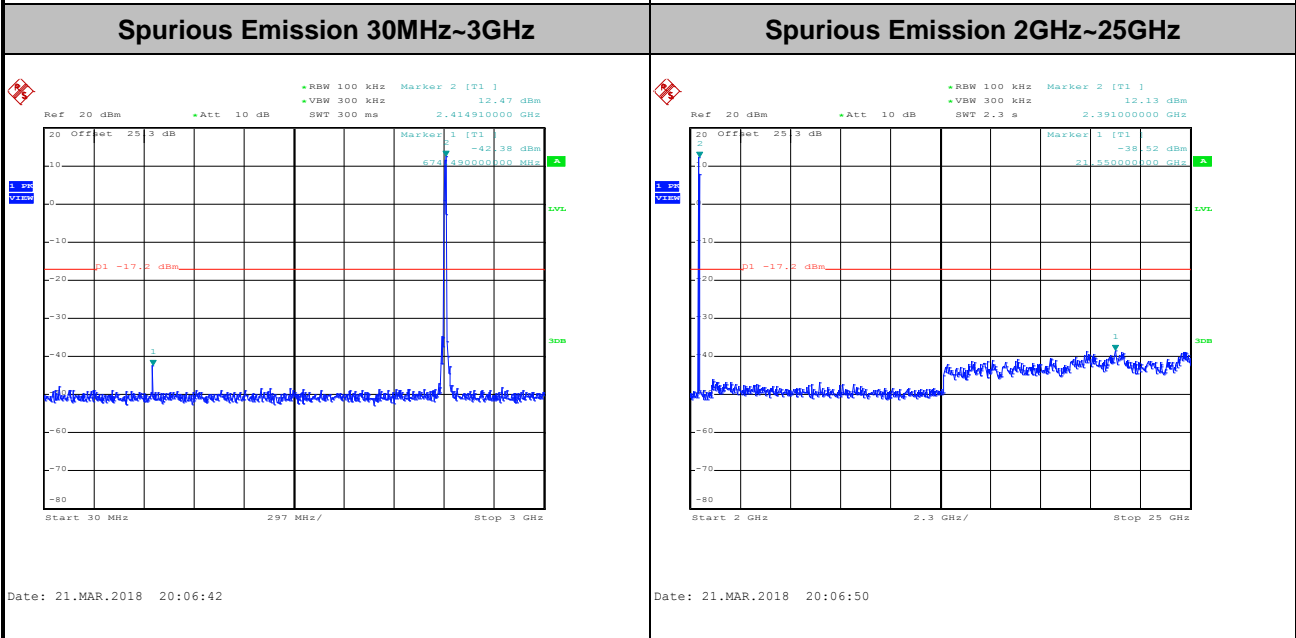
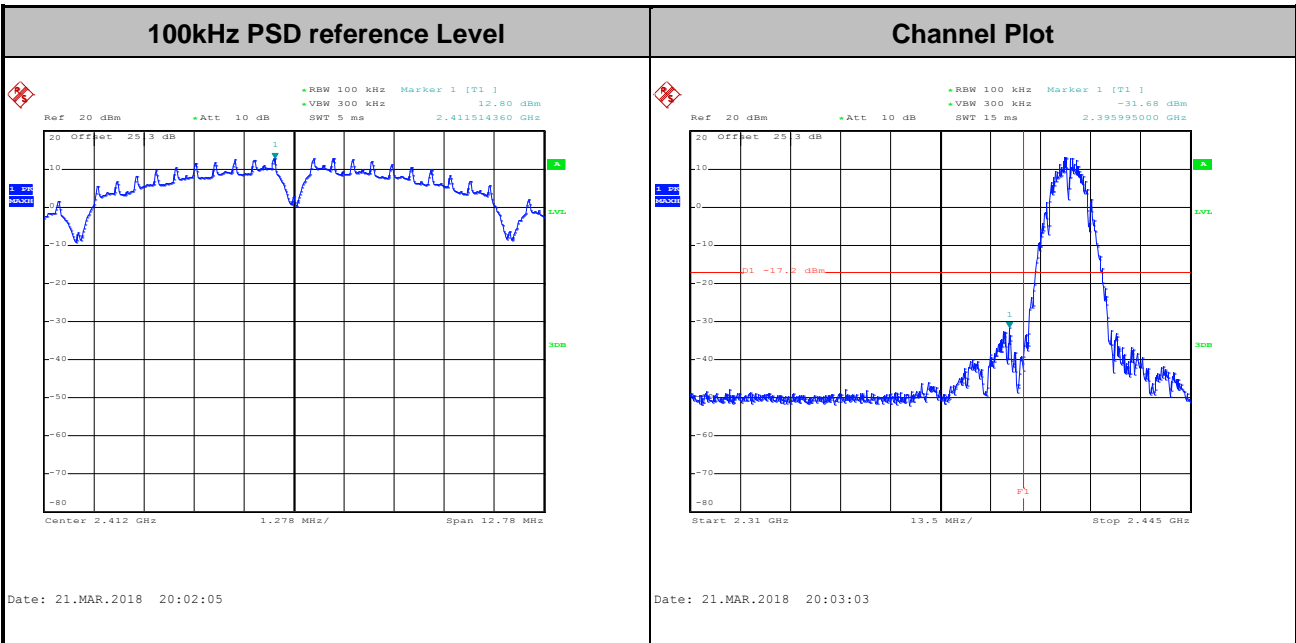



Test Mode :	802.11b	Test Channel :	06
-------------	---------	----------------	----

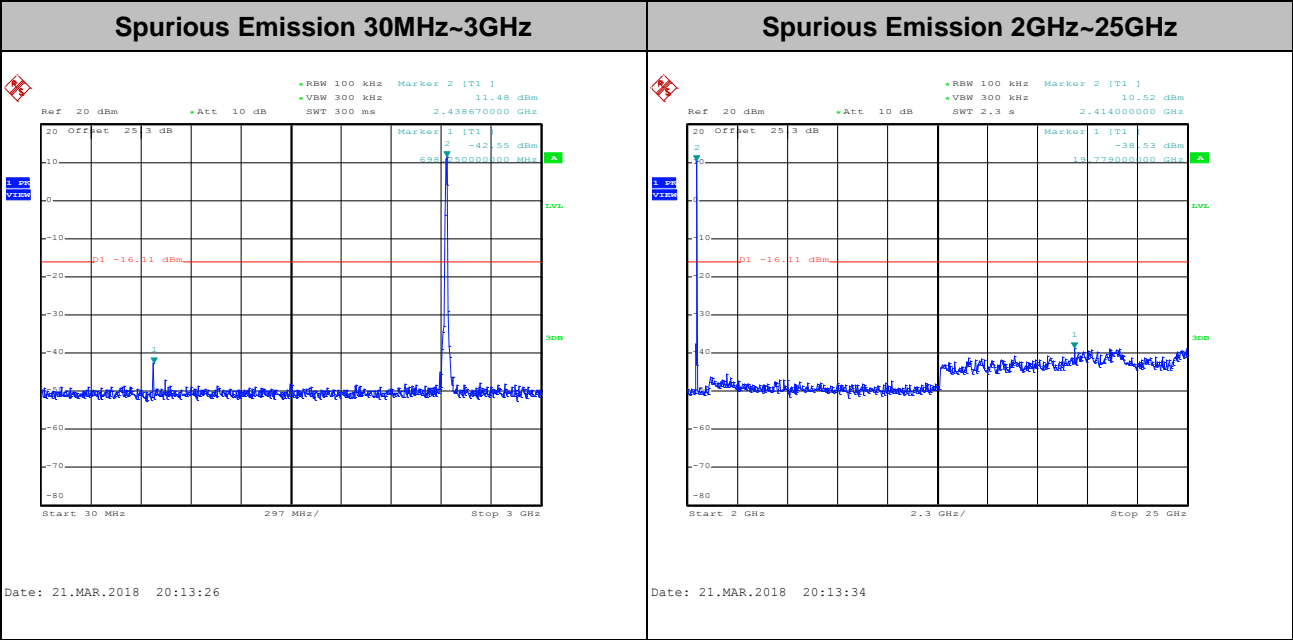
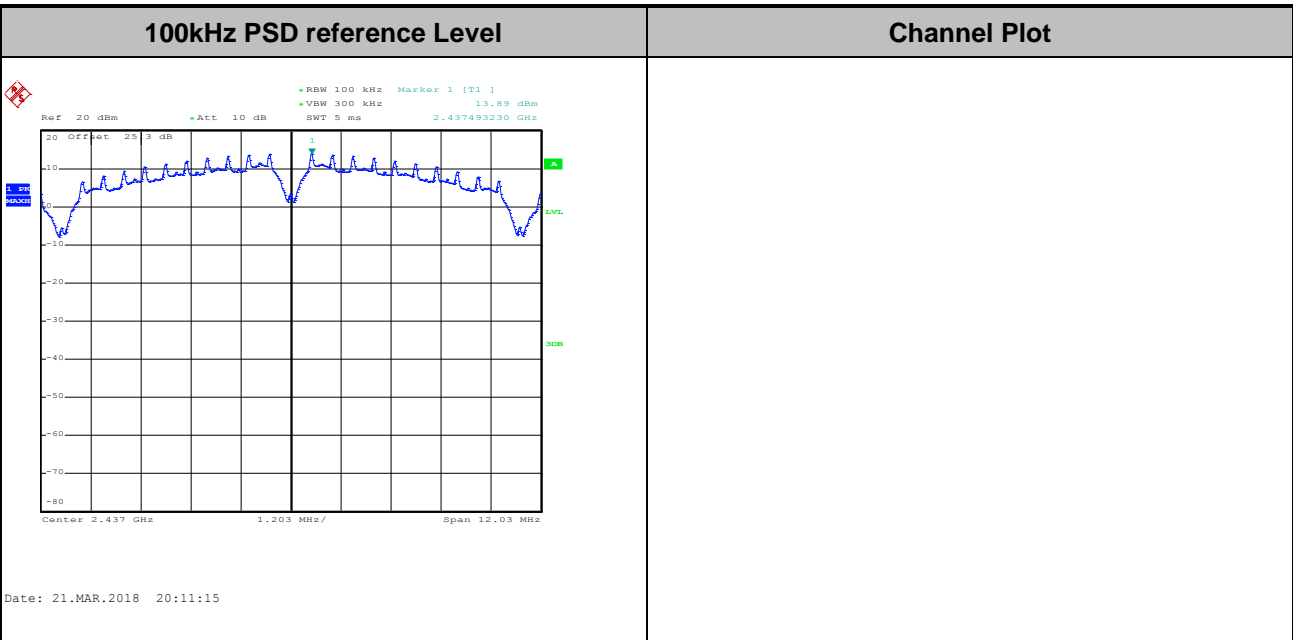



Test Mode :	802.11b	Test Channel :	11
-------------	---------	----------------	----

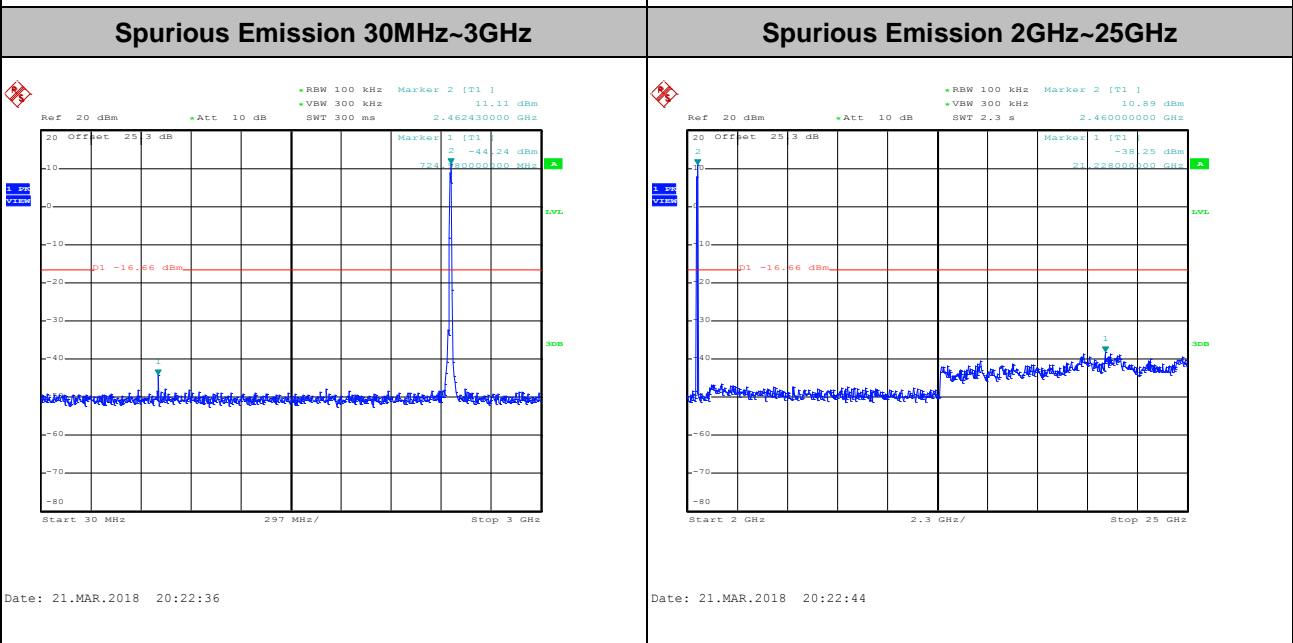
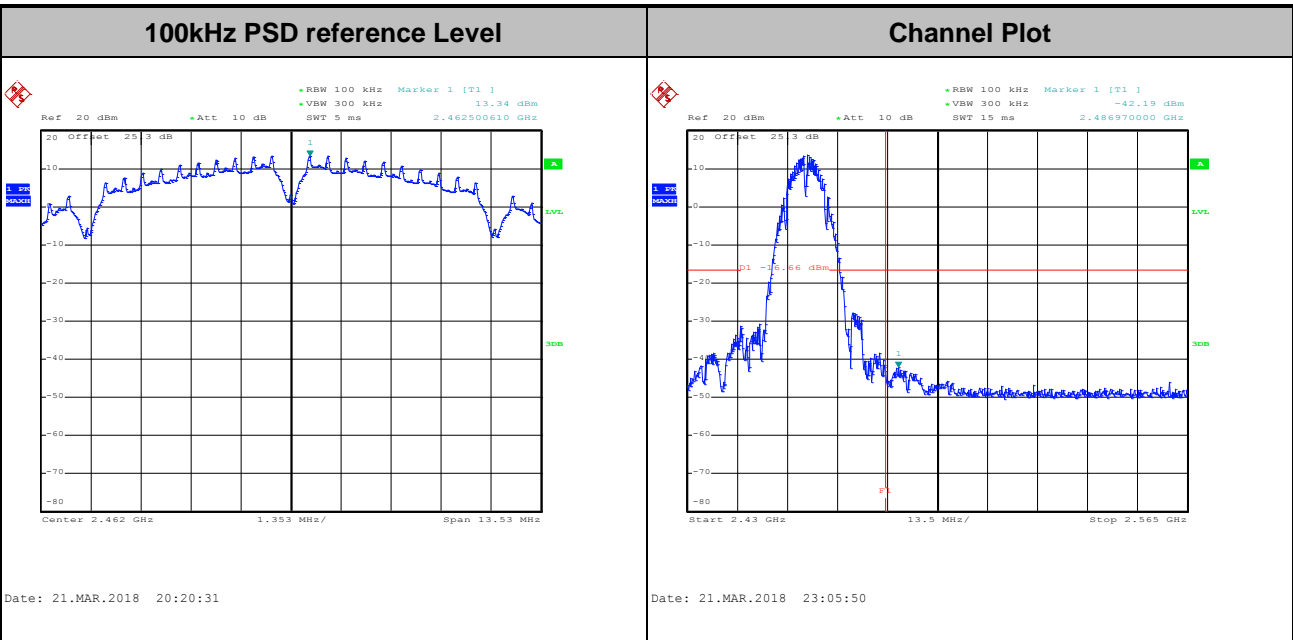



Test Mode :	802.11g	Test Channel :	01
-------------	---------	----------------	----

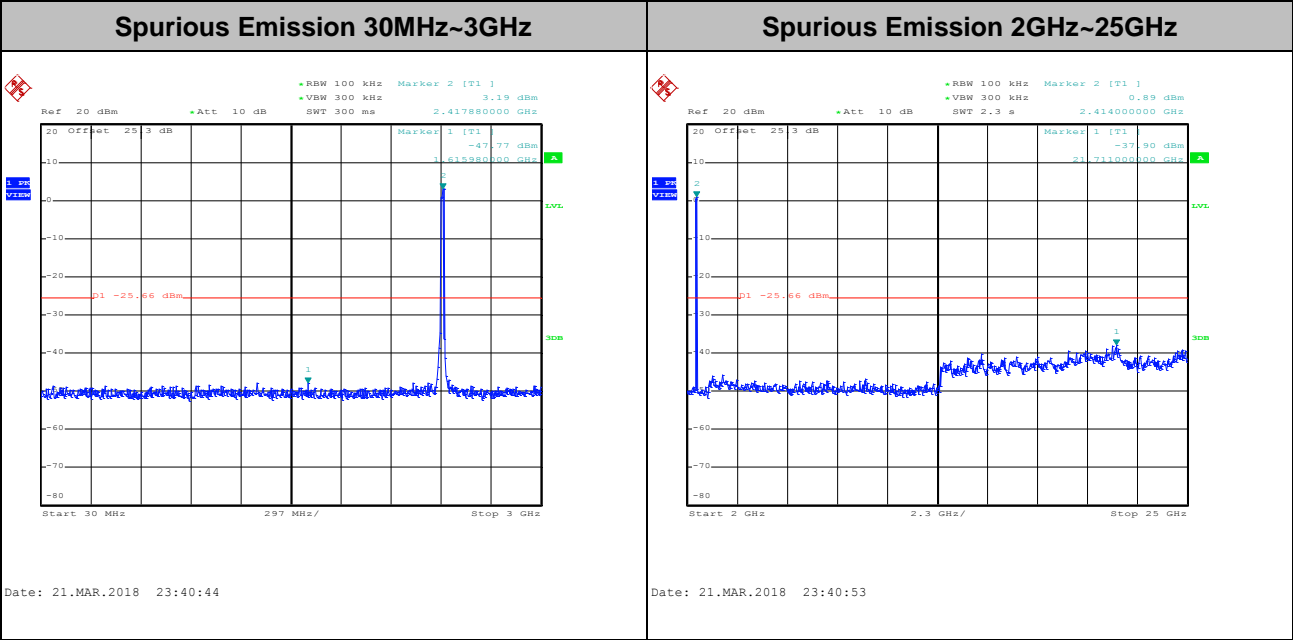
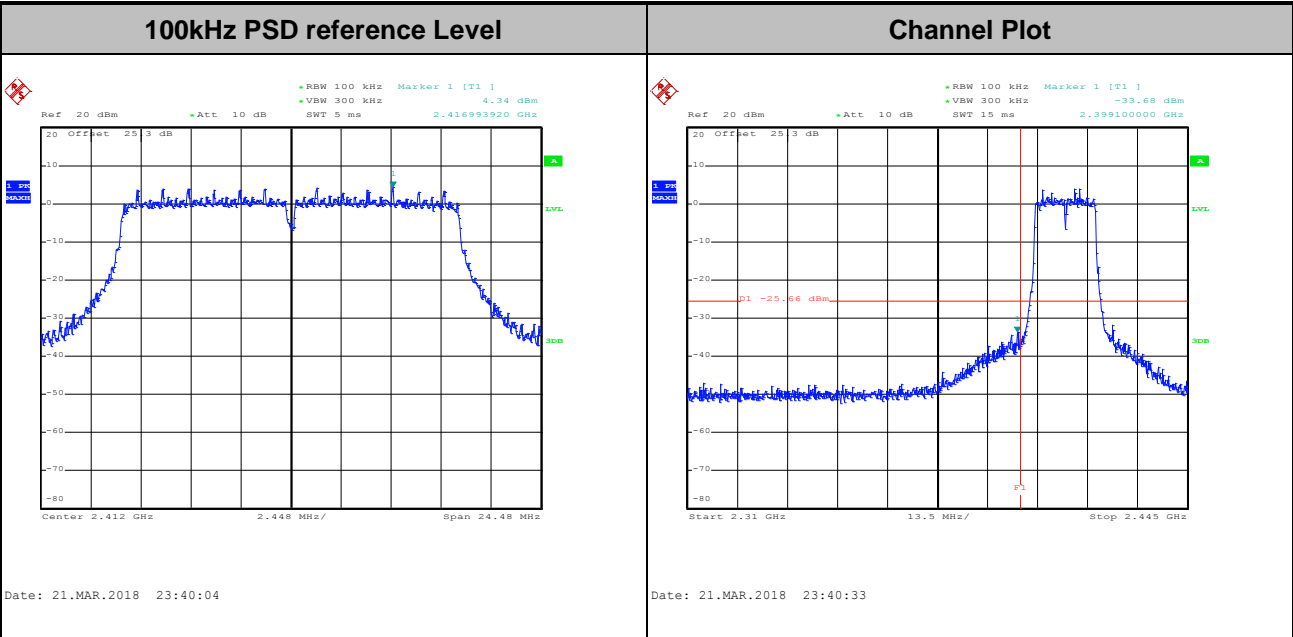



Test Mode :	802.11g	Test Channel :	06
-------------	---------	----------------	----

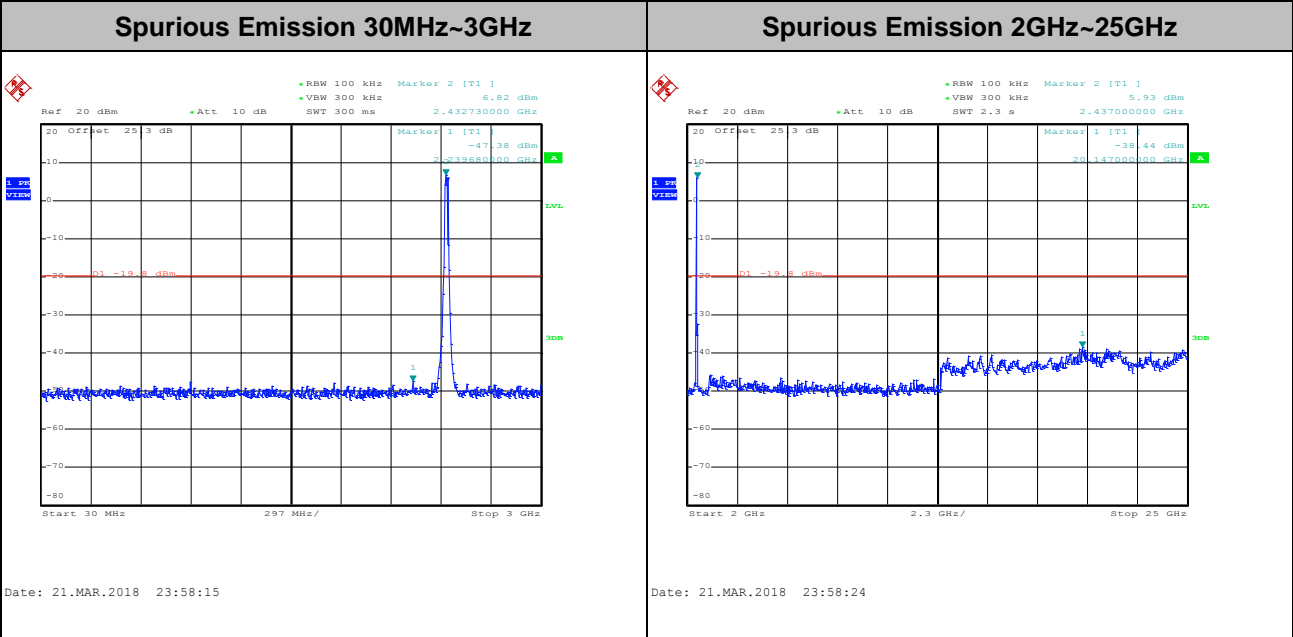
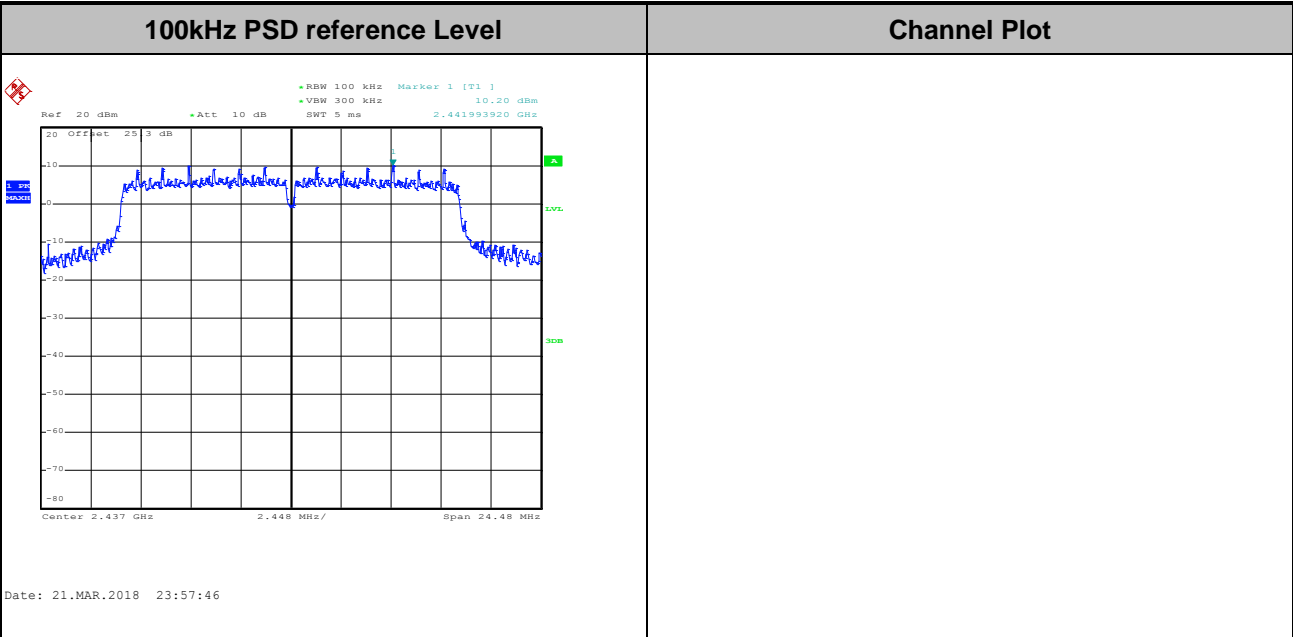



Test Mode :	802.11g	Test Channel :	11
-------------	---------	----------------	----

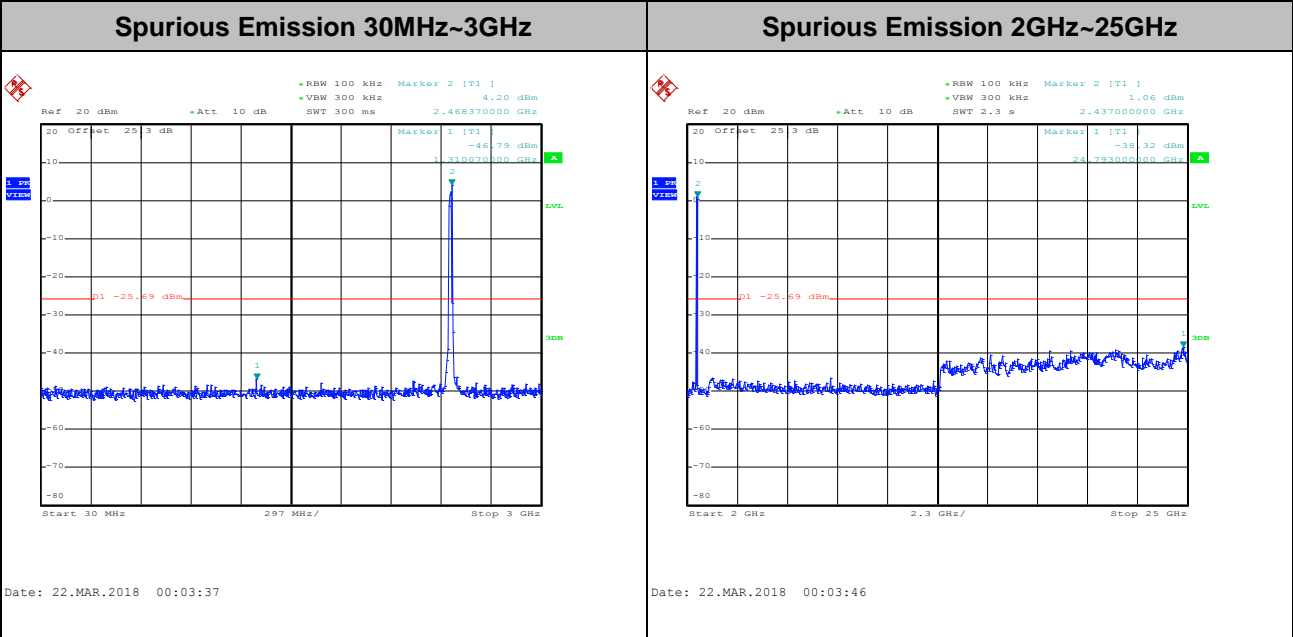
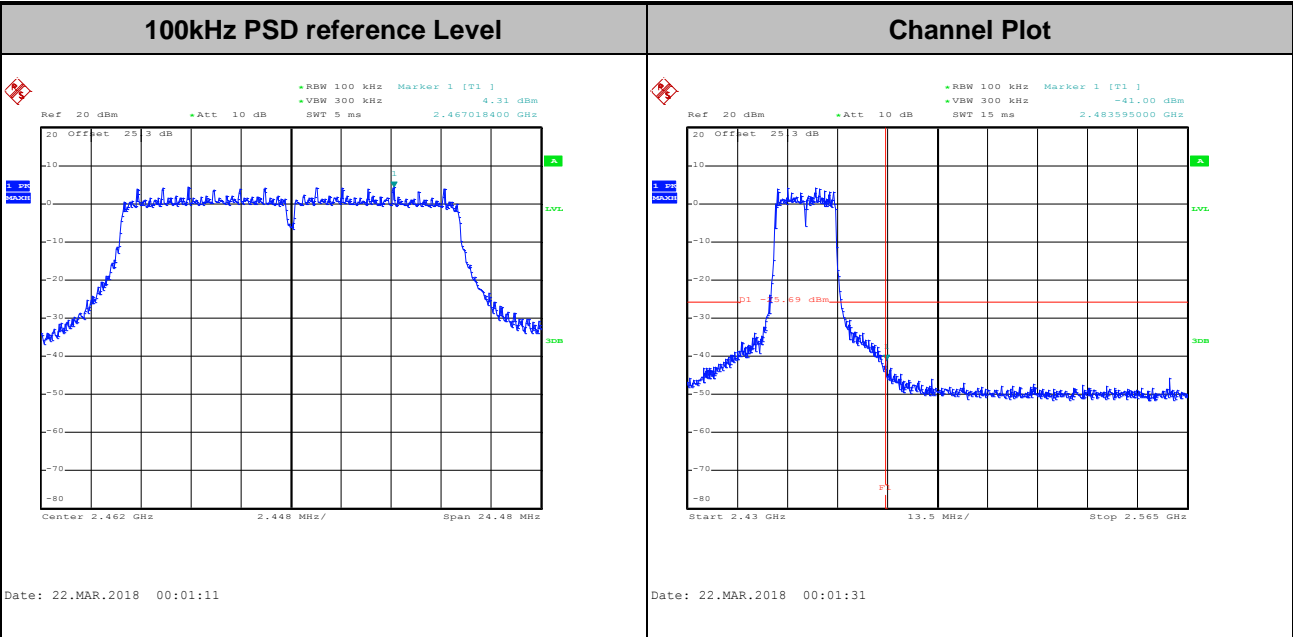



Test Mode :	802.11ac VHT20	Test Channel :	01
-------------	----------------	----------------	----

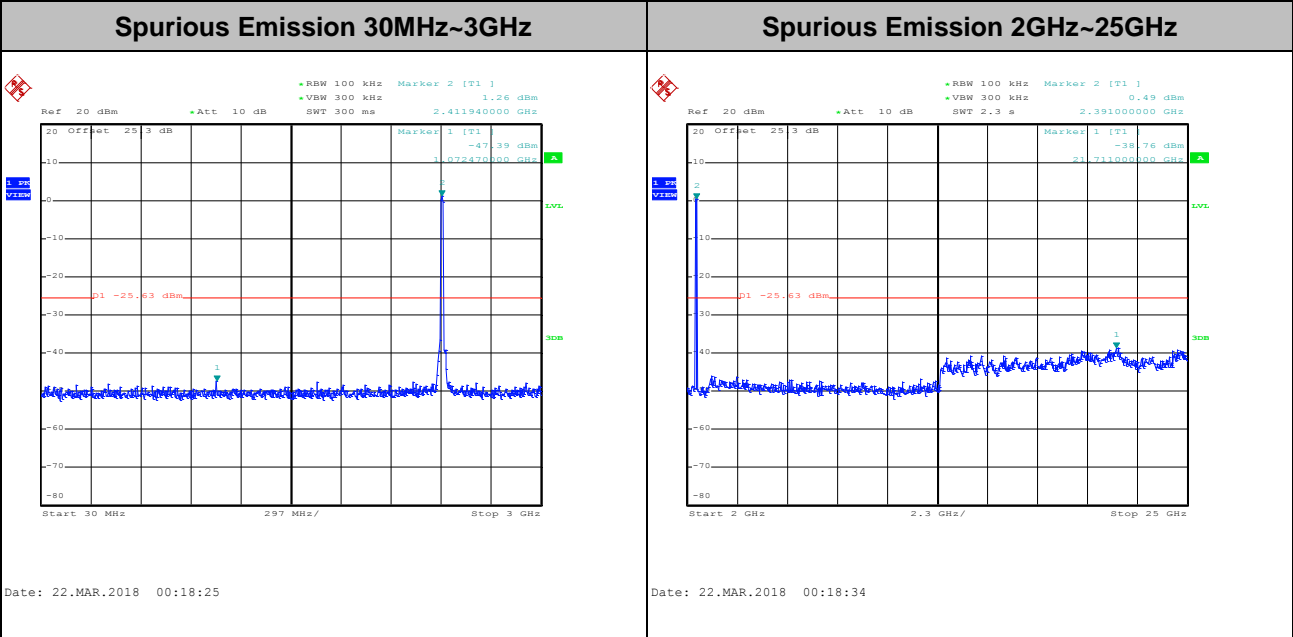
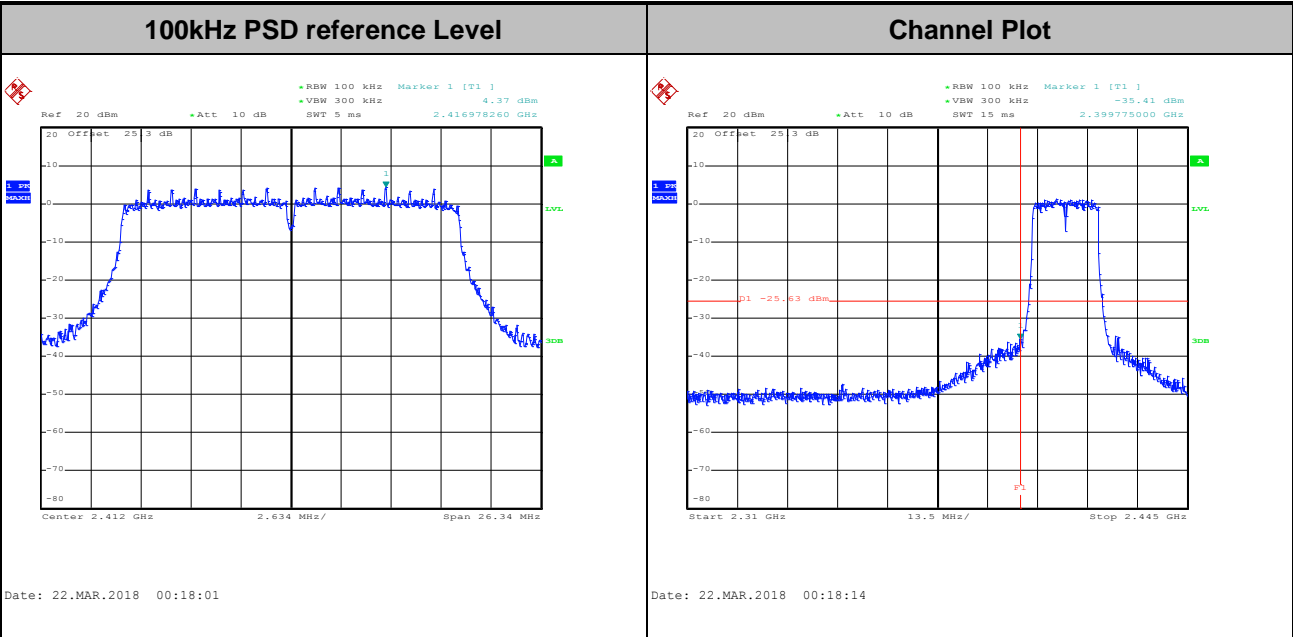



Test Mode :	802.11ac VHT20	Test Channel :	06
-------------	----------------	----------------	----

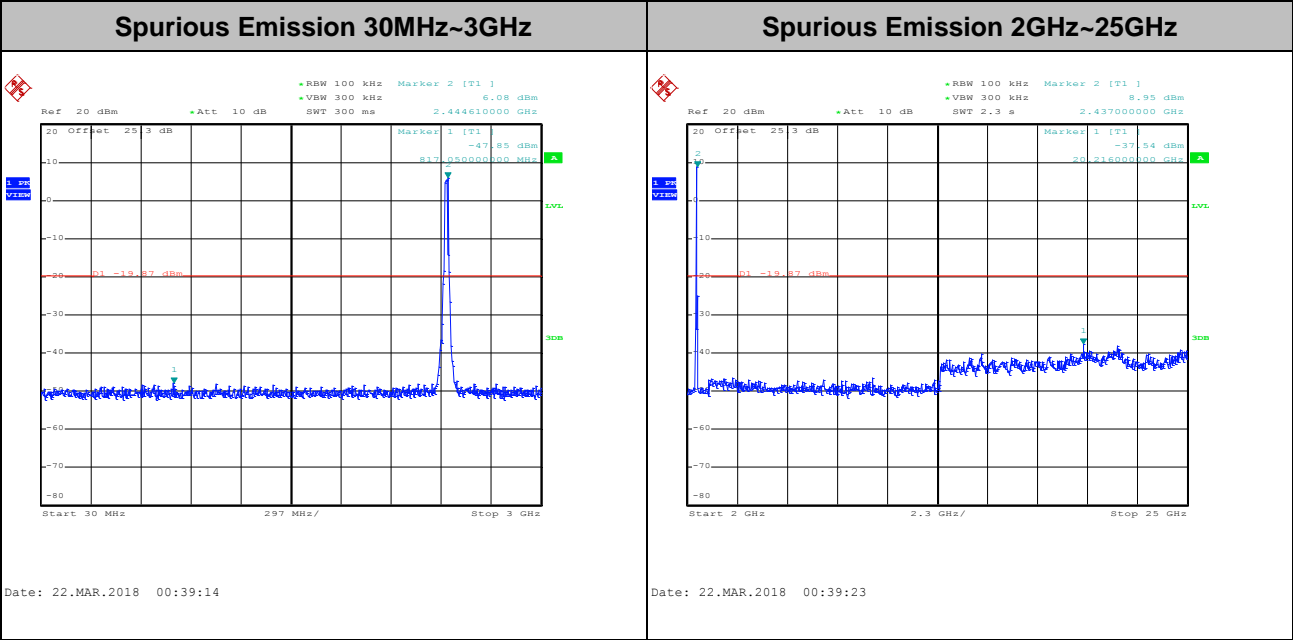
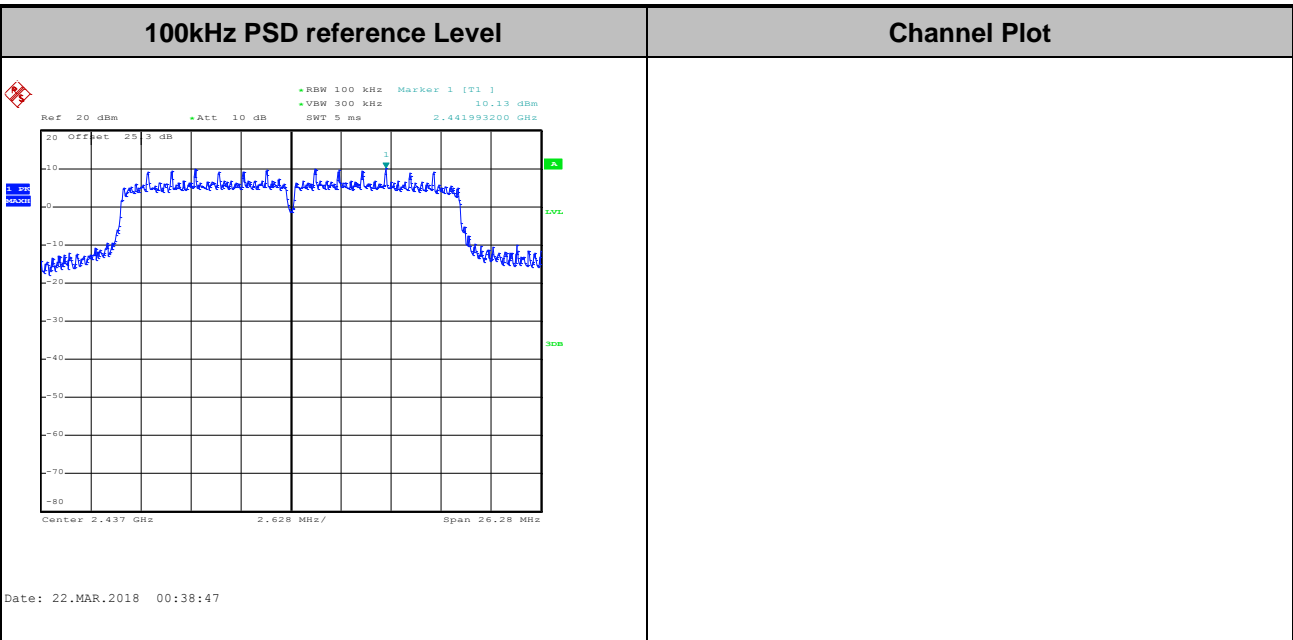



Test Mode :	802.11ac VHT20	Test Channel :	11
-------------	----------------	----------------	----

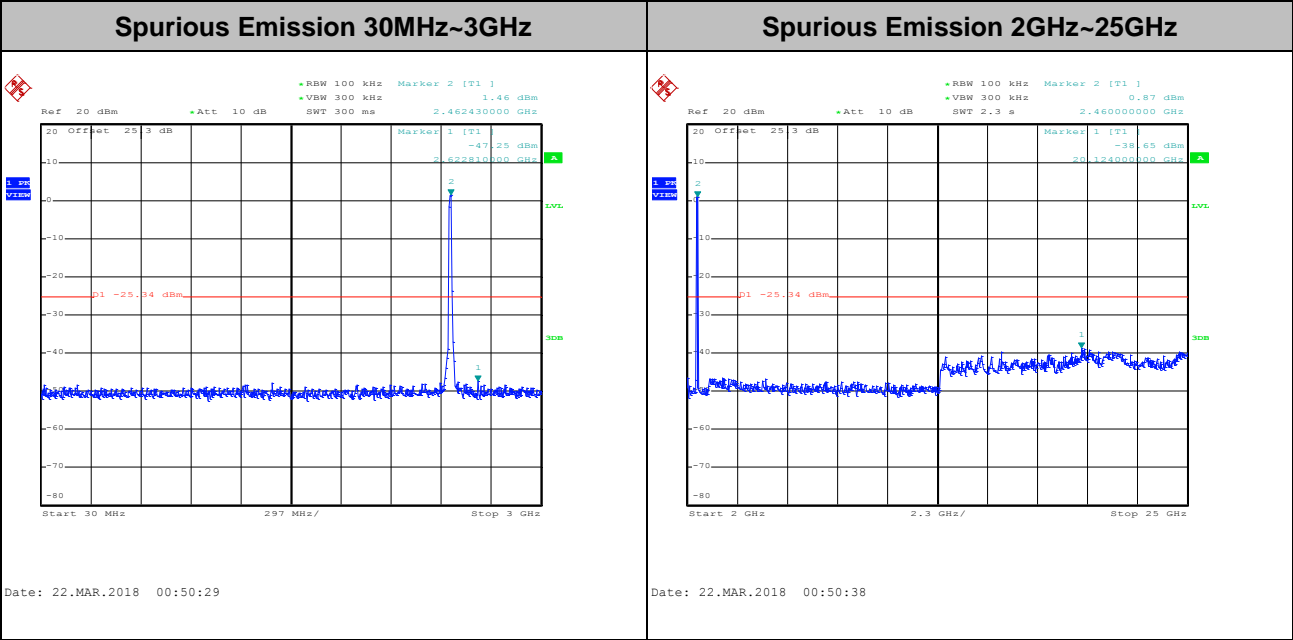
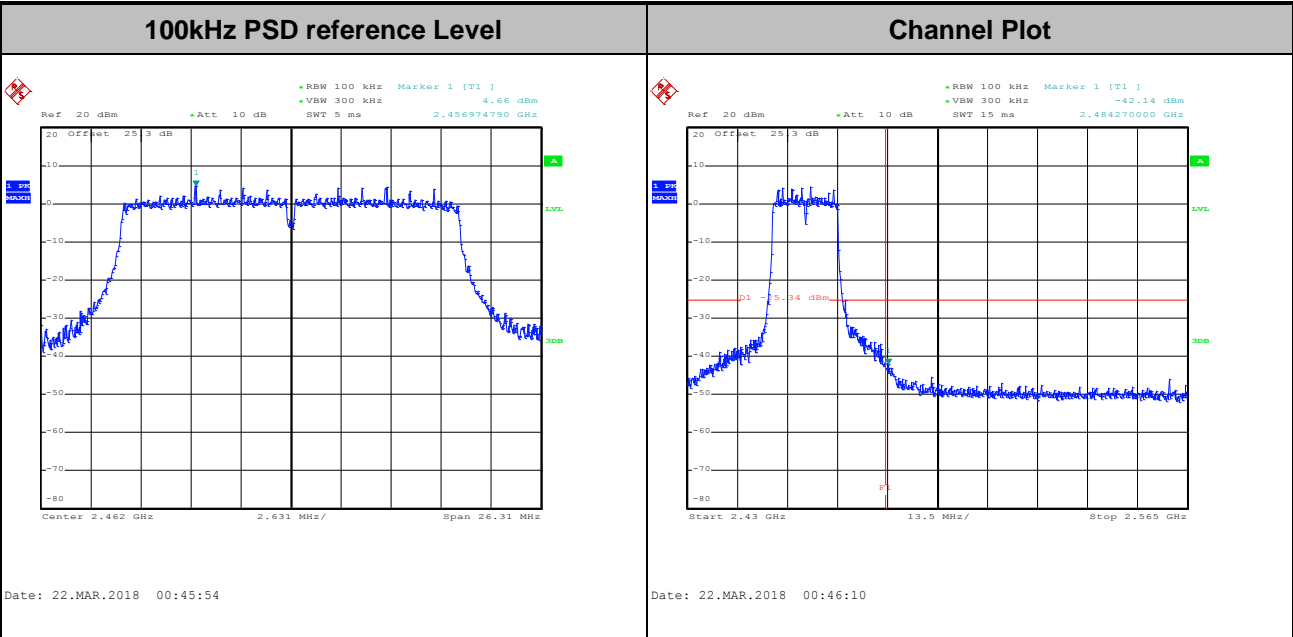



Test Mode :	802.11ac VHT40	Test Channel :	03
-------------	----------------	----------------	----

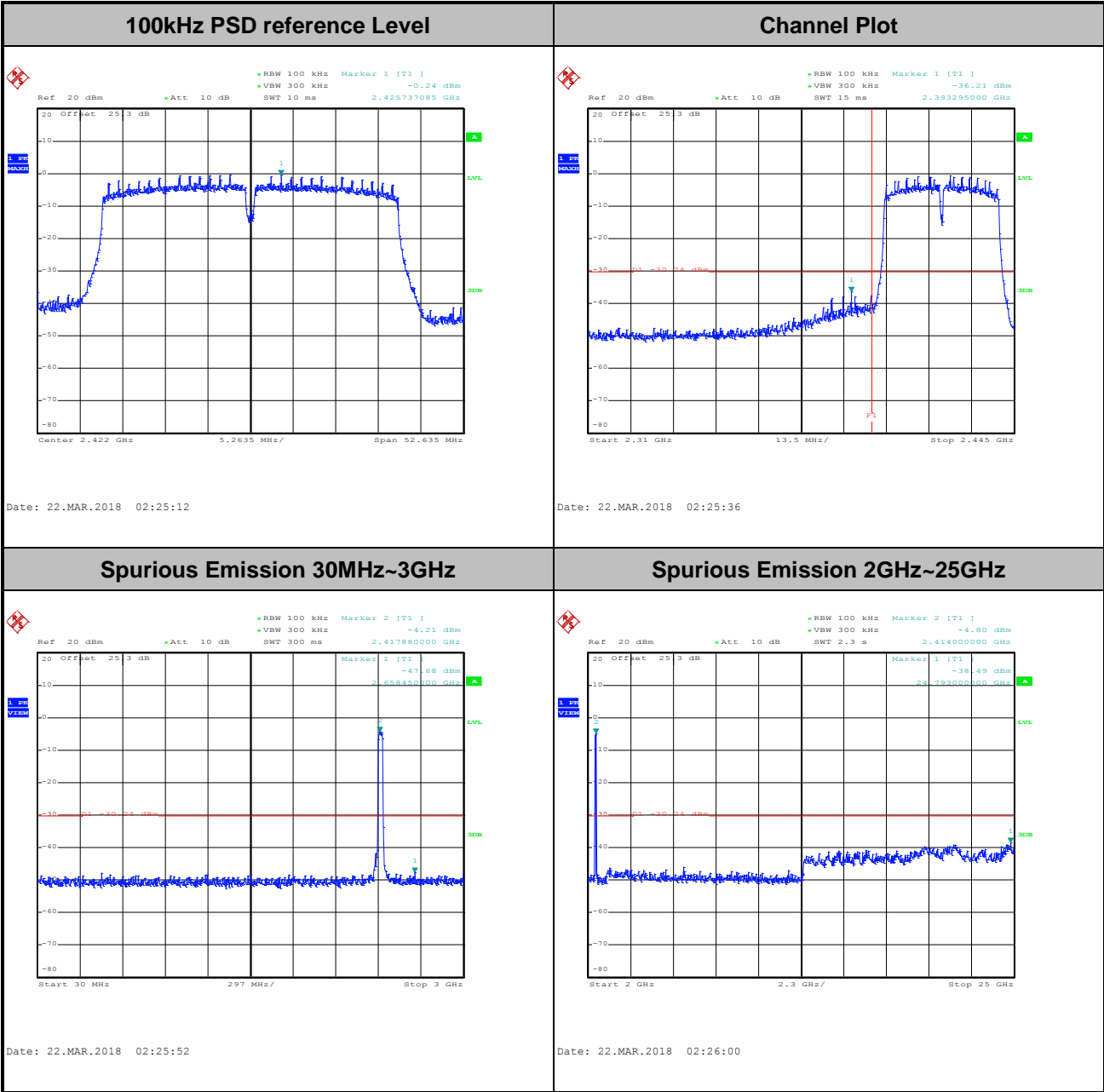



Test Mode :	802.11ac VHT40	Test Channel :	06
-------------	----------------	----------------	----

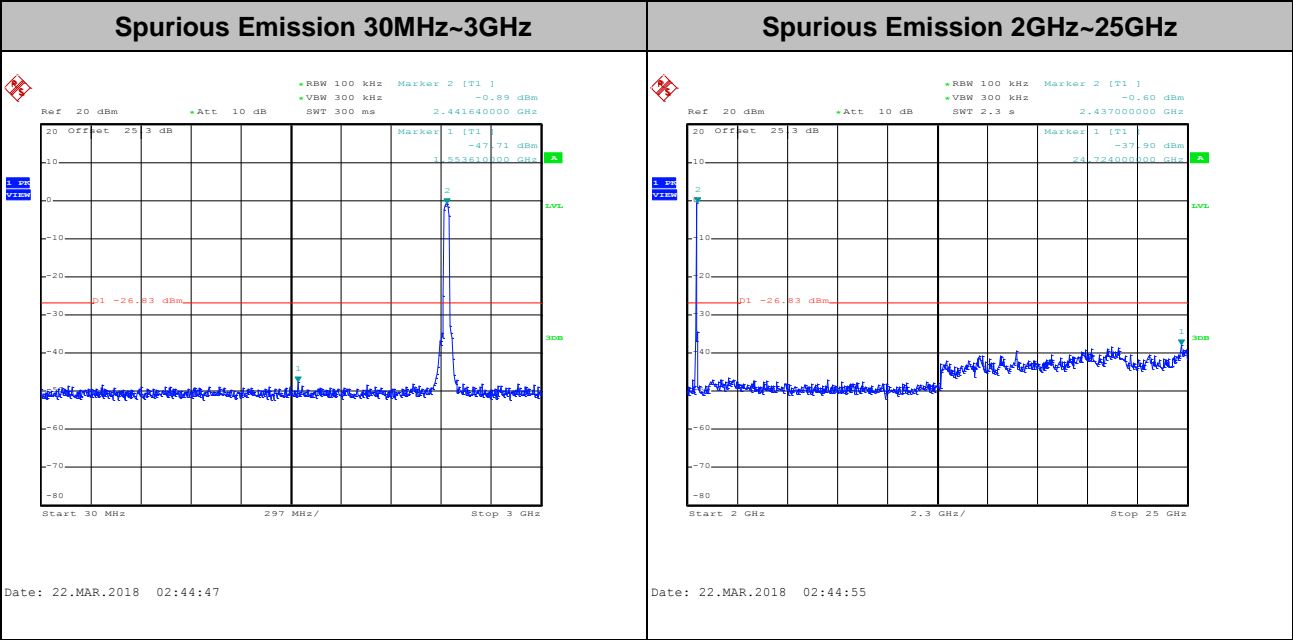
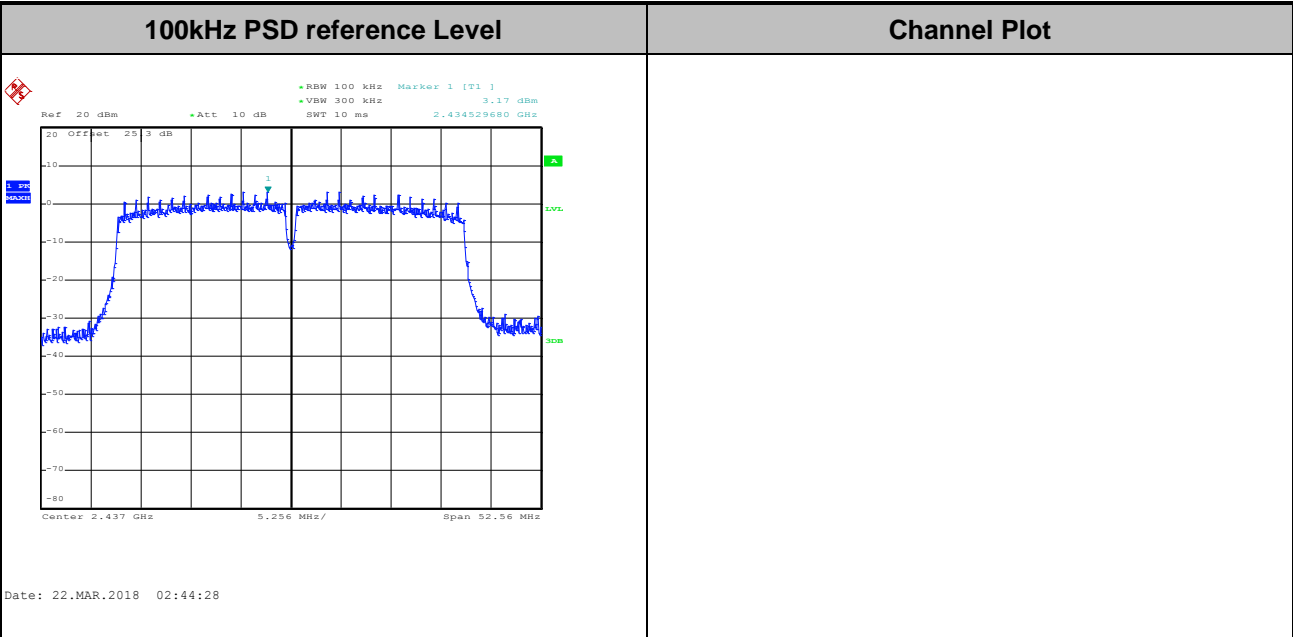



Test Mode :	802.11ac VHT40	Test Channel :	09
-------------	----------------	----------------	----

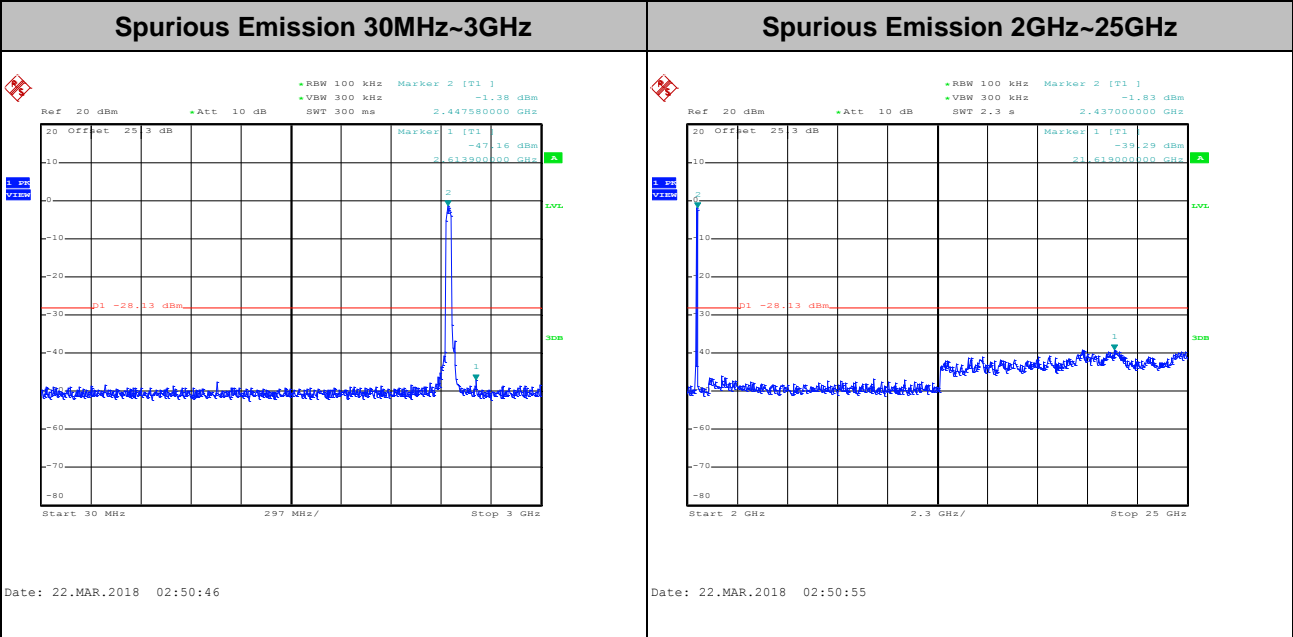
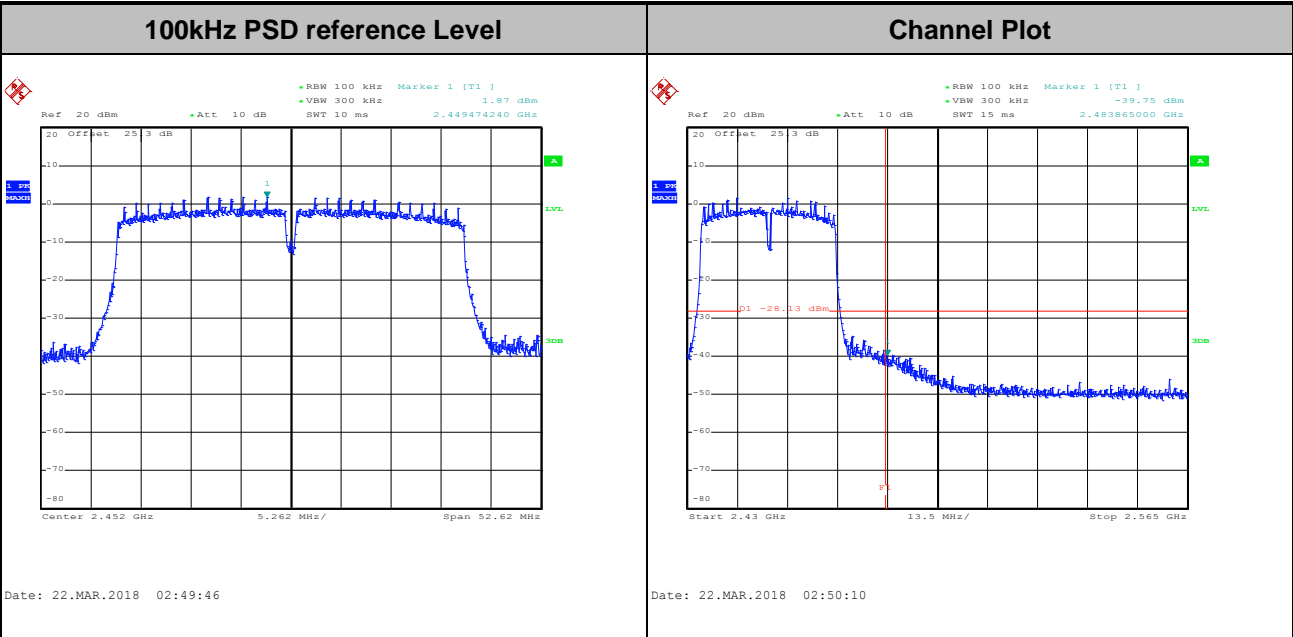



<CDD Modes>

Number of TX = 2, Ant. 1 (Measured)

Test Mode :	802.11b	Test Channel :	01
-------------	---------	----------------	----

100kHz PSD reference Level	Channel Plot
-----------------------------------	---------------------

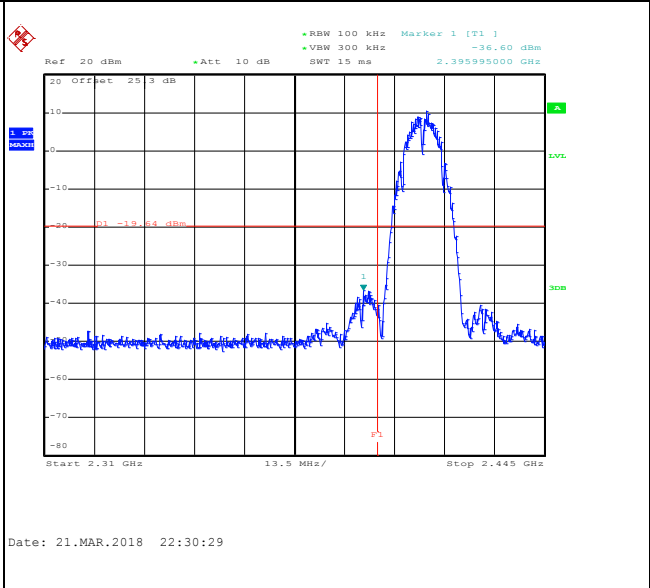
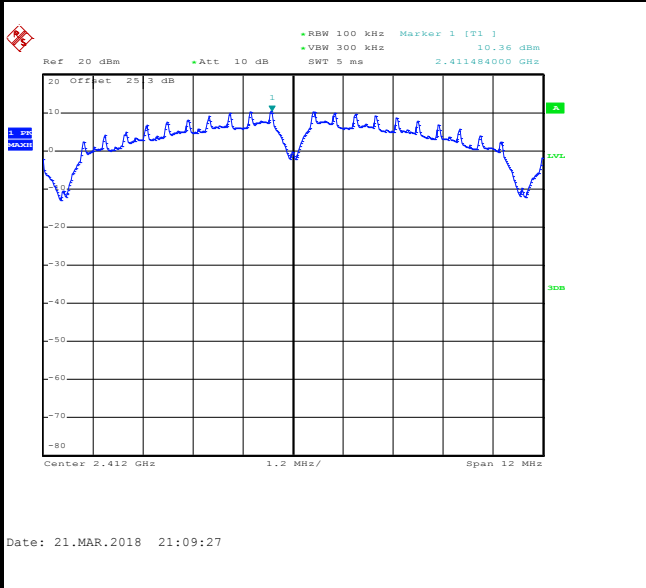

Spurious Emission 30MHz~3GHz	Spurious Emission 2GHz~25GHz
-------------------------------------	-------------------------------------

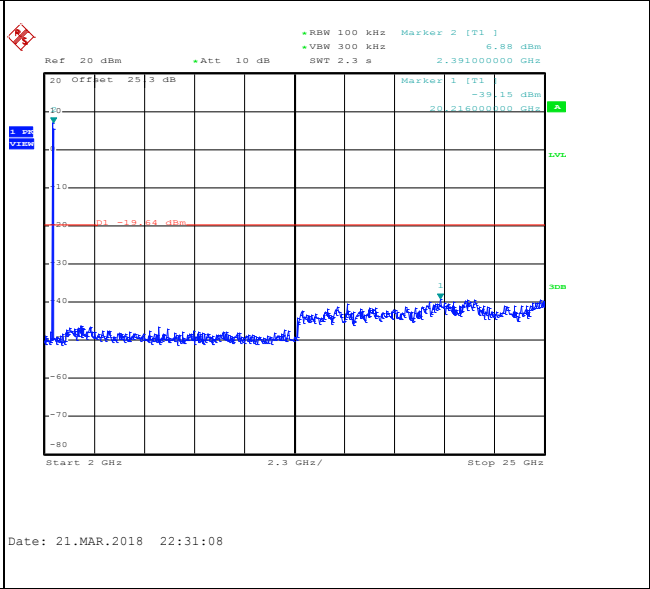
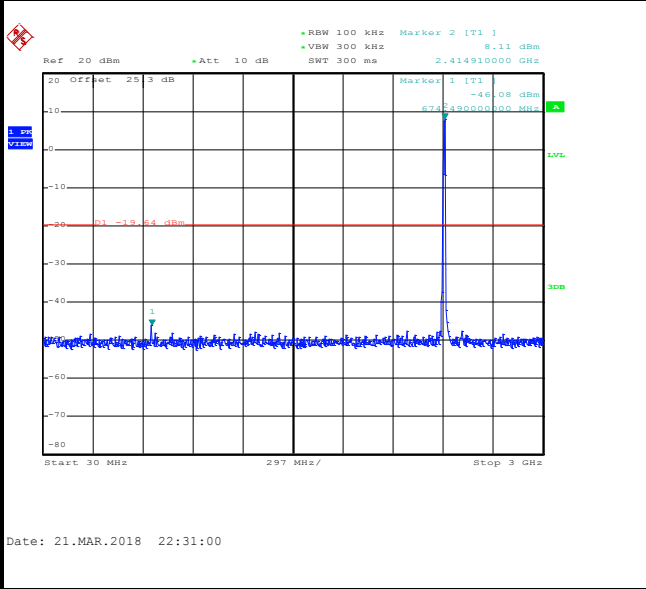



Test Mode :	802.11b	Test Channel :	06
-------------	---------	----------------	----

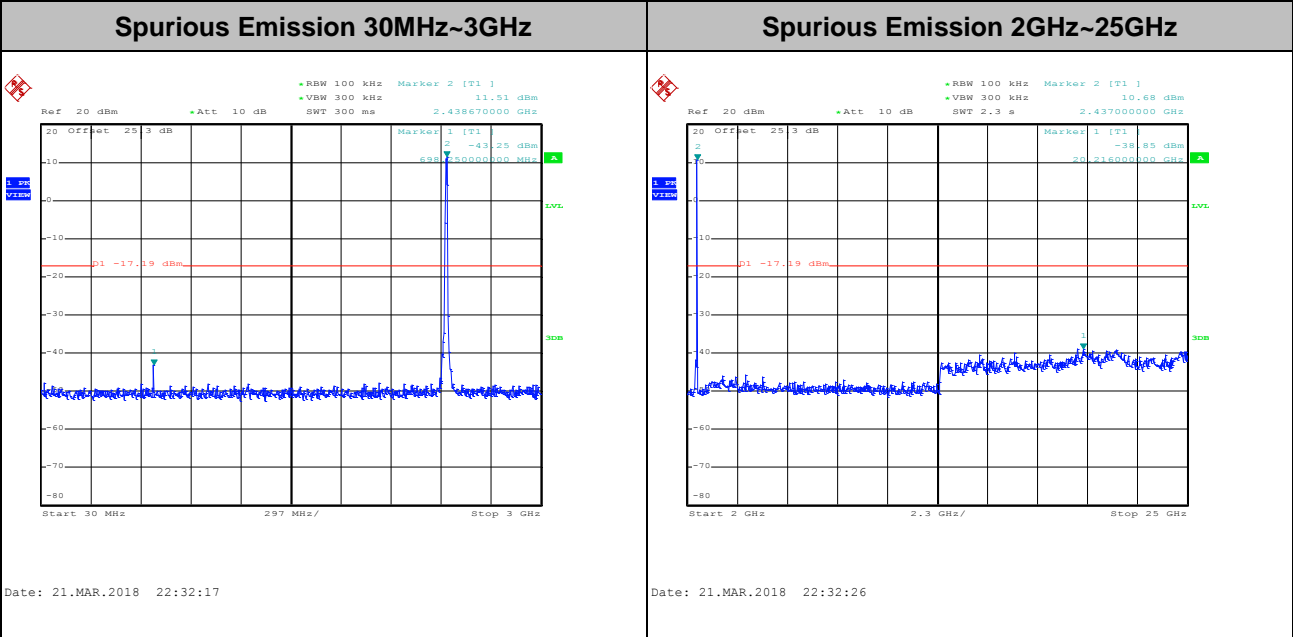
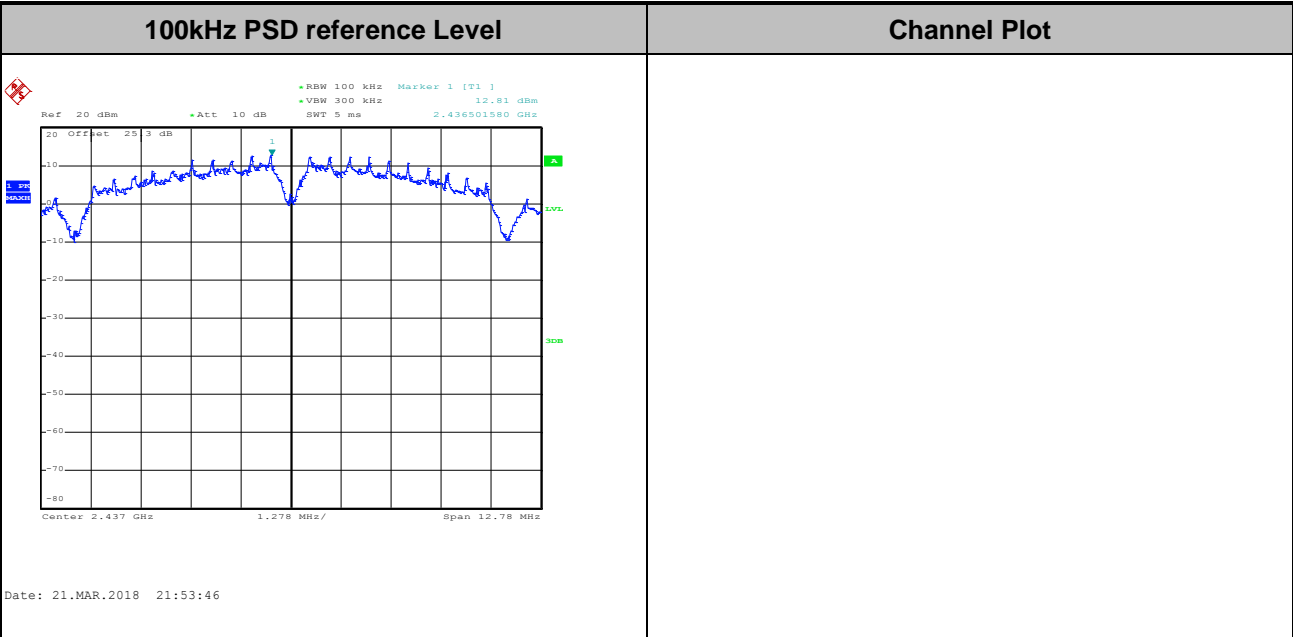



Test Mode :	802.11b	Test Channel :	11
-------------	---------	----------------	----

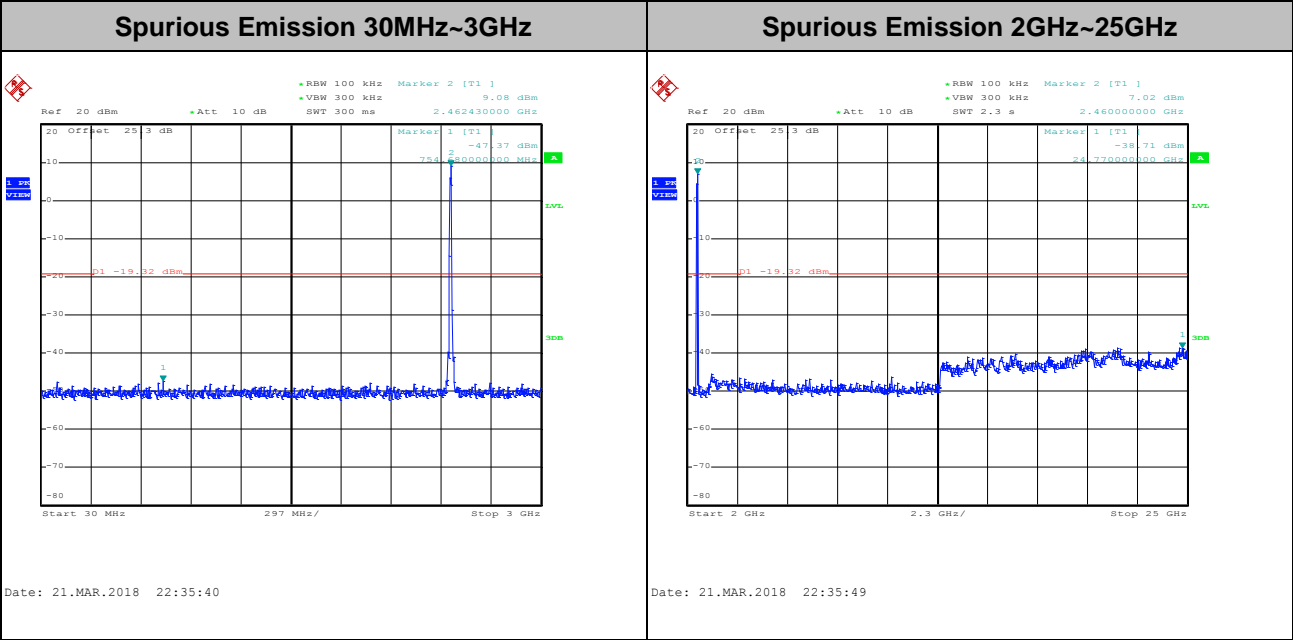
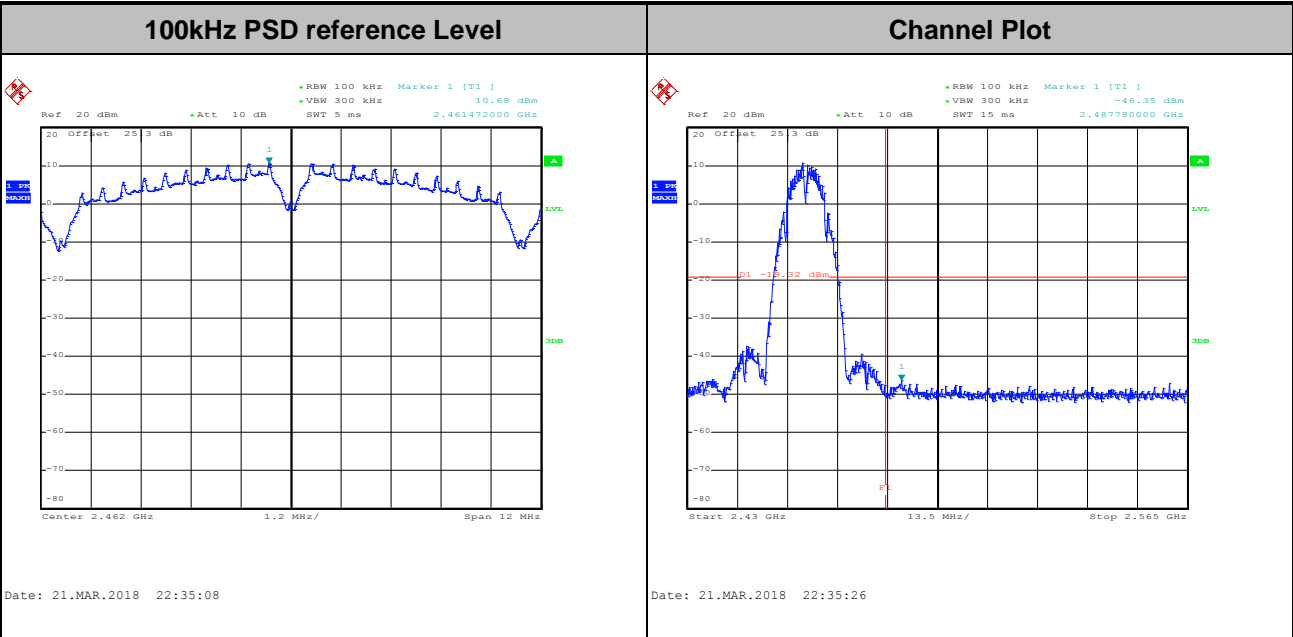



Test Mode :	802.11g	Test Channel :	01
-------------	---------	----------------	----

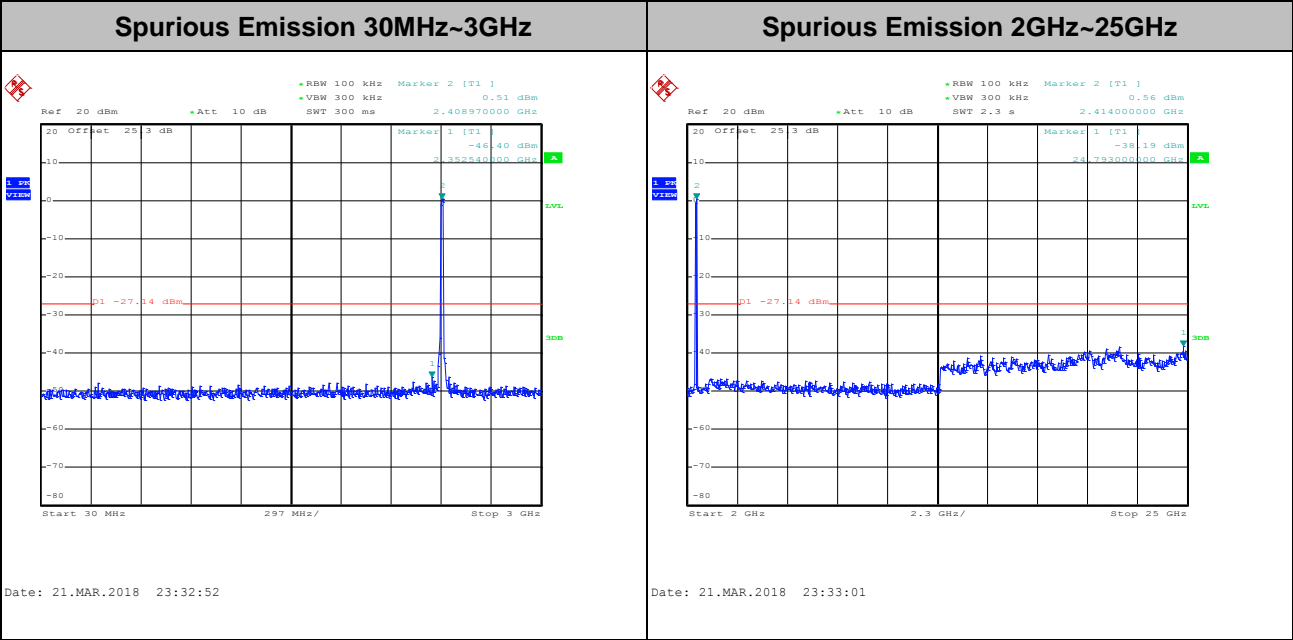
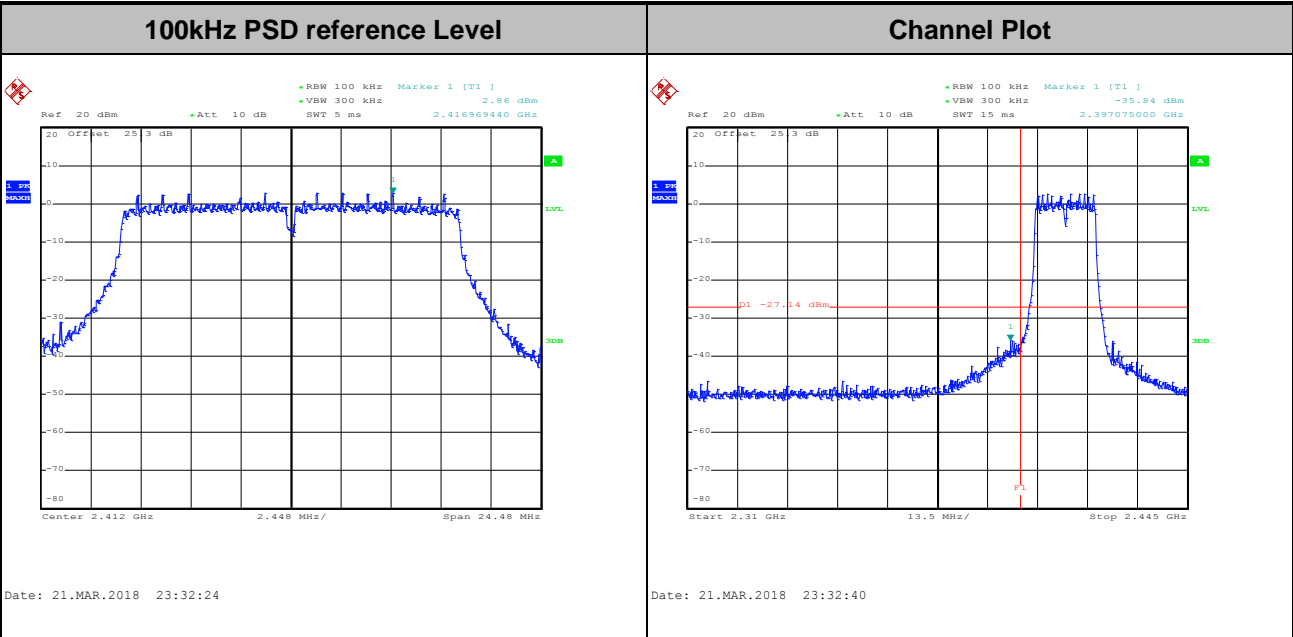



Test Mode :	802.11g	Test Channel :	06
-------------	---------	----------------	----

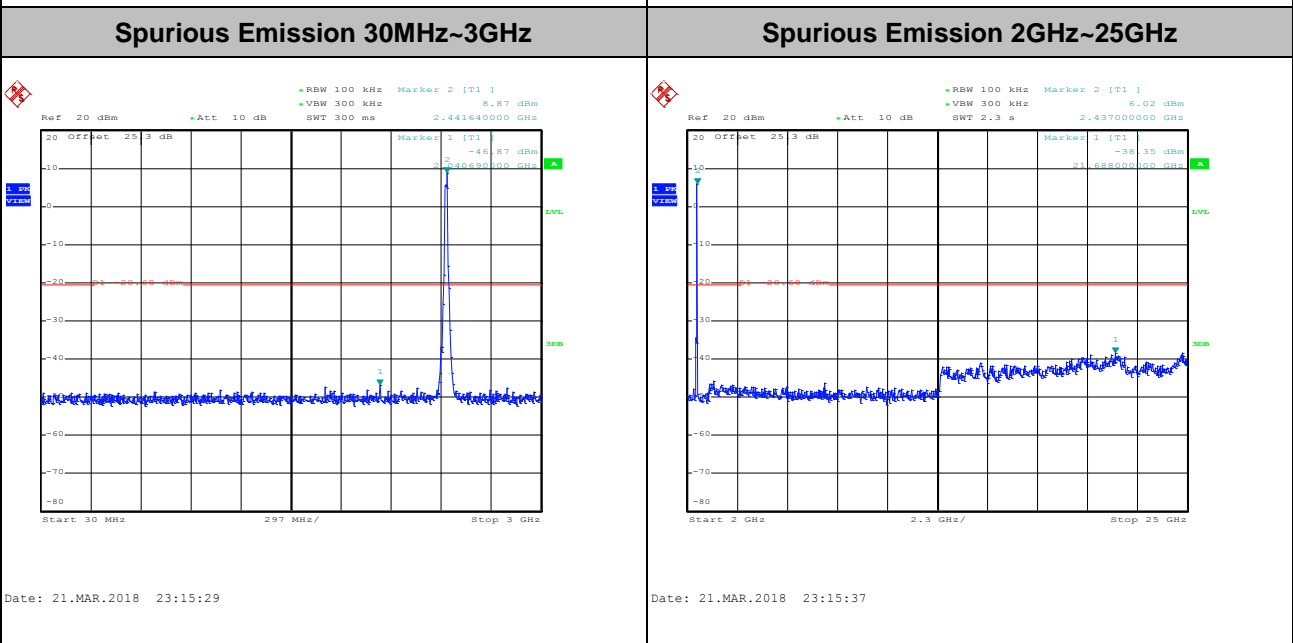
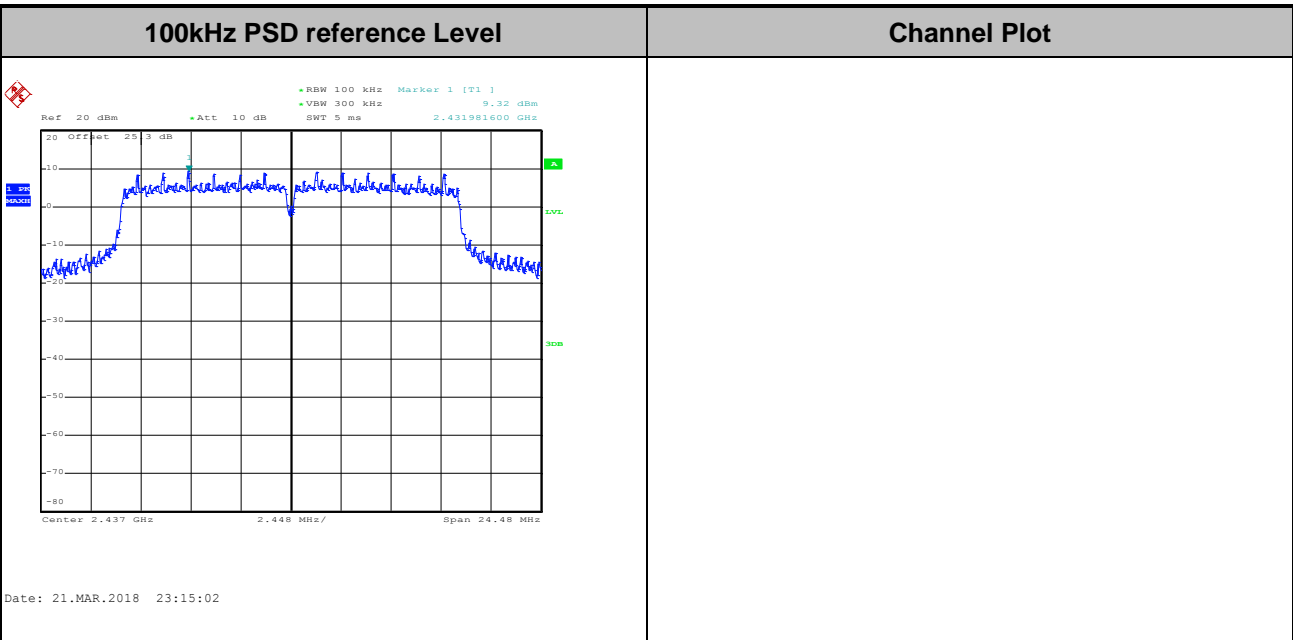



Test Mode :	802.11g	Test Channel :	11
-------------	---------	----------------	----

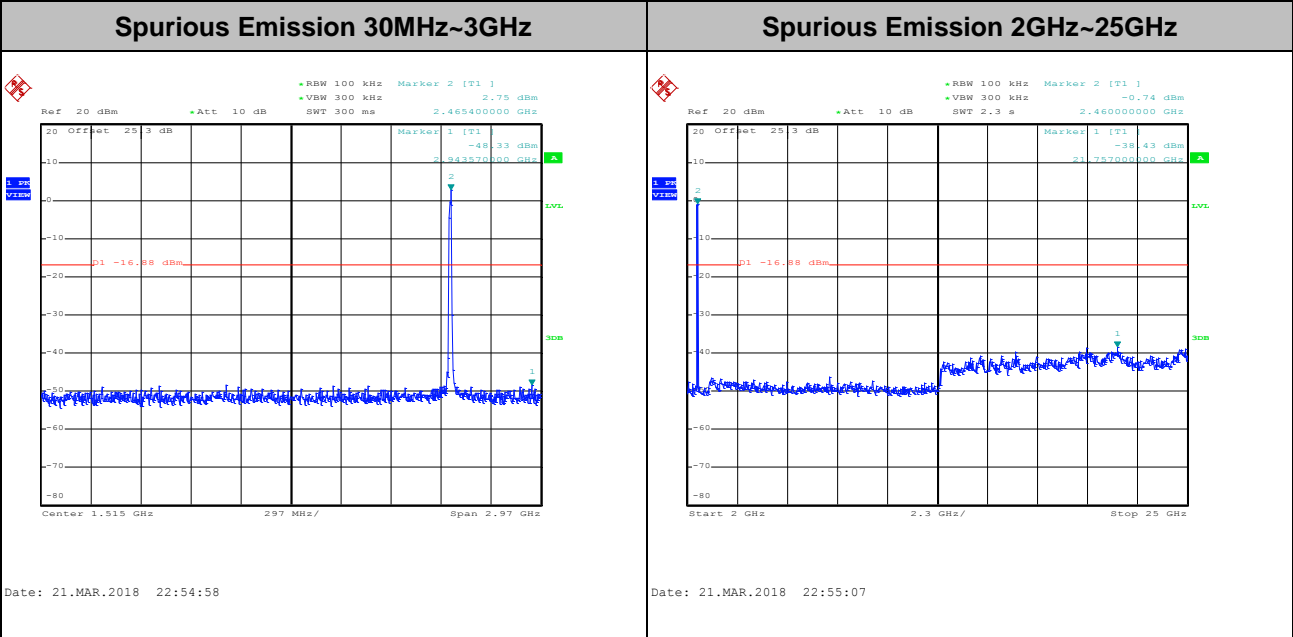
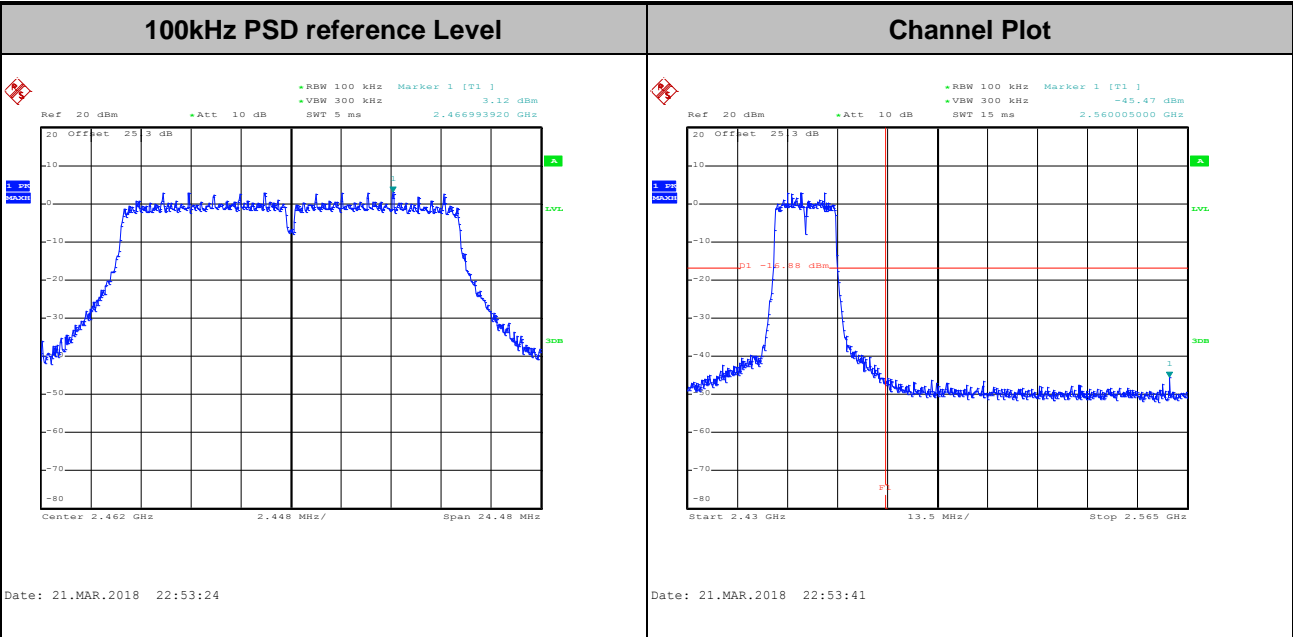



Test Mode : 802.11ac VHT20 Test Channel : 01

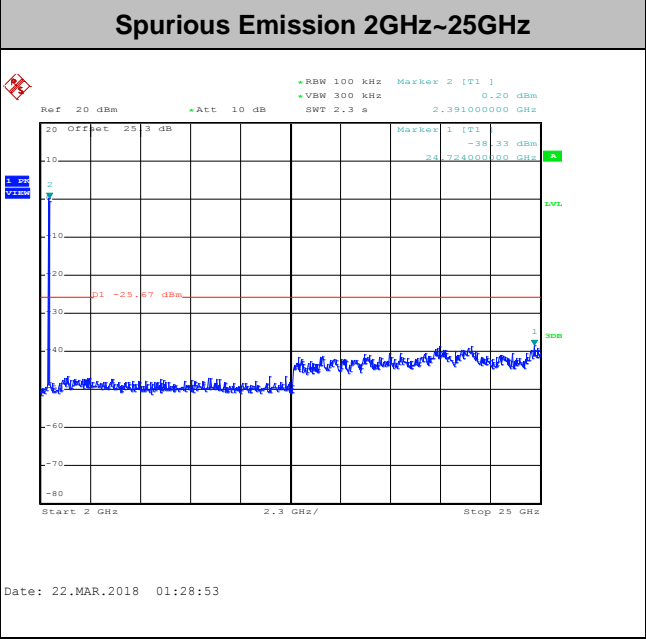
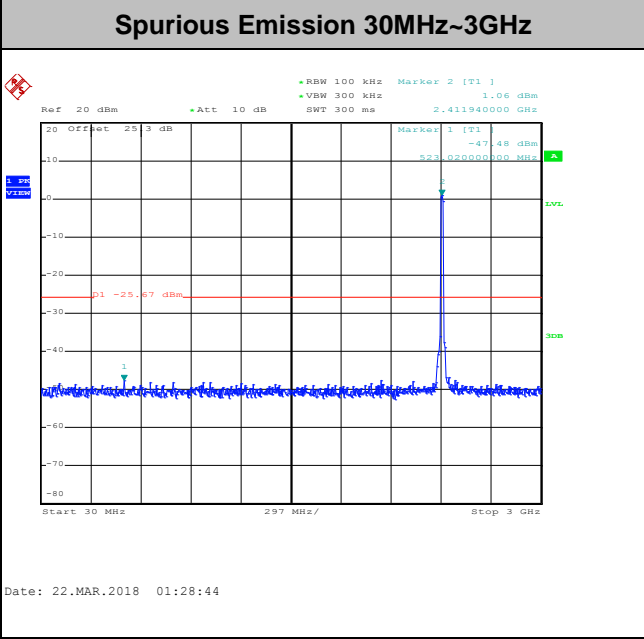
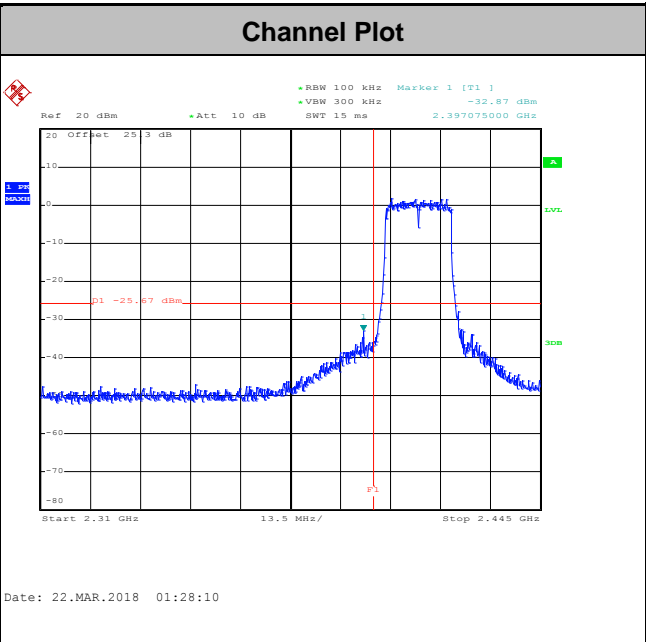
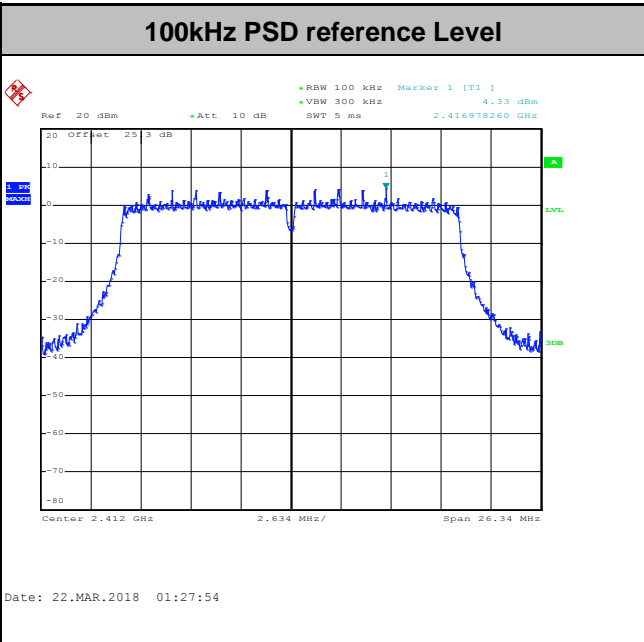



Test Mode :	802.11ac VHT20	Test Channel :	06
-------------	----------------	----------------	----

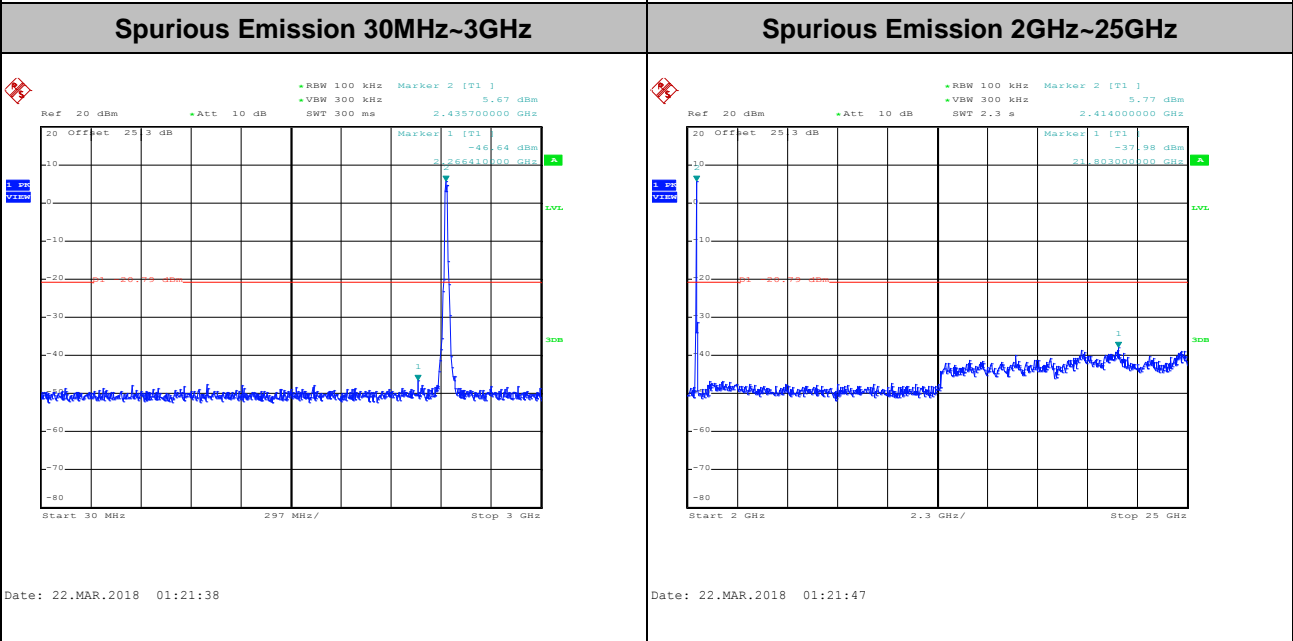
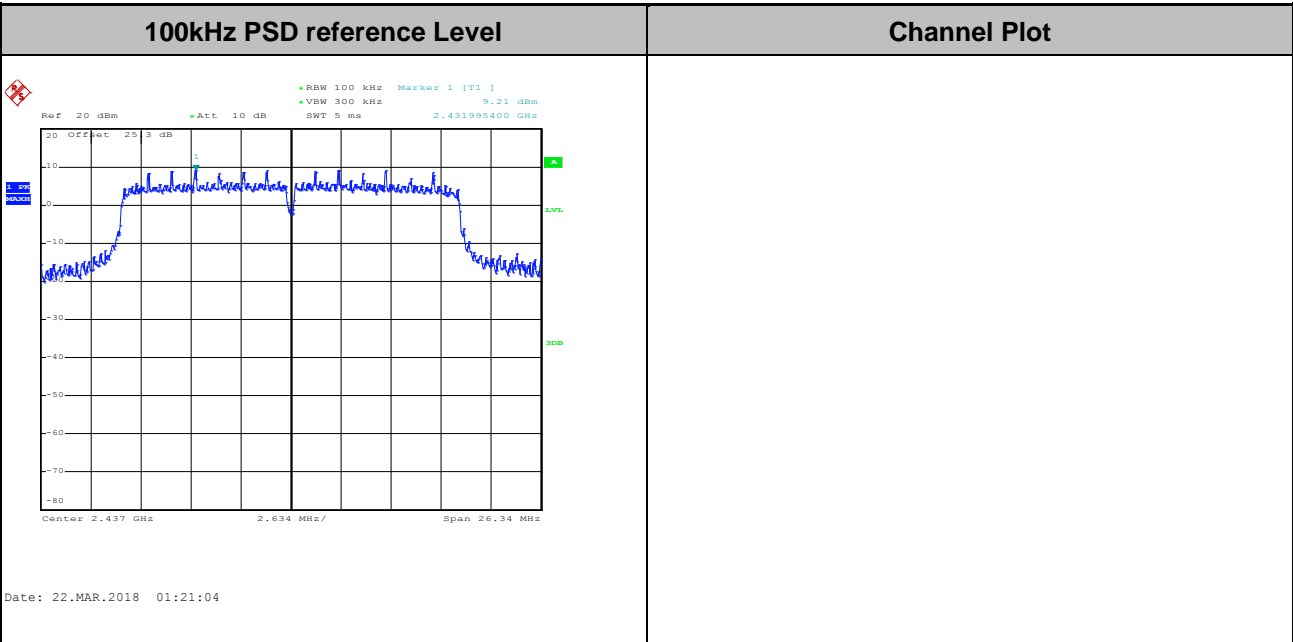



Test Mode : 802.11ac VHT20 Test Channel : 11

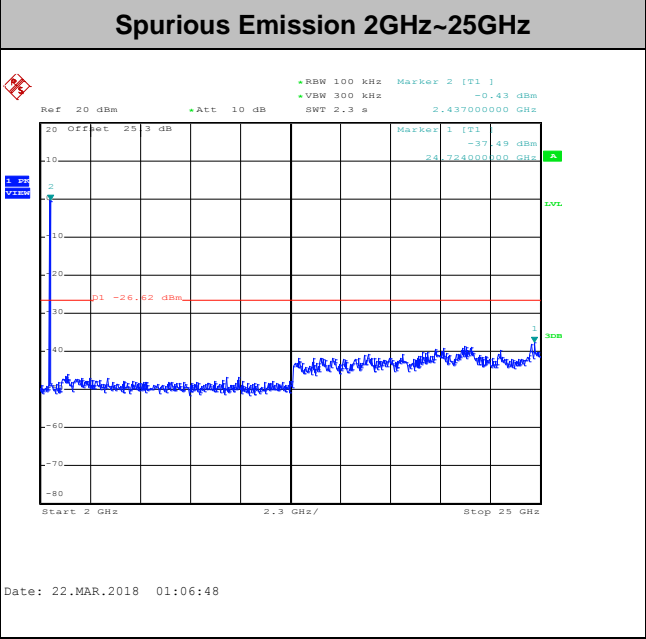
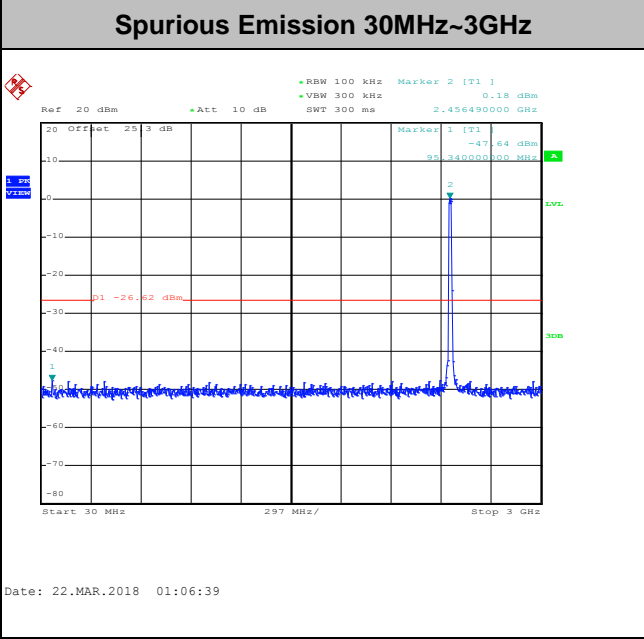
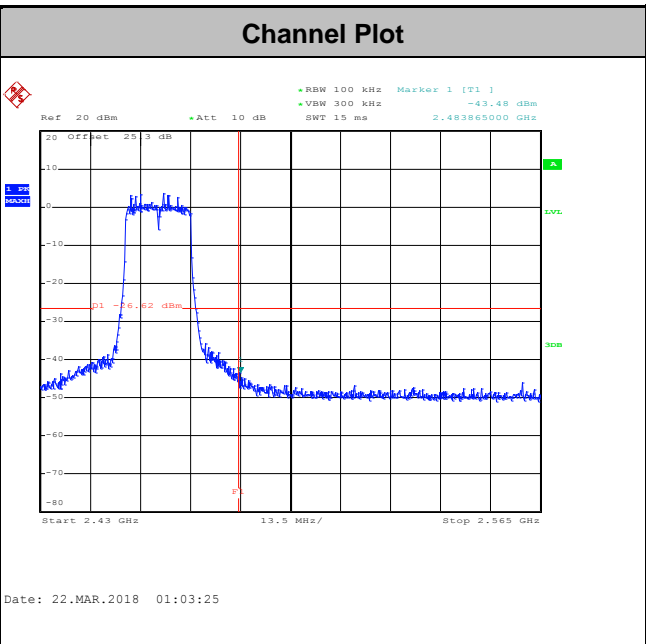
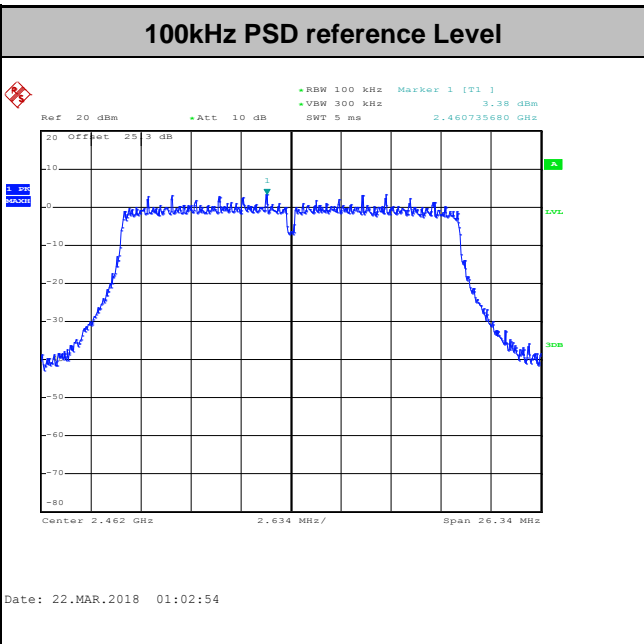



Test Mode :	802.11ac VHT40	Test Channel :	03
-------------	----------------	----------------	----

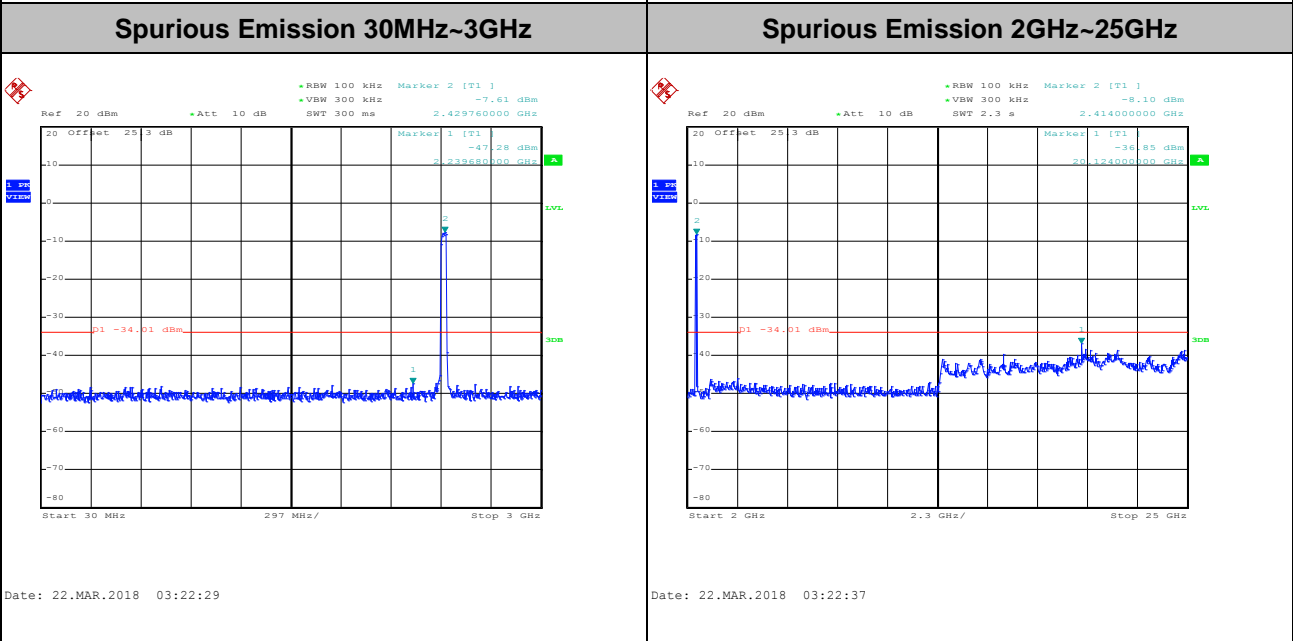
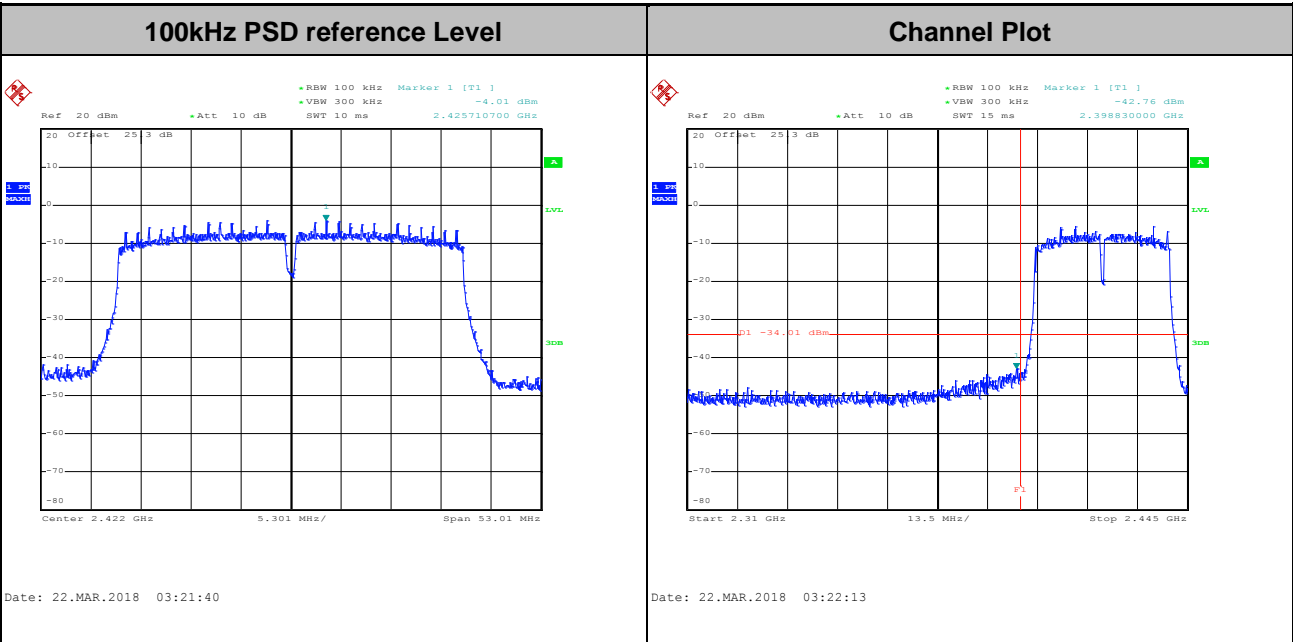



Test Mode :	802.11ac VHT40	Test Channel :	06
-------------	----------------	----------------	----

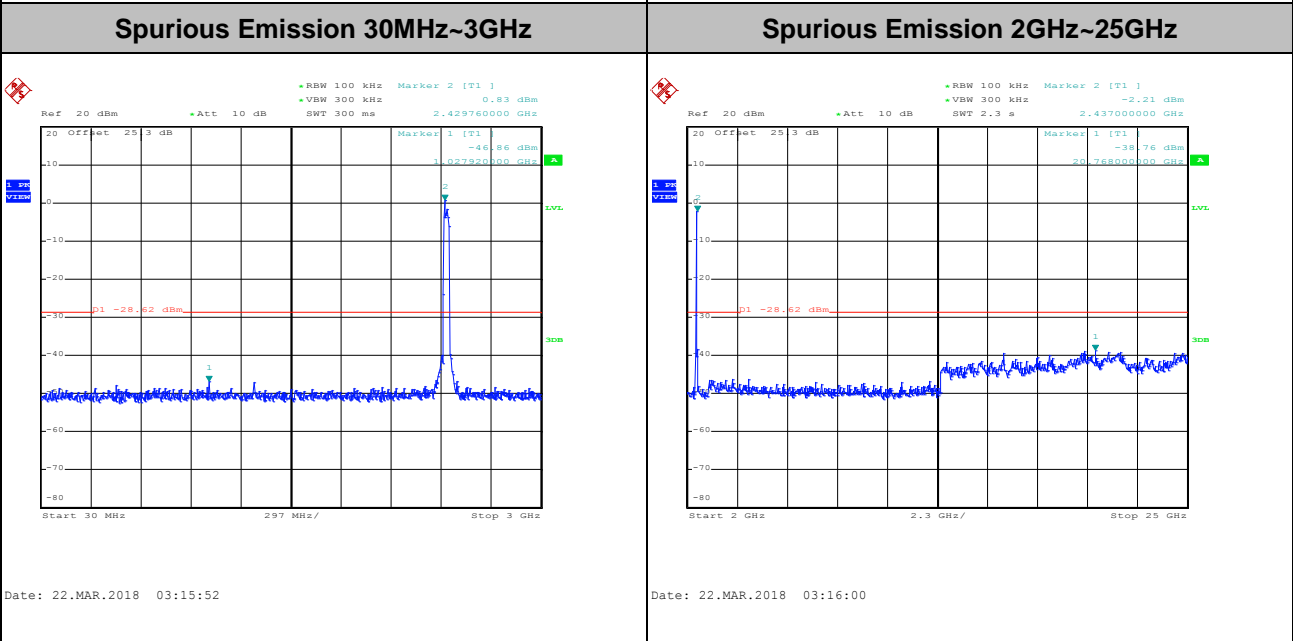
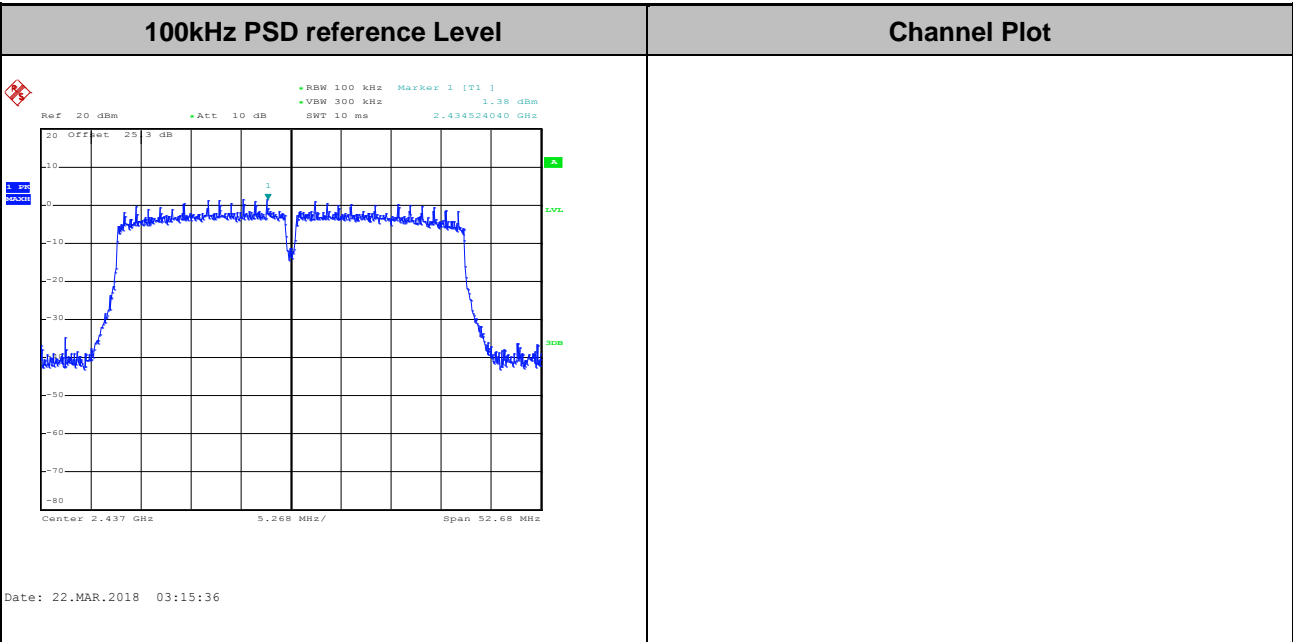



Test Mode : 802.11ac VHT40 Test Channel : 09

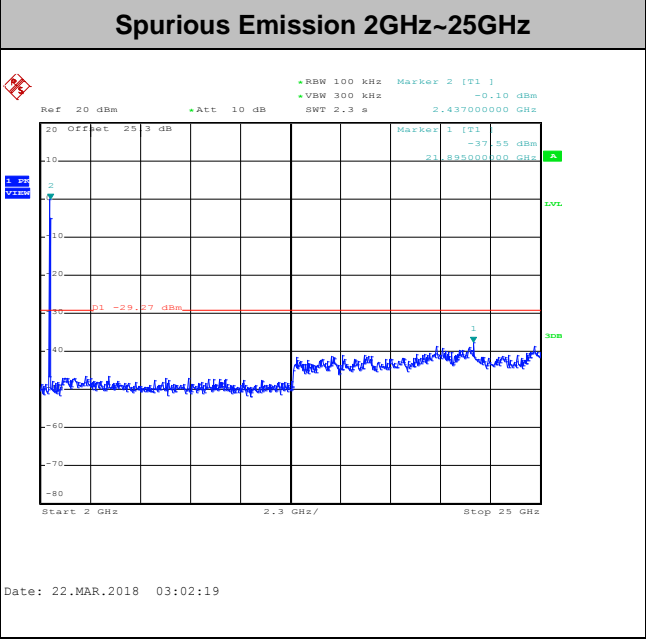
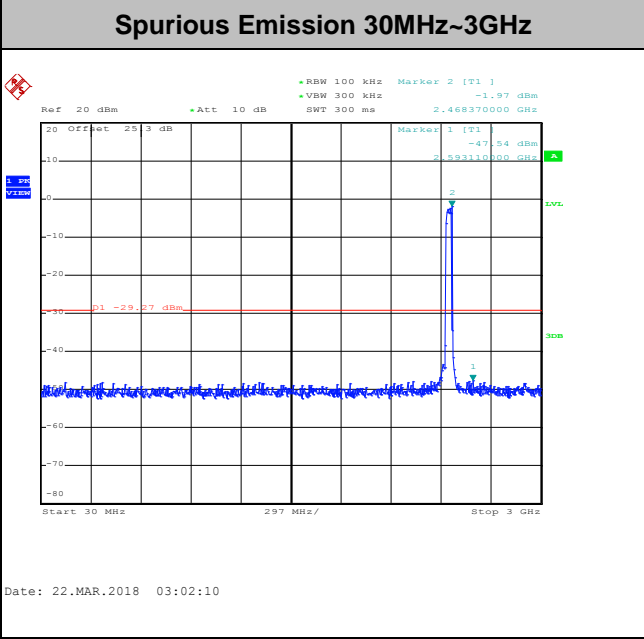
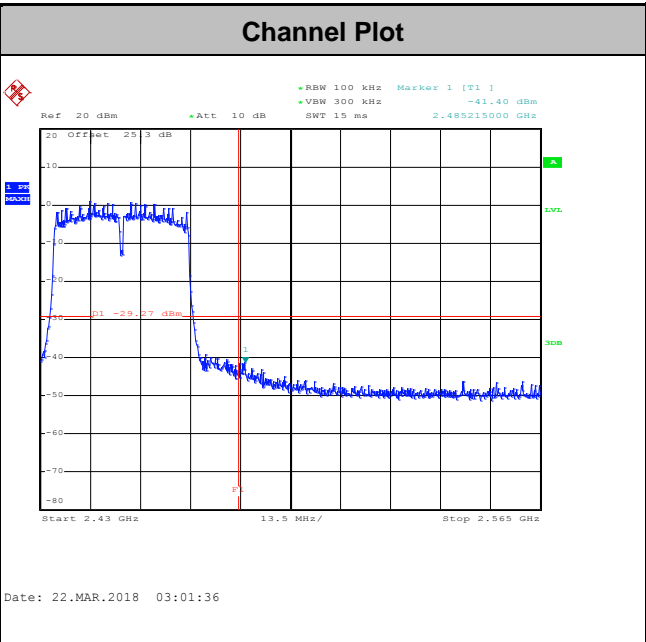
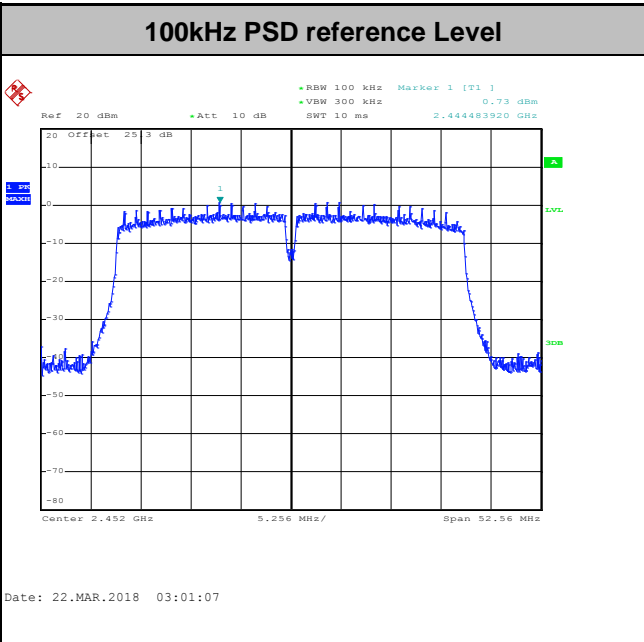



Test Mode :	802.11b	Test Channel :	06
-------------	---------	----------------	----

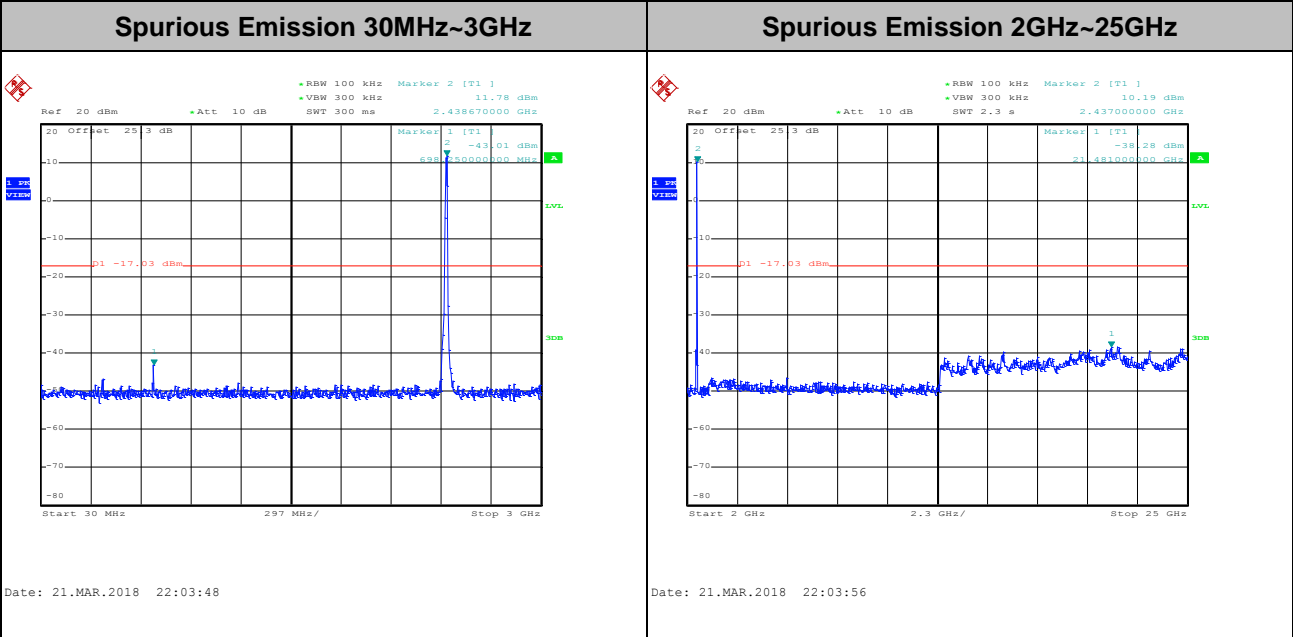
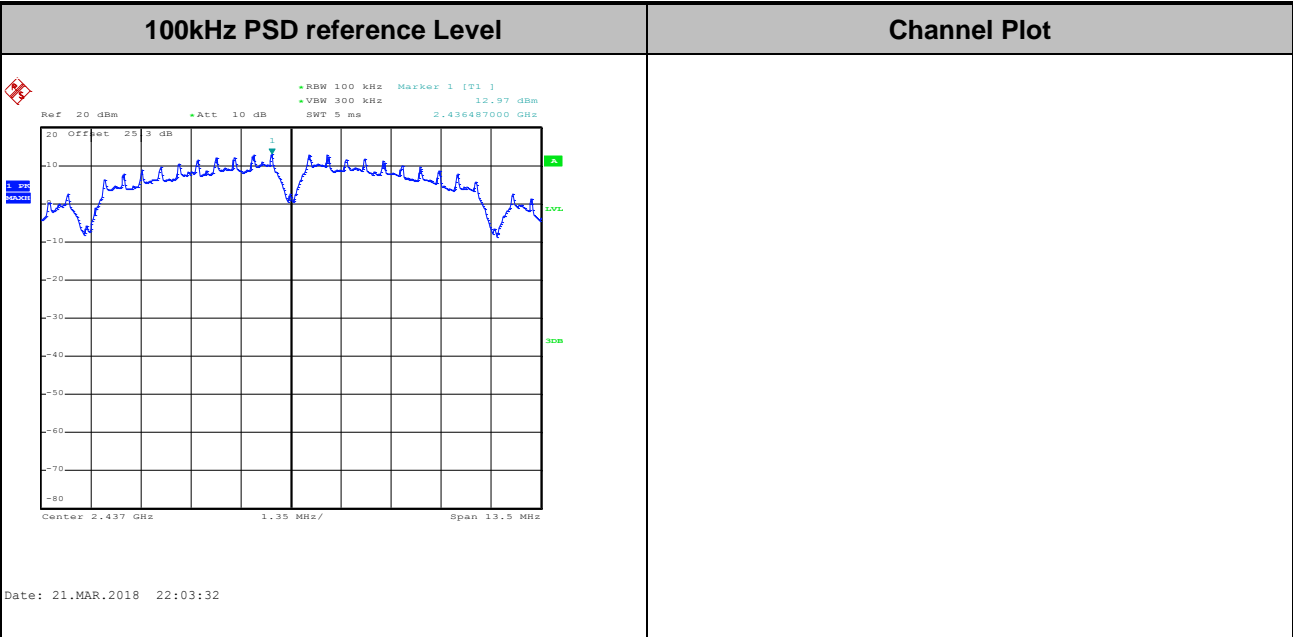



Test Mode :	802.11b	Test Channel :	11
-------------	---------	----------------	----

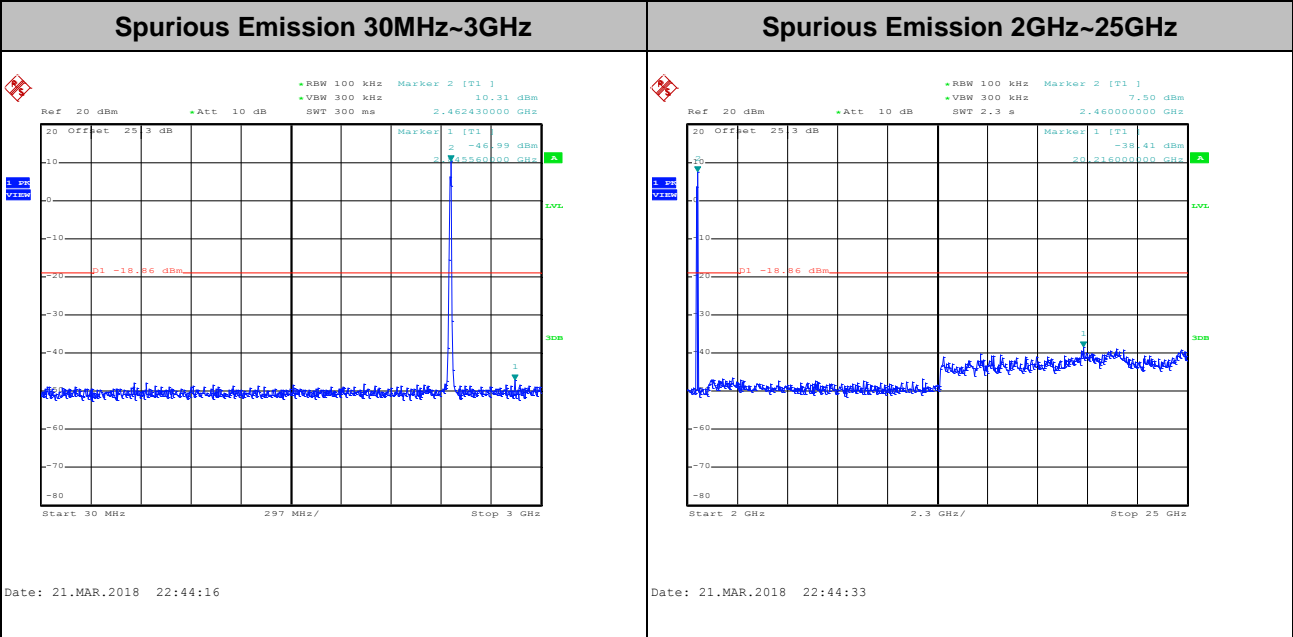
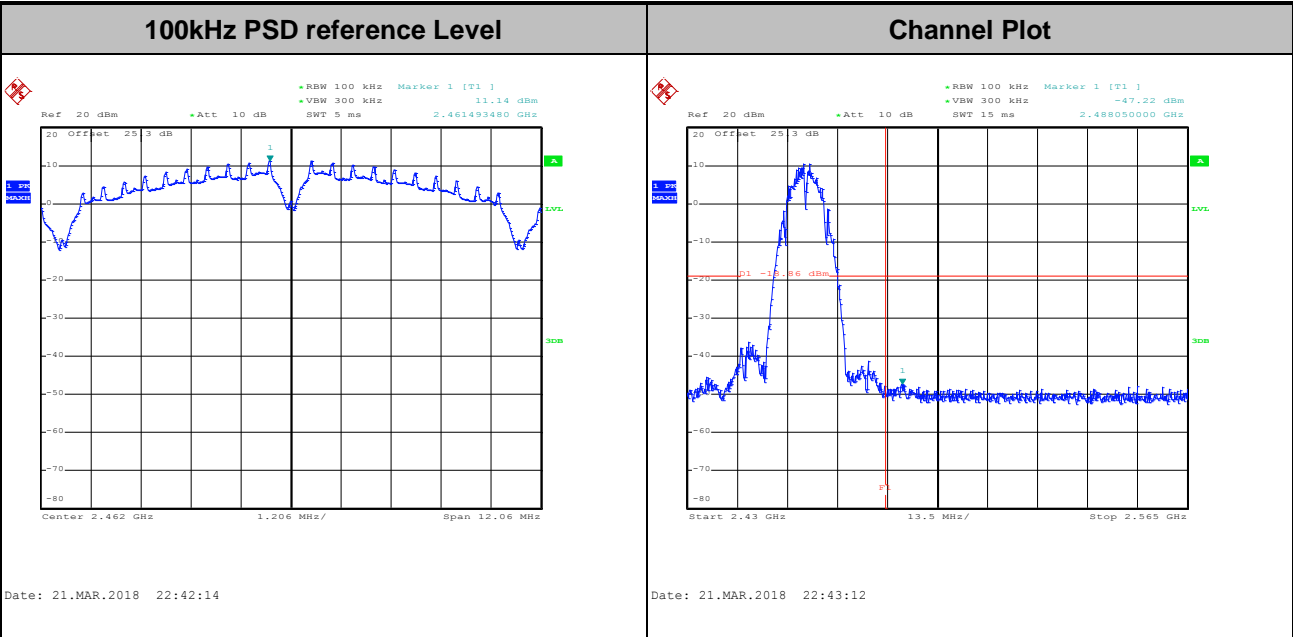



Test Mode :	802.11g	Test Channel :	01
-------------	---------	----------------	----

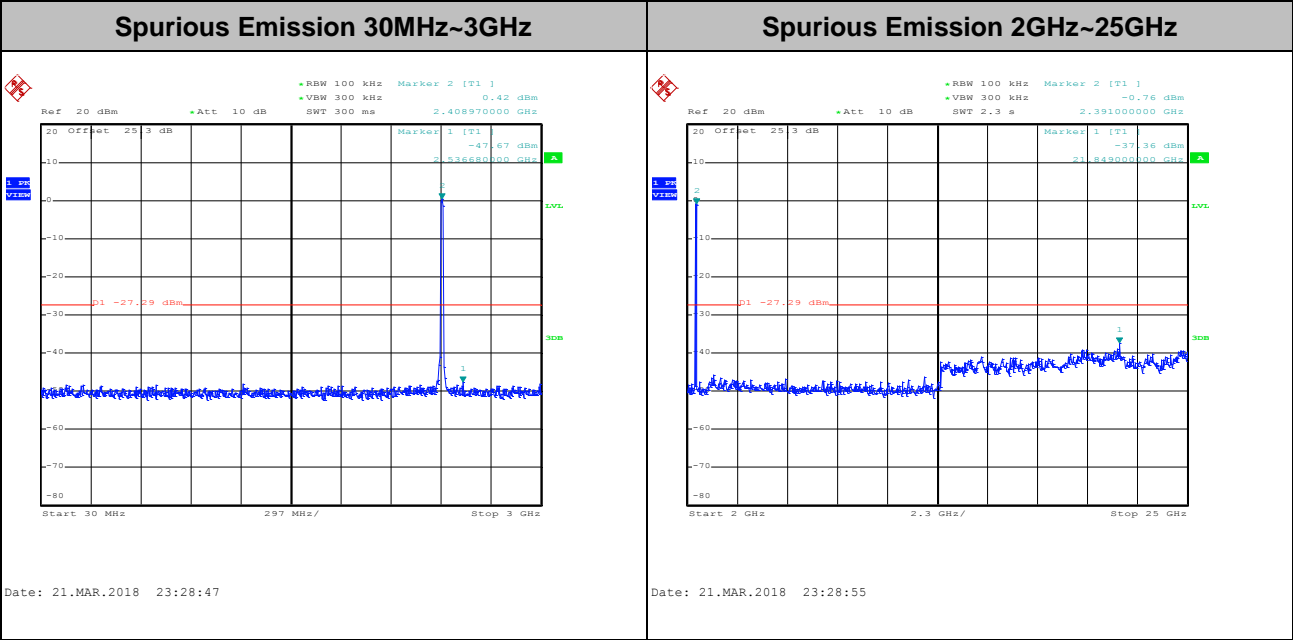
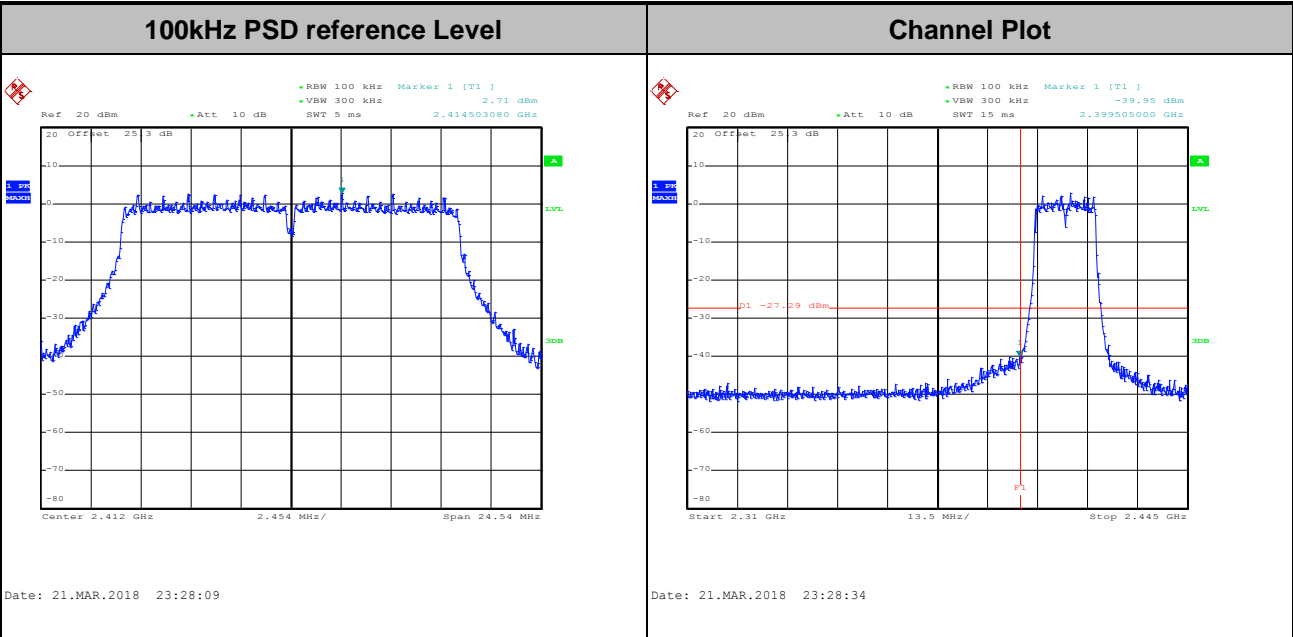



Test Mode :	802.11g	Test Channel :	06
-------------	---------	----------------	----

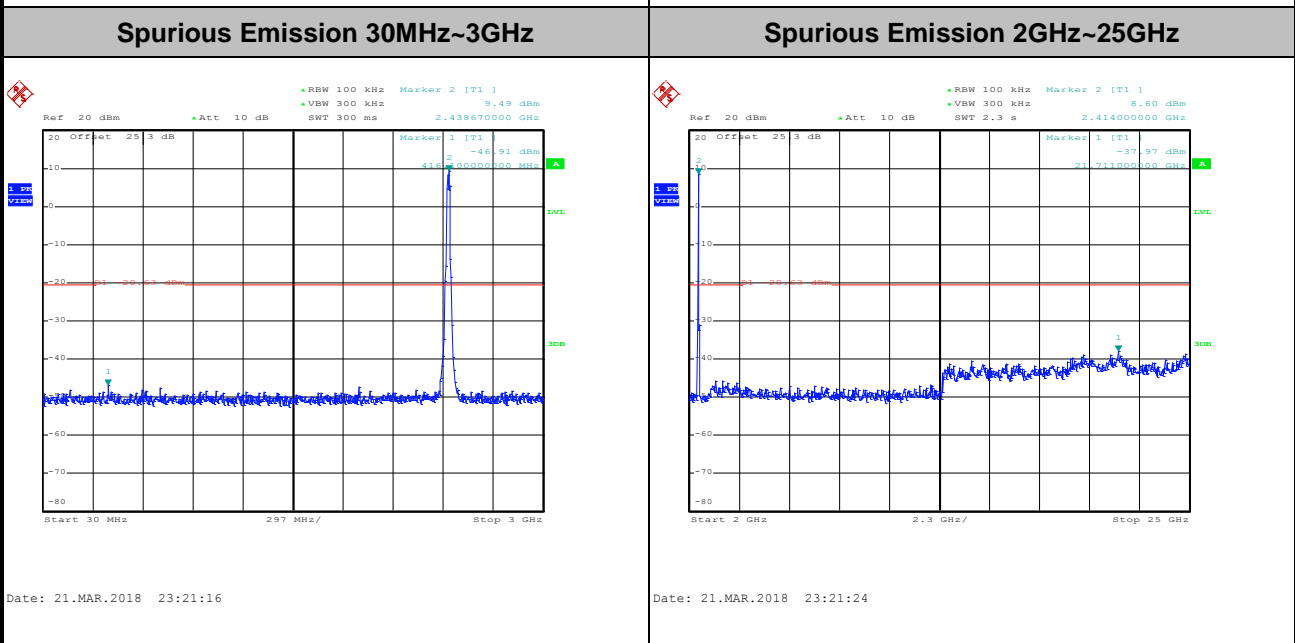
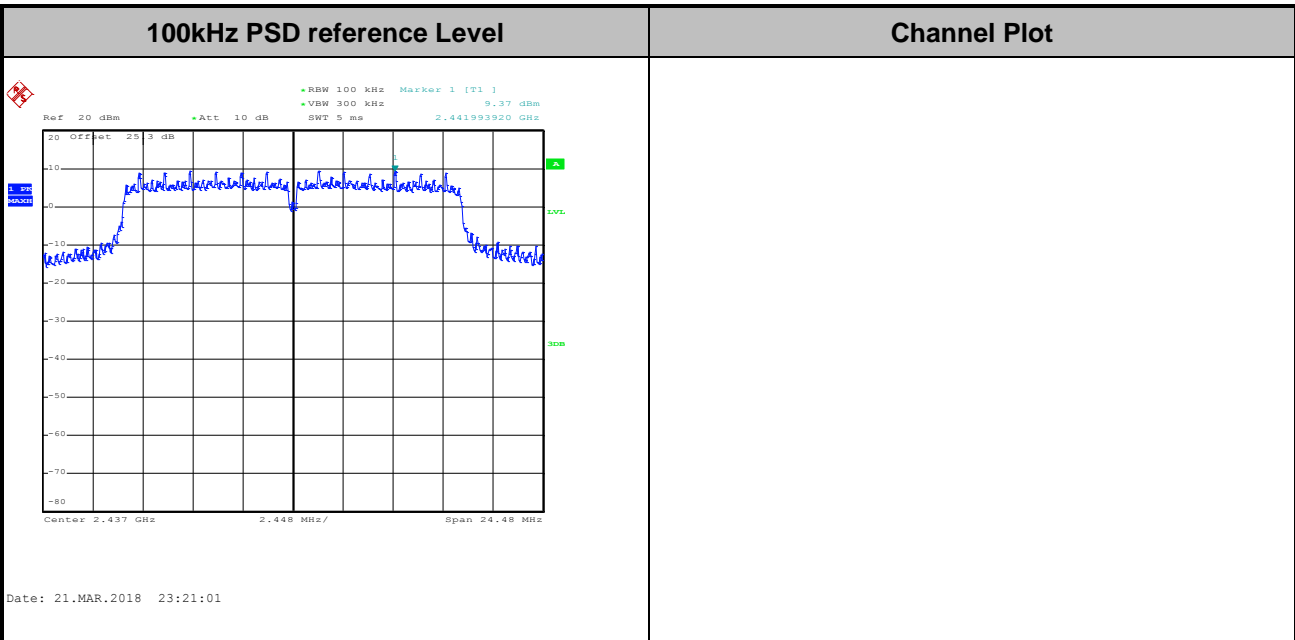



Test Mode :	802.11g	Test Channel :	11
-------------	---------	----------------	----

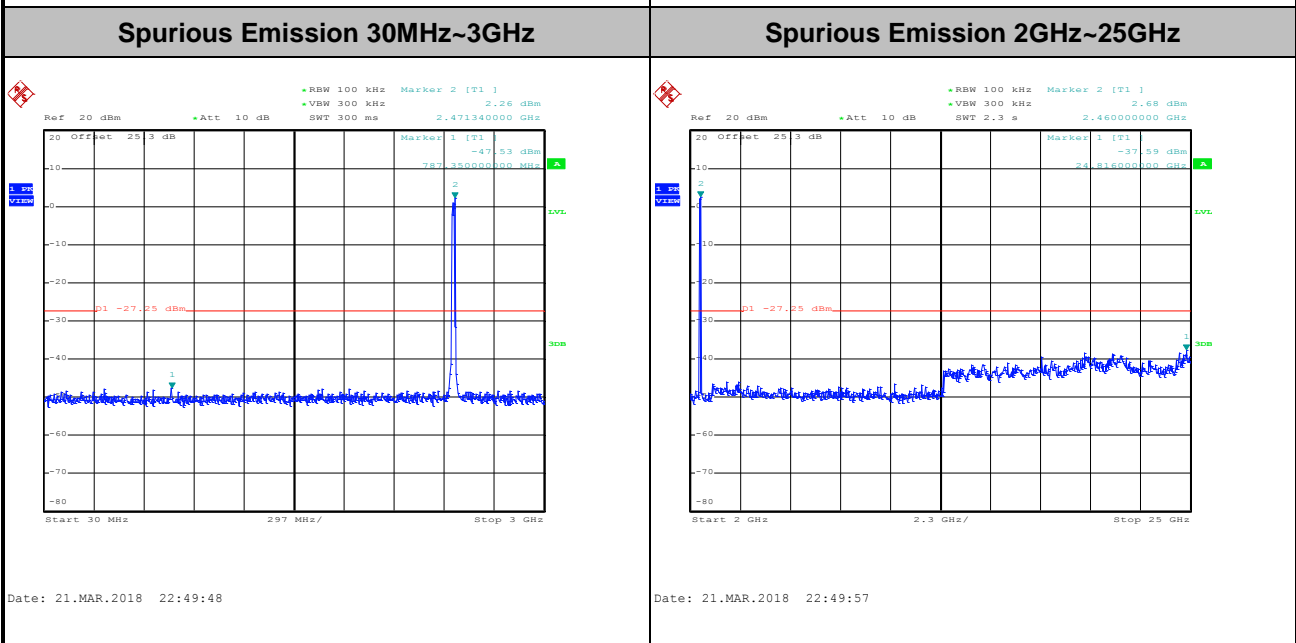
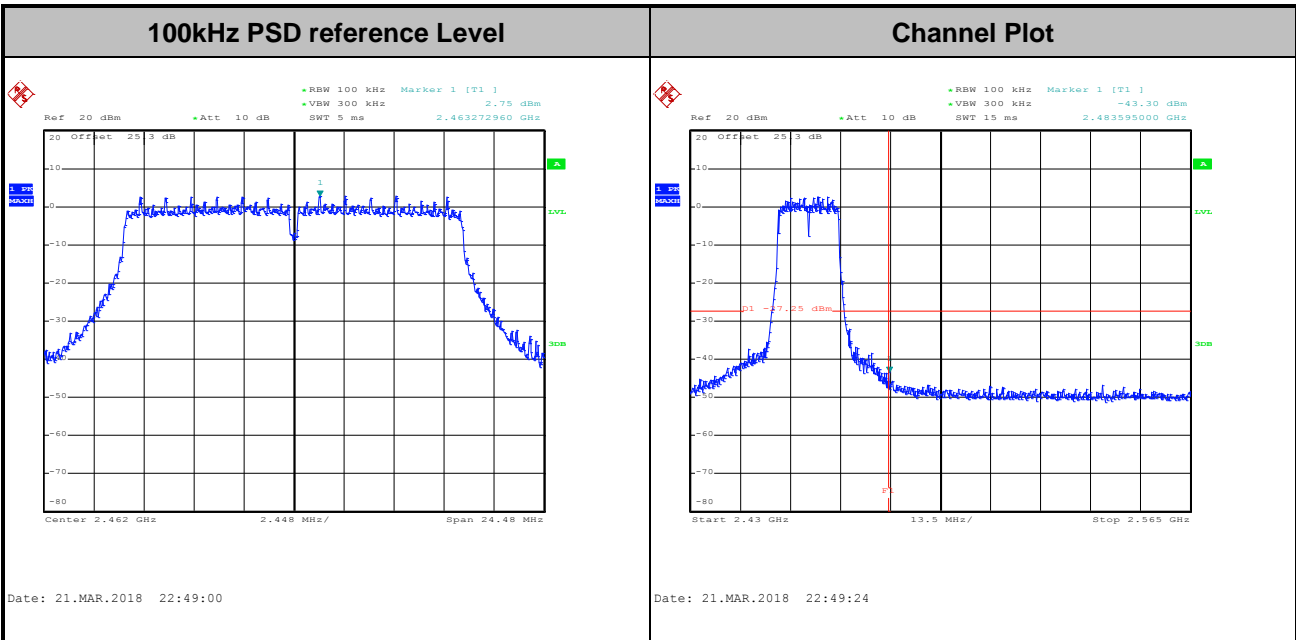



Test Mode : 802.11ac VHT20 Test Channel : 01

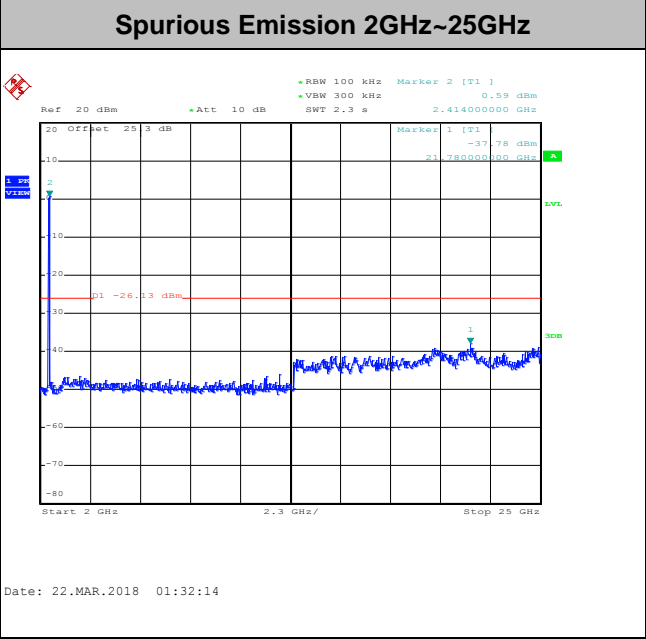
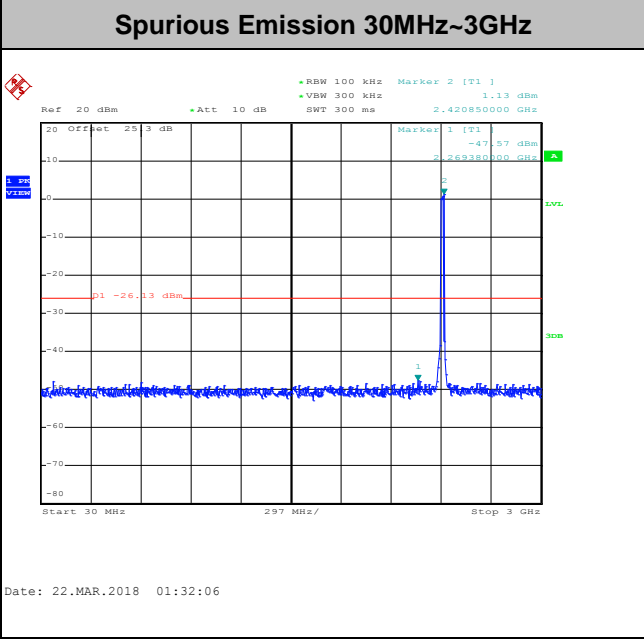
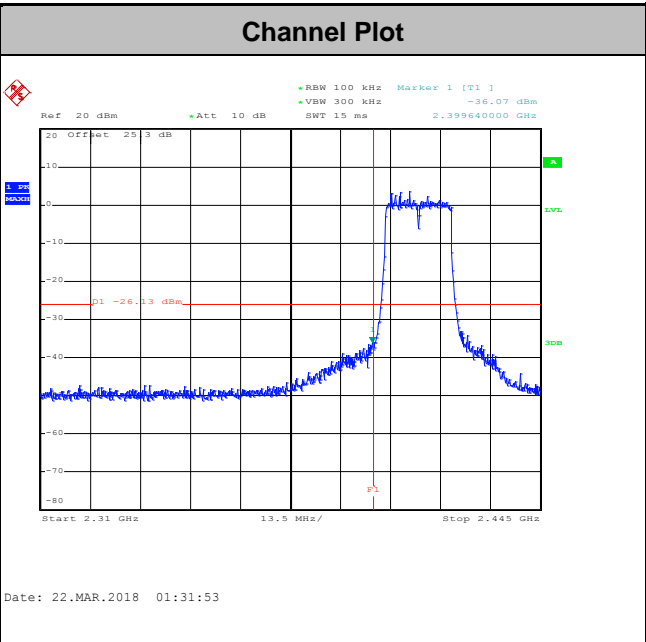
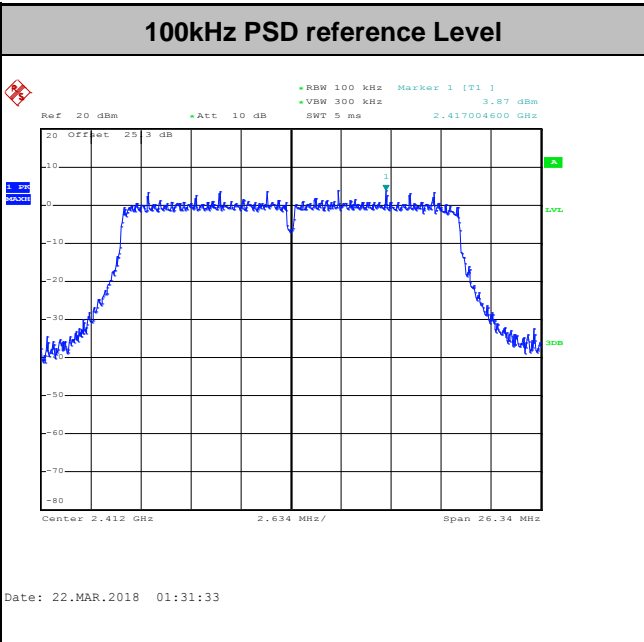



Test Mode :	802.11ac VHT20	Test Channel :	06
-------------	----------------	----------------	----

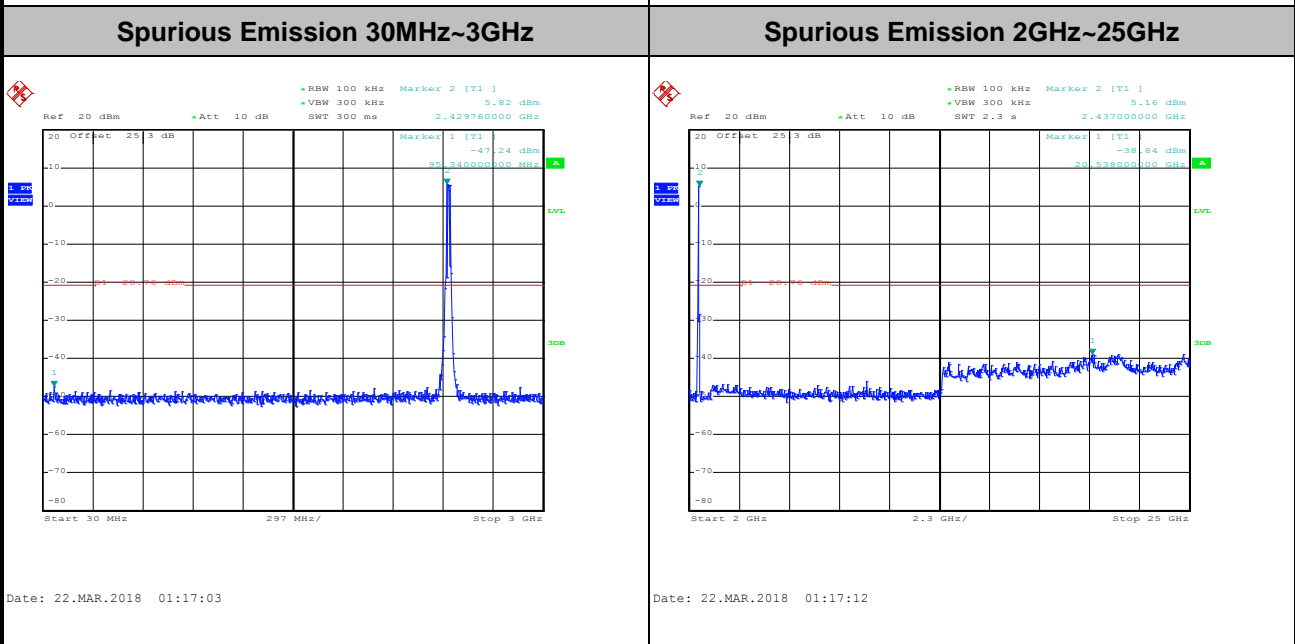
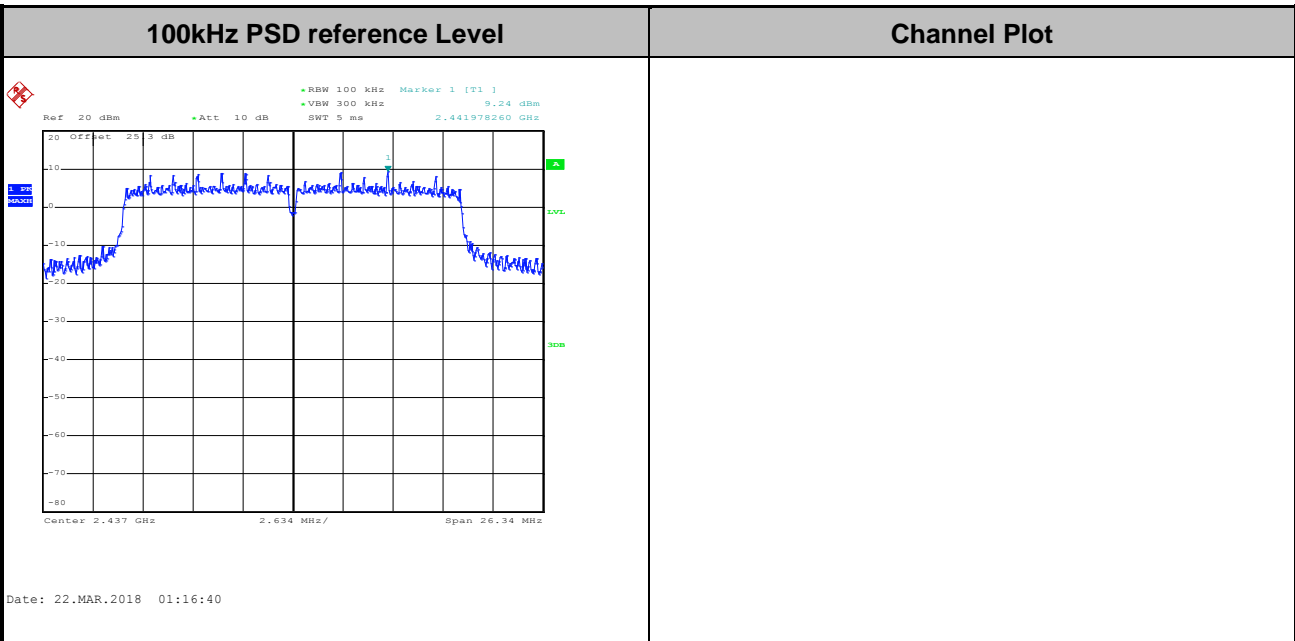



Test Mode :	802.11ac VHT20	Test Channel :	11
-------------	----------------	----------------	----

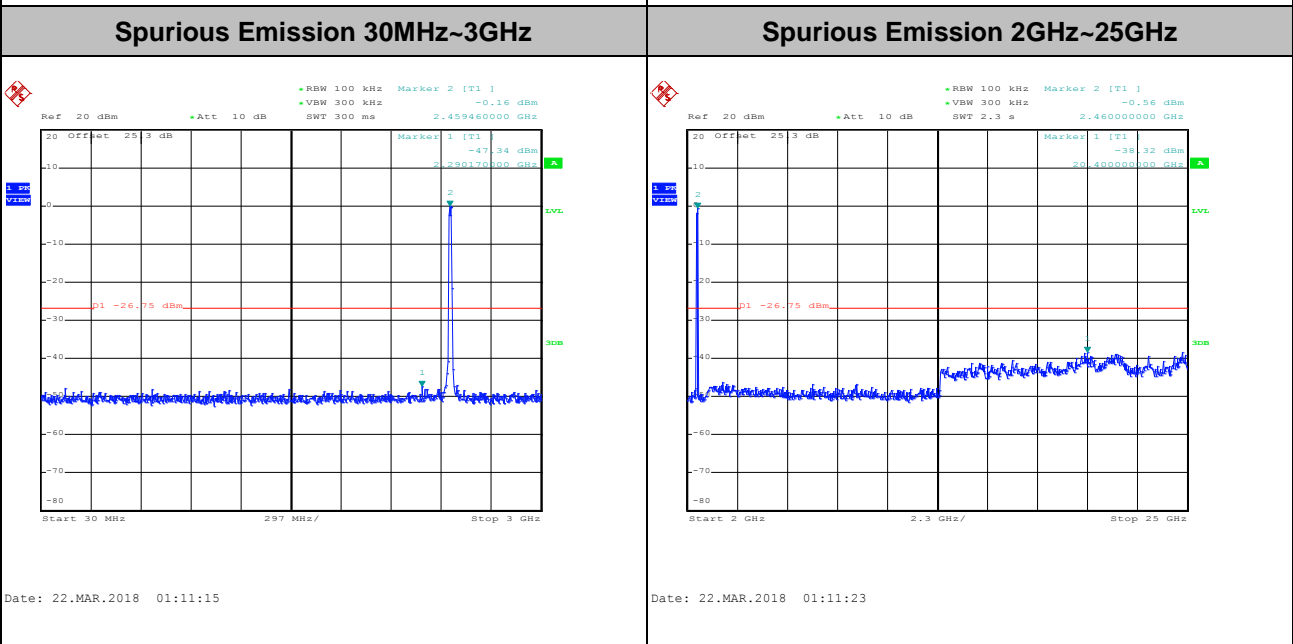
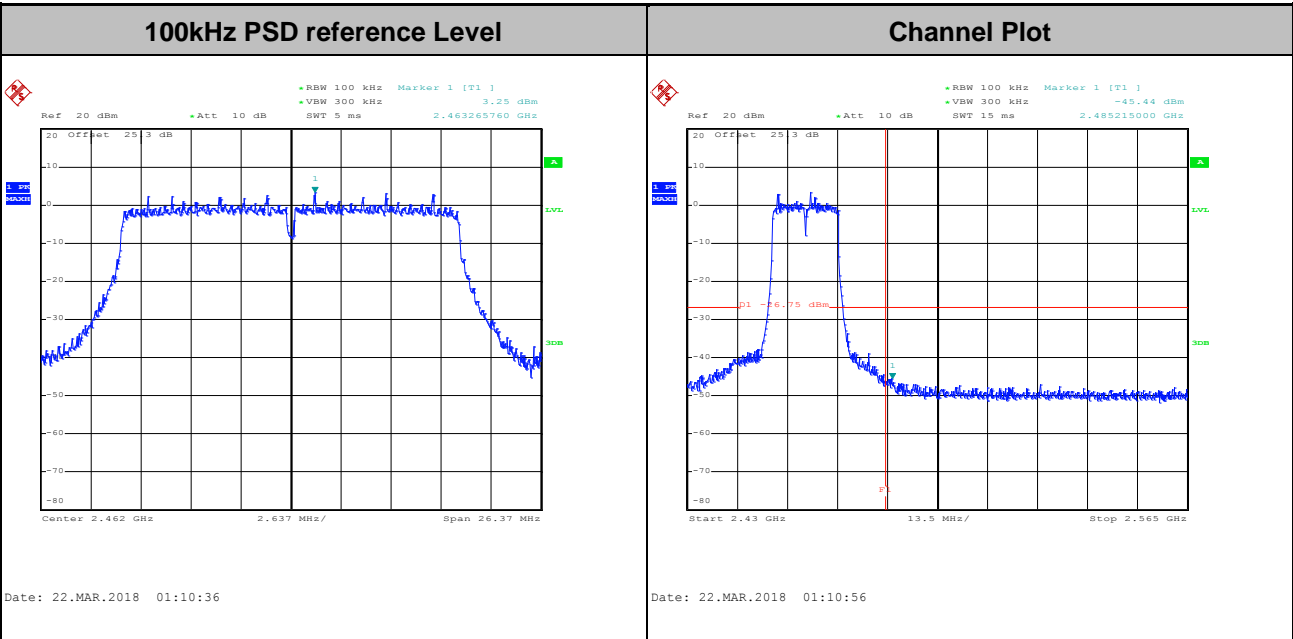



Test Mode : 802.11ac VHT40 Test Channel : 03

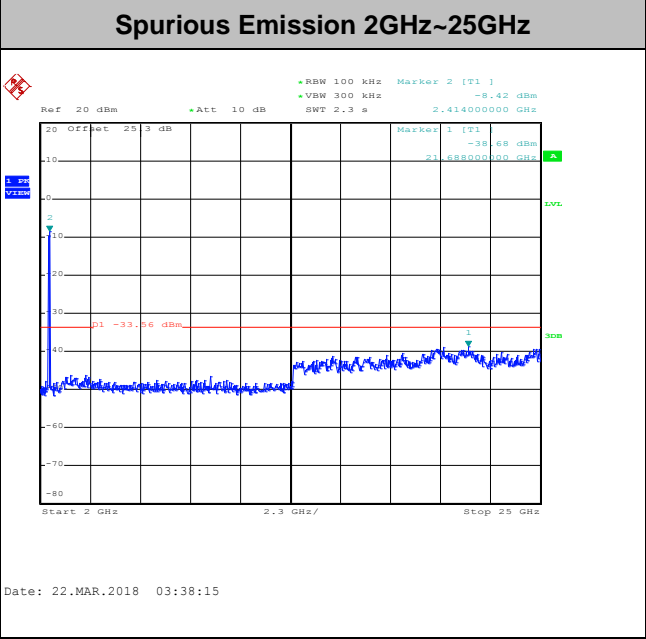
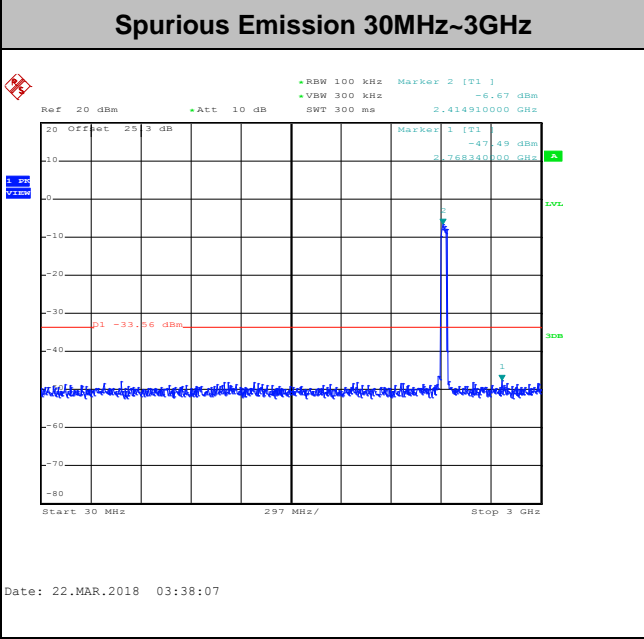
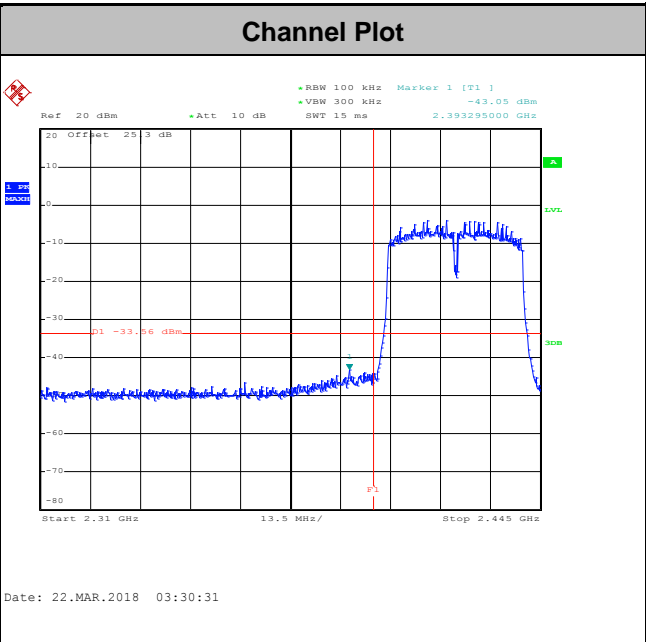
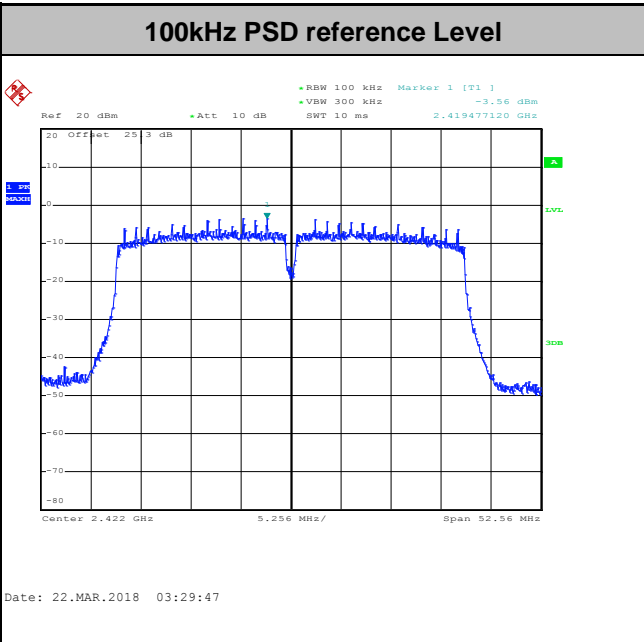



Test Mode :	802.11ac VHT40	Test Channel :	06
-------------	----------------	----------------	----

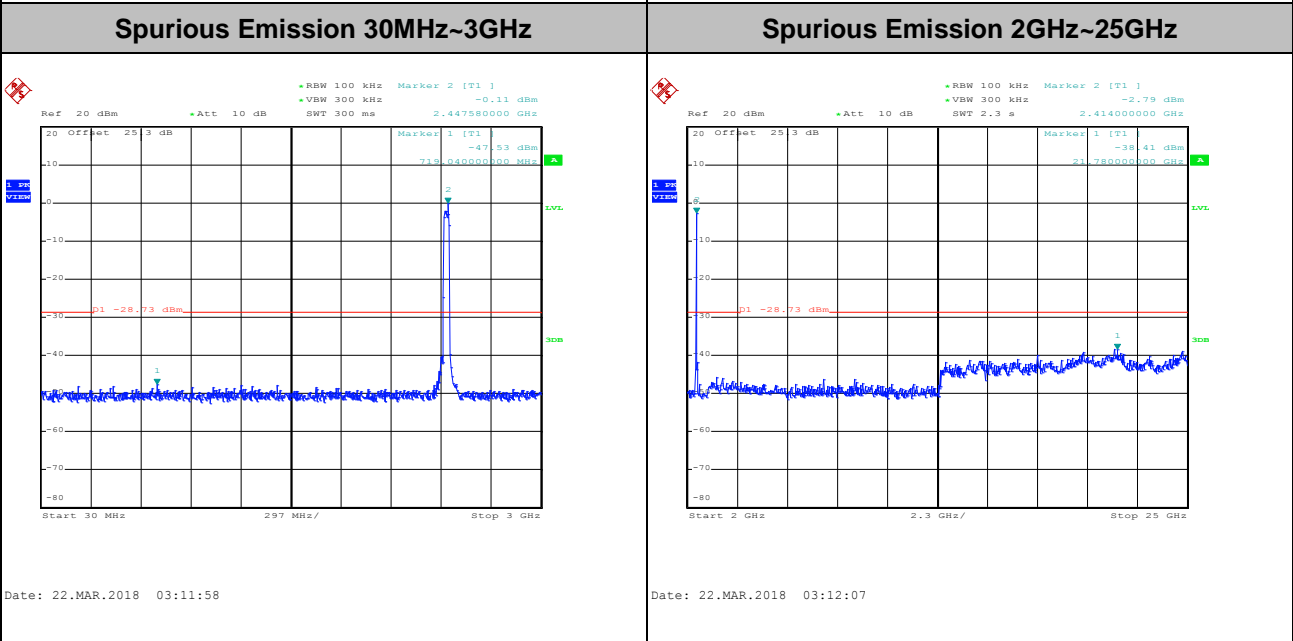
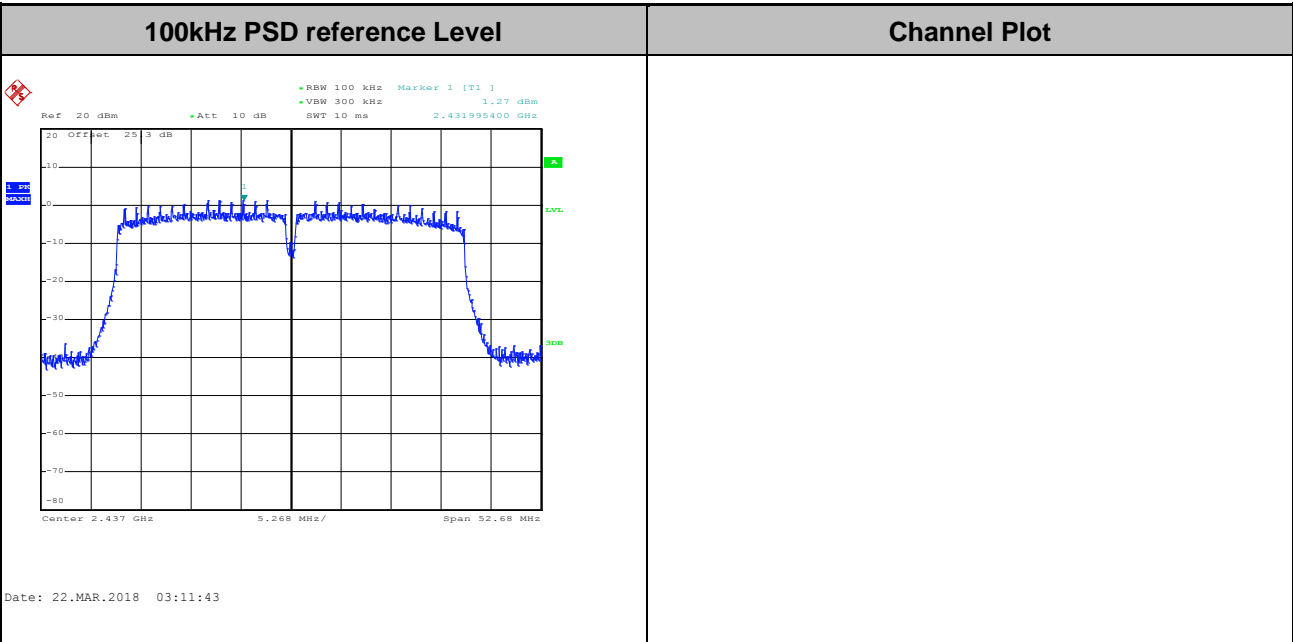



Test Mode :	802.11ac VHT40	Test Channel :	09
-------------	----------------	----------------	----

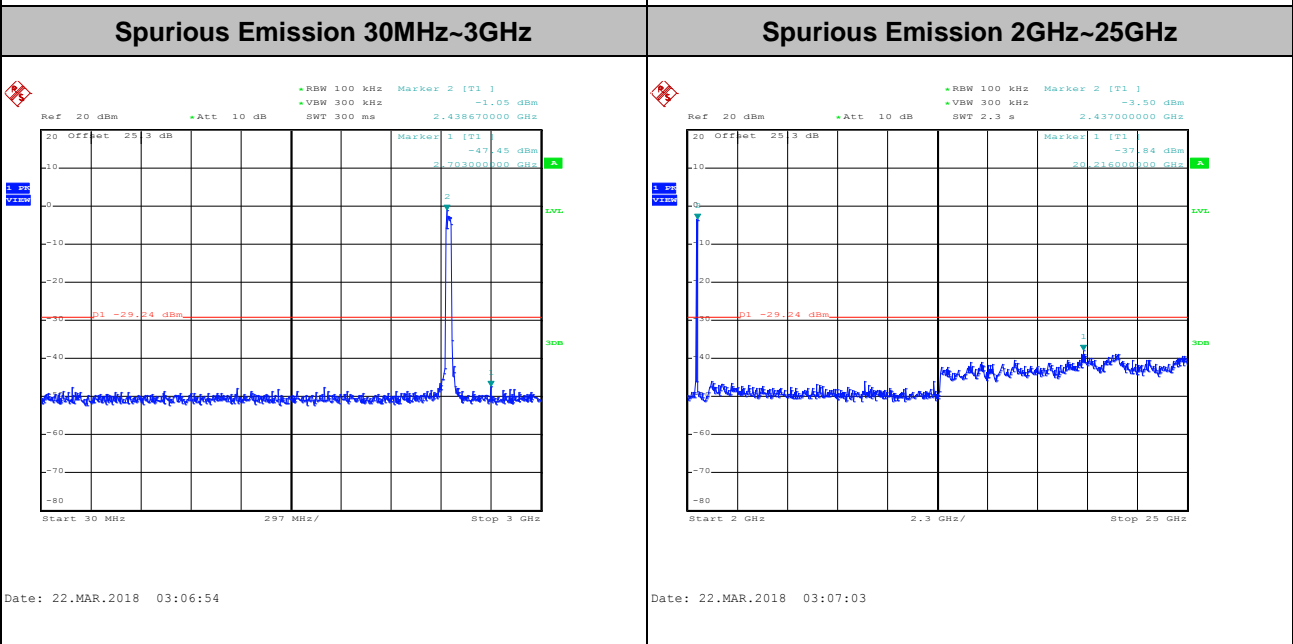
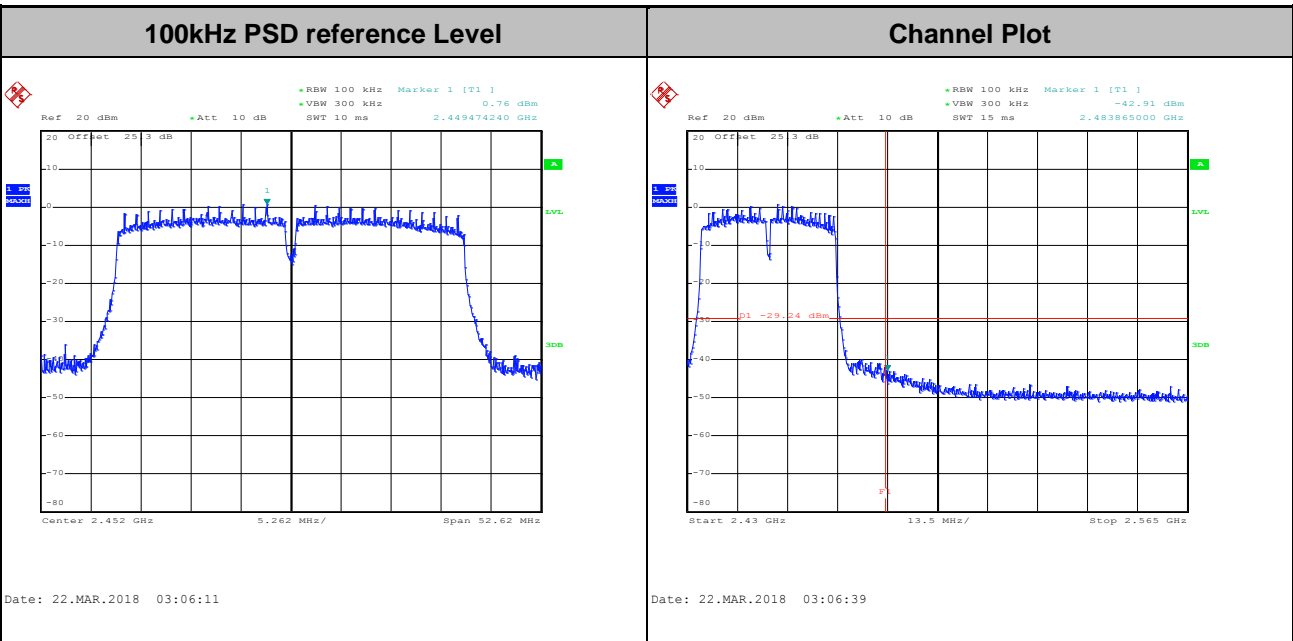



<TXBF Modes>

Number of TX = 2, Ant. 1 (Measured)

Test Mode :	802.11ac VHT20	Test Channel :	01
-------------	----------------	----------------	----

100kHz PSD reference Level	Channel Plot
-----------------------------------	---------------------

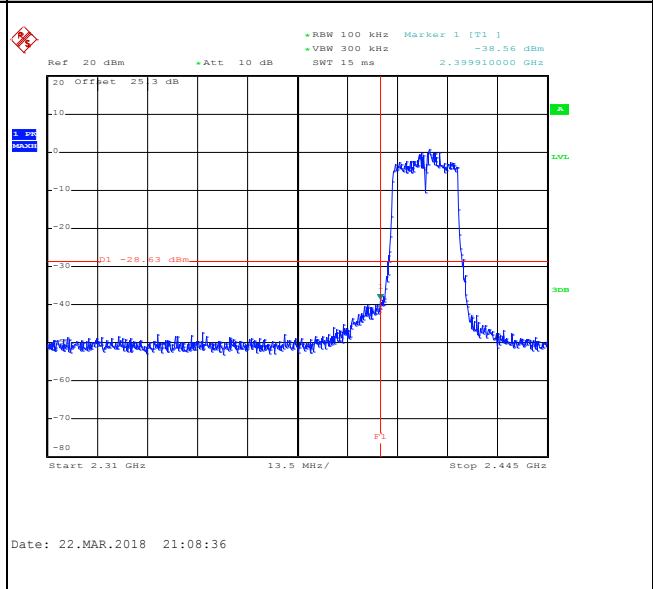
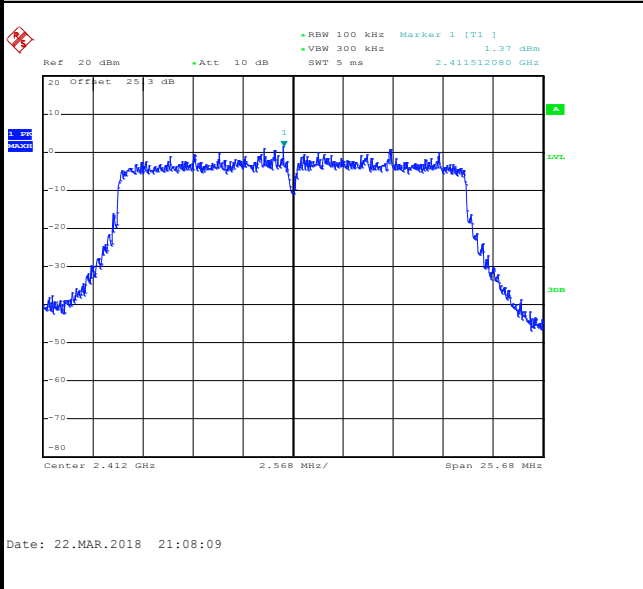

Spurious Emission 30MHz~3GHz	Spurious Emission 2GHz~25GHz
-------------------------------------	-------------------------------------

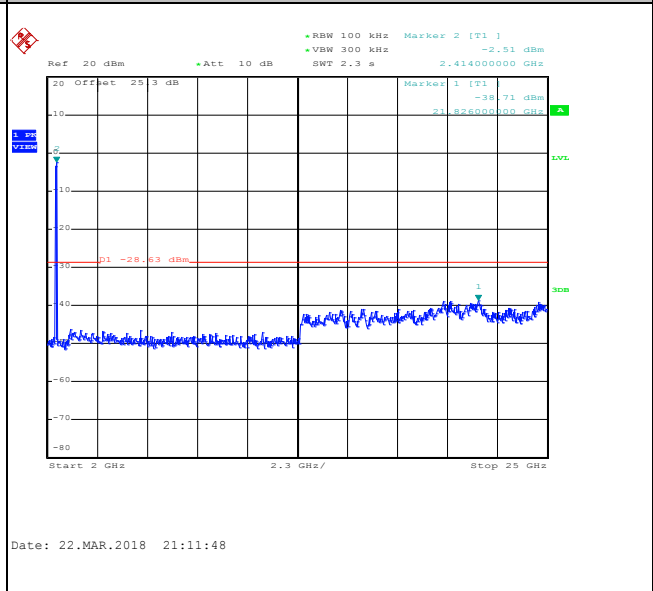
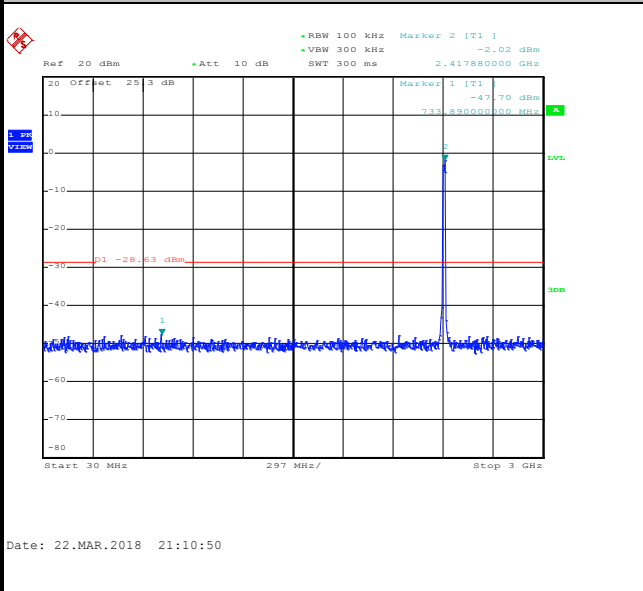



Test Mode :	802.11ac VHT20	Test Channel :	06
-------------	----------------	----------------	----

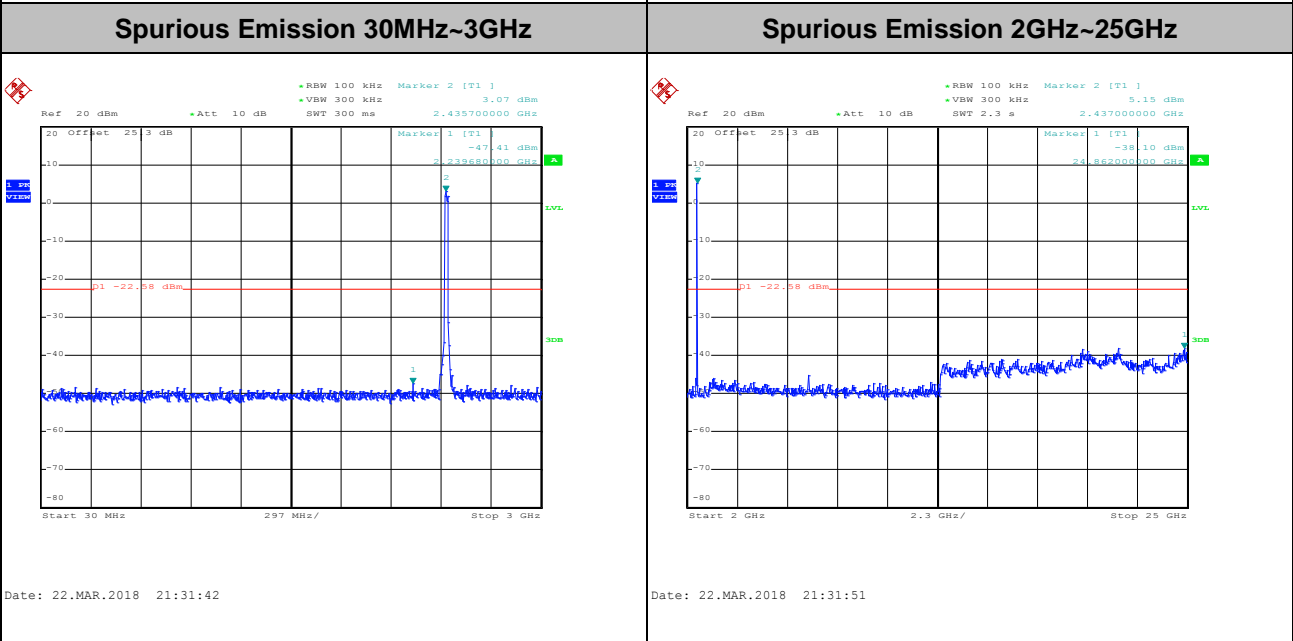
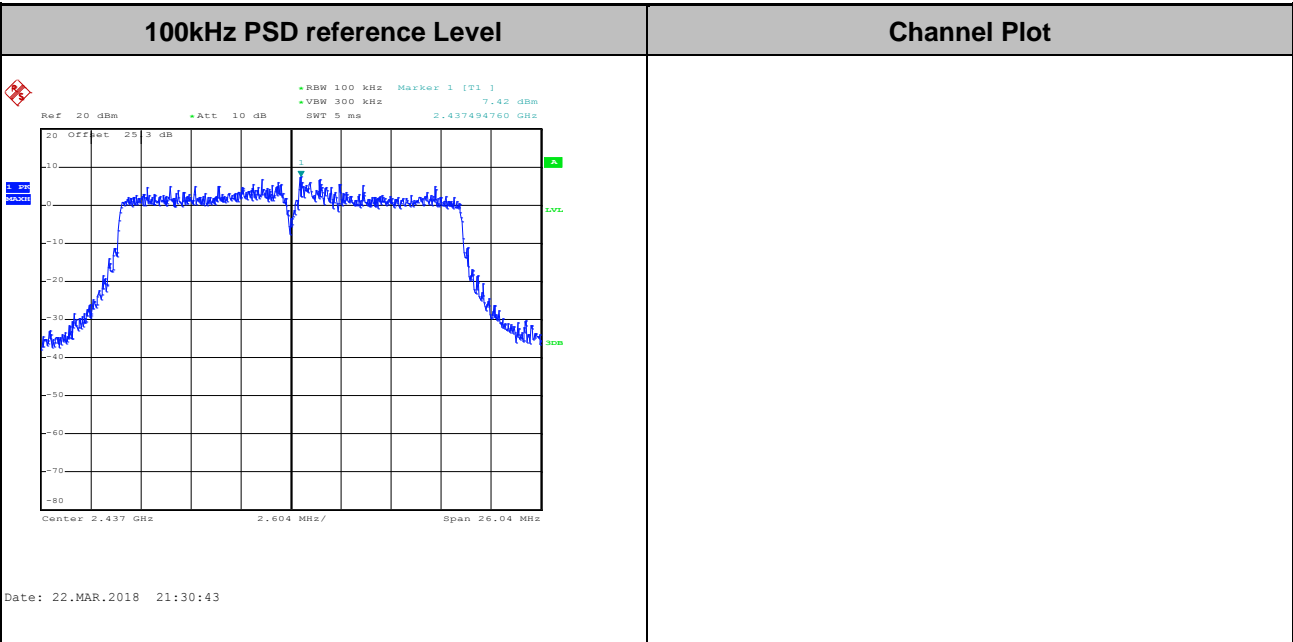



Test Mode :	802.11ac VHT20	Test Channel :	11
-------------	----------------	----------------	----

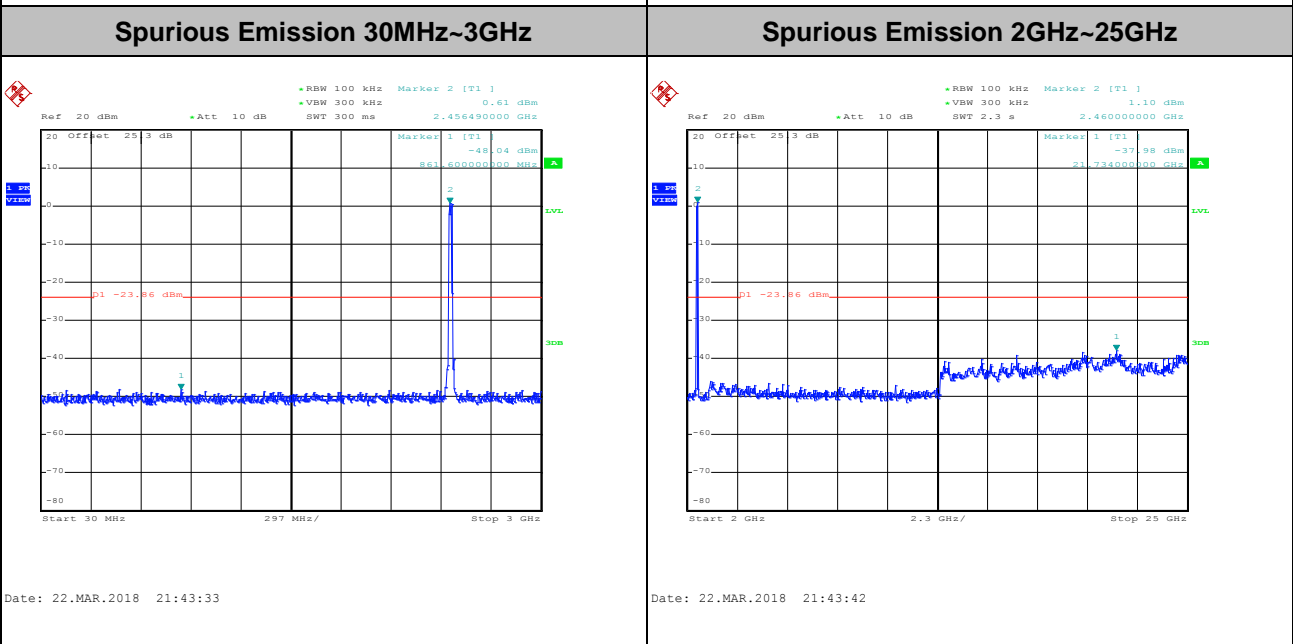
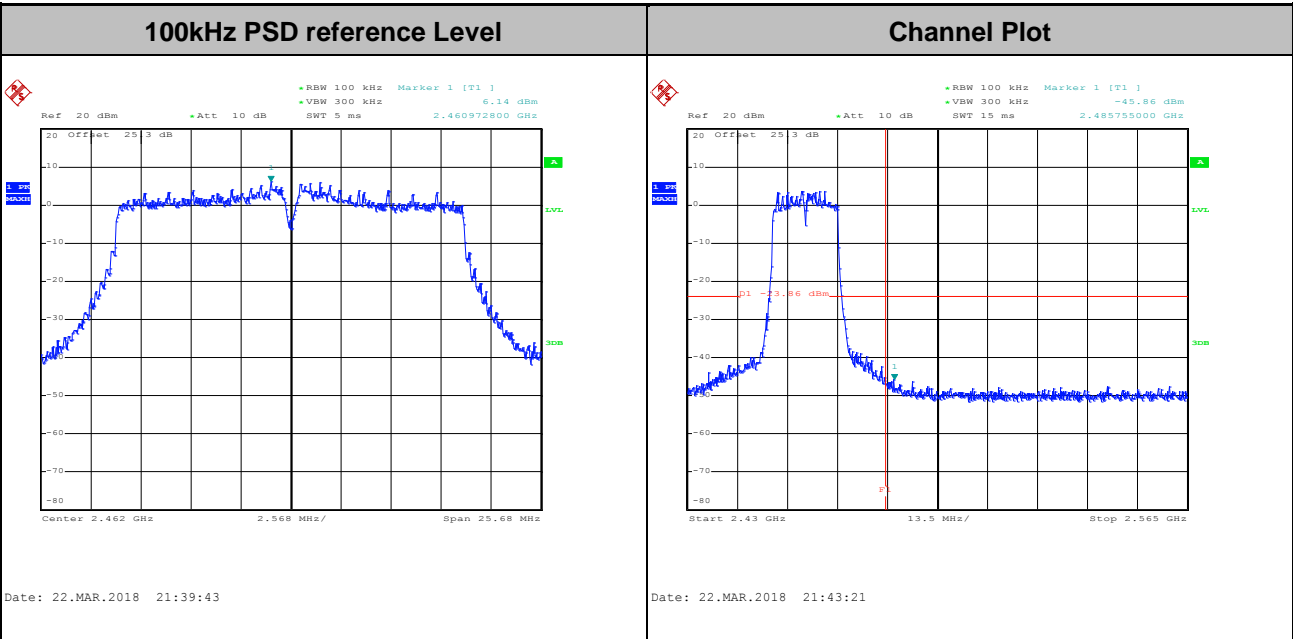



Test Mode :	802.11ac VHT40	Test Channel :	03
--------------------	----------------	-----------------------	----

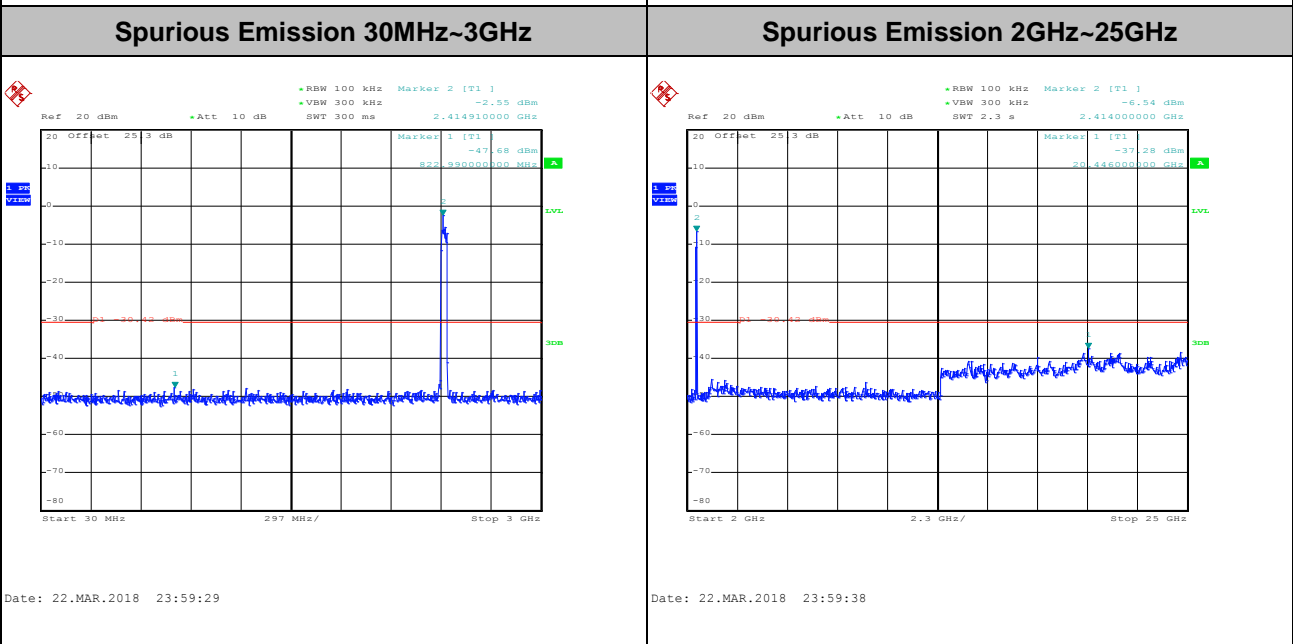
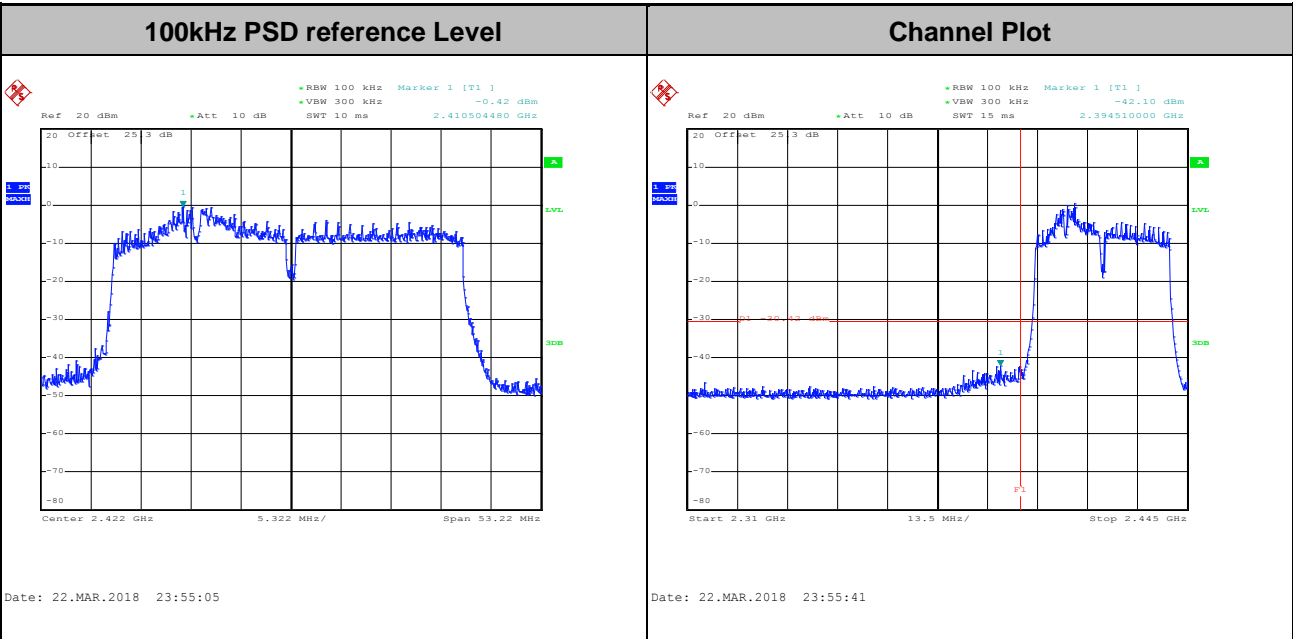



Test Mode :	802.11ac VHT40	Test Channel :	06
-------------	----------------	----------------	----

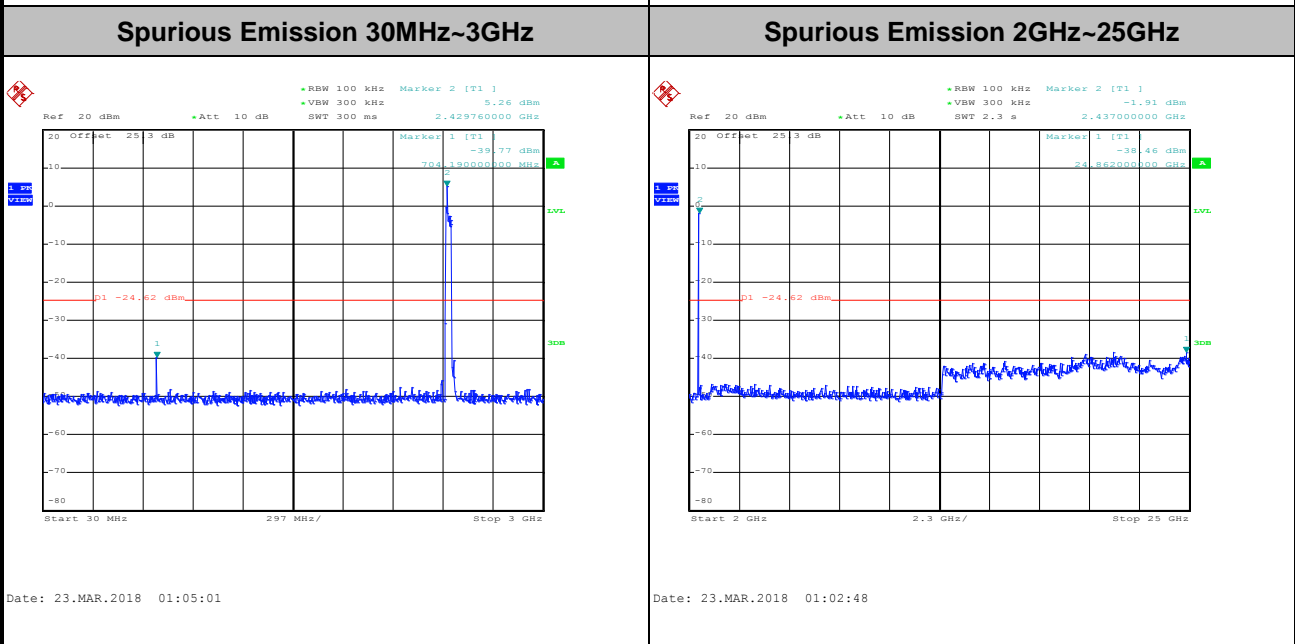
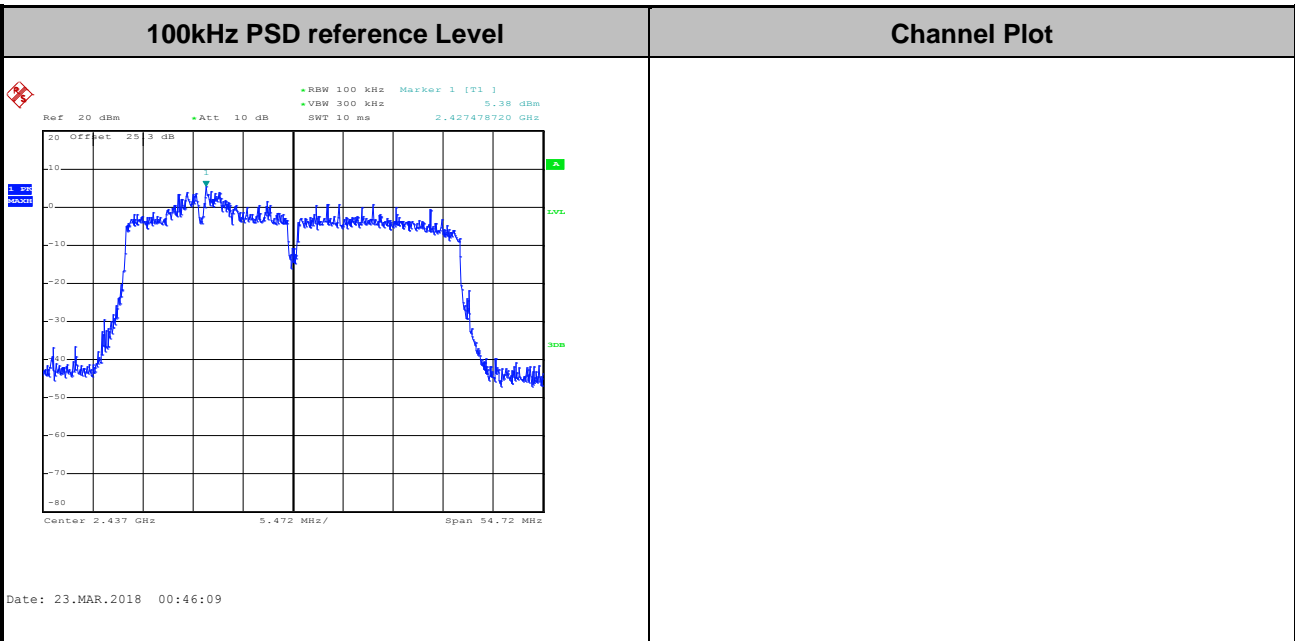



Test Mode : 802.11ac VHT40 Test Channel : 09

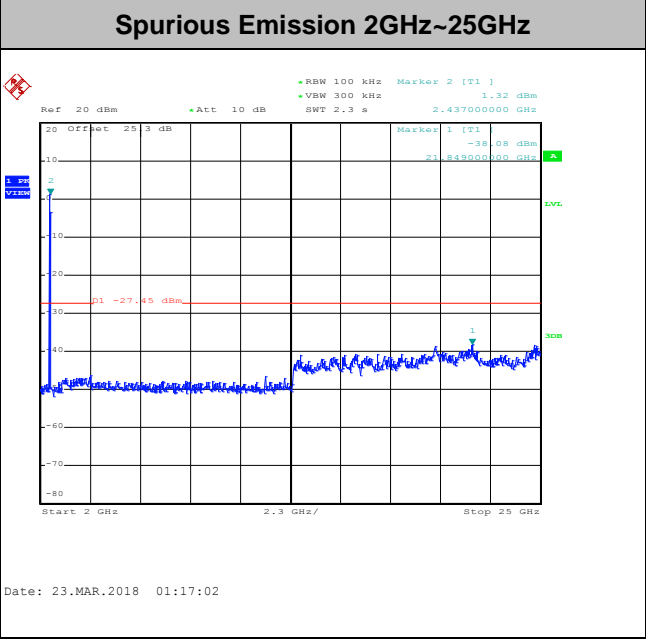
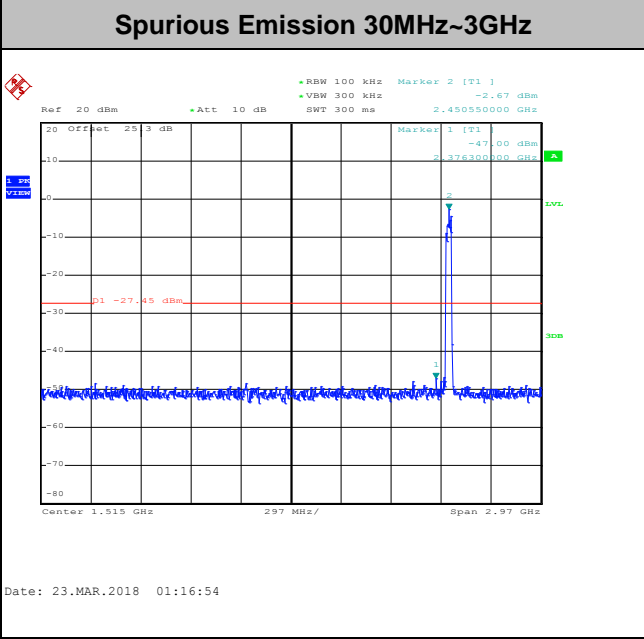
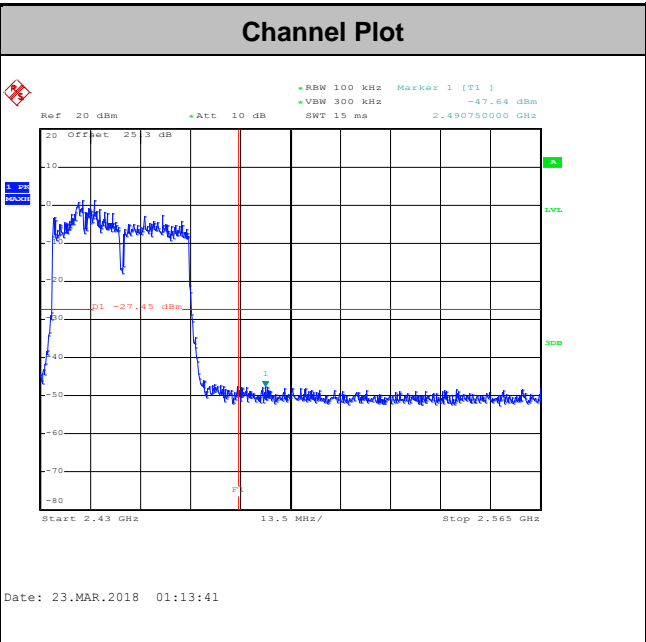
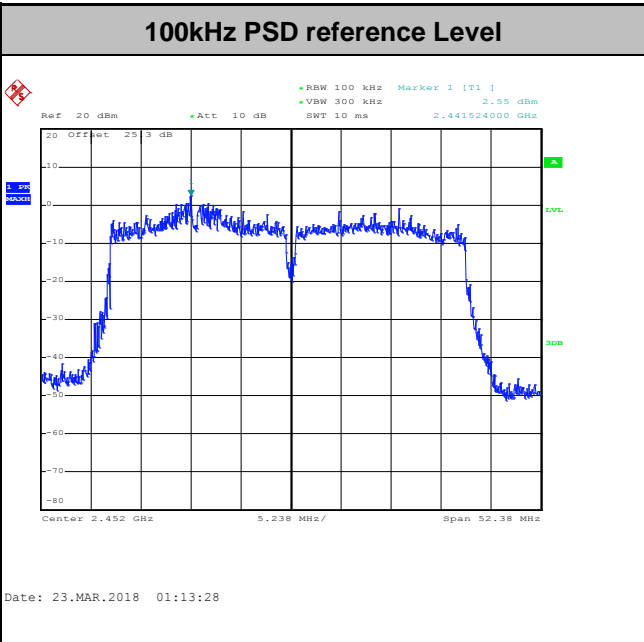



Number of TX = 2, Ant. 2 (Measured)

Test Mode :	802.11ac VHT20	Test Channel :	01
-------------	----------------	----------------	----

100kHz PSD reference Level	Channel Plot
-----------------------------------	---------------------

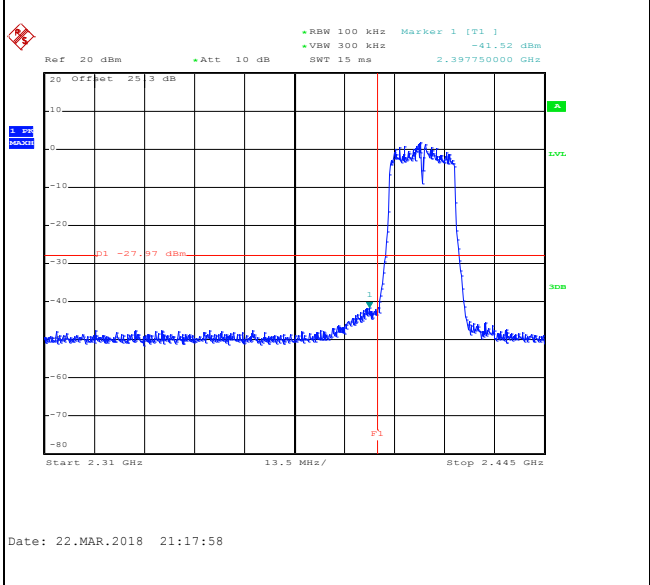
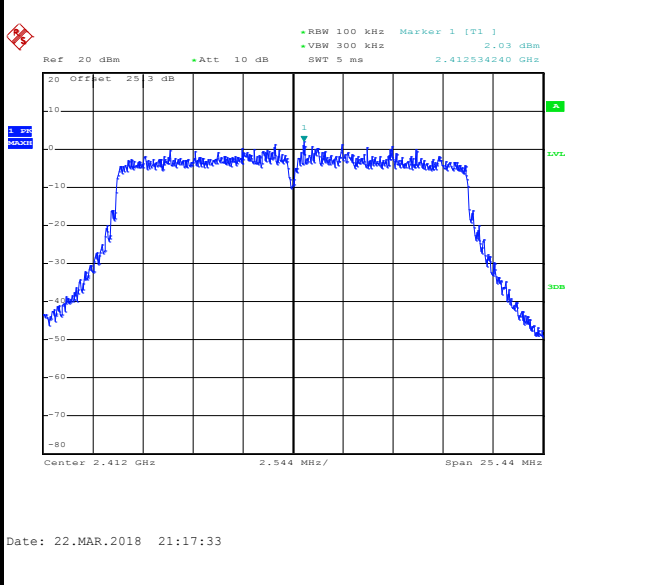

Spurious Emission 30MHz~3GHz	Spurious Emission 2GHz~25GHz
-------------------------------------	-------------------------------------

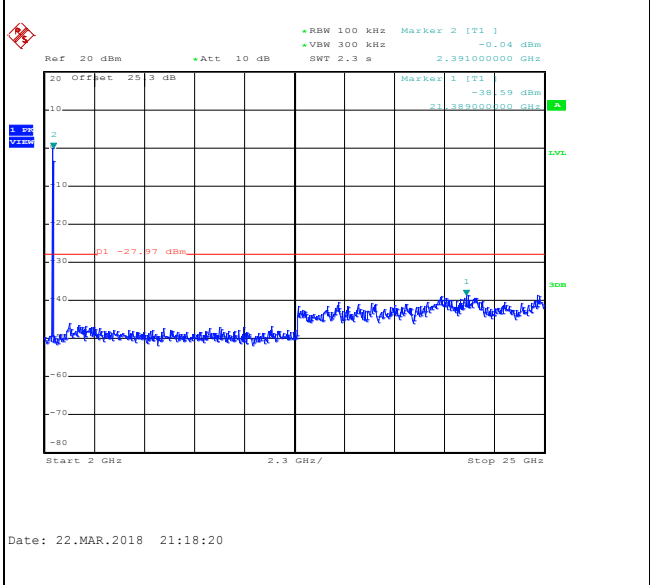
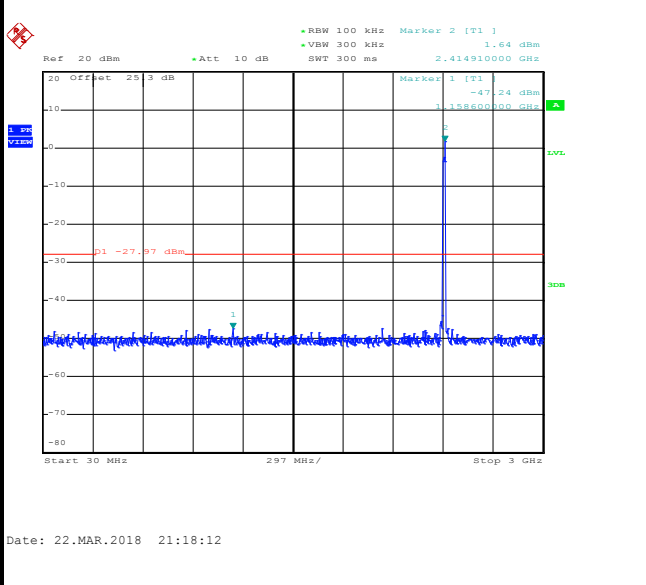



Test Mode :	802.11ac VHT20	Test Channel :	06
-------------	----------------	----------------	----

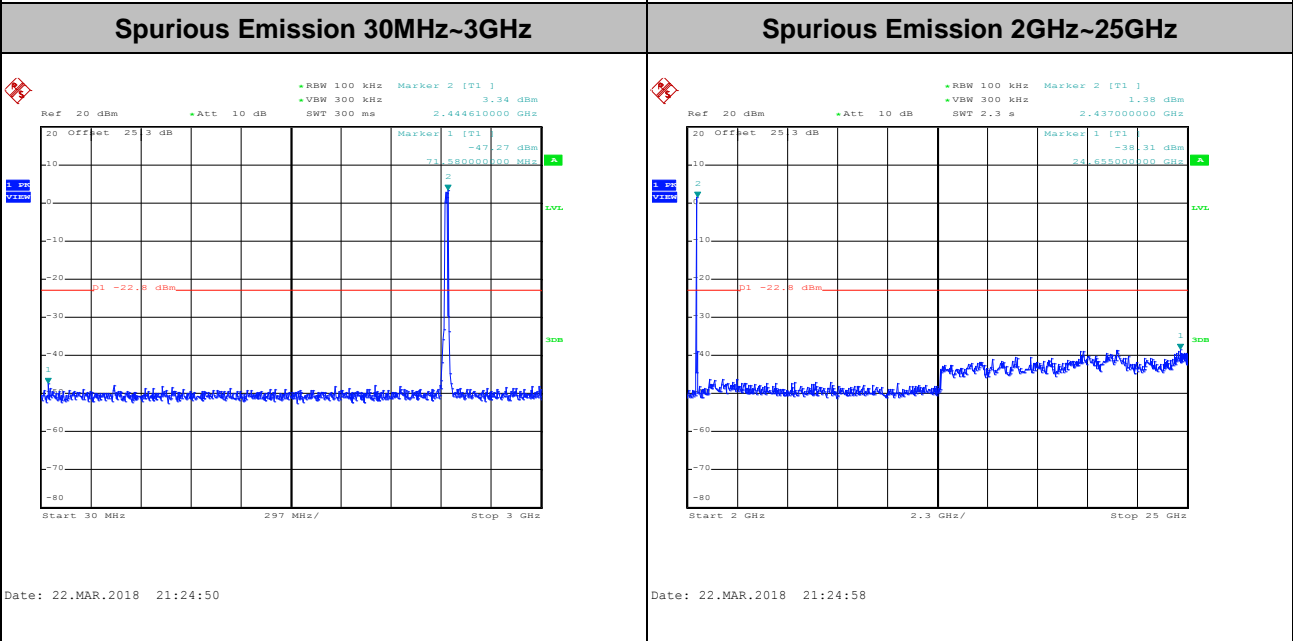
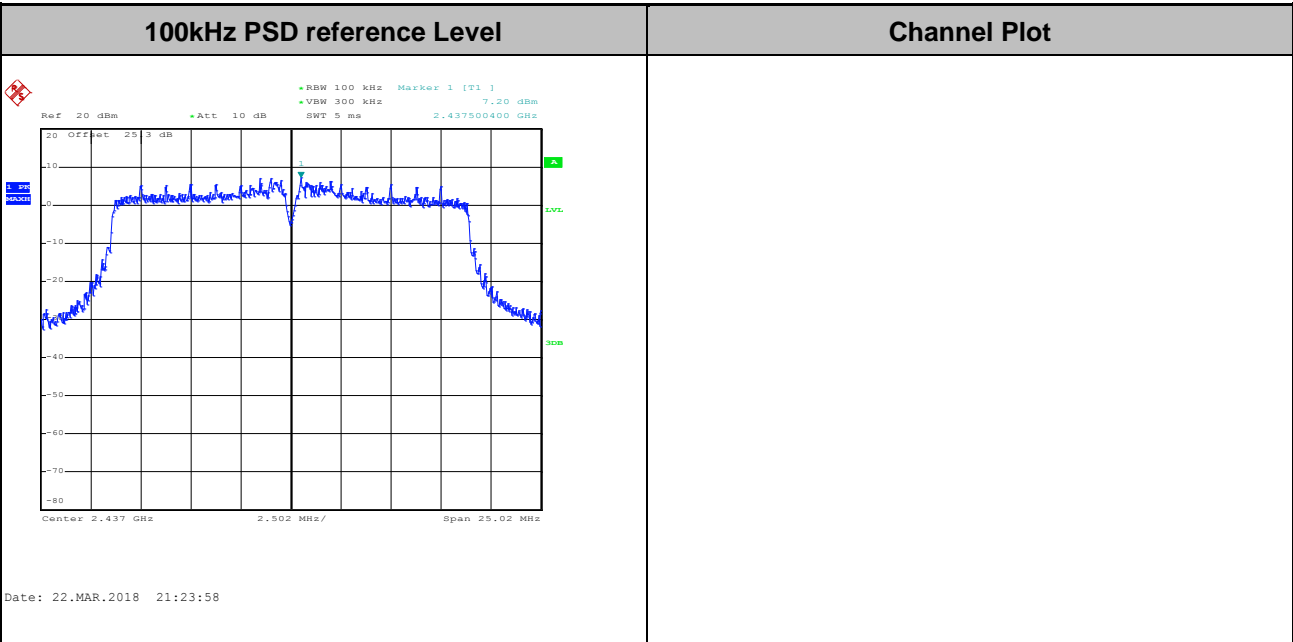



Test Mode : 802.11ac VHT20 Test Channel : 11

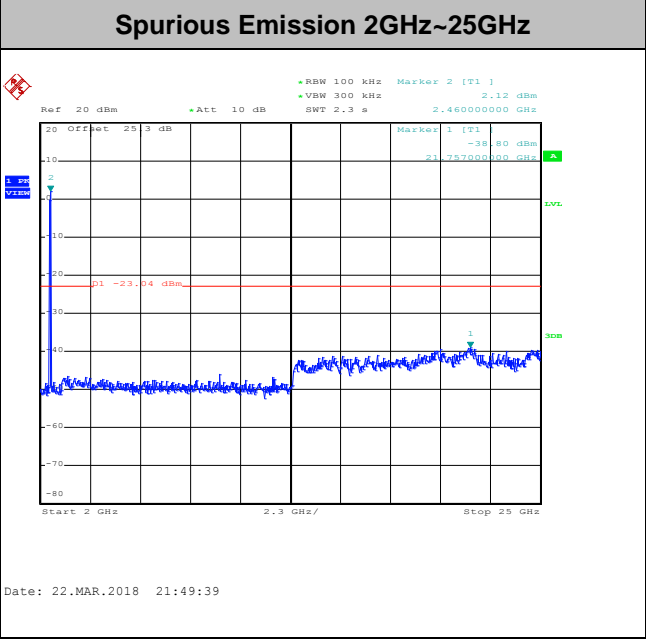
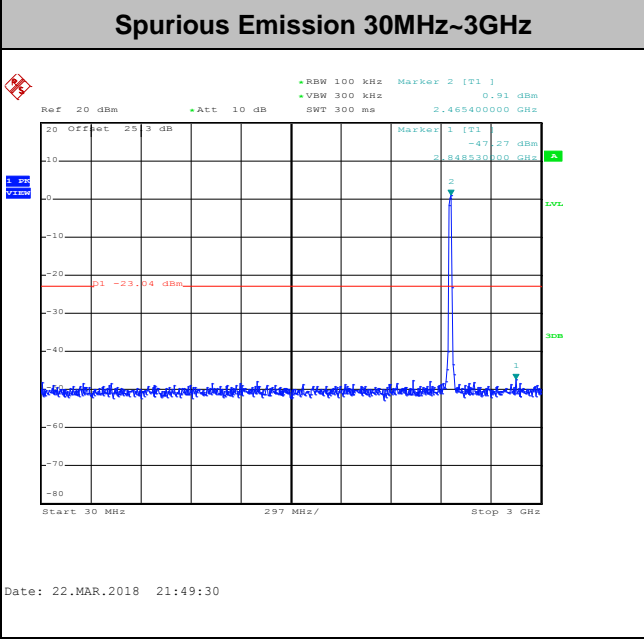
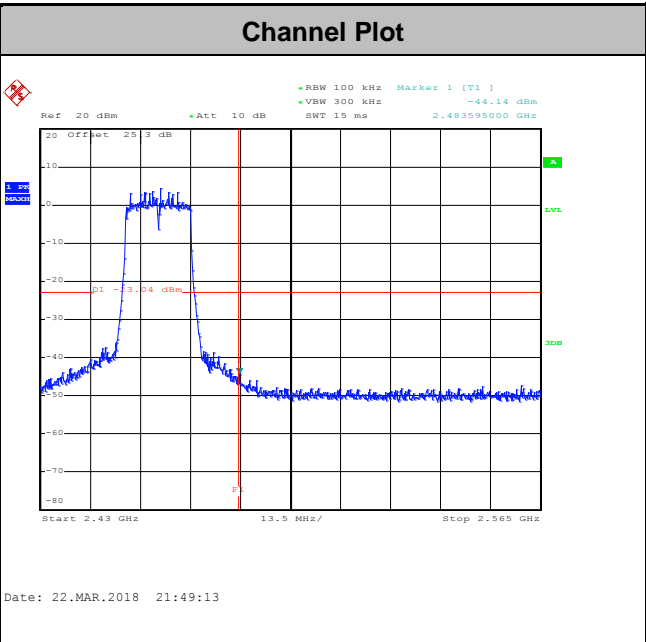
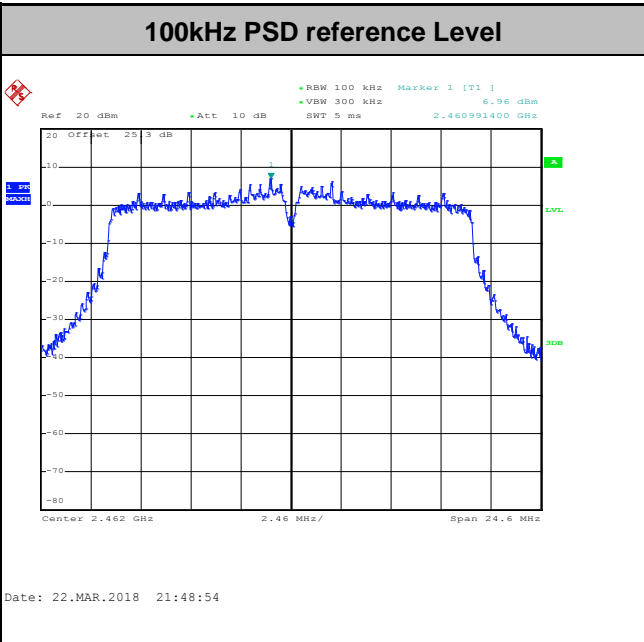



Test Mode :	802.11ac VHT40	Test Channel :	03
-------------	----------------	----------------	----

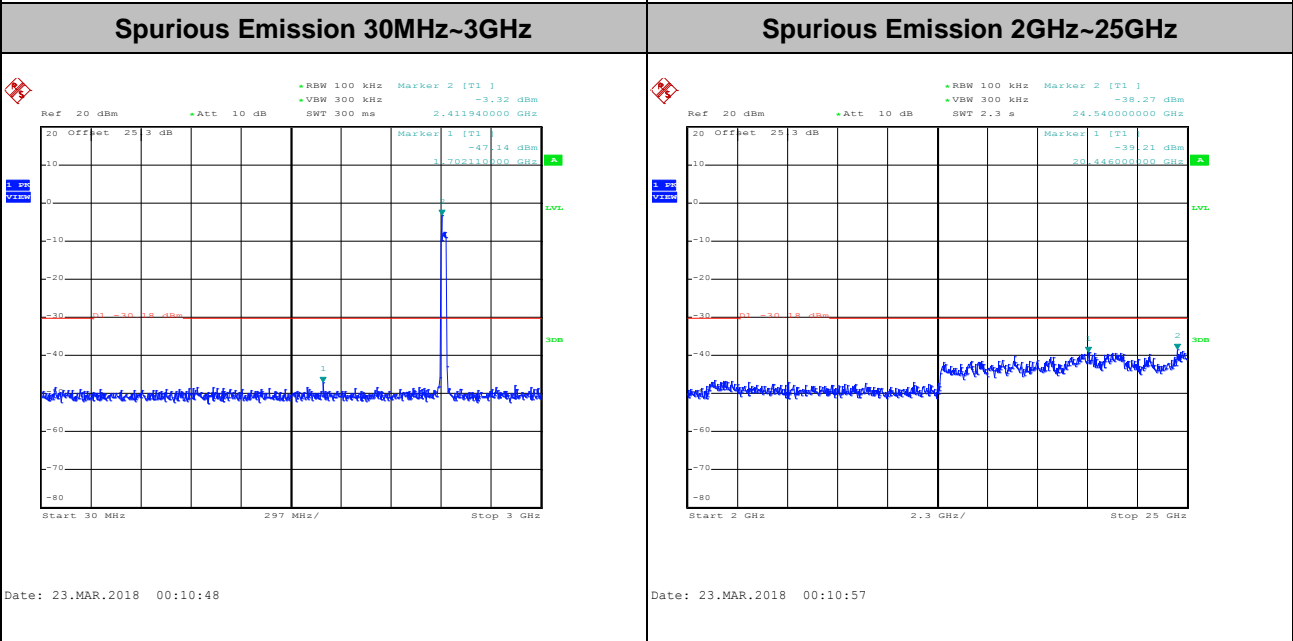
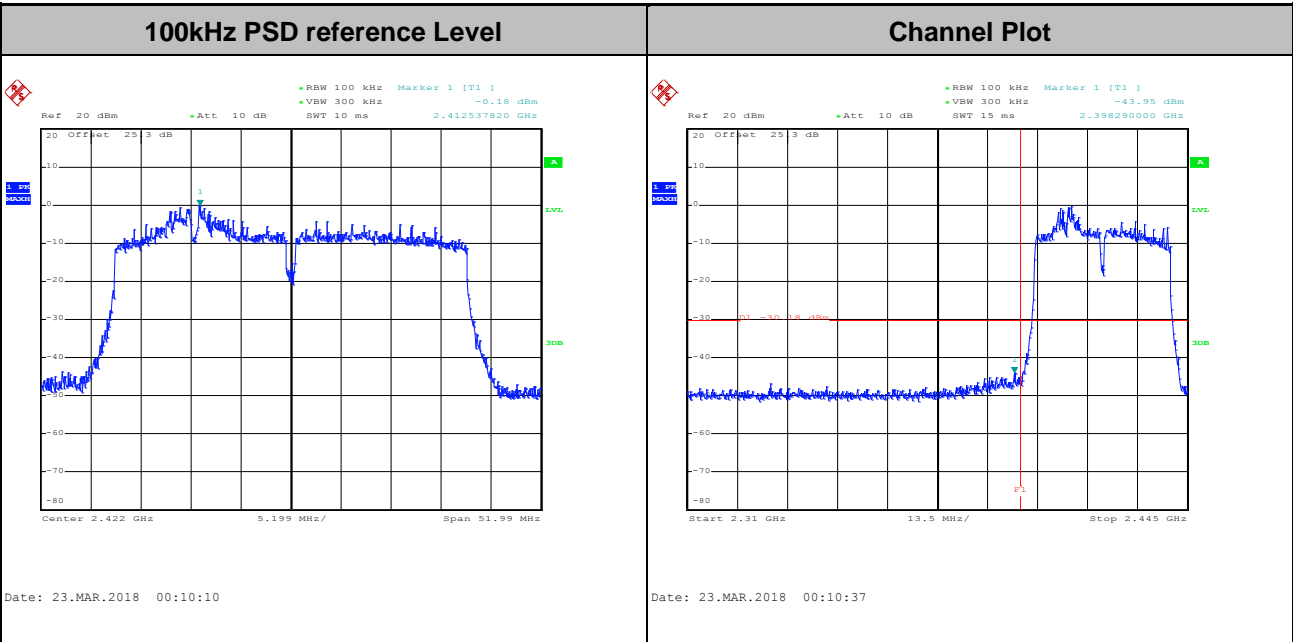



Test Mode :	802.11ac VHT40	Test Channel :	06
-------------	----------------	----------------	----

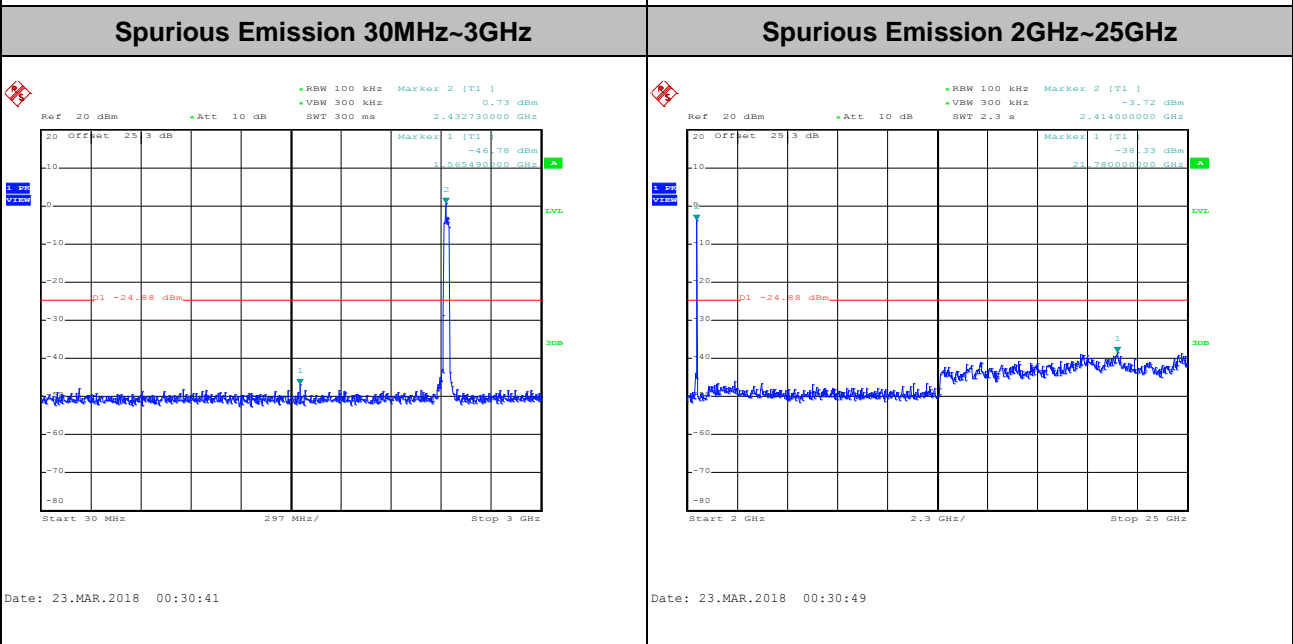
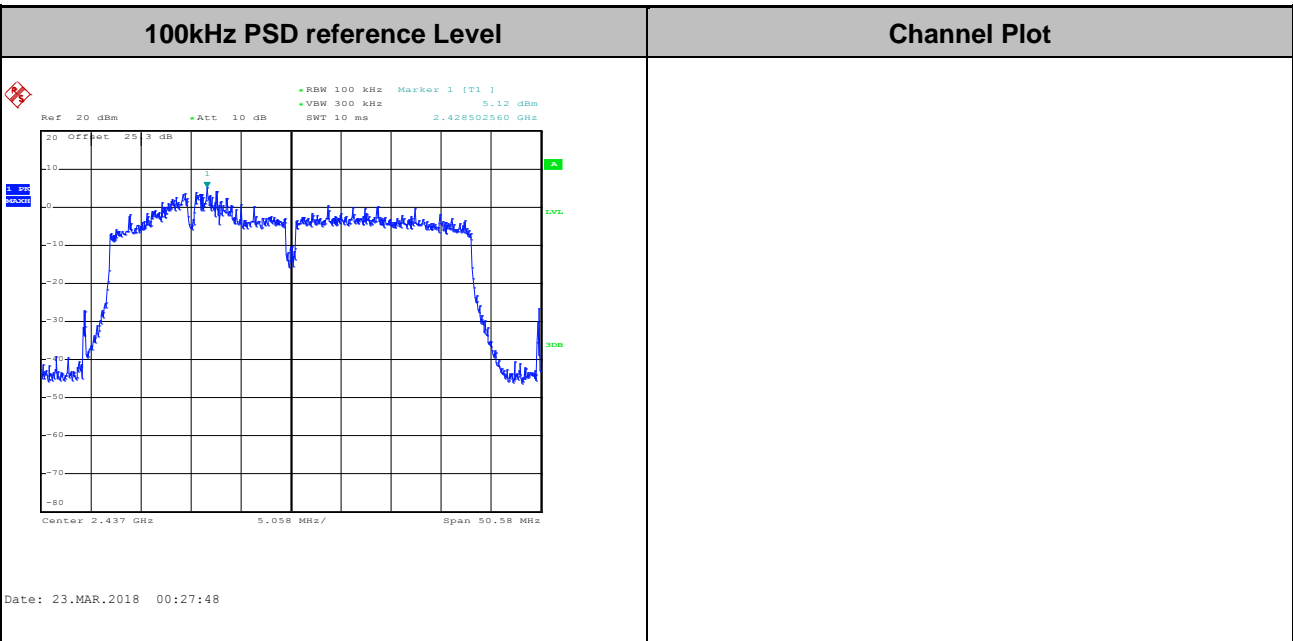



Test Mode :	802.11ac VHT40	Test Channel :	09
-------------	----------------	----------------	----

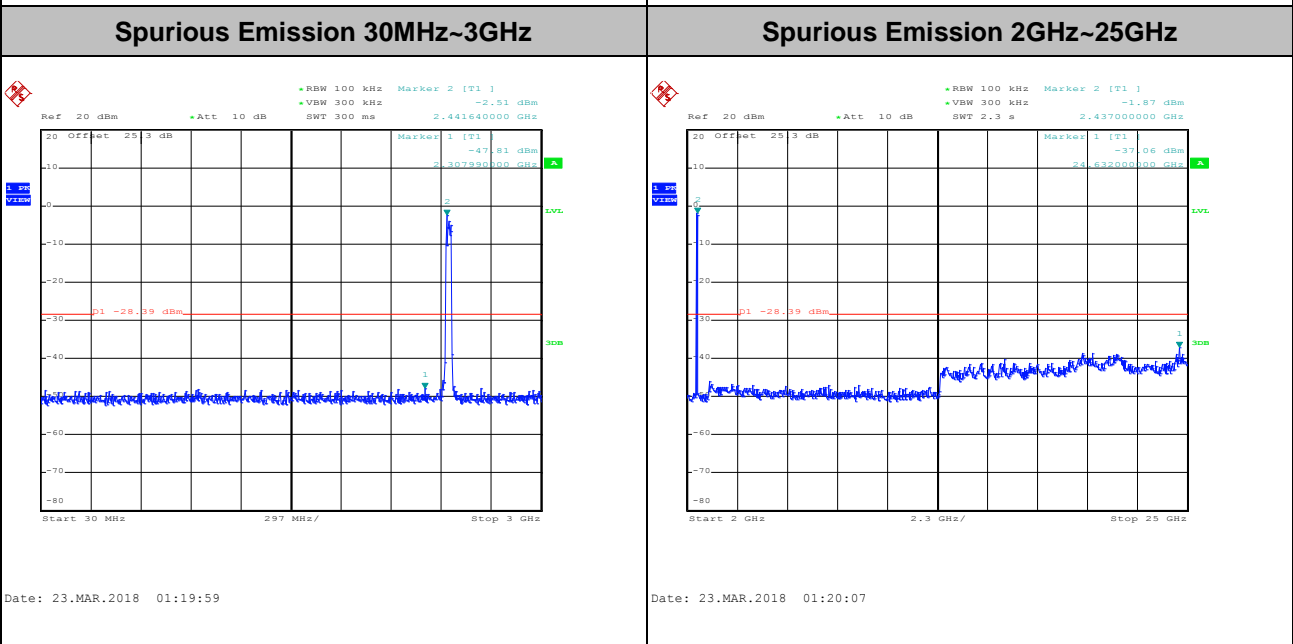
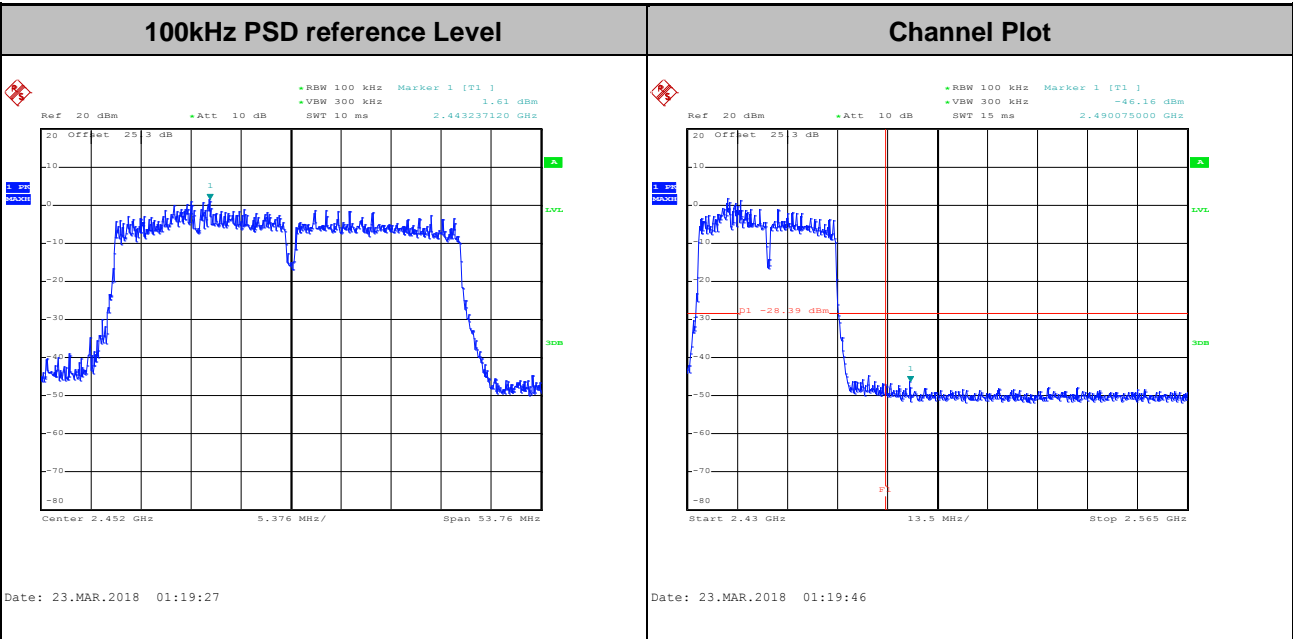



3.5 Radiated Band Edges and Spurious Emission Measurement

3.5.1 Limit of Radiated band edge and Spurious Emission Measurement

In any 100 kHz bandwidth outside the intentional radiator frequency band, all harmonics/spurious must be at least 20 dB below the highest emission level within the authorized band. If the output power of this device was measured by spectrum analyzer, the attenuation under this paragraph shall be 30 dB instead of 20 dB. In addition, radiated emissions which fall in the restricted bands must also comply with the limits as below.

Frequency (MHz)	Field Strength (microvolts/meter)	Measurement Distance (meters)
0.009 – 0.490	2400/F(kHz)	300
0.490 – 1.705	24000/F(kHz)	30
1.705 – 30.0	30	30
30 – 88	100	3
88 – 216	150	3
216 - 960	200	3
Above 960	500	3

3.5.2 Measuring Instruments

The measuring equipment is listed in the section 4 of this test report.



3.5.3 Test Procedures

1. The testing follows FCC KDB Publication No. 558074 D01 DTS Meas. Guidance v04.
2. The EUT was arranged to its worst case and then tune the antenna tower (from 1 m to 4 m) and turntable (from 0 degree to 360 degrees) to find the maximum reading. A pre-amp and a high pass filter are used for the test in order to get better signal level.
3. The EUT was placed on a turntable with 0.8 meter for frequency below 1GHz and 1.5 meter for frequency above 1GHz respectively above ground.
4. The EUT was set 3 meters from the interference receiving antenna, which was mounted on the top of a variable height antenna tower.
5. Corrected Reading: Antenna Factor + Cable Loss + Read Level - Preamp Factor = Level
6. For testing below 1GHz, if the emission level of the EUT in peak mode was 3 dB lower than the limit specified, then peak values of EUT will be reported, otherwise, the emissions will be repeated one by one using the CISPR quasi-peak method and reported.
7. For testing above 1GHz, the emission level of the EUT in peak mode was 20dB lower than average limit (that means the emission level in average mode also complies with the limit in average mode), then peak values of EUT will be reported, otherwise, the emissions will be measured in average mode again and reported.
8. Use the following spectrum analyzer settings:
 - (1) Span shall wide enough to fully capture the emission being measured;
 - (2) Set RBW=100 kHz for $f < 1$ GHz; $VBW \geq RBW$; Sweep = auto; Detector function = peak; Trace = max hold;
 - (3) Set RBW = 1 MHz, VBW= 3MHz for $f \geq 1$ GHz for peak measurement.
For average measurement:
 - $VBW = 10$ Hz, when duty cycle is no less than 98 percent.
 - $VBW \geq 1/T$, when duty cycle is less than 98 percent where T is the minimum transmission duration over which the transmitter is on and is transmitting at its maximum power control level for the tested mode of operation.

3.5.4 Test Setup

For radiated emissions below 30MHz

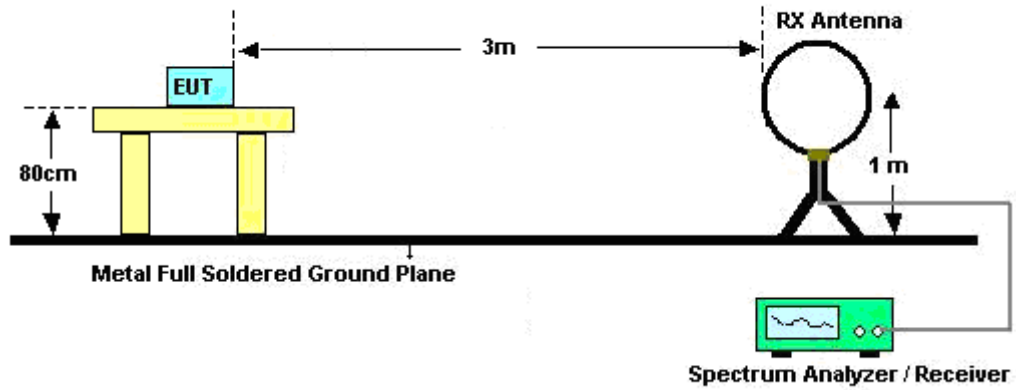

For radiated emissions from 30MHz to 1GHz

<CDD Mode>

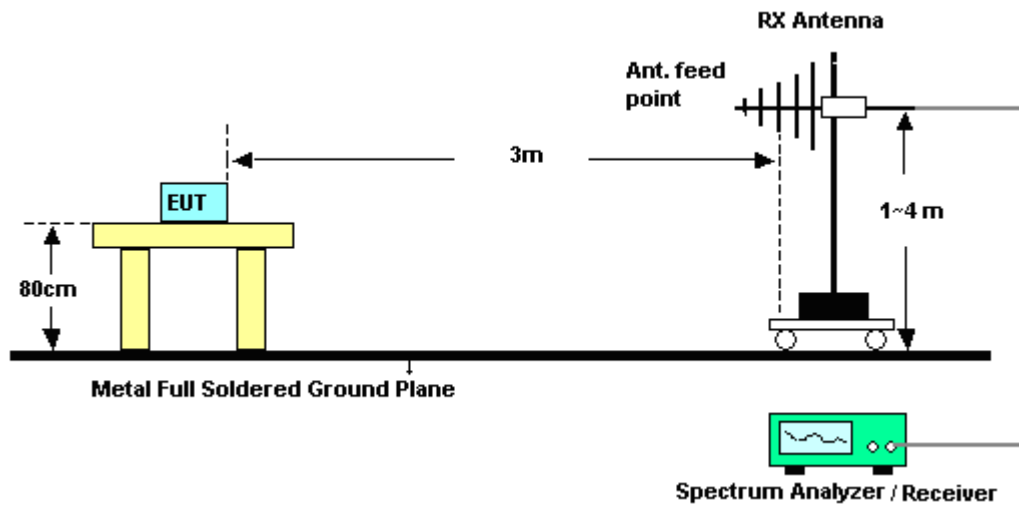

<TXBF Modes>

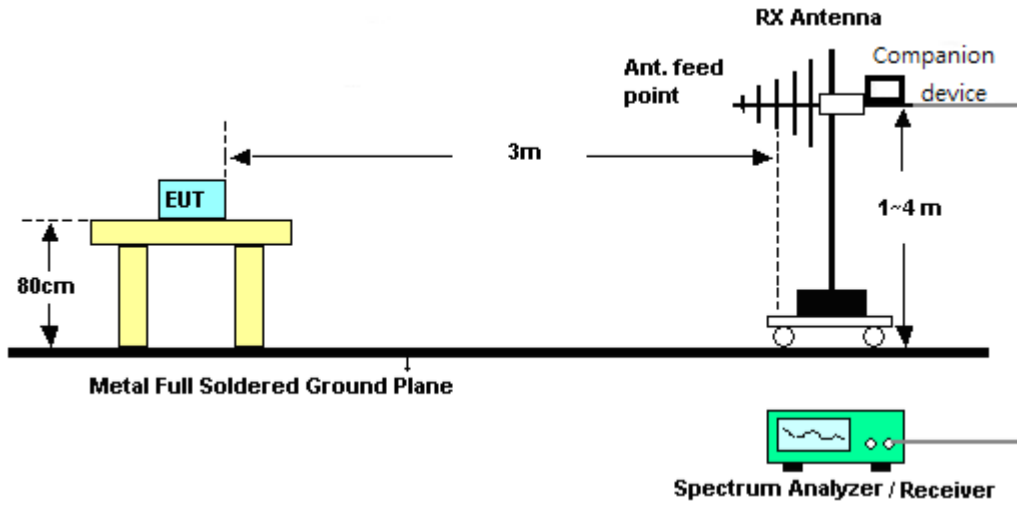

For radiated emissions above 1GHz

<CDD Mode>

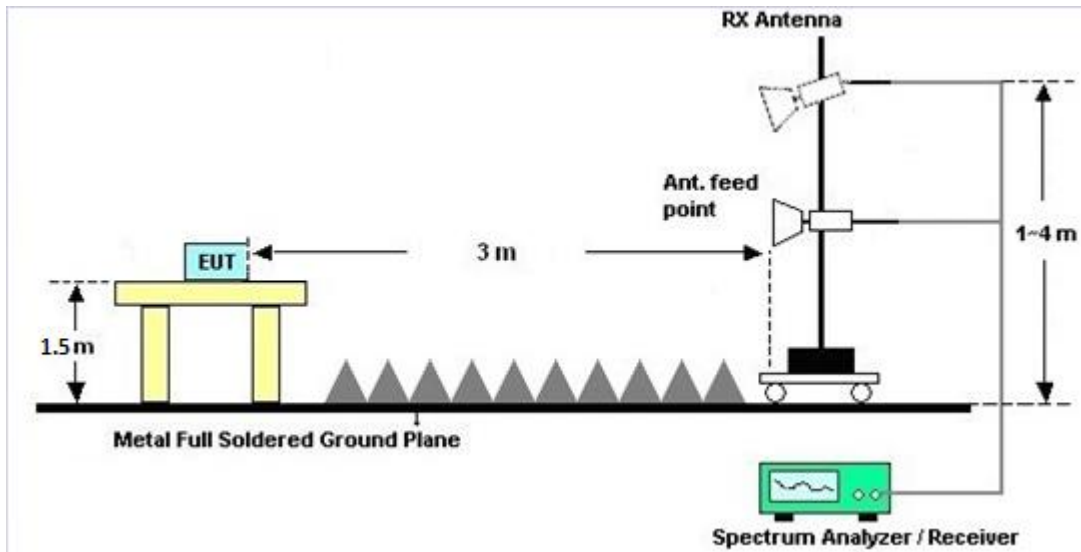

<TXBF Modes>

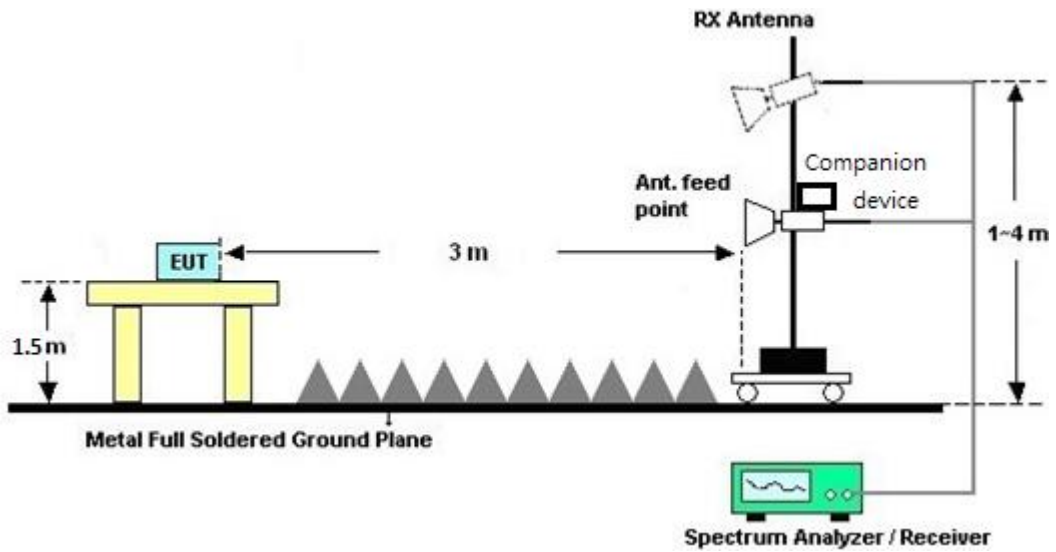

3.5.5 Test Results of Radiated Spurious Emissions (9kHz ~ 30MHz)

The low frequency, which started from 9 kHz to 30MHz, was pre-scanned and the result which was 20dB lower than the limit line was not reported.

There is a comparison data of both open-field test site and semi-Anechoic chamber, and the result came out very similar.

3.5.6 Test Result of Radiated Spurious at Band Edges

Please refer to Appendix C and D.

3.5.7 Duty Cycle

Please refer to Appendix E.

3.5.8 Test Result of Radiated Spurious Emission (30MHz ~ 10th Harmonic)

Please refer to Appendix C and D.



3.6 AC Conducted Emission Measurement

3.6.1 Limit of AC Conducted Emission

For equipment that is designed to be connected to the public utility (AC) power line, the radio frequency voltage that is conducted back onto the AC power line on any frequency or frequencies within the band 150 kHz to 30 MHz shall not exceed the limits in the following table.

Frequency of Emission (MHz)	Conducted Limit (dBµV)	
	Quasi-Peak	Average
0.15-0.5	66 to 56*	56 to 46*
0.5-5	56	46
5-30	60	50

*Decreases with the logarithm of the frequency.

3.6.2 Measuring Instruments

The measuring equipment is listed in the section 4 of this test report.

3.6.3 Test Procedures

1. The EUT was placed 0.4 meter from the conducting wall of the shielding room, and it was kept at least 80 centimeters from any other grounded conducting surface.
2. Connect EUT to the power mains through a line impedance stabilization network (LISN).
3. All the support units are connecting to the other LISN.
4. The LISN provides 50 ohm coupling impedance for the measuring instrument.
5. The FCC states that a 50 ohm, 50 microhenry LISN should be used.
6. Both sides of AC line were checked for maximum conducted interference.
7. The frequency range from 150 kHz to 30 MHz was searched.
8. Set the test-receiver system to Peak Detect Function and specified bandwidth (IF bandwidth = 9kHz) with Maximum Hold Mode.

3.6.4 Test Setup

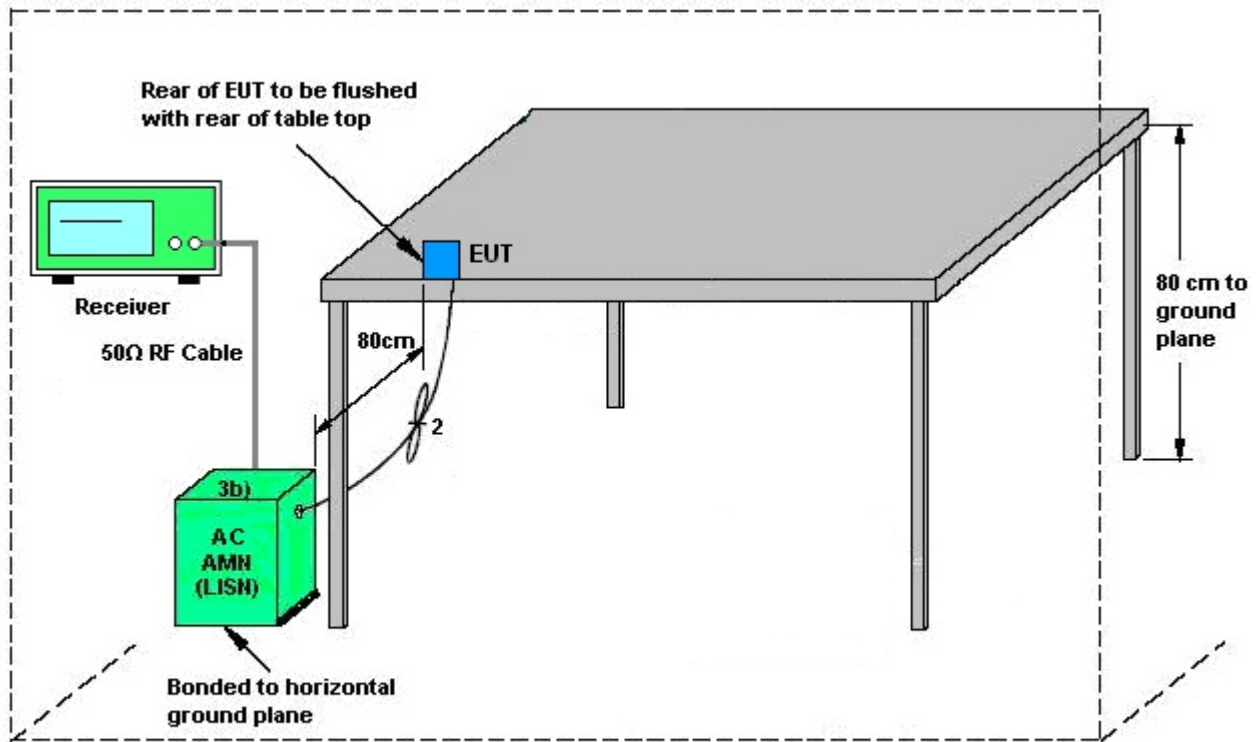

AMN = Artificial mains network (LISH)
 AE = Associated equipment
 EUT = Equipment under test
 ISN = Impedance stabilization network

3.6.5 Test Result of AC Conducted Emission

Please refer to Appendix B.



3.7 Antenna Requirements

3.7.1 Standard Applicable

If directional gain of transmitting Antennas is greater than 6dBi, the power shall be reduced by the same level in dB comparing to gain minus 6dBi. The use of a permanently attached Antenna or of an Antenna that uses a unique coupling to the intentional radiator shall be considered sufficient to comply with the rule.

3.7.2 Antenna Anti-Replacement Construction

An embedded-in antenna design is used.

3.7.3 Antenna Gain

<CDD Modes >

FCC KDB 662911 D01 Multiple Transmitter Output v02r01

For CDD transmissions, directional gain is calculated as

Directional gain = G_{ANT} + Array Gain, where Array Gain is as follows.

For power spectral density (PSD) measurements on all devices,

Array Gain = $10 \log(N_{ANT}/N_{SS}=1)$ dB.

For power measurements on IEEE 802.11 devices,

Array Gain = 0 dB (i.e., no array gain) for $N_{ANT} \leq 4$.

Directional gain may be calculated by using the formulas applicable to equal gain antennas with G_{ANT} set equal to the gain of the antenna having the highest gain;

The EUT supports CDD mode.

For power, the directional gain G_{ANT} is set equal to the antenna having the highest gain, i.e., F)2)f)i).

For PSD, the directional gain calculation is following F)2)f)ii) of KDB 662911 D01 v02r01.

The power and PSD limit should be modified if the directional gain of EUT is over 6 dBi,

The directional gain "DG" is calculated as following table.

<CDD Modes>						
			DG	DG	Power	PSD
			for	for	Limit	Limit
	Ant. 1	Ant. 2	Power	PSD	Reduction	Reduction
	(dBi)	(dBi)	(dBi)	(dBi)	(dB)	(dB)
2.4 GHz	1.70	1.90	1.90	4.81	0.00	0.00

$Power\ Limit\ Reduction = DG(Power) - 6dBi, (min = 0)$

$PSD\ Limit\ Reduction = DG(PSD) - 6dBi, (min = 0)$

TXBF modes

FCC KDB 662911 D01 Multiple Transmitter Output v02r01

For CDD transmissions, directional gain is calculated as

$$DirectionalGain = 10 \cdot \log \left[\frac{\sum_{j=1}^{N_{SS}} \left\{ \sum_{k=1}^{N_{ANT}} g_{j,k} \right\}^2}{N_{ANT}} \right]$$

where

Each antenna is driven by no more than one spatial stream;

N_{SS} = the number of independent spatial streams of data;

N_{ANT} = the total number of antennas

$g_{j,k} = 10^{G_k / 20}$ if the k th antenna is being fed by spatial stream j , or zero if it is not;
 G_k is the gain in dBi of the k th antenna.

The EUT supports beamforming for 802.11ac modes.

The directional gain calculation is following F)2)e)ii) of KDB 662911 D01 v02r01.

The power and PSD limit should be modified if the directional gain of EUT is over 6 dBi,

The directional gain “DG” is calculated as following table.

			DG	DG	Power	PSD
			for	for	Limit	Limit
	Ant. 1	Ant. 2	Power	PSD	Reduction	Reduction
	(dBi)	(dBi)	(dBi)	(dBi)	(dB)	(dB)
2.4 GHz	1.70	1.90	4.81	4.81	0.00	0.00

Power Limit Reduction = DG(Power) – 6dBi, (min = 0)

PSD Limit Reduction = DG(PSD) – 6dBi, (min = 0)



4 List of Measuring Equipment

Instrument	Manufacturer	Model No.	Serial No.	Characteristics	Calibration Date	Test Date	Due Date	Remark
Power Meter	Anritsu	ML2495A	1240001	N/A	Sep. 07, 2017	Feb. 03, 2018~ Apr. 19, 2018	Sep. 06, 2018	Conducted (TH05-HY)
Power Sensor	Anritsu	MA2411B	1207349	300MHz~40GHz	Sep. 07, 2017	Feb. 03, 2018~ Apr. 19, 2018	Sep. 06, 2018	Conducted (TH05-HY)
Spectrum Analyzer	Rohde & Schwarz	FSP40	100055	9kHz~40GHz	Jun. 20, 2017	Feb. 03, 2018~ Apr. 19, 2018	Jun. 19, 2018	Conducted (TH05-HY)
Power Sensor	DARE	RPR3006W	16I00054S NO10	10MHz~6GHz	Dec. 11, 2017	Feb. 03, 2018~ Apr. 19, 2018	Dec. 10, 2018	Conducted (TH05-HY)
Signal Analyzer	Rohde & Schwarz	FSV40	101397	10Hz~40GHz	Nov. 07, 2017	Feb. 03, 2018~ Apr. 19, 2018	Nov. 06, 2018	Conducted (TH05-HY)
Spectrum Analyzer	Rohde & Schwarz	FSP40	100057	9kHz~40GHz	Nov. 21, 2017	Feb. 03, 2018~ Apr. 19, 2018	Nov. 20, 2018	Conducted (TH05-HY)
AC Power Source	ChainTek	APC-1000W	N/A	N/A	N/A	Mar. 27, 2018	N/A	Conduction (CO05-HY)
EMI Test Receiver	Rohde & Schwarz	ESCI 7	100724	9kHz~7GHz	Sep. 20, 2017	Mar. 27, 2018	Sep. 19, 2018	Conduction (CO05-HY)
LISN	Rohde & Schwarz	ENV216	100080	9kHz~30MHz	Nov. 30, 2017	Mar. 27, 2018	Nov. 29, 2018	Conduction (CO05-HY)
LISN	Rohde & Schwarz	ENV216	100081	9kHz~30MHz	Dec. 08, 2017	Mar. 27, 2018	Dec. 07, 2018	Conduction (CO05-HY)
Software	Rohde & Schwarz	EMC32 V10.30	N/A	N/A	N/A	Mar. 27, 2018	N/A	Conduction (CO05-HY)
LF Cable	HUBER + SUHNER	RG-214/U	LF01	N/A	Jan. 03, 2018	Mar. 27, 2018	Jan. 02, 2019	Conduction (CO05-HY)
Pulse Limiter	Rohde & Schwarz	ESH3-Z2	100851	N/A	Jan. 03, 2018	Mar. 27, 2018	Jan. 02, 2019	Conduction (CO05-HY)



Instrument	Manufacturer	Model No.	Serial No.	Characteristics	Calibration Date	Test Date	Due Date	Remark
Amplifier	MITEQ	TTA1840-35-HG	1871923	18GHz~40GHz, VSWR : 2.5:1 max	Jul. 18, 2017	Feb. 11, 2018~ Apr. 22, 2018	Jul. 17, 2018	Radiation (03CH11-HY)
Amplifier	SONOMA	310N	187312	9kHz~1GHz	Nov. 10, 2016	Feb. 11, 2018~ Apr. 22, 2018	Nov. 09, 2018	Radiation (03CH11-HY)
Bilog Antenna	TESEQ	CBL 6111D&N-6-0 6	35414&AT- N0602	30MHz~1GHz	Oct. 14, 2017	Feb. 11, 2018~ Apr. 22, 2018	Oct. 13, 2018	Radiation (03CH11-HY)
Horn Antenna	SCHWARZBE CK	BBHA 9120 D	9120D-132 6	1GHz ~ 18GHz	Oct. 16, 2017	Feb. 11, 2018~ Apr. 22, 2018	Oct. 15, 2018	Radiation (03CH11-HY)
Loop Antenna	Rohde & Schwarz	HFH2-Z2	100488	9 kHz~30 MHz	Nov. 23, 2017	Feb. 11, 2018~ Apr. 22, 2018	Nov. 22, 2019	Radiation (03CH11-HY)
Preamplifier	Keysight	83017A	MY532700 80	1GHz~26.5GHz	Nov. 10, 2016	Feb. 11, 2018~ Apr. 22, 2018	Nov. 09, 2018	Radiation (03CH11-HY)
Spectrum Analyzer	Keysight	N9010A	MY542004 86	10Hz ~ 44GHz	Oct. 19, 2017	Feb. 11, 2018~ Apr. 22, 2018	Oct. 18, 2018	Radiation (03CH11-HY)
Antenna Mast	EMEC	AM-BS-4500- B	N/A	1~4m	N/A	Feb. 11, 2018~ Apr. 22, 2018	N/A	Radiation (03CH11-HY)
Turn Table	EMEC	TT 2000	N/A	0~360 Degree	N/A	Feb. 11, 2018~ Apr. 22, 2018	N/A	Radiation (03CH11-HY)
Preamplifier	MITEQ	AMF-7D-0010 1800-30-10P	1590074	1GHz~18GHz	May 22, 2017	Feb. 11, 2018~ Apr. 22, 2018	May 21, 2018	Radiation (03CH11-HY)
Preamplifier	MITEQ	AMF-7D-0010 1800	2025787	1GHz~18GHz	Feb. 13,2017	Feb. 11, 2018~ Apr. 22, 2018	Feb. 12,2019	Radiation (03CH11-HY)
EMI Test Receiver	Agilent	N9038A (MXE)	MY532900 53	20Hz to 26.5GHz	Jan. 16, 2018	Feb. 11, 2018~ Apr. 22, 2018	Jan. 15, 2019	Radiation (03CH11-HY)
SHF-EHF Horn Antenna	SCHWARZBE CK	BBHA 9170	BBHA9170 584	18GHz- 40GHz	Nov. 27, 2017	Feb. 11, 2018~ Apr. 22, 2018	Nov. 26, 2018	Radiation (03CH11-HY)
Software	Audix	E3 6.2009-8- 24	RK-00104 2	NA	NA	Feb. 11, 2018~ Apr. 22, 2018	NA	Radiation (03CH11-HY)



5 Uncertainty of Evaluation

Uncertainty of Conducted Emission Measurement (150kHz ~ 30MHz)

Measuring Uncertainty for a Level of Confidence of 95% ($U = 2Uc(y)$)	2.70
---	------

Uncertainty of Radiated Emission Measurement (30 MHz ~ 1000 MHz)

Measuring Uncertainty for a Level of Confidence of 95% ($U = 2Uc(y)$)	5.20
---	------

Uncertainty of Radiated Emission Measurement (1000 MHz ~ 18000 MHz)

Measuring Uncertainty for a Level of Confidence of 95% ($U = 2Uc(y)$)	5.50
---	------

Uncertainty of Radiated Emission Measurement (18000 MHz ~ 40000 MHz)

Measuring Uncertainty for a Level of Confidence of 95% ($U = 2Uc(y)$)	5.20
---	------

Appendix A. Test Result of Conducted Test Items

<For CDD Mode>

Test Engineer:	Kai Liao	Temperature:	21~25	°C
Test Date:	2018/2/3 ~ 2018/04/19	Relative Humidity:	51~54	%

TEST RESULTS DATA
6dB and 99% Occupied Bandwidth

2.4GHz Band										
Mod.	Data Rate	NTX	CH.	Freq. (MHz)	99% Occupied BW (MHz)		6dB BW (MHz)		6dB BW Limit (MHz)	Pass/Fail
					Ant 1	Ant 2	Ant 1	Ant 2		
11b	1Mbps	1	1	2412	13.45	-	8.52	-	0.50	Pass
11b	1Mbps	1	6	2437	13.90	-	8.02	-	0.50	Pass
11b	1Mbps	1	11	2462	13.80	-	9.02	-	0.50	Pass
11g	6Mbps	1	1	2412	17.15	-	16.32	-	0.50	Pass
11g	6Mbps	1	6	2437	19.60	-	16.32	-	0.50	Pass
11g	6Mbps	1	11	2462	17.15	-	16.32	-	0.50	Pass
VHT20	MCS0	1	1	2412	18.30	-	17.56	-	0.50	Pass
VHT20	MCS0	1	6	2437	19.75	-	17.52	-	0.50	Pass
VHT20	MCS0	1	11	2462	18.30	-	17.54	-	0.50	Pass
VHT40	MCS0	1	3	2422	36.10	-	35.09	-	0.50	Pass
VHT40	MCS0	1	6	2437	36.20	-	35.04	-	0.50	Pass
VHT40	MCS0	1	9	2452	36.20	-	35.08	-	0.50	Pass
11b	1Mbps	2	1	2412	12.80	12.80	8.00	8.06	0.50	Pass
11b	1Mbps	2	6	2437	13.70	14.05	8.52	9.00	0.50	Pass
11b	1Mbps	2	11	2462	13.05	12.90	8.00	8.04	0.50	Pass
11g	6Mbps	2	1	2412	17.10	17.20	16.32	16.36	0.50	Pass
11g	6Mbps	2	6	2437	18.05	19.20	16.32	16.32	0.50	Pass
11g	6Mbps	2	11	2462	17.15	17.15	16.32	16.32	0.50	Pass
VHT20	MCS0	2	1	2412	18.20	18.30	17.56	17.56	0.50	Pass
VHT20	MCS0	2	6	2437	18.85	19.80	17.56	17.56	0.50	Pass
VHT20	MCS0	2	11	2462	18.30	18.30	17.56	17.58	0.50	Pass
VHT40	MCS0	2	3	2422	36.20	36.10	35.34	35.04	0.50	Pass
VHT40	MCS0	2	6	2437	36.10	36.10	35.12	35.12	0.50	Pass
VHT40	MCS0	2	9	2452	36.20	36.30	35.04	35.08	0.50	Pass

TEST RESULTS DATA
Peak Output Power

2.4GHz Band											
Mod.	Data Rate	NTX	CH.	Freq. (MHz)	Peak Conducted Power (dBm)			DG (dBi)		EIRP Power (dBm)	
					Ant 1	Ant 2	SUM	Ant 1	Ant 2	Ant 1	Ant 2
11b	1Mbps	1	1	2412	23.13	-	-	1.70	-	24.83	-
11b	1Mbps	1	6	2437	23.77	-	-	1.70	-	25.47	-
11b	1Mbps	1	11	2462	23.51	-	-	1.70	-	25.21	-
11g	6Mbps	1	1	2412	23.76	-	-	1.70	-	25.46	-
11g	6Mbps	1	2	2417	24.54	-	-	1.70	-	26.24	-
11g	6Mbps	1	3	2422	24.93	-	-	1.70	-	26.63	-
11g	6Mbps	1	6	2437	25.50	-	-	1.70	-	27.20	-
11g	6Mbps	1	9	2452	25.34	-	-	1.70	-	27.04	-
11g	6Mbps	1	10	2457	24.57	-	-	1.70	-	26.27	-
11g	6Mbps	1	11	2462	23.78	-	-	1.70	-	25.48	-
HT20	MCS0	1	1	2412	23.52	-	-	1.70	-	25.22	-
HT20	MCS0	1	6	2437	25.39	-	-	1.70	-	27.09	-
HT20	MCS0	1	11	2462	23.70	-	-	1.70	-	25.40	-
HT40	MCS0	1	3	2422	22.40	-	-	1.70	-	24.10	-
HT40	MCS0	1	6	2437	23.91	-	-	1.70	-	25.61	-
HT40	MCS0	1	9	2452	23.51	-	-	1.70	-	25.21	-
VHT20	MCS0	1	1	2412	23.67	-	-	1.70	-	25.37	-
VHT20	MCS0	1	2	2417	23.92	-	-	1.70	-	25.62	-
VHT20	MCS0	1	3	2422	24.91	-	-	1.70	-	26.61	-
VHT20	MCS0	1	6	2437	25.45	-	-	1.70	-	27.15	-
VHT20	MCS0	1	9	2452	25.12	-	-	1.70	-	26.82	-
VHT20	MCS0	1	10	2457	24.22	-	-	1.70	-	25.92	-
VHT20	MCS0	1	11	2462	23.81	-	-	1.70	-	25.51	-
VHT40	MCS0	1	3	2422	22.57	-	-	1.70	-	24.27	-
VHT40	MCS0	1	4	2427	22.92	-	-	1.70	-	24.62	-
VHT40	MCS0	1	5	2432	23.78	-	-	1.70	-	25.48	-
VHT40	MCS0	1	6	2437	23.99	-	-	1.70	-	25.69	-
VHT40	MCS0	1	7	2442	24.75	-	-	1.70	-	26.45	-
VHT40	MCS0	1	8	2447	24.24	-	-	1.70	-	25.94	-
VHT40	MCS0	1	9	2452	23.56	-	-	1.70	-	25.26	-

11b	1Mbps	2	1	2412	20.60	20.82	23.72	1.90	25.62
11b	1Mbps	2	2	2417	22.57	22.79	25.69	1.90	27.59
11b	1Mbps	2	3	2422	23.40	23.28	26.35	1.90	28.25
11b	1Mbps	2	6	2437	23.48	23.36	26.43	1.90	28.33
11b	1Mbps	2	9	2452	23.34	23.31	26.34	1.90	28.24
11b	1Mbps	2	10	2457	22.88	22.86	25.88	1.90	27.78
11b	1Mbps	2	11	2462	21.15	21.21	24.19	1.90	26.09
11g	6Mbps	2	1	2412	22.94	22.67	25.82	1.90	27.72
11g	6Mbps	2	2	2417	23.34	22.99	26.18	1.90	28.08
11g	6Mbps	2	3	2422	24.44	23.92	27.20	1.90	29.10
11g	6Mbps	2	6	2437	25.39	24.73	28.08	1.90	29.98
11g	6Mbps	2	9	2452	24.40	23.90	27.17	1.90	29.07
11g	6Mbps	2	10	2457	23.92	23.77	26.86	1.90	28.76
11g	6Mbps	2	11	2462	22.95	22.81	25.89	1.90	27.79
HT20	MCS0	2	1	2412	23.42	22.91	26.18	1.90	28.08
HT20	MCS0	2	6	2437	25.26	24.64	27.97	1.90	29.87
HT20	MCS0	2	11	2462	22.78	22.56	25.68	1.90	27.58
HT40	MCS0	2	3	2422	18.90	18.89	21.91	1.90	23.81
HT40	MCS0	2	6	2437	23.34	22.90	26.14	1.90	28.04
HT40	MCS0	2	9	2452	22.91	22.62	25.78	1.90	27.68
VHT20	MCS0	2	1	2412	23.47	22.95	26.23	1.90	28.13
VHT20	MCS0	2	2	2417	23.79	23.56	26.69	1.90	28.59
VHT20	MCS0	2	3	2422	24.92	24.47	27.71	1.90	29.61
VHT20	MCS0	2	6	2437	25.30	24.71	28.03	1.90	29.93
VHT20	MCS0	2	9	2452	24.57	24.24	27.42	1.90	29.32
VHT20	MCS0	2	10	2457	23.90	23.78	26.85	1.90	28.75
VHT20	MCS0	2	11	2462	22.90	22.61	25.77	1.90	27.67
VHT40	MCS0	2	3	2422	18.92	18.94	21.94	1.90	23.84
VHT40	MCS0	2	4	2427	22.46	22.02	25.26	1.90	27.16
VHT40	MCS0	2	5	2432	22.92	22.50	25.73	1.90	27.63
VHT40	MCS0	2	6	2437	23.51	22.91	26.23	1.90	28.13
VHT40	MCS0	2	9	2452	22.92	22.77	25.86	1.90	27.76

Note: Measured power (dBm) has offset with cable loss.

TEST RESULTS DATA
Average Output Power

2.4GHz Band																		
Mod.	Data Rate	Ntx	CH.	Freq. (MHz)	Duty Factor (dB)		Average Conducted Power (dBm)			Conducted Power Limit (dBm)		DG (dBi)		EIRP Power (dBm)		EIRP Power Limit (dBm)		Pass /Fail
					Ant 1	Ant 2	Ant 1	Ant 2	SUM	Ant 1	Ant 2	Ant 1	Ant 2	Ant 1	Ant 2	Ant 1	Ant 2	
11b	1Mbps	1	1	2412	0.04	-	20.99	-	-	30.00	-	1.70	-	22.69	-	36.00	-	Pass
11b	1Mbps	1	6	2437	0.04	-	21.76	-	-	30.00	-	1.70	-	23.46	-	36.00	-	Pass
11b	1Mbps	1	11	2462	0.04	-	21.49	-	-	30.00	-	1.70	-	23.19	-	36.00	-	Pass
11g	6Mbps	1	1	2412	0.21	-	15.66	-	-	30.00	-	1.70	-	17.36	-	36.00	-	Pass
11g	6Mbps	1	2	2417	0.21	-	18.44	-	-	30.00	-	1.70	-	20.14	-	36.00	-	Pass
11g	6Mbps	1	3	2422	0.21	-	19.92	-	-	30.00	-	1.70	-	21.62	-	36.00	-	Pass
11g	6Mbps	1	6	2437	0.21	-	20.75	-	-	30.00	-	1.70	-	22.45	-	36.00	-	Pass
11g	6Mbps	1	9	2452	0.21	-	20.96	-	-	30.00	-	1.70	-	22.66	-	36.00	-	Pass
11g	6Mbps	1	10	2457	0.21	-	18.85	-	-	30.00	-	1.70	-	20.55	-	36.00	-	Pass
11g	6Mbps	1	11	2462	0.21	-	15.95	-	-	30.00	-	1.70	-	17.65	-	36.00	-	Pass
HT20	MCS0	1	1	2412	0.10	-	15.54	-	-	30.00	-	1.70	-	17.24	-	36.00	-	Pass
HT20	MCS0	1	6	2437	0.10	-	20.71	-	-	30.00	-	1.70	-	22.41	-	36.00	-	Pass
HT20	MCS0	1	11	2462	0.10	-	16.19	-	-	30.00	-	1.70	-	17.89	-	36.00	-	Pass
HT40	MCS0	1	3	2422	0.18	-	13.11	-	-	30.00	-	1.70	-	14.81	-	36.00	-	Pass
HT40	MCS0	1	6	2437	0.18	-	16.81	-	-	30.00	-	1.70	-	18.51	-	36.00	-	Pass
HT40	MCS0	1	9	2452	0.18	-	15.26	-	-	30.00	-	1.70	-	16.96	-	36.00	-	Pass
VHT20	MCS0	1	1	2412	0.56	-	15.86	-	-	30.00	-	1.70	-	17.56	-	36.00	-	Pass
VHT20	MCS0	1	2	2417	0.56	-	16.90	-	-	30.00	-	1.70	-	18.60	-	36.00	-	Pass
VHT20	MCS0	1	3	2422	0.56	-	18.80	-	-	30.00	-	1.70	-	20.50	-	36.00	-	Pass
VHT20	MCS0	1	6	2437	0.56	-	21.00	-	-	30.00	-	1.70	-	22.70	-	36.00	-	Pass
VHT20	MCS0	1	9	2452	0.56	-	19.86	-	-	30.00	-	1.70	-	21.56	-	36.00	-	Pass
VHT20	MCS0	1	10	2457	0.56	-	17.91	-	-	30.00	-	1.70	-	19.61	-	36.00	-	Pass
VHT20	MCS0	1	11	2462	0.56	-	16.61	-	-	30.00	-	1.70	-	18.31	-	36.00	-	Pass
VHT40	MCS0	1	3	2422	1.06	-	13.53	-	-	30.00	-	1.70	-	15.23	-	36.00	-	Pass
VHT40	MCS0	1	4	2427	1.06	-	14.55	-	-	30.00	-	1.70	-	16.25	-	36.00	-	Pass
VHT40	MCS0	1	5	2432	1.06	-	15.58	-	-	30.00	-	1.70	-	17.28	-	36.00	-	Pass
VHT40	MCS0	1	6	2437	1.06	-	16.83	-	-	30.00	-	1.70	-	18.53	-	36.00	-	Pass
VHT40	MCS0	1	7	2442	1.06	-	16.08	-	-	30.00	-	1.70	-	17.78	-	36.00	-	Pass
VHT40	MCS0	1	8	2447	1.06	-	15.83	-	-	30.00	-	1.70	-	17.53	-	36.00	-	Pass
VHT40	MCS0	1	9	2452	1.06	-	15.94	-	-	30.00	-	1.70	-	17.64	-	36.00	-	Pass

11b	1Mbps	2	1	2412	0.04	0.04	18.21	18.44	21.34	30.00	1.90	23.24	36.00	Pass
11b	1Mbps	2	2	2417	0.04	0.04	20.15	20.61	23.40	30.00	1.90	25.30	36.00	Pass
11b	1Mbps	2	3	2422	0.04	0.04	21.26	21.24	24.26	30.00	1.90	26.16	36.00	Pass
11b	1Mbps	2	6	2437	0.04	0.04	21.43	21.34	24.40	30.00	1.90	26.30	36.00	Pass
11b	1Mbps	2	9	2452	0.04	0.04	21.36	21.21	24.30	30.00	1.90	26.20	36.00	Pass
11b	1Mbps	2	10	2457	0.04	0.04	20.91	20.70	23.82	30.00	1.90	25.72	36.00	Pass
11b	1Mbps	2	11	2462	0.04	0.04	18.81	18.77	21.80	30.00	1.90	23.70	36.00	Pass
11g	6Mbps	2	1	2412	0.21	0.21	14.37	14.15	17.27	30.00	1.90	19.17	36.00	Pass
11g	6Mbps	2	2	2417	0.21	0.21	14.78	14.60	17.70	30.00	1.90	19.60	36.00	Pass
11g	6Mbps	2	3	2422	0.21	0.21	17.85	17.67	20.77	30.00	1.90	22.67	36.00	Pass
11g	6Mbps	2	6	2437	0.21	0.21	20.26	20.29	23.29	30.00	1.90	25.19	36.00	Pass
11g	6Mbps	2	9	2452	0.21	0.21	17.78	17.60	20.70	30.00	1.90	22.60	36.00	Pass
11g	6Mbps	2	10	2457	0.21	0.21	16.23	16.14	19.20	30.00	1.90	21.10	36.00	Pass
11g	6Mbps	2	11	2462	0.21	0.21	14.81	14.51	17.67	30.00	1.90	19.57	36.00	Pass
HT20	MCS0	2	1	2412	0.10	0.10	15.13	14.04	17.63	30.00	1.90	19.53	36.00	Pass
HT20	MCS0	2	6	2437	0.10	0.10	20.09	20.15	23.13	30.00	1.90	25.03	36.00	Pass
HT20	MCS0	2	11	2462	0.10	0.10	14.57	14.33	17.47	30.00	1.90	19.37	36.00	Pass
HT40	MCS0	2	3	2422	0.18	0.18	9.49	9.49	12.50	30.00	1.90	14.40	36.00	Pass
HT40	MCS0	2	6	2437	0.18	0.18	14.89	14.52	17.72	30.00	1.90	19.62	36.00	Pass
HT40	MCS0	2	9	2452	0.18	0.18	14.50	13.95	17.24	30.00	1.90	19.14	36.00	Pass
VHT20	MCS0	2	1	2412	0.53	0.53	15.44	15.14	18.30	30.00	1.90	20.20	36.00	Pass
VHT20	MCS0	2	2	2417	0.53	0.53	15.95	15.64	18.81	30.00	1.90	20.71	36.00	Pass
VHT20	MCS0	2	3	2422	0.53	0.53	19.42	19.21	22.32	30.00	1.90	24.22	36.00	Pass
VHT20	MCS0	2	6	2437	0.53	0.53	20.43	20.50	23.47	30.00	1.90	25.37	36.00	Pass
VHT20	MCS0	2	9	2452	0.53	0.53	18.88	18.87	21.88	30.00	1.90	23.78	36.00	Pass
VHT20	MCS0	2	10	2457	0.53	0.53	16.98	16.88	19.94	30.00	1.90	21.84	36.00	Pass
VHT20	MCS0	2	11	2462	0.53	0.53	14.91	14.59	17.76	30.00	1.90	19.66	36.00	Pass
VHT40	MCS0	2	3	2422	1.05	1.05	9.51	9.51	12.52	30.00	1.90	14.42	36.00	Pass
VHT40	MCS0	2	4	2427	1.05	1.05	14.96	14.95	17.96	30.00	1.90	19.86	36.00	Pass
VHT40	MCS0	2	5	2432	1.05	1.05	15.51	15.56	18.54	30.00	1.90	20.44	36.00	Pass
VHT40	MCS0	2	6	2437	1.05	1.05	15.02	14.65	17.85	30.00	1.90	19.75	36.00	Pass
VHT40	MCS0	2	9	2452	1.05	1.05	14.59	14.03	17.33	30.00	1.90	19.23	36.00	Pass

Note: Measured power (dBm) has offset with cable loss.

TEST RESULTS DATA
Average Power Spectral Density

2.4GHz Band												
Mod.	Data Rate	N _{Tx}	CH.	Freq. (MHz)	Average PSD (dBm/3kHz)			DG (dBi)		Average PSD Limit (dBm/3kHz)		Pass/Fail
					Ant 1	Ant 2	Worse + 3.01	Ant 1	Ant 2	Ant 1	Ant 2	
11b	1Mbps	1	1	2412	-5.35	-		1.70	1.90	8.00	8.00	Pass
11b	1Mbps	1	6	2437	-4.34	-		1.70	1.90	8.00	8.00	Pass
11b	1Mbps	1	11	2462	-5.13	-		1.70	1.90	8.00	8.00	Pass
11g	6Mbps	1	1	2412	-13.68	-		1.70	1.90	8.00	8.00	Pass
11g	6Mbps	1	6	2437	-8.64	-		1.70	1.90	8.00	8.00	Pass
11g	6Mbps	1	11	2462	-13.49	-		1.70	1.90	8.00	8.00	Pass
VHT20	MCS0	1	1	2412	-14.21	-		1.70	1.90	8.00	8.00	Pass
VHT20	MCS0	1	6	2437	-9.11	-		1.70	1.90	8.00	8.00	Pass
VHT20	MCS0	1	11	2462	-13.85	-		1.70	1.90	8.00	8.00	Pass
VHT40	MCS0	1	3	2422	-19.18	-		1.70	1.90	8.00	8.00	Pass
VHT40	MCS0	1	6	2437	-15.73	-	1.70	1.90	8.00	8.00	Pass	
VHT40	MCS0	1	9	2452	-17.11	-	1.70	1.90	8.00	8.00	Pass	
11b	1Mbps	2	1	2412	-7.75	-7.61	-4.60	4.81		8.00		Pass
11b	1Mbps	2	6	2437	-4.90	-4.72	-1.71	4.81		8.00		Pass
11b	1Mbps	2	11	2462	-7.20	-7.46	-4.19	4.81		8.00		Pass
11g	6Mbps	2	1	2412	-15.02	-14.96	-11.95	4.81		8.00		Pass
11g	6Mbps	2	6	2437	-9.21	-9.01	-6.00	4.81		8.00		Pass
11g	6Mbps	2	11	2462	-14.87	-14.93	-11.86	4.81		8.00		Pass
VHT20	MCS0	2	1	2412	-14.17	-14.39	-11.16	4.81		8.00		Pass
VHT20	MCS0	2	6	2437	-9.77	-9.73	-6.72	4.81		8.00		Pass
VHT20	MCS0	2	11	2462	-14.85	-15.36	-11.84	4.81		8.00		Pass
VHT40	MCS0	2	3	2422	-22.94	-22.76	-19.75	4.81		8.00		Pass
VHT40	MCS0	2	6	2437	-17.15	-17.33	-14.14	4.81		8.00		Pass
VHT40	MCS0	2	9	2452	-18.10	-18.36	-15.09	4.81		8.00		Pass

Measured power density (dBm) has offset with cable loss.

<For TXBF Mode>

Test Engineer:	Kai Liao	Temperature:	21~25	°C
Test Date:	2018/2/22 ~ 2018/04/19	Relative Humidity:	51~54	%

TEST RESULTS DATA
6dB and 99% Occupied Bandwidth

2.4GHz Band										
Mod.	Data Rate	NTX	CH.	Freq. (MHz)	99% Occupied BW (MHz)		6dB BW (MHz)		6dB BW Limit (MHz)	Pass/Fail
					Ant 1	Ant 2	Ant 1	Ant 2		
VHT20	MCS0	2	1	2412	18.25	18.35	17.12	16.96	0.50	Pass
VHT20	MCS0	2	6	2437	18.35	18.30	17.36	16.68	0.50	Pass
VHT20	MCS0	2	11	2462	18.40	18.30	17.12	16.40	0.50	Pass
VHT40	MCS0	2	3	2422	36.50	36.20	35.48	34.66	0.50	Pass
VHT40	MCS0	2	6	2437	36.20	36.10	36.48	33.72	0.50	Pass
VHT40	MCS0	2	9	2452	36.00	36.50	34.92	35.84	0.50	Pass

TEST RESULTS DATA
Average Output Power

2.4GHz Band																		
Mod.	Data Rate	Ntx	CH.	Freq. (MHz)	Duty Factor (dB)		Average Conducted Power (dBm)			Conducted Power Limit (dBm)		DG (dBi)		EIRP Power (dBm)		EIRP Power Limit (dBm)		Pass /Fail
					Ant 1	Ant 2	Ant 1	Ant 2	SUM	Ant 1	Ant 2	Ant 1	Ant 2	Ant 1	Ant 2	Ant 1	Ant 2	
HT20	MCS0	2	1	2412	0.00	0.00	12.20	12.80	15.52	30.00		4.81		20.33		36.00	Pass	
HT20	MCS0	2	6	2437	0.00	0.00	17.20	17.20	20.21	30.00		4.81		25.02		36.00	Pass	
HT20	MCS0	2	11	2462	0.00	0.00	15.80	15.50	18.66	30.00		4.81		23.47		36.00	Pass	
HT40	MCS0	2	3	2422	0.00	0.00	10.00	10.80	13.43	30.00		4.81		18.24		36.00	Pass	
HT40	MCS0	2	6	2437	0.00	0.00	17.30	16.90	20.11	30.00		4.81		24.93		36.00	Pass	
HT40	MCS0	2	9	2452	0.00	0.00	13.70	14.10	16.91	30.00		4.81		21.73		36.00	Pass	
VHT20	MCS0	2	1	2412	0.00	0.00	12.40	12.90	15.67	30.00		4.81		20.48		36.00	Pass	
VHT20	MCS0	2	2	2417	0.00	0.00	16.60	16.70	19.66	30.00		4.81		24.47		36.00	Pass	
VHT20	MCS0	2	3	2422	0.00	0.00	17.20	17.20	20.21	30.00		4.81		25.02		36.00	Pass	
VHT20	MCS0	2	6	2437	0.00	0.00	17.30	17.40	20.36	30.00		4.81		25.17		36.00	Pass	
VHT20	MCS0	2	11	2462	0.00	0.00	15.90	15.70	18.81	30.00		4.81		23.62		36.00	Pass	
VHT40	MCS0	2	3	2422	0.00	0.00	10.10	10.90	13.53	30.00		4.81		18.34		36.00	Pass	
VHT40	MCS0	2	4	2427	0.00	0.00	13.10	14.10	16.64	30.00		4.81		21.45		36.00	Pass	
VHT40	MCS0	2	5	2432	0.00	0.00	14.10	15.00	17.58	30.00		4.81		22.39		36.00	Pass	
VHT40	MCS0	2	6	2437	0.00	0.00	17.40	17.00	20.21	30.00		4.81		25.03		36.00	Pass	
VHT40	MCS0	2	7	2442	0.00	0.00	18.40	17.80	21.12	30.00		4.81		25.93		36.00	Pass	
VHT40	MCS0	2	8	2447	0.00	0.00	17.20	16.80	20.01	30.00		4.81		24.83		36.00	Pass	
VHT40	MCS0	2	9	2452	0.00	0.00	13.80	14.30	17.07	30.00		4.81		21.88		36.00	Pass	

Note: Measured power (dBm) has offset with cable loss.

TEST RESULTS DATA
Average Power Spectral Density

2.4GHz Band												
Mod.	Data Rate	N _{Tx}	CH.	Freq. (MHz)	Average PSD (dBm/3kHz)			DG (dBi)		Average PSD Limit (dBm/3kHz)		Pass/Fail
					Ant 1	Ant 2	Worse + 3.01	Ant 1	Ant 2	Ant 1	Ant 2	
VHT20	MCS0	2	1	2412	-7.63	-7.50	-4.49	4.81		8.00		Pass
VHT20	MCS0	2	6	2437	-2.16	-2.53	0.85	4.81		8.00		Pass
VHT20	MCS0	2	11	2462	-4.56	-4.89	-1.55	4.81		8.00		Pass
VHT40	MCS0	2	3	2422	-10.76	-10.14	-7.13	4.81		8.00		Pass
VHT40	MCS0	2	6	2437	-3.85	-3.94	-0.84	4.81		8.00		Pass
VHT40	MCS0	2	9	2452	-7.85	-7.30	-4.29	4.81		8.00		Pass

Measured power density (dBm) has offset with cable loss.



Appendix B. AC Conducted Emission Test Results

Test Engineer :	Shareef Yu	Temperature :	22~24°C
		Relative Humidity :	58~62%

EUT Information

Report NO : 811726
 Test Mode : Mode 1
 Test Voltage : 120Vac/60Hz
 Phase : Line

Full Spectrum

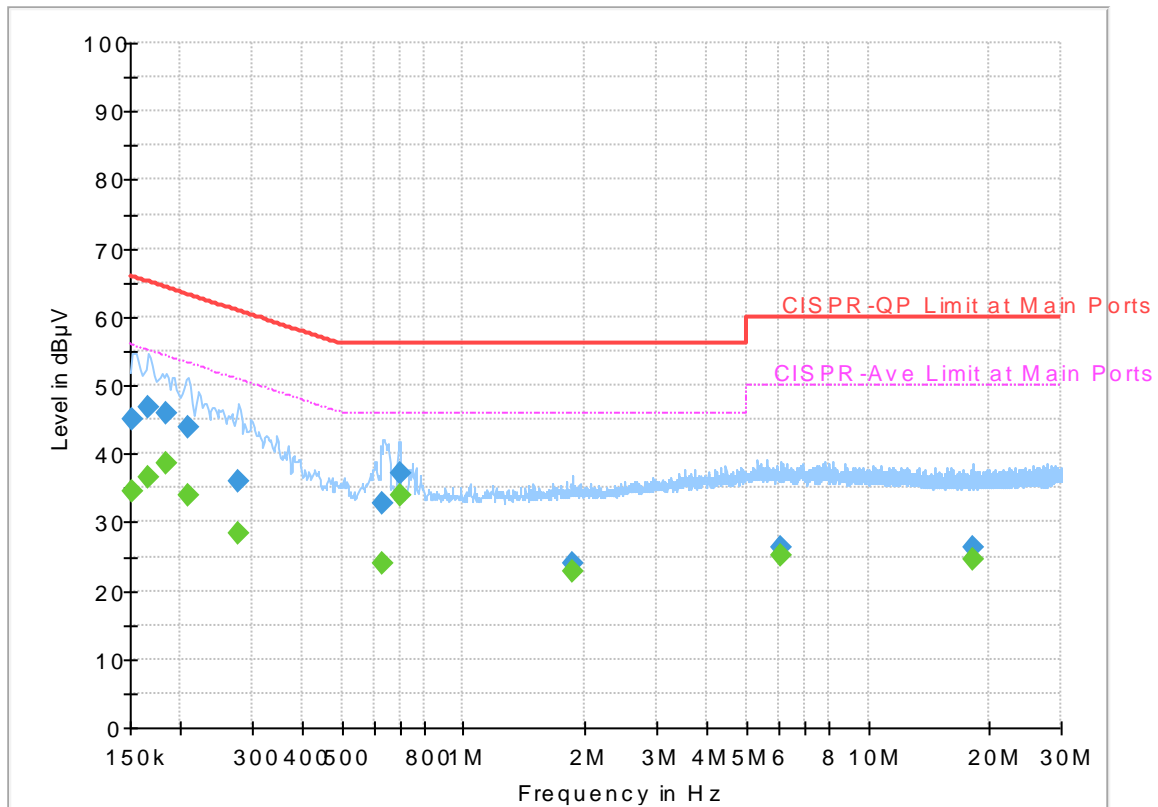

Final_Result

Frequency (MHz)	QuasiPeak (dBµV)	Average (dBµV)	Limit (dBµV)	Margin (dB)	Line	Filter	Corr. (dB)
0.152250	---	34.52	55.88	21.36	L1	OFF	19.5
0.152250	45.15	---	65.88	20.73	L1	OFF	19.5
0.165750	---	36.67	55.17	18.50	L1	OFF	19.5
0.165750	46.74	---	65.17	18.43	L1	OFF	19.5
0.183750	---	38.48	54.31	15.83	L1	OFF	19.5
0.183750	45.90	---	64.31	18.41	L1	OFF	19.5
0.208500	---	33.80	53.27	19.47	L1	OFF	19.5
0.208500	43.88	---	63.27	19.39	L1	OFF	19.5
0.278250	---	28.22	50.87	22.65	L1	OFF	19.5
0.278250	36.02	---	60.87	24.85	L1	OFF	19.5
0.633750	---	24.02	46.00	21.98	L1	OFF	19.5
0.633750	32.63	---	56.00	23.37	L1	OFF	19.5
0.694500	---	33.99	46.00	12.01	L1	OFF	19.5
0.694500	37.21	---	56.00	18.79	L1	OFF	19.5
1.855500	---	22.85	46.00	23.15	L1	OFF	19.6
1.855500	23.87	---	56.00	32.13	L1	OFF	19.6
6.105750	---	25.02	50.00	24.98	L1	OFF	19.6
6.105750	26.37	---	60.00	33.63	L1	OFF	19.6
18.096000	---	24.55	50.00	25.45	L1	OFF	19.8
18.096000	26.17	---	60.00	33.83	L1	OFF	19.8

EUT Information

Report NO : 811726
 Test Mode : Mode 1
 Test Voltage : 120Vac/60Hz
 Phase : Neutral

Full Spectrum

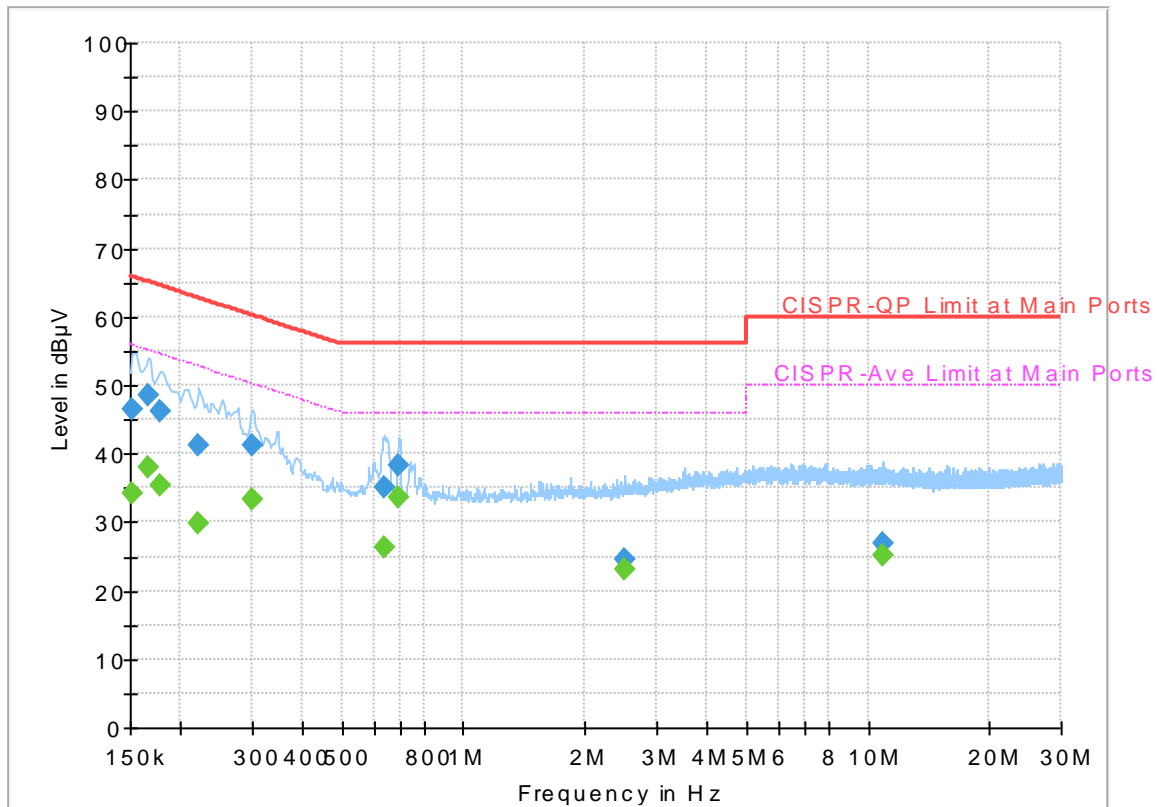

Final_Result

Frequency (MHz)	QuasiPeak (dBµV)	Average (dBµV)	Limit (dBµV)	Margin (dB)	Line	Filter	Corr. (dB)
0.152250	46.42	---	65.88	19.46	N	OFF	19.5
0.152250	---	34.20	55.88	21.68	N	OFF	19.5
0.165750	48.57	---	65.17	16.60	N	OFF	19.5
0.165750	---	37.88	55.17	17.29	N	OFF	19.5
0.177000	46.18	---	64.63	18.45	N	OFF	19.5
0.177000	---	35.37	54.63	19.26	N	OFF	19.5
0.222000	41.15	---	62.74	21.59	N	OFF	19.5
0.222000	---	29.96	52.74	22.78	N	OFF	19.5
0.300750	41.31	---	60.22	18.91	N	OFF	19.5
0.300750	---	33.37	50.22	16.85	N	OFF	19.5
0.638250	34.98	---	56.00	21.02	N	OFF	19.5
0.638250	---	26.19	46.00	19.81	N	OFF	19.5
0.690000	38.37	---	56.00	17.63	N	OFF	19.5
0.690000	---	33.49	46.00	12.51	N	OFF	19.5
2.505750	24.49	---	56.00	31.51	N	OFF	19.5
2.505750	---	23.21	46.00	22.79	N	OFF	19.5
10.871250	26.79	---	60.00	33.21	N	OFF	19.7
10.871250	---	25.06	50.00	24.94	N	OFF	19.7



Appendix C. Radiated Spurious Emission

Test Engineer :	Ken Wu, Jacky Hung, and Hao Hsu	Temperature :	22~24°C
		Relative Humidity :	48~52%

<Single Mode>

2.4GHz 2400~2483.5MHz

WIFI 802.11b (Band Edge @ 3m)

WIFI Ant.	Note	Frequency (MHz)	Level (dBμV/m)	Over Limit (dB)	Limit Line (dBμV/m)	Read Level (dBμV)	Antenna Factor (dB/m)	Path Loss (dB)	Preamp Factor (dB)	Ant Pos (cm)	Table Pos (deg)	Peak Avg. (P/A)	Pol. (H/V)	
802.11b CH 01 2412MHz		2387.175	56.37	-17.63	74	46.55	27.13	16.29	33.6	274	218	P	H	
		2387.175	50.77	-3.23	54	40.95	27.13	16.29	33.6	274	218	A	H	
	*	2412	108.61	-	-	98.72	27.18	16.3	33.59	274	218	P	H	
	*	2412	105.45	-	-	95.56	27.18	16.3	33.59	274	218	A	H	
													H	
														H
			2387.175	58.72	-15.28	74	48.9	27.13	16.29	33.6	173	150	P	V
			2387.175	52.9	-1.1	54	43.08	27.13	16.29	33.6	173	150	A	V
	*		2412	111.71	-	-	101.82	27.18	16.3	33.59	173	150	P	V
	*		2412	108.57	-	-	98.68	27.18	16.3	33.59	173	150	A	V
														V
														V
802.11b CH 06 2437MHz		2389.52	52.03	-21.97	74	42.21	27.13	16.29	33.6	268	222	P	H	
		2388.56	43.49	-10.51	54	33.67	27.13	16.29	33.6	268	222	A	H	
	*	2437	111.43	-	-	101.44	27.27	16.31	33.59	268	222	P	H	
	*	2437	108.32	-	-	98.33	27.27	16.31	33.59	268	222	A	H	
			2488.88	53.03	-20.97	74	42.89	27.4	16.32	33.58	268	222	P	H
			2485.68	45.04	-8.96	54	34.94	27.36	16.32	33.58	268	222	A	H
			2386.96	53.88	-20.12	74	44.06	27.13	16.29	33.6	147	144	P	V
			2388.4	46.89	-7.11	54	37.07	27.13	16.29	33.6	147	144	A	V
	*		2437	113.09	-	-	103.1	27.27	16.31	33.59	147	144	P	V
	*		2437	110.05	-	-	100.06	27.27	16.31	33.59	147	144	A	V
			2487.04	54.81	-19.19	74	44.71	27.36	16.32	33.58	147	144	P	V
			2485.6	47.51	-6.49	54	37.41	27.36	16.32	33.58	147	144	A	V



802.11b CH 11 2462MHz	*	2462	111.17	-	-	101.13	27.31	16.31	33.58	294	217	P	H
	*	2462	107.97	-	-	97.93	27.31	16.31	33.58	294	217	A	H
		2487.52	56.16	-17.84	74	46.02	27.4	16.32	33.58	294	217	P	H
		2487.36	49.77	-4.23	54	39.67	27.36	16.32	33.58	294	217	A	H
													H
													H
	*	2462	112.04	-	-	102	27.31	16.31	33.58	147	155	P	V
	*	2462	108.89	-	-	98.85	27.31	16.31	33.58	147	155	A	V
		2487.68	58.26	-15.74	74	48.12	27.4	16.32	33.58	147	155	P	V
		2487.52	52.43	-1.57	54	42.29	27.4	16.32	33.58	147	155	A	V
													V
													V
Remark	<ol style="list-style-type: none"> 1. No other spurious found. 2. All results are PASS against Peak and Average limit line. 												



**2.4GHz 2400~2483.5MHz
WIFI 802.11b (Harmonic @ 3m)**

WIFI Ant. 1	Note	Frequency (MHz)	Level (dBµV/m)	Over Limit (dB)	Limit Line (dBµV/m)	Read Level (dBµV)	Antenna Factor (dB/m)	Path Loss (dB)	Preamp Factor (dB)	Ant Pos (cm)	Table Pos (deg)	Peak Avg. (P/A)	Pol. (H/V)	
802.11b CH 01 2412MHz		4824	39.36	-34.64	74	62.79	31.29	10.02	64.74	100	0	P	H	
		9648	54.38	-34.23	88.61	67.2	38.86	13.52	65.2	100	0	P	H	
													H	
													H	
		4824	39.42	-34.58	74	62.85	31.29	10.02	64.74	100	0	P	V	
		9648	58.44	-33.27	91.71	71.26	38.86	13.52	65.2	100	0	P	V	
														V
														V
802.11b CH 06 2437MHz		4874	39.67	-34.33	74	63	31.38	9.99	64.7	100	0	P	H	
		7311	45.45	-28.55	74	62.22	36.28	11.77	64.82	100	0	P	H	
		9748	69.28	-22.15	91.43	81.69	38.9	13.89	65.2	170	79	P	H	
		12185	54.04	-19.96	74	64.46	38.73	16.09	65.24	100	179	P	H	
		4874	39.39	-34.61	74	62.72	31.38	9.99	64.7	100	0	P	V	
		7311	43.23	-30.77	74	60	36.28	11.77	64.82	100	0	P	V	
		9748	66.05	-27.04	93.09	78.46	38.9	13.89	65.2	326	103	P	V	
		12185	55.54	-18.46	74	65.96	38.73	16.09	65.24	181	155	P	V	
802.11b CH 11 2462MHz		4924	40.26	-33.74	74	63.45	31.48	9.99	64.66	100	0	P	H	
		7386	45.12	-28.88	74	61.83	36.47	11.68	64.86	100	0	P	H	
		9848	63.72	-27.45	91.17	75.8	38.94	14.18	65.2	182	80	P	H	
													H	
		4924	39.89	-34.11	74	63.08	31.48	9.99	64.66	100	0	P	V	
		7386	42.46	-31.54	74	59.17	36.47	11.68	64.86	100	0	P	V	
		9848	59.81	-32.23	92.04	71.89	38.94	14.18	65.2	329	103	P	V	
														V
Remark	1. No other spurious found. 2. All results are PASS against Peak and Average limit line.													



2.4GHz 2400~2483.5MHz
WIFI 802.11g (Band Edge @ 3m)

WIFI Ant. 1	Note	Frequency (MHz)	Level (dBμV/m)	Over Limit (dB)	Limit Line (dBμV/m)	Read Level (dBμV)	Antenna Factor (dB/m)	Path Loss (dB)	Preamp Factor (dB)	Ant Pos (cm)	Table Pos (deg)	Peak Avg. (P/A)	Pol. (H/V)	
802.11g CH 01 2412MHz		2389.695	61.63	-12.37	74	51.81	27.13	16.29	33.6	275	219	P	H	
		2390	50.78	-3.22	54	40.95	27.13	16.29	33.59	275	219	A	H	
	*	2412	105.97	-	-	96.08	27.18	16.3	33.59	275	219	P	H	
	*	2412	96.88	-	-	86.99	27.18	16.3	33.59	275	219	A	H	
													H	
														H
			2389.38	62.79	-11.21	74	52.97	27.13	16.29	33.6	174	149	P	V
			2390	52.28	-1.72	54	42.45	27.13	16.29	33.59	174	149	A	V
	*		2412	107.97	-	-	98.08	27.18	16.3	33.59	174	149	P	V
	*		2412	100.21	-	-	90.32	27.18	16.3	33.59	174	149	A	V
														V
														V
802.11g CH 06 2437MHz		2388.24	54.45	-19.55	74	44.63	27.13	16.29	33.6	266	222	P	H	
		2389.84	44.38	-9.62	54	34.55	27.13	16.29	33.59	266	222	A	H	
	*	2437	110.89	-	-	100.9	27.27	16.31	33.59	266	222	P	H	
	*	2437	103.25	-	-	93.26	27.27	16.31	33.59	266	222	A	H	
			2483.76	57.13	-16.87	74	47.04	27.36	16.31	33.58	266	222	P	H
			2484.8	45.58	-8.42	54	35.48	27.36	16.32	33.58	266	222	A	H
			2388.24	62	-12	74	52.18	27.13	16.29	33.6	146	144	P	V
			2388.72	49.18	-4.82	54	39.36	27.13	16.29	33.6	146	144	A	V
	*		2437	113.16	-	-	103.17	27.27	16.31	33.59	146	144	P	V
	*		2437	105.32	-	-	95.33	27.27	16.31	33.59	146	144	A	V
			2487.12	60.67	-13.33	74	50.57	27.36	16.32	33.58	146	144	P	V
			2483.6	48.06	-5.94	54	37.97	27.36	16.31	33.58	146	144	A	V



802.11g CH 11 2462MHz	*	2462	107.96	-	-	97.92	27.31	16.31	33.58	294	216	P	H
	*	2462	99.1	-	-	89.06	27.31	16.31	33.58	294	216	A	H
		2485.12	61.42	-12.58	74	51.32	27.36	16.32	33.58	294	216	P	H
		2483.76	49.52	-4.48	54	39.43	27.36	16.31	33.58	294	216	A	H
													H
													H
	*	2462	109.24	-	-	99.2	27.31	16.31	33.58	139	143	P	V
	*	2462	99.93	-	-	89.89	27.31	16.31	33.58	139	143	A	V
		2484.92	63.89	-10.11	74	53.79	27.36	16.32	33.58	139	143	P	V
		2483.72	51.73	-2.27	54	41.64	27.36	16.31	33.58	139	143	A	V
													V
													V
Remark	<ol style="list-style-type: none"> 1. No other spurious found. 2. All results are PASS against Peak and Average limit line. 												



**2.4GHz 2400~2483.5MHz
WIFI 802.11g (Harmonic @ 3m)**

WIFI Ant. 1	Note	Frequency (MHz)	Level (dBμV/m)	Over Limit (dB)	Limit Line (dBμV/m)	Read Level (dBμV)	Antenna Factor (dB/m)	Path Loss (dB)	Preamp Factor (dB)	Ant Pos (cm)	Table Pos (deg)	Peak Avg. (P/A)	Pol. (H/V)	
802.11g CH 01 2412MHz		4824	38.3	-35.7	74	61.73	31.29	10.02	64.74	100	0	P	H	
													H	
													H	
													H	
			4824	39.12	-34.88	74	62.55	31.29	10.02	64.74	100	0	P	V
														V
														V
802.11g CH 06 2437MHz		4874	38.86	-35.14	74	62.19	31.38	9.99	64.7	100	0	P	H	
		7311	43.64	-30.36	74	60.41	36.28	11.77	64.82	100	0	P	H	
		9748	63.91	-26.98	90.89	76.32	38.9	13.89	65.2	189	82	P	H	
													H	
			4874	38.75	-35.25	74	62.08	31.38	9.99	64.7	100	0	P	V
			7311	42.01	-31.99	74	58.78	36.28	11.77	64.82	100	0	P	V
			9748	58.42	-34.74	93.16	70.83	38.9	13.89	65.2	105	79	P	V
802.11g CH 11 2462MHz		4924	39.41	-34.59	74	62.6	31.48	9.99	64.66	100	0	P	H	
		7386	41.5	-32.5	74	58.21	36.47	11.68	64.86	100	0	P	H	
													H	
													H	
			4924	39.26	-34.74	74	62.45	31.48	9.99	64.66	100	0	P	V
			7386	41.28	-32.72	74	57.99	36.47	11.68	64.86	100	0	P	V
														V
Remark	1. No other spurious found.													
	2. All results are PASS against Peak and Average limit line.													



**2.4GHz 2400~2483.5MHz
WIFI 802.11ac VHT20 (Band Edge @ 3m)**

WIFI Ant. 1	Note	Frequency (MHz)	Level (dBμV/m)	Over Limit (dB)	Limit Line (dBμV/m)	Read Level (dBμV)	Antenna Factor (dB/m)	Path Loss (dB)	Preamp Factor (dB)	Ant Pos (cm)	Table Pos (deg)	Peak Avg. (P/A)	Pol. (H/V)	
802.11ac VHT20 CH 01 2412MHz		2389.695	61.55	-12.45	74	51.73	27.13	16.29	33.6	307	217	P	H	
		2390	48.83	-5.17	54	39	27.13	16.29	33.59	307	217	A	H	
	*	2412	104.97	-	-	95.08	27.18	16.3	33.59	307	217	P	H	
	*	2412	96.79	-	-	86.9	27.18	16.3	33.59	307	217	A	H	
													H	
														H
			2389.38	65.22	-8.78	74	55.4	27.13	16.29	33.6	173	151	P	V
			2390	51.71	-2.29	54	41.88	27.13	16.29	33.59	173	151	A	V
		*	2412	108.18	-	-	98.29	27.18	16.3	33.59	173	151	P	V
		*	2412	99.5	-	-	89.61	27.18	16.3	33.59	173	151	A	V
													V	
													V	
802.11ac VHT20 CH 06 2437MHz		2388.12	58.82	-15.18	74	49	27.13	16.29	33.6	268	223	P	H	
		2389.94	44.97	-9.03	54	35.14	27.13	16.29	33.59	268	223	A	H	
		* 2437	111.08	-	-	101.09	27.27	16.31	33.59	268	223	P	H	
		* 2437	102.89	-	-	92.9	27.27	16.31	33.59	268	223	A	H	
			2483.55	57.97	-16.03	74	47.88	27.36	16.31	33.58	268	223	P	H
			2483.76	45.72	-8.28	54	35.63	27.36	16.31	33.58	268	223	A	H
			2389.94	62.17	-11.83	74	52.34	27.13	16.29	33.59	145	143	P	V
			2389.94	48.66	-5.34	54	38.83	27.13	16.29	33.59	145	143	A	V
		*	2437	112.76	-	-	102.77	27.27	16.31	33.59	145	143	P	V
		*	2437	104.96	-	-	94.97	27.27	16.31	33.59	145	143	A	V
		2483.55	60.45	-13.55	74	50.36	27.36	16.31	33.58	145	143	P	V	
		2483.52	48.39	-5.61	54	38.3	27.36	16.31	33.58	145	143	A	V	



802.11ac VHT20 CH 11 2462MHz	*	2462	107.29	-	-	97.25	27.31	16.31	33.58	294	219	P	H
	*	2462	99.36	-	-	89.32	27.31	16.31	33.58	294	219	A	H
		2484.68	62.19	-11.81	74	52.09	27.36	16.32	33.58	294	219	P	H
		2483.52	50.18	-3.82	54	40.09	27.36	16.31	33.58	294	219	A	H
													H
													H
	*	2462	107.51	-	-	97.47	27.31	16.31	33.58	139	144	P	V
	*	2462	99.79	-	-	89.75	27.31	16.31	33.58	139	144	A	V
		2484.08	65.09	-8.91	74	55	27.36	16.31	33.58	139	144	P	V
		2483.52	52.76	-1.24	54	42.67	27.36	16.31	33.58	139	144	A	V
													V
												V	
Remark	1. No other spurious found. 2. All results are PASS against Peak and Average limit line.												



**2.4GHz 2400~2483.5MHz
WIFI 802.11ac VHT20 (Harmonic @ 3m)**

WIFI Ant. 1	Note	Frequency (MHz)	Level (dBµV/m)	Over Limit (dB)	Limit Line (dBµV/m)	Read Level (dBµV)	Antenna Factor (dB/m)	Path Loss (dB)	Preamp Factor (dB)	Ant Pos (cm)	Table Pos (deg)	Peak Avg. (P/A)	Pol. (H/V)	
802.11ac VHT20 CH 01 2412MHz		4824	38.54	-35.46	74	61.97	31.29	10.02	64.74	100	0	P	H	
													H	
													H	
													H	
			4824	38.42	-35.58	74	61.85	31.29	10.02	64.74	100	0	P	V
														V
														V
802.11ac VHT20 CH 06 2437MHz		4874	39.75	-34.25	74	63.08	31.38	9.99	64.7	100	0	P	H	
		7311	42.49	-31.51	74	59.26	36.28	11.77	64.82	100	0	P	H	
		9748	63.88	-27.2	91.08	76.29	38.9	13.89	65.2	174	79	P	H	
													H	
			4874	38.45	-35.55	74	61.78	31.38	9.99	64.7	100	0	P	V
			7311	42.38	-31.62	74	59.15	36.28	11.77	64.82	100	0	P	V
			9748	57.76	-35	92.76	70.17	38.9	13.89	65.2	100	80	P	V
													V	
802.11ac VHT20 CH 11 2462MHz		4924	38.84	-35.16	74	62.03	31.48	9.99	64.66	100	0	P	H	
		7386	40.7	-33.3	74	57.41	36.47	11.68	64.86	100	0	P	H	
													H	
													H	
			4924	38.56	-35.44	74	61.75	31.48	9.99	64.66	100	0	P	V
			7386	41.57	-32.43	74	58.28	36.47	11.68	64.86	100	0	P	V
														V
													V	
Remark	1. No other spurious found. 2. All results are PASS against Peak and Average limit line.													



**2.4GHz 2400~2483.5MHz
WIFI 802.11ac VHT40 (Band Edge @ 3m)**

WIFI Ant. 1	Note	Frequency (MHz)	Level (dBμV/m)	Over Limit (dB)	Limit Line (dBμV/m)	Read Level (dBμV)	Antenna Factor (dB/m)	Path Loss (dB)	Preamp Factor (dB)	Ant Pos (cm)	Table Pos (deg)	Peak Avg. (P/A)	Pol. (H/V)
802.11ac VHT40 CH 03 2422MHz		2387.76	56.03	-17.97	74	46.21	27.13	16.29	33.6	264	212	P	H
		2389.84	47.39	-6.61	54	37.56	27.13	16.29	33.59	264	212	A	H
	*	2422	100.33	-	-	90.4	27.22	16.3	33.59	264	212	P	H
	*	2422	92.58	-	-	82.65	27.22	16.3	33.59	264	212	A	H
		2487.44	52.55	-21.45	74	42.45	27.36	16.32	33.58	264	212	P	H
		2484.08	43	-11	54	32.91	27.36	16.31	33.58	264	212	A	H
		2387.92	61.69	-12.31	74	51.87	27.13	16.29	33.6	145	145	P	V
		2389.52	52.56	-1.44	54	42.74	27.13	16.29	33.6	145	145	A	V
	*	2422	102.63	-	-	92.7	27.22	16.3	33.59	145	145	P	V
	*	2422	94.96	-	-	85.03	27.22	16.3	33.59	145	145	A	V
		2484.64	54.02	-19.98	74	43.92	27.36	16.32	33.58	145	145	P	V
		2496.08	44.73	-9.27	54	34.58	27.4	16.32	33.57	145	145	A	V
802.11ac VHT40 CH 06 2437MHz		2384.88	56.73	-17.27	74	46.95	27.09	16.29	33.6	301	215	P	H
		2388.72	46.41	-7.59	54	36.59	27.13	16.29	33.6	301	215	A	H
	*	2437	104.12	-	-	94.13	27.27	16.31	33.59	301	215	P	H
	*	2437	96.38	-	-	86.39	27.27	16.31	33.59	301	215	A	H
		2483.6	61.01	-12.99	74	50.92	27.36	16.31	33.58	301	215	P	H
		2483.52	48.05	-5.95	54	37.96	27.36	16.31	33.58	301	215	A	H
		2389.84	62.88	-11.12	74	53.05	27.13	16.29	33.59	144	143	P	V
		2390	52.31	-1.69	54	42.48	27.13	16.29	33.59	144	143	A	V
	*	2437	106.92	-	-	96.93	27.27	16.31	33.59	144	143	P	V
	*	2437	98.21	-	-	88.22	27.27	16.31	33.59	144	143	A	V
		2483.6	63.18	-10.82	74	53.09	27.36	16.31	33.58	144	143	P	V
		2484.24	51.61	-2.39	54	41.51	27.36	16.32	33.58	144	143	A	V



802.11ac VHT40 CH 09 2452MHz		2386.64	52.56	-21.44	74	42.74	27.13	16.29	33.6	294	216	P	H
		2352.08	43.24	-10.76	54	33.65	27.04	16.15	33.6	294	216	A	H
	*	2452	103.64	-	-	93.64	27.27	16.31	33.58	294	216	P	H
	*	2452	95.69	-	-	85.69	27.27	16.31	33.58	294	216	A	H
		2484.64	65.3	-8.7	74	55.2	27.36	16.32	33.58	294	216	P	H
		2483.76	50.85	-3.15	54	40.76	27.36	16.31	33.58	294	216	A	H
		2388.4	54.93	-19.07	74	45.11	27.13	16.29	33.6	226	156	P	V
		2389.04	45.29	-8.71	54	35.47	27.13	16.29	33.6	226	156	A	V
	*	2452	104.72	-	-	94.72	27.27	16.31	33.58	226	156	P	V
	*	2452	96.91	-	-	86.91	27.27	16.31	33.58	226	156	A	V
		2484.64	65.15	-8.85	74	55.05	27.36	16.32	33.58	226	156	P	V
		2483.68	52.15	-1.85	54	42.06	27.36	16.31	33.58	226	156	A	V
Remark	1. No other spurious found. 2. All results are PASS against Peak and Average limit line.												



**2.4GHz 2400~2483.5MHz
WIFI 802.11ac VHT40 (Harmonic @ 3m)**

WIFI Ant. 1	Note	Frequency (MHz)	Level (dBμV/m)	Over Limit (dB)	Limit Line (dBμV/m)	Read Level (dBμV)	Antenna Factor (dB/m)	Path Loss (dB)	Preamp Factor (dB)	Ant Pos (cm)	Table Pos (deg)	Peak Avg. (P/A)	Pol. (H/V)
802.11ac VHT40 CH 03 2422MHz		4844	38.47	-35.53	74	61.86	31.32	10.01	64.72	100	0	P	H
		7266	40.52	-33.48	74	57.3	36.21	11.82	64.81	100	0	P	H
													H
													H
		4844	39.17	-34.83	74	62.56	31.32	10.01	64.72	100	0	P	V
		7266	41.6	-32.4	74	58.38	36.21	11.82	64.81	100	0	P	V
802.11ac VHT40 CH 06 2437MHz		4874	38.76	-35.24	74	62.09	31.38	9.99	64.7	100	0	P	H
		7311	42.13	-31.87	74	58.9	36.28	11.77	64.82	100	0	P	H
													H
													H
		4874	38.75	-35.25	74	62.08	31.38	9.99	64.7	100	0	P	V
		7311	41.52	-32.48	74	58.29	36.28	11.77	64.82	100	0	P	V
802.11ac VHT40 CH 09 2452MHz		4904	39.06	-34.94	74	62.3	31.44	9.99	64.67	100	0	P	H
		7356	41.53	-32.47	74	58.26	36.4	11.71	64.84	100	0	P	H
													H
													H
		4904	38.83	-35.17	74	62.07	31.44	9.99	64.67	100	0	P	V
		7356	41.31	-32.69	74	58.04	36.4	11.71	64.84	100	0	P	V
Remark	1. No other spurious found.												
	2. All results are PASS against Peak and Average limit line.												