



# FCC RF Test Report

**APPLICANT** : Plume Design Inc  
**EQUIPMENT** : Plume Pod  
**BRAND NAME** : Plume Design Inc  
**MODEL NAME** : A1A  
**MARKETING NAME** : Plume Adaptive WiFi  
**FCC ID** : 2AG7G-A1A  
**STANDARD** : FCC Part 15 Subpart E §15.407  
**CLASSIFICATION** : (NII) Unlicensed National Information Infrastructure

The product was received on Sep. 19, 2016 and testing was completed on Jan. 20, 2017. We, SPORTON INTERNATIONAL INC., would like to declare that the tested sample has been evaluated in accordance with the test procedures and has been in compliance with the applicable technical standards.

The test results in this report apply exclusively to the tested model / sample. Without written approval of SPORTON INTERNATIONAL INC., the test report shall not be reproduced except in full.

Reviewed by: Joseph Lin / Supervisor

Approved by: Jones Tsai / Manager



Testing Laboratory  
1190

## **SPORTON INTERNATIONAL INC.**

No. 52, Hwa Ya 1<sup>st</sup> Rd., Hwa Ya Technology Park, Kwei-Shan District, Tao Yuan City, Taiwan, R.O.C.



# TABLE OF CONTENTS

**REVISION HISTORY ..... 3**

**SUMMARY OF TEST RESULT ..... 4**

**1 GENERAL DESCRIPTION ..... 5**

    1.1 Applicant ..... 5

    1.2 Manufacturer ..... 5

    1.3 Product Feature of Equipment Under Test ..... 5

    1.4 Product Specification of Equipment Under Test ..... 6

    1.5 Modification of EUT ..... 6

    1.6 Testing Location ..... 7

    1.7 Applicable Standards ..... 7

**2 TEST CONFIGURATION OF EQUIPMENT UNDER TEST ..... 8**

    2.1 Carrier Frequency and Channel ..... 8

    2.2 Test Mode ..... 9

    2.3 Connection Diagram of Test System ..... 10

    2.4 Support Unit used in test configuration and system ..... 11

    2.5 EUT Operation Test Setup ..... 11

    2.6 Measurement Results Explanation Example ..... 12

**3 TEST RESULT ..... 13**

    3.1 26dB & 99% Occupied Bandwidth Measurement ..... 13

    3.2 Maximum Conducted Output Power Measurement ..... 15

    3.3 Power Spectral Density Measurement ..... 18

    3.4 Unwanted Emissions Measurement ..... 20

    3.5 AC Conducted Emission Measurement ..... 24

    3.6 Frequency Stability Measurement ..... 30

    3.7 Automatically Discontinue Transmission ..... 31

    3.8 Antenna Requirements ..... 33

**4 LIST OF MEASURING EQUIPMENT ..... 34**

**5 UNCERTAINTY OF EVALUATION ..... 35**

**APPENDIX A. CONDUCTED TEST RESULTS**

**APPENDIX B. RADIATED SPURIOUS EMISSION**

**APPENDIX C. RADIATED SPURIOUS EMISSION PLOTS**

**APPENDIX D. DUTY CYCLE PLOTS**

**APPENDIX E. SETUP PHOTOGRAPHS**



### REVISION HISTORY

REPORT NO.	VERSION	DESCRIPTION	ISSUED DATE
FR6O0801-01F	Rev. 01	Initial issue of report	Nov. 04, 2016
FR6O0801-01F	Rev. 02	Adding RJ-45 Cable mode	Nov. 14, 2016
FR6O0801-01F	Rev. 03	Revising the limit of radiated band edge in Appendix C.	Nov. 25, 2016
FR6O0801-01F	Rev. 04	Adding the description of maximum straddle channel power in section 3.2.5.	Jan. 09, 2017
FR6O0801-01F	Rev. 05	Adding the test data in section 3.7.	Jan. 20, 2017



### SUMMARY OF TEST RESULT

Report Section	FCC Rule	Description	Limit	Result	Remark
3.1	2.1049 15.403(i)	26dB & 99% Bandwidth	-	Pass	-
3.2	15.407(a)	Maximum Conducted Output Power	≤ 24 dBm (depend on band)	Pass	-
3.3	15.407(a)	Power Spectral Density	≤ 11 dBm (depend on band)	Pass	-
3.4	15.407(b)	Unwanted Emissions	≤ -17, -27 dBm (depend on band)&15.209(a)	Pass	Under limit 1.10 dB at 5469.840 MHz
3.5	15.207	AC Conducted Emission	15.207(a)	Pass	Under limit 0.60 dB at 0.534 MHz
3.6	15.407(g)	Frequency Stability	Within Operation Band	Pass	-
3.7	15.407(c)	Automatically Discontinue Transmission	Discontinue Transmission	Pass	-
3.8	15.203 & 15.407(a)	Antenna Requirement	N/A	Pass	-



# 1 General Description

## 1.1 Applicant

**Plume Design Inc**  
200 California Ave, STE200, Palo Alto, CA 94306, USA

## 1.2 Manufacturer

**Plume Design Inc**  
200 California Ave, STE200, Palo Alto, CA 94306, USA

## 1.3 Product Feature of Equipment Under Test

Product Feature	
Equipment	Plume Pod
Brand Name	Plume Design Inc
Model Name	A1A
Marketing Name	Plume Adaptive WiFi
FCC ID	2AG7G-A1A
EUT supports Radios application	WLAN 11a/b/g/n HT20/HT40 WLAN 11ac VHT80 Bluetooth BR/EDR/LE
HW Version	DVT
EUT Stage	Production Unit

**Remark:** The above EUT's information was declared by manufacturer. Please refer to the specifications or user's manual for more detailed description.



### 1.4 Product Specification of Equipment Under Test

Standards-related Product Specification							
<b>Tx/Rx Frequency Range</b>	5260 MHz ~ 5320 MHz 5500 MHz ~ 5720 MHz						
<b>Maximum Output Power to Antenna</b>	<b>MIMO &lt;Ant. 1 + 2&gt;</b> <b>&lt;5260 MHz ~ 5320 MHz&gt;</b> 802.11a : 20.60 dBm / 0.1148 W 802.11n HT20 : 21.77 dBm / 0.1503 W 802.11n HT40 : 22.33 dBm / 0.1710 W 802.11ac VHT80: 13.24 dBm / 0.0211 W <b>&lt;5500 MHz ~ 5720 MHz&gt;</b> 802.11a : 20.78 dBm / 0.1197 W 802.11n HT20 : 21.33 dBm / 0.1358 W 802.11n HT40 : 22.44 dBm / 0.1754 W 802.11ac VHT80: 19.99 dBm / 0.0998 W						
<b>Maximum Output Power to Antenna for Straddle Channel</b>	<b>MIMO &lt;Ant. 1 + 2&gt;</b> 802.11a : 22.09 dBm / 0.1618 W 802.11n HT20 : 22.49 dBm / 0.1774 W 802.11n HT40 : 23.33 dBm / 0.2153 W 802.11ac VHT80: 23.09 dBm / 0.2037 W						
<b>99% Occupied Bandwidth</b>	802.11a : 24.15 MHz 802.11n HT20 : 28.85 MHz 802.11n HT40 : 65.10 MHz 802.11ac VHT80 : 76.56 MHz						
<b>99% Occupied Bandwidth for Straddle Channel</b>	802.11a : 29.45 MHz 802.11n HT20 : 30.70 MHz 802.11n HT40 : 68.70 MHz 802.11ac VHT80 : 101.04 MHz						
<b>Antenna Type / Gain</b>	<b>&lt;5260 MHz ~ 5320 MHz&gt;</b> <b>Ant. 1</b> : Dipole Antenna with gain 4.00 dBi <b>Ant. 2</b> : Dipole Antenna with gain 4.10 dBi <b>&lt;5500 MHz ~ 5720 MHz &gt;</b> <b>Ant. 1</b> : Dipole Antenna with gain 3.90 dBi <b>Ant. 2</b> : Dipole Antenna with gain 3.20 dBi						
<b>Type of Modulation</b>	802.11a/n : OFDM (BPSK / QPSK / 16QAM / 64QAM) 802.11ac : OFDM (BPSK / QPSK / 16QAM / 64QAM / 256QAM)						
<b>Antenna Function Description</b>	<table border="1"> <thead> <tr> <th></th> <th>Ant. 1</th> <th>Ant. 2</th> </tr> </thead> <tbody> <tr> <td>802.11 a/n/ac MIMO</td> <td>V</td> <td>V</td> </tr> </tbody> </table>		Ant. 1	Ant. 2	802.11 a/n/ac MIMO	V	V
	Ant. 1	Ant. 2					
802.11 a/n/ac MIMO	V	V					

Note: MIMO Ant. 1+2 is a calculated result from sum of the power MIMO Ant. 1 and MIMO Ant. 2.

### 1.5 Modification of EUT

No modifications are made to the EUT during all test items.



### 1.6 Testing Location

Sporton Lab is accredited to ISO 17025 by Taiwan Accreditation Foundation (TAF code : 1190) and the FCC designation No. TW1022 under the FCC 2.948(e) by Mutual Recognition Agreement (MRA) in FCC Test.

<b>Test Site</b>	SPORTON INTERNATIONAL INC.	
<b>Test Site Location</b>	No. 52, Hwa Ya 1 <sup>st</sup> Rd., Hwa Ya Technology Park, Kwei-Shan District, Tao Yuan City, Taiwan, R.O.C. TEL: +886-3-327-3456 FAX: +886-3-328-4978	
<b>Test Site No.</b>	<b>Sporton Site No.</b>	
	TH05-HY	CO05-HY

**Note:** The test site complies with ANSI C63.4 2014 requirement.

<b>Test Site</b>	SPORTON INTERNATIONAL INC.	
<b>Test Site Location</b>	No.58, Aly. 75, Ln. 564, Wenhua 3rd Rd. Guishan Dist, Taoyuan City, Taiwan (R.O.C.) TEL: +886-3-327-0868 FAX: +886-3-327-0855	
<b>Test Site No.</b>	<b>Sporton Site No.</b>	
	03CH12-HY	

**Note:** The test site complies with ANSI C63.4 2014 requirement.

### 1.7 Applicable Standards

According to the specifications of the manufacturer, the EUT must comply with the requirements of the following standards:

- ♦ FCC Part 15 Subpart E
- ♦ FCC KDB 789033 D02 General UNII Test Procedures New Rules v01r03
- ♦ FCC KDB 662911 D01 Multiple Transmitter Output v02r01.
- ♦ FCC KDB 644545 D03 Guidance for IEEE 802 11ac New Rules v01
- ♦ ANSI C63.10-2013

**Remark:**

1. All test items were verified and recorded according to the standards and without any deviation during the test.
2. This EUT has also been tested and complied with the requirements of FCC Part 15, Subpart B, recorded in a separate test report.



## 2 Test Configuration of Equipment Under Test

The EUT has been associated with peripherals and configuration operated in a manner tended to maximize its emission characteristics in a typical application. Frequency range investigated: conducted emission (150 kHz to 30 MHz) and radiated emission (9 kHz to the 10th harmonic of the highest fundamental frequency or to 40 GHz, whichever is lower). For radiated measurement, pre-scanned in three orthogonal panels, X, Y, Z. The worst cases (Z plane) were recorded in this report.

### 2.1 Carrier Frequency and Channel

Frequency Band	Channel	Freq. (MHz)	Channel	Freq. (MHz)
5250-5350 MHz Band 2 (U-NII-2A)	52	5260	60	5300
	54*	5270	62*	5310
	56	5280	64	5320
	58 <sup>#</sup>	5290		

Frequency Band	Channel	Freq. (MHz)	Channel	Freq. (MHz)
5470-5725 MHz Band 3 (U-NII-2C)	100	5500	112	5560
	102*	5510	116	5580
	104	5520	132	5660
	106 <sup>#</sup>	5530	134*	5670
	108	5540	136	5680
	110*	5550	140	5700

Frequency Band	Channel	Freq. (MHz)	Channel	Freq. (MHz)
TDWR Channel	118*	5590	124	5620
	120	5600	126*	5630
	122 <sup>#</sup>	5610	128	5640

Frequency Band	Channel	Freq. (MHz)	Channel	Freq. (MHz)
Straddle Channel	138 <sup>#</sup>	5690	144	5720
	142*	5710		

**Note:**

1. The above Frequency and Channel in "\*" were 802.11n HT40.
2. The above Frequency and Channel in "<sup>#</sup>" were 802.11ac VHT80.





## 2.2 Test Mode

Final test mode of conducted test items and radiated spurious emissions are considering the modulation and worse data rates as below table.

### MIMO Antenna

Modulation	Data Rate
802.11a	6 Mbps
802.11n HT20	MCS8
802.11n HT40	MCS8
802.11ac VHT80	MCS0

Test Cases	
AC Conducted Emission	Mode 1 : LAN Link + WLAN (5GHz) Link + Bluetooth Link

Ch. #		Band II : 5250-5350 MHz			
		802.11a	802.11n HT20	802.11n HT40	802.11ac VHT80
L	Low	52	52	54	-
M	Middle	60	60	-	58
H	High	64	64	62	-

Ch. #		Band III : 5470-5725MHz			
		802.11a	802.11n HT20	802.11n HT40	802.11ac VHT80
L	Low	100	100	102	-
M	Middle	116	116	110	106
H	High	140	140	134	-
Straddle		144	138	144	142

## 2.3 Connection Diagram of Test System

<WLAN Tx Mode>

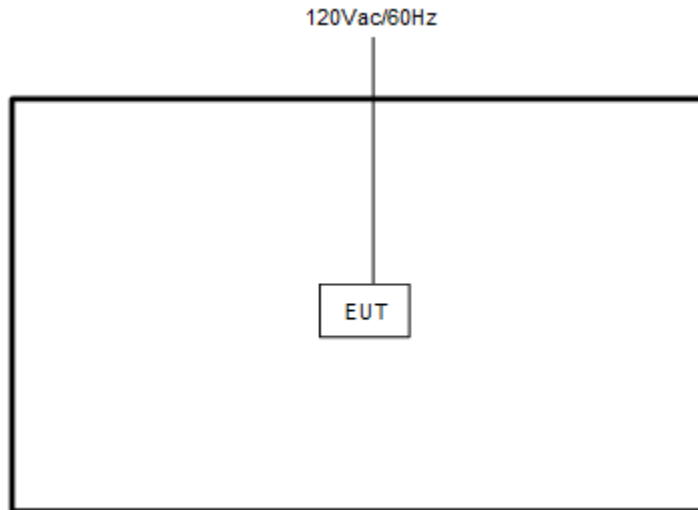

<WLAN RJ-45 Cable Mode>

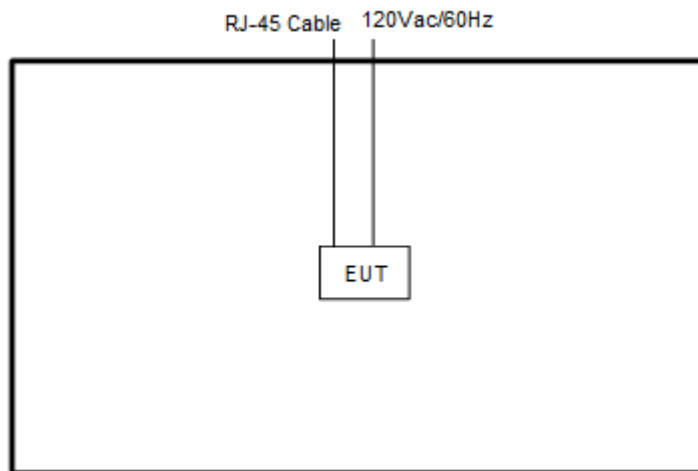

<AC Conducted Emission Mode>

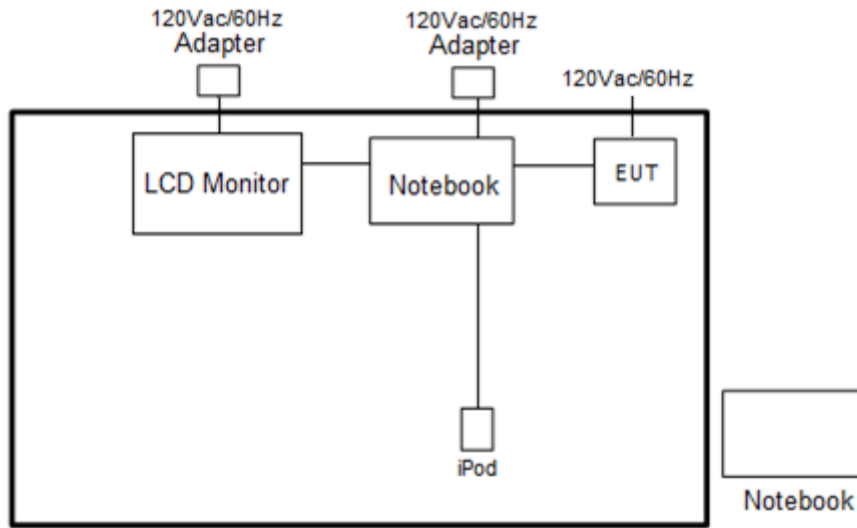

2.4 Support Unit used in test configuration and system

Item	Equipment	Trade Name	Model Name	FCC ID	Data Cable	Power Cord
1.	Notebook	DELL	P20G	FCC DoC/ Contains FCC ID: QDS-BRCM1051	N/A	AC I/P: Unshielded, 1.2 m DC O/P: Shielded, 1.8 m
2.	Notebook	DELL	Latitude E6320	FCC DoC/ Contains FCC ID: QDS-BRCM1054	N/A	AC I/P: Unshielded, 1.2 m DC O/P: Shielded, 1.8 m
3.	iPod	Apple	A1285	FCC DoC	Shielded, 1.0 m	N/A
4.	LCD Monitor	DELL	U2410	FCC DoC	Shielded, 1.6 m	Unshielded, 1.8 m
5.	RJ-45 Cable	INVAX DATA CABLE	IVX011	N/A	Unshielded, 1.0m	N/A

2.5 EUT Operation Test Setup

For WLAN function, programmed RF utility, "Putty" installed in the notebook make the EUT provide functions like channel selection and power level for continuous transmitting and receiving signals.



## 2.6 Measurement Results Explanation Example

For all conducted test items:

The offset level is set in the spectrum analyzer to compensate the RF cable loss and attenuator factor between EUT conducted output port and spectrum analyzer. With the offset compensation, the spectrum analyzer reading level is exactly the EUT RF output level.

Example :

The spectrum analyzer offset is derived from RF cable loss and attenuator factor.

*Offset = RF cable loss + attenuator factor.*

Following shows an offset computation example with cable loss 4.2 dB and 10dB attenuator.

$$\begin{aligned} \text{Offset(dB)} &= \text{RF cable loss(dB)} + \text{attenuator factor(dB)}. \\ &= 4.2 + 10 = 14.2 \text{ (dB)} \end{aligned}$$

### 3 Test Result

#### 3.1 26dB & 99% Occupied Bandwidth Measurement

##### 3.1.1 Description of 26dB & 99% Occupied Bandwidth

This section is for reporting purpose only.

There is no restriction limits for bandwidth.

For Straddle Channel, U-NII procedures were applied for operations in the frequency band in accordance with FCC KDB 644545 D03.

##### 3.1.2 Measuring Instruments

The measuring equipment is listed in the section 4 of this test report.

##### 3.1.3 Test Procedures

1. The testing follows FCC KDB 789033 D02 General UNII Test Procedures New Rules v01r03. Section C) Emission bandwidth
2. Set RBW = approximately 1% of the emission bandwidth.
3. Set the VBW > RBW.
4. Detector = Peak.
5. Trace mode = max hold
6. Measure the maximum width of the emission that is 26 dB down from the peak of the emission. Compare this with the RBW setting of the analyzer. Readjust RBW and repeat measurement as needed until the RBW/EBW ratio is approximately 1%.
7. For 99% Bandwidth Measurement, the spectrum analyzer's resolution bandwidth (RBW) is set 1MHz and set the Video bandwidth (VBW)  $\geq 3 * RBW$ .
8. Measure and record the results in the test report.

##### 3.1.4 Test Setup

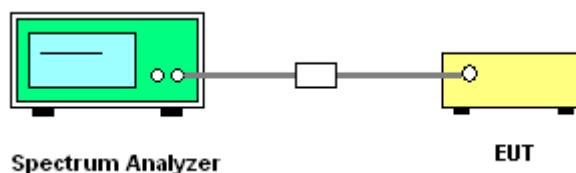



### 3.1.5 Test Result of 26dB & 99% Occupied Bandwidth

Please refer to Appendix A.

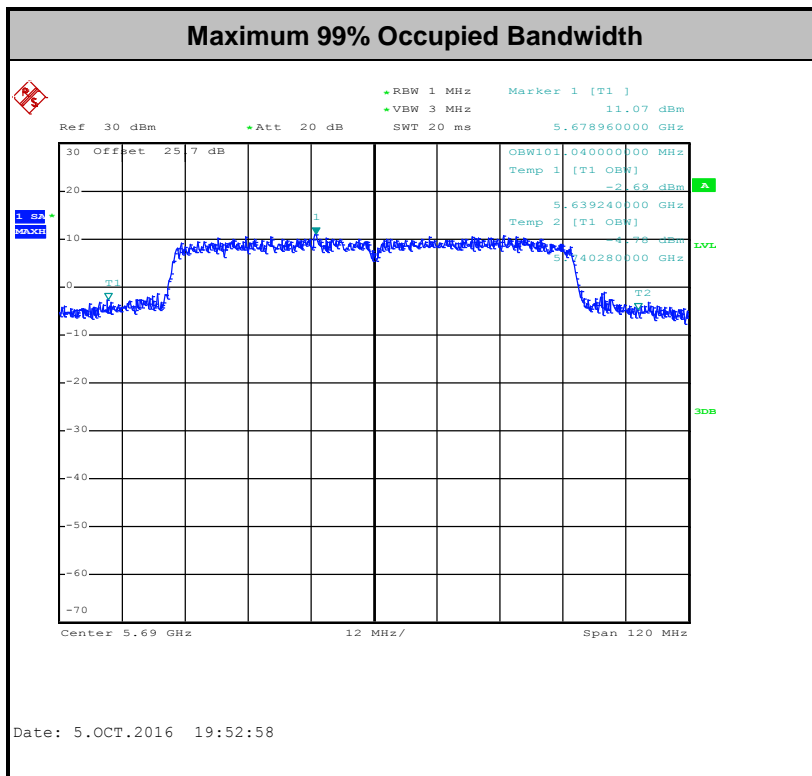
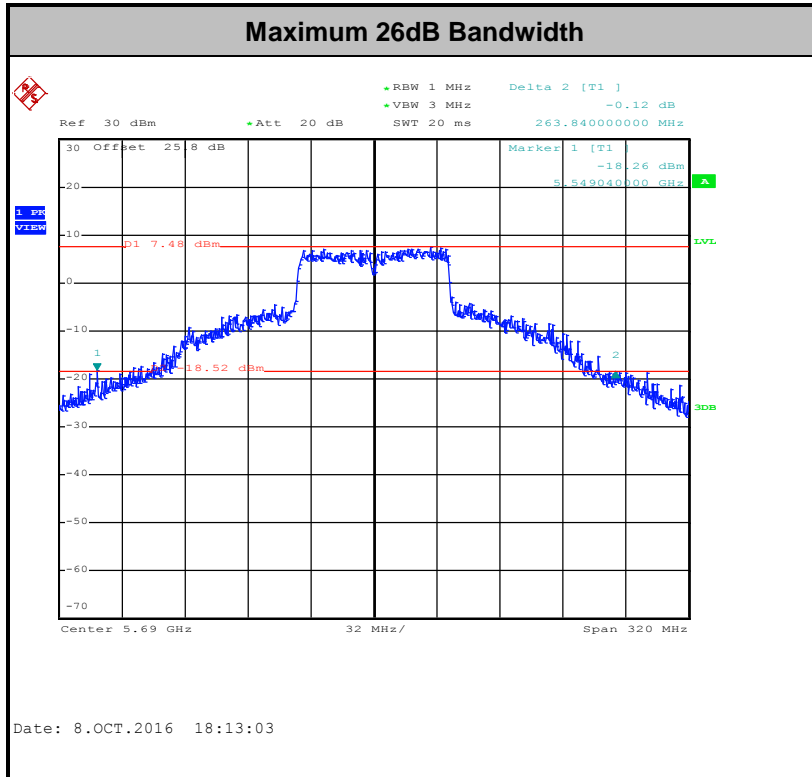

**Note:** The occupied channel bandwidth is maintained within the band of operation for all of the modulations.



## **3.2 Maximum Conducted Output Power Measurement**

### **3.2.1 Limit of Maximum Conducted Output Power**

For the 5.25–5.725 GHz bands, the maximum conducted output power over the frequency bands of operation shall not exceed the lesser of 250 mW or 11 dBm  $10 \log B$ , where B is the 26 dB emission bandwidth in megahertz.

For Straddle Channel, U-NII procedures and limits were applied for operations in the frequency band in accordance with FCC KDB 644545 D03.

If transmitting antennas of directional gain greater than 6 dBi are used, the peak output power shall be reduced by the amount in dB that the directional gain of the antenna exceeds 6 dBi.

Note that U-NII-2 band, devices with a maximum e.i.r.p. greater than 500 mW shall implement TPC in order to have the capability to operate at least 6 dB below the maximum permitted e.i.r.p. of 1 W.

### **3.2.2 Measuring Instruments**

The measuring equipment is listed in the section 4 of this test report.

### **3.2.3 Test Procedures**

The testing follows Method PM of FCC KDB 789033 D02 General UNII Test Procedures New Rules v01r03 for STBC odes.

Method PM (Measurement using an RF average power meter):

1. Measurement is performed using a wideband RF power meter.
2. The EUT is configured to transmit continuously with a consistent duty cycle at its maximum power control level.
3. Measure the average power of the transmitter, and the average power is corrected with duty factor,  $10 \log(1/x)$ , where x is the duty cycle.

For straddle channel, the testing follows Method SA-3 (RMS detection with max hold) of FCC KDB 789033 D02 General UNII Test Procedures New Rules v01r03.

Compute power by integrating the spectrum across the 99% occupied bandwidth of the signal using the instrument's band power measurement function.

### 3.2.4 Test Setup

For normal channel:

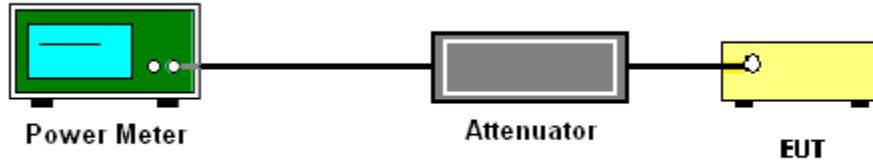

For straddle channel:

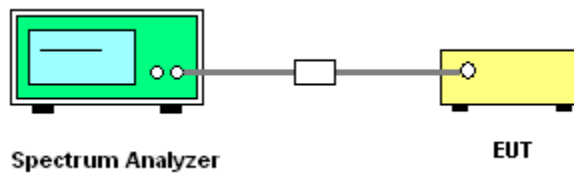





### 3.2.5 Test Result of Maximum Conducted Output Power

1. Please refer to Appendix A.
2. The maximum EIRP within the UNII bands 2A (5250-5350 MHz) and 2C (5470-5725 MHz) does not exceed 500mW (27dBm) and therefore TPC is not required. The total power for the straddle channel does exceed 500mW: however the eirp within the 5470-5725 MHz band is below 500mW.

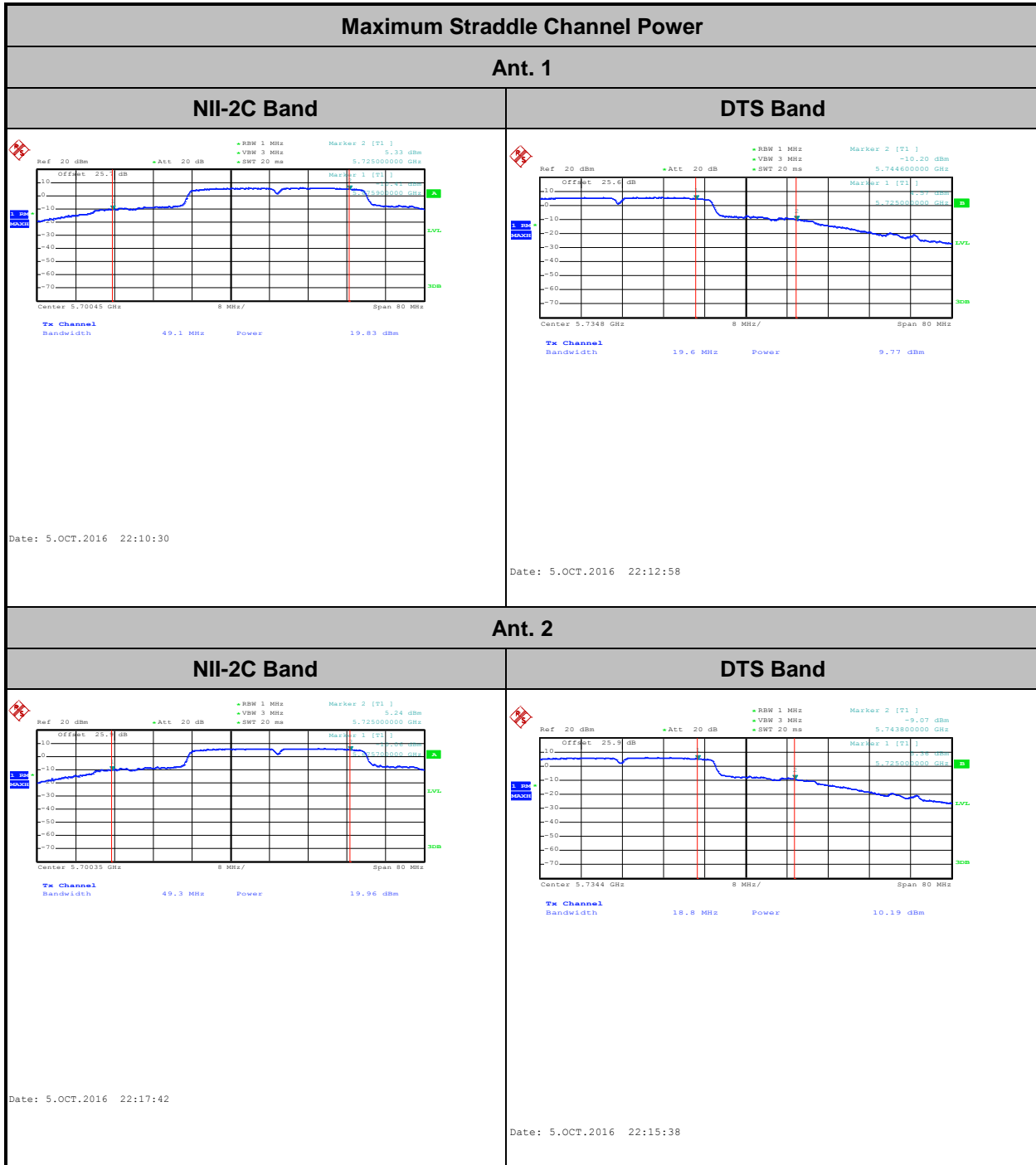



### 3.3 Power Spectral Density Measurement

#### 3.3.1 Limit of Power Spectral Density

For the 5.25–5.725 GHz bands, the maximum power spectral density shall not exceed 11 dBm in any 1 megahertz band.

For Straddle Channel, U-NII procedures and limits were applied for operations in the frequency band in accordance with FCC KDB 644545 D03.

If transmitting antennas of directional gain greater than 6 dBi are used, the peak output power shall be reduced by the amount in dB that the directional gain of the antenna exceeds 6 dBi.

#### 3.3.2 Measuring Instruments

The measuring equipment is listed in the section 4 of this test report.

#### 3.3.3 Test Procedures

The testing follows FCC KDB 789033 D02 General UNII Test Procedures New Rules v01r03. Section F) Maximum power spectral density.

##### # Method SA-2 #

(trace averaging across on and off times of the EUT transmissions, followed by duty cycle correction).

- Measure the duty cycle.
- Set span to encompass the entire emission bandwidth (EBW) of the signal.
- Set RBW = 1 MHz.
- Set VBW  $\geq$  3 MHz.
- Number of points in sweep  $\geq$  2 Span / RBW.
- Sweep time = auto.
- Detector = RMS
- Trace average at least 100 traces in power averaging mode.
- Add  $10 \log(1/x)$ , where  $x$  is the duty cycle, to the measured power in order to compute the average power during the actual transmission times. For example, add  $10 \log(1/0.25) = 6$  dB if the duty cycle is 25 percent.

1. The RF output of EUT was connected to the spectrum analyzer by a low loss cable.
2. Each plot has already offset with cable loss, and attenuator loss. Measure the PPSD and record it.
3. For MIMO mode, calculation method follows FCC KDB 662911 D01 Multiple Transmitter Output v02r01.

Method (a): Measure and sum the spectra across the outputs.

The total final Power Spectral Density is from a device with 2 transmitter outputs. The spectrum measurements of the individual outputs are all performed with the same span and number of points, the spectrum value in the first spectral bin of output 1 is summed with that in the first spectral bin of output 2 to obtain the value for the first frequency bin of the summed spectrum.

### 3.3.4 Test Setup

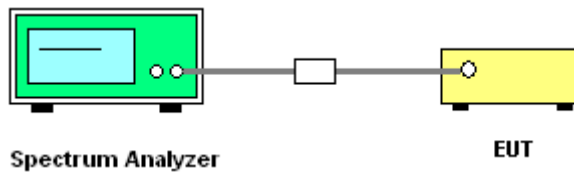

### 3.3.5 Test Result of Power Spectral Density

Please refer to Appendix A.

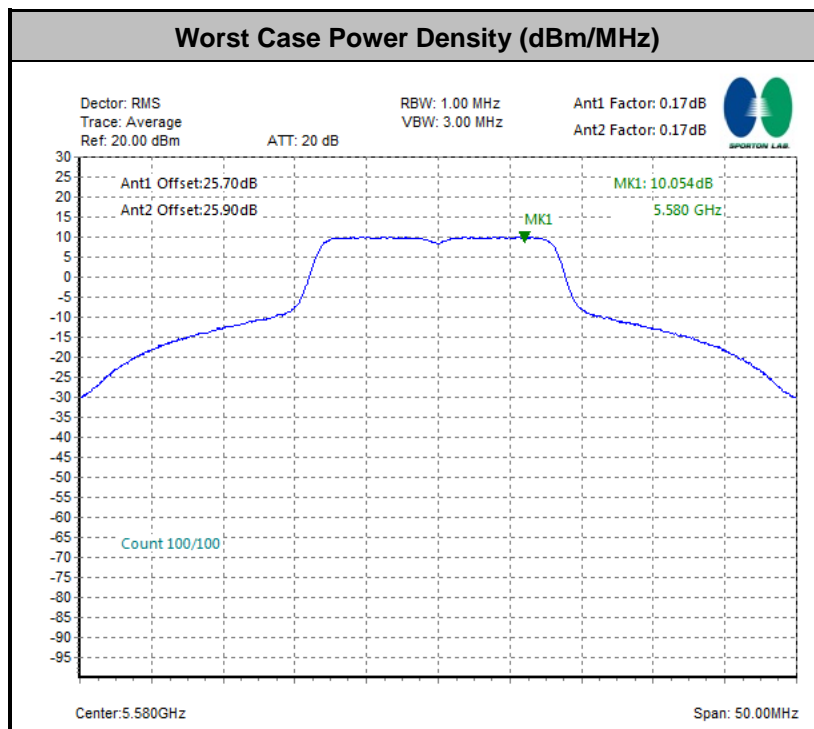

**Note:** Average Power Density (dB) = Measured value+ Duty Factor



### 3.4 Unwanted Emissions Measurement

This section as specified in FCC Part 15.407(b) is to measure unwanted emissions through radiated measurement for band edge spurious emissions and out of band emissions measurement. The unwanted emissions shall comply with 15.407(b)(1) to (6), and restricted bands per FCC Part15.205.

#### 3.4.1 Limit of Unwanted Emissions

(1) For transmitters operating in the 5250-5350 MHz band: all emissions outside of the 5150-5350 MHz band shall not exceed an EIRP of -27 dBm/MHz. Devices operating in the 5250-5350 MHz band that generate emissions in the 5150-5250 MHz band must meet all applicable technical requirements for operation in the 5150-5250 MHz band (including indoor use) or alternatively meet an out-of-band emission EIRP limit of -27 dBm/MHz in the 5150-5250 MHz band.

For transmitters operating in the 5470-5600 MHz and 5650-5725MHz band: all emissions outside of the 5470-5600 MHz and 5650-5725MHz band shall not exceed an EIRP of -27 dBm/MHz.

(2) Unwanted spurious emissions fallen in restricted bands per FCC Part15.205 shall comply with the general field strength limits set forth in § 15.209 as below table,

Frequency (MHz)	Field Strength (microvolts/meter)	Measurement Distance (meters)
0.009 – 0.490	2400/F(kHz)	300
0.490 – 1.705	24000/F(kHz)	30
1.705 – 30.0	30	30
30 – 88	100	3
88 – 216	150	3
216 - 960	200	3
Above 960	500	3

**Note:** The following formula is used to convert the EIRP to field strength.

$$E = \frac{1000000\sqrt{30P}}{3} \mu\text{V/m, where P is the eirp (Watts)}$$

EIRP (dBm)	Field Strength at 3m (dBμV/m)
-17	78.3
- 27	68.3

(3) KDB789033 D02 v01r03 G)2)c) As specified in 15.407(b), emissions above 1000 MHz that are outside of the restricted bands are subject to a peak emission limit of -27 dBm/MHz (or -17 dBm/MHz as specified in 15.407(b)(4)). However, an out-of-band emission that complies with both the average and peak limits of 15.209 is not required to satisfy the -27 dBm/MHz or -17 dBm/MHz peak emission limit.



### 3.4.2 Measuring Instruments

The measuring equipment is listed in the section 4 of this test report.

### 3.4.3 Test Procedures

1. The testing follows FCC KDB 789033 D02 General UNII Test Procedures New Rules v01r03. Section G) Unwanted emissions measurement.
  - (1) Procedure for Unwanted Emissions Measurements Below 1000MHz
    - RBW = 120 kHz
    - VBW = 300 kHz
    - Detector = Peak
    - Trace mode = max hold
  - (2) Procedure for Peak Unwanted Emissions Measurements Above 1000 MHz
    - RBW = 1 MHz
    - VBW  $\geq$  3 MHz
    - Detector = Peak
    - Sweep time = auto
    - Trace mode = max hold
  - (3) Procedures for Average Unwanted Emissions Measurements Above 1000MHz
    - RBW = 1 MHz
    - VBW = 10 Hz, when duty cycle is no less than 98 percent.
    - VBW  $\geq$  1/T, when duty cycle is less than 98 percent where T is the minimum transmission duration over which the transmitter is on and is transmitting at its maximum power control level for the tested mode of operation.
2. The EUT was placed on a turntable with 0.8 meter for frequency below 1GHz and 1.5 meter for frequency above 1GHz respectively above ground.
3. The EUT was set 3 meters from the interference receiving antenna which was mounted on the top of a variable height antenna tower.
4. The antenna is a broadband antenna and its height is adjusted between one meter and four meters above ground to find the maximum value of the field strength for both horizontal polarization and vertical polarization of the antenna.
5. For each suspected emission, the EUT was arranged to its worst case and then adjust the antenna tower (from 1 m to 4 m) and turntable (from 0 degree to 360 degrees) to find the maximum reading.
6. For testing below 1GHz, if the emission level of the EUT in peak mode was 3 dB lower than the limit specified, then peak values of EUT will be reported, otherwise, the emissions will be repeated one by one using the CISPR quasi-peak method and reported.
7. For testing above 1GHz, the emission level of the EUT in peak mode was 20dB lower than average limit (that means the emission level in average mode also complies with the limit in average mode), then peak values of EUT will be reported, otherwise, the emissions will be measured in average mode again and reported.

### 3.4.4 Test Setup

For radiated emissions below 30MHz

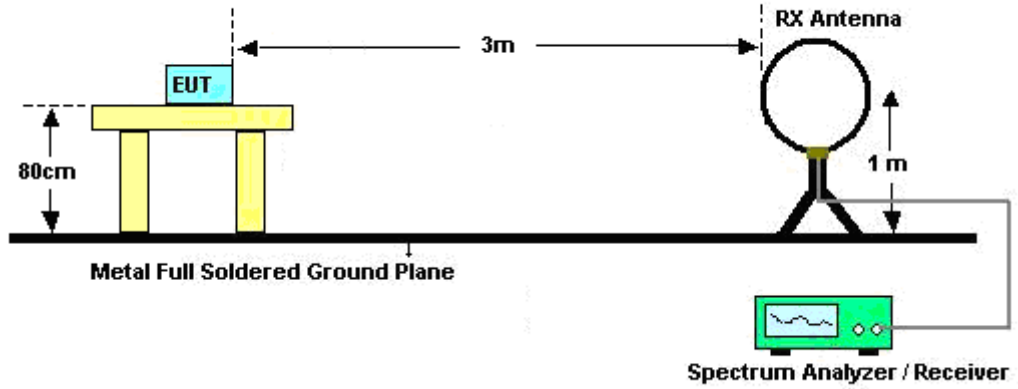

For radiated emissions from 30MHz to 1GHz

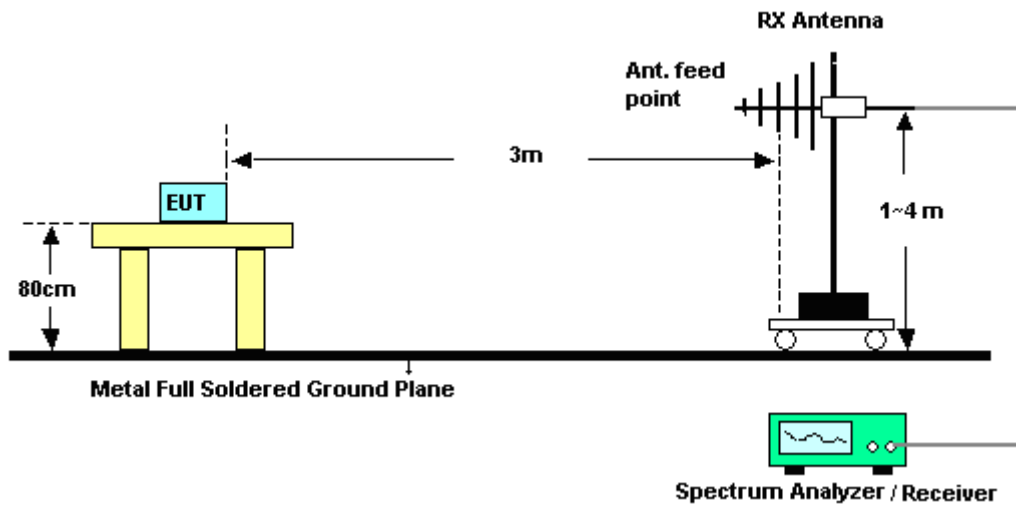

For radiated emissions above 1GHz

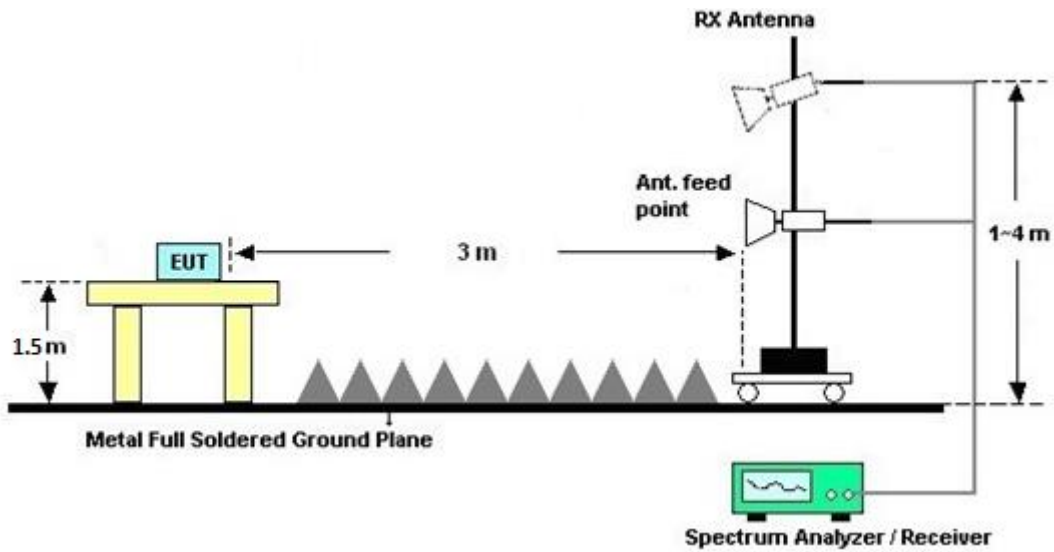

### 3.4.5 Test Results of Radiated Spurious Emissions (9 kHz ~ 30 MHz)

The low frequency, which started from 9 kHz to 30MHz, was pre-scanned and the result which was 20dB lower than the limit line per 15.31(o) was not reported.

### 3.4.6 Test Result of Radiated Spurious at Band Edges

Please refer to Appendix B and C.

### 3.4.7 Duty Cycle

Please refer to Appendix D.

### 3.4.8 Test Result of Radiated Spurious Emissions (30MHz ~ 10th Harmonic)

Please refer to Appendix B and C.



### 3.5 AC Conducted Emission Measurement

#### 3.5.1 Limit of AC Conducted Emission

For equipment that is designed to be connected to the public utility (AC) power line, the radio frequency voltage that is conducted back onto the AC power line on any frequency or frequencies within the band 150 kHz to 30 MHz shall not exceed the limits in the following table.

Frequency of emission (MHz)	Conducted limit (dB $\mu$ V)	
	Quasi-peak	Average
0.15-0.5	66 to 56*	56 to 46*
0.5-5	56	46
5-30	60	50

\*Decreases with the logarithm of the frequency.

#### 3.5.2 Measuring Instruments

The measuring equipment is listed in the section 4 of this test report.

#### 3.5.3 Test Procedures

1. The EUT was placed 0.4 meter from the conducting wall of the shielding room was kept at least 80 centimeters from any other grounded conducting surface.
2. Connect EUT to the power mains through a line impedance stabilization network (LISN).
3. All the support units are connecting to the other LISN.
4. The LISN provides 50 ohm coupling impedance for the measuring instrument.
5. The FCC states that a 50 ohm, 50 microhenry LISN should be used.
6. Both sides of AC line were checked for maximum conducted interference.
7. The frequency range from 150 kHz to 30 MHz was searched.
8. Set the test-receiver system to Peak Detect Function and specified bandwidth with Maximum Hold Mode.



### 3.5.4 Test Setup

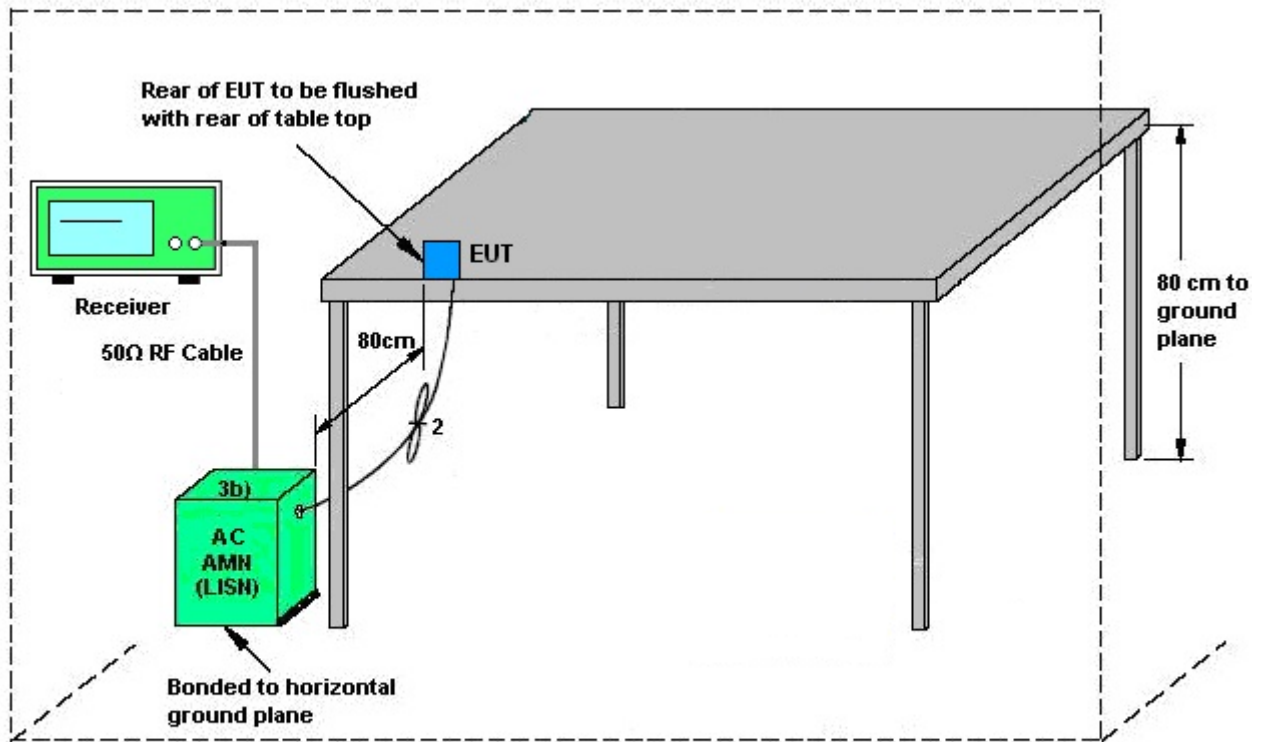

AMN = Artificial mains network (LISH)  
AE = Associated equipment  
EUT = Equipment under test  
ISN = Impedance stabilization network



### 3.5.5 Test Result of AC Conducted Emission

Test Mode :	Mode 1	Temperature :	21~23°C
Test Engineer :	Arthur Hsieh	Relative Humidity :	50~52%
Test Voltage :	120Vac / 60Hz	Phase :	Line
Function Type :	LAN Link + WLAN (5GHz) Link + Bluetooth Link		

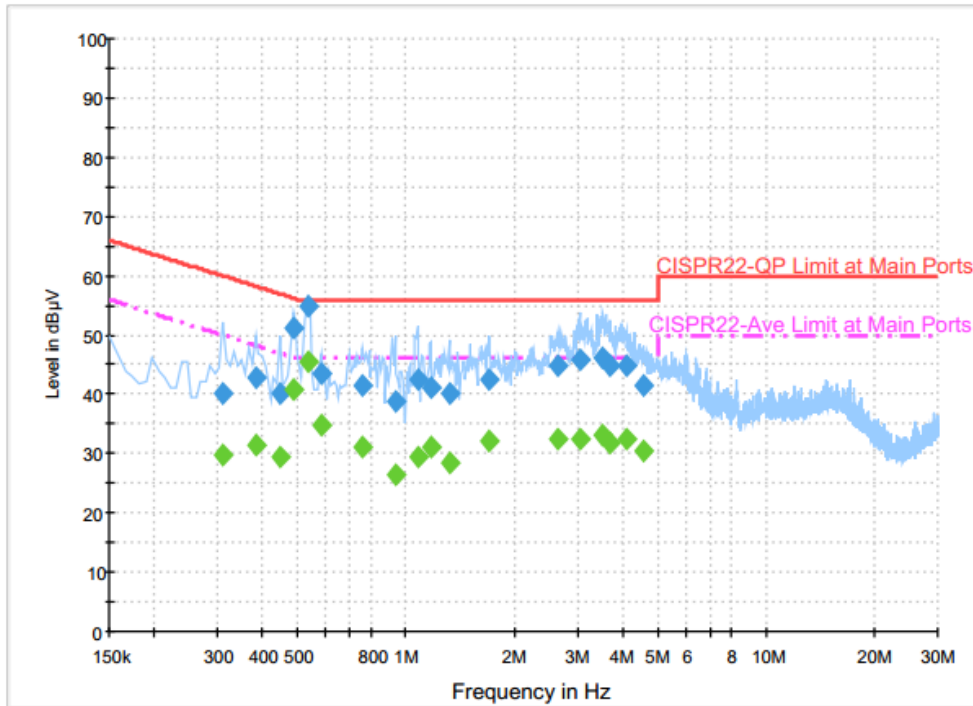

**Final Result : QuasiPeak**

Frequency (MHz)	QuasiPeak (dBµV)	Filter	Line	Corr. (dB)	Margin (dB)	Limit (dBµV)
0.310000	40.2	Off	L1	19.6	19.8	60.0
0.382000	42.7	Off	L1	19.6	15.5	58.2
0.446000	40.2	Off	L1	19.6	16.7	56.9
0.486000	51.1	Off	L1	19.6	5.1	56.2
0.534000	54.7	Off	L1	19.6	1.3	56.0
0.582000	43.6	Off	L1	19.6	12.4	56.0
0.758000	41.5	Off	L1	19.6	14.5	56.0
0.934000	38.8	Off	L1	19.7	17.2	56.0
1.078000	42.4	Off	L1	19.7	13.6	56.0
1.174000	41.0	Off	L1	19.7	15.0	56.0
1.318000	40.2	Off	L1	19.7	15.8	56.0
1.702000	42.5	Off	L1	19.7	13.5	56.0
2.630000	44.7	Off	L1	19.3	11.3	56.0
3.038000	45.7	Off	L1	19.6	10.3	56.0
3.534000	46.1	Off	L1	19.7	9.9	56.0
3.702000	44.8	Off	L1	19.8	11.2	56.0
4.086000	45.0	Off	L1	19.8	11.0	56.0
4.566000	41.3	Off	L1	19.9	14.7	56.0



Test Mode :	Mode 1	Temperature :	21~23°C
Test Engineer :	Arthur Hsieh	Relative Humidity :	50~52%
Test Voltage :	120Vac / 60Hz	Phase :	Line
Function Type :	LAN Link + WLAN (5GHz) Link + Bluetooth Link		

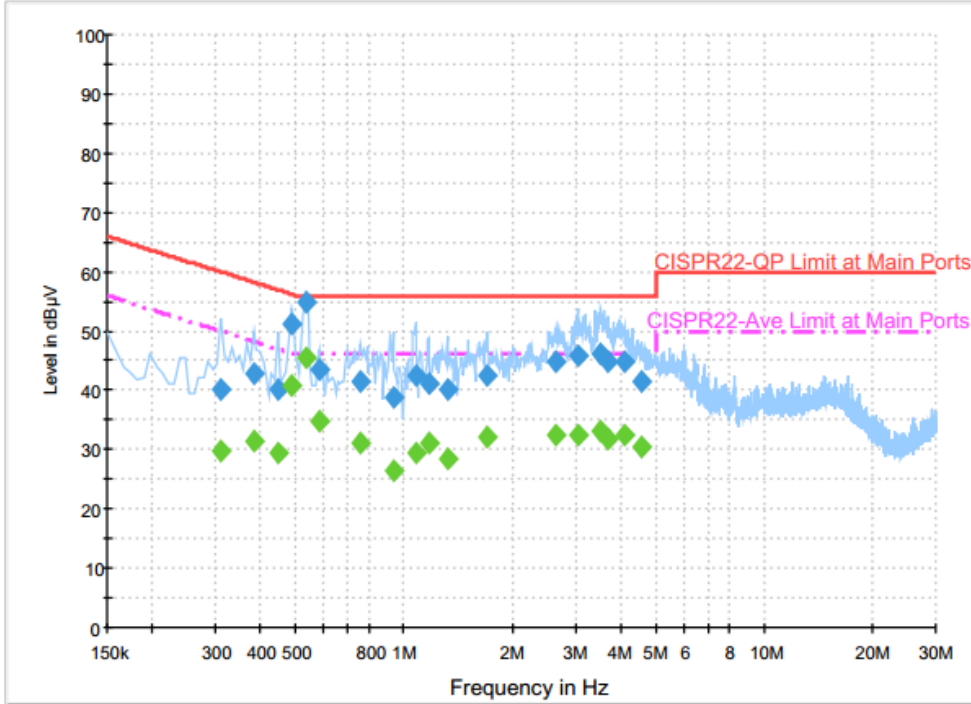

Final Result : Average

Frequency (MHz)	Average (dBµV)	Filter	Line	Corr. (dB)	Margin (dB)	Limit (dBµV)
0.310000	29.6	Off	L1	19.6	20.4	50.0
0.382000	31.3	Off	L1	19.6	16.9	48.2
0.446000	29.5	Off	L1	19.6	17.4	46.9
0.486000	40.8	Off	L1	19.6	5.4	46.2
0.534000	45.4	Off	L1	19.6	0.6	46.0
0.582000	34.8	Off	L1	19.6	11.2	46.0
0.758000	31.0	Off	L1	19.6	15.0	46.0
0.934000	26.5	Off	L1	19.7	19.5	46.0
1.078000	29.5	Off	L1	19.7	16.5	46.0
1.174000	31.1	Off	L1	19.7	14.9	46.0
1.318000	28.5	Off	L1	19.7	17.5	46.0
1.702000	32.0	Off	L1	19.7	14.0	46.0
2.630000	32.5	Off	L1	19.3	13.5	46.0
3.038000	32.5	Off	L1	19.6	13.5	46.0
3.534000	33.3	Off	L1	19.7	12.7	46.0
3.702000	31.8	Off	L1	19.8	14.2	46.0
4.086000	32.6	Off	L1	19.8	13.4	46.0
4.566000	30.4	Off	L1	19.9	15.6	46.0



Test Mode :	Mode 1	Temperature :	21~23°C
Test Engineer :	Arthur Hsieh	Relative Humidity :	50~52%
Test Voltage :	120Vac / 60Hz	Phase :	Neutral
Function Type :	LAN Link + WLAN (5GHz) Link + Bluetooth Link		

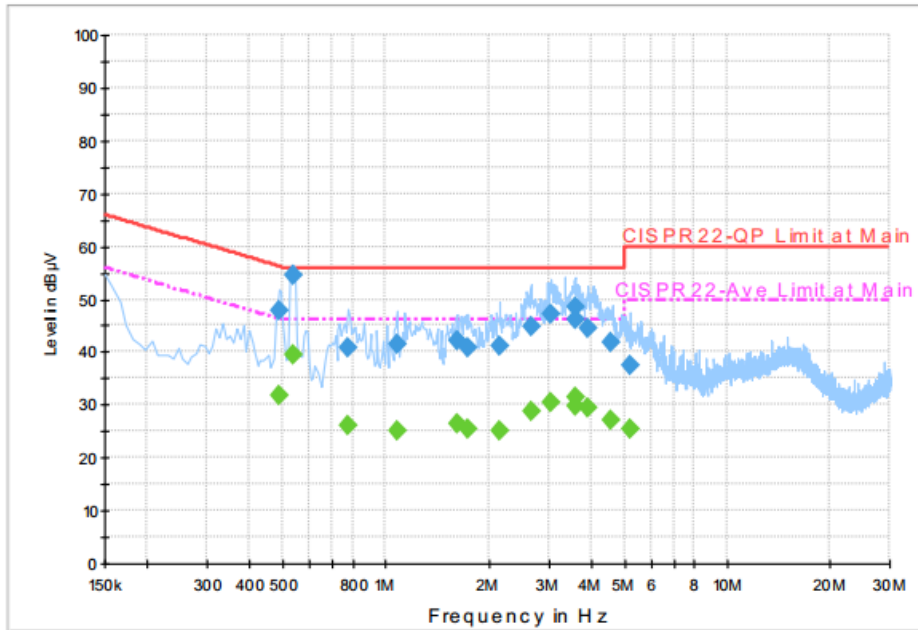

Final Result : QuasiPeak

Frequency (MHz)	QuasiPeak (dBµV)	Filter	Line	Corr. (dB)	Margin (dB)	Limit (dBµV)
0.486000	47.7	Off	N	19.6	8.5	56.2
0.534000	54.6	Off	N	19.6	1.4	56.0
0.774000	40.8	Off	N	19.6	15.2	56.0
1.078000	41.3	Off	N	19.6	14.7	56.0
1.614000	42.0	Off	N	19.7	14.0	56.0
1.742000	40.6	Off	N	19.7	15.4	56.0
2.158000	41.2	Off	N	17.9	14.8	56.0
2.662000	44.9	Off	N	19.4	11.1	56.0
3.062000	47.3	Off	N	19.6	8.7	56.0
3.582000	48.4	Off	N	19.7	7.6	56.0
3.622000	46.0	Off	N	19.7	10.0	56.0
3.902000	44.5	Off	N	19.8	11.5	56.0
4.550000	41.7	Off	N	19.8	14.3	56.0
5.190000	37.4	Off	N	19.9	22.6	60.0



Test Mode :	Mode 1	Temperature :	21~23°C
Test Engineer :	Arthur Hsieh	Relative Humidity :	50~52%
Test Voltage :	120Vac / 60Hz	Phase :	Neutral
Function Type :	LAN Link + WLAN (5GHz) Link + Bluetooth Link		

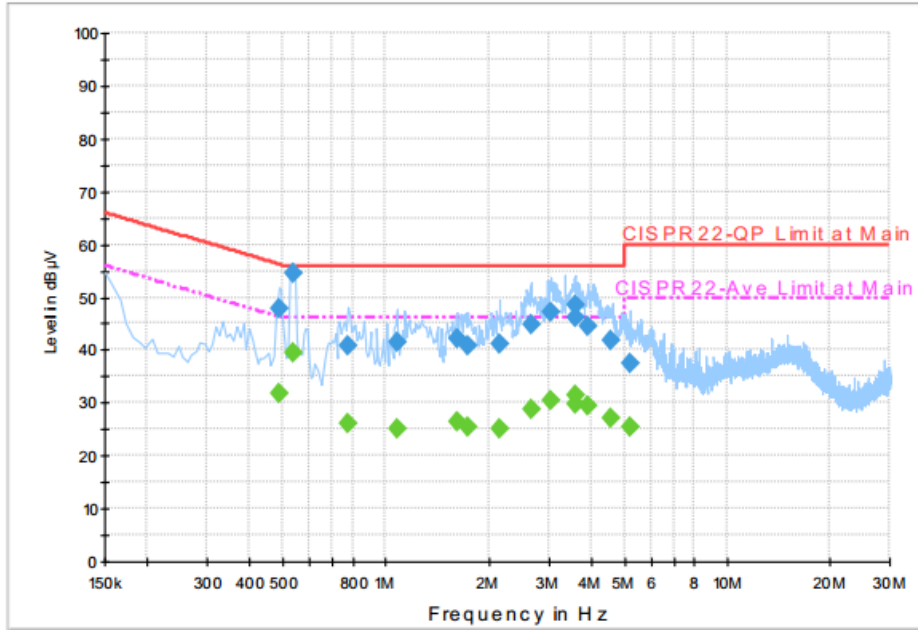

**Final Result : Average**

Frequency (MHz)	Average (dBµV)	Filter	Line	Corr. (dB)	Margin (dB)	Limit (dBµV)
0.486000	31.7	Off	N	19.6	14.5	46.2
0.534000	39.4	Off	N	19.6	6.6	46.0
0.774000	26.0	Off	N	19.6	20.0	46.0
1.078000	25.2	Off	N	19.6	20.8	46.0
1.614000	26.3	Off	N	19.7	19.7	46.0
1.742000	25.3	Off	N	19.7	20.7	46.0
2.158000	25.1	Off	N	17.9	20.9	46.0
2.662000	28.6	Off	N	19.4	17.4	46.0
3.062000	30.4	Off	N	19.6	15.6	46.0
3.582000	31.4	Off	N	19.7	14.6	46.0
3.622000	29.6	Off	N	19.7	16.4	46.0
3.902000	29.3	Off	N	19.8	16.7	46.0
4.550000	27.2	Off	N	19.8	18.8	46.0
5.190000	25.5	Off	N	19.9	24.5	50.0

### 3.6 Frequency Stability Measurement

#### 3.6.1 Limit of Frequency Stability

Manufacturers of U-NII devices are responsible for ensuring frequency stability such that an emission is maintained within the band of operation under all conditions of normal operation as specified in the user's manual.

#### 3.6.2 Measuring Instruments

The measuring equipment is listed in the section 4 of this test report.

#### 3.6.3 Test Procedures

1. To ensure emission at the band edge is maintained within the authorized band, those values shall be measured by radiation emissions at upper and lower frequency points, and finally compensated by frequency deviation as procedures below.
2. The EUT was operated at the maximum output power, and connected to the spectrum analyzer, which is set to maximum hold function and peak detector. The peak value of the power envelope was measured and noted. The upper and lower frequency points were respectively measured relatively 10dB lower than the measured peak value.
3. The frequency deviation was calculated by adding the upper frequency point and the lower frequency point divided by two. Those detailed values of frequency deviation are provided in table below.

#### 3.6.4 Test Setup



#### 3.6.5 Test Result of Frequency Stability

Please refer to Appendix A.



### **3.7 Automatically Discontinue Transmission**

#### **3.7.1 Limit of Automatically Discontinue Transmission**

The device shall automatically discontinue transmission in case of either absence of information to transmit or operational failure. These provisions are not intended to preclude the transmission of control or signaling information or the use of repetitive codes used by certain digital technologies to complete frame or burst intervals. Applicants shall include in their application for equipment authorization to describe how this requirement is met.

#### **3.7.2 Measuring Instruments**

The measuring equipment is listed in the section 4 of this test report.

#### **3.7.3 Test Result of Automatically Discontinue Transmission**

EUT is verified this characteristic during the function check of normal sample associated with an access point:

- A. Information start: make EUT supply information to the access point.
- B. Information stop: stop supplying information to the access point.

While the EUT is not transmitting any information, the EUT can automatically discontinue transmission and become standby mode for power saving.

- C. Information start: make EUT supply information to the access point again.

The EUT can detect the controlling signal of ACK message transmitting from remote device and verify whether it shall resend or discontinue transmission.

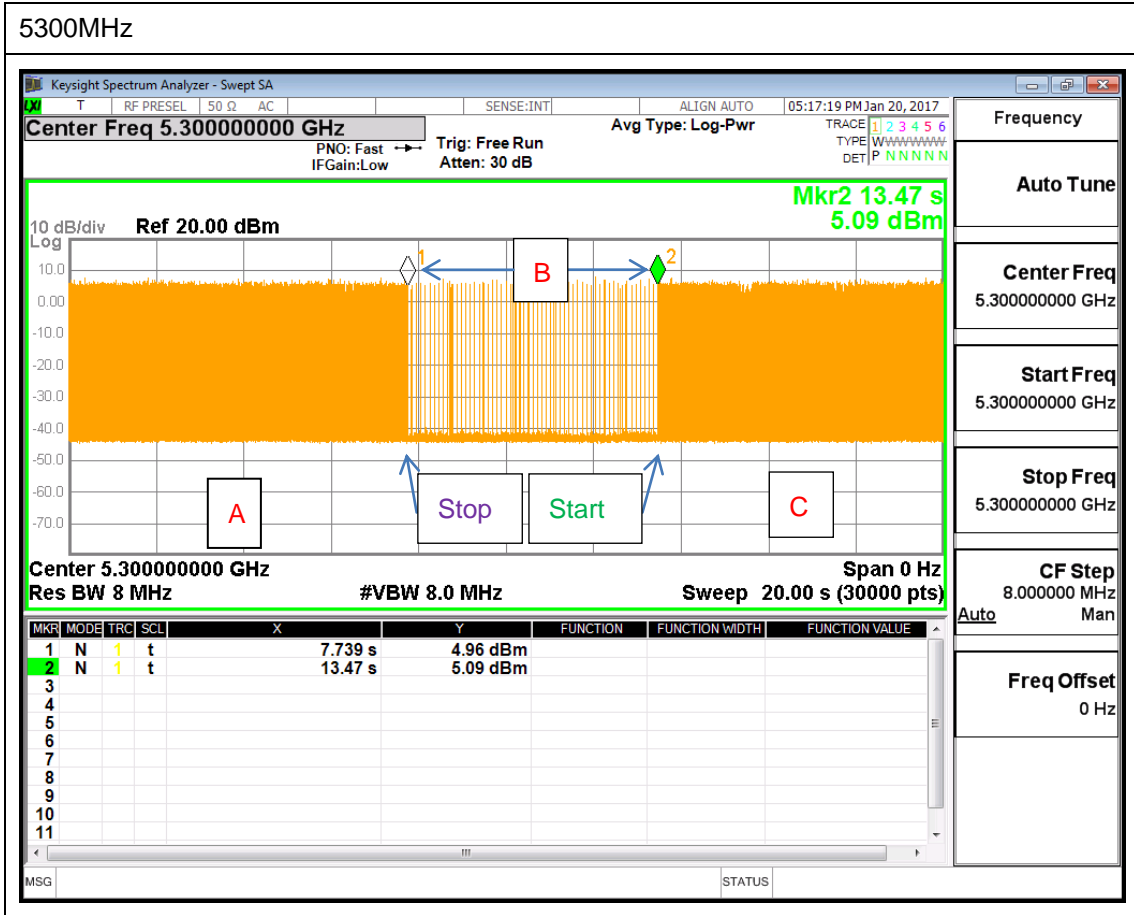

Note : The control / signalling information during the period B is precluded.





### 3.8 Antenna Requirements

#### 3.8.1 Standard Applicable

According to FCC 47 CFR Section 15.407(a)(1)(2) ,if transmitting antenna directional gain is greater than 6 dBi, both the peak transmit power and the peak power spectral density shall be reduced by the amount in dB that the directional gain of the antenna exceeds 6 dBi.

#### 3.8.2 Antenna Anti-Replacement Construction

An embedded-in antenna design is used.

#### 3.8.3 Antenna Gain

FCC KDB 662911 D01 Multiple Transmitter Output v02r01

For power, the directional gain  $G_{ANT}$  is set equal to the antenna having the highest gain, i.e., F)2)f)i).

For PSD, the directional gain calculation is following F)2)f)ii) of KDB 662911 D01 v02r01.

The power and PSD limit should be modified if the directional gain of EUT is over 6 dBi,

The directional gain “DG” is calculated as following table.

	Ant 1 (dBi)	Ant 2 (dBi)	DG for Power (dBi)	DG for PSD (dBi)	Power Limit Reduction (dB)	PSD Limit Reduction (dB)
<b>Band II</b>	4.00	4.10	4.10	7.06	0.00	1.06
<b>Band III</b>	3.90	3.20	3.90	6.57	0.00	0.57

$Power\ limit\ reduction = Composite\ gain - 6dBi, (min = 0)$

$PSD\ limit\ reduction = Composite\ gain + PSD\ Array\ gain - 6dBi, (min = 0)$



## 4 List of Measuring Equipment

Instrument	Manufacturer	Model No.	Serial No.	Characteristics	Calibration Date	Test Date	Due Date	Remark
Power Meter	Anritsu	ML2495A	1132003	300MHz~40GHz	Aug. 04, 2016	Oct. 04, 2016 ~ Oct. 11, 2016	Aug. 03, 2017	Conducted (TH05-HY)
Power Sensor	Anritsu	MA2411B	1126017	300MHz~40GHz	Aug. 04, 2016	Oct. 04, 2016 ~ Oct. 11, 2016	Aug. 03, 2017	Conducted (TH05-HY)
Signal Analyzer	Rohde & Schwarz	FSV 30	100895	9kHz~30GHz	Apr. 27, 2016	Oct. 04, 2016 ~ Oct. 11, 2016	Apr. 26, 2017	Conducted (TH05-HY)
Spectrum Analyzer	Rohde & Schwarz	FSP40	100057	9kHz-40GHz	Nov. 23, 2015	Oct. 04, 2016 ~ Oct. 11, 2016	Nov. 22, 2016	Conducted (TH05-HY)
Temperature Chamber	ESPEC	SU-241	92003713	-30℃ ~95℃	Jun. 06, 2016	Oct. 04, 2016 ~ Oct. 11, 2016	Jun. 05, 2017	Conducted (TH05-HY)
AC Power Source	ChainTek	APC-1000W	N/A	N/A	N/A	Oct. 18, 2016	N/A	Conduction (CO05-HY)
EMI Test Receiver	Rohde & Schwarz	ESCI 7	100724	9kHz~7GHz	Aug. 30, 2016	Oct. 18, 2016	Aug. 29, 2017	Conduction (CO05-HY)
LISN	Rohde & Schwarz	ENV216	100080	9kHz~30MHz	Dec. 02, 2015	Oct. 18, 2016	Dec. 01, 2016	Conduction (CO05-HY)
LISN	Rohde & Schwarz	ENV216	100081	9kHz~30MHz	Dec. 14, 2015	Oct. 18, 2016	Dec. 13, 2016	Conduction (CO05-HY)
Loop Antenna	Rohde & Schwarz	HFH2-Z2	100315	9 kHz~30 MHz	Sep. 02, 2015	Sep. 26, 2016 ~ Nov. 12, 2016	Sep. 01, 2017	Radiation (03CH12-HY)
Amplifier	SONOMA	310N	187312	9kHz~1GHz	Nov. 20, 2015	Sep. 26, 2016 ~ Nov. 12, 2016	Nov. 19, 2016	Radiation (03CH12-HY)
Spectrum Analyzer	Agilent	N9030A	MY52350276	3Hz~44GHz	Mar. 21, 2016	Sep. 26, 2016 ~ Nov. 12, 2016	Mar. 20, 2017	Radiation (03CH12-HY)
Bilog Antenna	TESEQ	CBL 6111D	37059	30MHz~1GHz	Dec. 29, 2015	Sep. 26, 2016 ~ Nov. 12, 2016	Dec. 28, 2016	Radiation (03CH12-HY)
EMI Test Receiver	Rohde & Schwarz	ESU26	100390	20Hz~26.5GHz	Dec. 21, 2015	Sep. 26, 2016 ~ Nov. 12, 2016	Dec. 20, 2016	Radiation (03CH12-HY)
Preamplifier	MITEQ	TTA0204	1872107	2GHz~40GHz	Feb. 15, 2016	Sep. 26, 2016 ~ Nov. 12, 2016	Feb. 14, 2017	Radiation (03CH12-HY)
Horn Antenna	SCHWARZBECK	BBHA 9120D	9120D-1328	1GHz ~ 18GHz	Nov. 02, 2015	Sep. 26, 2016 ~ Oct. 02, 2016	Nov. 01, 2016	Radiation (03CH12-HY)
Horn Antenna	SCHWARZBECK	BBHA 9120D	9120D-1328	1GHz ~ 18GHz	Mar. 31, 2016	Nov. 11, 2016 ~ Nov. 12, 2016	Mar. 30, 2017	Radiation (03CH12-HY)
Preamplifier	MITEQ	AMF-7D-0010 1800-30-10P	1815698	1GHz~18GHz	Dec. 14, 2015	Sep. 26, 2016 ~ Nov. 12, 2016	Dec. 13, 2016	Radiation (03CH12-HY)
Preamplifier	Keysight	83017A	MY53270148	1GHz~26.5GHz	Jan. 30, 2016	Sep. 26, 2016 ~ Nov. 12, 2016	Jan. 29, 2017	Radiation (03CH12-HY)
Antenna Mast	EMEC	AM-BS-4500-B	N/A	1m~4m	N/A	Sep. 26, 2016 ~ Nov. 12, 2016	N/A	Radiation (03CH12-HY)
Turn Table	EMEC	TT2000	N/A	0~360 Degree	N/A	Sep. 26, 2016 ~ Nov. 12, 2016	N/A	Radiation (03CH12-HY)
SHF-EHF Horn Antenna	SCHWARZBECK	BBHA 9170	BBHA917058 4	18GHz- 40GHz	Nov. 02, 2015	Sep. 26, 2016 ~ Oct. 02, 2016	Nov. 01, 2016	Radiation (03CH12-HY)
SHF-EHF Horn Antenna	SCHWARZBECK	BBHA 9170	BBHA917058 4	18GHz- 40GHz	Apr. 15, 2016	Nov. 11, 2016 ~ Nov. 12, 2016	Apr. 14, 2017	Radiation (03CH12-HY)
Spectrum Analyzer	Keysight	N9010A	MY56070412	10Hz~7GHz	Aug. 05, 2016	Jan. 20, 2017	Aug. 04, 2017	DFS (DFS02-HY)



## 5 Uncertainty of Evaluation

### Uncertainty of Conducted Emission Measurement (150kHz ~ 30MHz)

Measuring Uncertainty for a Level of Confidence of 95% ( $U = 2Uc(y)$ )	2.70
---	------

### Uncertainty of Radiated Emission Measurement (30 MHz ~ 1000 MHz)

Measuring Uncertainty for a Level of Confidence of 95% ( $U = 2Uc(y)$ )	5.10
---	------

### Uncertainty of Radiated Emission Measurement (1000 MHz ~ 18000 MHz)

Measuring Uncertainty for a Level of Confidence of 95% ( $U = 2Uc(y)$ )	5.20
---	------

### Uncertainty of Radiated Emission Measurement (18000 MHz ~ 40000 MHz)

Measuring Uncertainty for a Level of Confidence of 95% ( $U = 2Uc(y)$ )	4.70
---	------



## **Appendix A. Conducted Test Results**