

Speed 5S

ORIGINALITY DESIGN SMART – AND BEAUTIFUL



IP CAMERA



QUICK GUIDE



What's in the box

Consult the checklist below for all components.

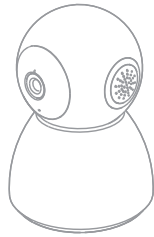

Speed 5S

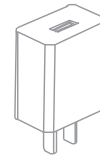

Power adapter

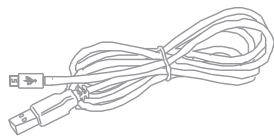

USB cable

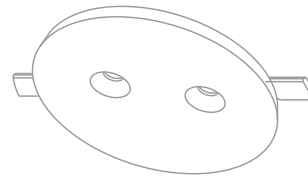

Bracket

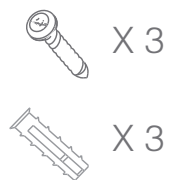

Screws

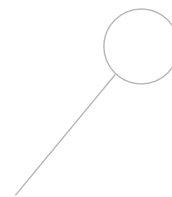

Pin

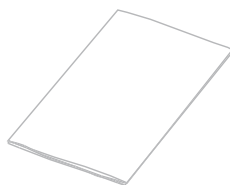

I/M

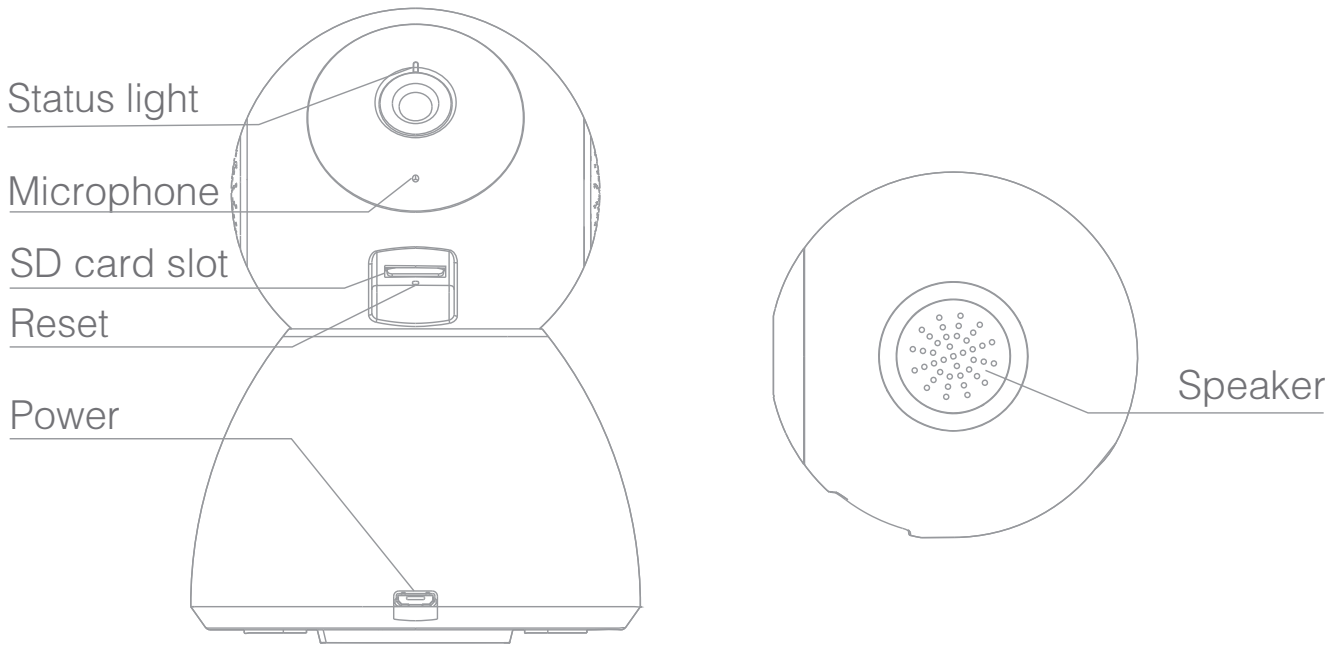

Description

Power DC 5V ± 10%

Status light

- Red light solids on: the camera network is abnormal
- Blinking red light: awaiting WiFi connection (faster blinking)
- Blue light solids on: camera running correctly
- Blinking blue light: currently connecting (faster blinking)

Microphone Captures sound for your video

SD card slot Supports local SD Card storage (Max. 128G)

Reset Press and hold for 5 seconds with pin to reset the camera (if you have modified settings, they will return to factory defaults)

Install

- 1 Use the included mounting bracket to fix the camera to a clean surface.

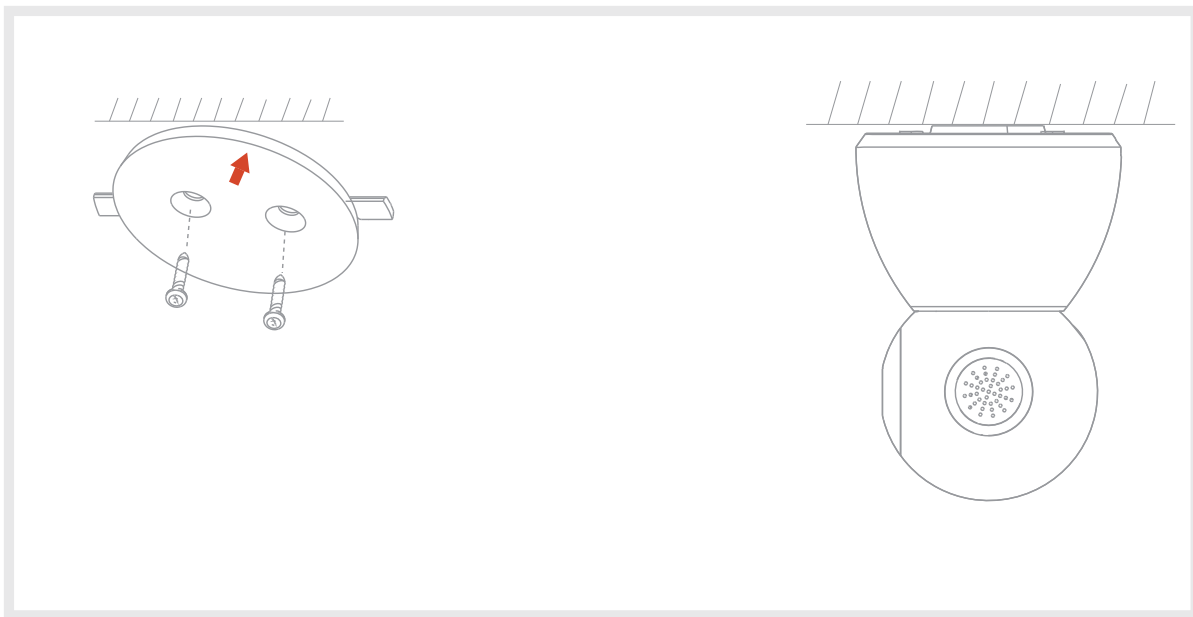

- 2 Or, put the camera on a flat surface.

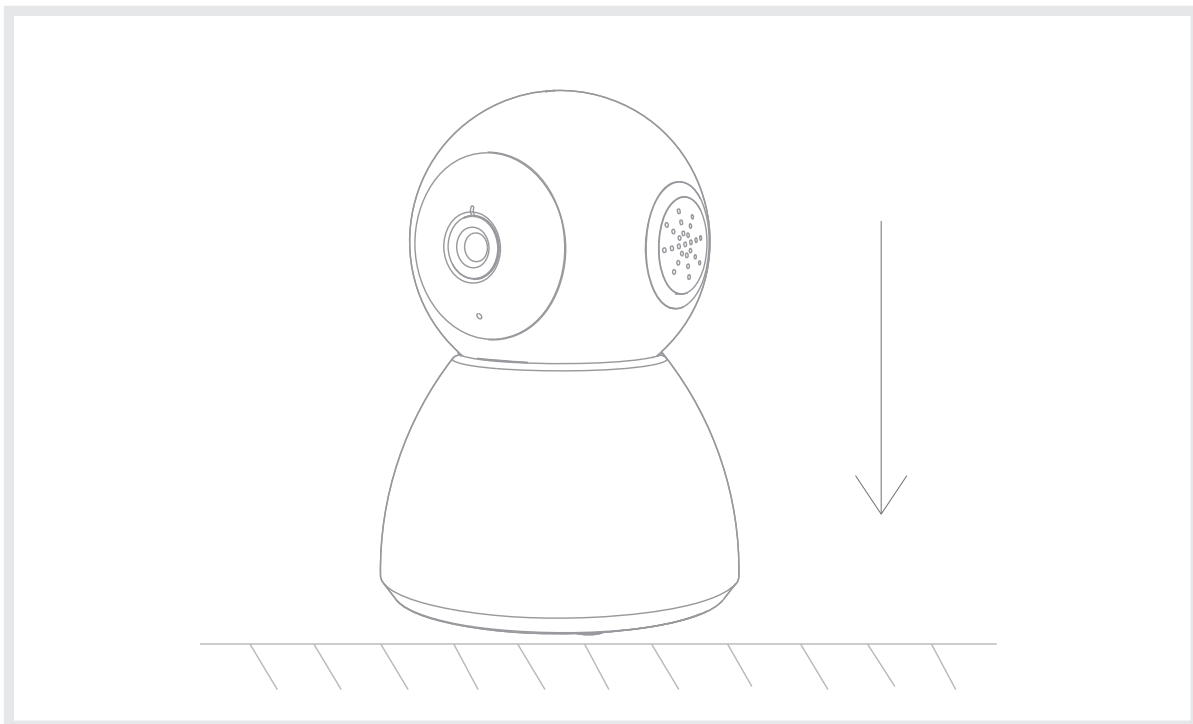

Connect

Download

Smart Life is available for both iOS and Android OS. Search the name 'Smart Life' in App Store or Android Market, or scan upper QR-Code to download the App.

• Support



iOS



Android



Download App(iOS&android)

Set up router

This device only supports 2.4GHz frequency band router, does not support 5GHz frequency band router, please set the relevant parameters of the router before WiFi configuration, WiFi passwords do not include special characters such as ~!@#\$\$%^&*(). When the device is configured in WiFi, the mobile phone and device are as close as to the router, which can speed up the configuration of the device.



Please keep network available

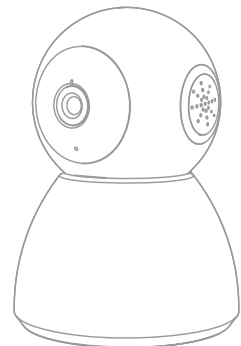

Registration process

Step 1 Open the Smart Life App, click "Register", read the "Privacy Policy" and click "Agree" .

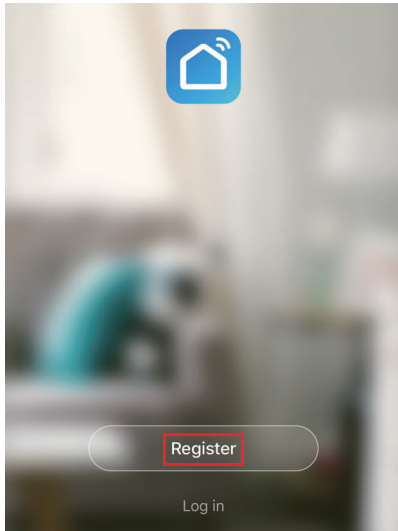

Update date: 2018.4
Come into force date: 2018.5

So you have purchased our Smart LifeSmart device hardware and are starting to use the Smart LifeSmart device software and all its functionalities! Any information you share with us (e.g. for creating a Smart Life Account) will help us to provide you with services related to Smart LifeSmart device and to improve them to make them even better. We explain here our ways of collecting and using information, and how we protect your privacy. In this privacy policy, "personal data" means information that can be used to identify an individual, either from that information alone, or from that information and other information we have access to about that individual. We collect both personal and non-personal data to enable and facilitate the best user experience possible

What information is collected and how do we use it?

Disagree

Agree

Step 2 input a legal and valid Mobile number or Email address and click "Continue". Input Verification Code, then log in the app.

Register

Canada +1 >

Mobile number/Email

Continue

I agree with [Service Agreement](#) and [Privacy Policy](#)

Verification Code

Verification code has been sent to: admin@gmail.com,
Resend (56s)

QR Code Configuration

Getting started

1. Please follow the instructions and make sure the passwords are inputted correctly.
2. One device can only be added with one App account, if the device has been added with another account already, then it can't be added to any another account again.
3. The device will be unbind from previous account after been deleted from App. Further, the device will be resetted automatically once from blue light to red light.

Process

Step 1 Open the Smart Life App, click "+" or "Add Device". Then select "All" on the "Select Device Type" page.

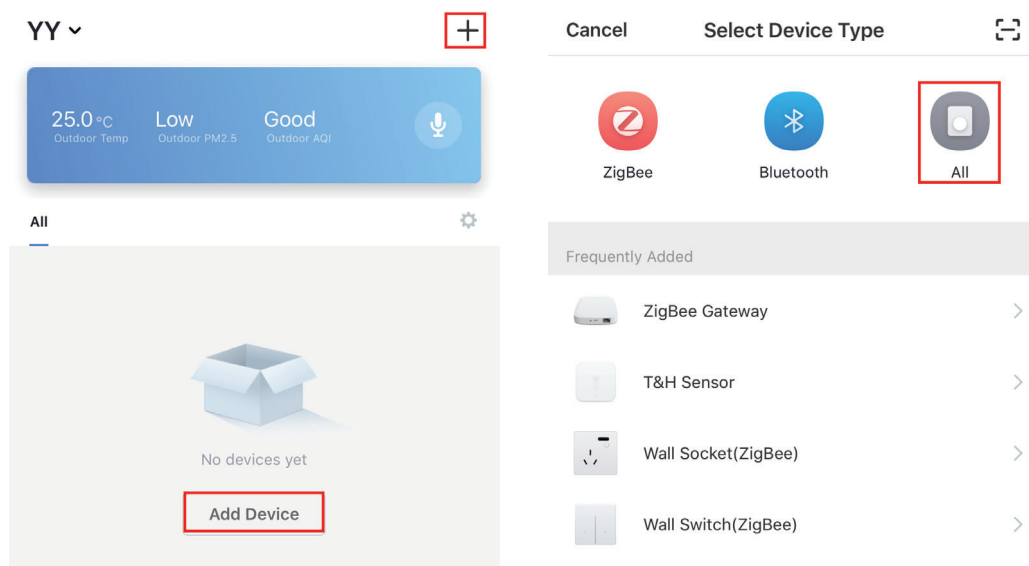

Step 2 Select "Security Camera". Power the device on and make sure the indicator is flashing quickly or a prompt tone is heard.

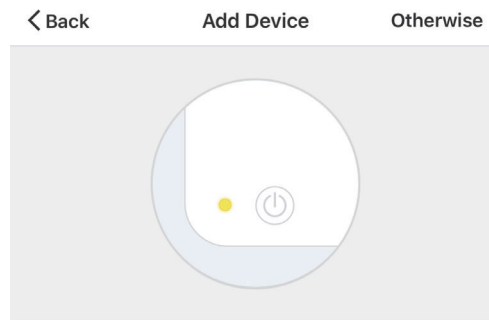
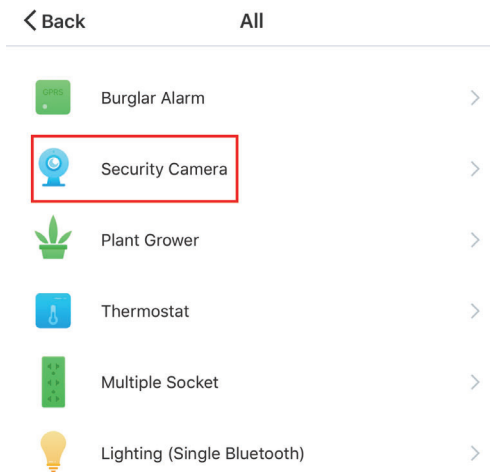

Power the device on and make sure the indicator is flashing quickly or a prompt tone is heard

[How to set the indicato...y or with a prompt tone](#)



Step 3 Input WiFi passwords and click "Confirm", scan the QR Code with a device. (You can change the network connection)

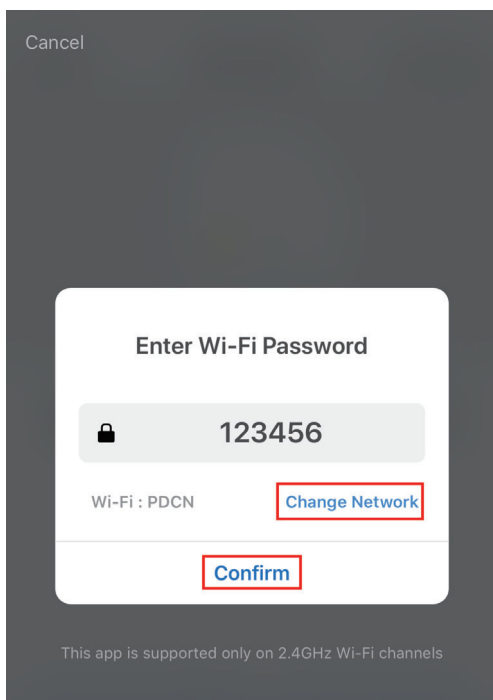

About 20cm

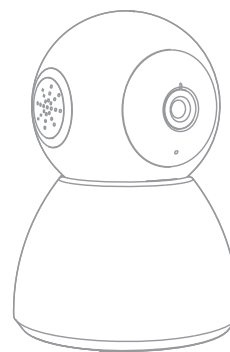

Step 4 Click "I heard the beep" when the device comes out "dong dong dong". And you can complete the configuration about 30s.

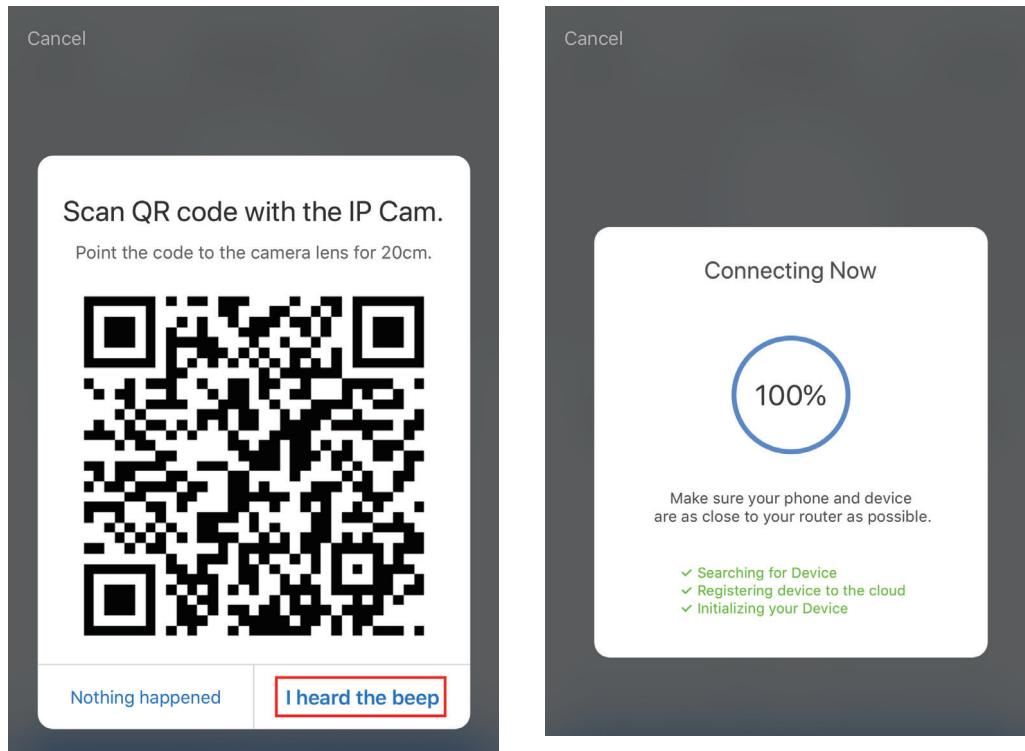

Step 5 The device is added, and the device nickname can also be changed in this interface.

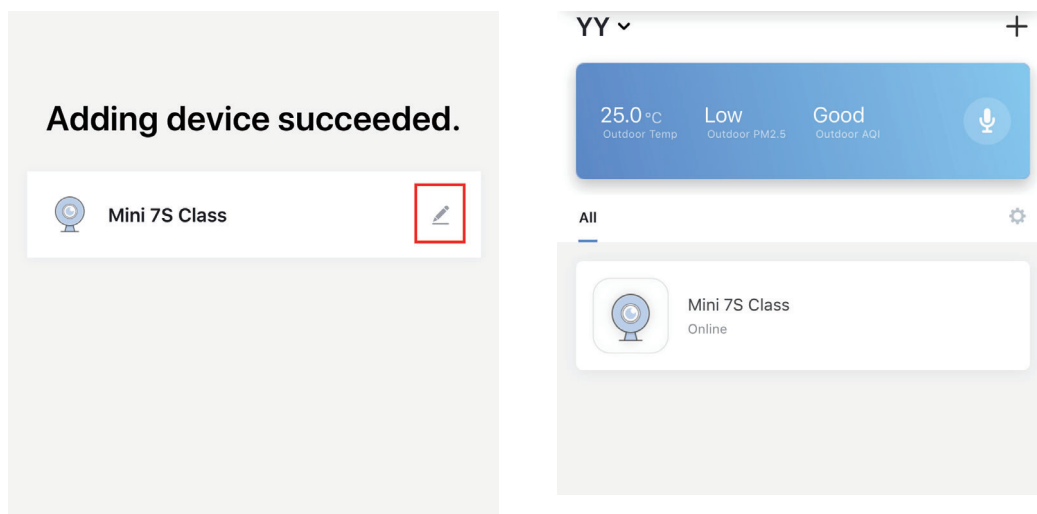

Q: The device cannot be previewed properly?

A: Check whether the network is normal, you can place the camera close to the router, and if not, it is recommended to reset the device and add it again.

Q: Why is it still in the list of devices after resetting?

A: The reset device only resets the network configuration of the camera, but cannot change the configuration on the App, remove the camera, and must be deleted by the App.

Q: How to cut the camera network to another router?

A: First remove and reset the device on the App and then configure the device again by the App.

Q: Why doesn't the device identify the SD card?

A: It is recommended to plug in SD card after power cut. Confirm whether the SD card is normally available and the format is FAT32. And the TF card can't be identified when the internet environment is not good.

Q: Why I can't get the notifications with my cell phone App?

A: Please confirm that the App has been running on the phone, and the relevant reminder function has been opened; Message notification and authority confirmation in the mobile phone system have been opened.

Functions

Pan/Tilt

Rotate your camera by sliding on your smartphone, providing you with 360 degrees of vision.

Video flip

Flip your video stream up or down for maximum flexibility.

Motion detection

Built-in motion sensors detect movement, and the camera will send you push notifications and app alerts.

Record

Support 24H continuous recording with high capacity SD storage or Cloud storage.

Day & Night

Never miss a moment, even in complete darkness, with powerful night-vision technology.



Daytime



Night

FCC Statement

This equipment has been tested and found to comply with the limits for a Class B digital device, pursuant to part 15 of the FCC Rules. These limits are designed to provide reasonable protection against harmful interference in a residential installation. This equipment generates, uses and can radiate radio frequency energy and, if not installed and used in accordance with the instructions, may cause harmful interference to radio communications. However, there is no guarantee that interference will not occur in a particular installation. If this equipment does cause harmful interference to radio or television reception, which can be determined by turning the equipment off and on, the user is encouraged to try to correct the interference by one or more of the following measures:

- Reorient or relocate the receiving antenna.
- Increase the separation between the equipment and receiver.
- Connect the equipment into an outlet on a circuit different from that to which the receiver is connected.
- Consult the dealer or an experienced radio/TV technician for help.

FCC Radiation Exposure Statement

This device complies with FCC radiation exposure limits set forth for an uncontrolled environment and it also complies with Part 15 of the FCC RF Rules. This equipment must be installed and operated in accordance with provided instructions and the antenna(s) used for this transmitter must be installed to provide a separation distance of at least 20 cm from all persons and must not be co-located or operating in conjunction with any other antenna or transmitter. End-users and installers must be provide with antenna installation instructions and consider removing the no-collocation statement.

This device complies with Part 15 of the FCC Rules. Operation is subject to the following two conditions: (1) this device may not cause harmful interference, and (2) this device must accept any interference received, including interference that may cause undesired operation.

Caution!

Any changes or modifications not expressly approved by the party responsible for compliance could void the user's authority to operate the equipment.