

Mini 18

ORIGINALITY DESIGN SMART AND BEAUTIFUL

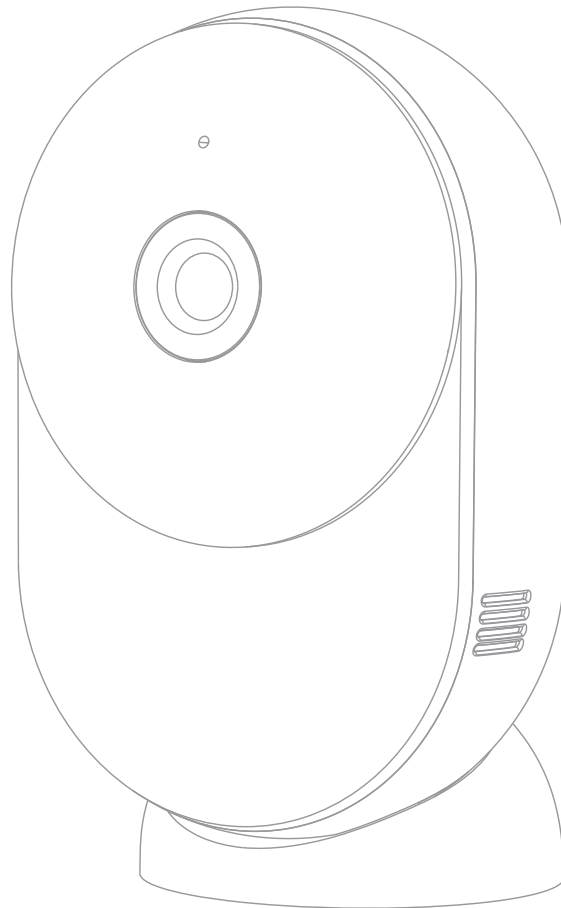

QUICK GUIDE



What's in the box

Please consult this checklist for all parts.

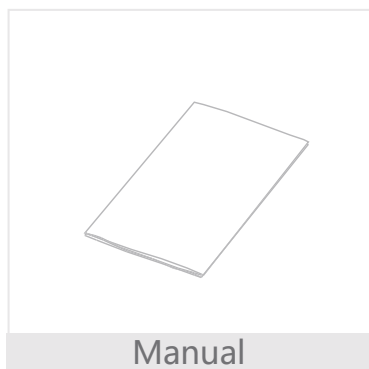
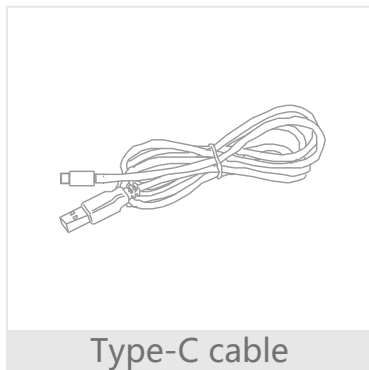
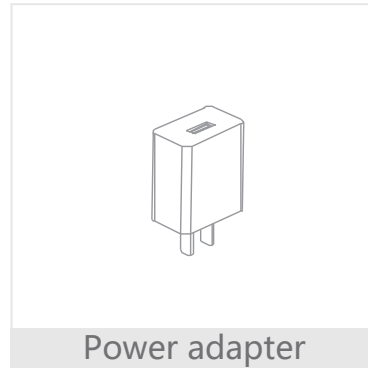

Description

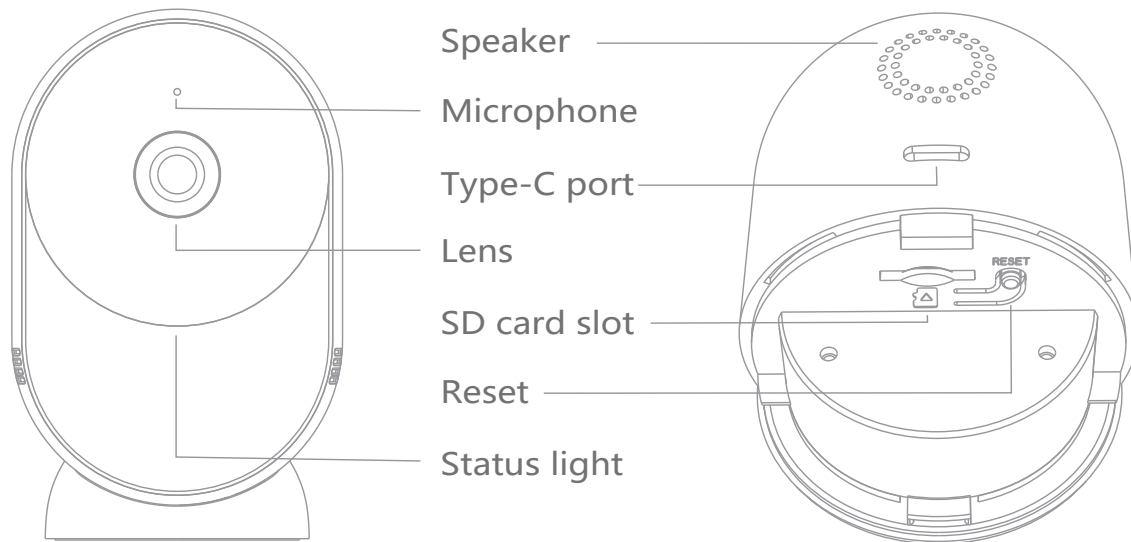

Power DC 5V±10% (Type-C)

- Status light
- Solid red light on: network is abnormal
 - Blinking red light: wait for network connection (fast blinking)
 - Solid blue light on: camera is running correctly
 - Blinking blue light: currently connecting (fast blinking)

Microphone Capture sound for your video

SD card slot Support local SD Card storage (Max.128G)

Reset Press and hold for 5 seconds with pin to reset the camera (if you have modified settings, they will return to factory defaults)

- 1 Stick the adhesive tape in the middle of camera bottom.

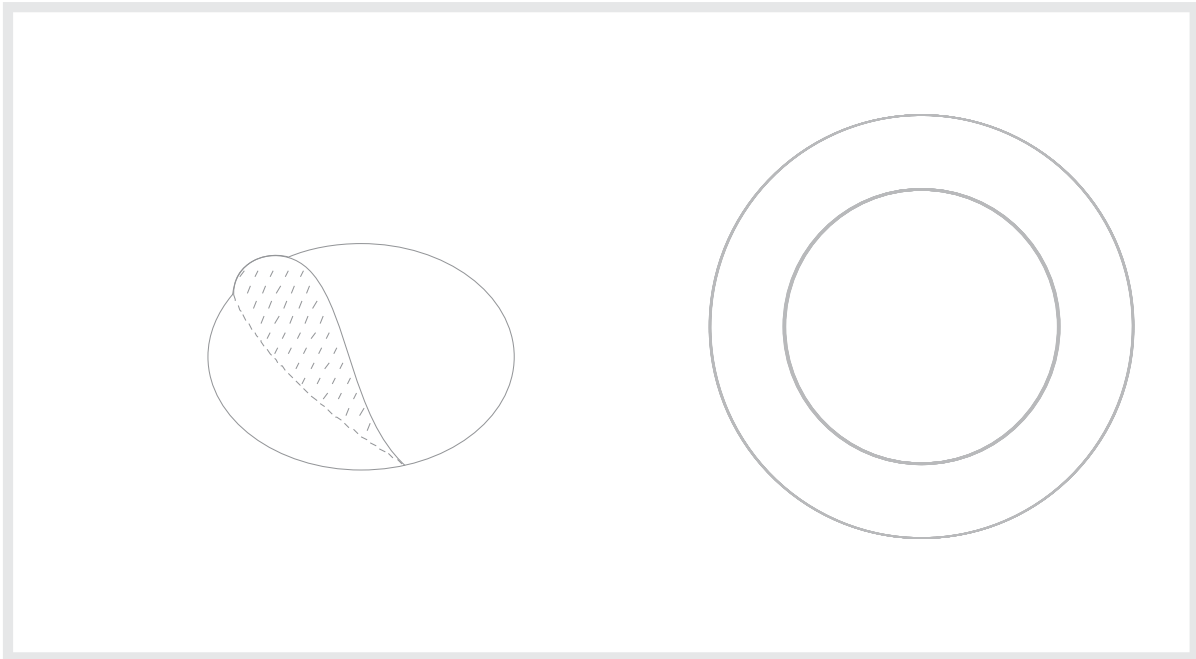

- 2 Put the camera on the clean plane.

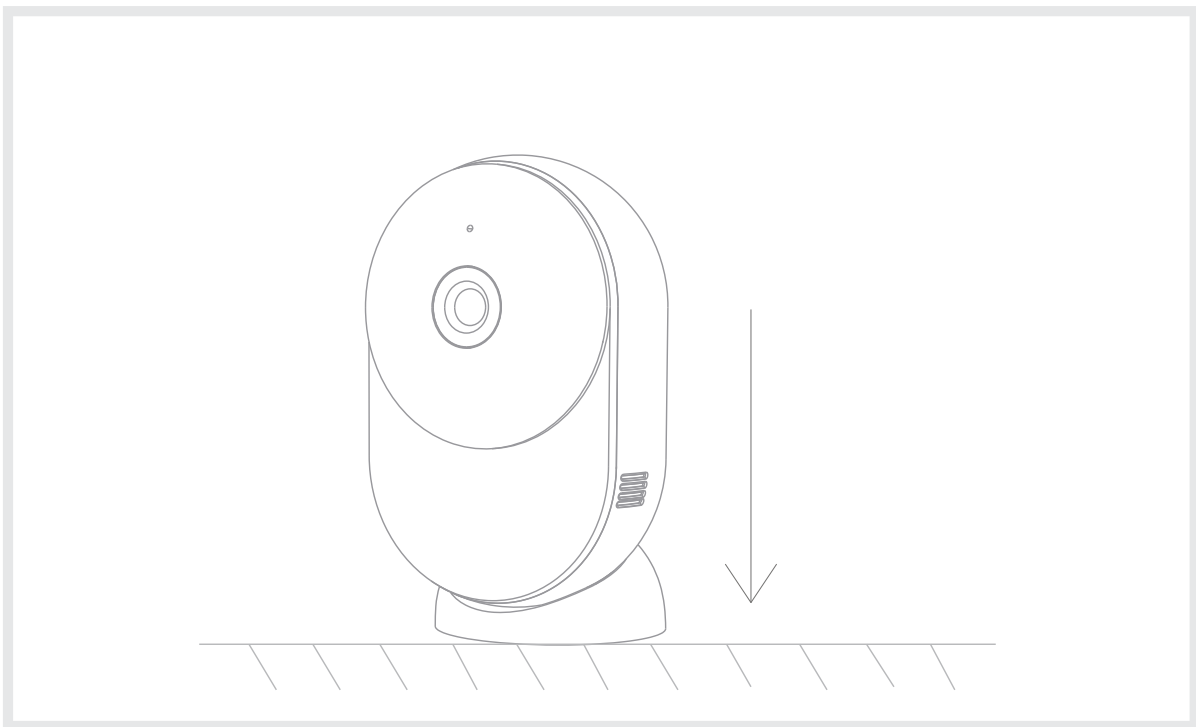

Download

Smart Life is available for both iOS and Android OS. Search the name 'Smart Life' in App Store or Android Market, or scan the QR-Code to download the App.

Support



IOS



Android



Download App(IOS&android)

Set up router

The router supports the 2.4GHz WiFi and 5GHz WiFi, and is connected to the WiFi network. Please set the parameters of the router before connecting the WiFi network, and record the SSID and password of your WiFi.



Please keep network available

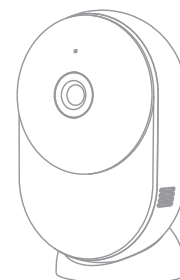

2.4GHz



5GHz



Registration process

Step 1 Open the Smart Life App, click "Register", read the "Privacy Policy" and click "Agree" .

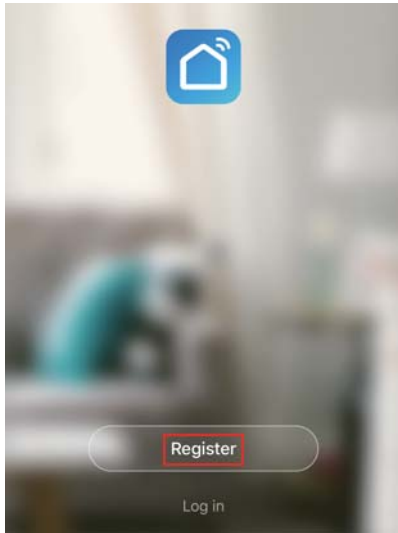

Update date: 2018.4
Come into force date: 2018.5

So you have purchased our Smart LifeSmart device hardware and are starting to use the Smart LifeSmart device software and all its functionalities! Any information you share with us (e.g. for creating a Smart Life Account) will help us to provide you with services related to Smart LifeSmart device and to improve them to make them even better. We explain here our ways of collecting and using information, and how we protect your privacy. In this privacy policy, "personal data" means information that can be used to identify an individual, either from that information alone, or from that information and other information we have access to about that individual. We collect both personal and non-personal data to enable and facilitate the best user experience possible

What information is collected and how do we use it?

Disagree

Agree

Step 2 Input a legal and valid Mobile number or Email address and click "Continue". Input Verification Code, then log in the app.

Register

Canada +1 >

Mobile number/Email

Continue

I agree with [Service Agreement](#) and [Privacy Policy](#)

Verification Code

Verification code has been sent to: admin@gmail.com, Resend (56s)

QR Code Configuration

- 1 Open the Smart Life App, click "Create family", and you can customize the Family name and related settings .

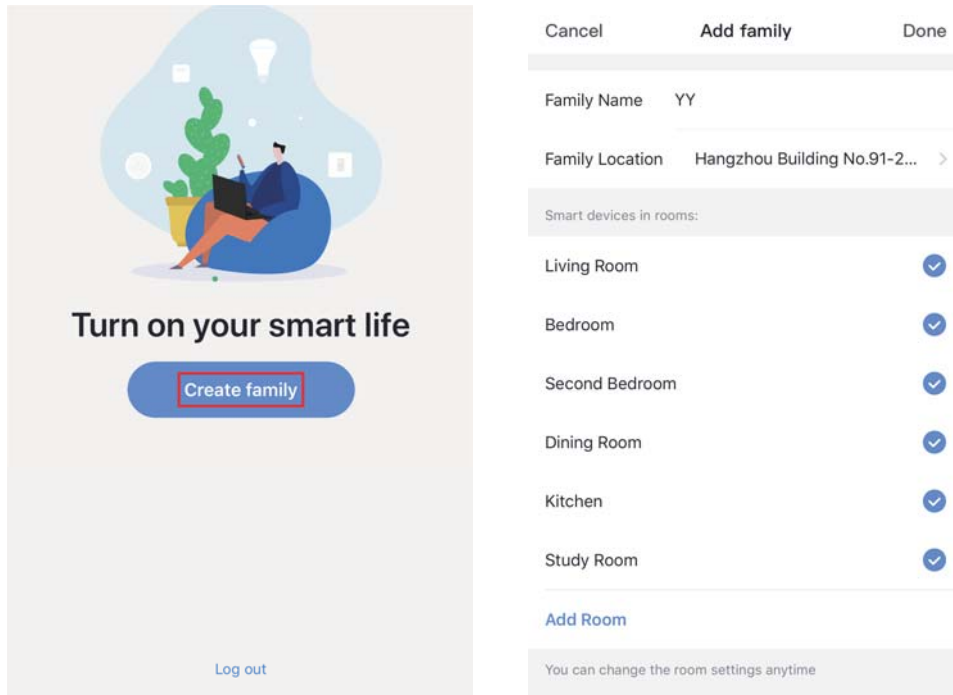

- 2 Continue to click "Security & Sensor" >> "Smart Camera", and then choose "Add Device" or "+", ready to add camera.

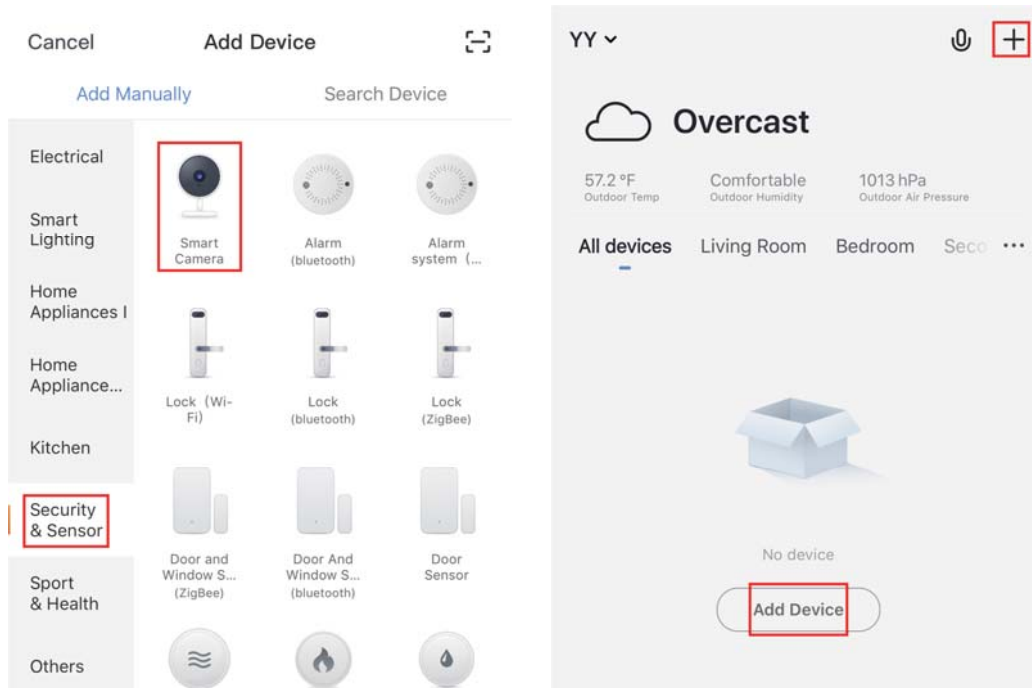

- 3 In "Add Device" this interface, continue to click "next step", and then you should input your WiFi's passwords.

Add Device

Power the device on and make sure the indicator is flashing quickly or a prompt tone is heard

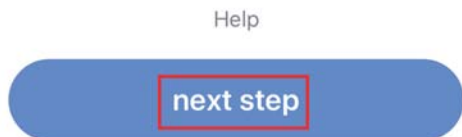
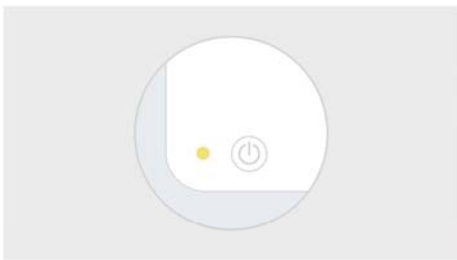

Enter Wi-Fi Password

support 2.4GHz WiFi and 5GHz WiFi



Note:

- 1) Camera supports 2.4GHz and 5GHz WiFi network.
- 2) The number of bits in the ssid and passwords of the router should not exceed 24 digits.

- 4 In this interface, you should scan the QR code in your phone with the camera, when the camera comes out "dong dong dong". And you can complete the configuration about 30s.

Scan with the camera

When you tap CONTINUE, the mobile phone displays a QR code. Hold the camera 15 to 20 cm in front of the mobile phone for the camera to scan the QR code.

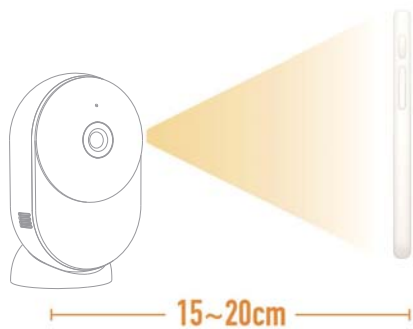

Continue



Heard nothing at all

Heard the beep

- 5 When connecting, you should make sure your router, mobile, and camera are as close as possible. When camera added successfully, click "✎" you could also DIY the camera's name.

Connecting

Make sure your router, mobile, and device are as close as possible



- ✓ Device found
- ✓ Register device to the smart cloud
- ✓ Initializing device

Device added successfully

 Smart Camera 

Living Room

Bedroom

Second...edroom

Dining Room

Kitchen

Study Room

Completed

Settings

In "Smart Camera" interface,click "",you can set the camera common functions.

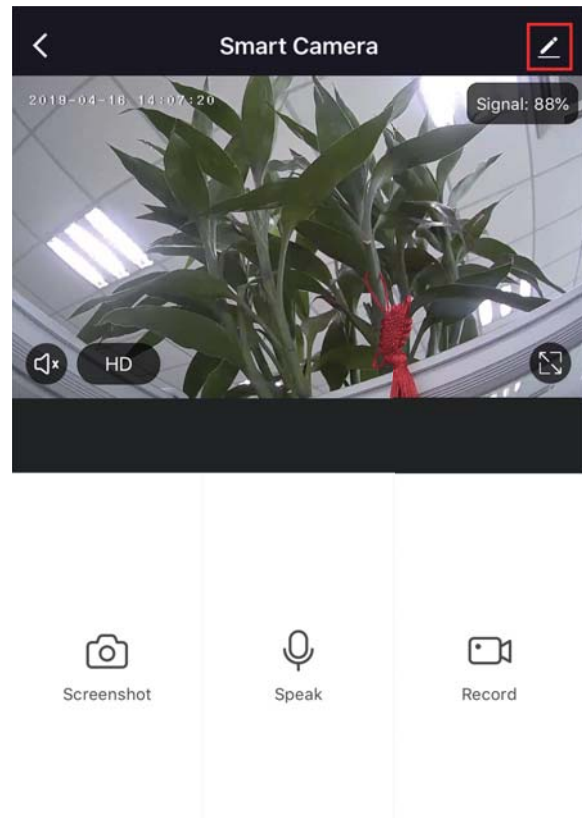
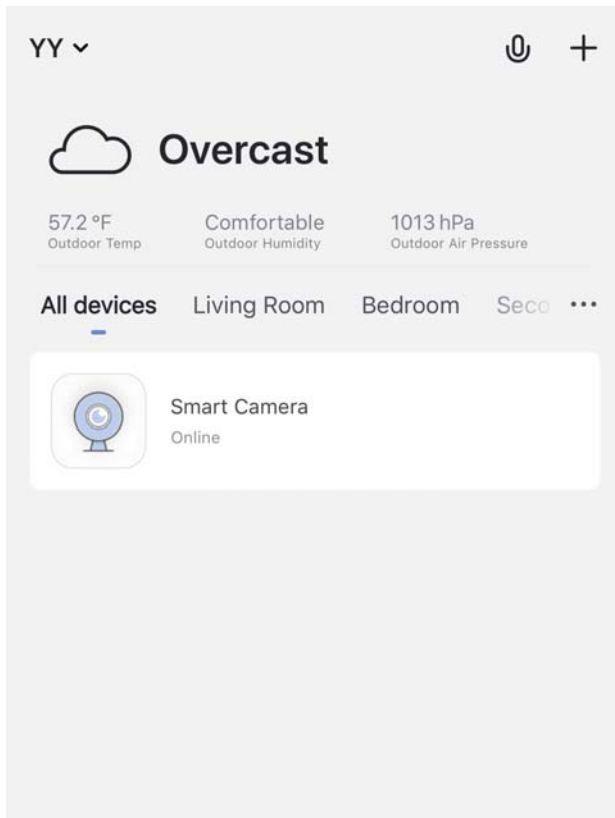

Q: The device cannot be previewed properly?

A: Check whether the network is normal, you can place the camera close to the router, and if not, it is recommended to reset the device and add it again.

Q: Why is it still in the list of devices after resetting?

A: The reset device only resets the network configuration of the camera, but cannot change the configuration on the App, remove the camera, and must be deleted by the App.

Q: How to cut the camera network to another router?

A: First remove and reset the device on the App and then configure the device again by the App.

Q: Why doesn't the device identify the SD card?

A: It is recommended to plug in SD card after power cut. Confirm whether the SD card is normally available and the format is FAT32. And the TF card can't be identified when the internet environment is not good.

Q: Why I can't get the notifications with my cell phone App?

A: Please confirm that the App has been running on the phone, and the relevant reminder function has been opened; Message notification and authority confirmation in the mobile phone system have been opened.

Video flip

Flip your video stream up or down for maximum flexibility.

Motion detection

Built-in motion sensors detect movement, and the camera will send you push notifications and app alerts.

Record

Support 24H continuous recording with high capacity SD storage or Cloud storage.

Daytime & Night

Never miss a moment, even in complete darkness, with powerful night-vision technology.

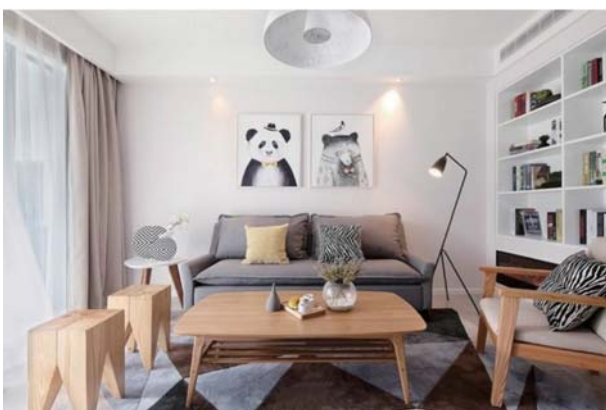

Daytime



Night

FCC Statement :

Any Changes or modifications not expressly approved by the party responsible for compliance could void the user's authority to operate the equipment.

This device complies with part 15 of the FCC Rules. Operation is subject to the following two conditions:

- (1) This device may not cause harmful interference, and
- (2) this device must accept any interference received, including interference that may cause undesired operation.

FCC Radiation Exposure Statement:

This equipment complies with FCC radiation exposure limits set forth for an uncontrolled environment. This equipment should be installed and operated with minimum distance 20cm between the radiator and your body.

Note: This equipment has been tested and found to comply with the

limits for a Class B digital device, pursuant to part 15 of the FCC Rules. These limits are designed to provide reasonable protection against harmful interference in a residential installation. This equipment generates uses and can radiate radio frequency energy and, if not installed and used in accordance with the instructions, may cause harmful interference to radio communications. However, there is no guarantee that interference will not occur in a particular installation. If this equipment does cause harmful interference to radio or television reception, which can be determined by turning the equipment off and on, the user is encouraged to try to correct the interference by one or more of the following measures:

- Reorient or relocate the receiving antenna.
- Increase the separation between the equipment and receiver.
- Connect the equipment into an outlet on a circuit different from that to which the receiver is connected.
- Consult the dealer or an experienced radio/TV technician for help.