

Bell 5S

ORIGINALITY DESIGN SMART – AND BEAUTIFUL

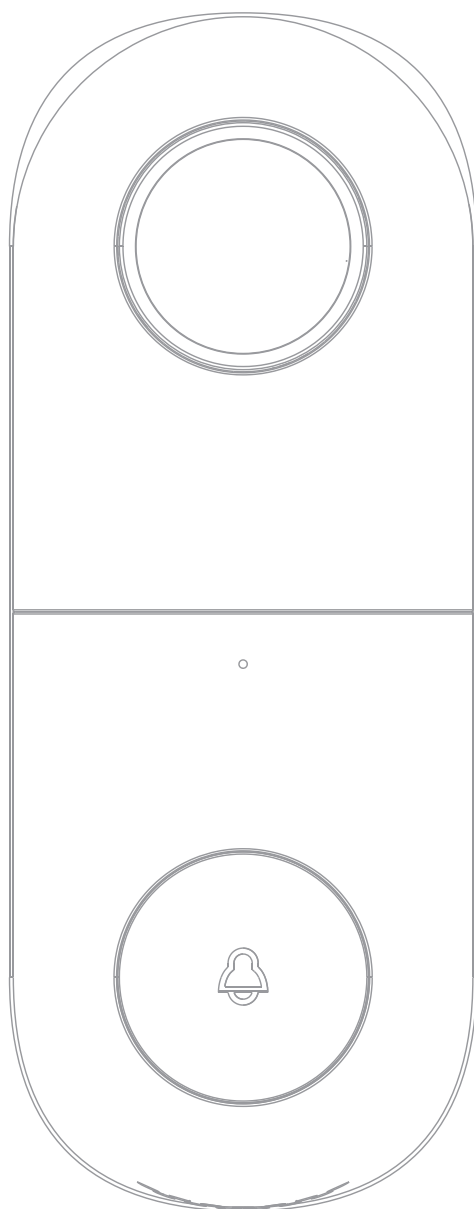

QUICK GUIDE



What's in the box

Please consult this checklist for all parts.

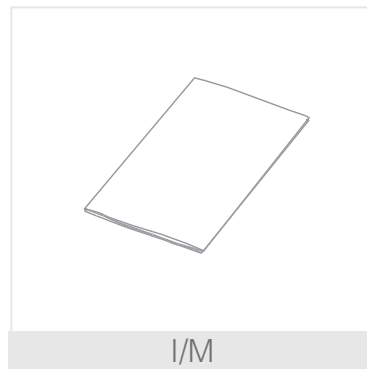
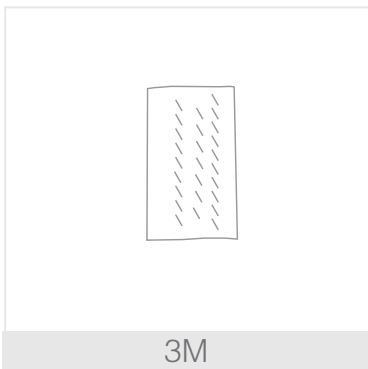
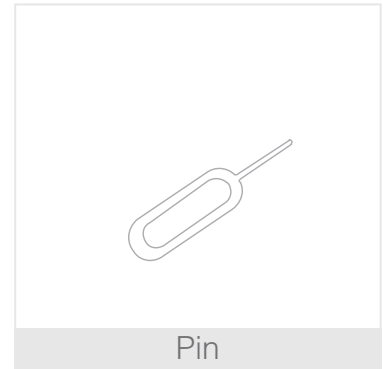
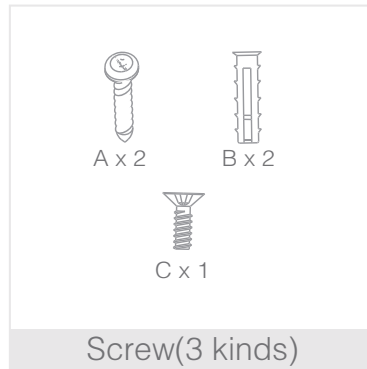
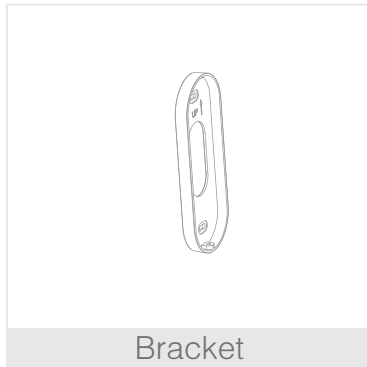

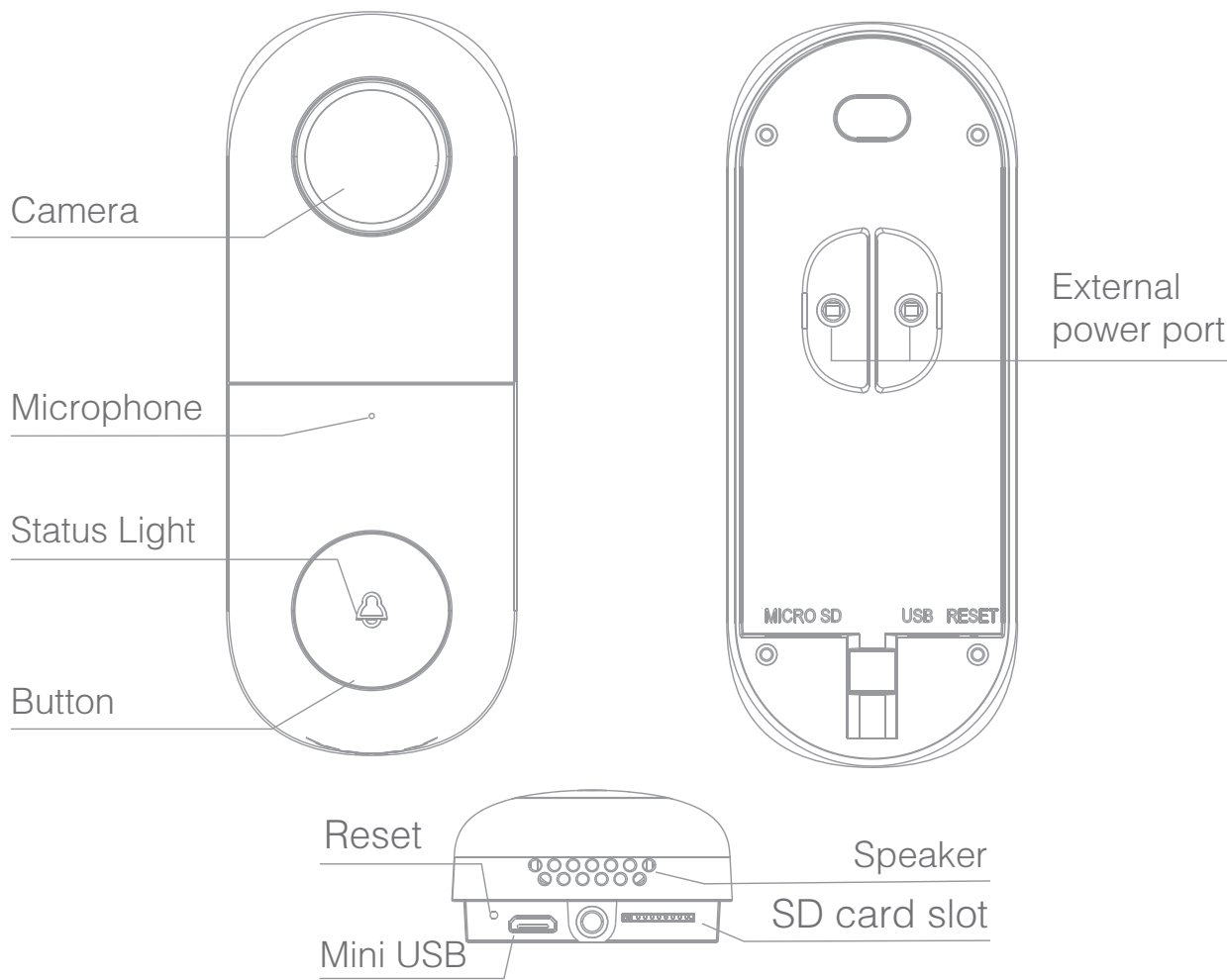

Description

Power Port	AC 12V~24V/DC 5V
Doorbell button	Press the button to activate the doorbell
Status light	<ul style="list-style-type: none"> • Red light solids on: the camera or network is abnormal • Red light blinking: awaiting WiFi connection, or currently connecting (faster blinking) • Blue light solids on: camera running correctly
Microphone	Captures sound for your video
SD card slot	Supports local SD Card storage (Max.128G)
Reset	Press and hold on for 5 seconds with pin to reset the doorbell (unable to unbind the bell from account)

Install

Mode 1 Doorbell General Installation

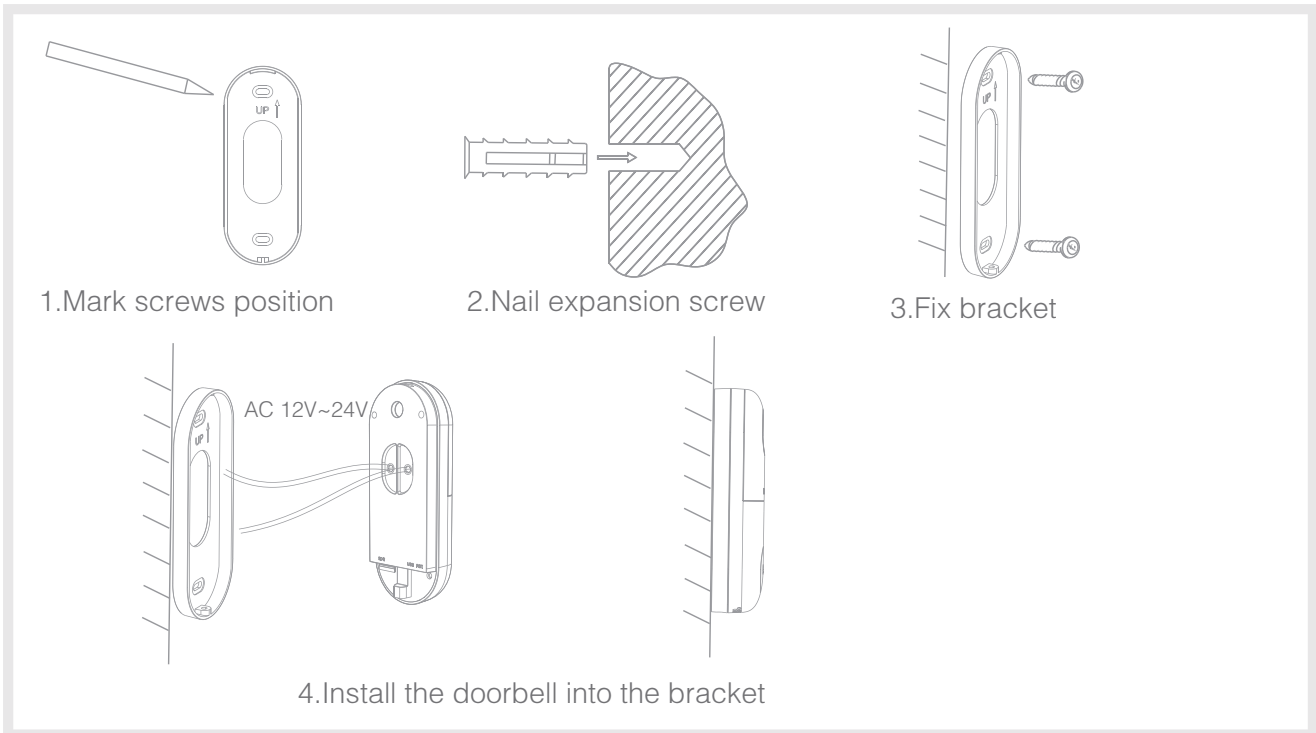

Mode 2 Angle Wall Mount + bracket + doorbell installation

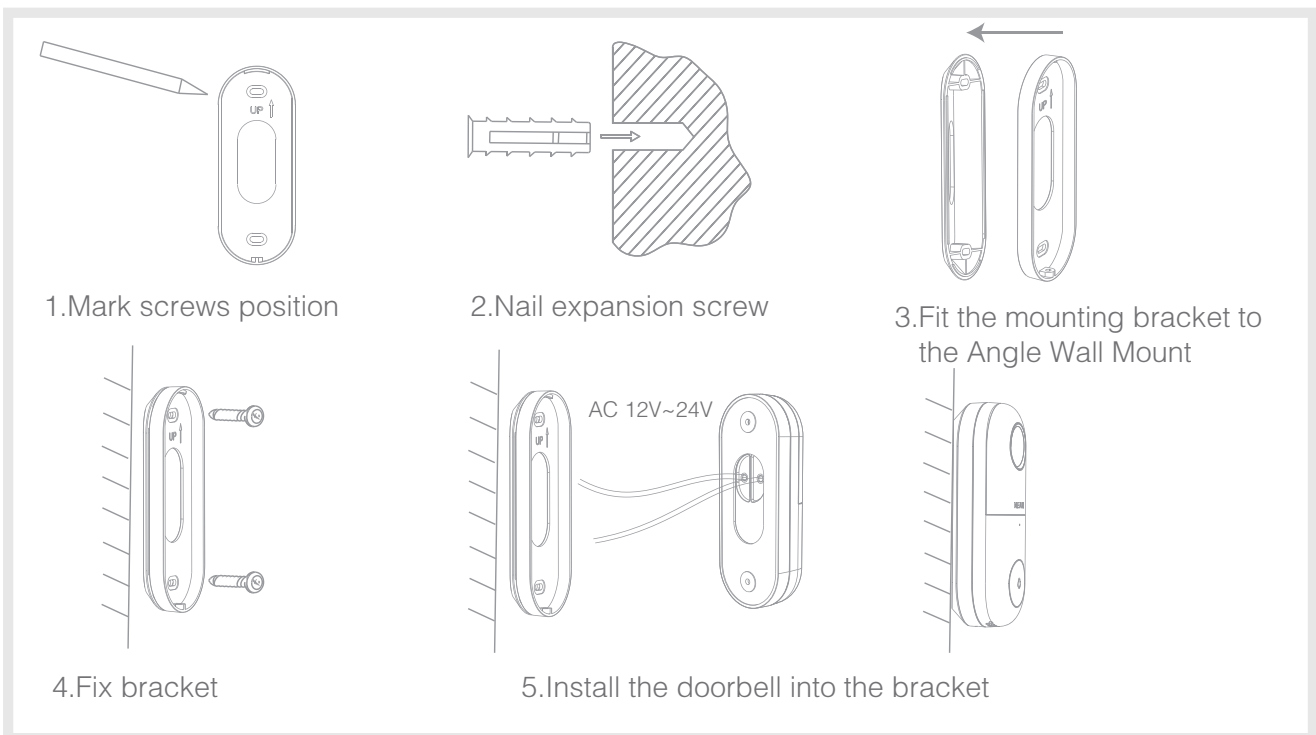

Connect

Download

Smart Life is available for both iOS and Android OS. Search the name 'Smart Life' in App Store or Android Market, or scan the QR-Code to download the App.

• Support



iOS



Android



Download App(iOS&android)

Set up router

This device only supports 2.4GHz frequency band router, does not support 5GHz frequency band router, please set the relevant parameters of the router before WiFi configuration, WiFi passwords do not include special characters such as ~!@#\$\$%^&*(). When the device is configured in WiFi, the mobile phone and device are as close as to the router, which can speed up the configuration of the device.

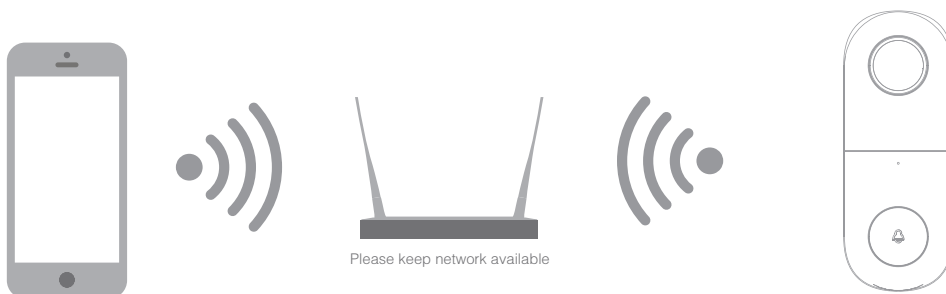

Registration process

Step 1 Open the Smart Life App, click "Register", read the "Privacy Policy" and click "Agree" .

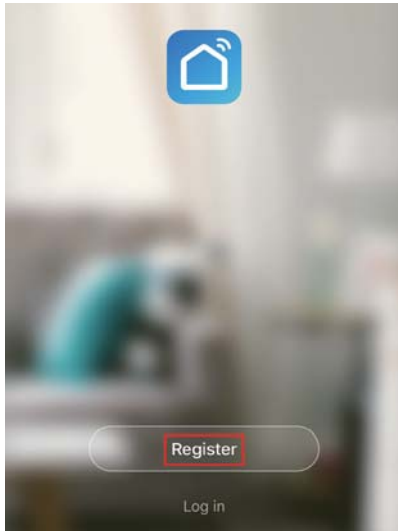

Update date: 2018.4
Come into force date: 2018.5

So you have purchased our Smart LifeSmart device hardware and are starting to use the Smart LifeSmart device software and all its functionalities! Any information you share with us (e.g. for creating a Smart Life Account) will help us to provide you with services related to Smart LifeSmart device and to improve them to make them even better. We explain here our ways of collecting and using information, and how we protect your privacy. In this privacy policy, "personal data" means information that can be used to identify an individual, either from that information alone, or from that information and other information we have access to about that individual. We collect both personal and non-personal data to enable and facilitate the best user experience possible

What information is collected and how do we use it?

Disagree

Agree

Step 2 input a legal and valid Mobile number or Email address and click "Continue". Input Verification Code, then log in the app.

Register

Canada +1 >

Mobile number/Email

Continue

I agree with Service Agreement and Privacy Policy

Verification Code

Verification code has been sent to: admin@gmail.com,
Resend (56s)

QR Code Configuration

- 1 Open the Smart Life App, click "Create family", and you can customize the Family name and related settings .

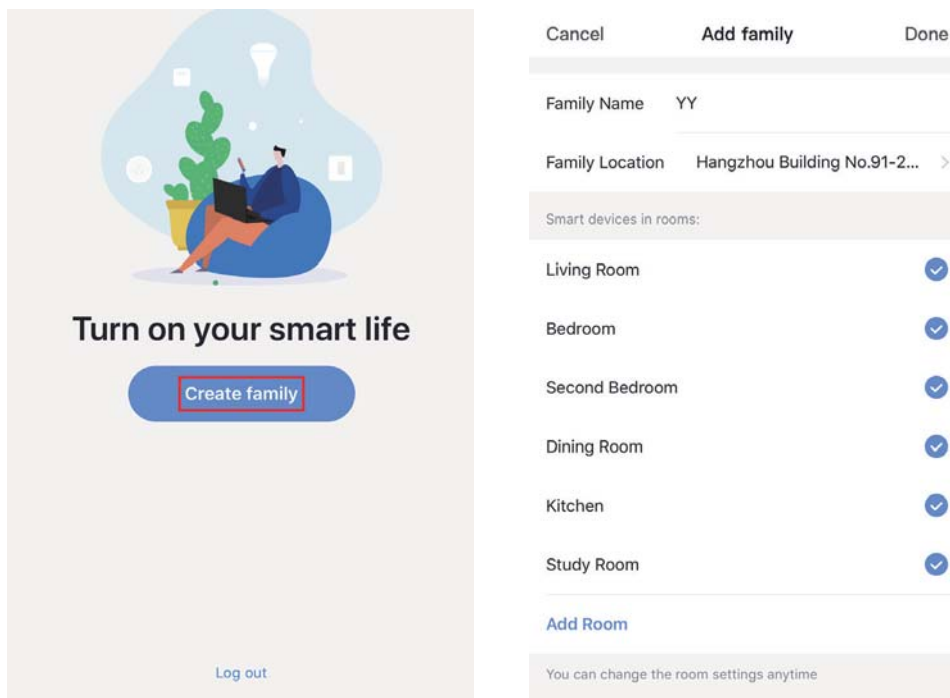

- 2 Continue to click "Security & Sensor" >> "Smart Camera", and then choose "Add Device" or "+", ready to add camera.

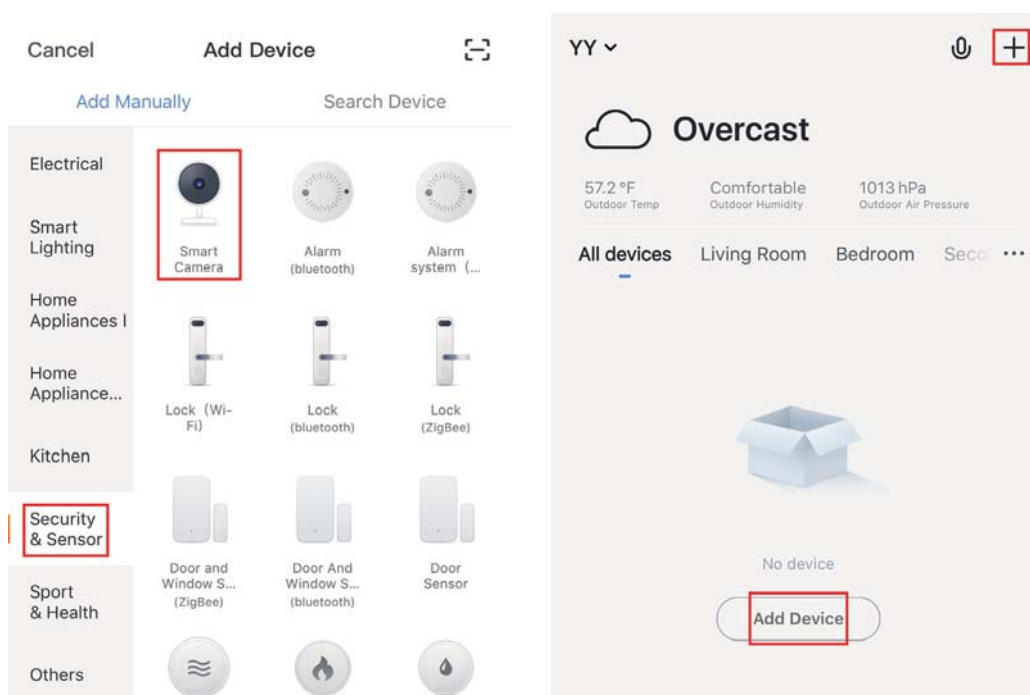

- 3 In "Add Device" this interface, continue to click "next step", and then you should input your WiFi's passwords.

Add Device

Power the device on and make sure the indicator is flashing quickly or a prompt tone is heard

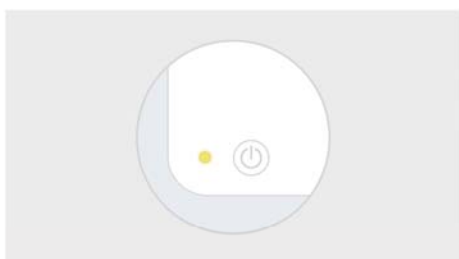

Enter Wi-Fi Password

Only support 2.4GHz Wi-Fi network

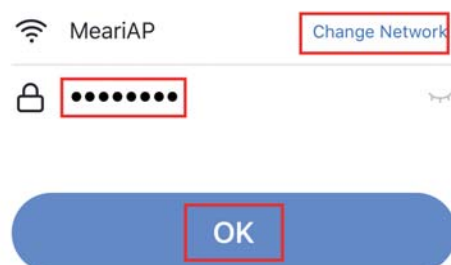
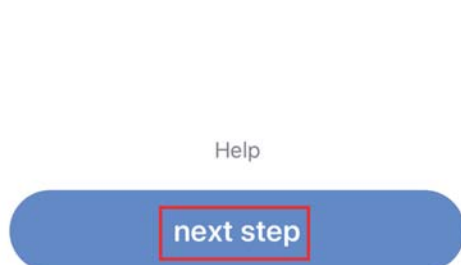

Note:

- 1) Camera only supports 2.4GHz WiFi network.
- 2) The number of bits in the ssid and passwords of the router should not exceed 24 digits.

- 4 In this interface, you should scan the QR code in your phone with the camera, when the camera comes out "dong dong dong". And you can complete the configuration about 30s.

Scan with the camera

When you tap CONTINUE, the mobile phone displays a QR code. Hold the camera 15 to 20 cm in front of the mobile phone for the camera to scan the QR code.

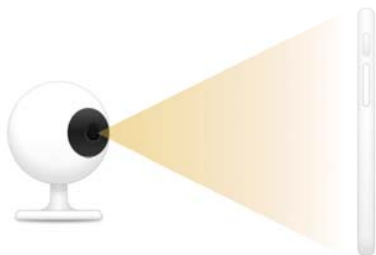

Continue



Heard nothing at all

Heard the beep

- 5 When connecting, you should make sure your router, mobile, and camera are as close as possible. When camera added successfully, click " " you could also DIY the camera's name.

Connecting

Make sure your router, mobile, and device are as close as possible



- ✓ Device found
- ✓ Register device to the smart cloud
- ✓ Initializing device

Device added successfully

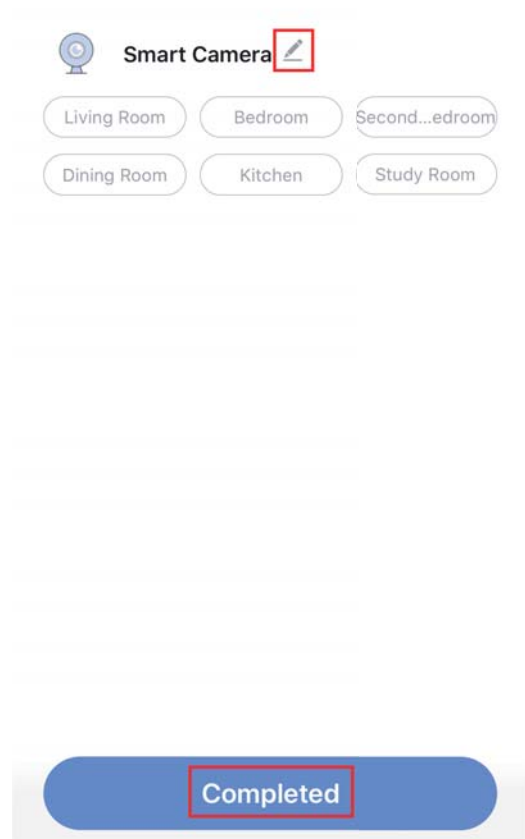

Settings

In "Smart Camera" interface,click "",you can set the camera common functions.

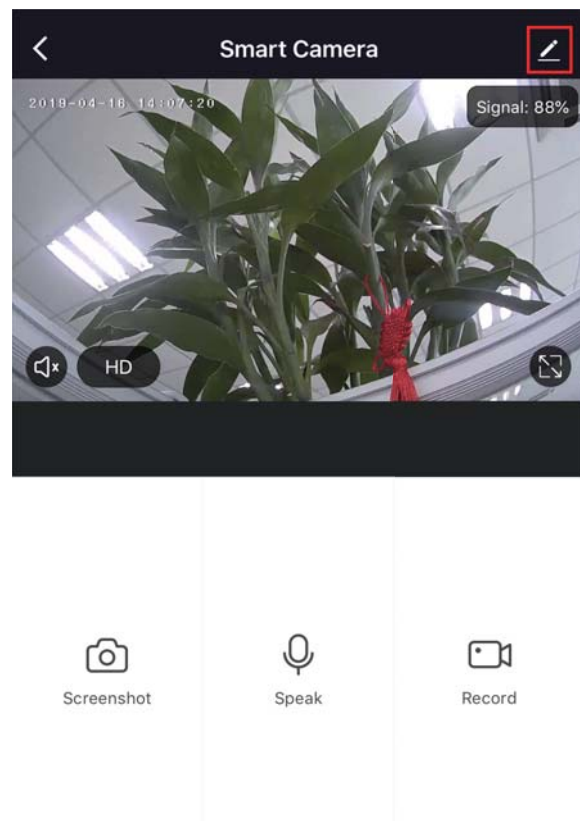
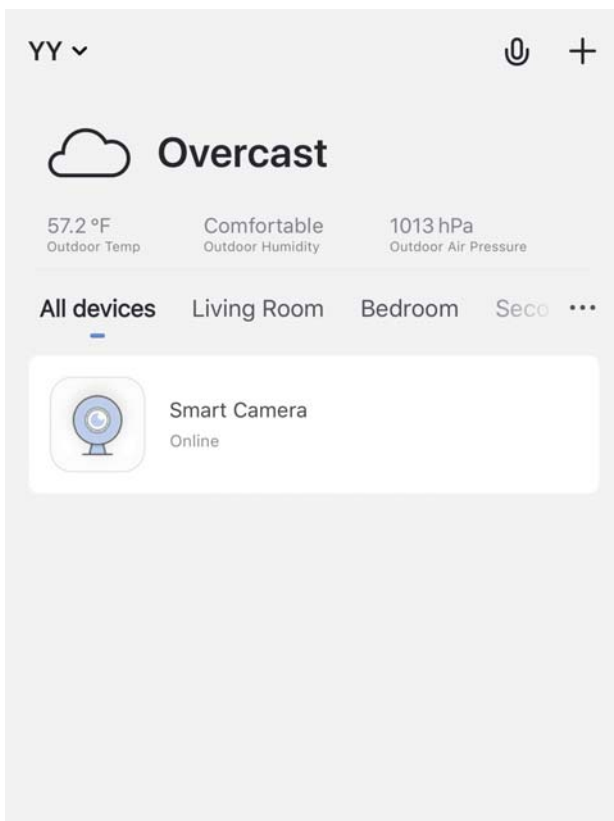

Functions

Full-duplex audio

When the visitor push the doorbell button, you will get a call. You can see and hear the vistor in your App from the doorbell if you answer.

Motion detection

Motion sensors will notify you when movement is detected.

Shared device

The doorbell device can be shared with friends, and friends can also preview online. There is no limit to the number of sharing devices, but only 6 accounts are supported for online preview at the same time.

Record

Record every moment using high capacity SD card storage.

Day & Night

Powerful night vision means no interruptions, even in complete darkness.



Daytime



Night

Q: In the network process, the process bar is always not 100%, add failure?

A: This camera only supports 2.4GHz WiFi router, please make sure you are using a 2.4GHz WiFi router. And confirm the WiFi password again.

Q: Repeated additions are failures?

A: After adding a failure, it is recommended to restart the device or power off, and then try to add again.

Q: The device cannot be previewed properly?

A: Check whether the network is normal, you can place the camera close to the router, and if not, it is recommended to reset the device and add it again.

Q: How to cut the camera network to another router?

A: First remove and reset the device on the App and then configure the device again by the App.

Q: Why I can't get the notifications with my cell phone App?

A: Please confirm that the App has been running on the phone, and the relevant reminder function has been opened; Message notification and authority confirmation in the mobile phone system have been opened.

Q: Why doesn't the device identify the SD card?

A: It is recommended to plug in SD card after power cut. Confirm whether the SD card is normally available and the format is FAT32. And the TF card can't be identified when the internet environment is not good.

Jingle appearance

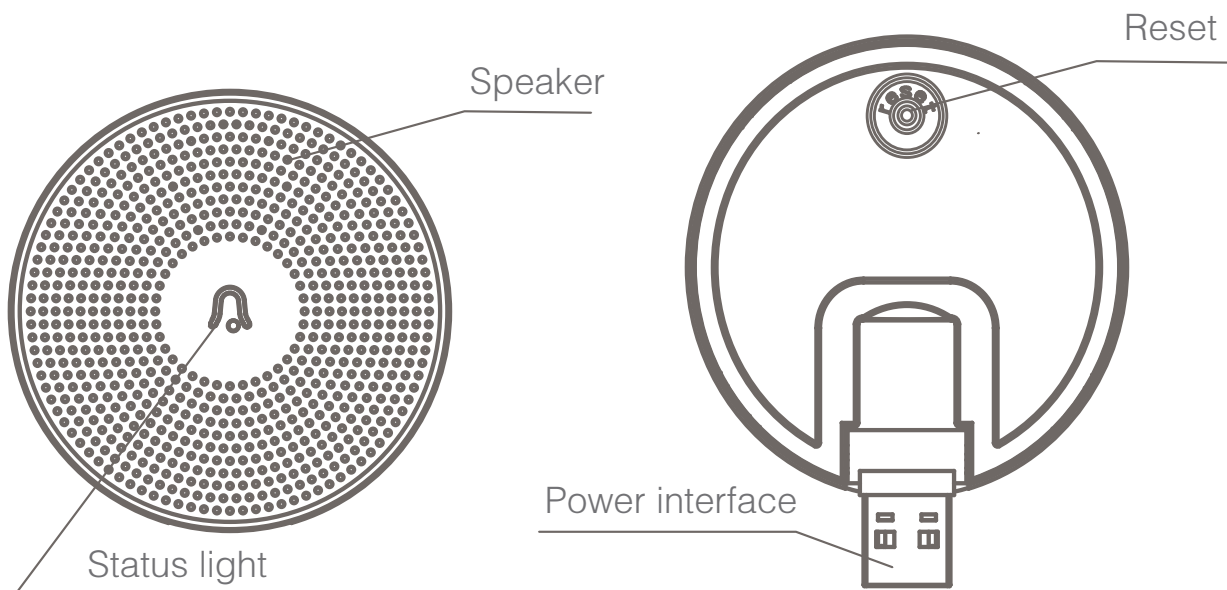

Description

Mini USB DC5V \pm 10%,USB power supply

Reset Press the RESET for 5s to restore Factory Settings;

Click the RESET button to pair the doorbell

Status light Blue light blinking: Awaiting for configuration;

Blue light solid on: Configuration completed

Functions

Jingle to choose

You can choose your own ringtone among the four ringtones

Jingle of volume

The device's volume could be adjusted by sliding the volume of your smartphone

Jingle pairing

- Step 1: Click the "RESET" button, the blue light blinks and enter the configuration mode.
- Step 2: Access to "SETTINGS" of your APP, press "Bell Setting".
- Step 3: Select the ringtone, adjust the volume, and press "Bell Connection" button.
- Step 4: Press "Start Connect" button, the device will be connected about 2s.
- Step 5: Press "Connected", the blue light is on, we complete the configuration.

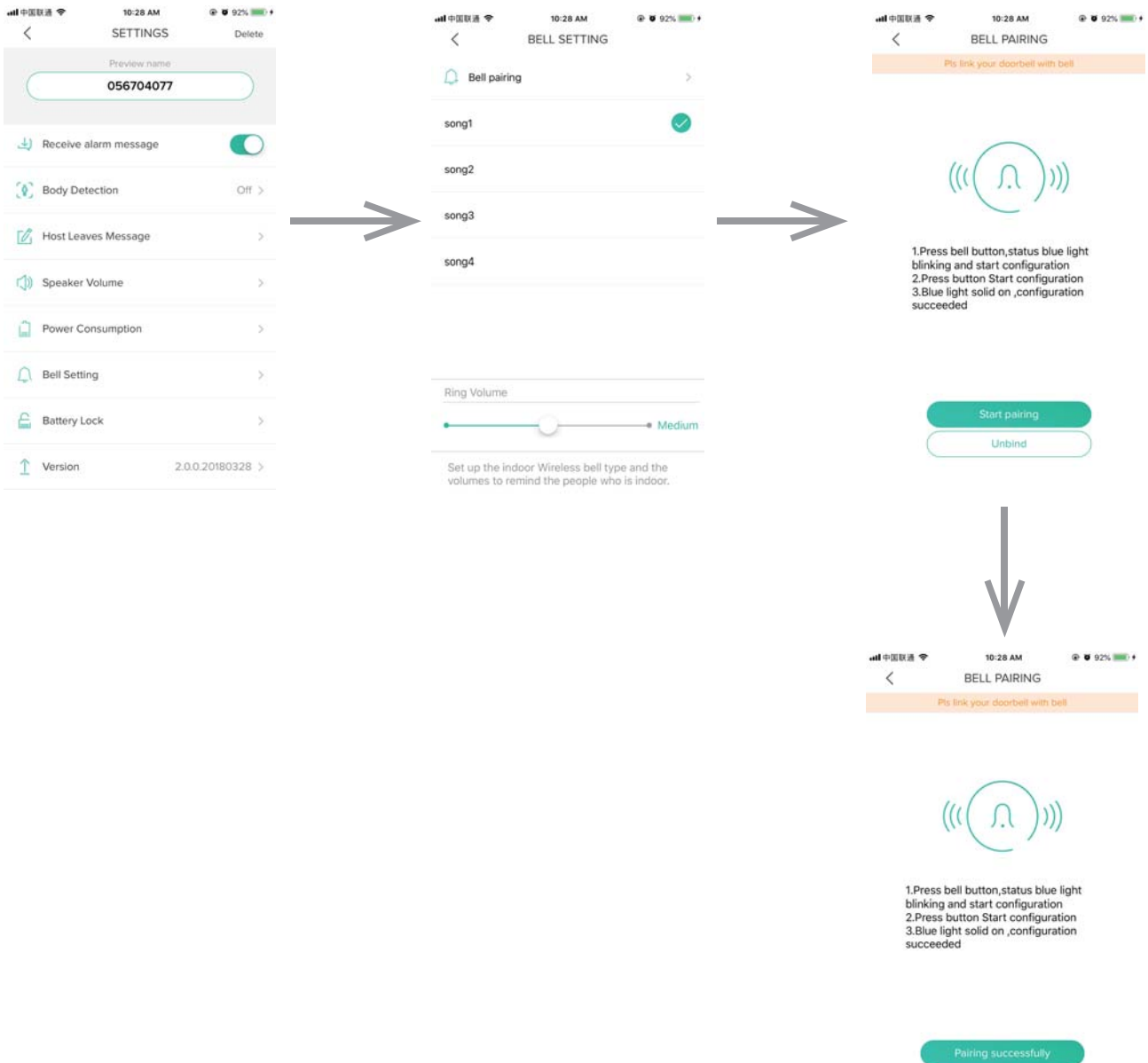

FCC Statement

Any Changes or modifications not expressly approved by the party responsible for compliance could void the user's authority to operate the equipment.

This device complies with part 15 of the FCC Rules. Operation is subject to the following two conditions:

- (1) This device may not cause harmful interference, and
- (2) This device must accept any interference received, including interference that may cause undesired operation.

FCC Radiation Exposure Statement:

This equipment complies with FCC radiation exposure limits set forth for an uncontrolled environment. This equipment should be installed and operated with minimum distance 20cm between the radiator & your body.

IMPORTANT NOTE:

Note: This equipment has been tested and found to comply with the limits for a Class B digital device, pursuant to part 15 of the FCC Rules. These limits are designed to provide reasonable protection against harmful interference in a residential installation. This equipment generates, uses and can radiate radio frequency energy and, if not installed and used in accordance with the instructions, may cause harmful interference to radio communications. However, there is no guarantee that interference will not occur in a particular installation. If this equipment does cause harmful interference to radio or television reception, which can be determined by turning the equipment off and on, the user is encouraged to try to correct the interference by one or more of the following measures:

- Reorient or relocate the receiving antenna.
- Increase the separation between the equipment and receiver.
- Connect the equipment into an outlet on a circuit different from that to which the receiver is connected.
- Consult the dealer or an experienced radio/TV technician for help.