

Speed 14SE

创意家庭 - 智慧便捷

.....



快速操作指南

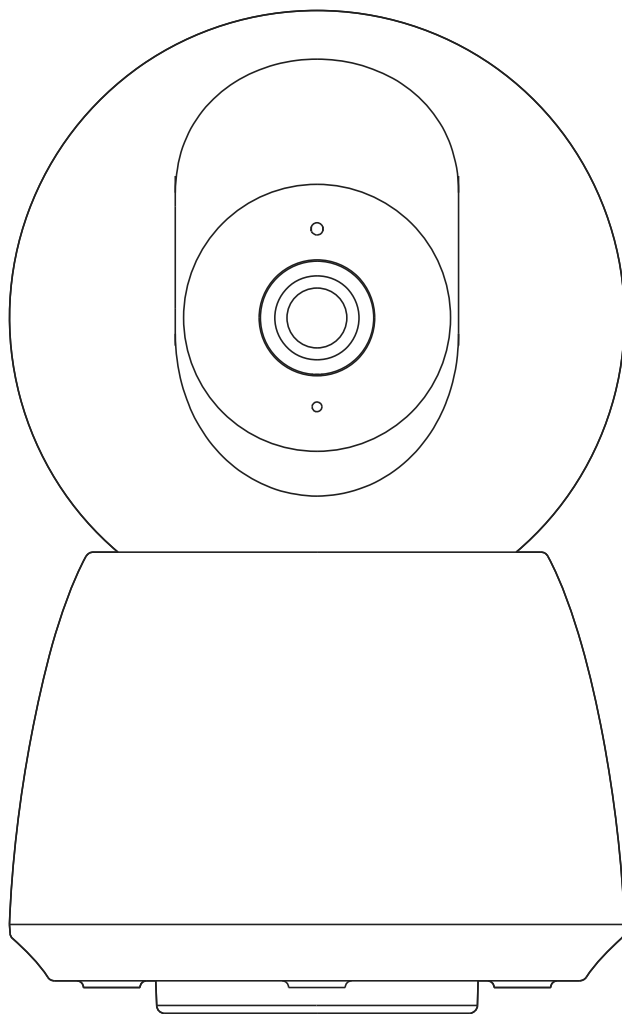

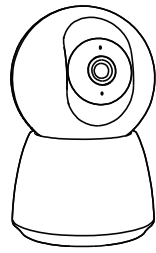

Speed 14

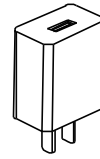

适配器

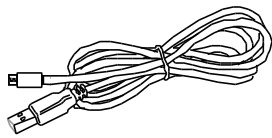

USB接口线

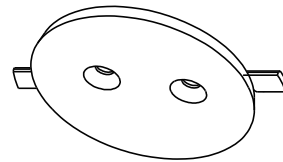

安装支架

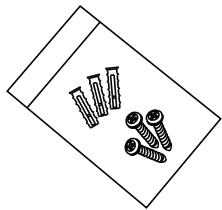

安装螺钉

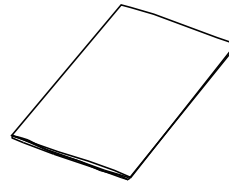

操作手册

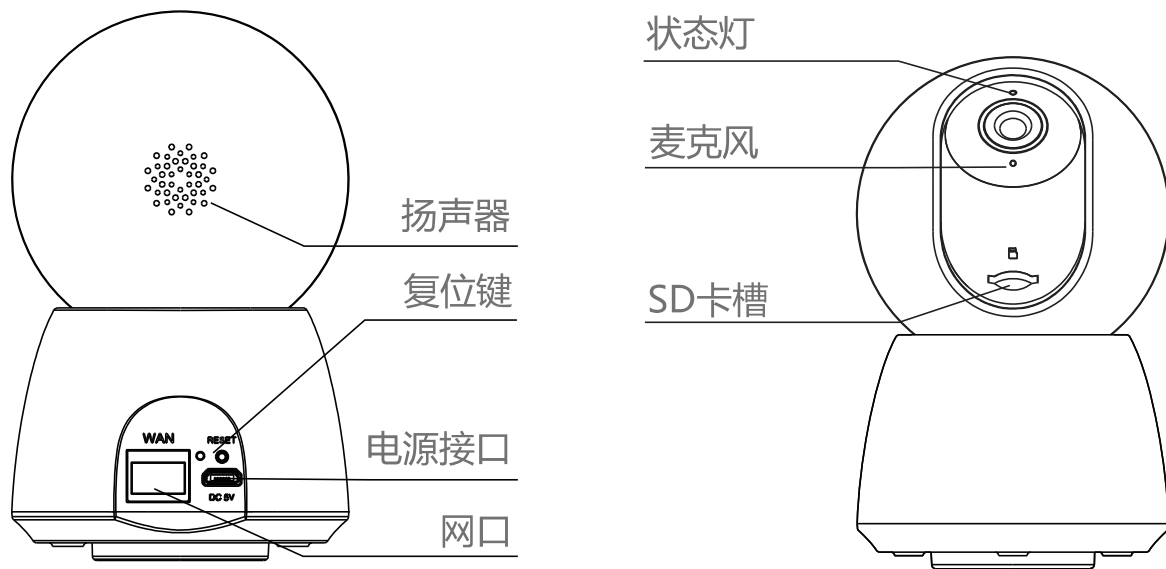

电源 DC 5V/1A

状态灯

- 红灯慢闪：等待配网
- 红灯快闪：正在连接网络
- 红灯常亮：网络异常
- 蓝灯常亮：连接成功，正在运行

麦克风

声音输入，在查看图像时同时听到声音

SD卡槽

支持SD卡本地存储（最大支持128G）

复位键

长按主机上Reset键5秒，重置摄像机，恢复出厂设置（摄像机修改网络需要长按复位键恢复出厂设置）

网口

有线网络接口。摄像机支持通过网络电缆接入网络，以防摄像机安装无线网络覆盖不到的地方，例如地下室。请确保网络电缆连接摄像机至路由器或中继器。

- 1 将相机安装在干净平整的平面上。

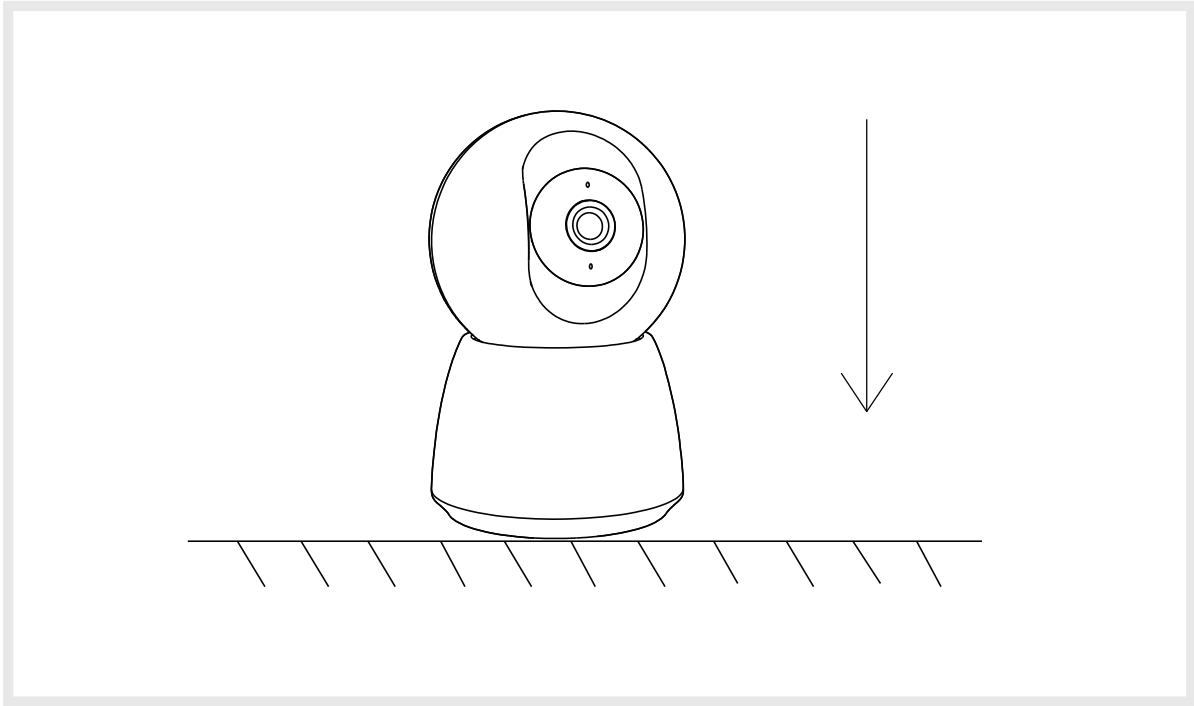

- 2 用螺钉将在安装支架安装至平面，然后将相机固定于安装支架中。

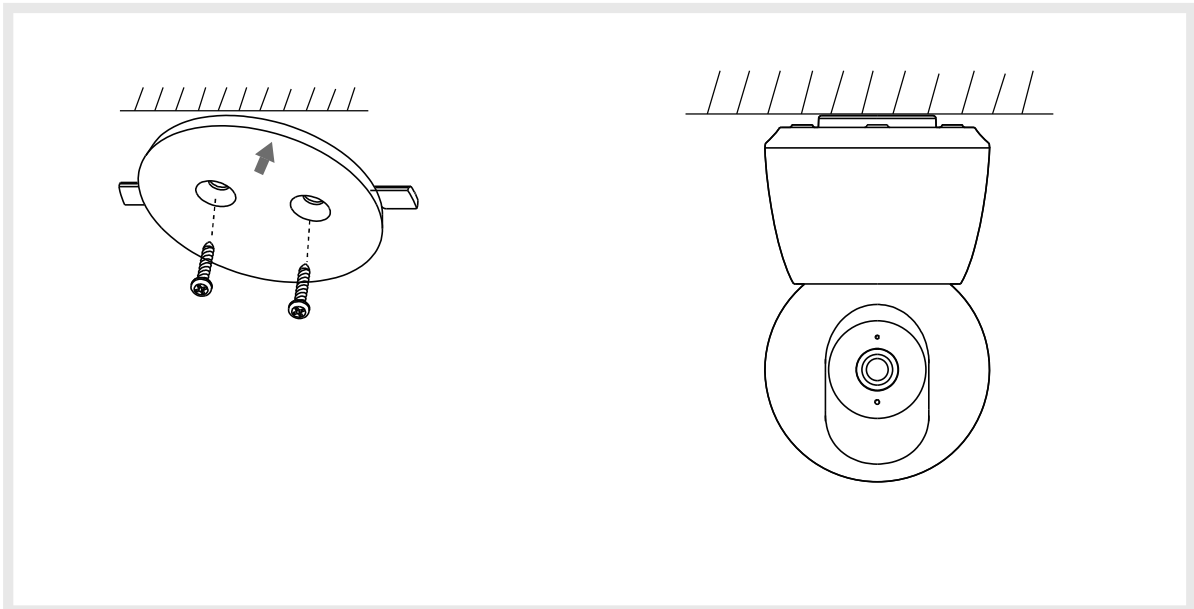

App下载

"智能生活"App和"涂鸦智能"App, 兼容iOS和Android系统。在应用商店或安卓市场搜索软件名称或扫码下载App。请根据需求下载对应的软件。

·App支持



ipad



IOS



Android



下载App (IOS&android)

设置路由器

摄像机兼容网络电缆和无线网络。且摄像机仅支持2.4GHz WiFi (不支持5GHz)。

•方法1:

使用网络线缆。提前准备长度合适的网络线缆将, 并确保路由器参数已设置完毕且网络稳定流畅。

建议使用网络电缆将摄像机连入网络。

•方法2:

使用无线网络。提前设置路由器参数, 并记录SSID和密码。

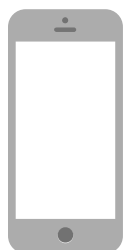

请保持WiFi网络畅通

方法 2

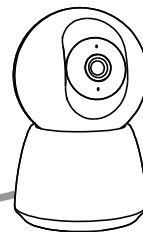

方法 1

2.4GHz



5GHz



注册及登录

步骤1 (以下操作均以"智能生活"App操作为例)
打开"智能生活"App, 单击"注册", 阅读"用户协议与隐私政策", 单击"同意"。



步骤2 输入合法有效的手机号码或电子邮件地址, 然后单击"获取验证码"。
输入验证码以登录。



- 1 请先连接您的智能手机至稳定且通畅的WiFi网络。

提前准备长度合适的网络线缆。（网络线缆需连接摄像机和为手机提供WIFI的路由器。网络线缆的长度，请考虑摄像机的安装位置，以及路由器的位置。）

- 2 将网络线缆的一端连接至摄像机，另一端连接至为手机提供WIFI的路由器。

备注：

- 1) 摄像机仅支持2.4GHz WiFi（不支持5GHz）
- 2) 路由器SSID和密码的位数需小于24位。

- 3 打开"智能生活"App，单击"我的>>家庭管理>>创建家庭"，您可以自定义家庭名称及相关设置。



4 单击"添加设备"或"+", 选择"安防监控", 根据相应的摄像机选择图标。



5 单击"↔" 更改配网方式, 选择"有线配网"来连接设备。
接通设备电源并重置摄像机, 直至状态指示灯快速闪烁或听到提示音, 再单击"下一步"。



- 6 在设备添加列表中，选择所需的设备，点击"+"。



- 7 配网时，请确保您的路由器，智能手机和设备相距不远。成功添加设备后，您可以单击"✎"自定义设备名称。



8 在预览界面，您可以单击"☒"来设置设备的通用参数。

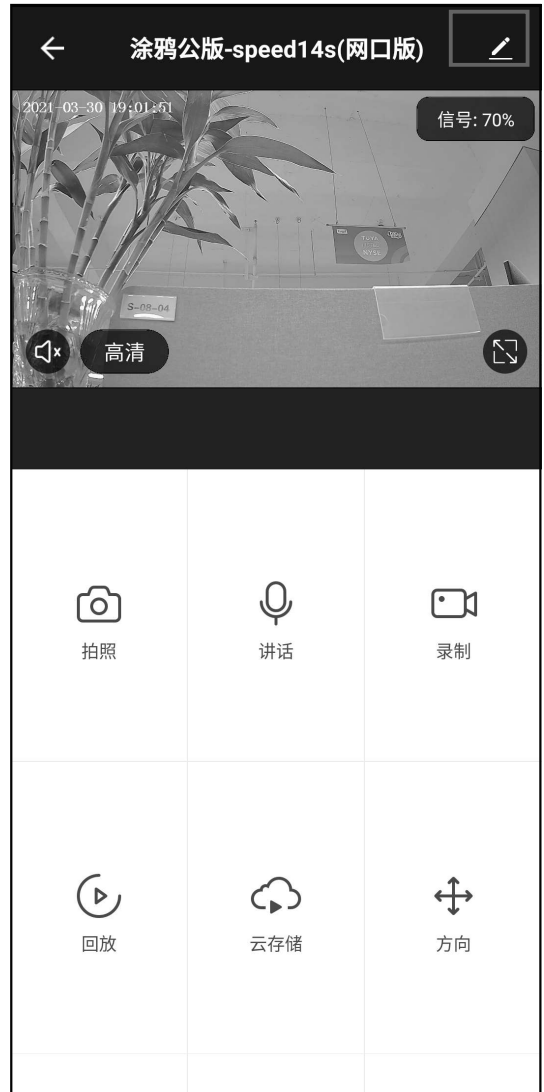
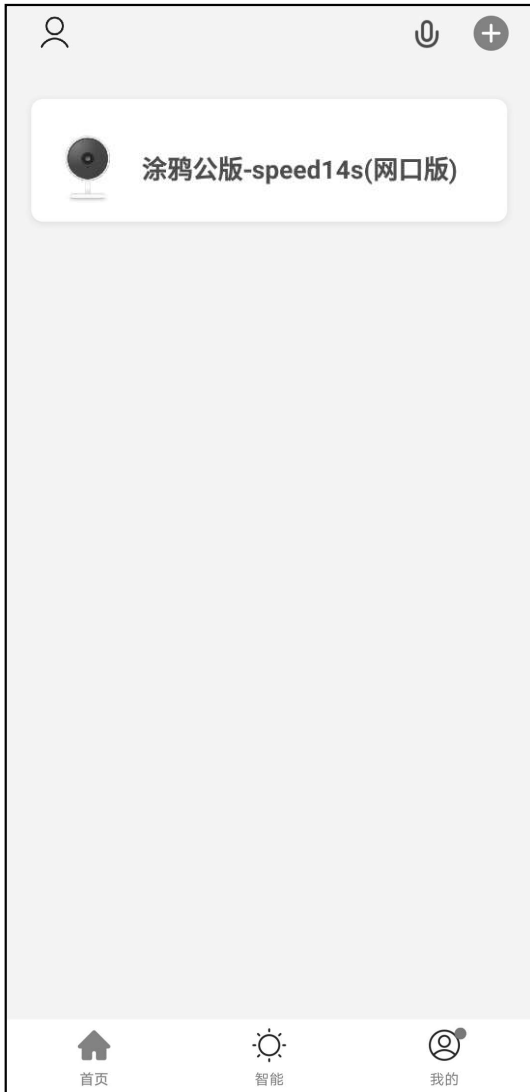

Q: 设备不能正常预览?

A: 检查网络信号是否过弱, 可将设备放置在离路由器近处, 若还不行
建议重置设备, 再次添加

Q: 复位设备后, 设备列表里怎么还有?

A: 复位设备只是重置摄像机的网络连接设置, 而无法改变App上的配置,
删除摄像机, 必须登陆上App删除

Q: 如何更换摄像机的网络环境?

A: 首先在App上移除并重置设备, 然后通过App再次给设备进行网络设置

Q: 为什么识别不到SD卡?

A: 建议断电后在进行SD卡的插拔。SD卡是否正常可用, 格式是否为
FAT32。手机端网络或者设备端的网络不稳定情况下, App也会提示识
别不到TF卡

Q: 设备在线并且有报警事件, 手机端接收不到信息?

A: 请确认App中相关提醒功能已打开; 手机系统中消息通知和权限已开启

云台控制

使用手机APP任意方向转动摄像机，体验不同的视角，捕捉到你想要的任意角落

画面翻转

设备安装后可能导致图像倒置，在App上打开设备的画面翻转功能，即可恢复图像正置

移动报警

智能检测家中的异常移动并上报通知，让您安心出门工作、游玩。根据摄像机安装后的视野，可设置报警等级高低，使报警更精准

录像存储

支持SD卡24小时连续录像，不让您错失家中的任何细节

日夜切换

可自动切换白天模式和晚上模式，不论白天晚上，都给你一个清晰流畅的视角



白天模式



夜间模式

FCC Statement

This equipment has been tested and found to comply with the limits for a Class B digital device, pursuant to part 15 of the FCC Rules. These limits are designed to provide reasonable protection against harmful interference in a residential installation. This equipment generates, uses and can radiate radio frequency energy and, if not installed and used in accordance with the instructions, may cause harmful interference to radio communications. However, there is no guarantee that interference will not occur in a particular installation. If this equipment does cause harmful interference to radio or television reception, which can be determined by turning the equipment off and on, the user is encouraged to try to correct the interference by one or more of the following measures:

- Reorient or relocate the receiving antenna.
- Increase the separation between the equipment and receiver.
- Connect the equipment into an outlet on a circuit different from that to which the receiver is connected.
- Consult the dealer or an experienced radio/TV technician for help.

FCC Radiation Exposure Statement

This device complies with FCC radiation exposure limits set forth for an uncontrolled environment and it also complies with Part 15 of the FCC RF Rules. This equipment must be installed and operated in accordance with provided instructions and the antenna(s) used for this transmitter must be installed to provide a separation distance of at least 20 cm from all persons and must not be co-located or operating in conjunction with any other antenna or transmitter. End-users and installers must be provide with antenna installation instructions and consider removing the no-collocation statement.

This device complies with Part 15 of the FCC Rules. Operation is subject to the following two conditions: (1) this device may not cause harmful interference, and (2) this device must accept any interference received, including interference that may cause undesired operation.

Caution!

Any changes or modifications not expressly approved by the party responsible for compliance could void the user's authority to operate the equipment.