

FCC Radio Test Report

FCC ID: 2AG7C-SPEED10S

This report concerns: Original Grant

Project No. : 2009H028
Equipment : IP CAMERA
Brand Name : N/A
Test Model : Speed 10S
Series Model : Speed 10T
Applicant : Hangzhou Meari Technology Co., Ltd.
Address : Room 604-605, Building 1, No.768 Jianghong Road,
Changhe street, Binjiang District, Hangzhou, Zhejiang, China
Manufacturer : Hangzhou Meari Technology Co., Ltd.
Address : Room 604-605, Building 1, No.768 Jianghong Road,
Changhe street, Binjiang District, Hangzhou, Zhejiang, China
Factory : Hangzhou Meari Technology Co., Ltd.
Address : No. 91 Chutian Road, Xixing Street, Binjiang District,
Hangzhou, Zhejiang, China
Date of Receipt : Sep.17, 2020
Date of Test : Sep.17, 2020~Oct. 14, 2020
Issued Date : Oct.23, 2020
Report Version : R01
Test Sample : Engineering Sample No.: SH2020091129, SH2020091130
SH2020091129-1
Standard(s) : FCC Part15, Subpart C (15.247)
ANSI C63.10-2013
KDB 558074 D01 15.247 Meas Guidance v05r02

The above equipment has been tested and found compliance with the requirement of the relative standards by BTL Inc.

Allen Wei

Prepared by : Allen Wei

Ryan Wang

Approved by : Ryan Wang



Certificate # 5123.03

Add: No. 29, Jintang Road, Tangzhen Industry Park, Pudong New Area, Shanghai 201210, China

TEL: +86-021-61765666

Web: www.newbtl.com

Declaration

BTL represents to the client that testing is done in accordance with standard procedures as applicable and that test instruments used has been calibrated with standards traceable to international standard(s) and/or national standard(s).

BTL's reports apply only to the specific samples tested under conditions. It is manufacture's responsibility to ensure that additional production units of this model are manufactured with the identical electrical and mechanical components. **BTL** shall have no liability for any declarations, inferences or generalizations drawn by the client or others from **BTL** issued reports.

The report must not be used by the client to claim product certification, approval, or endorsement by NVLAP, NIST, A2LA, or any agency of the U.S. Government.

This report is the confidential property of the client. As a mutual protection to the clients, the public and ourselves, the test report shall not be reproduced, except in full, without our written approval.

BTL's laboratory quality assurance procedures are in compliance with the **ISO/IEC 17025** requirements, and accredited by the conformity assessment authorities listed in this test report.

BTL is not responsible for the sampling stage, so the results only apply to the sample as received.

The information, data and test plan are provided by manufacturer which may affect the validity of results, so it is manufacturer's responsibility to ensure that the apparatus meets the essential requirements of applied standards and in all the possible configurations as representative of its intended use.

Limitation

For the use of the authority's logo is limited unless the Test Standard(s)/Scope(s)/Item(s) mentioned in this test report is (are) included in the conformity assessment authorities acceptance respective.

Please note that the measurement uncertainty is provided for informational purpose only and are not use in determining the Pass/Fail results.

Table of Contents	Page
REPORT ISSUED HISTORY	6
1 . SUMMARY OF TEST RESULTS	7
1.1 TEST FACILITY	8
1.2 MEASUREMENT UNCERTAINTY	8
1.3 TEST ENVIRONMENT CONDITIONS	8
2 . GENERAL INFORMATION	9
2.1 GENERAL DESCRIPTION OF EUT	9
2.2 DESCRIPTION OF TEST MODES	10
2.3 PARAMETERS OF TEST SOFTWARE	12
2.4 DUTY CYCLE	13
2.5 BLOCK DIAGRAM SHOWING THE CONFIGURATION OF SYSTEM TESTED	14
2.6 SUPPORT UNITS	14
3 . AC POWER LINE CONDUCTED EMISSIONS TEST	15
3.1 LIMIT	15
3.2 TEST PROCEDURE	15
3.3 DEVIATION FROM TEST STANDARD	15
3.4 TEST SETUP	16
3.5 EUT OPERATION CONDITIONS	16
3.6 TEST RESULTS	16
4 . RADIATED EMISSIONS TEST	17
4.1 LIMIT	17
4.2 TEST PROCEDURE	18
4.3 DEVIATION FROM TEST STANDARD	18
4.4 TEST SETUP	19
4.5 EUT OPERATION CONDITIONS	20
4.6 TEST RESULTS - 9 KHZ TO 30 MHZ	20
4.7 TEST RESULTS - 30 MHZ TO 1000 MHZ	20
4.8 TEST RESULTS - ABOVE 1000 MHZ	20
5 . BANDWIDTH TEST	21
5.1 LIMIT	21
5.2 TEST PROCEDURE	21
5.3 DEVIATION FROM STANDARD	21
5.4 TEST SETUP	21

Table of Contents	Page
5.5 EUT OPERATION CONDITIONS	21
5.6 TEST RESULTS	21
6 . MAXIMUM OUTPUT POWER TEST	22
6.1 LIMIT	22
6.2 TEST PROCEDURE	22
6.3 DEVIATION FROM STANDARD	22
6.4 TEST SETUP	22
6.5 EUT OPERATION CONDITIONS	22
6.6 TEST RESULTS	22
7 . CONDUCTED SPURIOUS EMISSIONS	23
7.1 LIMIT	23
7.2 TEST PROCEDURE	23
7.3 DEVIATION FROM STANDARD	23
7.4 TEST SETUP	23
7.5 EUT OPERATION CONDITIONS	23
7.6 TEST RESULTS	23
8 . POWER SPECTRAL DENSITY TEST	24
8.1 LIMIT	24
8.2 TEST PROCEDURE	24
8.3 DEVIATION FROM STANDARD	24
8.4 TEST SETUP	24
8.5 EUT OPERATION CONDITIONS	24
8.6 TEST RESULTS	24
9 . MEASUREMENT INSTRUMENTS LIST	25
10 . EUT TEST PHOTO	27
APPENDIX A - AC POWER LINE CONDUCTED EMISSIONS	30
APPENDIX B - RADIATED EMISSION - 9 KHZ TO 30 MHZ	33
APPENDIX C - RADIATED EMISSION - 30 MHZ TO 1000 MHZ	34
APPENDIX D - RADIATED EMISSION- ABOVE 1000 MHZ	37
APPENDIX E - BANDWIDTH	86
APPENDIX F - MAXIMUM OUTPUT POWER	89
APPENDIX G - CONDUCTED SPURIOUS EMISSIONS	91

Table of Contents

Page

APPENDIX H - POWER SPECTRAL DENSITY

96

REPORT ISSUED HISTORY

Report Version	Description	Issued Date
R00	Original Issue.	Oct.20, 2020
R01	Revised the power value.	Oct.23, 2020

1. SUMMARY OF TEST RESULTS

Test procedures according to the technical standard(s):

FCC Part15, Subpart C (15.247)				
Standard(s) Section	Test Item	Test Result	Judgment	Remark
15.207	AC Power Line Conducted Emissions	APPENDIX A	PASS	-----
15.247(d) 15.205(a) 15.209(a)	Radiated Emissions	APPENDIX B APPENDIX C APPENDIX D	PASS	-----
15.247(a)(2)	Bandwidth	APPENDIX E	PASS	-----
15.247(b)(3)	Maximum Output Power	APPENDIX F	PASS	-----
15.247(d)	Conducted Spurious Emissions	APPENDIX G	PASS	-----
15.247(e)	Power Spectral Density	APPENDIX H	PASS	-----
15.203	Antenna Requirement	-----	PASS	Note(2)

Note:

- (1) "N/A" denotes test is not applicable in this test report.
- (2) The device what use a permanently attached antenna were considered sufficient to comply with the provisions of 15.203.

1.1 TEST FACILITY

The test facilities used to collect the test data in this report is at the location of No. 29, Jintang Road, Tangzhen Industry Park, Pudong New Area, Shanghai 201210,China
 BTL's Test Firm Registration Number for FCC: 476765
 BTL's Designation Number for FCC: CN1241

1.2 MEASUREMENT UNCERTAINTY

ISO/IEC 17025 requires that an estimate of the measurement uncertainties associated with the emissions test results be included in the report. The measurement uncertainties given below are based on a 95% confidence level (based on a coverage factor (k=2))
 The BTL measurement uncertainty as below table:

A. Radiated emissions test:

Test Site	Method	Measurement Frequency Range	Ant. H / V	U, (dB)
SH-CB01	CISPR	9 KHz~30 MHz	V	3.79
		9 KHz~30 MHz	H	3.57
		30 MHz~200 MHz	V	4.04
		30 MHz~200 MHz	H	3.76
		200 MHz~1,000 MHz	V	4.24
		200 MHz~1,000 MHz	H	3.84
		1 GHz~18 GHz	V	4.46
		1 GHz~18 GHz	H	4.40
		18 GHz~40 GHz	V	3.95
		18 GHz~40 GHz	H	3.95

Note: Unless specifically mentioned, the uncertainty of measurement has not been taken into account to declare the compliance or non-compliance to the specification.

1.3 TEST ENVIRONMENT CONDITIONS

Test Item	Temperature	Humidity	Test Voltage	Tested By
AC Power Line Conducted Emissions	22°C	48%	AC 120V/60Hz	Forest
Radiated Emissions-9K-30MHz	24°C	58%	AC 120V/60Hz	Forest
Radiated Emissions-30 MHz to 1GHz	24°C	58%	AC 120V/60Hz	Forest
Radiated Emissions-Above 1000 MHz	24°C	58%	AC 120V/60Hz	Forest
Bandwidth	22°C	48%	AC 120V/60Hz	Forest
Maximum output power & e.i.r.p.	22°C	48%	AC 120V/60Hz	Forest
Conducted Spurious Emissions	22°C	48%	AC 120V/60Hz	Forest
Power Spectral Density	22°C	48%	AC 120V/60Hz	Forest

2. GENERAL INFORMATION

2.1 GENERAL DESCRIPTION OF EUT

Equipment	IP CAMERA
Brand Name	N/A
Test Model	Speed 10S
Series Model	Speed 10T
Model Difference(s)	Only differ in model name
Software Version	Smart life
Hardware Version	PCB-SPEED10S-H1MB_F37-REV1.0
Power Source	DC voltage supplied from AC/DC adapter. 1#Brand/Mode: SZTY/TPA-46B050100UU 2#Brand/Mode: GPO/GTA92-0501000US
Power Rating	1# I/P: 100V-240V ~ 50Hz/60Hz 0.2A, O/P:5V === 1000mA 2# I/P: 100V-240V ~ 50Hz/60Hz 0.3A, O/P:USB-A 5.0V === 1.0A 5.0W
Operation Frequency	2412 MHz ~ 2462 MHz
Modulation Type	IEEE 802.11b: DSSS IEEE 802.11g: OFDM IEEE 802.11n: OFDM
Bit Rate of Transmitter	IEEE 802.11b: 11/5.5/2/1 Mbps IEEE 802.11g: 54/48/36/24/18/12/9/6 Mbps IEEE 802.11n: up to 150 Mbps
Maximum Output Power Non-Beamforming	IEEE 802.11b: 17.62 dBm (0.0578 W) IEEE 802.11g: 13.89 dBm (0.0245 W) IEEE 802.11n (HT20): 14.85 dBm (0.0305 W) IEEE 802.11n (HT40): 14.86 dBm (0.0306 W)

Note:

- For a more detailed features description, please refer to the manufacturer's specifications or the user's manual.
- Channel List:

CH01 - CH11 for IEEE 802.11b, IEEE 802.11g, IEEE 802.11n (HT20) CH03 - CH09 for IEEE 802.11n (HT40)							
Channel	Frequency (MHz)	Channel	Frequency (MHz)	Channel	Frequency (MHz)	Channel	Frequency (MHz)
01	2412	04	2427	07	2442	10	2457
02	2417	05	2432	08	2447	11	2462
03	2422	06	2437	09	2452		

3. Antenna Specification:

Ant.	Brand	Model Name	Antenna Type	Connector	Gain (dBi)	Note
1	N/A	N/A	FPC	N/A	3	N/A

2.2 DESCRIPTION OF TEST MODES

The test system was pre-tested based on the consideration of all possible combinations of EUT operation mode.

Pretest Mode	Description
Mode 1	TX B Mode Channel 01/06/11
Mode 2	TX G Mode Channel 01/06/11
Mode 3	TX N-20 MHz Mode Channel 01/06/11
Mode 4	TX N-40 MHz Mode Channel 03/06/09
Mode 5	TX B Mode Channel 11

Following mode(s) as (were) found to be the worst case(s) and selected for the final test.

AC power line conducted emissions test	
Final Test Mode:	Description
Mode 5	TX B Mode Channel 11

Radiated emissions test - Below 1GHz	
Final Test Mode:	Description
Mode 5	TX B Mode Channel 11

Radiated emissions test- Above 1GHz	
Final Test Mode:	Description
Mode 1	TX B Mode Channel 01/06/11
Mode 2	TX G Mode Channel 01/06/11
Mode 3	TX N-20 MHz Mode Channel 01/06/11
Mode 4	TX N-40 MHz Mode Channel 03/06/09

Conducted test	
Final Test Mode:	Description
Mode 1	TX B Mode Channel 01/06/11
Mode 2	TX G Mode Channel 01/06/11
Mode 3	TX N-20 MHz Mode Channel 01/06/11
Mode 4	TX N-40 MHz Mode Channel 03/06/09

NOTE:

- (1) The measurements are performed at the high, middle, low available channels.
- (2) 802.11b mode: CCK (1 Mbps)
802.11g mode: OFDM (6 Mbps)
802.11n HT20 mode : BPSK (6.5 Mbps)
802.11n HT40 mode : BPSK (13.5 Mbps)
For radiated emission tests, the highest output powers were set for final test.
- (3) For radiated emission below 1 GHz test, the IEEE 802.11b Channel 11 is found to be the worst case and recorded.

2.3 PARAMETERS OF TEST SOFTWARE

Test Software	MPTool 1.0.0.9		
Frequency (MHz)	2412	2437	2462
IEEE 802.11b	60	62	62
IEEE 802.11g	63	63	63
IEEE 802.11n (HT20)	63	63	63
Frequency (MHz)	2422	2437	2452
IEEE 802.11n (HT40)	63	63	63

2.4 DUTY CYCLE

If duty cycle is $\geq 98\%$, duty factor is not required.
 If duty cycle is $< 98\%$, duty factor shall be considered.
 The output power = measured power + duty factor.

IEEE 802.11b

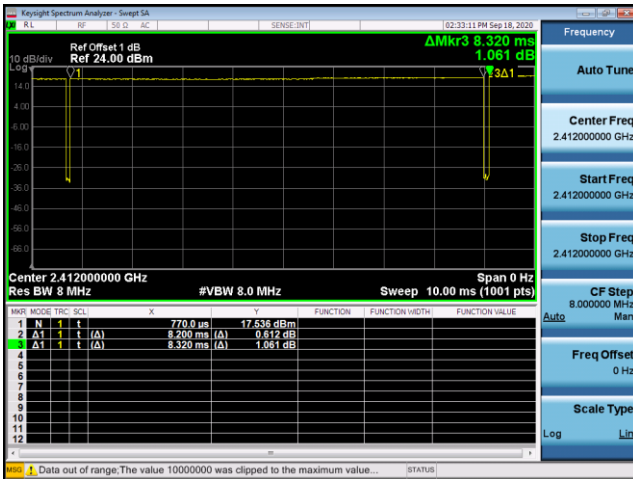

Duty cycle = $8.200 \text{ ms} / 8.320 \text{ ms} = 98.56\%$
 Duty Factor = $10 \log(1/\text{Duty cycle}) = 0.06$

IEEE 802.11g

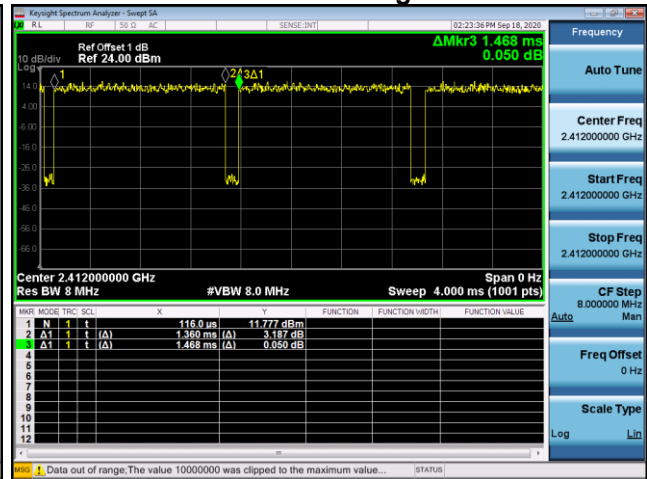

Duty cycle = $1.360 \text{ ms} / 1.468 \text{ ms} = 92.64\%$
 Duty Factor = $10 \log(1/\text{Duty cycle}) = 0.33$

IEEE 802.11n (HT20)

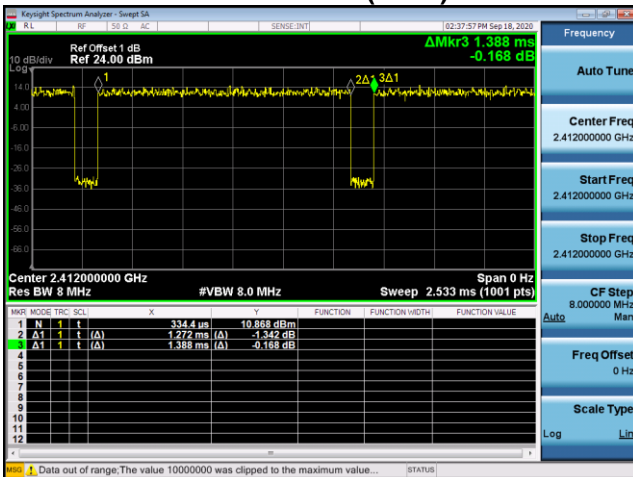

Duty cycle = $1.272 \text{ ms} / 1.388 \text{ ms} = 91.64\%$
 Duty Factor = $10 \log(1/\text{Duty cycle}) = 0.38$,

IEEE 802.11n (HT40)

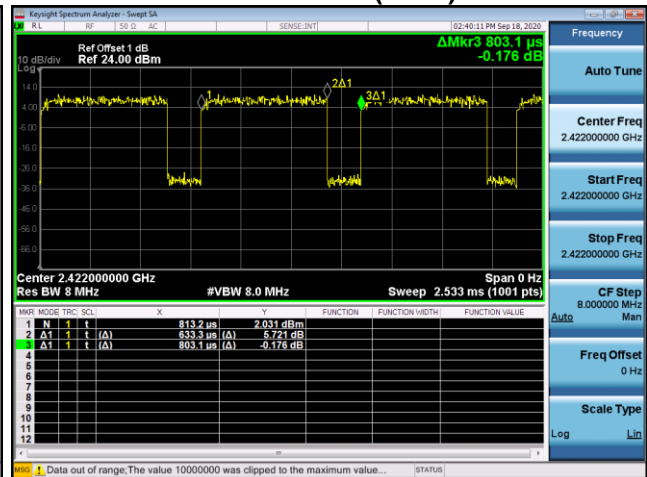

Duty cycle = $0.633 \text{ ms} / 0.803 \text{ ms} = 78.83\%$
 Duty Factor = $10 \log(1/\text{Duty cycle}) = 1.03$

NOTE:

For IEEE 802.11g and IEEE 802.11n (HT20):

For radiated emissions frequency above 1 GHz, the resolution bandwidth of test receiver/spectrum analyzer is 1 MHz and the video bandwidth is 1 kHz (Duty cycle $< 98\%$).

For IEEE 802.11n (HT40):

For radiated emissions frequency above 1 GHz, the resolution bandwidth of test receiver/spectrum analyzer is 1 MHz and the video bandwidth is 2 kHz (Duty cycle $< 98\%$).

2.5 BLOCK DIAGRAM SHOWING THE CONFIGURATION OF SYSTEM TESTED

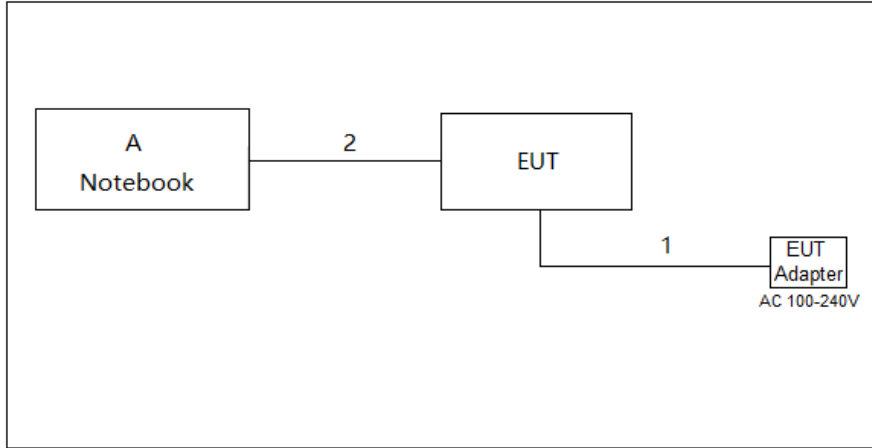

2.6 SUPPORT UNITS

Item	Equipment	Brand	Model No.	Series No.
A	Notebook	DELL	N/A	N/A

Item	Cable Type	Shielded Type	Ferrite Core	Length
1	DC Cable	NO	NO	1.5m
2	USB	NO	NO	0.5m

3. AC POWER LINE CONDUCTED EMISSIONS TEST

3.1 LIMIT

Frequency of Emission (MHz)	Limit (dB μ V)	
	Quasi-peak	Average
0.15 - 0.50	66 to 56*	56 to 46*
0.50 - 5.0	56	46
5.0 - 30.0	60	50

NOTE:

- (1) The tighter limit applies at the band edges.
- (2) The limit of " * " marked band means the limitation decreases linearly with the logarithm of the frequency in the range.

The following table is the setting of the receiver

Receiver Parameters	Setting
Attenuation	10 dB
Start Frequency	0.15 MHz
Stop Frequency	30 MHz
IF Bandwidth	9 kHz

3.2 TEST PROCEDURE

- a. The EUT was placed 0.8 meters from the horizontal ground plane with EUT being connected to the power mains through a line impedance stabilization network (LISN). All other support equipment powered from additional LISN(s). The LISN provide 50 Ohm/ 50uH of coupling impedance for the measuring instrument.
- b. Interconnecting cables that hang closer than 40 cm to the ground plane shall be folded back and forth in the center forming a bundle 30 to 40 cm long.
- c. I/O cables that are not connected to a peripheral shall be bundled in the center. The end of the cable may be terminated, if required, using the correct terminating impedance. The overall length shall not exceed 1 m.
- d. LISN at least 80 cm from nearest part of EUT chassis.
- e. For the actual test configuration, please refer to the related Item -EUT Test Photos.

3.3 DEVIATION FROM TEST STANDARD

No deviation

3.4 TEST SETUP

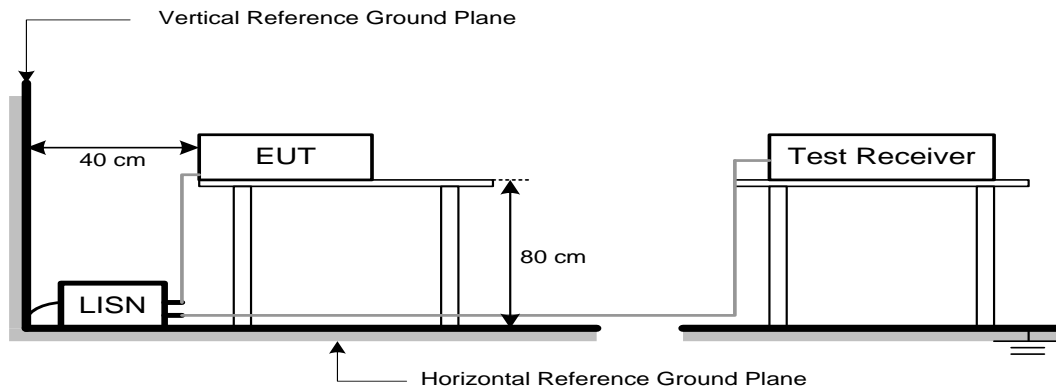

3.5 EUT OPERATION CONDITIONS

EUT was programmed to be in continuously transmitting mode.

3.6 TEST RESULTS

Please refer to the APPENDIX A.

4. RADIATED EMISSIONS TEST

4.1 LIMIT

In case the emission fall within the restricted band specified on 15.205(a), then the 15.209(a) limit in the table below has to be followed.

LIMITS OF RADIATED EMISSION MEASUREMENT (9 kHz-1000 MHz)

Frequency (MHz)	Field Strength (microvolts/meter)	Measurement Distance (meters)
0.009-0.490	2400/F(kHz)	300
0.490-1.705	24000/F(kHz)	30
1.705-30.0	30	30
30-88	100	3
88-216	150	3
216-960	200	3
Above 960	500	3

LIMITS OF RADIATED EMISSION MEASUREMENT (Above 1000 MHz)

Frequency (MHz)	(dBuV/m at 3 m)	
	Peak	Average
Above 1000	74	54

NOTE:

- (1) The limit for radiated test was performed according to FCC PART 15C.
- (2) The tighter limit applies at the band edges.
- (3) Emission level (dBuV/m)=20log Emission level (uV/m).
- (4) The test result calculated as following:
 Measurement Value = Reading Level + Correct Factor
 Correct Factor = Antenna Factor + Cable Loss - Amplifier Gain(if use)
 Margin Level = Measurement Value - Limit Value

Spectrum Parameter	Setting
Attenuation	Auto
Start Frequency	1000 MHz
Stop Frequency	10th carrier harmonic
RBW / VBW (Emission in restricted band)	1 MHz / 3 MHz for Peak, 1 MHz / 1/T for Average

Receiver Parameter	Setting
Attenuation	Auto
Start ~ Stop Frequency	9 kHz~90 kHz for PK/AVG detector
Start ~ Stop Frequency	90 kHz~110 kHz for QP detector
Start ~ Stop Frequency	110 kHz~490 kHz for PK/AVG detector
Start ~ Stop Frequency	490 kHz~30 MHz for QP detector
Start ~ Stop Frequency	30 MHz~1000 MHz for QP detector

4.2 TEST PROCEDURE

- a. The measuring distance of 3 m shall be used for measurements. The EUT was placed on the top of a rotating table 0.8 meter above the ground at a 3 meter semi-anechoic chamber. The table was rotated 360 degrees to determine the position of the highest radiation.(below 1 GHz)
- b. The measuring distance of 3 m shall be used for measurements. The EUT was placed on the top of a rotating table 1.5 meter above the ground at a 3 meter semi-anechoic chamber. The table was rotated 360 degrees to determine the position of the highest radiation.(above 1 GHz)
- c. The height of the equipment or of the substitution antenna shall be 0.8m or 1.5m; the height of the test antenna shall vary between 1 m to 4 m. Both horizontal and vertical polarizations of the antenna are set to make the measurement.
- d. For each suspected emission, the EUT was arranged to its worst case and then the antenna was tuned to heights find the maximum reading (used Bore sight function).
- e. The receiver system was set to peak and average detect function and specified bandwidth with maximum hold mode when the test frequency is above 1 GHz.
- f. The initial step in collecting radiated emission data is a receiver peak detector mode pre-scanning the measurement frequency range. Significant peaks are then marked and then Quasi Peak detector mode re-measured.
- g. All readings are Peak unless otherwise stated QP in column of Note. Peak denotes that the Peak reading compliance with the QP Limits and then QP Mode measurement didn't perform.
(below 1 GHz)
- h. All readings are Peak Mode value unless otherwise stated AVG in column of Note. If the Peak Mode Measured value compliance with the Peak Limits and lower than AVG Limits, the EUT shall be deemed to meet both Peak & AVG Limits and then only Peak Mode was measured, but AVG Mode didn't perform. (above 1 GHz)
- i. For the actual test configuration, please refer to the related Item -EUT Test Photos.

4.3 DEVIATION FROM TEST STANDARD

No deviation

4.4 TEST SETUP

9 kHz-30 MHz

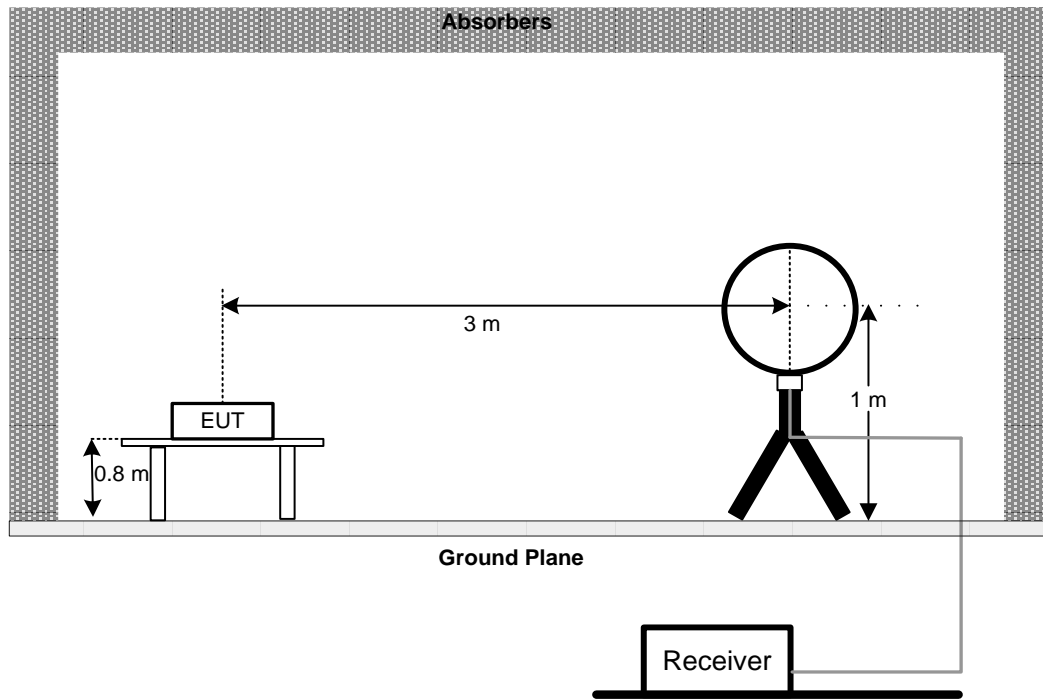

30 MHz to 1 GHz

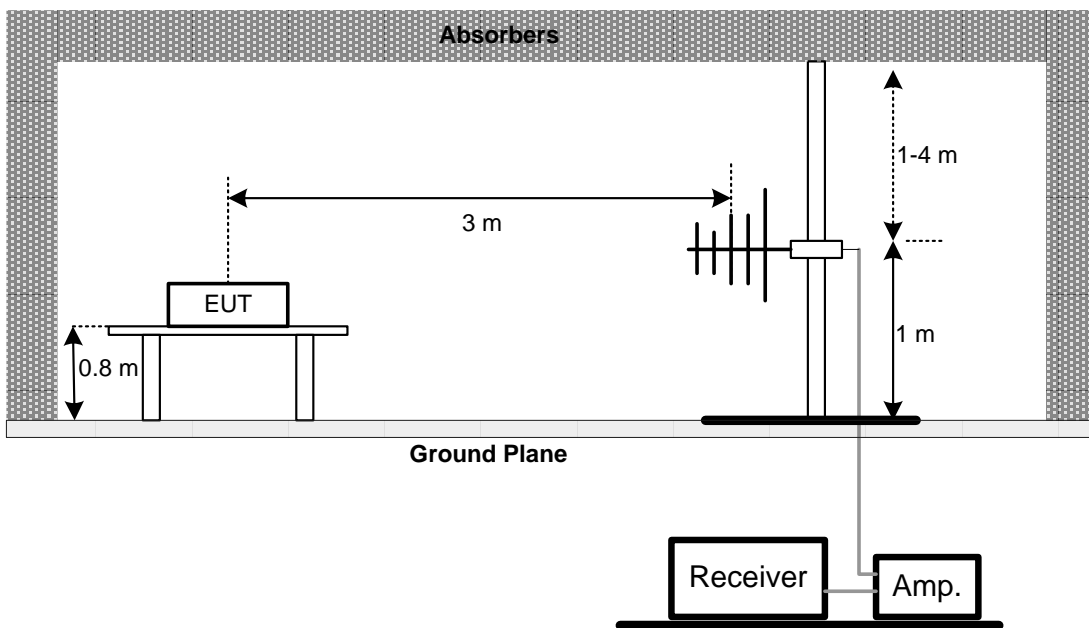

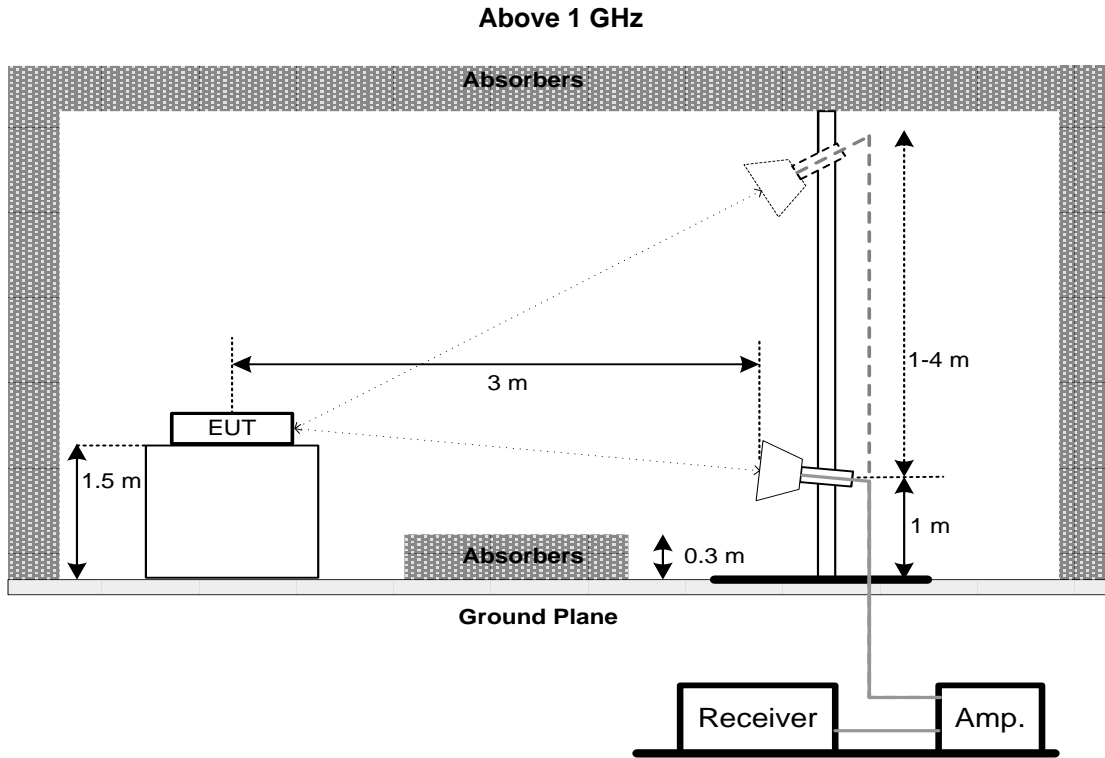

4.5 EUT OPERATION CONDITIONS

The EUT was programmed to be in continuously transmitting mode.

4.6 TEST RESULTS - 9 KHZ TO 30 MHZ

Please refer to the APPENDIX B

Remark:

- (1) Distance extrapolation factor = $40 \log (\text{specific distance} / \text{test distance})$ (dB).
- (2) Limit line = specific limits (dBuV) + distance extrapolation factor.

4.7 TEST RESULTS - 30 MHZ TO 1000 MHZ

Please refer to the APPENDIX C.

4.8 TEST RESULTS - ABOVE 1000 MHZ

Please refer to the APPENDIX D.

Remark:

- (1) No limit: This is fundamental signal, the judgment is not applicable.
For fundamental signal judgment was referred to Peak output test.

5. BANDWIDTH TEST**5.1 LIMIT**

FCC Part15, Subpart C (15.247)		
Section	Test Item	Limit
15.247(a)(2)	6 dB Bandwidth	Minimum 500 kHz
	99% Emission Bandwidth	-

5.2 TEST PROCEDURE

- The EUT was directly connected to the spectrum analyzer and antenna output port as show in the block diagram below.
- Spectrum Setting:
 - For 6 dB Bandwidth : RBW= 100 kHz, VBW=300 kHz, Sweep time = auto.
 - For 99% Emission Bandwidth B/G/N-20 Mode: RBW= 300 KHz, VBW=1 MHz, Sweep time = 2.5 ms.
 - For 99% Emission Bandwidth N-40 Mode: RBW= 1 MHz, VBW=3 MHz, Sweep time = 2.5 ms.
- The bandwidth was performed in accordance with method 11.8.1 of ANSI C63.10-2013.

5.3 DEVIATION FROM STANDARD

No deviation.

5.4 TEST SETUP**5.5 EUT OPERATION CONDITIONS**

The EUT was programmed to be in continuously transmitting mode.

5.6 TEST RESULTS

Please refer to the APPENDIX E.

6. MAXIMUM OUTPUT POWER TEST

6.1 LIMIT

FCC Part15, Subpart C (15.247)		
Section	Test Item	Limit
15.247(b)(3)	Maximum Output Power	1 Watt or 30dBm

6.2 TEST PROCEDURE

- The EUT was directly connected to the power meter and antenna output port as show in the block diagram below.
- The maximum conducted output power was performed in accordance with method 11.9.1.3 (for peak power) or 11.9.2.3.1 (for AVG power) of ANSI C63.10-2013.

6.3 DEVIATION FROM STANDARD

No deviation.

6.4 TEST SETUP



6.5 EUT OPERATION CONDITIONS

The EUT was programmed to be in continuously transmitting mode.

6.6 TEST RESULTS

Please refer to the APPENDIX F.

7. CONDUCTED SPURIOUS EMISSIONS

7.1 LIMIT

In any 100 kHz bandwidth outside the frequency band in which the spread spectrum or digitally modulated intentional radiator is operating, the radio frequency power that is produced by the intentional radiator shall be at least 20 dB below that in the 100 kHz bandwidth within the band that contains the highest level of the desired power, based on either an RF conducted or a radiated measurement, provided the transmitter demonstrates compliance with the peak Output Power limits. If the transmitter complies with the Output Power limits based on the use of RMS averaging over a time interval, as permitted under paragraph (b)(3) of this section, the attenuation required under this paragraph shall be 30 dB instead of 20 dB. Attenuation below the general limits specified in Section 15.209(a) is not required.

7.2 TEST PROCEDURE

- a. The EUT was directly connected to the spectrum analyzer and antenna output port as show in the block diagram below.
- b. Spectrum Setting: RBW= 100 kHz, VBW=300 kHz, Sweep time = Auto.

7.3 DEVIATION FROM STANDARD

No deviation.

7.4 TEST SETUP



7.5 EUT OPERATION CONDITIONS

The EUT was programmed to be in continuously transmitting mode.

7.6 TEST RESULTS

Please refer to the APPENDIX G.

8. POWER SPECTRAL DENSITY TEST

8.1 LIMIT

FCC Part15, Subpart C (15.247)		
Section	Test Item	Limit
15.247(e)	Power Spectral Density	8 dBm (in any 3 kHz)

8.2 TEST PROCEDURE

- The EUT was directly connected to the spectrum analyzer and antenna output port as show in the block diagram below.
- Spectrum Setting: RBW=3 kHz, VBW=10 kHz, Sweep time = Auto.
- The Power Spectral Density was performed in accordance with method 11.10.2 of ANSI C63.10-2013.

8.3 DEVIATION FROM STANDARD

No deviation.

8.4 TEST SETUP



8.5 EUT OPERATION CONDITIONS

The EUT was programmed to be in continuously transmitting mode.

8.6 TEST RESULTS

Please refer to the APPENDIX H.

9. MEASUREMENT INSTRUMENTS LIST

AC Power Line Conducted Emissions					
Item	Kind of Equipment	Manufacturer	Type No.	Serial No.	Calibrated until
1	Line Impedance Stabilisation Network	Schwarzbeck	NNLK 8121	8121-822	Mar. 21, 2021
2	TWO-LINE V-NETWORK	R&S	ENV216	101340	Aug. 23, 2021
3	Test Cable	emci	EMCRG400-BM-NM-10000	170628	Jul. 15, 2021
4	EMI Test Receiver	R&S	ESCI	100082	Mar. 21, 2021
5	50Ω Terminator	SHX	TF2-1G-A	17051602	Mar. 21, 2021
6	50Ω coaxial switch	Anritsu	MP59B	6201750902	Mar. 21, 2021
7	Measurement Software	Farad	EZ-EMC Ver.NB-03A1-01	N/A	N/A

Radiated Emissions - 30 MHz to 1 GHz					
Item	Kind of Equipment	Manufacturer	Type No.	Serial No.	Calibrated until
1	TRILOG Broadband Antenna	Schwarzbeck	VULB 9168	719	Apr. 02, 2021
2	Pre-Amplifier	emci	EMC9135	980400	Mar. 21, 2021
3	MXE EMI Receiver	Keysight	N9038A	MY57150106	Mar. 21, 2021
4	Test Cable	emci	EMC104-SM-SM-7000	170330	Apr. 13, 2021
5	Test Cable	emci	EMC104-SM-SM-1000	170331	Apr. 13, 2021
6	Test Cable	emci	EMC104-SM-NM-3500	170621	Apr. 13, 2021
7	Measurement Software	Farad	EZ-EMC Ver.NB-03A1-01	N/A	N/A

Radiated Emissions - Above 1 GHz					
Item	Kind of Equipment	Manufacturer	Type No.	Serial No.	Calibrated until
1	Double-Ridged Waveguide Horn Antenna	ETS-Lindgren	9120D	00206960	Apr. 02, 2021
2	Pre-Amplifier	emci	EMC012645SE	980421	May. 11, 2021
3	EXA Spectrum Analyzer	Keysight	N9010A	MY56480545	Mar. 21, 2021
4	Test Cable	emci	EMC104-SM-SM-7000	170330	Apr. 13, 2021
5	Test Cable	emci	EMC104-SM-SM-1000	170331	Apr. 13, 2021
6	Test Cable	emci	EMC104-SM-NM-3500	170621	Apr. 13, 2021
7	Measurement Software	Farad	EZ-EMC Ver.NB-03A1-01	N/A	N/A
8	MXE EMI Receiver	Keysight	N9038A	MY57150106	May. 06, 2021
9	Double-Ridged Waveguide Horn Antenna	ETS-Lindgren	3116C	00203919	Jul. 20, 2021
10	Pre-Amplifier	emci	EMC184045SE	980409	Mar. 21, 2021
11	EXA Spectrum Analyzer	Keysight	N9010A	MY56480579	Mar. 21, 2021
12	Test Cable	emci	EMC102-KM-KM-800	170654	Apr. 13, 2021
13	Test Cable	emci	Super Reliable-40G-SS11-7000	W0030860001	Apr. 13, 2021
14	Measurement Software	Farad	EZ-EMC Ver.NB-03A1-01	N/A	N/A

Bandwidth					
Item	Kind of Equipment	Manufacturer	Type No.	Serial No.	Calibrated until
1	Spectrum Analyzer	R&S	FSP40	100626	May. 06, 2021

Maximum Output Power					
Item	Kind of Equipment	Manufacturer	Type No.	Serial No.	Calibrated until
1	Peak Power Analyze	Keysight	8990B	MY51000507	Mar. 21, 2021
2	Wideband Power Sensor	Keysight	N9123A	MY58310003	Mar. 21, 2021

Antenna Conducted Spurious Emissions					
Item	Kind of Equipment	Manufacturer	Type No.	Serial No.	Calibrated until
1	Spectrum Analyzer	R&S	FSP40	100626	May. 06, 2021

Power Spectral Density					
Item	Kind of Equipment	Manufacturer	Type No.	Serial No.	Calibrated until
1	Spectrum Analyzer	R&S	FSP40	100626	May. 06, 2021

Remark: "N/A" denotes no model name, serial no. or calibration specified.

All calibration period of equipment list is one year.

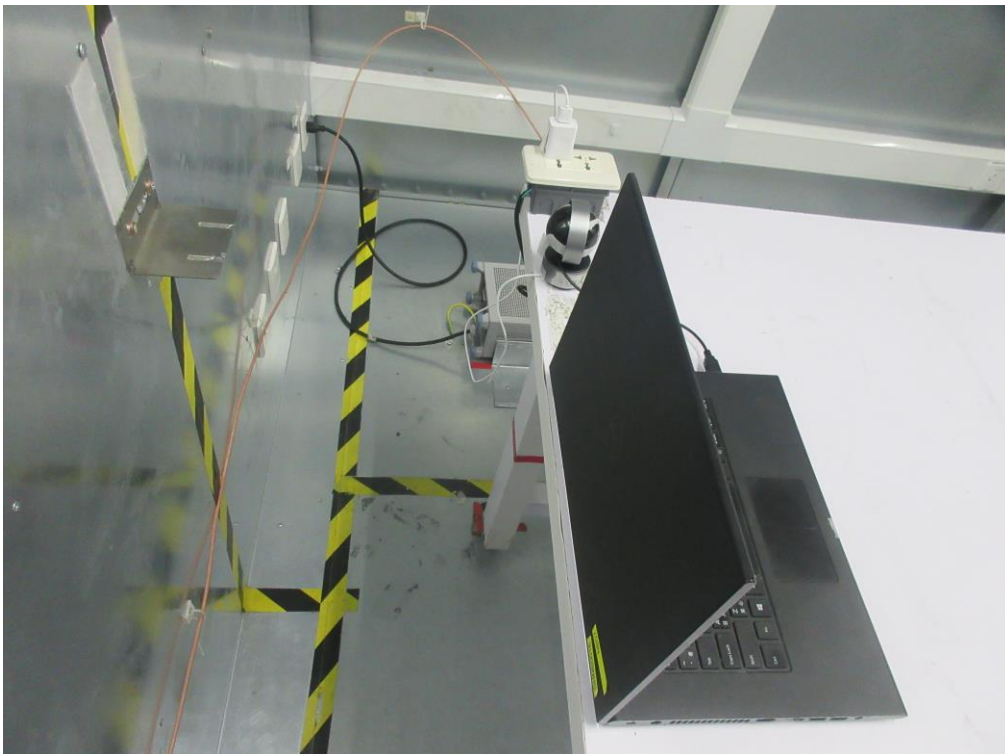
10. EUT TEST PHOTO**Conducted Emissions Test Photos**

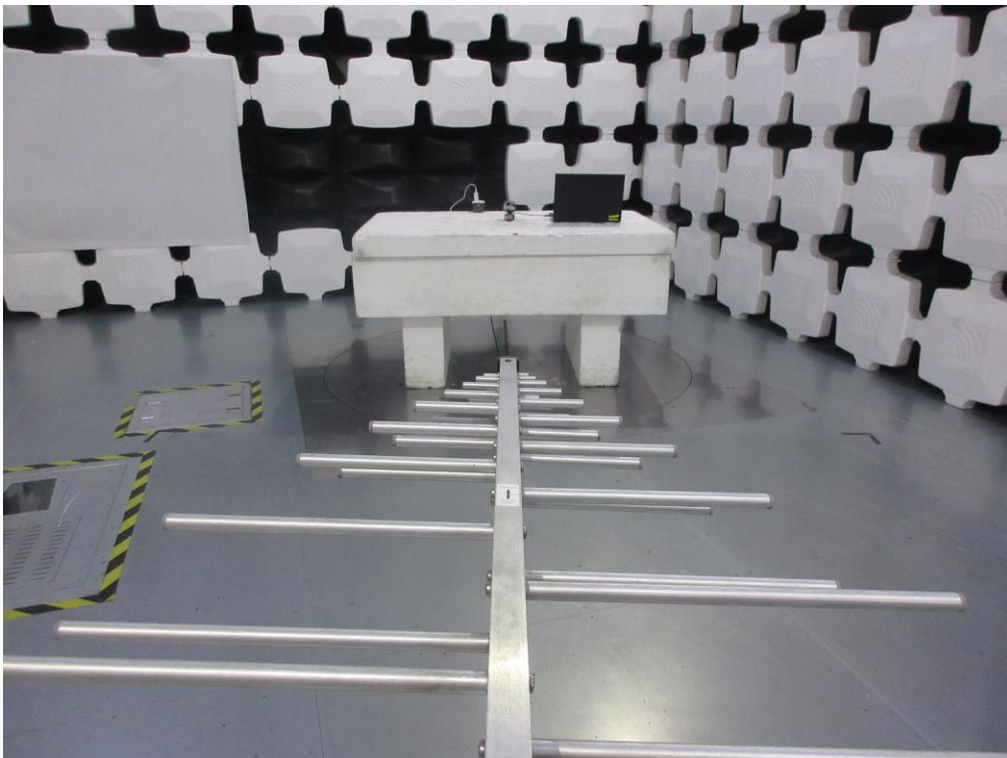
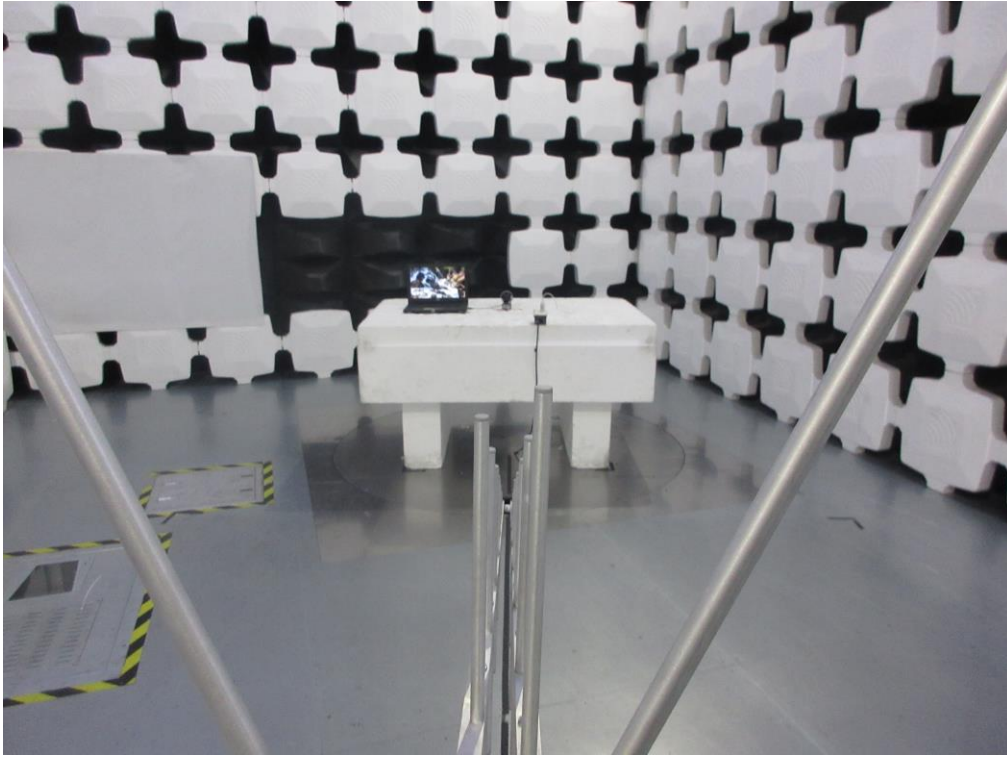
Radiated Emissions Test Photos**30 MHz to 1 GHz**

Radiated Emissions Test Photos

Above 1 GHz

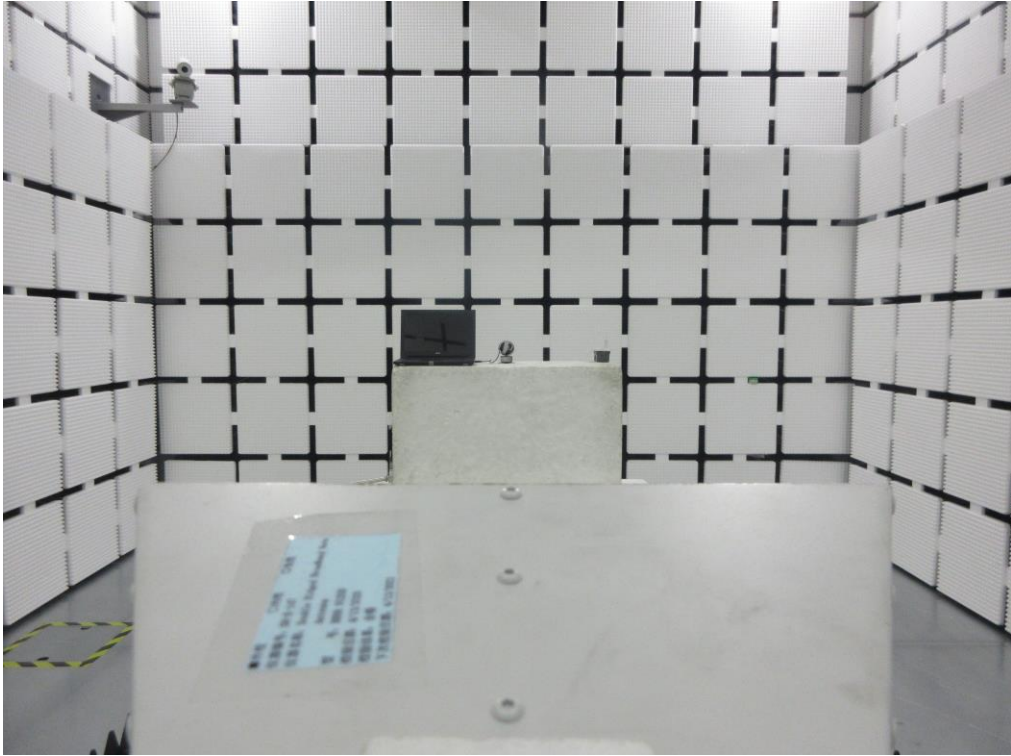
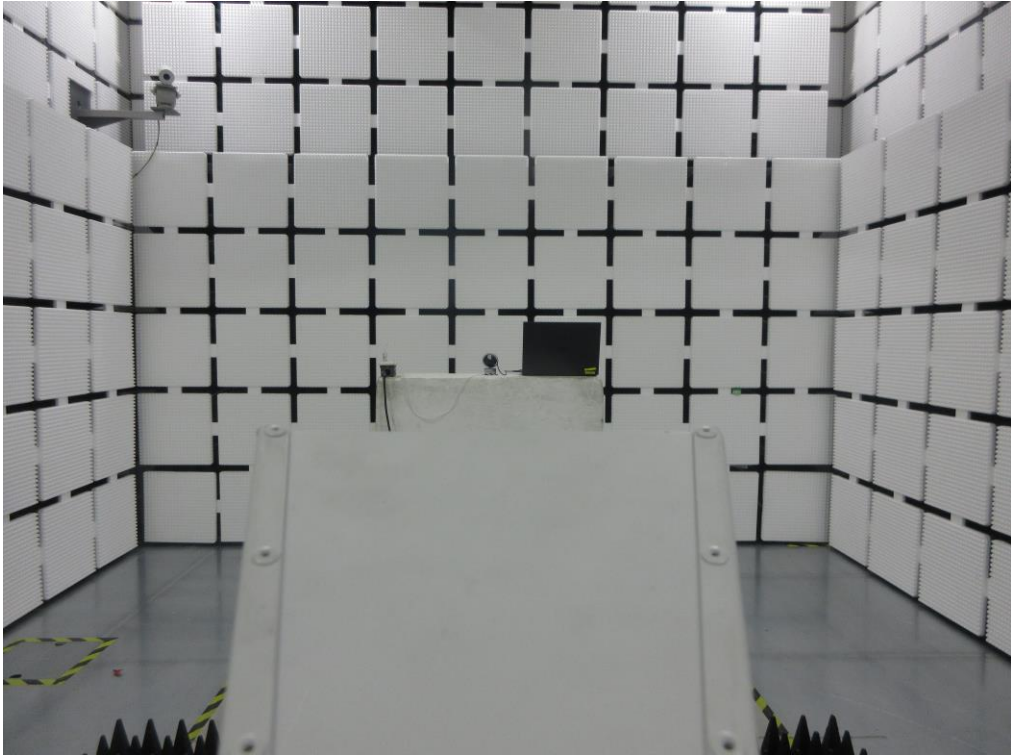

APPENDIX A - AC POWER LINE CONDUCTED EMISSIONS

Test Mode: TX B Mode Channel 11

Line

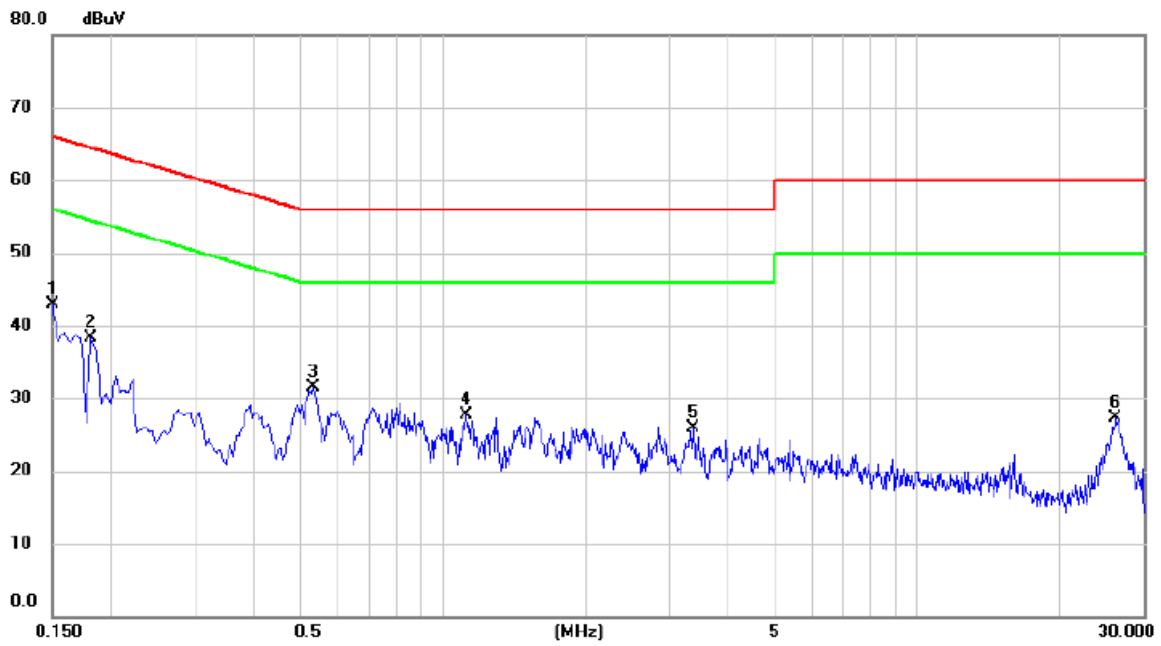

No.	Mk.	Freq. MHz	Reading Level dBuV	Correct Factor dB	Measure- ment dBuV	Limit dBuV	Margin dB	Detector	Comment
1	*	0.1500	33.10	9.71	42.81	66.00	-23.19	peak	
2		0.1815	28.65	9.73	38.38	64.42	-26.04	peak	
3		0.5325	21.77	9.80	31.57	56.00	-24.43	peak	
4		1.1220	17.92	9.85	27.77	56.00	-28.23	peak	
5		3.3810	15.91	9.98	25.89	56.00	-30.11	peak	
6		26.1600	16.69	10.71	27.40	60.00	-32.60	peak	

REMARKS:

- (1) Measurement Value = Reading Level + Correct Factor.
- (2) Margin Level = Measurement Value - Limit Value.

Test Mode: TX B Mode Channel 11

Neutral

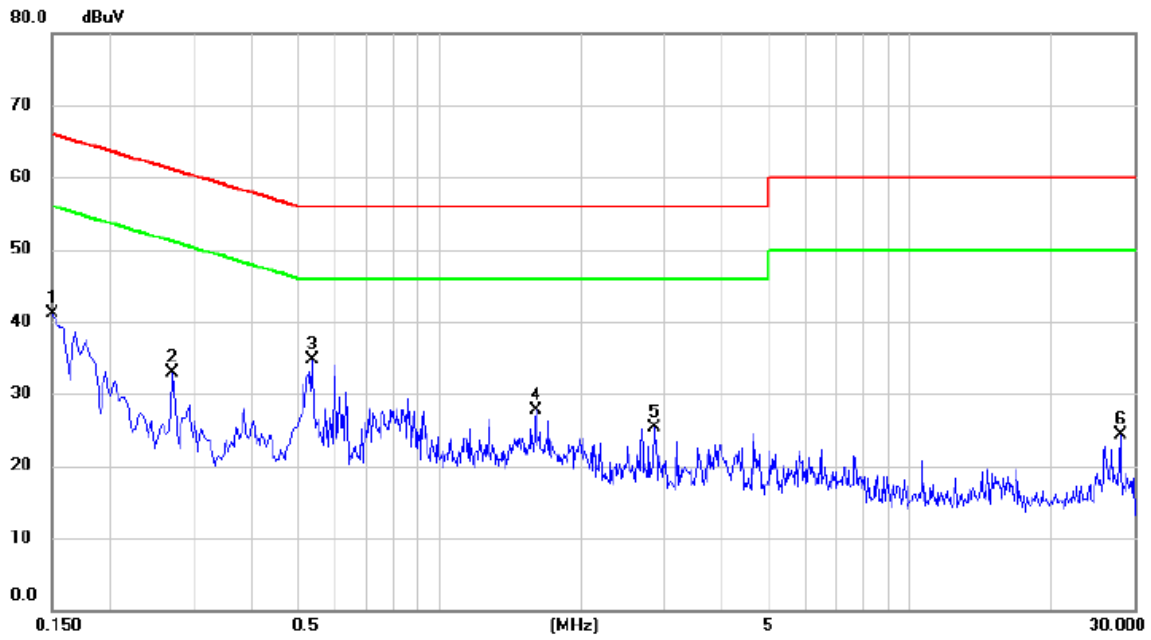

No.	Mk.	Freq. MHz	Reading Level dBuV	Correct Factor dB	Measure- ment dBuV	Limit dBuV	Margin dB	Detector	Comment
1		0.1500	31.41	9.68	41.09	66.00	-24.91	peak	
2		0.2714	23.19	9.73	32.92	61.07	-28.15	peak	
3	*	0.5370	24.99	9.78	34.77	56.00	-21.23	peak	
4		1.6035	17.82	9.86	27.68	56.00	-28.32	peak	
5		2.8590	15.39	9.93	25.32	56.00	-30.68	peak	
6		28.0005	13.55	10.75	24.30	60.00	-35.70	peak	

REMARKS:

- (1) Measurement Value = Reading Level + Correct Factor.
- (2) Margin Level = Measurement Value - Limit Value.

APPENDIX B - RADIATED EMISSION - 9 KHZ TO 30 MHZ

Note: The measured value have enough margin over 20dB than the limit, therefore they are not reported.

APPENDIX C - RADIATED EMISSION - 30 MHZ TO 1000 MHZ

Test Mode: TX B Mode Channel 11

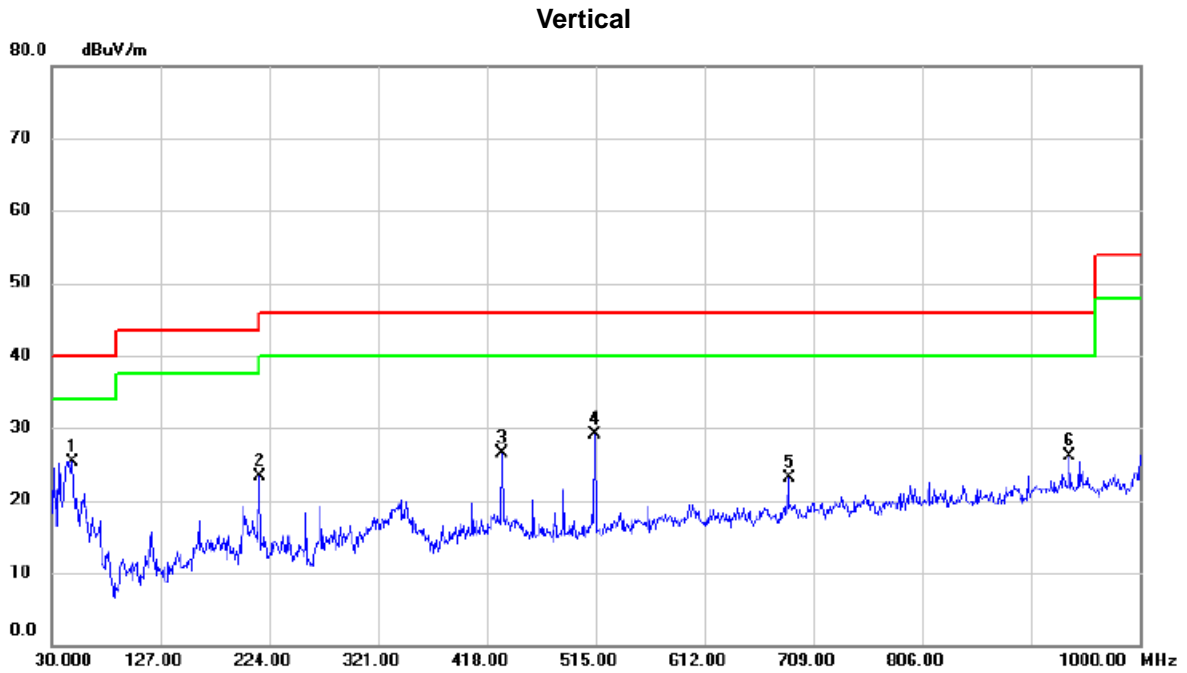

No.	Mk.	Freq. MHz	Reading Level dBuV	Correct Factor dB	Measure- ment dBuV/m	Limit dBuV/m	Margin dB	Detector	Comment
1	*	48.5512	42.61	-17.37	25.24	40.00	-14.76	peak	
2		215.9975	43.75	-20.52	23.23	43.50	-20.27	peak	
3		431.9438	40.68	-14.18	26.50	46.00	-19.50	peak	
4		514.2725	42.02	-12.83	29.19	46.00	-16.81	peak	
5		687.5388	33.31	-10.28	23.03	46.00	-22.97	peak	
6		937.5562	33.94	-7.80	26.14	46.00	-19.86	peak	

REMARKS:

- (1) Measurement Value = Reading Level + Correct Factor.
- (2) Margin Level = Measurement Value - Limit Value.

Test Mode: TX B Mode Channel 11

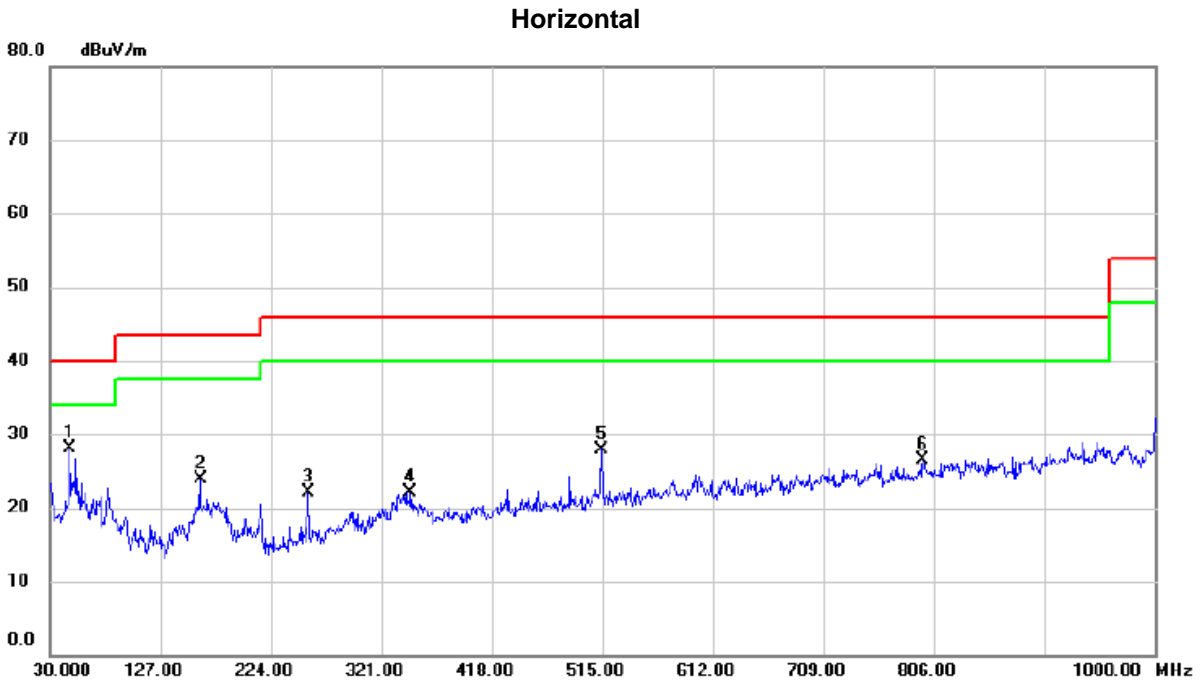

No.	Mk.	Freq. MHz	Reading Level dBuV	Correct Factor dB	Measure- ment dBuV/m	Limit dBuV/m	Margin dB	Detector	Comment
1	*	47.8237	45.42	-17.39	28.03	40.00	-11.97	peak	
2		162.0412	41.05	-17.15	23.90	43.50	-19.60	peak	
3		257.1012	40.49	-18.46	22.03	46.00	-23.97	peak	
4		346.5838	38.21	-16.04	22.17	46.00	-23.83	peak	
5		514.2725	40.83	-12.83	28.00	46.00	-18.00	peak	
6		796.6638	35.28	-8.87	26.41	46.00	-19.59	peak	

REMARKS:

- (1) Measurement Value = Reading Level + Correct Factor.
- (2) Margin Level = Measurement Value - Limit Value.

APPENDIX D - RADIATED EMISSION- ABOVE 1000 MHZ

Test Mode: TX B Mode 2412 MHz

Vertical

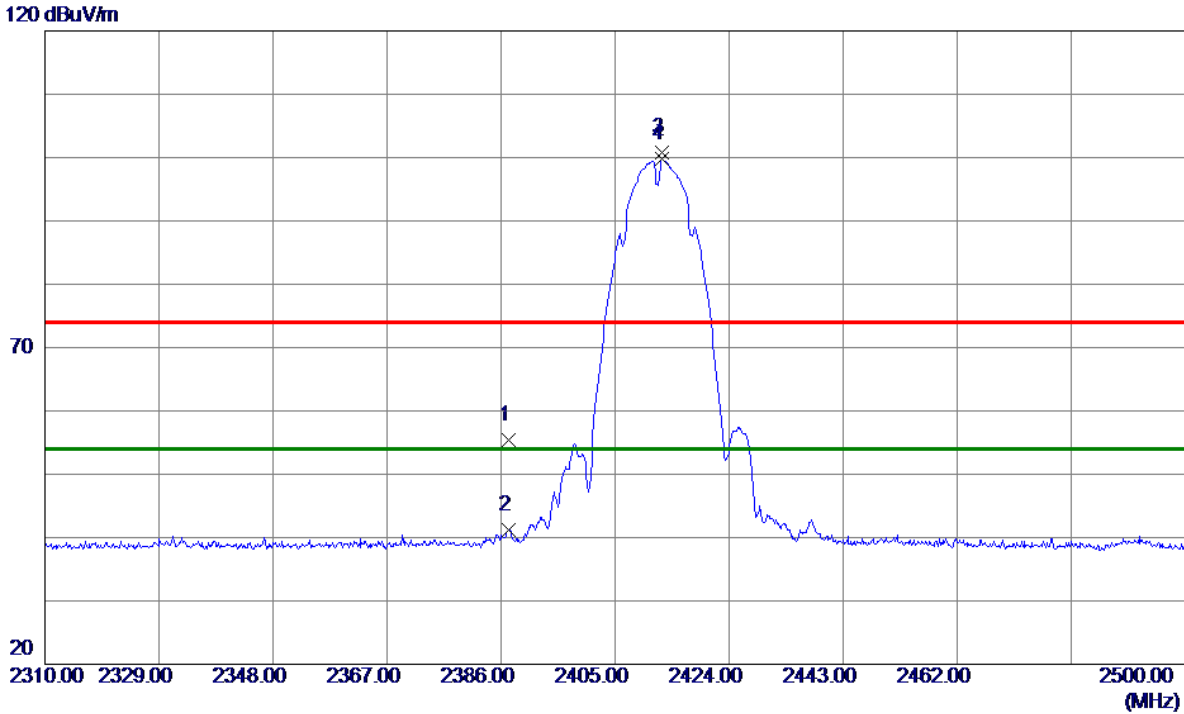

No.	Freq. MHz	Reading Level dBuV/m	Correct Factor dB	Measure ment dBuV/m	Limit dBuV/m	Margin dB	Detector	Comment
1	2387.2350	23.57	31.74	55.31	74.00	-18.69	Peak	
2	2387.2350	9.43	31.74	41.17	54.00	-12.83	AVG	
3	2412.8850	69.16	31.72	100.88	74.00	26.88	Peak	No limit
4 *	2412.8850	68.06	31.72	99.78	54.00	45.78	AVG	No limit

REMARKS:

- (1) Measurement Value = Reading Level + Correct Factor.
- (2) Margin Level = Measurement Value - Limit Value.

Test Mode: TX B Mode 2412 MHz

Vertical

80 dBuV/m

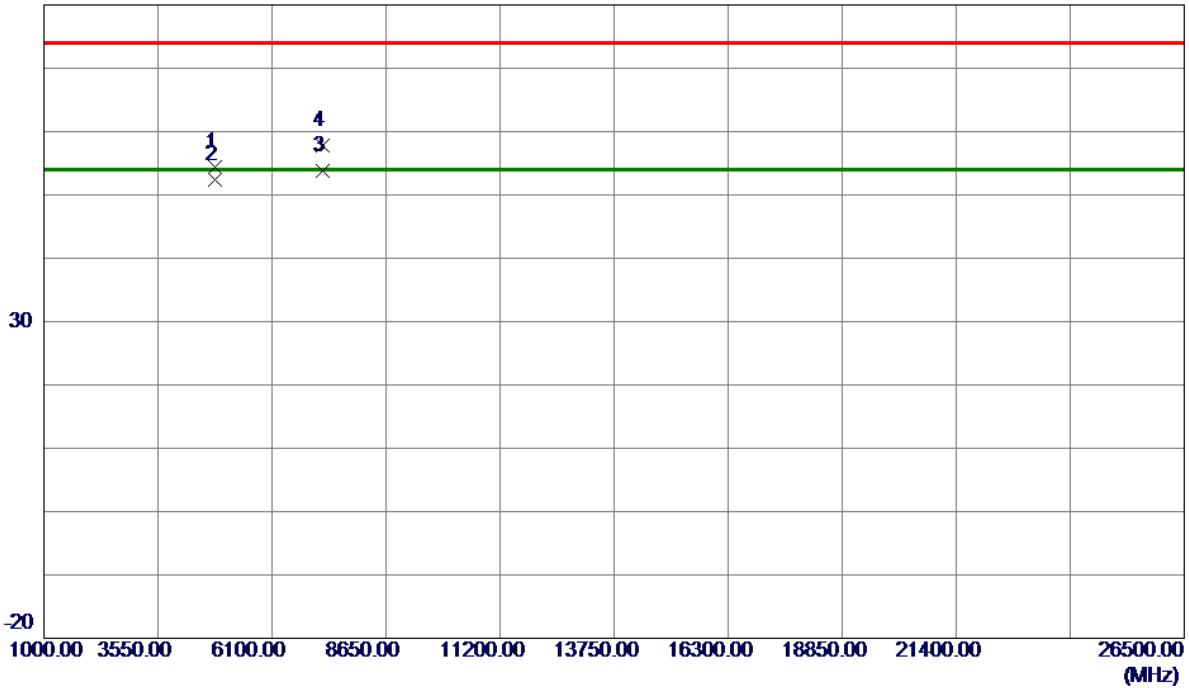

No.	Freq. MHz	Reading Level dBuV/m	Correct Factor dB	Measure ment dBuV/m	Limit dBuV/m	Margin dB	Detector	Comment
1	4823.9800	65.26	-10.91	54.35	74.00	-19.65	Peak	
2	4824.0650	63.36	-10.91	52.45	54.00	-1.55	AVG	
3 *	7235.2130	58.06	-4.17	53.89	54.00	-0.11	AVG	
4	7236.2790	61.96	-4.17	57.79	74.00	-16.21	Peak	

REMARKS:

- (1) Measurement Value = Reading Level + Correct Factor.
- (2) Margin Level = Measurement Value - Limit Value.

Test Mode: TX B Mode 2412 MHz

Horizontal

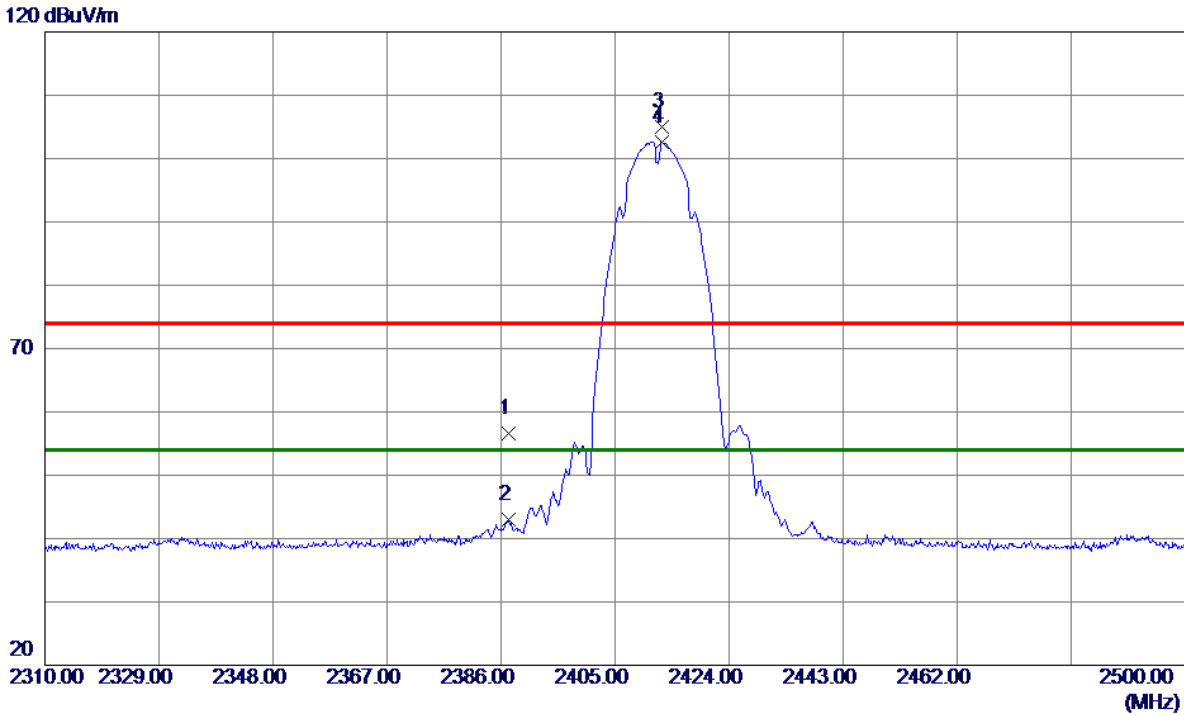

No.	Freq. MHz	Reading Level dBuV/m	Correct Factor dB	Measure ment dBuV/m	Limit dBuV/m	Margin dB	Detector	Comment
1	2387.2350	24.77	31.74	56.51	74.00	-17.49	Peak	
2	2387.2350	11.24	31.74	42.98	54.00	-11.02	AVG	
3	2412.7900	73.21	31.72	104.93	74.00	30.93	Peak	No limit
4 *	2412.7900	70.95	31.72	102.67	54.00	48.67	AVG	No limit

REMARKS:

- (1) Measurement Value = Reading Level + Correct Factor.
- (2) Margin Level = Measurement Value - Limit Value.

Test Mode: TX B Mode 2412 MHz

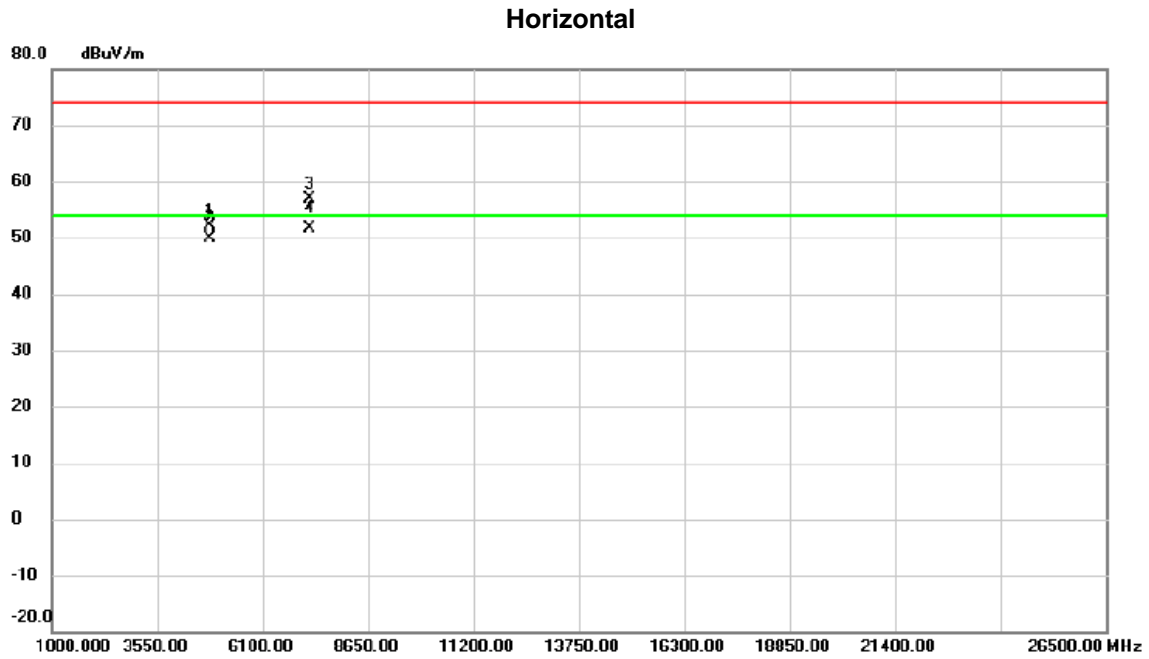

No.	Mk.	Freq. MHz	Reading Level dBuV	Correct Factor dB	Measure- ment dBuV/m	Limit dBuV/m	Margin dB	Detector	Comment
1		4823.972	62.98	-10.90	52.08	74.00	-21.92	peak	
2		4824.070	60.85	-10.90	49.95	54.00	-4.05	AVG	
3		7236.055	60.94	-4.17	56.77	74.00	-17.23	peak	
4	*	7236.843	55.80	-4.17	51.63	54.00	-2.37	AVG	

REMARKS:

- (1) Measurement Value = Reading Level + Correct Factor.
- (2) Margin Level = Measurement Value - Limit Value.

Test Mode: TX B Mode 2437 MHz

Vertical

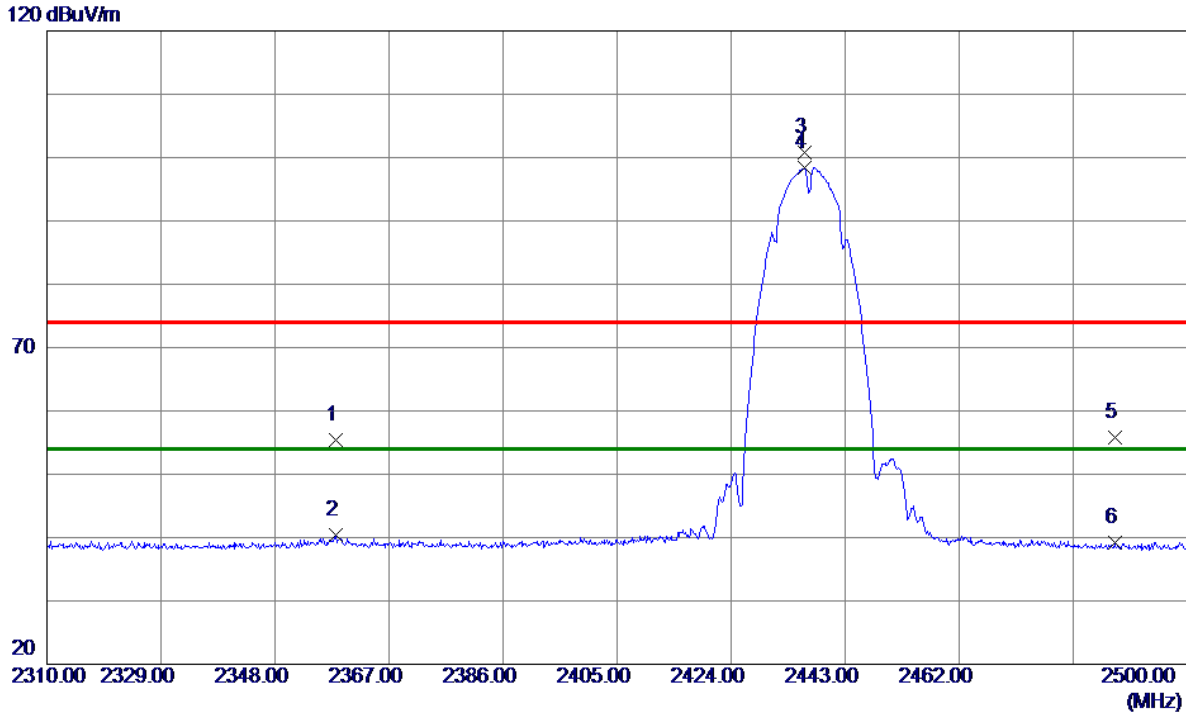

No.	Freq. MHz	Reading Level dBuV/m	Correct Factor dB	Measure ment dBuV/m	Limit dBuV/m	Margin dB	Detector	Comment
1	2358.0700	23.67	31.80	55.47	74.00	-18.53	Peak	
2	2358.0700	8.53	31.80	40.33	54.00	-13.67	AVG	
3	2436.3500	69.13	31.72	100.85	74.00	26.85	Peak	No limit
4 *	2436.3500	66.76	31.72	98.48	54.00	44.48	AVG	No limit
5	2487.9350	24.13	31.71	55.84	74.00	-18.16	Peak	
6	2487.9350	7.57	31.71	39.28	54.00	-14.72	AVG	

REMARKS:

- (1) Measurement Value = Reading Level + Correct Factor.
- (2) Margin Level = Measurement Value - Limit Value.

Test Mode: TX B Mode 2437 MHz

Vertical

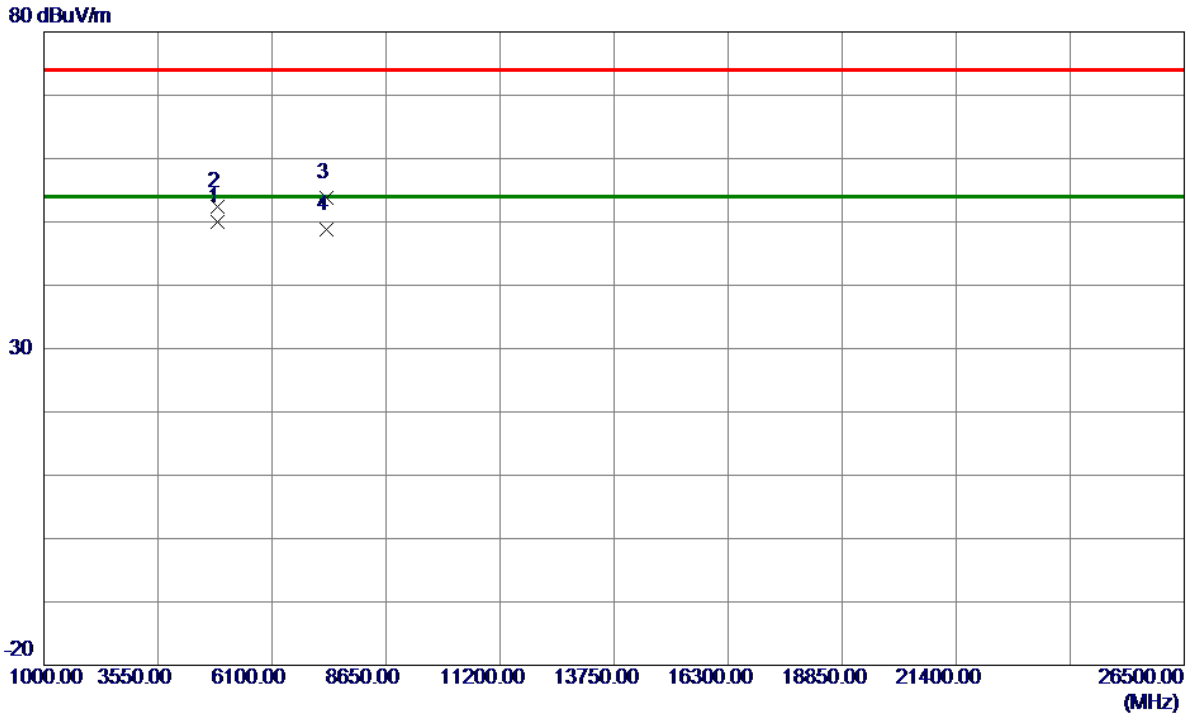

No.	Freq. MHz	Reading Level dBuV/m	Correct Factor dB	Measure ment dBuV/m	Limit dBuV/m	Margin dB	Detector	Comment
1 *	4873.9940	60.79	-10.79	50.00	54.00	-4.00	AVG	
2	4874.1220	63.28	-10.79	52.49	74.00	-21.51	Peak	
3	7310.2300	57.80	-4.08	53.72	74.00	-20.28	Peak	
4	7310.3300	52.91	-4.08	48.83	54.00	-5.17	AVG	

REMARKS:

- (1) Measurement Value = Reading Level + Correct Factor.
- (2) Margin Level = Measurement Value - Limit Value.

Test Mode: TX B Mode 2437 MHz

Horizontal

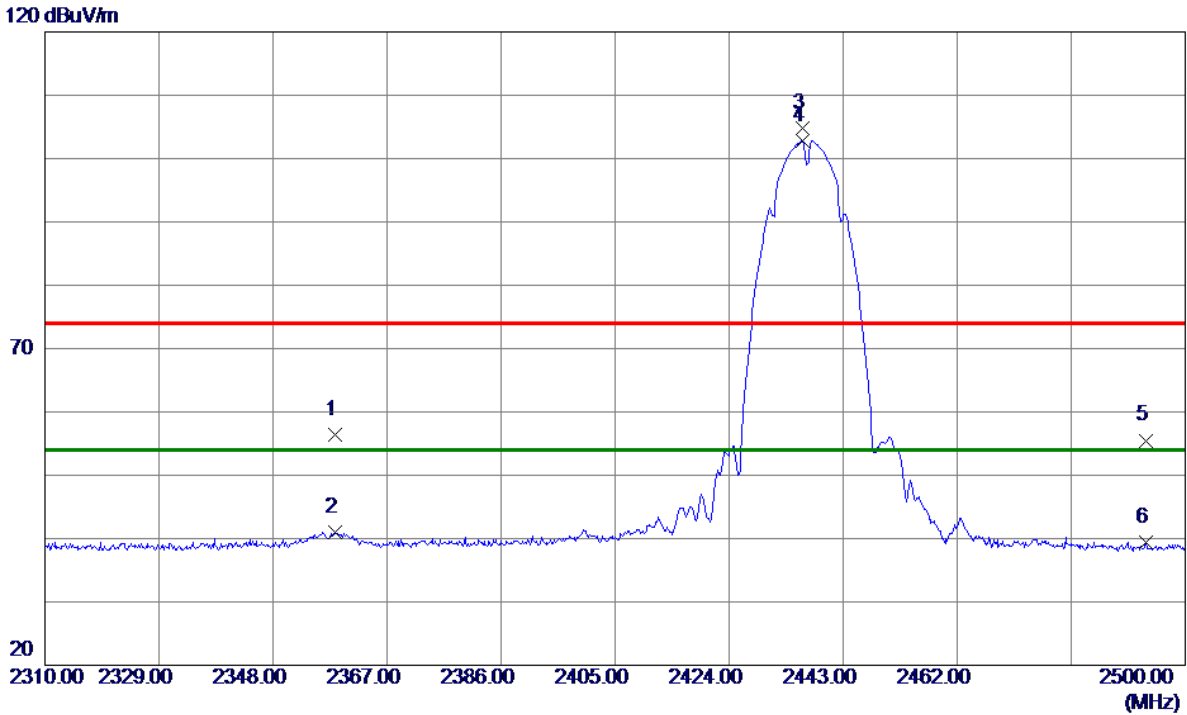

No.	Freq. MHz	Reading Level dBuV/m	Correct Factor dB	Measure ment dBuV/m	Limit dBuV/m	Margin dB	Detector	Comment
1	2358.3550	24.62	31.80	56.42	74.00	-17.58	Peak	
2	2358.3550	9.18	31.80	40.98	54.00	-13.02	AVG	
3	2436.2549	73.14	31.72	104.86	74.00	30.86	Peak	No limit
4 *	2436.2549	71.11	31.72	102.83	54.00	48.83	AVG	No limit
5	2493.4450	23.79	31.71	55.50	74.00	-18.50	Peak	
6	2493.4450	7.63	31.71	39.34	54.00	-14.66	AVG	

REMARKS:

- (1) Measurement Value = Reading Level + Correct Factor.
- (2) Margin Level = Measurement Value - Limit Value.

Test Mode: TX B Mode 2437 MHz

Horizontal

80 dBuV/m

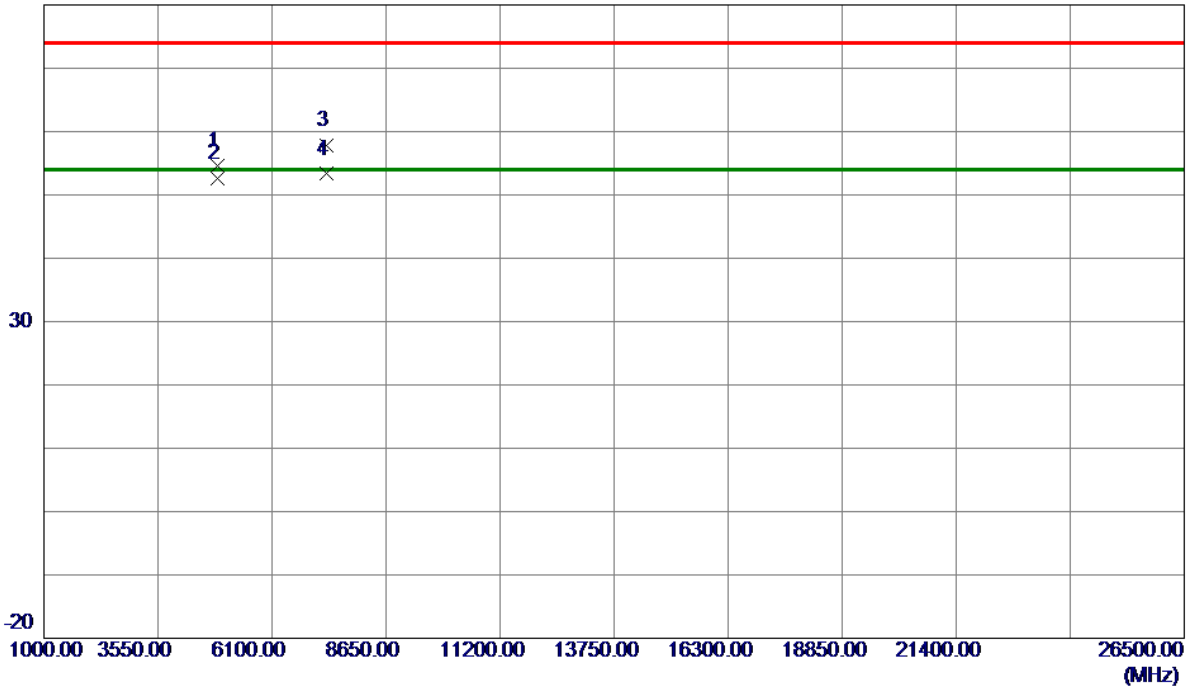

No.	Freq. MHz	Reading Level dBuV/m	Correct Factor dB	Measure ment dBuV/m	Limit dBuV/m	Margin dB	Detector	Comment
1	4873.9950	65.46	-10.79	54.67	74.00	-19.33	Peak	
2	4874.0170	63.46	-10.79	52.67	54.00	-1.33	AVG	
3	7310.9800	61.80	-4.07	57.73	74.00	-16.27	Peak	
4 *	7311.7100	57.37	-4.07	53.30	54.00	-0.70	AVG	

REMARKS:

(1) Measurement Value = Reading Level + Correct Factor.

(2) Margin Level = Measurement Value - Limit Value.

Test Mode: TX B Mode 2462 MHz

Vertical

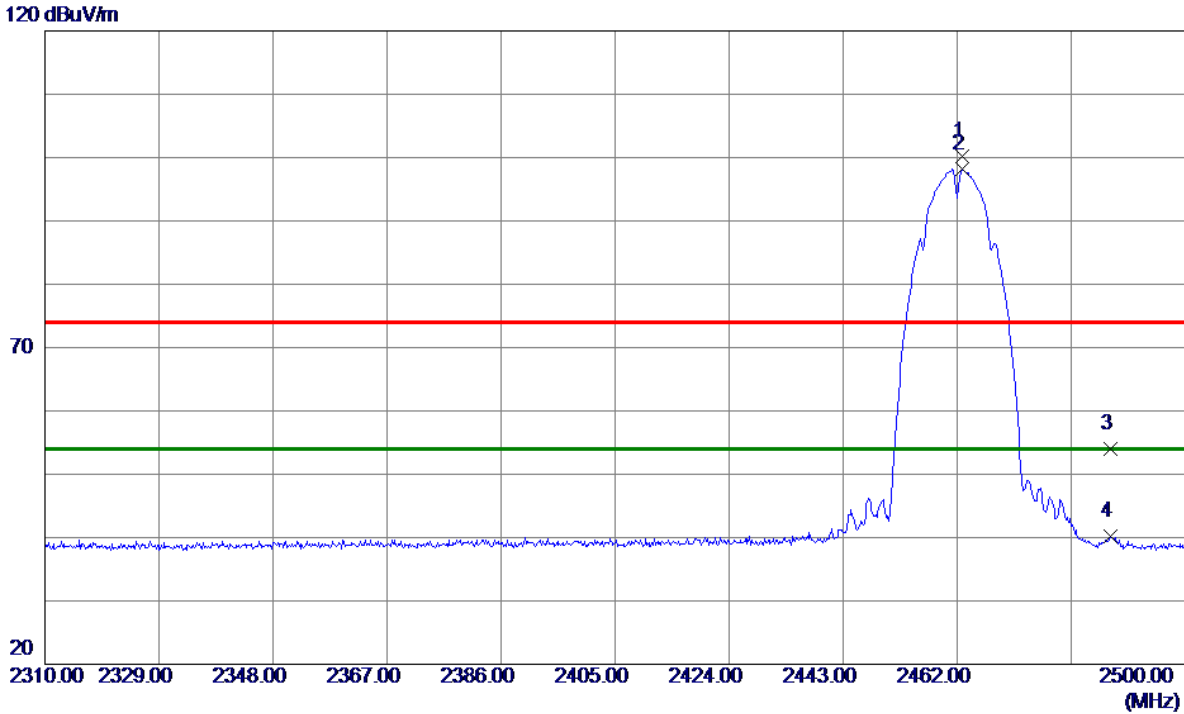

No.	Freq. MHz	Reading Level dBuV/m	Correct Factor dB	Measure ment dBuV/m	Limit dBuV/m	Margin dB	Detector	Comment
1	2462.7600	68.48	31.71	100.19	74.00	26.19	Peak	No limit
2 *	2462.7600	66.46	31.71	98.17	54.00	44.17	AVG	No limit
3	2487.5550	22.37	31.71	54.08	74.00	-19.92	Peak	
4	2487.5550	8.42	31.71	40.13	54.00	-13.87	AVG	

REMARKS:

- (1) Measurement Value = Reading Level + Correct Factor.
- (2) Margin Level = Measurement Value - Limit Value.

Test Mode: TX B Mode 2462 MHz

Vertical

80 dBuV/m

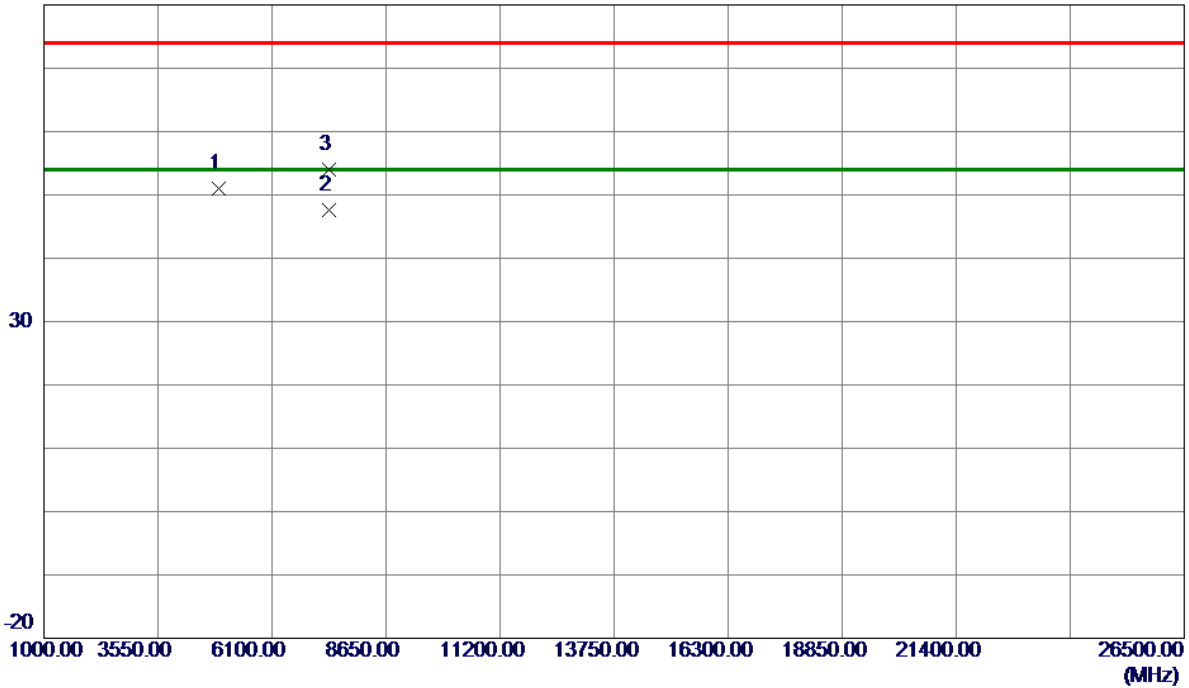

No.	Freq. MHz	Reading Level dBuV/m	Correct Factor dB	Measure ment dBuV/m	Limit dBuV/m	Margin dB	Detector	Comment
1	4923.9280	61.55	-10.63	50.92	74.00	-23.08	Peak	
2 *	7385.2900	51.49	-3.98	47.51	54.00	-6.49	AVG	
3	7385.9500	57.97	-3.98	53.99	74.00	-20.01	Peak	

REMARKS:

- (1) Measurement Value = Reading Level + Correct Factor.
- (2) Margin Level = Measurement Value - Limit Value.

Test Mode: TX B Mode 2462 MHz

Horizontal

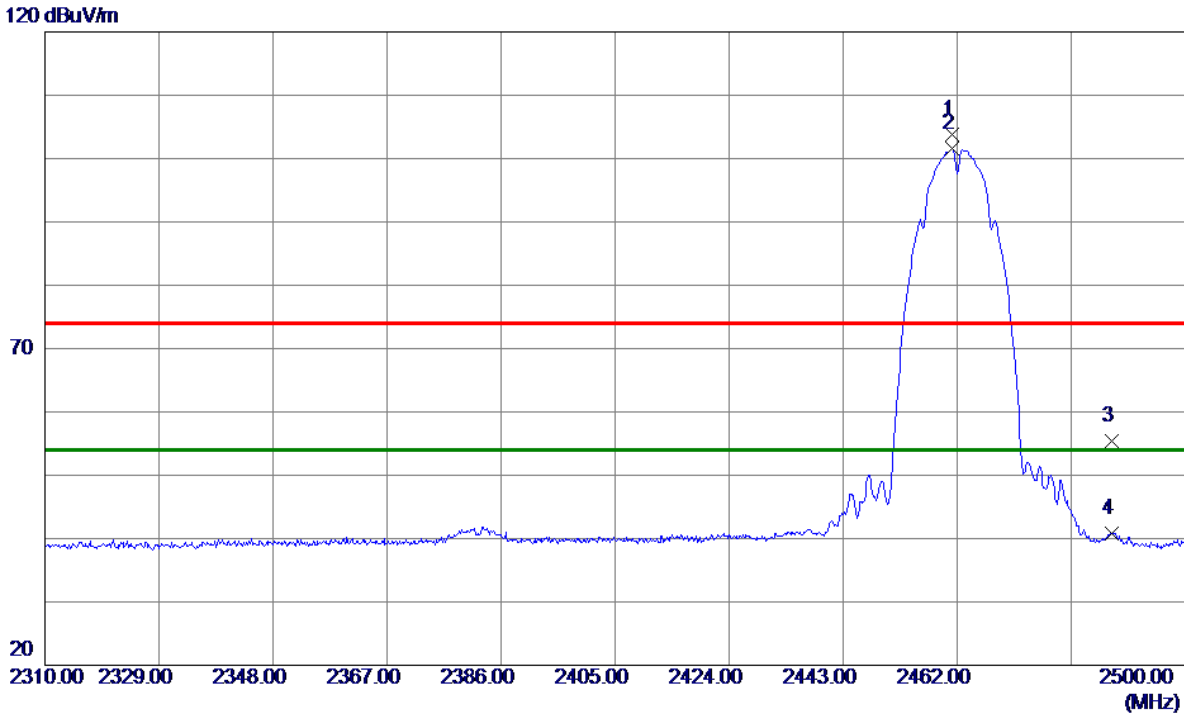

No.	Freq. MHz	Reading Level dBuV/m	Correct Factor dB	Measure ment dBuV/m	Limit dBuV/m	Margin dB	Detector	Comment
1	2461.2400	72.09	31.71	103.80	74.00	29.80	Peak	No limit
2 *	2461.2400	69.90	31.71	101.61	54.00	47.61	AVG	No limit
3	2487.6500	23.64	31.71	55.35	74.00	-18.65	Peak	
4	2487.6500	9.17	31.71	40.88	54.00	-13.12	AVG	

REMARKS:

- (1) Measurement Value = Reading Level + Correct Factor.
- (2) Margin Level = Measurement Value - Limit Value.

Test Mode: TX B Mode 2462 MHz

Horizontal

80 dBuV/m

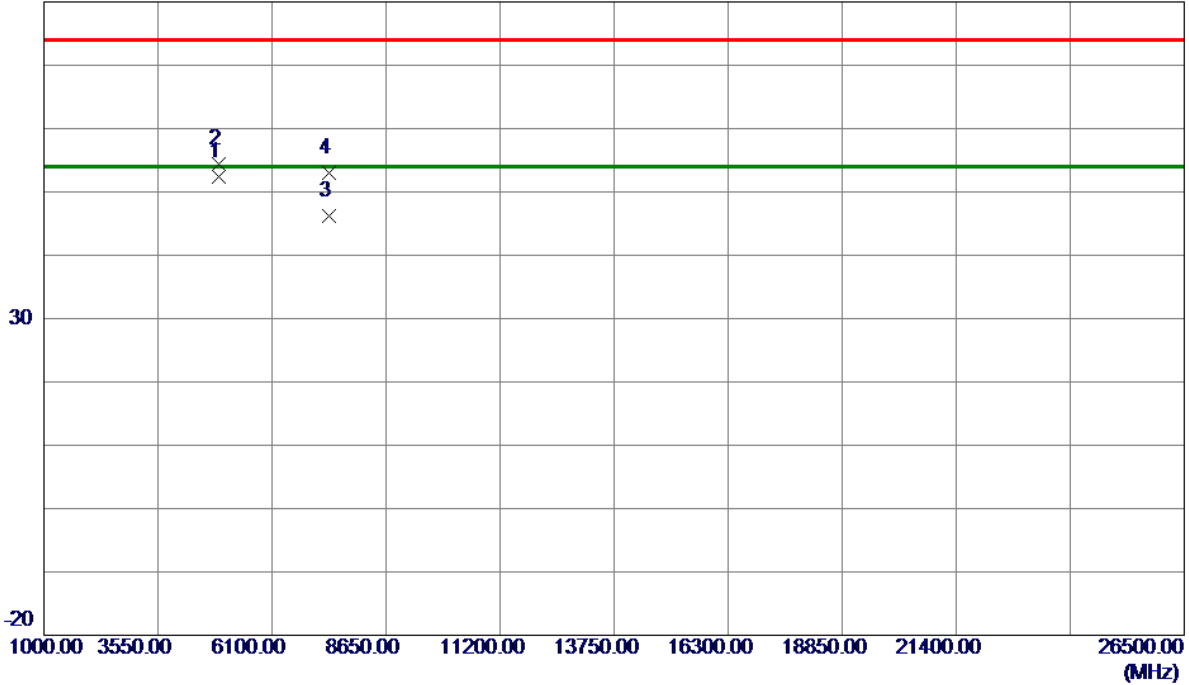

No.	Freq. MHz	Reading Level dBuV/m	Correct Factor dB	Measure ment dBuV/m	Limit dBuV/m	Margin dB	Detector	Comment
1 *	4924.0200	63.12	-10.63	52.49	54.00	-1.51	AVG	
2	4924.1530	64.99	-10.63	54.36	74.00	-19.64	Peak	
3	7385.2800	50.10	-3.98	46.12	54.00	-7.88	AVG	
4	7386.1000	57.05	-3.98	53.07	74.00	-20.93	Peak	

REMARKS:

- (1) Measurement Value = Reading Level + Correct Factor.
- (2) Margin Level = Measurement Value - Limit Value.

Test Mode: TX G Mode 2412 MHz

Vertical

120 dBuV/m

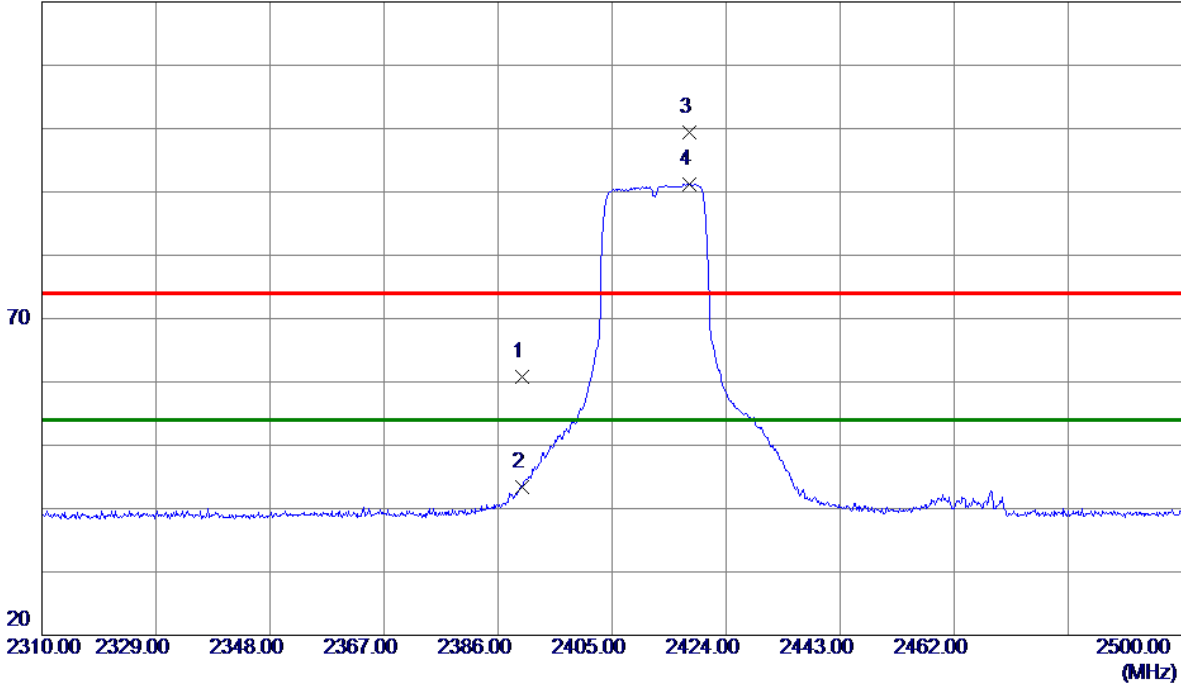

No.	Freq. MHz	Reading Level dBuV/m	Correct Factor dB	Measure ment dBuV/m	Limit dBuV/m	Margin dB	Detector	Comment
1	2390.0000	29.03	31.74	60.77	74.00	-13.23	Peak	
2	2390.0000	11.73	31.74	43.47	54.00	-10.53	AVG	
3	2417.9200	67.67	31.72	99.39	74.00	25.39	Peak	No limit
4 *	2417.9200	59.55	31.72	91.27	54.00	37.27	AVG	No limit

REMARKS:

- (1) Measurement Value = Reading Level + Correct Factor.
- (2) Margin Level = Measurement Value - Limit Value.

Test Mode: TX G Mode 2412 MHz

Vertical

80 dBuV/m

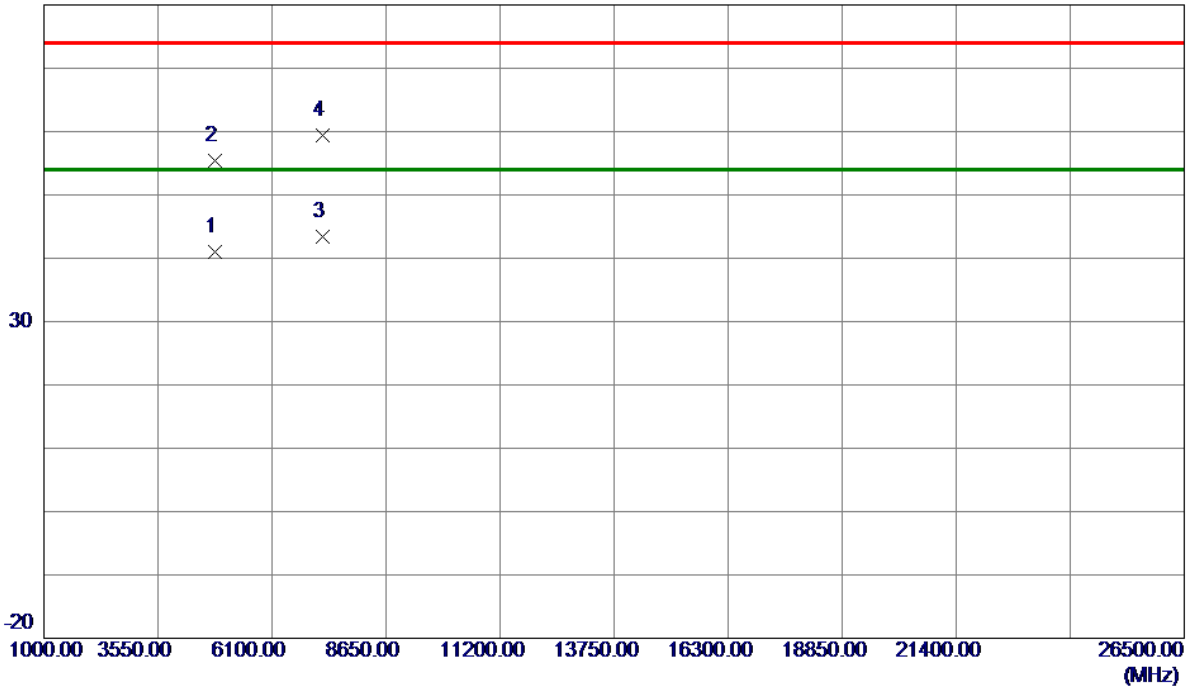

No.	Freq. MHz	Reading Level dBuV/m	Correct Factor dB	Measure ment dBuV/m	Limit dBuV/m	Margin dB	Detector	Comment
1	4824.2900	51.83	-10.91	40.92	54.00	-13.08	AVG	
2	4825.8180	66.23	-10.90	55.33	74.00	-18.67	Peak	
3 *	7236.1250	47.58	-4.17	43.41	54.00	-10.59	AVG	
4	7238.2750	63.64	-4.17	59.47	74.00	-14.53	Peak	

REMARKS:

- (1) Measurement Value = Reading Level + Correct Factor.
- (2) Margin Level = Measurement Value - Limit Value.

Test Mode: TX G Mode 2412 MHz

Horizontal

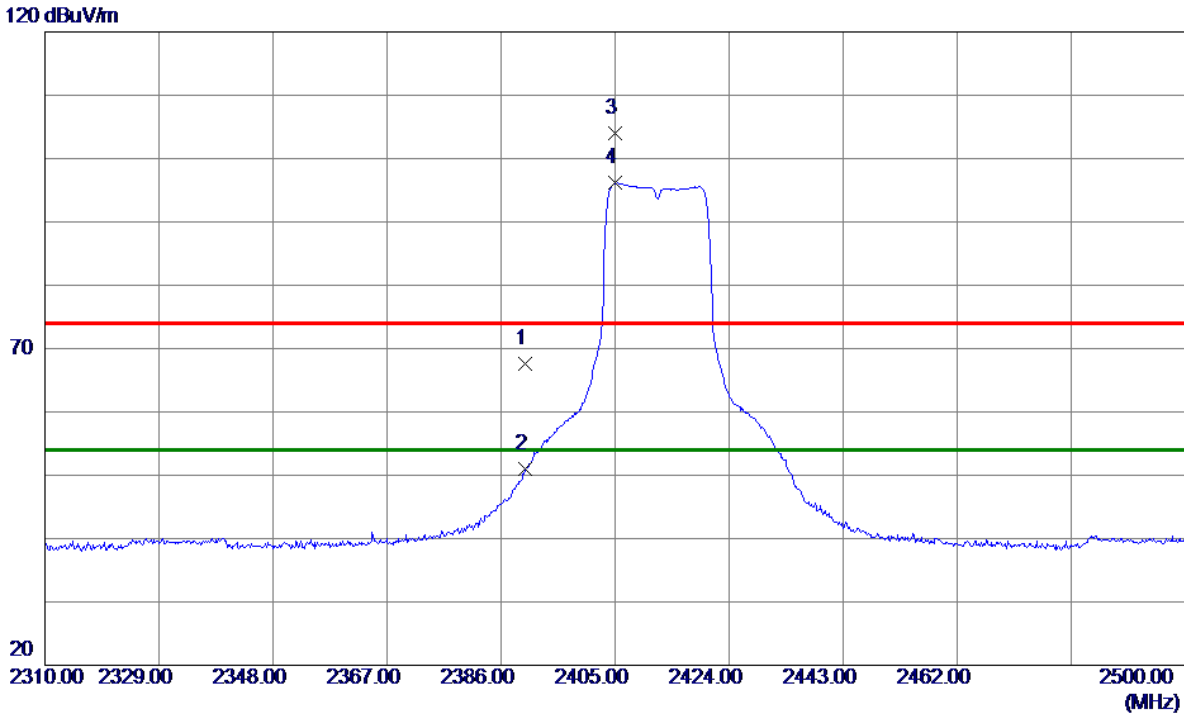

No.	Freq. MHz	Reading Level dBuV/m	Correct Factor dB	Measure ment dBuV/m	Limit dBuV/m	Margin dB	Detector	Comment
1	2390.0000	35.83	31.74	67.57	74.00	-6.43	Peak	
2	2390.0000	19.32	31.74	51.06	54.00	-2.94	AVG	
3	2405.0950	72.24	31.72	103.96	74.00	29.96	Peak	No limit
4 *	2405.0950	64.42	31.72	96.14	54.00	42.14	AVG	No limit

REMARKS:

- (1) Measurement Value = Reading Level + Correct Factor.
- (2) Margin Level = Measurement Value - Limit Value.

Test Mode: TX G Mode 2412 MHz

Horizontal

80 dBuV/m

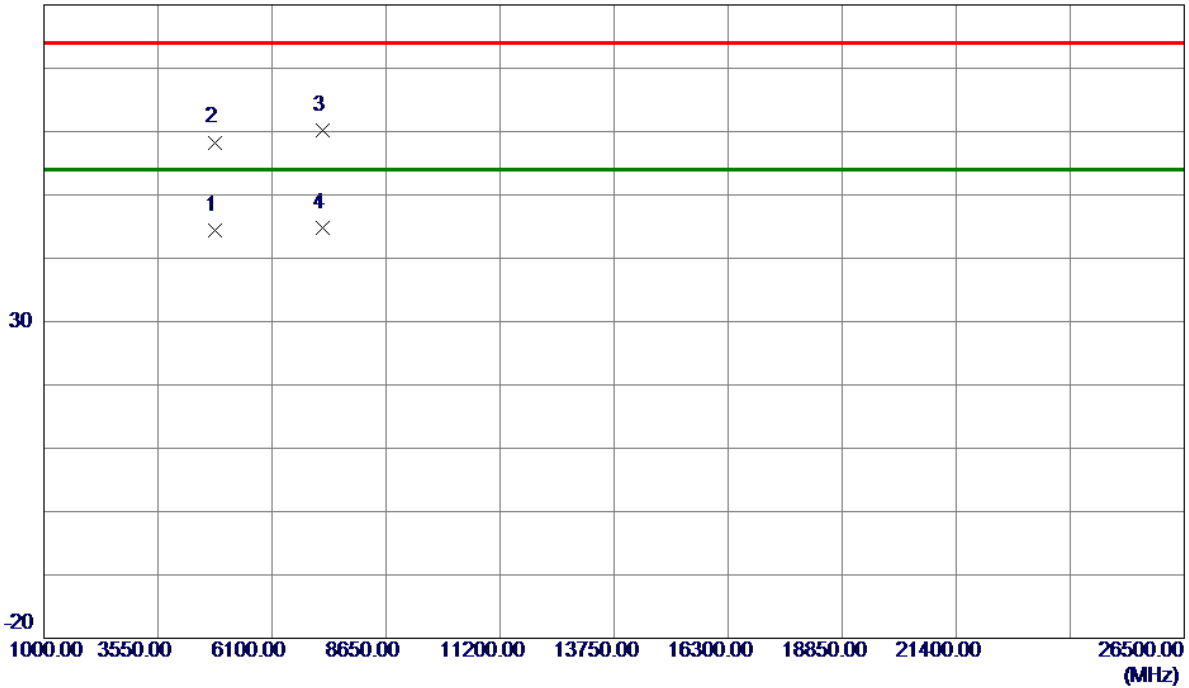

No.	Freq. MHz	Reading Level dBuV/m	Correct Factor dB	Measure ment dBuV/m	Limit dBuV/m	Margin dB	Detector	Comment
1	4824.1500	55.24	-10.91	44.33	54.00	-9.67	AVG	
2	4825.9400	69.20	-10.90	58.30	74.00	-15.70	Peak	
3	7237.0400	64.30	-4.17	60.13	74.00	-13.87	Peak	
4 *	7238.8600	48.92	-4.17	44.75	54.00	-9.25	AVG	

REMARKS:

- (1) Measurement Value = Reading Level + Correct Factor.
- (2) Margin Level = Measurement Value - Limit Value.

Test Mode: TX G Mode 2437 MHz

Vertical

120 dBuV/m

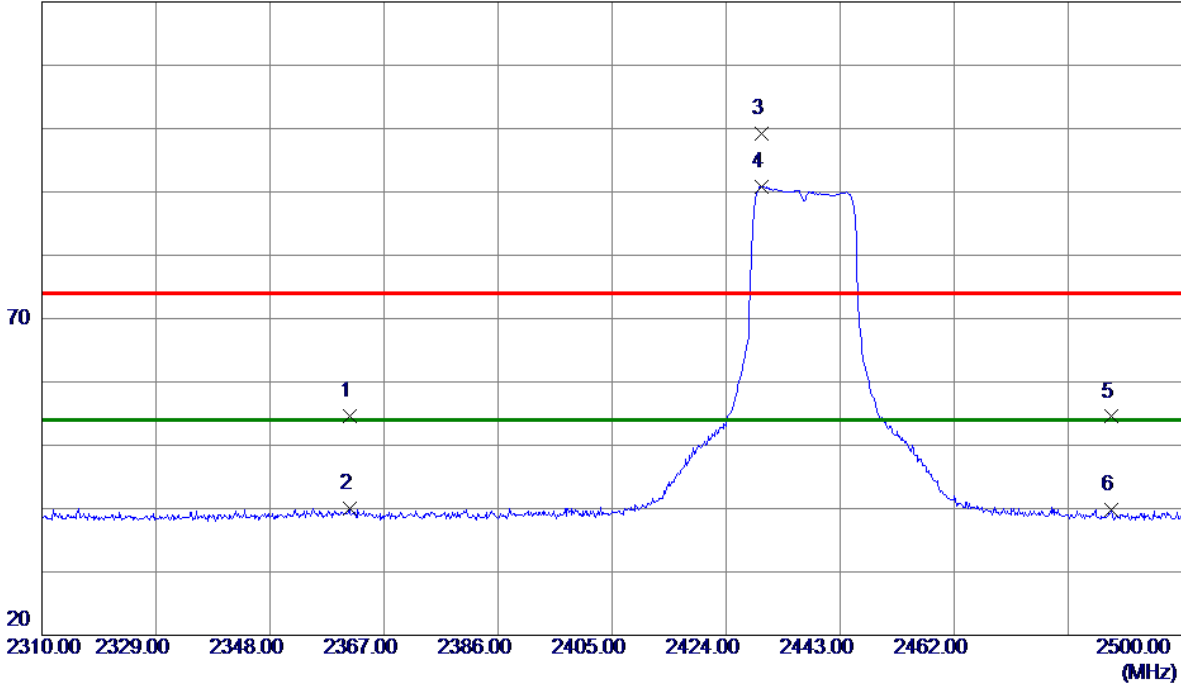

No.	Freq. MHz	Reading Level dBuV/m	Correct Factor dB	Measure ment dBuV/m	Limit dBuV/m	Margin dB	Detector	Comment
1	2361.2050	22.77	31.80	54.57	74.00	-19.43	Peak	
2	2361.2050	8.23	31.80	40.03	54.00	-13.97	AVG	
3	2429.9850	67.39	31.72	99.11	74.00	25.11	Peak	No limit
4 *	2429.9850	59.12	31.72	90.84	54.00	36.84	AVG	No limit
5	2488.2200	22.79	31.71	54.50	74.00	-19.50	Peak	
6	2488.2200	8.00	31.71	39.71	54.00	-14.29	AVG	

REMARKS:

- (1) Measurement Value = Reading Level + Correct Factor.
- (2) Margin Level = Measurement Value - Limit Value.

Test Mode: TX G Mode 2437 MHz

Vertical

80 dBuV/m

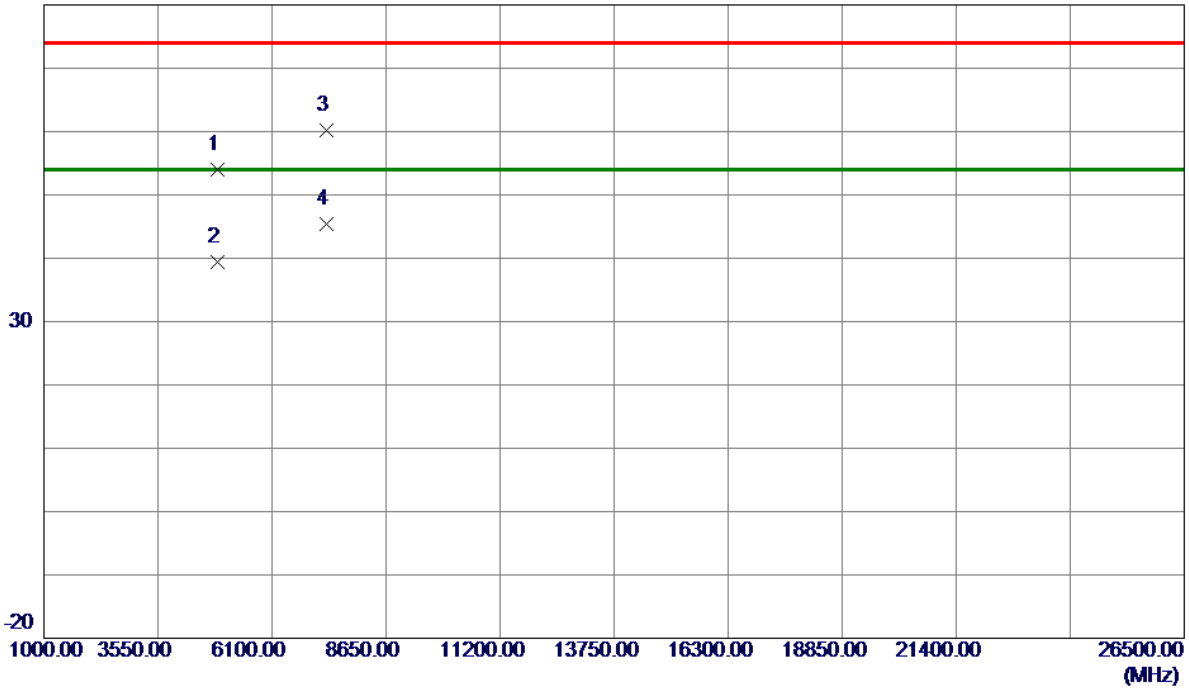

No.	Freq. MHz	Reading Level dBuV/m	Correct Factor dB	Measure ment dBuV/m	Limit dBuV/m	Margin dB	Detector	Comment
1	4871.3750	64.74	-10.80	53.94	74.00	-20.06	Peak	
2	4872.8000	50.16	-10.80	39.36	54.00	-14.64	AVG	
3	7305.5500	64.26	-4.08	60.18	74.00	-13.82	Peak	
4 *	7309.5750	49.40	-4.08	45.32	54.00	-8.68	AVG	

REMARKS:

- (1) Measurement Value = Reading Level + Correct Factor.
- (2) Margin Level = Measurement Value - Limit Value.

Test Mode: TX G Mode 2437 MHz

Horizontal

120 dBuV/m

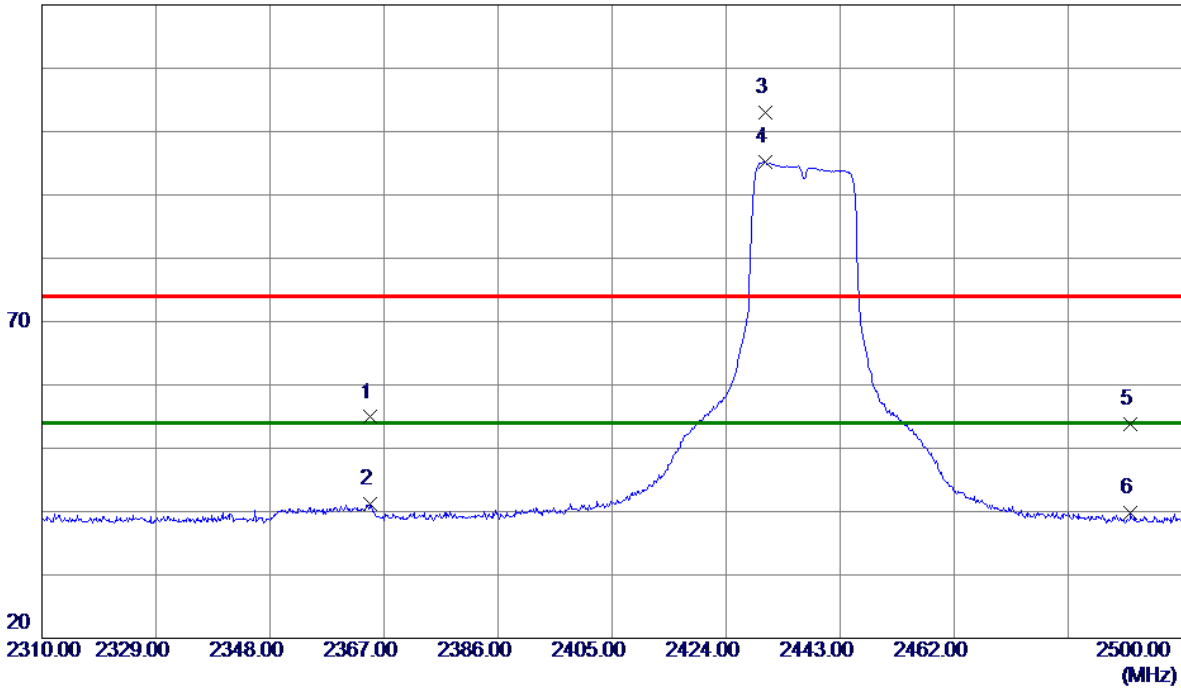

No.	Freq. MHz	Reading Level dBuV/m	Correct Factor dB	Measure ment dBuV/m	Limit dBuV/m	Margin dB	Detector	Comment
1	2364.7200	23.11	31.79	54.90	74.00	-19.10	Peak	
2	2364.7200	9.44	31.79	41.23	54.00	-12.77	AVG	
3	2430.4600	71.21	31.72	102.93	74.00	28.93	Peak	No limit
4 *	2430.4600	63.41	31.72	95.13	54.00	41.13	AVG	No limit
5	2491.4500	22.16	31.71	53.87	74.00	-20.13	Peak	
6	2491.4500	8.06	31.71	39.77	54.00	-14.23	AVG	

REMARKS:

- (1) Measurement Value = Reading Level + Correct Factor.
- (2) Margin Level = Measurement Value - Limit Value.

Test Mode: TX G Mode 2437 MHz

Horizontal

80 dBuV/m

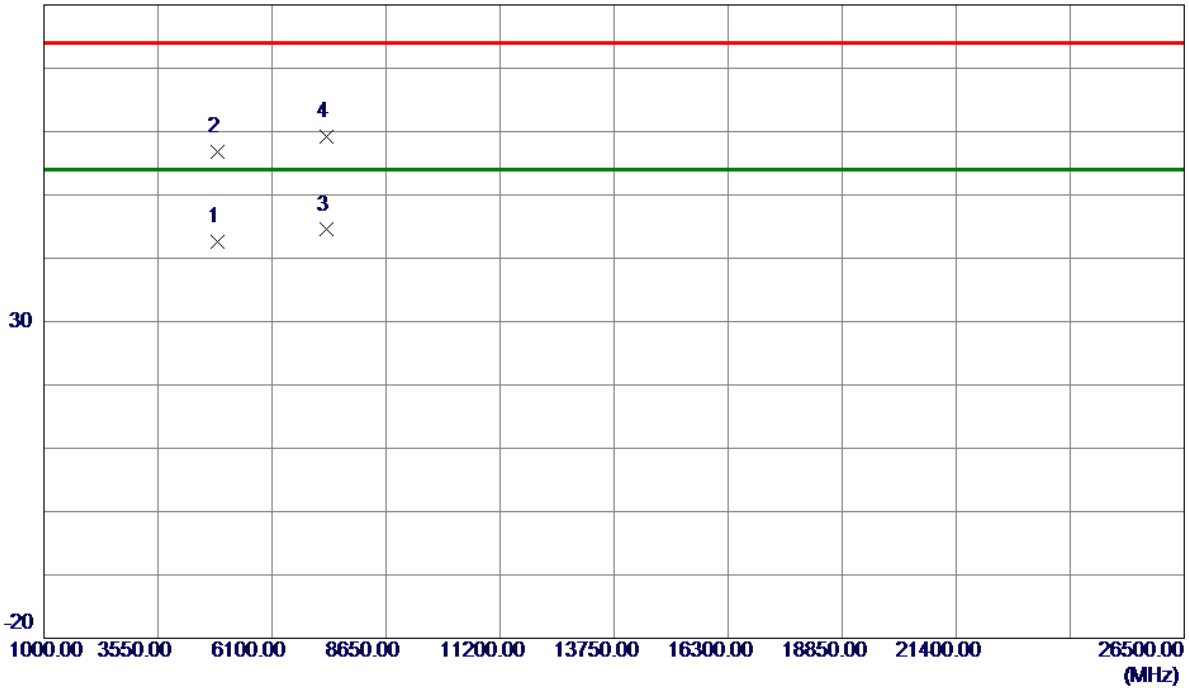

No.	Freq. MHz	Reading Level dBuV/m	Correct Factor dB	Measure ment dBuV/m	Limit dBuV/m	Margin dB	Detector	Comment
1	4873.6750	53.34	-10.79	42.55	54.00	-11.45	AVG	
2	4874.5750	67.56	-10.79	56.77	74.00	-17.23	Peak	
3 *	7311.5250	48.57	-4.07	44.50	54.00	-9.50	AVG	
4	7312.8000	63.19	-4.07	59.12	74.00	-14.88	Peak	

REMARKS:

(1) Measurement Value = Reading Level + Correct Factor.

(2) Margin Level = Measurement Value - Limit Value.

Test Mode: TX G Mode 2462 MHz

Vertical

120 dBuV/m

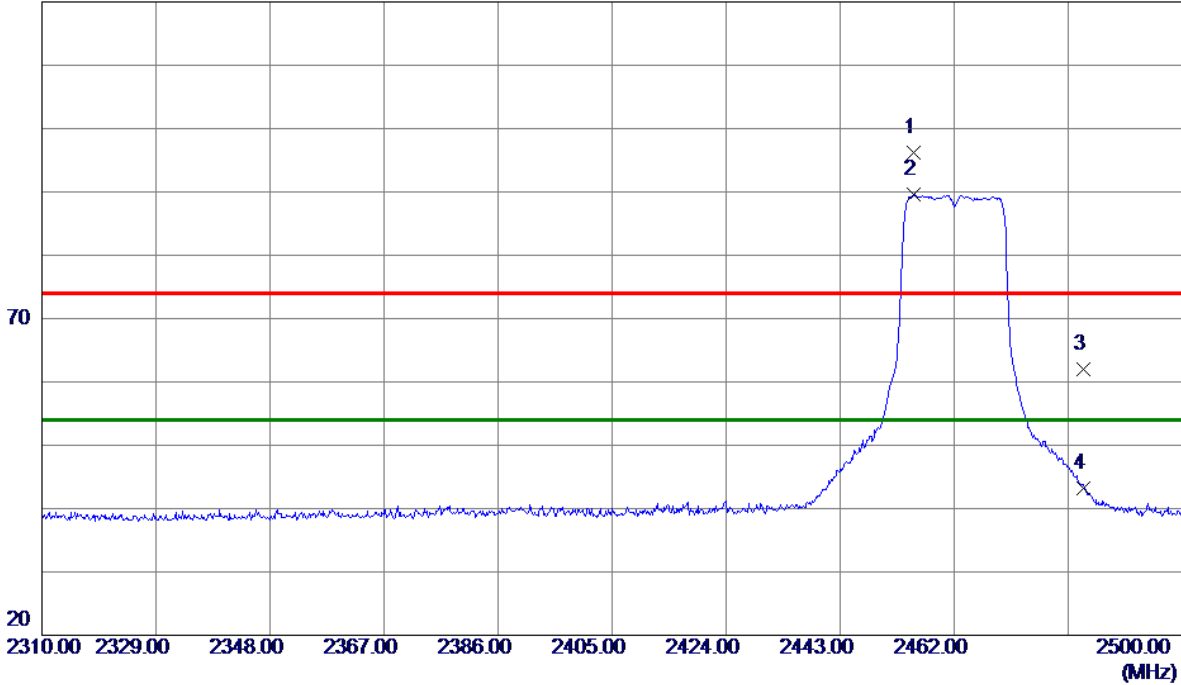

No.	Freq. MHz	Reading Level dBuV/m	Correct Factor dB	Measure ment dBuV/m	Limit dBuV/m	Margin dB	Detector	Comment
1	2455.3500	64.43	31.71	96.14	74.00	22.14	Peak	No limit
2 *	2455.3500	57.89	31.71	89.60	54.00	35.60	AVG	No limit
3	2483.5000	30.37	31.71	62.08	74.00	-11.92	Peak	
4	2483.5000	11.50	31.71	43.21	54.00	-10.79	AVG	

REMARKS:

- (1) Measurement Value = Reading Level + Correct Factor.
- (2) Margin Level = Measurement Value - Limit Value.

Test Mode: TX G Mode 2462 MHz

Vertical

80 dBuV/m

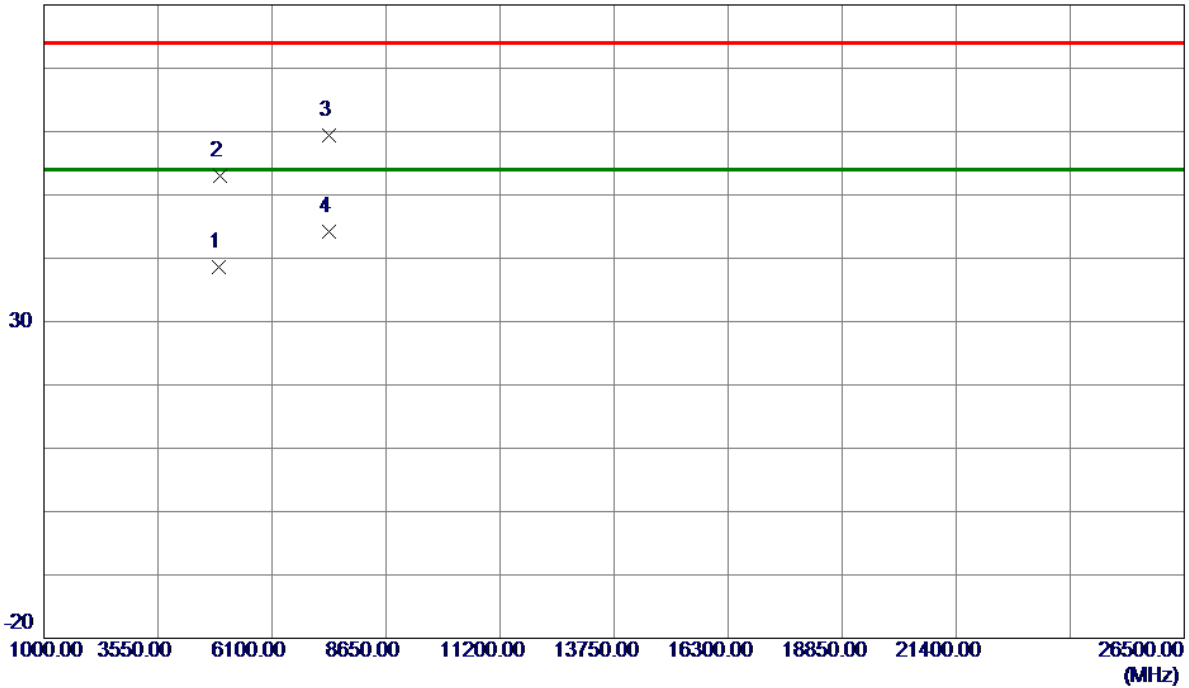

No.	Freq. MHz	Reading Level dBuV/m	Correct Factor dB	Measure ment dBuV/m	Limit dBuV/m	Margin dB	Detector	Comment
1	4923.7750	49.23	-10.63	38.60	54.00	-15.40	AVG	
2	4924.5000	63.62	-10.62	53.00	74.00	-21.00	Peak	
3	7378.3000	63.48	-3.99	59.49	74.00	-14.51	Peak	
4 *	7383.8500	48.21	-3.98	44.23	54.00	-9.77	AVG	

REMARKS:

- (1) Measurement Value = Reading Level + Correct Factor.
- (2) Margin Level = Measurement Value - Limit Value.

Test Mode: TX G Mode 2462 MHz

Horizontal

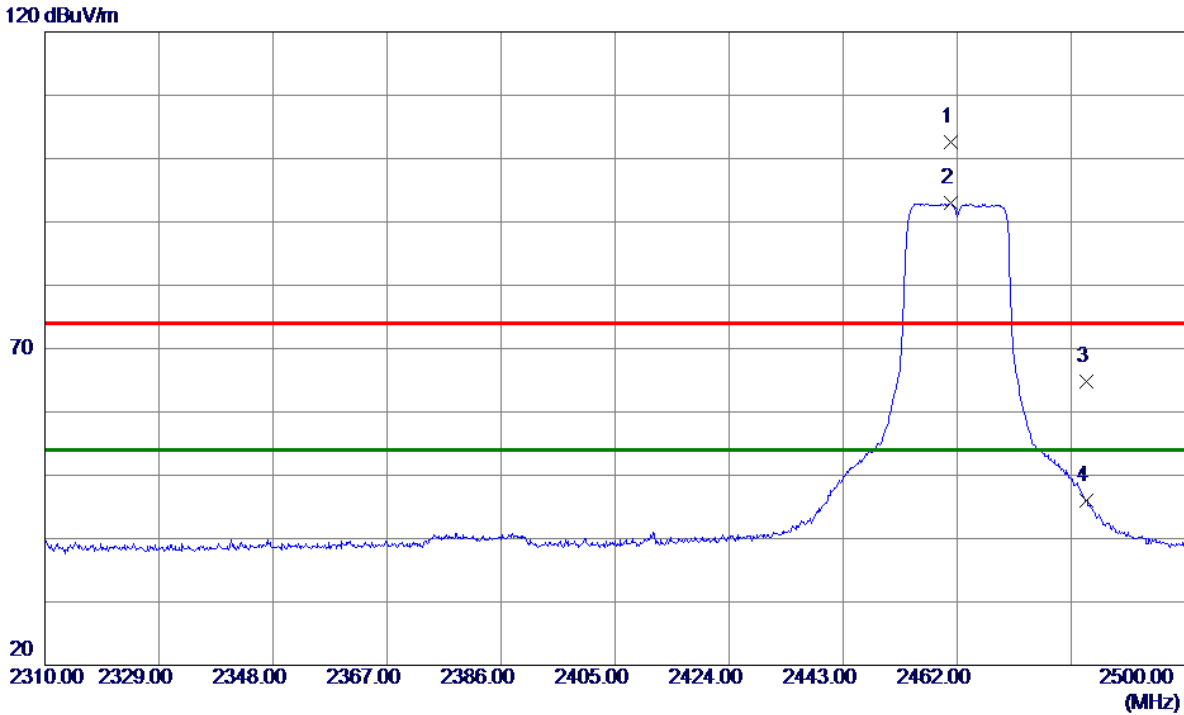

No.	Freq. MHz	Reading Level dBuV/m	Correct Factor dB	Measure ment dBuV/m	Limit dBuV/m	Margin dB	Detector	Comment
1	2460.8600	70.84	31.71	102.55	74.00	28.55	Peak	No limit
2 *	2460.8600	61.20	31.71	92.91	54.00	38.91	AVG	No limit
3	2483.5000	33.11	31.71	64.82	74.00	-9.18	Peak	
4	2483.5000	14.23	31.71	45.94	54.00	-8.06	AVG	

REMARKS:

- (1) Measurement Value = Reading Level + Correct Factor.
- (2) Margin Level = Measurement Value - Limit Value.

Test Mode: TX G Mode 2462 MHz

Horizontal

80 dBuV/m

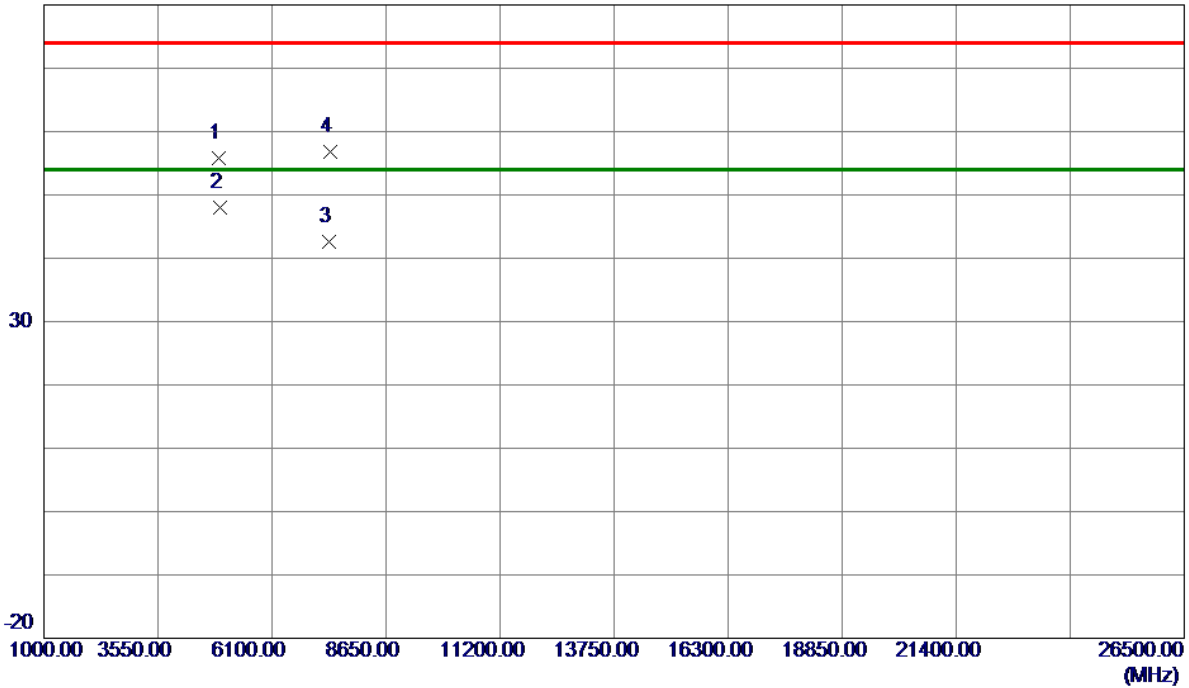

No.	Freq. MHz	Reading Level dBuV/m	Correct Factor dB	Measure ment dBuV/m	Limit dBuV/m	Margin dB	Detector	Comment
1	4923.1500	66.34	-10.63	55.71	74.00	-18.29	Peak	
2 *	4925.5250	58.64	-10.62	48.02	54.00	-5.98	AVG	
3	7382.2500	46.59	-3.98	42.61	54.00	-11.39	AVG	
4	7396.2000	60.77	-3.96	56.81	74.00	-17.19	Peak	

REMARKS:

- (1) Measurement Value = Reading Level + Correct Factor.
- (2) Margin Level = Measurement Value - Limit Value.

Test Mode: TX N-20M Mode 2412 MHz

Vertical

120 dBuV/m

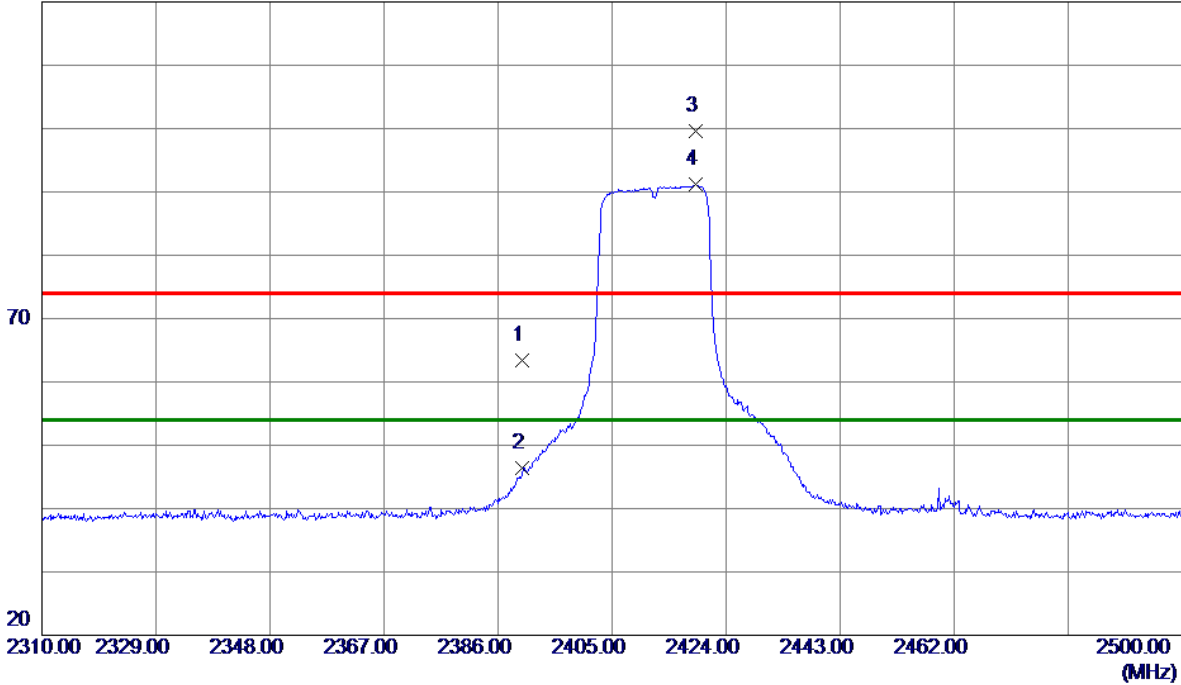

No.	Freq. MHz	Reading Level dBuV/m	Correct Factor dB	Measure ment dBuV/m	Limit dBuV/m	Margin dB	Detector	Comment
1	2390.0000	31.71	31.74	63.45	74.00	-10.55	Peak	
2	2390.0000	14.66	31.74	46.40	54.00	-7.60	AVG	
3	2418.9650	67.90	31.72	99.62	74.00	25.62	Peak	No limit
4 *	2418.9650	59.41	31.72	91.13	54.00	37.13	AVG	No limit

REMARKS:

- (1) Measurement Value = Reading Level + Correct Factor.
- (2) Margin Level = Measurement Value - Limit Value.

Test Mode: TX N-20M Mode 2412 MHz

Vertical

80 dBuV/m

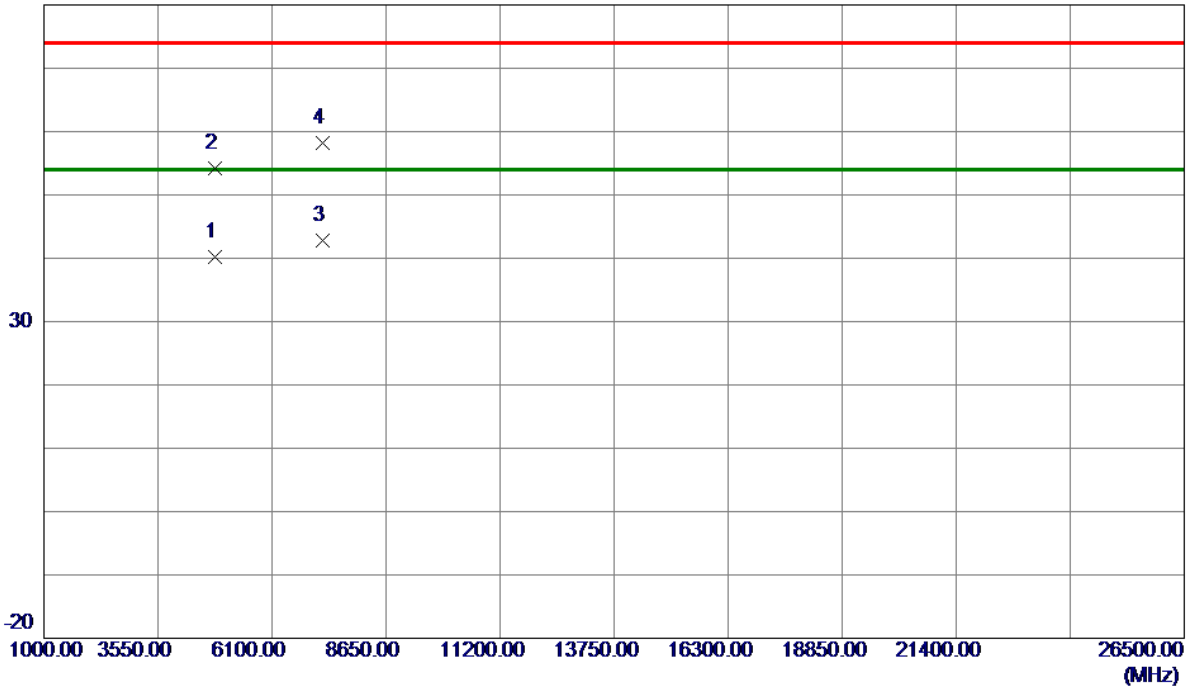

No.	Freq. MHz	Reading Level dBuV/m	Correct Factor dB	Measure ment dBuV/m	Limit dBuV/m	Margin dB	Detector	Comment
1	4824.7250	51.01	-10.90	40.11	54.00	-13.89	AVG	
2	4824.7750	65.18	-10.90	54.28	74.00	-19.72	Peak	
3 *	7231.9000	46.98	-4.18	42.80	54.00	-11.20	AVG	
4	7239.5750	62.29	-4.17	58.12	74.00	-15.88	Peak	

REMARKS:

- (1) Measurement Value = Reading Level + Correct Factor.
- (2) Margin Level = Measurement Value - Limit Value.

Test Mode: TX N-20M Mode 2412 MHz

Horizontal

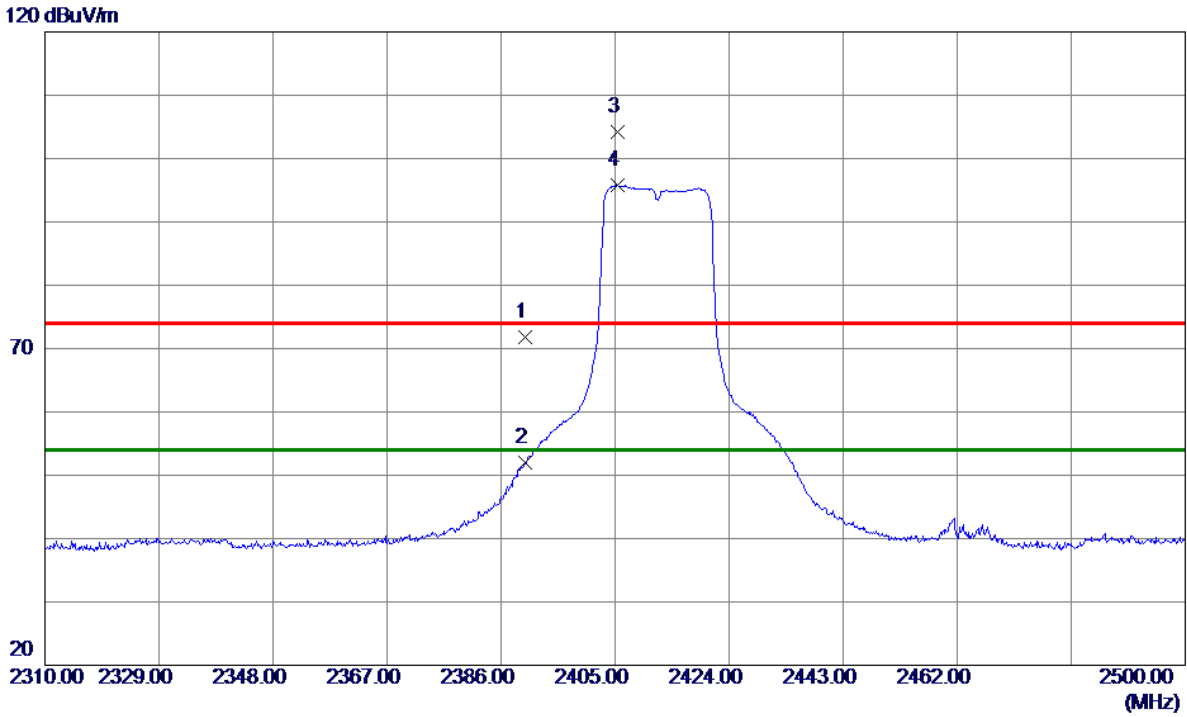

No.	Freq. MHz	Reading Level dBuV/m	Correct Factor dB	Measure ment dBuV/m	Limit dBuV/m	Margin dB	Detector	Comment
1	2390.0000	40.14	31.74	71.88	74.00	-2.12	Peak	
2	2390.0000	20.23	31.74	51.97	54.00	-2.03	AVG	
3	2405.4750	72.47	31.72	104.19	74.00	30.19	Peak	No limit
4 *	2405.4750	64.04	31.72	95.76	54.00	41.76	AVG	No limit

REMARKS:

- (1) Measurement Value = Reading Level + Correct Factor.
- (2) Margin Level = Measurement Value - Limit Value.

Test Mode: TX N-20M Mode 2412 MHz

Horizontal

80 dBuV/m

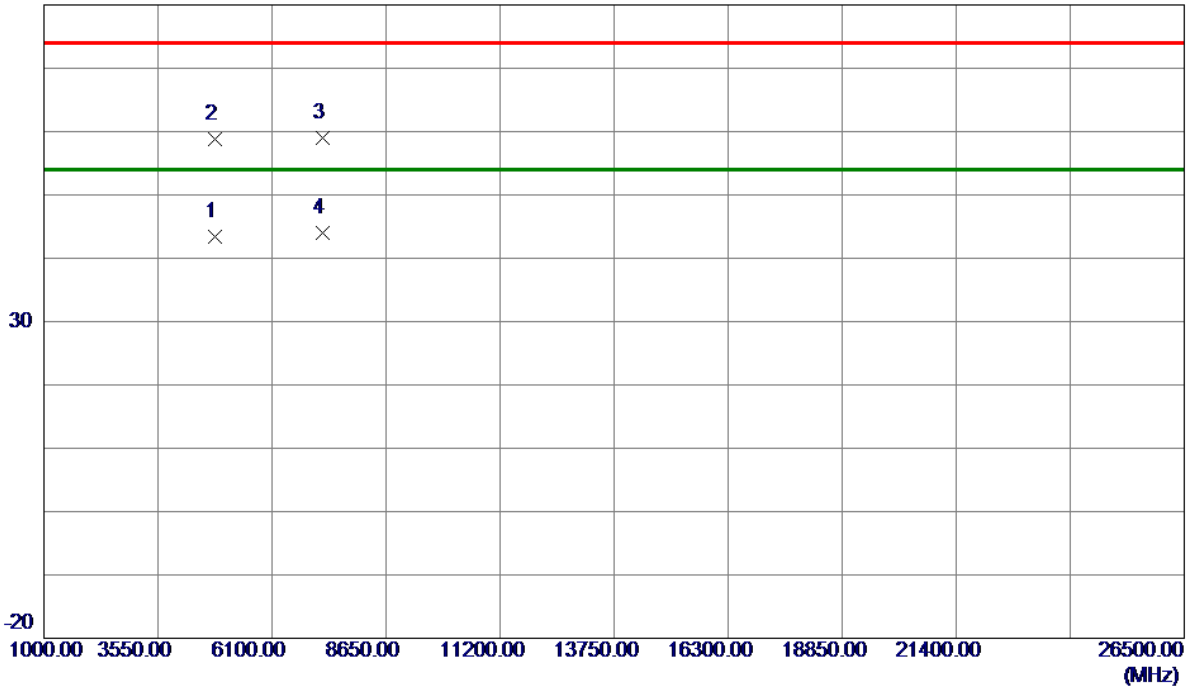

No.	Freq. MHz	Reading Level dBuV/m	Correct Factor dB	Measure ment dBuV/m	Limit dBuV/m	Margin dB	Detector	Comment
1	4821.7250	54.29	-10.91	43.38	54.00	-10.62	AVG	
2	4828.5000	69.71	-10.90	58.81	74.00	-15.19	Peak	
3	7234.4750	63.26	-4.17	59.09	74.00	-14.91	Peak	
4 *	7239.1500	48.19	-4.17	44.02	54.00	-9.98	AVG	

REMARKS:

- (1) Measurement Value = Reading Level + Correct Factor.
- (2) Margin Level = Measurement Value - Limit Value.

Test Mode: TX N-20M Mode 2437 MHz

Vertical

120 dBuV/m

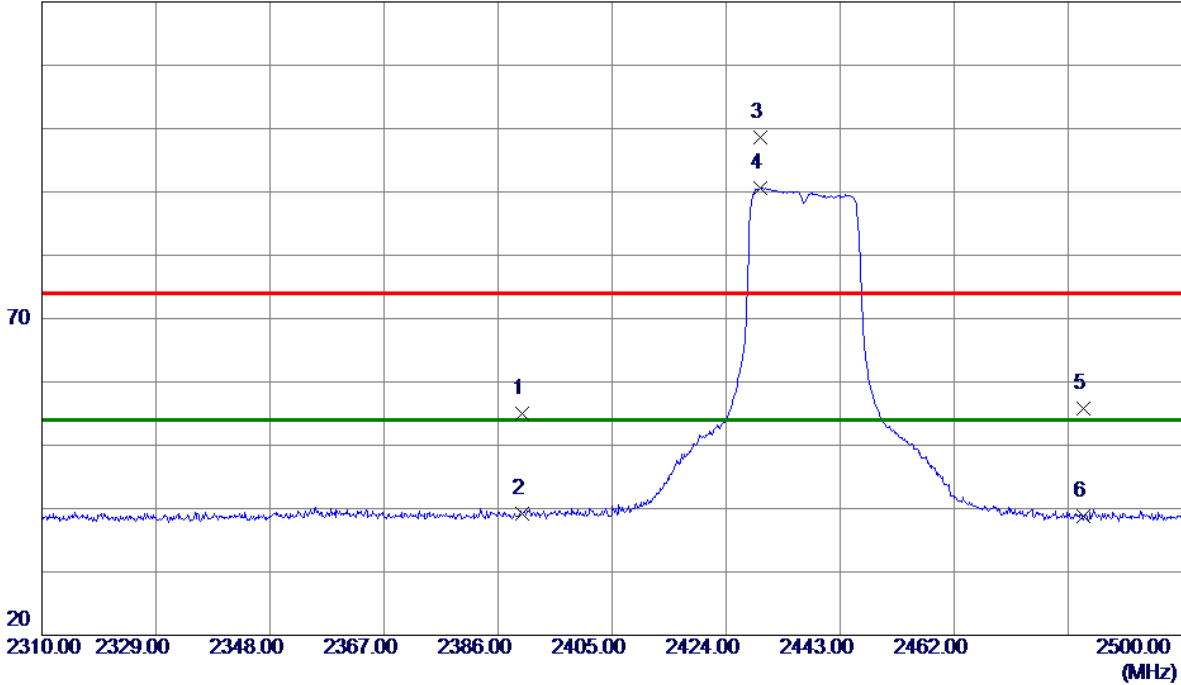

No.	Freq. MHz	Reading Level dBuV/m	Correct Factor dB	Measure ment dBuV/m	Limit dBuV/m	Margin dB	Detector	Comment
1	2390.0000	23.28	31.74	55.02	74.00	-18.98	Peak	
2	2390.0000	7.50	31.74	39.24	54.00	-14.76	AVG	
3	2429.7000	66.80	31.72	98.52	74.00	24.52	Peak	No limit
4 *	2429.7000	58.96	31.72	90.68	54.00	36.68	AVG	No limit
5	2483.5000	24.11	31.71	55.82	74.00	-18.18	Peak	
6	2483.5000	7.14	31.71	38.85	54.00	-15.15	AVG	

REMARKS:

- (1) Measurement Value = Reading Level + Correct Factor.
- (2) Margin Level = Measurement Value - Limit Value.

Test Mode: TX N-20M Mode 2437 MHz

Vertical

80 dBuV/m

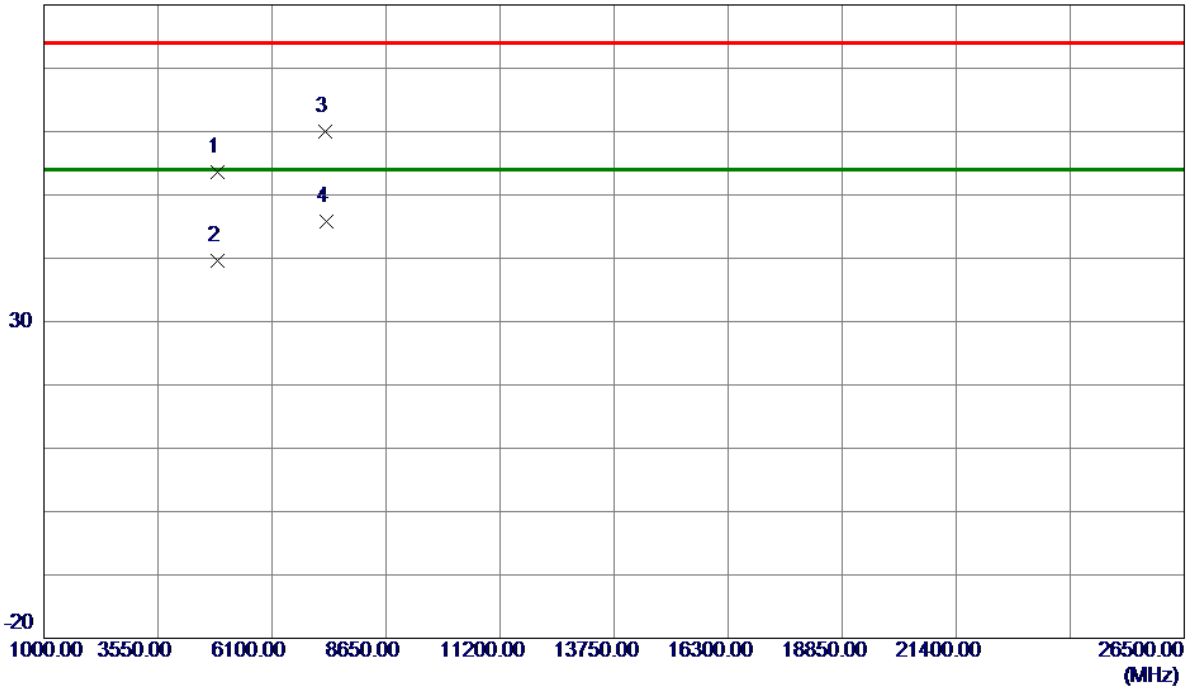

No.	Freq. MHz	Reading Level dBuV/m	Correct Factor dB	Measure ment dBuV/m	Limit dBuV/m	Margin dB	Detector	Comment
1	4871.3500	64.37	-10.80	53.57	74.00	-20.43	Peak	
2	4872.1750	50.44	-10.80	39.64	54.00	-14.36	AVG	
3	7304.0750	63.99	-4.08	59.91	74.00	-14.09	Peak	
4 *	7309.5500	49.88	-4.08	45.80	54.00	-8.20	AVG	

REMARKS:

- (1) Measurement Value = Reading Level + Correct Factor.
- (2) Margin Level = Measurement Value - Limit Value.

Test Mode: TX N-20M Mode 2437 MHz

Horizontal

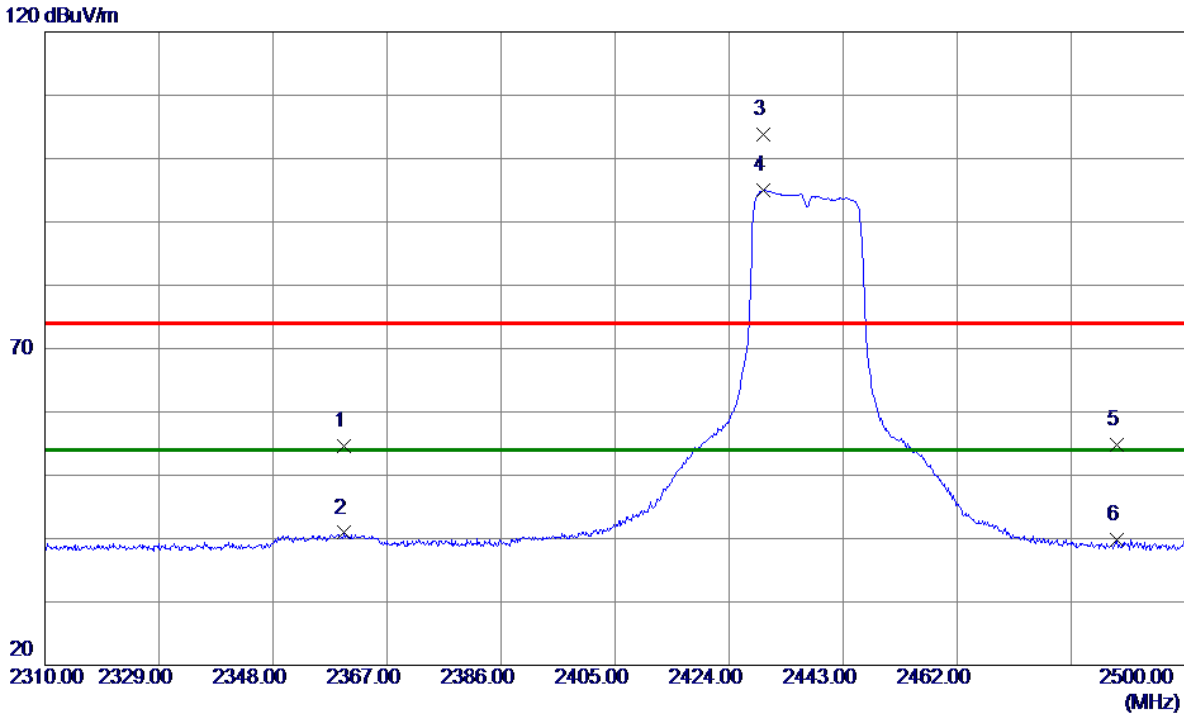

No.	Freq. MHz	Reading Level dBuV/m	Correct Factor dB	Measurement dBuV/m	Limit dBuV/m	Margin dB	Detector	Comment
1	2359.8750	22.82	31.80	54.62	74.00	-19.38	Peak	
2	2359.8750	9.10	31.80	40.90	54.00	-13.10	AVG	
3	2429.6050	71.98	31.72	103.70	74.00	29.70	Peak	No limit
4 *	2429.6050	63.21	31.72	94.93	54.00	40.93	AVG	No limit
5	2488.6000	23.17	31.71	54.88	74.00	-19.12	Peak	
6	2488.6000	8.06	31.71	39.77	54.00	-14.23	AVG	

REMARKS:

- (1) Measurement Value = Reading Level + Correct Factor.
- (2) Margin Level = Measurement Value - Limit Value.

Test Mode: TX N-20M Mode 2437 MHz

Horizontal

80 dBuV/m

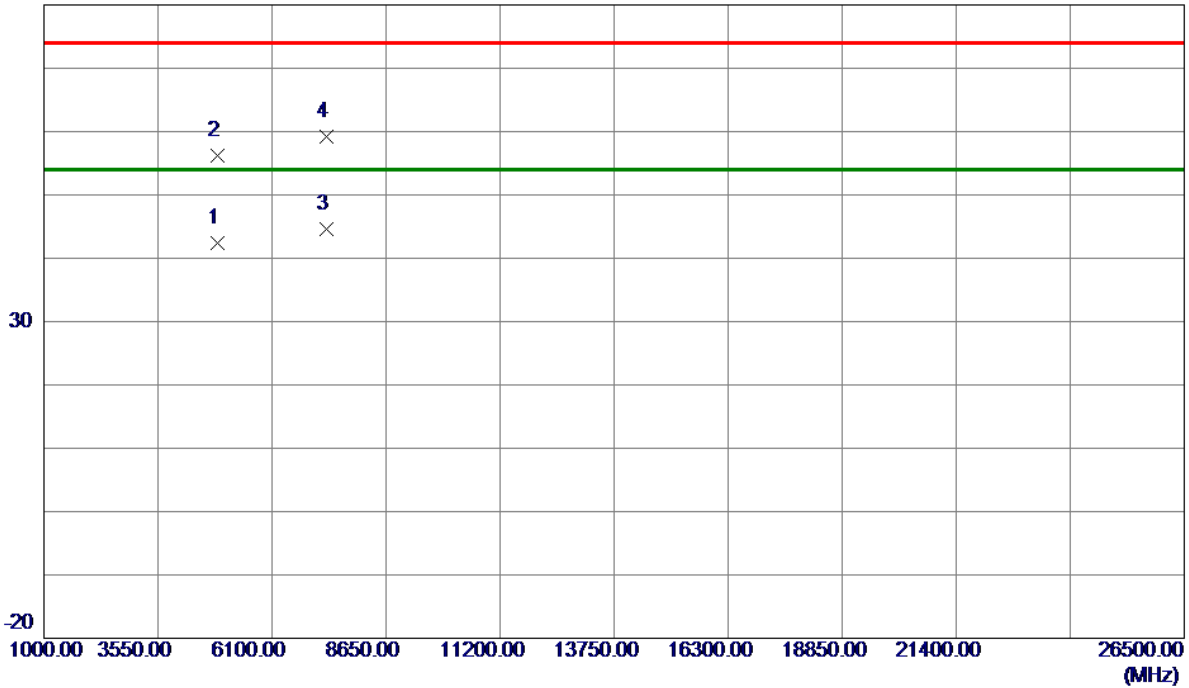

No.	Freq. MHz	Reading Level dBuV/m	Correct Factor dB	Measurement dBuV/m	Limit dBuV/m	Margin dB	Detector	Comment
1	4874.8000	53.21	-10.79	42.42	54.00	-11.58	AVG	
2	4877.2000	67.00	-10.79	56.21	74.00	-17.79	Peak	
3 *	7313.3750	48.61	-4.07	44.54	54.00	-9.46	AVG	
4	7313.6250	63.23	-4.07	59.16	74.00	-14.84	Peak	

REMARKS:

- (1) Measurement Value = Reading Level + Correct Factor.
- (2) Margin Level = Measurement Value - Limit Value.

Test Mode: TX N-20M Mode 2462 MHz

Vertical

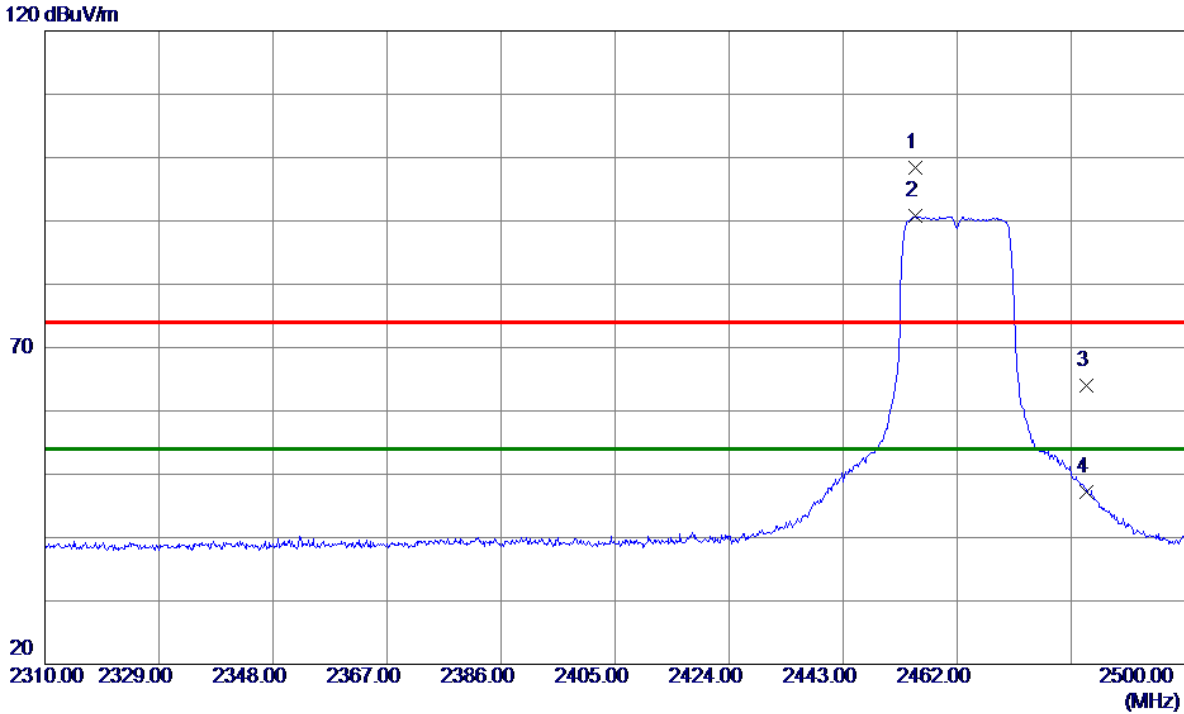

No.	Freq. MHz	Reading Level dBuV/m	Correct Factor dB	Measure ment dBuV/m	Limit dBuV/m	Margin dB	Detector	Comment
1	2454.9700	66.63	31.71	98.34	74.00	24.34	Peak	No limit
2 *	2454.9700	59.00	31.71	90.71	54.00	36.71	AVG	No limit
3	2483.5000	32.29	31.71	64.00	74.00	-10.00	Peak	
4	2483.5000	15.49	31.71	47.20	54.00	-6.80	AVG	

REMARKS:

- (1) Measurement Value = Reading Level + Correct Factor.
- (2) Margin Level = Measurement Value - Limit Value.

Test Mode: TX N-20M Mode 2462 MHz

Vertical

80 dBuV/m

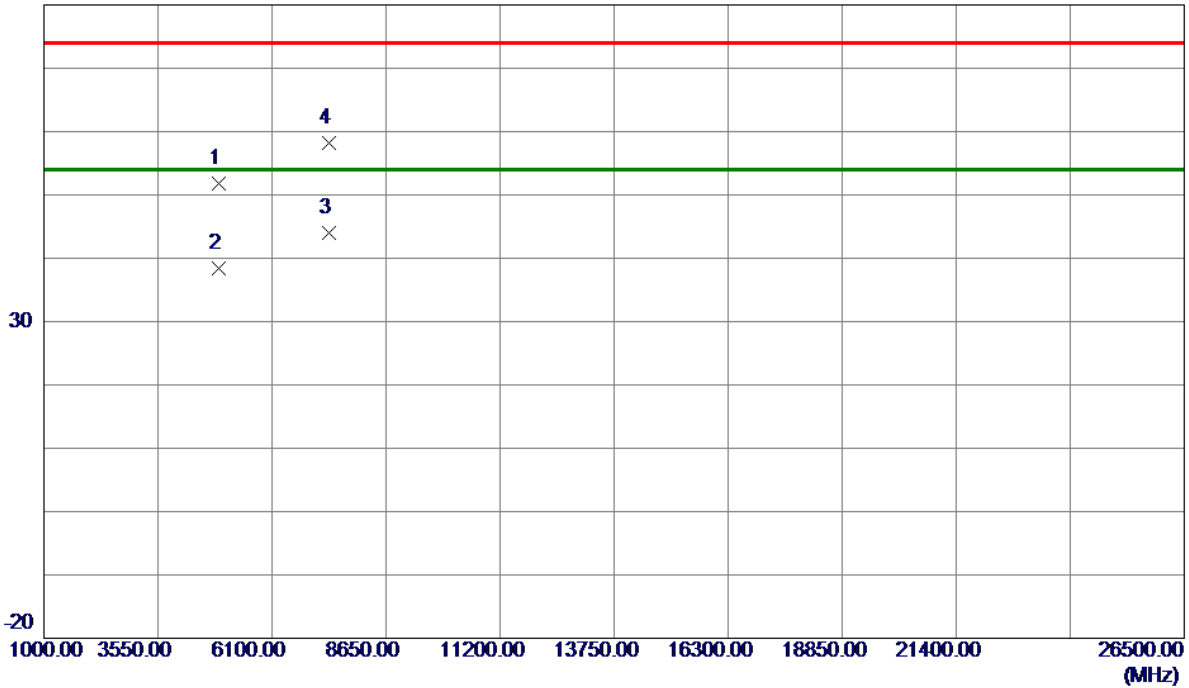

No.	Freq. MHz	Reading Level dBuV/m	Correct Factor dB	Measure ment dBuV/m	Limit dBuV/m	Margin dB	Detector	Comment
1	4923.2750	62.40	-10.63	51.77	74.00	-22.23	Peak	
2	4923.5750	48.98	-10.63	38.35	54.00	-15.65	AVG	
3 *	7383.9750	48.03	-3.98	44.05	54.00	-9.95	AVG	
4	7384.2000	62.11	-3.98	58.13	74.00	-15.87	Peak	

REMARKS:

- (1) Measurement Value = Reading Level + Correct Factor.
- (2) Margin Level = Measurement Value - Limit Value.

Test Mode: TX N-20M Mode 2462 MHz

Horizontal

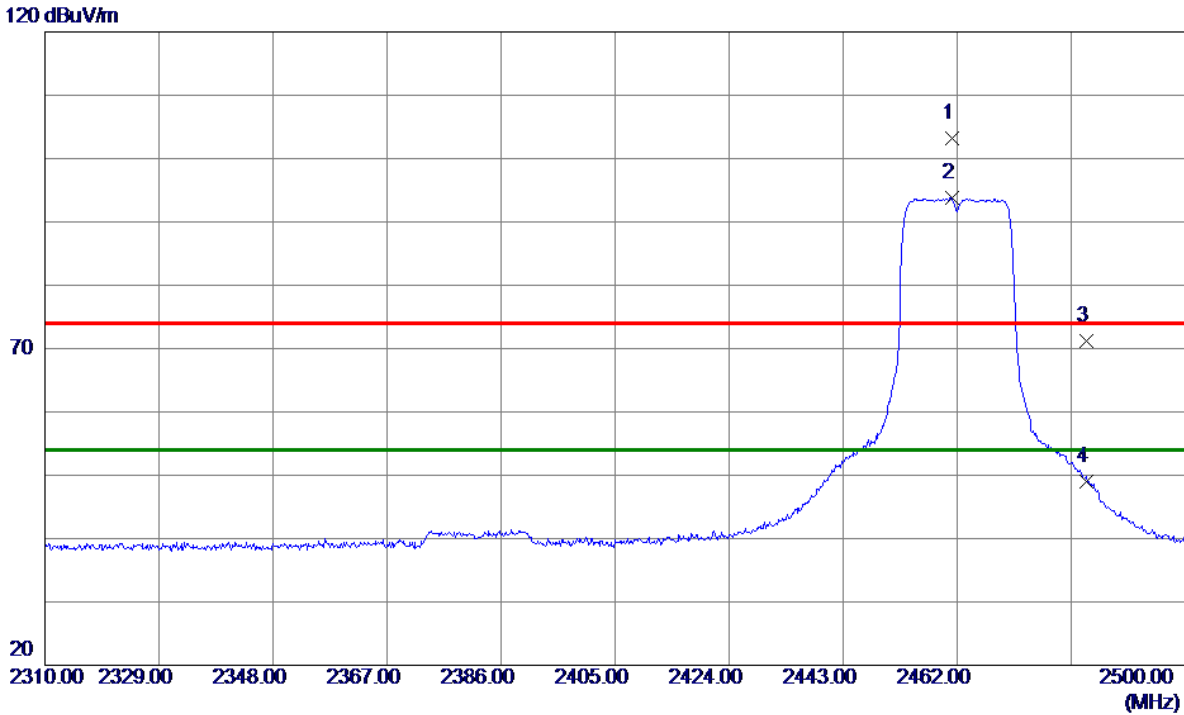

No.	Freq. MHz	Reading Level dBuV/m	Correct Factor dB	Measure ment dBuV/m	Limit dBuV/m	Margin dB	Detector	Comment
1	2461.0500	71.57	31.71	103.28	74.00	29.28	Peak	No limit
2 *	2461.0500	62.04	31.71	93.75	54.00	39.75	AVG	No limit
3	2483.5000	39.54	31.71	71.25	74.00	-2.75	Peak	
4	2483.5000	17.29	31.71	49.00	54.00	-5.00	AVG	

REMARKS:

- (1) Measurement Value = Reading Level + Correct Factor.
- (2) Margin Level = Measurement Value - Limit Value.

Test Mode: TX N-20M Mode 2462 MHz

Horizontal

80 dBuV/m

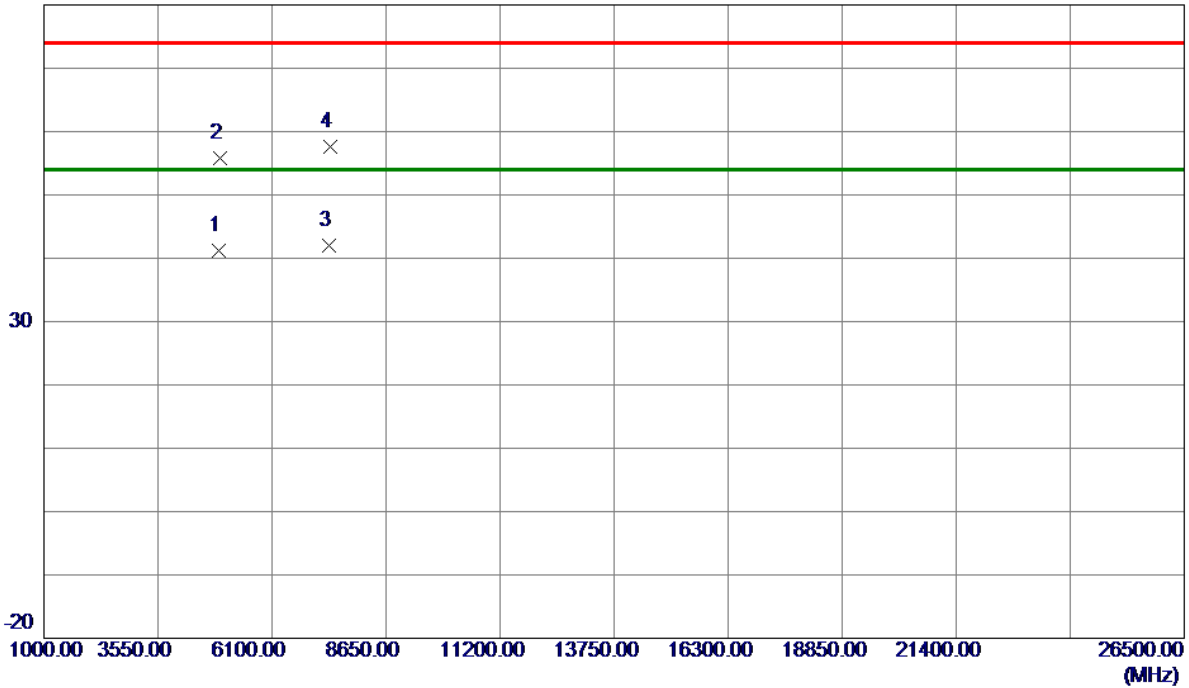

No.	Freq. MHz	Reading Level dBuV/m	Correct Factor dB	Measure ment dBuV/m	Limit dBuV/m	Margin dB	Detector	Comment
1	4923.8750	51.75	-10.63	41.12	54.00	-12.88	AVG	
2	4925.1750	66.47	-10.62	55.85	74.00	-18.15	Peak	
3 *	7385.7500	46.02	-3.98	42.04	54.00	-11.96	AVG	
4	7390.7500	61.51	-3.97	57.54	74.00	-16.46	Peak	

REMARKS:

- (1) Measurement Value = Reading Level + Correct Factor.
- (2) Margin Level = Measurement Value - Limit Value.

Test Mode: TX N-40M Mode 2422MHz

Vertical

120 dBuV/m

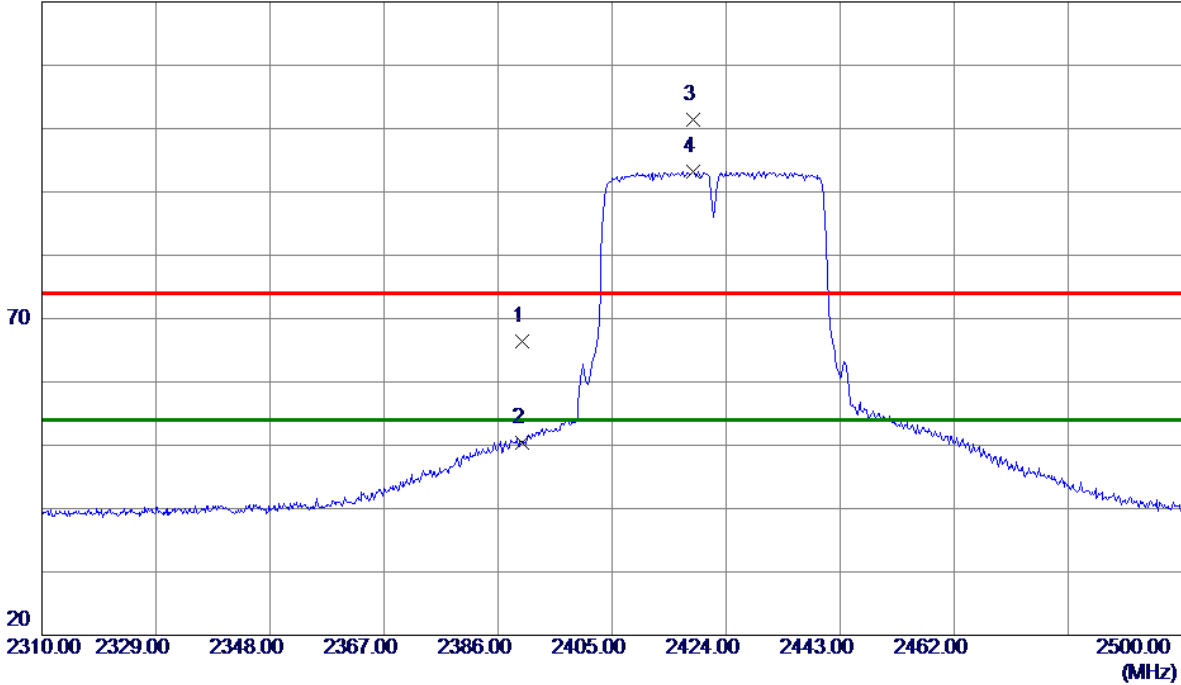

No.	Freq. MHz	Reading Level dBuV/m	Correct Factor dB	Measure ment dBuV/m	Limit dBuV/m	Margin dB	Detector	Comment
1	2390.0000	34.74	31.74	66.48	74.00	-7.52	Peak	
2	2390.0000	18.61	31.74	50.35	54.00	-3.65	AVG	
3	2418.4900	69.64	31.72	101.36	74.00	27.36	Peak	No limit
4 *	2418.4900	61.55	31.72	93.27	54.00	39.27	AVG	No limit

REMARKS:

- (1) Measurement Value = Reading Level + Correct Factor.
- (2) Margin Level = Measurement Value - Limit Value.

Test Mode: TX N-40M Mode 2422MHz

Vertical

80 dBuV/m

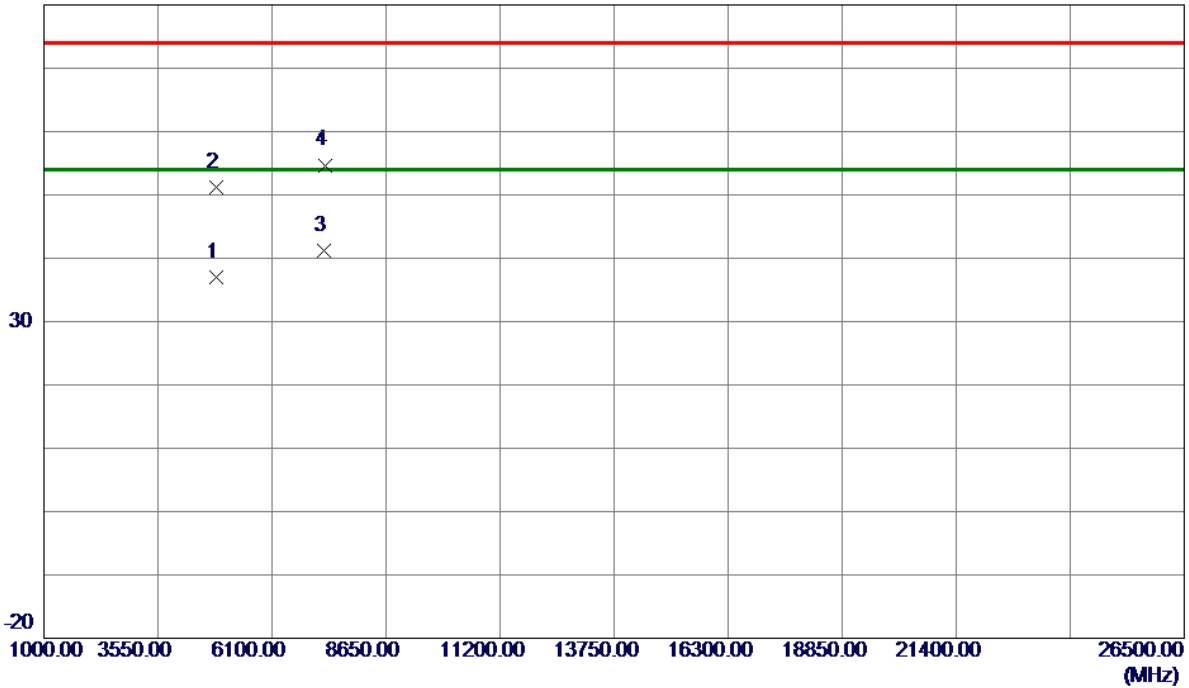

No.	Freq. MHz	Reading Level dBuV/m	Correct Factor dB	Measure ment dBuV/m	Limit dBuV/m	Margin dB	Detector	Comment
1	4843.0000	47.77	-10.86	36.91	54.00	-17.09	AVG	
2	4843.8800	62.02	-10.86	51.16	74.00	-22.84	Peak	
3 *	7269.4000	45.31	-4.13	41.18	54.00	-12.82	AVG	
4	7298.2400	58.79	-4.09	54.70	74.00	-19.30	Peak	

REMARKS:

- (1) Measurement Value = Reading Level + Correct Factor.
- (2) Margin Level = Measurement Value - Limit Value.

Test Mode: TX N-40M Mode 2422MHz

Horizontal

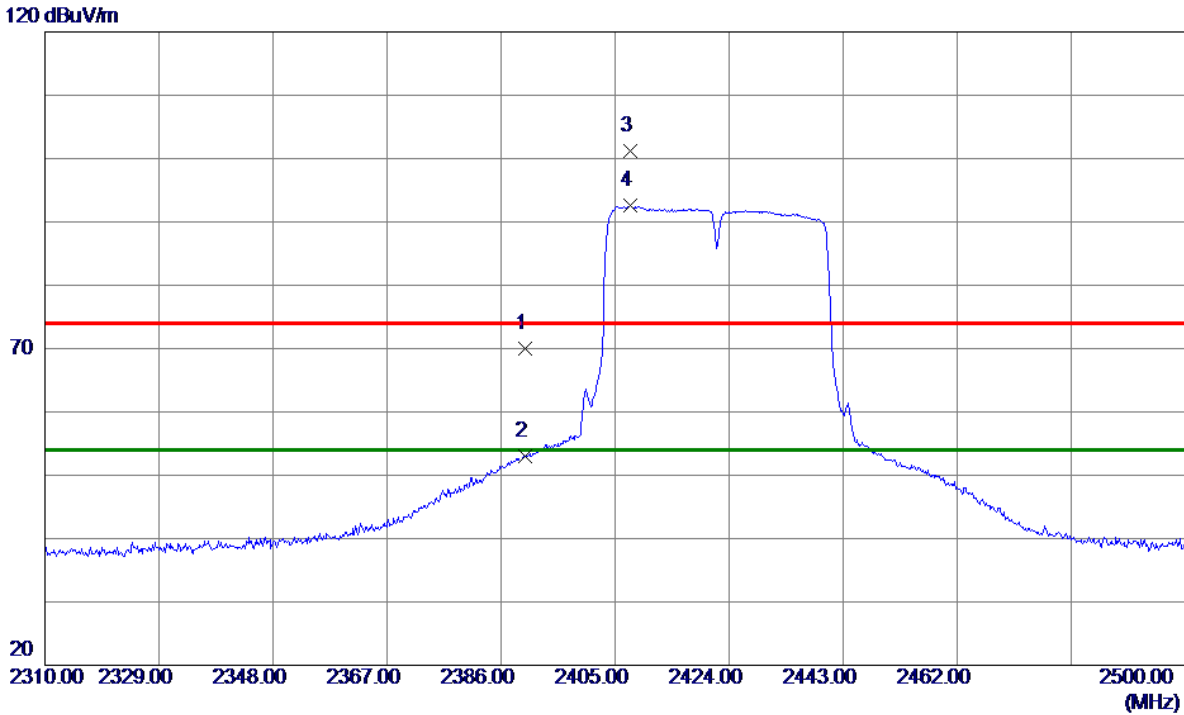

No.	Freq. MHz	Reading Level dBuV/m	Correct Factor dB	Measure ment dBuV/m	Limit dBuV/m	Margin dB	Detector	Comment
1	2390.0000	38.34	31.74	70.08	74.00	-3.92	Peak	
2	2390.0000	21.22	31.74	52.96	54.00	-1.04	AVG	
3	2407.5650	69.51	31.72	101.23	74.00	27.23	Peak	No limit
4 *	2407.5650	60.87	31.72	92.59	54.00	38.59	AVG	No limit

REMARKS:

- (1) Measurement Value = Reading Level + Correct Factor.
- (2) Margin Level = Measurement Value - Limit Value.

Test Mode: TX N-40M Mode 2422MHz

Horizontal

80 dBuV/m

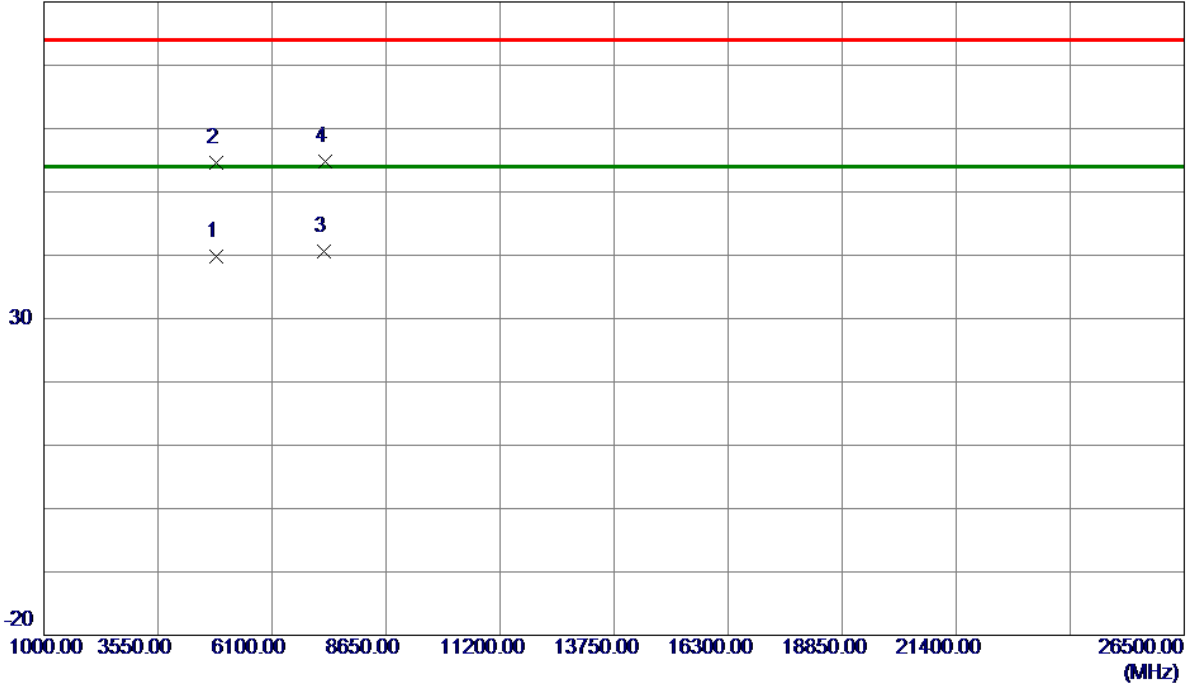

No.	Freq. MHz	Reading Level dBuV/m	Correct Factor dB	Measure ment dBuV/m	Limit dBuV/m	Margin dB	Detector	Comment
1	4843.6000	50.68	-10.86	39.82	54.00	-14.18	AVG	
2	4846.9200	65.51	-10.85	54.66	74.00	-19.34	Peak	
3 *	7275.0800	44.70	-4.12	40.58	54.00	-13.42	AVG	
4	7286.5600	58.98	-4.11	54.87	74.00	-19.13	Peak	

REMARKS:

- (1) Measurement Value = Reading Level + Correct Factor.
- (2) Margin Level = Measurement Value - Limit Value.

Test Mode: TX N-40M Mode 2437 MHz

Vertical

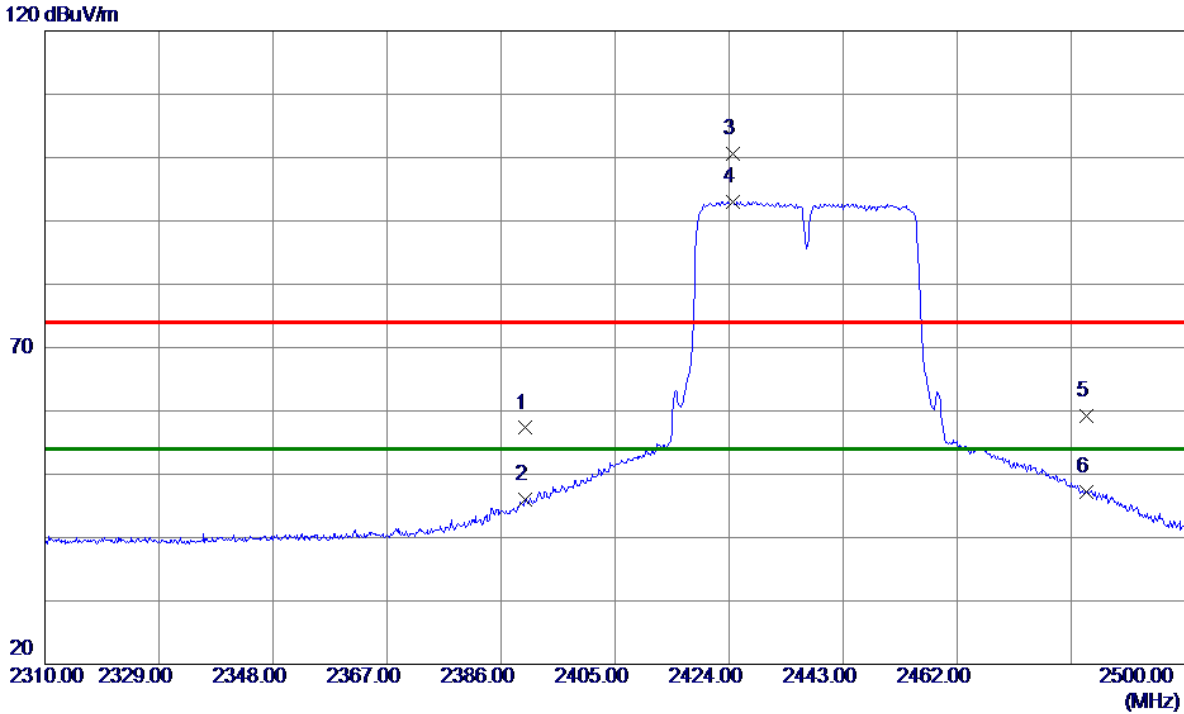

No.	Freq. MHz	Reading Level dBuV/m	Correct Factor dB	Measure ment dBuV/m	Limit dBuV/m	Margin dB	Detector	Comment
1	2390.0000	25.56	31.74	57.30	74.00	-16.70	Peak	
2	2390.0000	14.32	31.74	46.06	54.00	-7.94	AVG	
3	2424.6650	68.97	31.72	100.69	74.00	26.69	Peak	No limit
4 *	2424.6650	61.37	31.72	93.09	54.00	39.09	AVG	No limit
5	2483.5000	27.49	31.71	59.20	74.00	-14.80	Peak	
6	2483.5000	15.54	31.71	47.25	54.00	-6.75	AVG	

REMARKS:

- (1) Measurement Value = Reading Level + Correct Factor.
- (2) Margin Level = Measurement Value - Limit Value.

Test Mode: TX N-40M Mode 2437 MHz

Vertical

80 dBuV/m

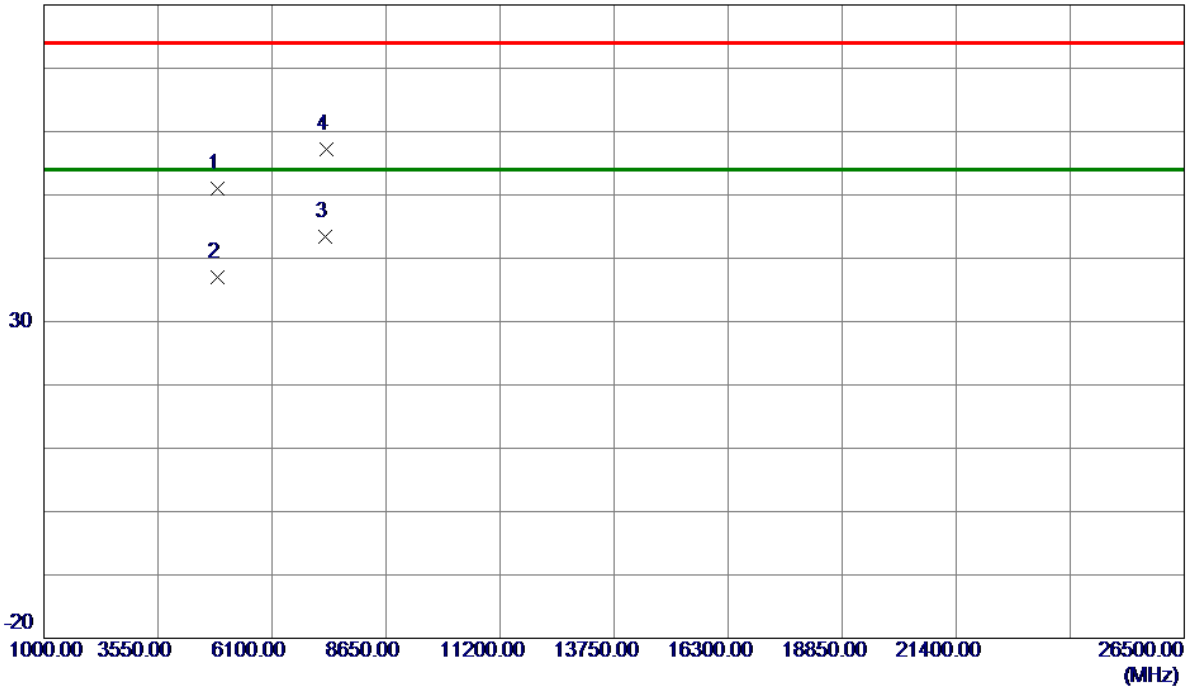

No.	Freq. MHz	Reading Level dBuV/m	Correct Factor dB	Measure ment dBuV/m	Limit dBuV/m	Margin dB	Detector	Comment
1	4873.9200	61.83	-10.79	51.04	74.00	-22.96	Peak	
2	4873.9200	47.72	-10.79	36.93	54.00	-17.07	AVG	
3 *	7301.5600	47.46	-4.09	43.37	54.00	-10.63	AVG	
4	7317.4400	61.24	-4.07	57.17	74.00	-16.83	Peak	

REMARKS:

- (1) Measurement Value = Reading Level + Correct Factor.
- (2) Margin Level = Measurement Value - Limit Value.

Test Mode: TX N-40M Mode 2437 MHz

Horizontal

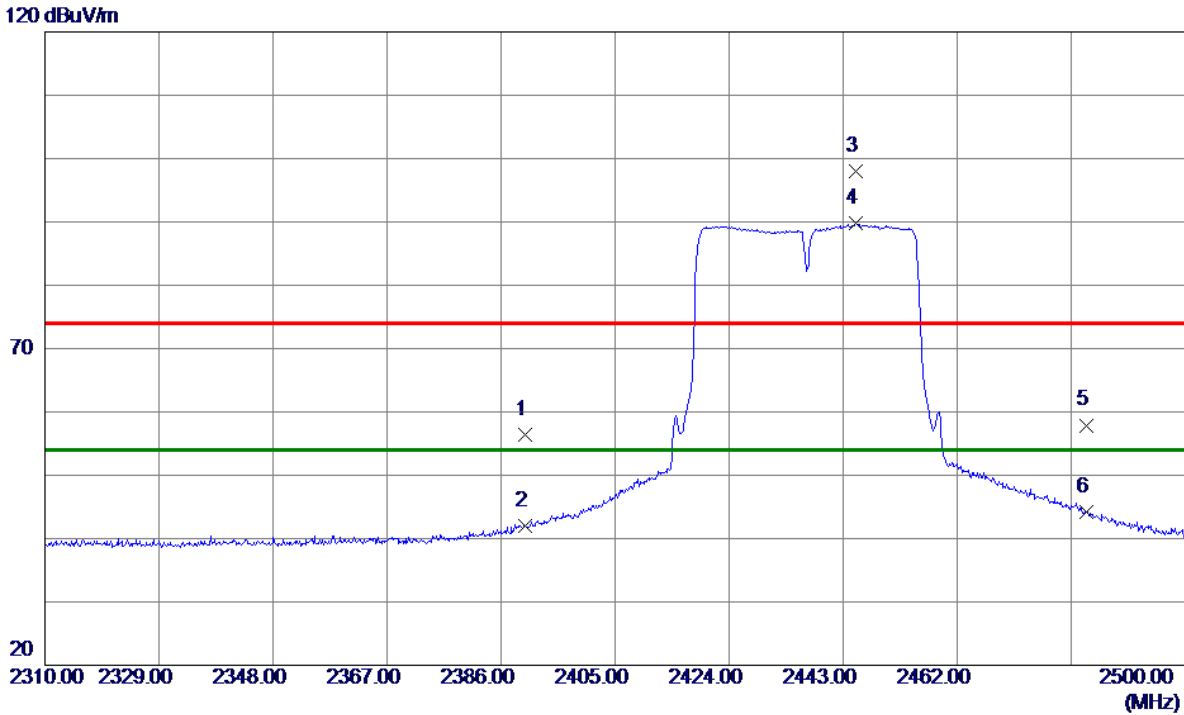

No.	Freq. MHz	Reading Level dBuV/m	Correct Factor dB	Measure ment dBuV/m	Limit dBuV/m	Margin dB	Detector	Comment
1	2390.0000	24.65	31.74	56.39	74.00	-17.61	Peak	
2	2390.0000	10.35	31.74	42.09	54.00	-11.91	AVG	
3	2445.0900	66.29	31.72	98.01	74.00	24.01	Peak	No limit
4 *	2445.0900	58.02	31.72	89.74	54.00	35.74	AVG	No limit
5	2483.5000	26.19	31.71	57.90	74.00	-16.10	Peak	
6	2483.5000	12.42	31.71	44.13	54.00	-9.87	AVG	

REMARKS:

- (1) Measurement Value = Reading Level + Correct Factor.
- (2) Margin Level = Measurement Value - Limit Value.