

# Snap 12S

ORIGINALITY DESIGN SMART - AND BEAUTIFUL

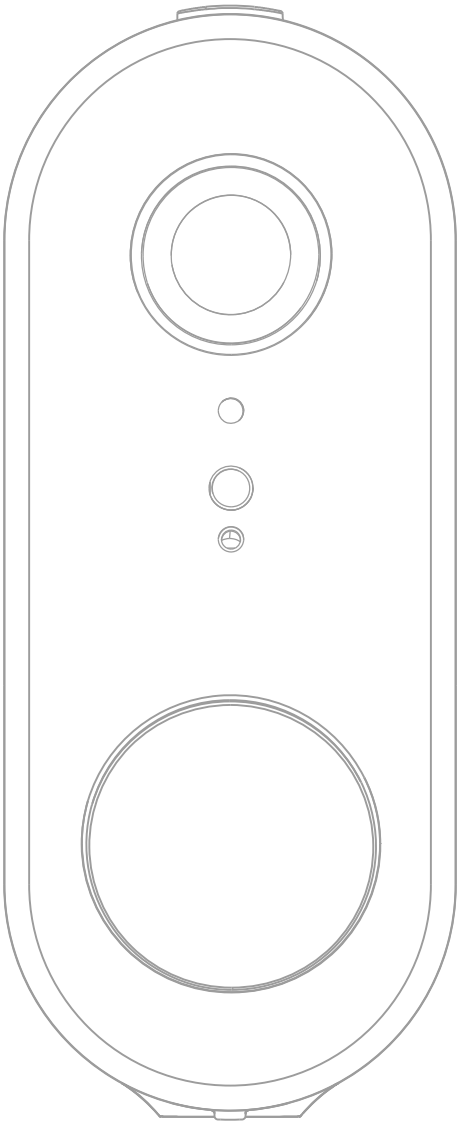

# QUICK GUIDE



# What's in the box

Please consult this checklist for all parts.

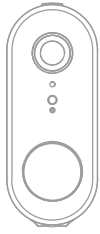

Snap 12S

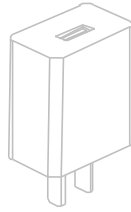

Power adapter

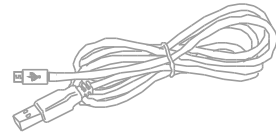

USB cable



Screws

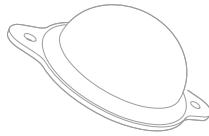

Bracket (A)

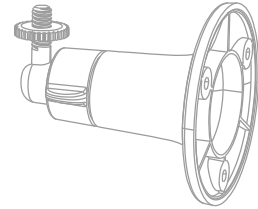

Bracket (B)

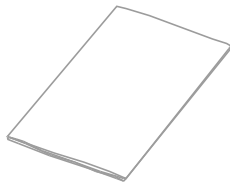

User manual

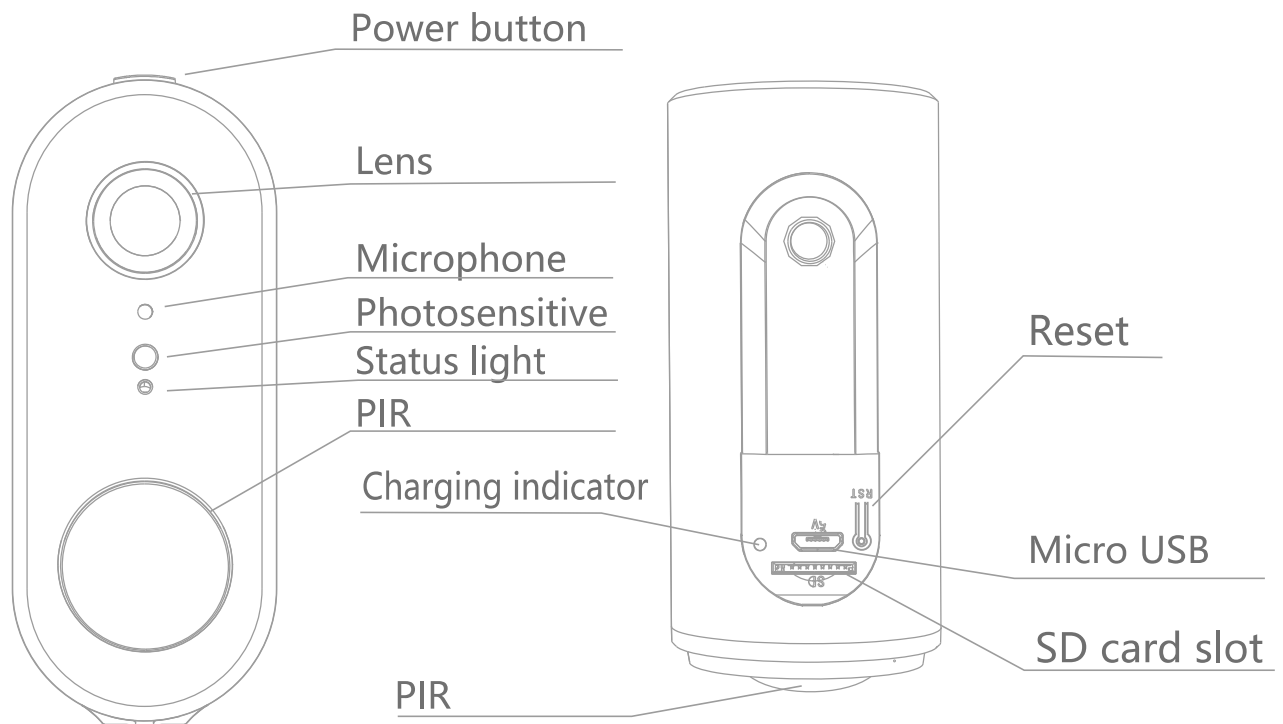

Power port	DC 5V±10%
Power on/off	Press the button for 3 seconds to turn on/off the camera
Status light	<ul style="list-style-type: none"> <li>• Solid red light on: the camera is turning on or malfunctional</li> <li>• Blinking red light: awaiting WiFi connection (slowly blinking) connecting the WiFi (quickly blinking)</li> <li>• Blinking blue light: currently connecting</li> <li>• Solid blue light on: the camera runs correctly</li> </ul>
SD card slot	Support local SD card storage (Max.128G)
Reset	Press and hold on for 5 seconds to reset the camera
Charging indicator	<ul style="list-style-type: none"> <li>• Solid red indicator on: battery is charging</li> <li>• Solid blue indicator on: charging completed</li> </ul>
Battery capacity	9000mAh (two 21700 lithium-ion batteries)

## Mode 1 Bracket (A) Installation

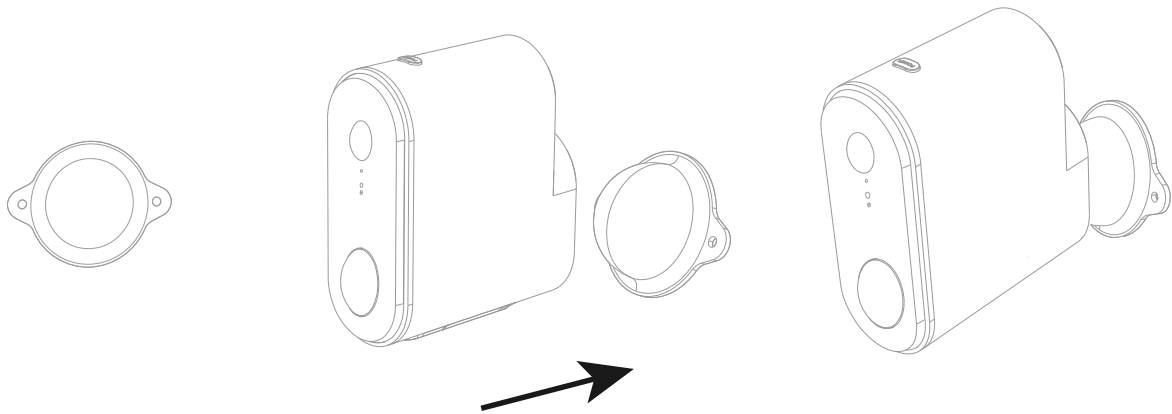

1. Fix the bracket on the wall with screws
2. Bring the camera closer to the bracket

## Mode 2 Bracket (B) Installation

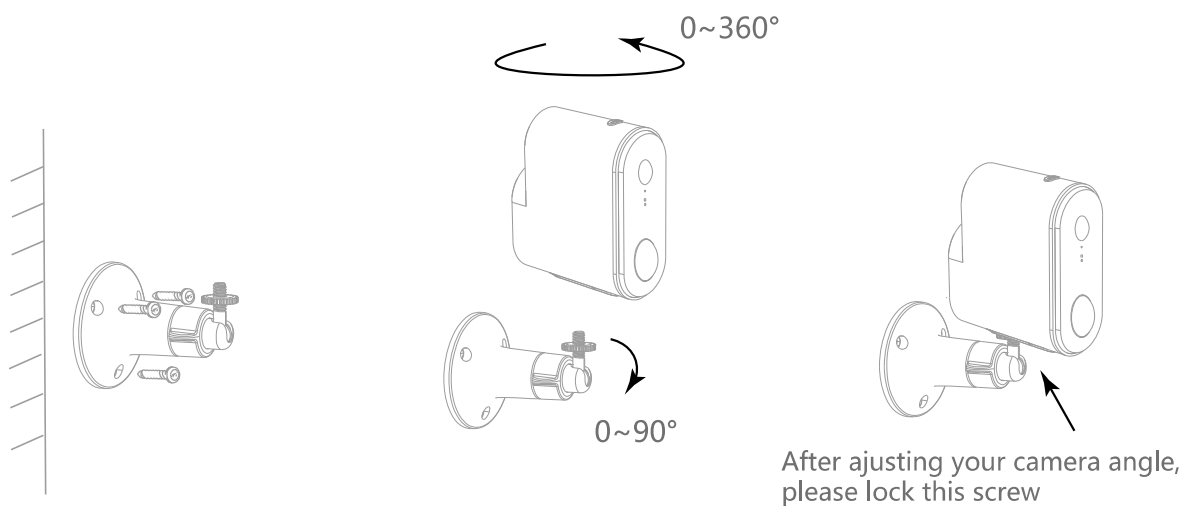

1. Fix the bracket on the wall
2. Install the camera in the bracket and lock it with the screw

## Download

SmartLife or Tuya Smart is available for both iOS and Android OS. Search the name 'SmartLife', 'Tuya Smart' in App Store or Google Play, or scan the QR-Code to download the App.

## Support



ipad



iOS



Android



Download App(iOS&android)

## Set up router

The router supports the 2.4GHz WiFi (doesn't support the 5GHz), and is connected to the WiFi network. Please set the parameters of the router before connecting the WiFi network, and record the SSID and password of your WiFi.



Please keep network available

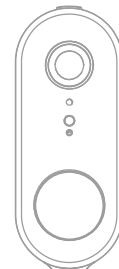

2.4GHz



5GHz



Registration process

Step 1 Open the Smart Life App, click "Sign Up", read the "User Agreement Privacy Policy" and click "Agree" .

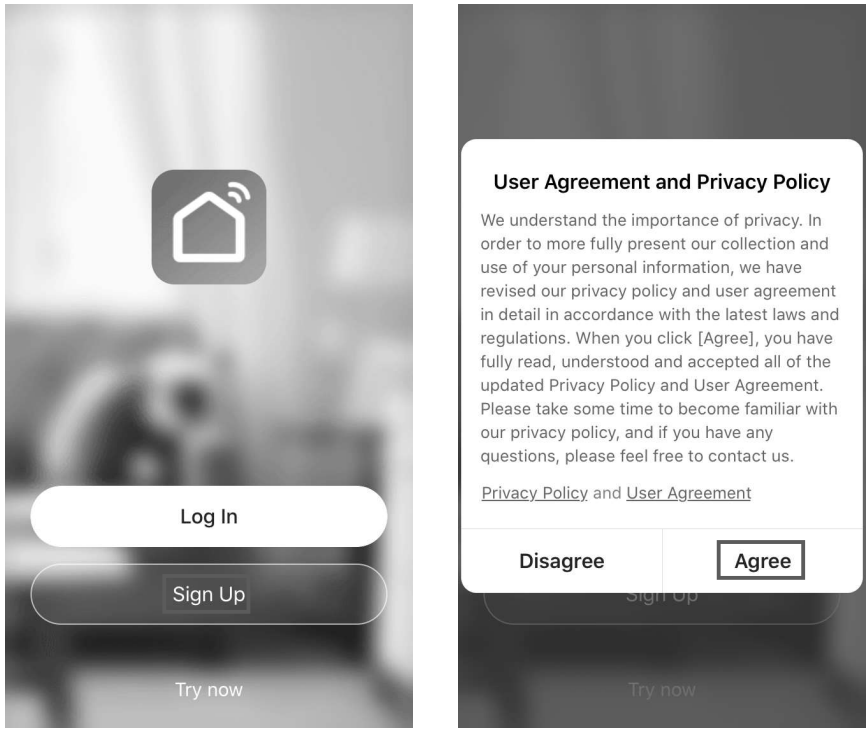

Step 2 Input a legal and valid Mobile number or Email address and click "Get Verification Code". Input the verification code to log in.

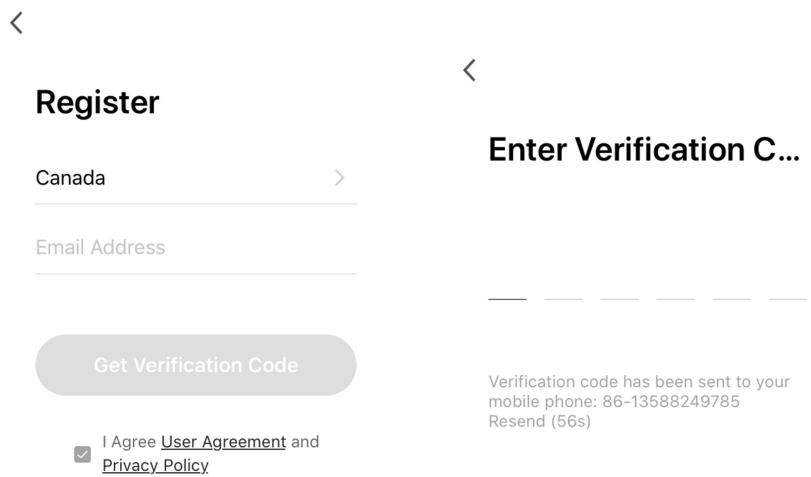

- 1 Open the Smart Life App, click "My" >> "Home Management" >> "Create a home", and you can customize the home name and related settings .

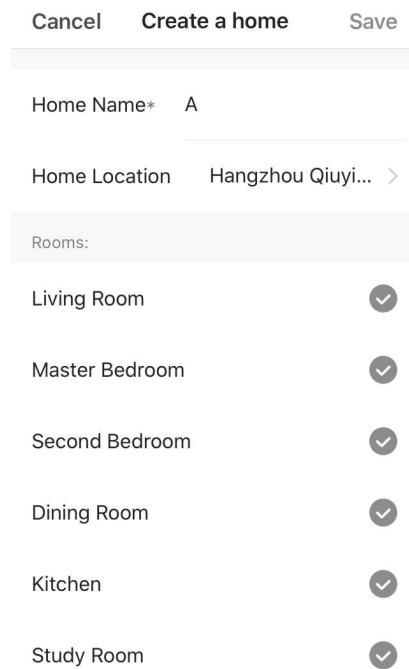
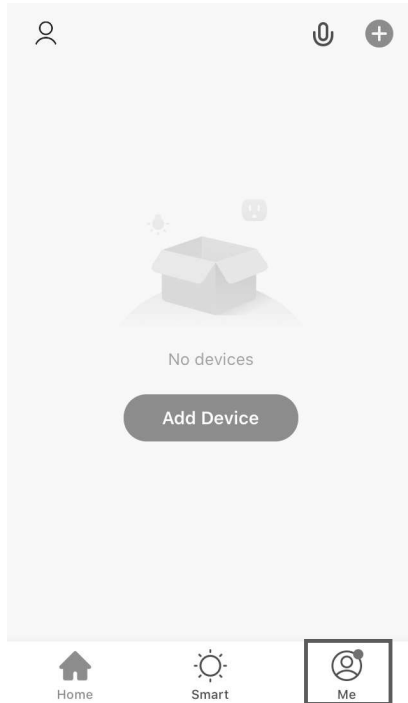

- 2 Click "Add Device" or "+", and then select "Security & Sensor" >> "Smart Camera" to add camera.

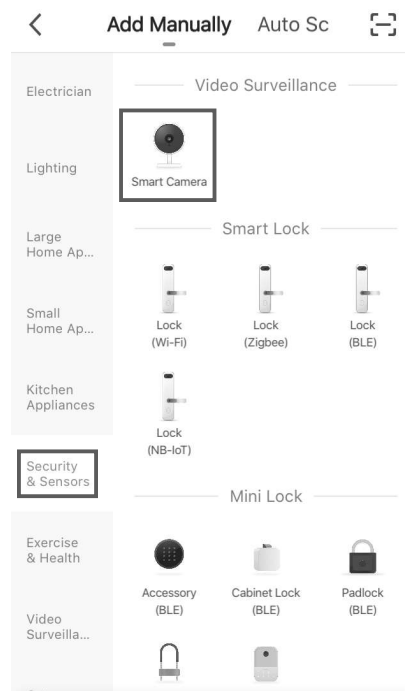
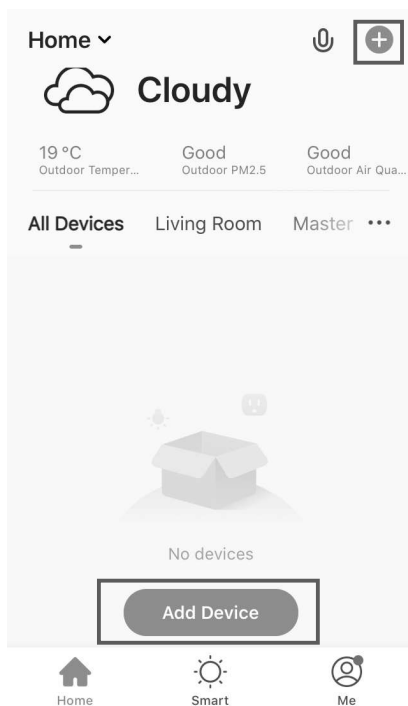

- 3 Power on and reset camera until the status indicator is flashing quickly or a prompt tone is heard, and then click "Next". Then input your WiFi's passwords and click "Next". Click "↔" to change network.

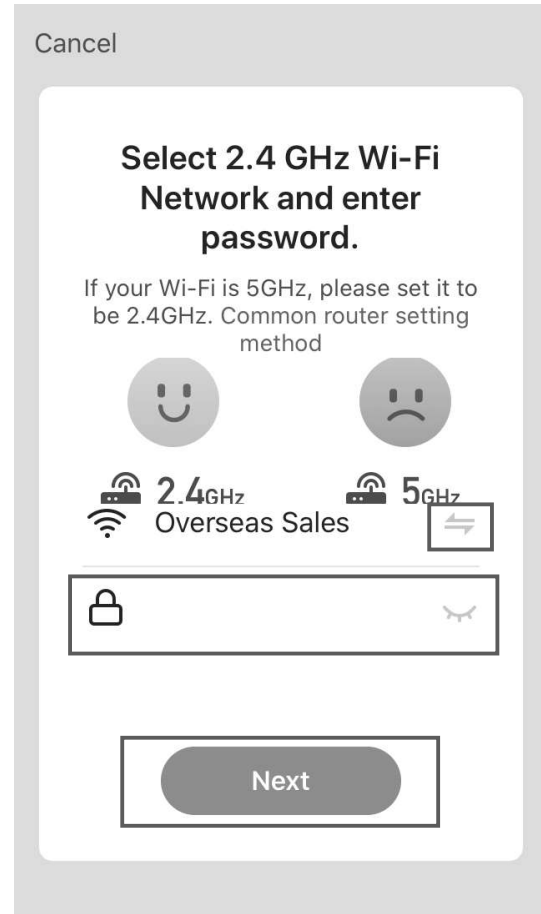
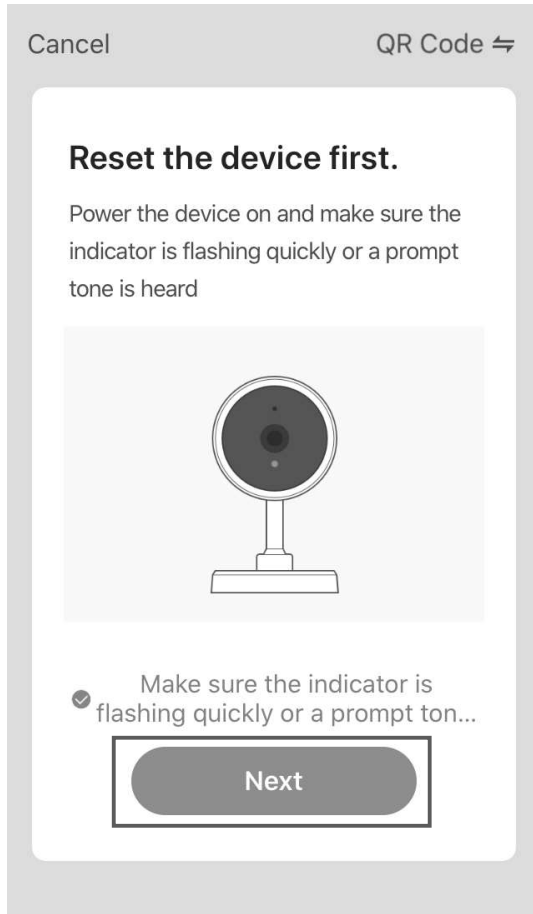

Note:

- 1) Camera only supports 2.4GHz WiFi network.
- 2) The number of bits in the ssid and passwords of the router should not exceed 24 digits.



- 4 In this interface, you should scan the QR code in your phone with the camera, when the camera comes out "dong dong dong". And you can complete the configuration about 30s.

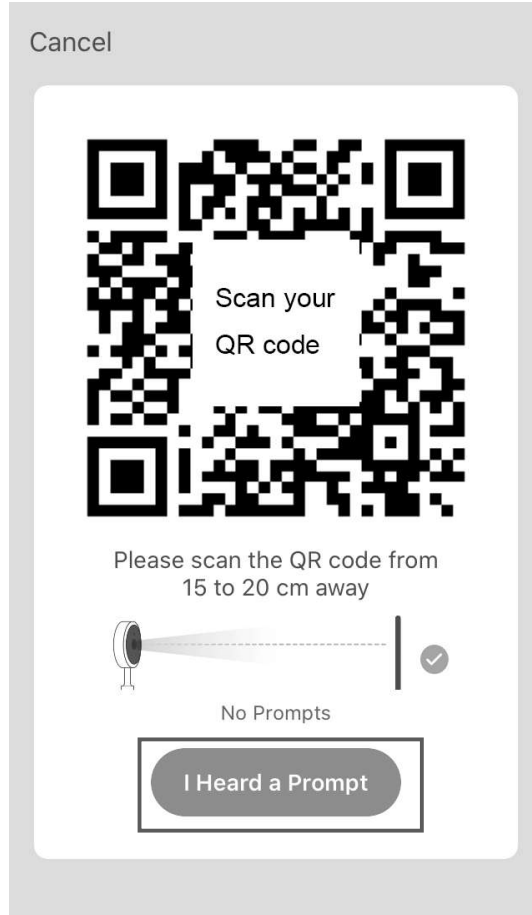

- 5 When connecting, you should make sure your router, mobile, and camera are as close as possible. When camera added successfully, click "✎" you could also DIY the camera's name.

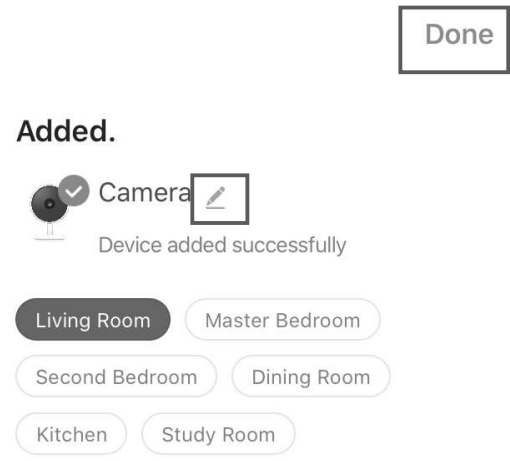
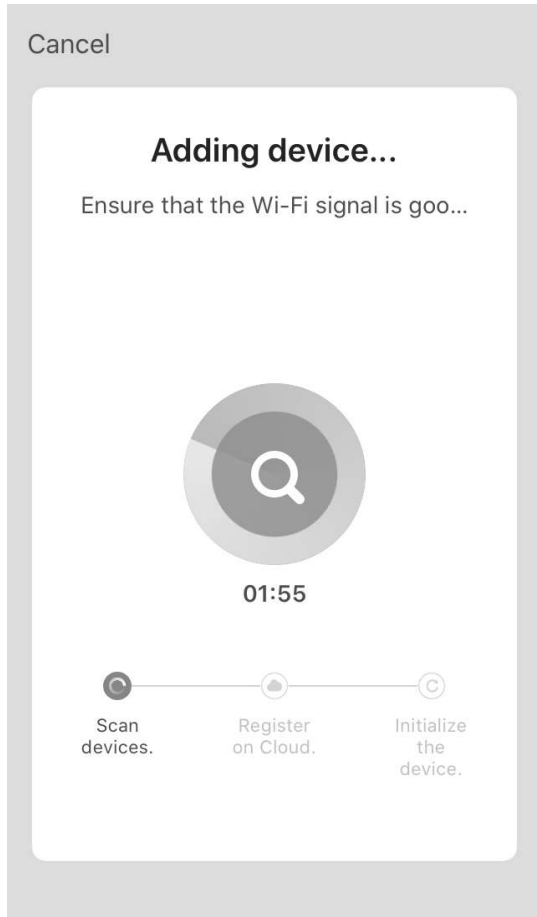

In "Smart Camera" interface,click "[edit icon]",you can set the camera common functions.

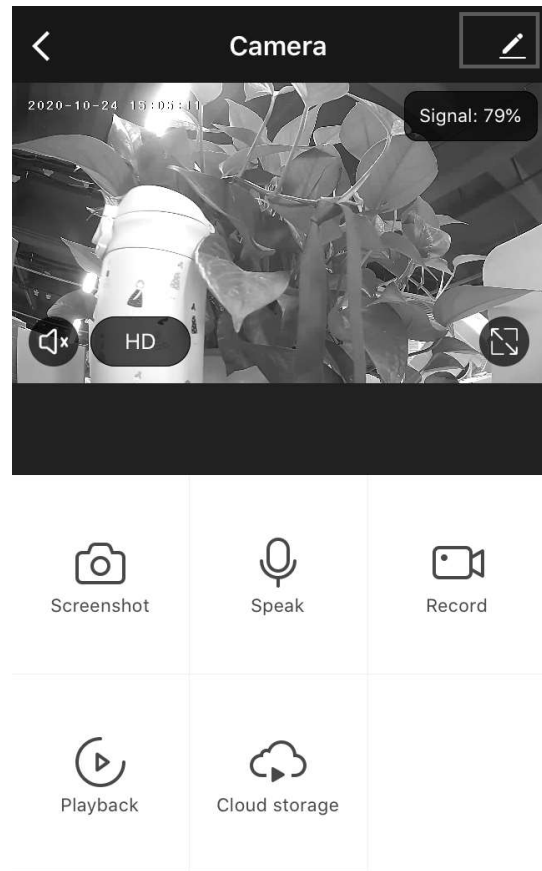
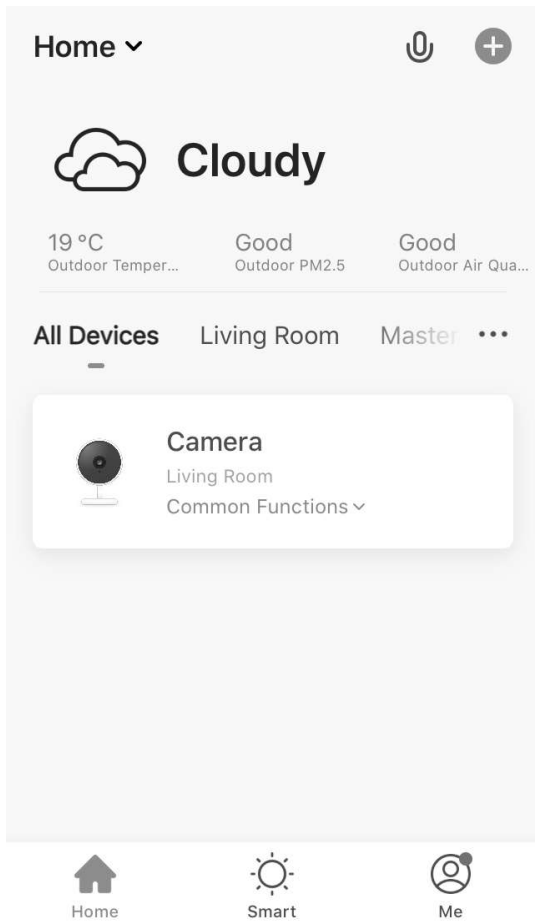

Q: The device cannot be previewed properly?

A: Check whether the network is normal, you can place the camera close to the router, and if not, it is recommended to reset the device and add it again.

Q: Why is it still in the list of devices after resetting?

A: The reset device only resets the network configuration of the camera, but cannot change the configuration on the App, remove the camera, and must be deleted by the App.

Q: How to cut the camera network to another router?

A: First remove and reset the device on the App and then configure the device again by the App.

Q: Why doesn't the device identify the SD card?

A: It is recommended to plug in SD card after power cut. Confirm whether the SD card is normally available and the format is FAT32. And the TF card can't be identified when the internet environment is not good.

Q: Why I can't get the notifications with my cell phone App?

A: Please confirm that the App has been running on the phone, and the relevant reminder function has been opened; Message notification and authority confirmation in the mobile phone system have been opened.

### Remote wake-up

The camera will be in a sleep mode to save power; you can have a preview in App.

### Full-duplex audio

You can see and hear the visitor in your App from the camera.

### PIR

When the camera detects someone stopping by, it sends an alarm message to your cell phone.

### Low battery alarm

When the battery power is lower than your set, the App will send a notification to your mobile phone.

### Record

Using SD card or opening the Cloud-Storage Service, to keep recording for every moment.

### Day & Night

Powerful night vision means no interruptions, even in complete darkness.



Daytime



Night

## FCC Statement

This equipment has been tested and found to comply with the limits for a Class B digital device, pursuant to part 15 of the FCC Rules. These limits are designed to provide reasonable protection against harmful interference in a residential installation. This equipment generates, uses and can radiate radio frequency energy and, if not installed and used in accordance with the instructions, may cause harmful interference to radio communications. However, there is no guarantee that interference will not occur in a particular installation. If this equipment does cause harmful interference to radio or television reception, which can be determined by turning the equipment off and on, the user is encouraged to try to correct the interference by one or more of the following measures:

- Reorient or relocate the receiving antenna.
- Increase the separation between the equipment and receiver.
- Connect the equipment into an outlet on a circuit different from that to which the receiver is connected.
- Consult the dealer or an experienced radio/TV technician for help.

## FCC Radiation Exposure Statement

This device complies with FCC radiation exposure limits set forth for an uncontrolled environment and it also complies with Part 15 of the FCC RF Rules. This equipment must be installed and operated in accordance with provided instructions and the antenna(s) used for this transmitter must be installed to provide a separation distance of at least 20 cm from all persons and must not be co-located or operating in conjunction with any other antenna or transmitter. End-users and installers must be provide with antenna installation instructions and consider removing the no-collocation statement.

This device complies with Part 15 of the FCC Rules. Operation is subject to the following two conditions: (1) this device may not cause harmful interference, and (2) this device must accept any interference received, including interference that may cause undesired operation.

## Caution!

Any changes or modifications not expressly approved by the party responsible for compliance could void the user's authority to operate the equipment.