



Shenzhen Global Test Service Co.,Ltd.

No.7-101 and 8A-104, Building 7 and 8, DCC Cultural and Creative Garden, No.98, Pingxin North Road, Shangmugu Community, Pinghu Street, Longgang District, Shenzhen, Guangdong

FCC PART 15 SUBPART C TEST REPORT

FCC PART 15.247

| | |
|--|--|
| Report Reference No.: | GTS20211227004-1-7 |
| FCC ID: | 2AG7C-SNAP12T |
| Compiled by (position+printed name+signature)...: | File administrators Peter Xiao <i>Peter Xiao</i> |
| Supervised by (position+printed name+signature)...: | Test Engineer Oliver Ou <i>Oliver Ou</i> |
| Approved by (position+printed name+signature)...: | Manager Simon Hu <i>Simon Hu</i> |
| Date of issue.....: | Jan.12, 2022 |
| Representative Laboratory Name .: | Shenzhen Global Test Service Co.,Ltd. |
| Address | No.7-101 and 8A-104, Building 7 and 8, DCC Cultural and Creative Garden, No.98, Pingxin North Road, Shangmugu Community, Pinghu Street, Longgang District, Shenzhen, Guangdong,China |
| Applicant's name | Hangzhou Meari Technology Co., Ltd. |
| Address | Room 604-605, Building 1, No.768 Jianghong Road, Changhe street, Binjiang District, Hangzhou, zhejiang, China |
| Test specification | |
| Standard | FCC Part 15.247: Operation within the bands 902-928 MHz, 2400-2483.5 MHz and 5725-5850 MHz ANSI C63.10-2013 |
| TRF Originator | Shenzhen Global Test Service Co.,Ltd. |
| Master TRF | Dated 2014-12 |
| Shenzhen Global Test Service Co.,Ltd. All rights reserved. | |
| This publication may be reproduced in whole or in part for non-commercial purposes as long as the Shenzhen Global Test Service Co.,Ltd. is acknowledged as copyright owner and source of the material. Shenzhen Global Test Service Co.,Ltd. takes no responsibility for and will not assume liability for damages resulting from the reader's interpretation of the reproduced material due to its placement and context. | |
| Test item description | BATTERY CAMERA |
| Trade Mark | N/A |
| Manufacturer | Hangzhou Meari Technology Co., Ltd. |
| Model/Type reference.....: | Snap 12S |
| Listed Models | Snap 12T,Snap 12Q |
| Operation Frequency.....: | From 2412MHz to 2462MHz |
| Hardware Version | PCB-SNAP12S-T1MB-GC1-REV1_0 |
| Software Version | N/A |
| Rating | DC 3.7V by battery Recharged by DC 5.0V/1.0A |
| Result.....: | PASS |



TEST REPORT

| | |
|--|--|
| Test Report No. : GTS20211227004-1-7 | Jan.12, 2022 ----- Date of issue |
|--|--|

Equipment under Test : BATTERY CAMERA

Model /Type : Snap 12S

Listed model : Snap 12T,Snap 12Q

Applicant : **Hangzhou Meari Technology Co., Ltd.**

Address : Room 604-605, Building 1, No.768 Jianghong Road, Changhe street, Binjiang District, Hangzhou, zhejiang, China

Manufacturer : **Hangzhou Meari Technology Co., Ltd.**

Address : 4F of Building 1 and 2-4F of Building 2, No. 91 Chutian Road, Xixing Street, Binjiang District, Hangzhou,Zhejiang,China

| | |
|---------------------|-------------|
| Test Result: | PASS |
|---------------------|-------------|

The test report merely corresponds to the test sample.
 It is not permitted to copy extracts of these test result without the written permission of the test laboratory.

Contents

| | |
|--|-----------|
| 1. TEST STANDARDS | 4 |
| 2. SUMMARY | 5 |
| 2.1. General Remarks | 5 |
| 2.2. Product Description | 5 |
| 2.3. Equipment Under Test | 6 |
| 2.4. Short description of the Equipment under Test (EUT) | 6 |
| 2.5. EUT operation mode | 6 |
| 2.6. Block Diagram of Test Setup | 6 |
| 2.7. Related Submittal(s) / Grant (s) | 7 |
| 2.8. EUT Exercise Software | 7 |
| 2.9. Special Accessories | 7 |
| 2.10. External I/O Cable | 7 |
| 2.11. Modifications | 7 |
| 3. TEST ENVIRONMENT | 8 |
| 3.1. Address of the test laboratory | 8 |
| 3.2. Test Facility | 8 |
| 3.3. Environmental conditions | 8 |
| 3.4. Statement of the measurement uncertainty | 8 |
| 3.5. Test Description | 9 |
| 3.6. Equipments Used during the Test..... | 10 |
| 4. TEST CONDITIONS AND RESULTS | 11 |
| 4.1. AC Power Conducted Emission | 11 |
| 4.2. Radiated Emission | 14 |
| 4.3. Maximum Peak Output Power | 22 |
| 4.4. Power Spectral Density | 23 |
| 4.5. 6dB Bandwidth | 26 |
| 4.6. Band Edge Compliance of RF Emission | 29 |
| 4.7. Antenna Requirement | 34 |
| 5. TEST SETUP PHOTOS OF THE EUT | 35 |
| 6. EXTERNAL AND INTERNAL PHOTOS OF THE EUT | 38 |

1. TEST STANDARDS

The tests were performed according to following standards:

[FCC Rules Part 15.247](#): Frequency Hopping, Direct Spread Spectrum and Hybrid Systems that are in operation within the bands of 902-928 MHz, 2400-2483.5 MHz, and 5725-5850 MHz.

[ANSI C63.10-2013](#): American National Standard for Testing Unlicensed Wireless Devices

[KDB558074 D01 DTS Meas Guidance v05r02](#): Guidance for Performing Compliance Measurements on Digital Transmission Systems (DTS) Operating Under §15.247.

[KDB 662911D01 Multiple Transmitter Output v02r01](#): Emissions Testing of Transmitters with Multiple Outputs in the Same Band

2. SUMMARY

2.1. General Remarks

| | | |
|--------------------------------|---|--------------|
| Date of receipt of test sample | : | Dec.29, 2021 |
| | : | |
| Testing commenced on | : | Dec.29, 2021 |
| | : | |
| Testing concluded on | : | Jan.12, 2022 |

2.2. Product Description

| | |
|----------------------|--|
| Product Name | BATTERY CAMERA |
| Trade Mark | N/A |
| Model/Type reference | Snap 12S |
| List Models | Snap 12T,Snap 12Q |
| Model Declaration | PCB board, structure and internal of these model(s) are the same, Only the model name different , So no additional models were tested. |
| Power supply: | DC 3.7V by battery Recharged by DC 5.0V/1.0A |
| Sample ID | GTS20211227004-1-1#& GTS20211227004-1-2# |
| WIFI(2.4G Band) | |
| Frequency Range | 2412MHz ~ 2462MHz |
| Channel Spacing | 5MHz |
| Channel Number | 11 Channel for 20MHz bandwidth(2412~2462MHz) |
| Modulation Type | 802.11b: DSSS; 802.11g/n: OFDM |
| Antenna Description | FPC Antenna, 2.92dBi(Max.) |

2.3. Equipment Under Test

Power supply system utilised

| | | | |
|----------------------|---|---|-----------------------------------|
| Power supply voltage | : | <input type="radio"/> 230V / 50 Hz | <input type="radio"/> 120V / 60Hz |
| | | <input type="radio"/> 12 V DC | <input type="radio"/> 24 V DC |
| | | <input checked="" type="radio"/> Other (specified in blank below) | |

DC 5.0V

2.4. Short description of the Equipment under Test (EUT)

This is a BATTERY CAMERA .
For more details, refer to the user's manual of the EUT.

2.5. EUT operation mode

The application provider specific test software to control sample in continuous TX and RX (Duty Cycle >98%) for testing meet KDB558074 test requirement.

IEEE 802.11b/g/n: Thirteen channels are provided to the EUT.

| Antenna | Chain 0 | | Chain 1 | | Simultaneously |
|----------------|-------------------------------------|--------------------------|--------------------------|--------------------------|--------------------------|
| Bandwidth Mode | 20MHz | 40MHz | 20MHz | 40MHz | / |
| IEEE 802.11b | <input checked="" type="checkbox"/> | <input type="checkbox"/> | <input type="checkbox"/> | <input type="checkbox"/> | <input type="checkbox"/> |
| IEEE 802.11g | <input checked="" type="checkbox"/> | <input type="checkbox"/> | <input type="checkbox"/> | <input type="checkbox"/> | <input type="checkbox"/> |
| IEEE 802.11n | <input checked="" type="checkbox"/> | <input type="checkbox"/> | <input type="checkbox"/> | <input type="checkbox"/> | <input type="checkbox"/> |

| Channel | Frequency(MHz) | Channel | Frequency(MHz) |
|---------|----------------|---------|----------------|
| 1 | 2412 | 8 | 2447 |
| 2 | 2417 | 9 | 2452 |
| 3 | 2422 | 10 | 2457 |
| 4 | 2427 | 11 | 2462 |
| 5 | 2432 | | |
| 6 | 2437 | | |
| 7 | 2442 | | |

The EUT has been tested under operating condition.
AC main conducted emission pre-test voltage at both AC 120V/60Hz and AC 240V/60Hz, recorded worst case;
AC main conducted emission pre-test at charge from PC modes, recorded worst case;
This test was performed with EUT in X, Y, Z position and the worst case was found when EUT in X position.
Worst-case mode and channel used for 9 KHz-1000 MHz radiated emissions was the mode and channel with the highest output power, that was determined to be IEEE 802.11g mode (MCH).

2.6. Block Diagram of Test Setup

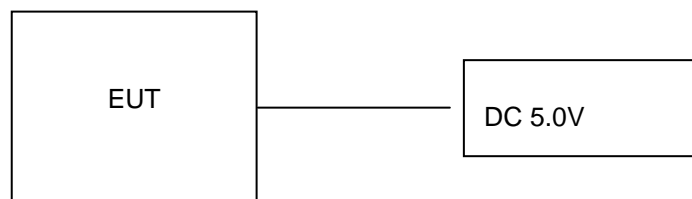

2.7. Related Submittal(s) / Grant (s)

This submittal(s) (test report) is intended for **FCC ID: 2AG7C-SNAP12T** filing to comply with Section 15.247 of the FCC Part 15, Subpart C Rules.

2.8. EUT Exercise Software

The system was configured for testing in a continuous transmits condition and change test channels by software (XCOM V2.2) provided by application.

2.9. Special Accessories

| Manufacturer | Description | Model | Serial Number | Certificate |
|---------------------------------------|-------------|-----------------|---------------|-------------|
| SHENZHEN TIANYIN ELECTRONICS CO.,LTD. | Adapter | TPA-46B050100UU | -- | SDOC |
| SHENZHEN GREENPOWERONE CO., LTD. | Adapter | GTA92-0501000US | -- | SDOC |

2.10. External I/O Cable

| I/O Port Description | Quantity | Cable |
|----------------------|----------|------------------------|
| USB Port | 1 | 1.0M, Unscreened Cable |

2.11. Modifications

No modifications were implemented to meet testing criteria.

3. TEST ENVIRONMENT

3.1. Address of the test laboratory

Shenzhen Global Test Service Co.,Ltd.

No.7-101 and 8A-104, Building 7 and 8, DCC Cultural and Creative Garden, No.98, Pingxin North Road, Shangmugu Community, Pinghu Street, Longgang District, Shenzhen, Guangdong,China.

3.2. Test Facility

The test facility is recognized, certified, or accredited by the following organizations:

CNAS (No. CNAS L8169)

Shenzhen Global Test Service Co., Ltd. has been assessed and proved to be in compliance with CNAS-CL01 Accreditation Criteria for Testing and Calibration Laboratories (identical to ISO/IEC 17025: 2019 General Requirements) for the Competence of Testing and Calibration Laboratories.

A2LA (Certificate No. 4758.01)

Shenzhen Global Test Service Co., Ltd. has been assessed by the American Association for Laboratory Accreditation (A2LA). Certificate No. 4758.01.

Industry Canada Registration Number. is 24189.

FCC Designation Number is CN1234.

FCC Registered Test Site Number is165725.

3.3. Environmental conditions

During the measurement the environmental conditions were within the listed ranges:

| | |
|-----------------------|--------------|
| Temperature: | 15-35 ° C |
| | |
| Humidity: | 30-60 % |
| | |
| Atmospheric pressure: | 950-1050mbar |

3.4. Statement of the measurement uncertainty

The data and results referenced in this document are true and accurate. The reader is cautioned that there may be errors within the calibration limits of the equipment and facilities. The measurement uncertainty was calculated for all measurements listed in this test report acc. to CISPR 16 - 4 „Specification for radio disturbance and immunity measuring apparatus and methods – Part 4: Uncertainty in EMC Measurements“ and is documented in the Shenzhen Global Test Service Co.,Ltd quality system acc. to DIN EN ISO/IEC 17025. Furthermore, component and process variability of devices similar to that tested may result in additional deviation. The manufacturer has the sole responsibility of continued compliance of the device.

Hereafter the best measurement capability for Shenzhen GTS laboratory is reported:

| Test | Range | Measurement Uncertainty | Notes |
|-----------------------|------------|-------------------------|-------|
| Radiated Emission | 30~1000MHz | 4.10 dB | (1) |
| Radiated Emission | 1~18GHz | 4.32 dB | (1) |
| Radiated Emission | 18-40GHz | 5.54 dB | (1) |
| Conducted Disturbance | 0.15~30MHz | 3.12 dB | (1) |

This uncertainty represents an expanded uncertainty expressed at approximately the 95% confidence level using a coverage factor of k=2.

3.5. Test Description

| Applied Standard: FCC Part 15 Subpart C | | | | |
|---|--------------------------------|--|-----------|--------|
| ISED Rules | Description of Test | Test Sample | Result | Remark |
| / | On Time and Duty Cycle | GTS20211227004-1-1# | / | / |
| §15.247(b) | Maximum Conducted Output Power | GTS20211227004-1-1# | Compliant | Note 1 |
| §15.247(e) | Power Spectral Density | GTS20211227004-1-1# | Compliant | Note 1 |
| §15.247(a)(2) | 6dB Bandwidth | GTS20211227004-1-1# | Compliant | Note 1 |
| §2.1047 | 99% Occupied Bandwidth | / | N/A | N/A |
| §15.209, §15.247(d) | Conducted Spurious Emissions | GTS20211227004-1-1# | Compliant | Note 1 |
| §15.209, §15.247(d) | Radiated Spurious Emissions | GTS20211227004-1-1# GTS20211227004-1-2# | Compliant | Note 1 |
| §15.205 | Emissions at Restricted Band | GTS20211227004-1-1# GTS20211227004-1-2# | Compliant | Note 1 |
| §15.207(a) | AC Conducted Emissions | GTS20211227004-1-2# | Compliant | Note 1 |
| §15.203 §15.247(c) | Antenna Requirements | GTS20211227004-1-1# | Compliant | Note 1 |
| §15.247(i)§2.1091 | RF Exposure | / | Compliant | Note 2 |

Remark:

1. The measurement uncertainty is not included in the test result.
2. NA = Not Applicable; NP = Not Performed
3. Note 1 – Test results inside test report;
4. Note 2 – Test results in other test report (MPE Report).
5. We tested all test mode and recorded worst case in report

Preliminary tests were performed in different data rate to find the worst radiated emission. The data rate shown in the table below is the worst-case rate with respect to the specific test item. Investigation has been done on all the possible configurations for searching the worst cases. The following table is a list of the test modes shown in this test report.

| Test Items | Mode | Data Rate | Channel |
|--|-----------------|-----------|---------|
| Maximum Peak Conducted Output Power | 11b/DSSS | 1 Mbps | 1/6/11 |
| Power Spectral Density | 11g/OFDM | 6 Mbps | 1/6/11 |
| 6dB Bandwidth | 11n(20MHz)/OFDM | 6.5Mbps | 1/6/11 |
| Spurious RF conducted emission | 11n(20MHz)/OFDM | 6.5Mbps | 1/6/11 |
| Radiated Emission 9kHz~1GHz& | 11n(20MHz)/OFDM | 6.5Mbps | 1/6/11 |
| Radiated Emission 1GHz~10 th Harmonic | 11n(20MHz)/OFDM | 6.5Mbps | 1/6/11 |
| Band Edge | 11b/DSSS | 1 Mbps | 1/11 |
| | 11g/OFDM | 6 Mbps | 1/11 |
| | 11n(20MHz)/OFDM | 6.5Mbps | 1/11 |

3.6. Equipments Used during the Test

| Test Equipment | Manufacturer | Model No. | Serial No. | Calibration Date | Calibration Due Date |
|----------------------------|-----------------------------------|-----------------------|-----------------|------------------|----------------------|
| LISN | CYBERTEK | EM5040A | E1850400105 | 2021/07/17 | 2022/07/16 |
| LISN | R&S | ESH2-Z5 | 893606/008 | 2021/07/17 | 2022/07/16 |
| EMI Test Receiver | R&S | ESPI3 | 101841-cd | 2021/07/17 | 2022/07/16 |
| EMI Test Receiver | R&S | ESCI7 | 101102 | 2021/09/19 | 2022/09/18 |
| Spectrum Analyzer | Agilent | N9020A | MY48010425 | 2021/09/19 | 2022/09/18 |
| Spectrum Analyzer | R&S | FSV40 | 100019 | 2021/07/17 | 2022/07/16 |
| Vector Signal generator | Agilent | N5181A | MY49060502 | 2021/07/17 | 2022/07/16 |
| Signal generator | Agilent | N5182A | 3610AO1069 | 2021/09/19 | 2022/09/18 |
| Climate Chamber | ESPEC | EL-10KA | A20120523 | 2021/09/19 | 2022/09/18 |
| Controller | EM Electronics | Controller EM 1000 | N/A | N/A | N/A |
| Horn Antenna | Schwarzbeck | BBHA 9120D | 01622 | 2021/09/19 | 2022/09/18 |
| Active Loop Antenna | Beijing Da Ze Technology Co.,Ltd. | ZN30900C | 15006 | 2021/09/19 | 2022/09/18 |
| Bilog Antenna | Schwarzbeck | VULB9163 | 000976 | 2021/08/08 | 2022/08/07 |
| Broadband Horn Antenna | SCHWARZBECK | BBHA 9170 | 791 | 2021/09/19 | 2022/09/18 |
| Amplifier | Schwarzbeck | BBV 9743 | #202 | 2021/07/17 | 2022/07/16 |
| Amplifier | Schwarzbeck | BBV9179 | 9719-025 | 2021/07/17 | 2022/07/16 |
| Amplifier | EMCI | EMC051845B | 980355 | 2021/07/17 | 2022/07/16 |
| Temperature/Humidity Meter | Gangxing | CTH-608 | 02 | 2021/07/17 | 2022/07/16 |
| High-Pass Filter | K&L | 9SH10-2700/X12750-O/O | KL142031 | 2021/07/17 | 2022/07/16 |
| High-Pass Filter | K&L | 41H10-1375/U12750-O/O | KL142032 | 2021/07/17 | 2022/07/16 |
| RF Cable(below 1GHz) | HUBER+SUHNER | RG214 | RE01 | 2021/07/17 | 2022/07/16 |
| RF Cable(above 1GHz) | HUBER+SUHNER | RG214 | RE02 | 2021/07/17 | 2022/07/16 |
| Data acquisition card | Agilent | U2531A | TW53323507 | 2021/07/17 | 2022/07/16 |
| Power Sensor | Agilent | U2021XA | MY5365004 | 2021/07/17 | 2022/07/16 |
| Test Control Unit | Tonscend | JS0806-1 | 178060067 | 2021/07/17 | 2022/07/16 |
| Automated filter bank | Tonscend | JS0806-F | 19F8060177 | 2021/07/17 | 2022/07/16 |
| EMI Test Software | Tonscend | JS1120-1 | Ver 2.6.8.0518 | / | / |
| EMI Test Software | Tonscend | JS1120-3 | Ver 2.5.77.0418 | / | / |
| EMI Test Software | Tonscend | JS32-CE | Ver 2.5 | / | / |
| EMI Test Software | Tonscend | JS32-RE | Ver 2.5.1.8 | / | / |

Note: The Cal.Interval was one year.

4. TEST CONDITIONS AND RESULTS

4.1. AC Power Conducted Emission

TEST CONFIGURATION

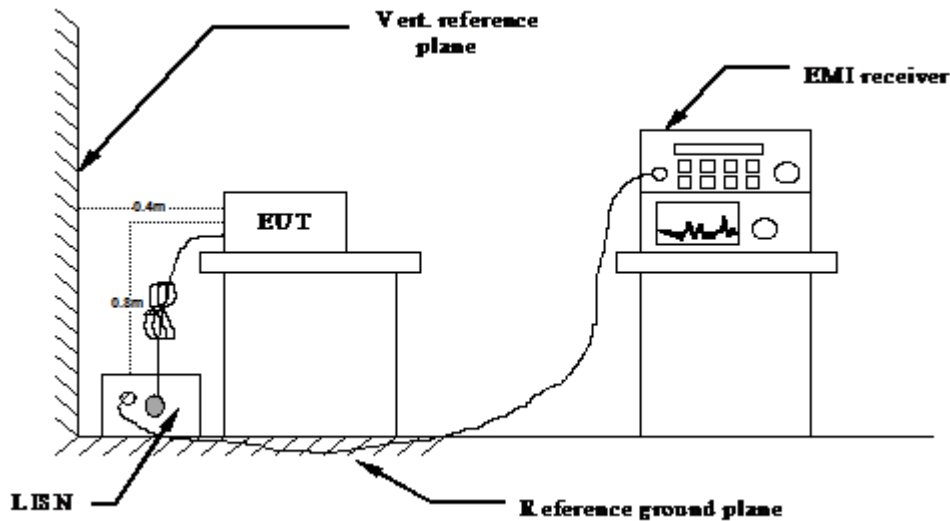

TEST PROCEDURE

- 1 The equipment was set up as per the test configuration to simulate typical actual usage per the user's manual. The EUT is a tabletop system, a wooden table with a height of 0.8 meters is used and is placed on the ground plane as per ANSI C63.10-2013.
- 2 Support equipment, if needed, was placed as per ANSI C63.10-2013.
- 3 All I/O cables were positioned to simulate typical actual usage as per ANSI C63.10-2013.
- 4 The EUT received DC 5V power, the adapter received AC120V/60Hz or AC 240V/60Hz power through a Line Impedance Stabilization Network (LISN) which supplied power source and was grounded to the ground plane.
- 5 All support equipments received AC power from a second LISN, if any.
- 6 The EUT test program was started. Emissions were measured on each current carrying line of the EUT using a spectrum Analyzer / Receiver connected to the LISN powering the EUT. The LISN has two monitoring points: Line 1 (Hot Side) and Line 2 (Neutral Side). Two scans were taken: one with Line 1 connected to Analyzer / Receiver and Line 2 connected to a 50 ohm load; the second scan had Line 1 connected to a 50 ohm load and Line 2 connected to the Analyzer / Receiver.
- 7 Analyzer / Receiver scanned from 150 KHz to 30MHz for emissions in each of the test modes.
- 8 During the above scans, the emissions were maximized by cable manipulation.

AC Power Conducted Emission Limit

For intentional device, according to § 15.207(a) AC Power Conducted Emission Limits is as following :

| Frequency range (MHz) | Limit (dBuV) | |
|-----------------------|--------------|-----------|
| | Quasi-peak | Average |
| 0.15-0.5 | 66 to 56* | 56 to 46* |
| 0.5-5 | 56 | 46 |
| 5-30 | 60 | 50 |

* Decreases with the logarithm of the frequency.

TEST RESULTS

Remark: We measured Conducted Emission at 802.11b/802.11g/802.11n HT20 mode from 150 KHz to 30MHz in AC120V and the worst case was recorded.

| | | | |
|---------------|-----------|----------------|--------------------|
| Temperature | 25°C | Humidity | 60% |
| Test Engineer | Oliver Ou | Configurations | IEEE 802.11g (MCH) |

Adapter: TPA-46B050100UU

| | | | |
|---------------|--------------|--------------|---|
| Power supply: | AC 120V/60Hz | Polarization | L |
|---------------|--------------|--------------|---|

Test Graph

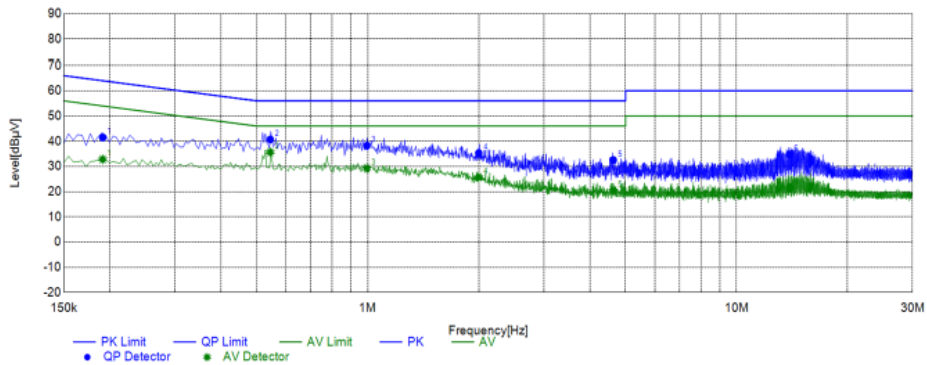

| Final Data List | | | | | | | | | | | | |
|-----------------|-----------------|-------------------|---------------------|-------------|------------------|--------------------|-----------------|-------------------|----------------|------------------|------|--------|
| NO. | Frequency [MHz] | QP Reading [dBµV] | AVG. Reading [dBµV] | Factor [dB] | QP Result [dBµV] | AVG. Result [dBµV] | QP Limit [dBµV] | AVG. Limit [dBµV] | QP Margin [dB] | AVG. Margin [dB] | Line | Remark |
| 1 | 0.1912 | 31.41 | 22.76 | 10.06 | 41.47 | 32.82 | 63.98 | 53.98 | 22.51 | 21.16 | L1 | PASS |
| 2 | 0.5443 | 30.62 | 25.57 | 10.06 | 40.68 | 35.63 | 56.00 | 46.00 | 15.32 | 10.37 | L1 | PASS |
| 3 | 0.9944 | 28.13 | 19.16 | 10.07 | 38.20 | 29.23 | 56.00 | 46.00 | 17.80 | 16.77 | L1 | PASS |
| 4 | 2.0001 | 25.17 | 15.61 | 10.15 | 35.32 | 25.76 | 56.00 | 46.00 | 20.68 | 20.24 | L1 | PASS |
| 5 | 4.6320 | 22.10 | 9.99 | 10.45 | 32.55 | 20.44 | 56.00 | 46.00 | 23.45 | 25.56 | L1 | PASS |
| 6 | 13.9119 | 23.81 | 10.58 | 10.98 | 34.79 | 21.56 | 60.00 | 50.00 | 25.21 | 28.44 | L1 | PASS |

Note: 1. Result (dBµV) = Reading (dBµV) + Factor (dB).
 2. Factor (dB) = Cable loss (dB) + LISN Factor (dB).

| | | | |
|---------------|--------------|--------------|---|
| Power supply: | AC 120V/60Hz | Polarization | N |
|---------------|--------------|--------------|---|

Test Graph

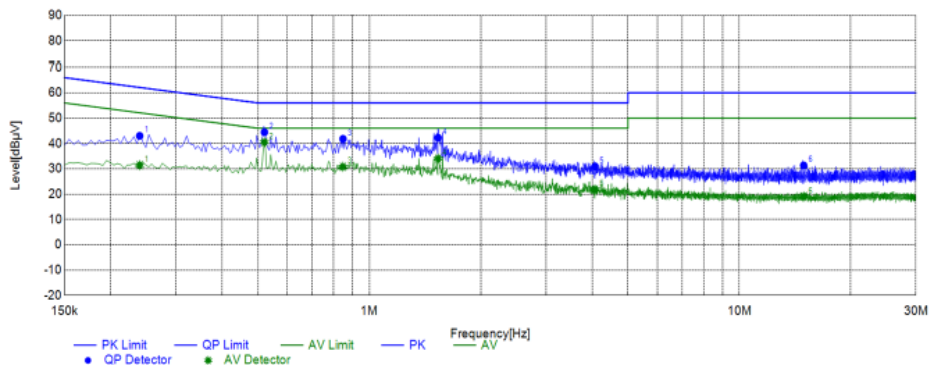

| Final Data List | | | | | | | | | | | | |
|-----------------|-----------------|-------------------|---------------------|-------------|------------------|--------------------|-----------------|-------------------|----------------|------------------|------|--------|
| NO. | Frequency [MHz] | QP Reading [dBµV] | AVG. Reading [dBµV] | Factor [dB] | QP Result [dBµV] | AVG. Result [dBµV] | QP Limit [dBµV] | AVG. Limit [dBµV] | QP Margin [dB] | AVG. Margin [dB] | Line | Remark |
| 1 | 0.2396 | 32.98 | 21.42 | 10.02 | 43.00 | 31.44 | 62.11 | 52.11 | 19.11 | 20.67 | N | PASS |
| 2 | 0.5206 | 34.39 | 30.47 | 10.06 | 44.45 | 40.53 | 56.00 | 46.00 | 11.55 | 5.47 | N | PASS |
| 3 | 0.8490 | 31.75 | 20.74 | 10.07 | 41.82 | 30.81 | 56.00 | 46.00 | 14.18 | 15.19 | N | PASS |
| 4 | 1.5342 | 32.13 | 23.93 | 10.11 | 42.24 | 34.04 | 56.00 | 46.00 | 13.76 | 11.96 | N | PASS |
| 5 | 4.0730 | 20.56 | 11.47 | 10.41 | 30.97 | 21.88 | 56.00 | 46.00 | 25.03 | 24.12 | N | PASS |
| 6 | 14.9180 | 20.28 | 8.02 | 11.06 | 31.34 | 19.08 | 60.00 | 50.00 | 28.66 | 30.92 | N | PASS |

Note: 1. Result (dBµV) = Reading (dBµV) + Factor (dB).
 2. Factor (dB) = Cable loss (dB) + LISN Factor (dB).

Adapter: GTA92-0501000US

| | | | |
|---------------|--------------|--------------|---|
| Power supply: | AC 120V/60Hz | Polarization | L |
|---------------|--------------|--------------|---|

Test Graph

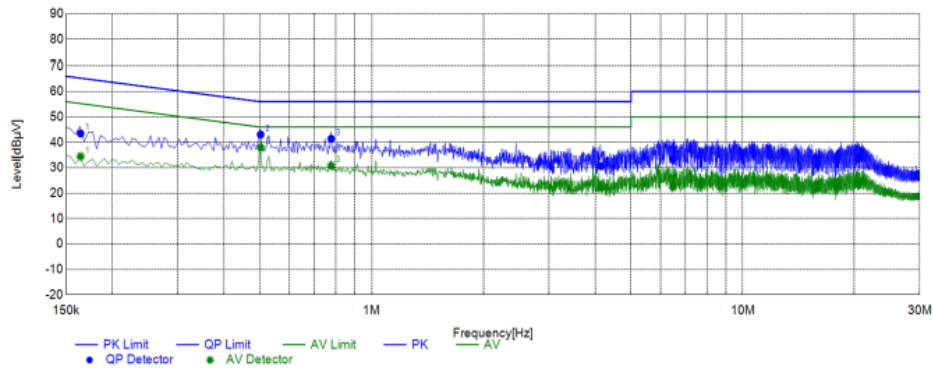

Final Data List

| NO. | Frequency [MHz] | QP Reading [dBµV] | AVG. Reading [dBµV] | Factor [dB] | QP Result [dBµV] | AVG. Result [dBµV] | QP Limit [dBµV] | AVG. Limit [dBµV] | QP Margin [dB] | AVG. Margin [dB] | Line | Remark |
|-----|-----------------|-------------------|---------------------|-------------|------------------|--------------------|-----------------|-------------------|----------------|------------------|------|--------|
| 1 | 0.1643 | 33.46 | 24.37 | 10.05 | 43.51 | 34.42 | 65.25 | 55.25 | 21.74 | 20.83 | L1 | PASS |
| 2 | 0.5022 | 33.02 | 27.89 | 10.06 | 43.08 | 37.95 | 56.00 | 46.00 | 12.92 | 8.05 | L1 | PASS |
| 3 | 0.7782 | 31.32 | 20.69 | 10.07 | 41.39 | 30.76 | 56.00 | 46.00 | 14.61 | 15.24 | L1 | PASS |
| 4 | 4.1487 | 20.18 | 11.59 | 10.41 | 30.59 | 22.00 | 56.00 | 46.00 | 25.41 | 24.00 | L1 | PASS |
| 5 | 6.4810 | 22.90 | 11.78 | 10.56 | 33.46 | 22.34 | 60.00 | 50.00 | 26.54 | 27.66 | L1 | PASS |
| 6 | 20.4511 | 22.10 | 12.19 | 11.52 | 33.62 | 23.71 | 60.00 | 50.00 | 26.38 | 26.29 | L1 | PASS |

Note: 1. Result (dBµV) = Reading (dBµV) + Factor (dB).

2. Factor (dB) = Cable loss (dB) + LISN Factor (dB).

| | | | |
|---------------|--------------|--------------|---|
| Power supply: | AC 120V/60Hz | Polarization | N |
|---------------|--------------|--------------|---|

Test Graph

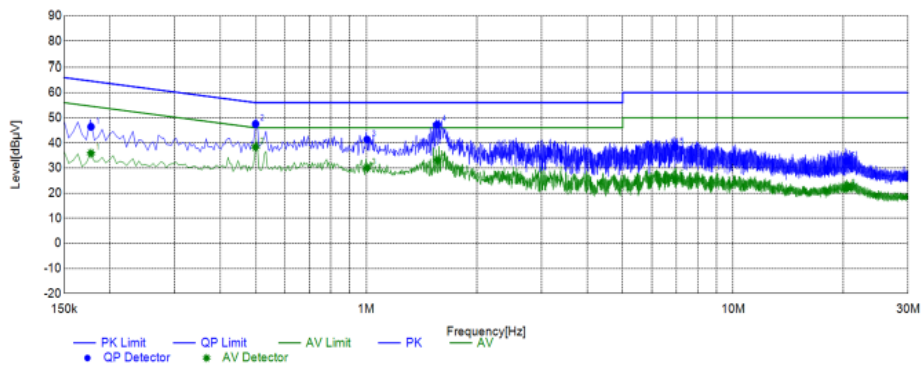

Final Data List

| NO. | Frequency [MHz] | QP Reading [dBµV] | AVG. Reading [dBµV] | Factor [dB] | QP Result [dBµV] | AVG. Result [dBµV] | QP Limit [dBµV] | AVG. Limit [dBµV] | QP Margin [dB] | AVG. Margin [dB] | Line | Remark |
|-----|-----------------|-------------------|---------------------|-------------|------------------|--------------------|-----------------|-------------------|----------------|------------------|------|--------|
| 1 | 0.1776 | 36.35 | 25.81 | 10.05 | 46.40 | 35.86 | 64.60 | 54.60 | 18.20 | 18.74 | N | PASS |
| 2 | 0.4989 | 37.47 | 28.30 | 10.06 | 47.53 | 38.36 | 56.02 | 46.02 | 8.49 | 7.66 | N | PASS |
| 3 | 1.0047 | 31.26 | 20.05 | 10.07 | 41.33 | 30.12 | 56.00 | 46.00 | 14.67 | 15.88 | N | PASS |
| 4 | 1.5608 | 37.15 | 23.00 | 10.12 | 47.27 | 33.12 | 56.00 | 46.00 | 8.73 | 12.88 | N | PASS |
| 5 | 6.9473 | 27.67 | 14.71 | 10.59 | 38.26 | 25.30 | 60.00 | 50.00 | 21.74 | 24.70 | N | PASS |
| 6 | 20.3804 | 21.31 | 10.40 | 11.42 | 32.73 | 21.82 | 60.00 | 50.00 | 27.27 | 28.18 | N | PASS |

Note: 1. Result (dBµV) = Reading (dBµV) + Factor (dB).

2. Factor (dB) = Cable loss (dB) + LISN Factor (dB).

4.2. Radiated Emission

TEST CONFIGURATION

Frequency range 9 KHz – 30MHz



Frequency range 30MHz – 1000MHz

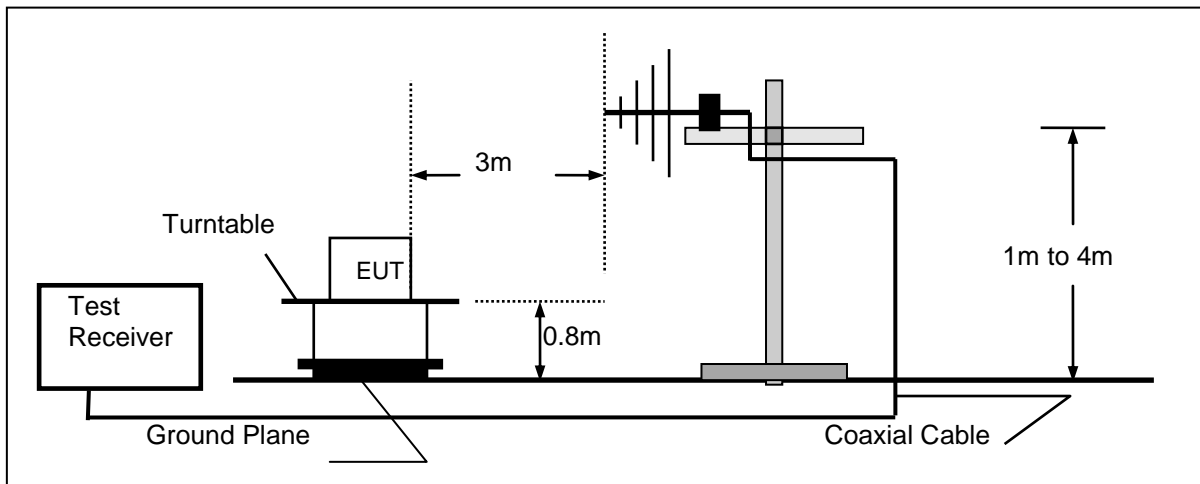

Frequency range above 1GHz-25GHz

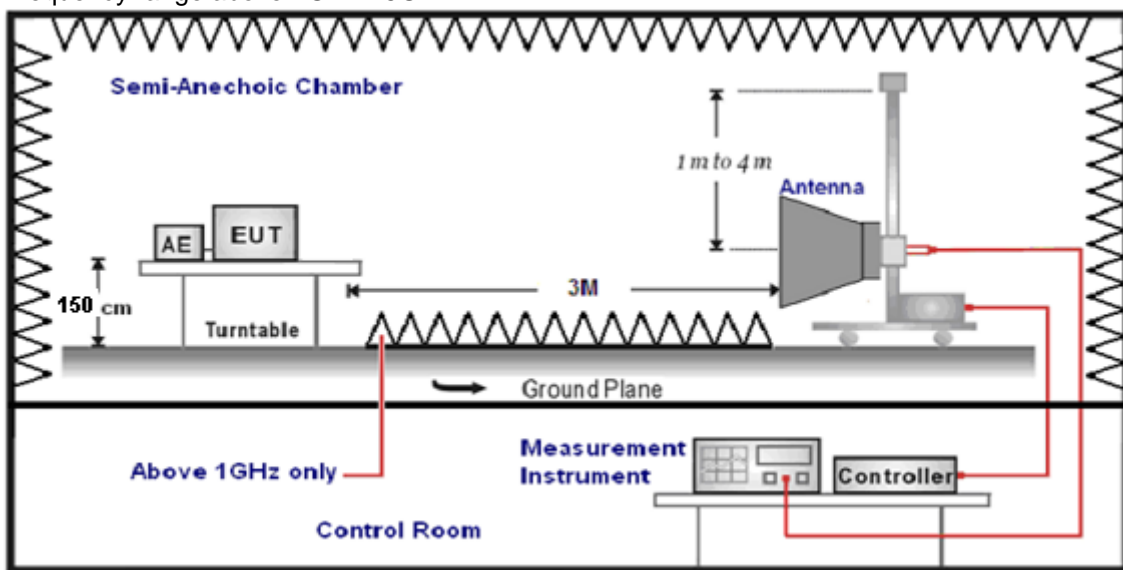

TEST PROCEDURE

1. The EUT was placed on a turn table which is 0.8m above ground plane when testing frequency range 30MHz –1GHz;the EUT was placed on a turn table which is 1.5m above ground plane when testing frequency range 1GHz – 25GHz.
2. Maximum procedure was performed by raising the receiving antenna from 1m to 4m and rotating the turn table from 0° to 360° to acquire the highest emissions from EUT.
3. And also, each emission was to be maximized by changing the polarization of receiving antenna both horizontal and vertical.
4. Repeat above procedures until all frequency measurements have been completed.
5. Radiated emission test frequency band from 30MHz to 25GHz.
6. The distance between test antenna and EUT as following table states:

| Test Frequency range | Test Antenna Type | Test Distance |
|----------------------|----------------------------|---------------|
| 9KHz-30MHz | Active Loop Antenna | 3 |
| 30MHz-1GHz | Ultra-Broadband Antenna | 3 |
| 1GHz-18GHz | Double Ridged Horn Antenna | 3 |
| 18GHz-25GHz | Horn Antenna | 1 |

7. Setting test receiver/spectrum as following table states:

| Test Frequency range | Test Receiver/Spectrum Setting | Detector |
|----------------------|---|----------|
| 9KHz-150KHz | RBW=200Hz/VBW=3KHz,Sweep time=Auto | QP |
| 150KHz-30MHz | RBW=9KHz/VBW=100KHz,Sweep time=Auto | QP |
| 30MHz-1GHz | RBW=120KHz/VBW=1000KHz,Sweep time=Auto | QP |
| 1GHz-40GHz | Peak Value: RBW=1MHz/VBW=3MHz, Sweep time=Auto Average Value: RBW=1MHz/VBW=10Hz, Sweep time=Auto | Peak |

Field Strength Calculation

The field strength is calculated by adding the Antenna Factor and Cable Factor and subtracting the Amplifier Gain and Duty Cycle Correction Factor(if any) from the measured reading. The basic equation with a sample calculation is as follows:

$$FS = RA + AF + CL - AG$$

| | |
|---------------------------|--|
| Where FS = Field Strength | CL = Cable Attenuation Factor (Cable Loss) |
| RA = Reading Amplitude | AG = Amplifier Gain |
| AF = Antenna Factor | |

$$Transd=AF +CL-AG$$

RADIATION LIMIT

For intentional device, according to § 15.209(a), the general requirement of field strength of radiated emission from intentional radiators at a distance of 3 meters shall not exceed the following table. According to § 15.247(d), in any 100kHz bandwidth outside the frequency band in which the EUT is operating, the radio frequency power that is produced by the intentional radiator shall be at least 20dB below that in the 100kHz bandwidth within the band that contains the highest level of desired power.

The pre-test have done for the EUT in three axes and found the worst emission at position shown in test setup photos.

| Frequency (MHz) | Distance (Meters) | Radiated (dBµV/m) | Radiated (µV/m) |
|-----------------|-------------------|--|-----------------|
| 0.009-0.49 | 3 | $20\log(2400/F(\text{KHz}))+40\log(300/3)$ | 2400/F(KHz) |
| 0.49-1.705 | 3 | $20\log(24000/F(\text{KHz}))+40\log(30/3)$ | 24000/F(KHz) |
| 1.705-30 | 3 | $20\log(30)+40\log(30/3)$ | 30 |
| 30-88 | 3 | 40.0 | 100 |
| 88-216 | 3 | 43.5 | 150 |
| 216-960 | 3 | 46.0 | 200 |
| Above 960 | 3 | 54.0 | 500 |

TEST RESULTS

Remark: We measured Radiated Emission at 802.11b/802.11g/802.11n HT20 mode from 30 MHz to 25GHz in AC120V and the worst case was recorded.

| | | | |
|---------------|-----------|----------------|--------------------|
| Temperature | 25°C | Humidity | 60% |
| Test Engineer | Oliver Ou | Configurations | IEEE 802.11g (MCH) |

For 9 KHz~30MHz

| Freq. (MHz) | Level (dBuV) | Over Limit (dB) | Over Limit (dBuV) | Remark |
|-------------|--------------|-----------------|-------------------|----------|
| - | - | - | - | See Note |

Note:

The amplitude of spurious emissions which are attenuated by more than 20 dB below the permissible value has no need to be reported.

Distance extrapolation factor = $40 \log(\text{specific distance} / \text{test distance})$ (dB);

Limit line = specific limits (dBuV) + distance extrapolation factor.

Adapter: TPA-46B050100UU

For 30MHz-1GHz

Horizontal

Test Graph

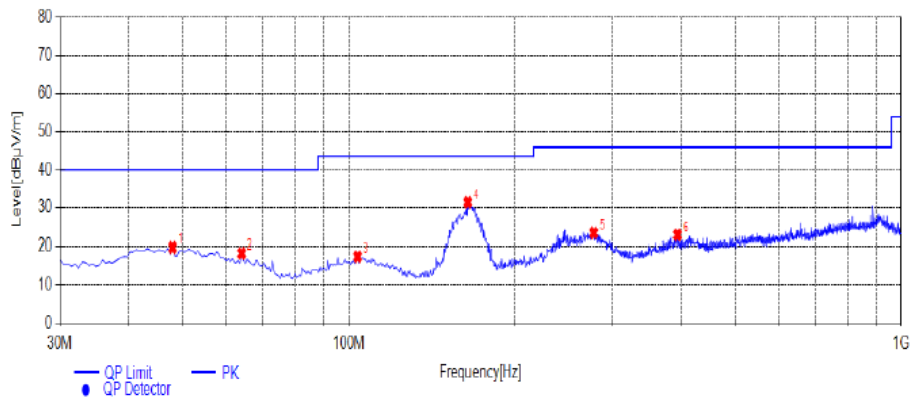

Suspected List

| NO. | Frequency [MHz] | Reading [dBµV/m] | Factor [dB] | Result [dBµV/m] | Limit [dBµV/m] | Margin [dB] | Height [cm] | Angle [°] | Detector | Polarity | Remark |
|-----|-----------------|------------------|-------------|-----------------|----------------|-------------|-------------|-----------|----------|------------|--------|
| 1 | 47.9450 | 26.46 | -6.66 | 19.80 | 40.00 | 20.20 | 100 | 318 | PK | Horizontal | PASS |
| 2 | 63.9500 | 27.21 | -8.86 | 18.35 | 40.00 | 21.65 | 100 | 220 | PK | Horizontal | PASS |
| 3 | 103.7200 | 25.70 | -8.19 | 17.51 | 43.50 | 25.99 | 100 | 130 | PK | Horizontal | PASS |
| 4 | 164.3450 | 42.73 | -11.31 | 31.42 | 43.50 | 12.08 | 100 | 89 | PK | Horizontal | PASS |
| 5 | 277.8350 | 31.46 | -8.04 | 23.42 | 46.00 | 22.58 | 100 | 76 | PK | Horizontal | PASS |
| 6 | 393.7500 | 28.59 | -5.67 | 22.92 | 46.00 | 23.08 | 100 | 19 | PK | Horizontal | PASS |

Note: 1. Result (dBµV/m) = Reading(dBµV/m) + Factor (dB) .

2. Factor (dB) = Antenna Factor (dB/m) + Cable loss (dB) - Pre Amplifier gain (dB).

Vertical

Test Graph

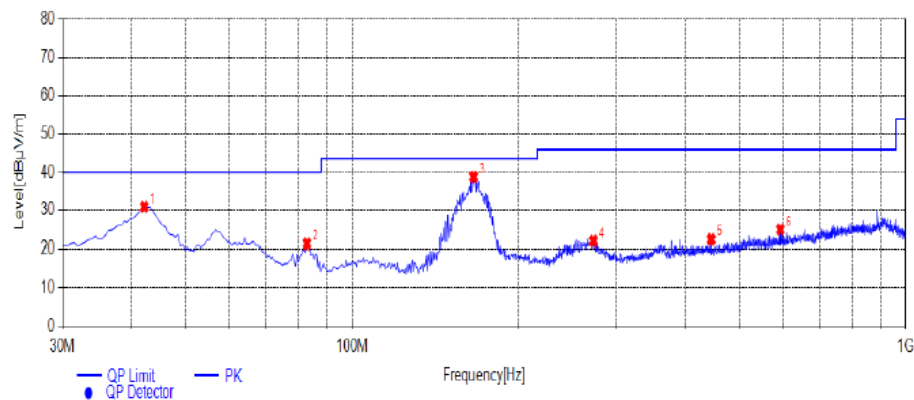

Suspected List

| NO. | Frequency [MHz] | Reading [dBµV/m] | Factor [dB] | Result [dBµV/m] | Limit [dBµV/m] | Margin [dB] | Height [cm] | Angle [°] | Detector | Polarity | Remark |
|-----|-----------------|------------------|-------------|-----------------|----------------|-------------|-------------|-----------|----------|----------|--------|
| 1 | 42.1250 | 38.03 | -7.15 | 30.88 | 40.00 | 9.12 | 100 | 343 | PK | Vertical | PASS |
| 2 | 82.8650 | 33.37 | -12.00 | 21.37 | 40.00 | 18.63 | 100 | 20 | PK | Vertical | PASS |
| 3 | 165.8000 | 50.02 | -11.21 | 38.81 | 43.50 | 4.69 | 100 | 87 | PK | Vertical | PASS |
| 4 | 272.9850 | 30.24 | -8.24 | 22.00 | 46.00 | 24.00 | 100 | 149 | PK | Vertical | PASS |
| 5 | 445.6450 | 26.88 | -4.49 | 22.39 | 46.00 | 23.61 | 100 | 349 | PK | Vertical | PASS |
| 6 | 594.0550 | 26.79 | -1.81 | 24.98 | 46.00 | 21.02 | 100 | 39 | PK | Vertical | PASS |

Note: 1. Result (dBµV/m) = Reading(dBµV/m) + Factor (dB) .

2. Factor (dB) = Antenna Factor (dB/m) + Cable loss (dB) - Pre Amplifier gain (dB).

Adapter: GTA92-0501000US

For 30MHz-1GHz

Horizontal

Test Graph

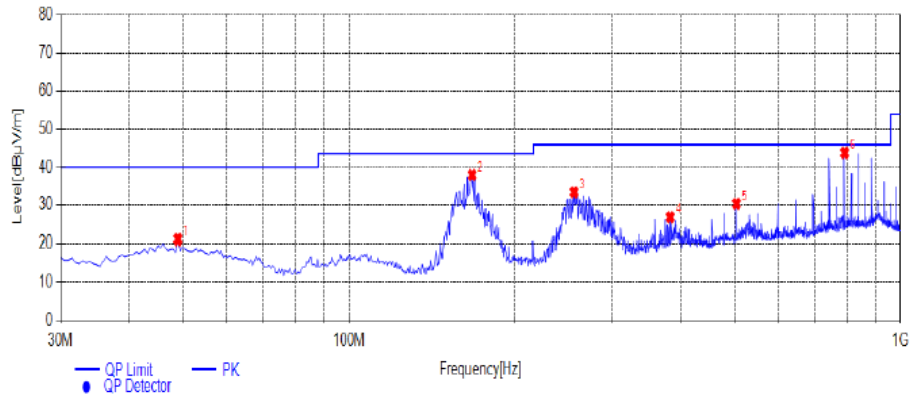

Suspected List

| NO. | Frequency [MHz] | Reading [dBµV/m] | Factor [dB] | Result [dBµV/m] | Limit [dBµV/m] | Margin [dB] | Height [cm] | Angle [°] | Detector | Polarity | Remark |
|-----|-----------------|------------------|-------------|-----------------|----------------|-------------|-------------|-----------|----------|------------|--------|
| 1 | 48.9150 | 27.78 | -6.65 | 21.13 | 40.00 | 18.87 | 100 | 246 | PK | Horizontal | PASS |
| 2 | 167.2550 | 49.35 | -11.41 | 37.94 | 43.50 | 5.56 | 100 | 75 | PK | Horizontal | PASS |
| 3 | 256.0100 | 41.36 | -7.96 | 33.40 | 46.00 | 12.60 | 100 | 327 | PK | Horizontal | PASS |
| 4 | 382.5950 | 32.86 | -6.04 | 26.82 | 46.00 | 19.18 | 100 | 358 | PK | Horizontal | PASS |
| 5 | 504.3300 | 33.69 | -3.37 | 30.32 | 46.00 | 15.68 | 100 | 335 | PK | Horizontal | PASS |
| 6 | 792.4200 | 42.62 | 1.14 | 43.76 | 46.00 | 2.24 | 100 | 2 | PK | Horizontal | PASS |

Note: 1. Result (dBµV/m) = Reading(dBµV/m) + Factor (dB) .

2. Factor (dB) = Antenna Factor (dB/m) + Cable loss (dB) - Pre Amplifier gain (dB).

Vertical

Test Graph

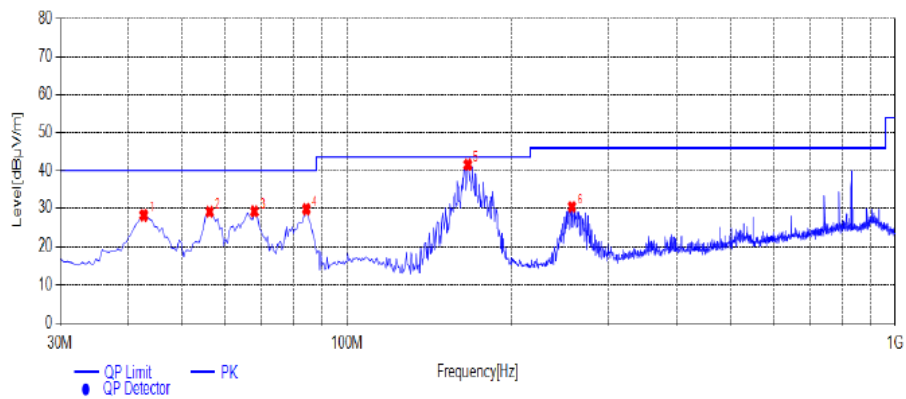

Suspected List

| NO. | Frequency [MHz] | Reading [dBµV/m] | Factor [dB] | Result [dBµV/m] | Limit [dBµV/m] | Margin [dB] | Height [cm] | Angle [°] | Detector | Polarity | Remark |
|-----|-----------------|------------------|-------------|-----------------|----------------|-------------|-------------|-----------|----------|----------|--------|
| 1 | 42.6100 | 35.10 | -6.99 | 28.11 | 40.00 | 11.89 | 100 | 27 | PK | Vertical | PASS |
| 2 | 56.1900 | 36.33 | -7.30 | 29.03 | 40.00 | 10.97 | 100 | 91 | PK | Vertical | PASS |
| 3 | 67.8300 | 38.53 | -9.41 | 29.12 | 40.00 | 10.88 | 100 | 89 | PK | Vertical | PASS |
| 4 | 84.3200 | 41.39 | -11.66 | 29.73 | 40.00 | 10.27 | 100 | 89 | PK | Vertical | PASS |
| 5 | 166.2850 | 52.69 | -11.21 | 41.48 | 43.50 | 2.02 | 100 | 73 | PK | Vertical | PASS |
| 6 | 257.4650 | 38.27 | -7.93 | 30.34 | 46.00 | 15.66 | 100 | 60 | PK | Vertical | PASS |

Note: 1. Result (dBµV/m) = Reading(dBµV/m) + Factor (dB) .

2. Factor (dB) = Antenna Factor (dB/m) + Cable loss (dB) - Pre Amplifier gain (dB).

For Greater than 1GHz

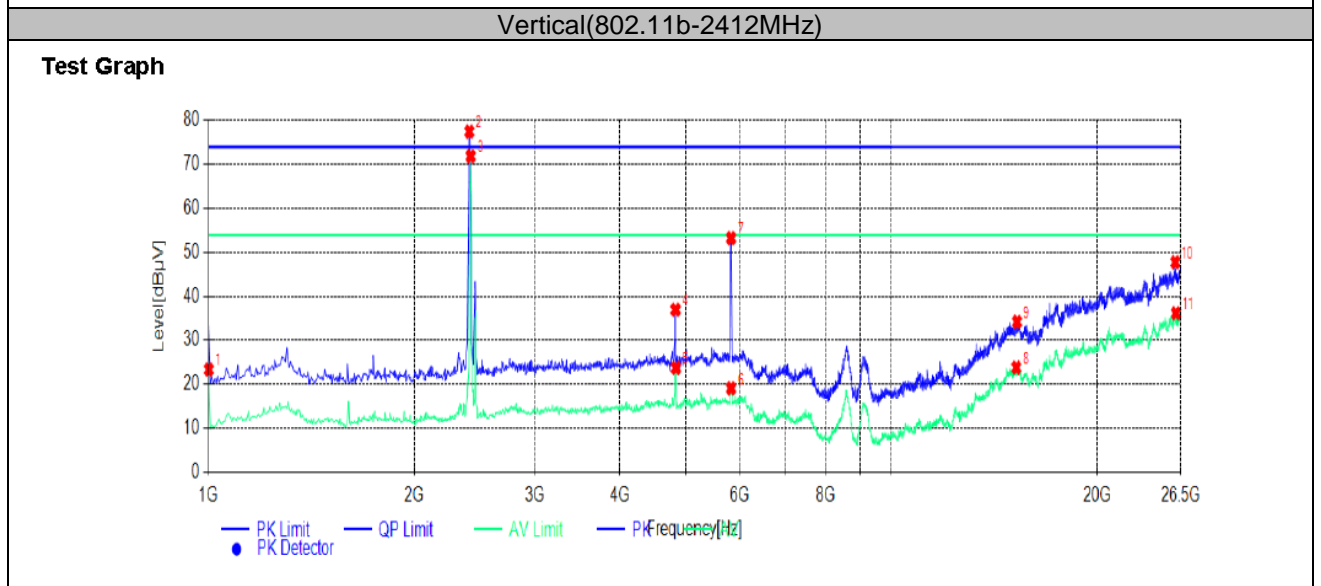
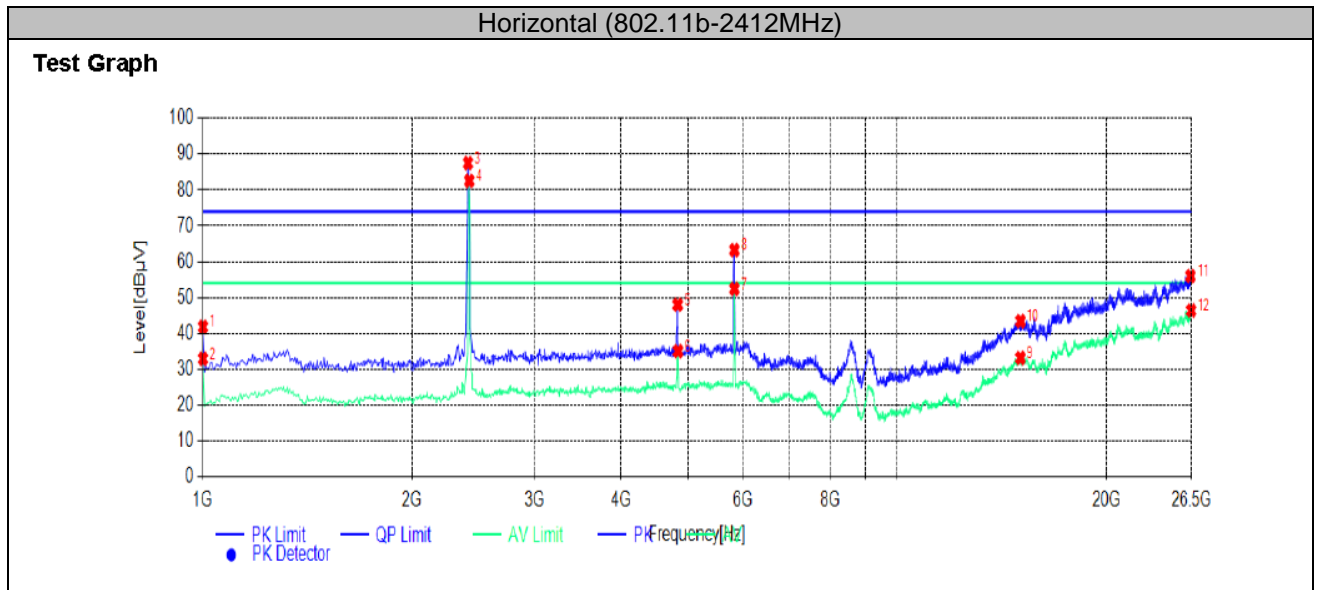

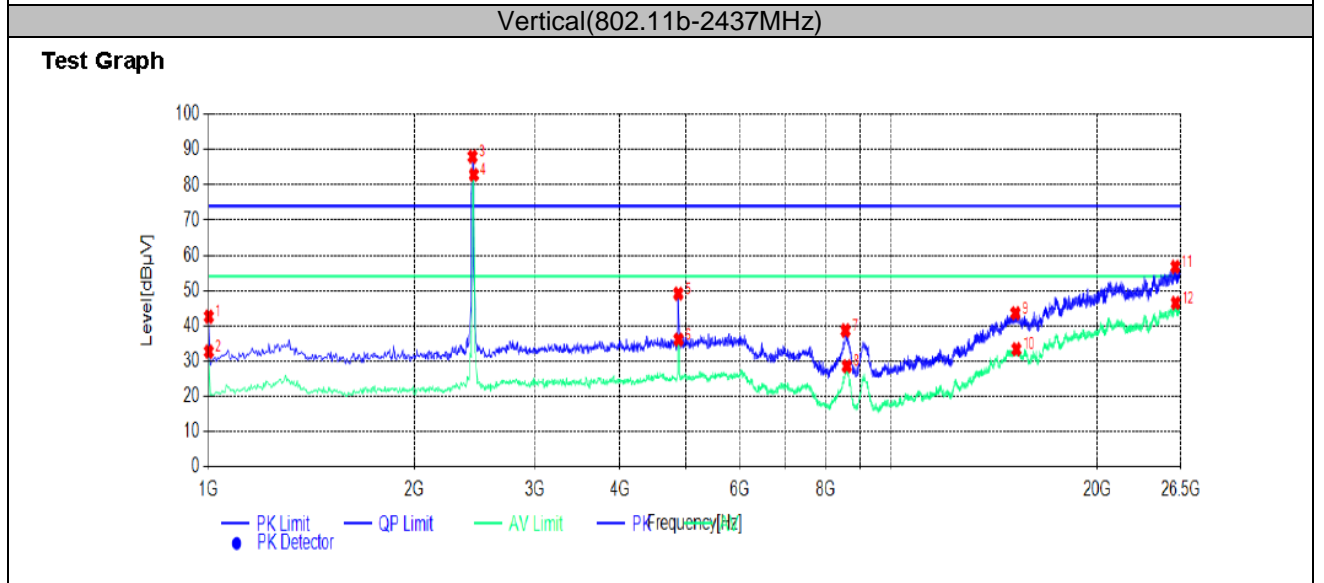
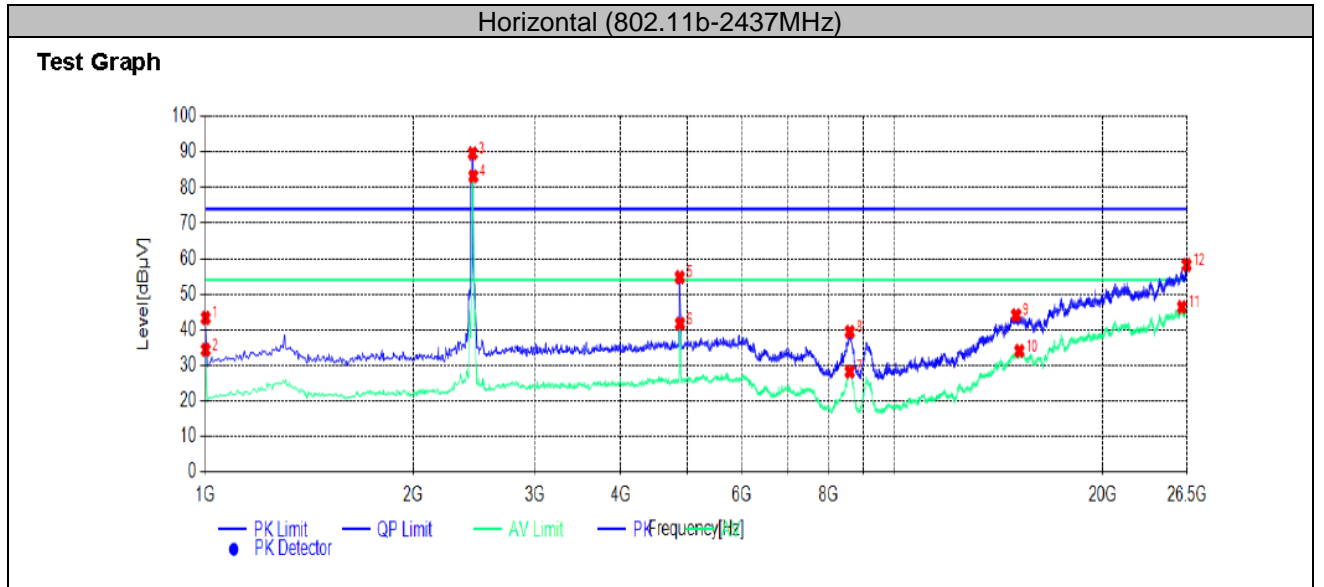

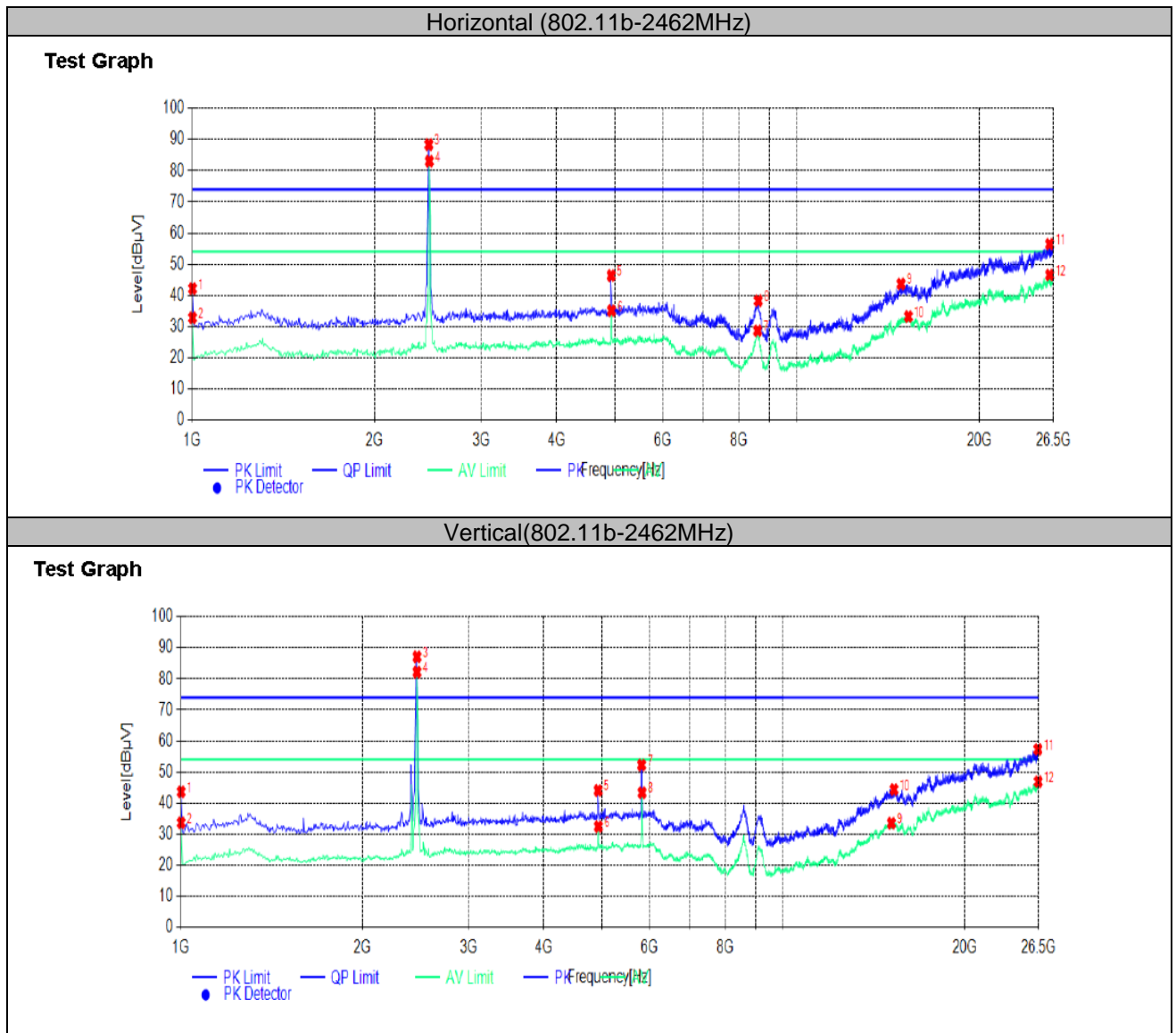

REMARKS:

1. Emission level (dBuV/m) =Raw Value (dBuV)+Correction Factor (dB/m)
2. Correction Factor (dB/m) = Antenna Factor (dB/m)+Cable Factor (dB)-Pre-amplifier Factor
3. Margin value = Limit value- Emission level.
4. -- Mean the PK detector measured value is below average limit.
5. The other emission levels were very low against the limit.

NOTE: All the modes have been tested and recorded worst mode in the report.

4.3. Maximum Peak Output Power

TEST CONFIGURATION

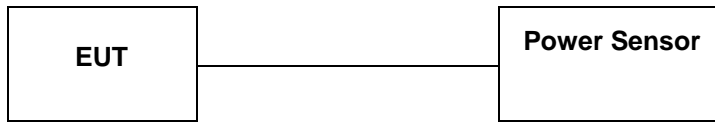

TEST PROCEDURE

According to KDB558074 D01 DTS Measurement Guidance Section 9.1 Maximum peak conducted output power, 9.1.2. and Average conducted output power, 9.2.3.1.

The maximum peak conducted output power may be measured using a broadband peak RF power meter. The power meter shall have a video bandwidth that is greater than or equal to the DTS bandwidth and shall utilize a fast-responding diode detector.

The maximum Average conducted output power may be measured using a wideband RF power meter with a thermocouple detector or equivalent. The power meter shall have a video bandwidth that is greater than or equal to the DTS bandwidth and shall utilize a fast-responding diode detector.

LIMIT

The Maximum Peak Output Power Measurement is 30dBm.

TEST RESULTS

| | | | |
|---------------|-----------|----------------|------------------|
| Temperature | 23.4°C | Humidity | 52.7% |
| Test Engineer | Oliver Ou | Configurations | IEEE 802.11b/g/n |

| Type | Channel | Output power PK (dBm) | Output power AV (dBm) | Limit (dBm) | Result |
|---------------|---------|-----------------------|-----------------------|-------------|--------|
| 802.11b | 01 | 18.59 | 15.43 | 30.00 | Pass |
| | 06 | 18.52 | 15.39 | | |
| | 11 | 18.04 | 14.96 | | |
| 802.11g | 01 | 20.40 | 17.12 | 30.00 | Pass |
| | 06 | 20.05 | 16.87 | | |
| | 11 | 20.33 | 16.96 | | |
| 802.11n(HT20) | 01 | 20.26 | 16.12 | 30.00 | Pass |
| | 06 | 19.19 | 15.18 | | |
| | 11 | 19.39 | 15.29 | | |

Note: 1. The test results including the cable loss.
 Duty cycle used in all test items: 100%

4.4. Power Spectral Density

TEST CONFIGURATION

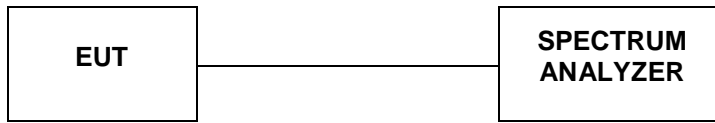

TEST PROCEDURE

According to KDB 558074 D01 Method PKPSD (peak PSD) This procedure shall be used if maximum peak conducted output power was used to demonstrate compliance, and is optional if the maximum conducted (average) output power was used to demonstrate compliance.

1. Set analyzer center frequency to DTS channel center frequency.
2. Set the span to 1.5 times the DTS bandwidth.
3. Set the RBW to: $3 \text{ kHz} \leq \text{RBW} \leq 100 \text{ kHz}$.
4. Set the VBW $\geq 3 \text{ RBW}$.
5. Detector = peak.
6. Sweep time = auto couple.
7. Trace mode = max hold.
8. Allow trace to fully stabilize.
9. Use the peak marker function to determine the maximum amplitude level within the RBW.
10. If measured value exceeds limit, reduce RBW (no less than 3 kHz) and repeat.

LIMIT

For digitally modulated systems, the power spectral density conducted from the intentional radiator to the antenna shall not be greater than 8 dBm in any 3 kHz band during any time interval of continuous transmission.

TEST RESULTS

| | | | |
|---------------|-----------|----------------|------------------|
| Temperature | 23.4°C | Humidity | 52.7% |
| Test Engineer | Oliver Ou | Configurations | IEEE 802.11b/g/n |

| Type | Channel | Power Spectral Density (dBm/3KHz) | Limit (dBm/3KHz) | Result |
|---------------|---------|-----------------------------------|------------------|--------|
| 802.11b | 01 | -10.24 | 8.00 | Pass |
| | 06 | -10.25 | | |
| | 11 | -9.72 | | |
| 802.11g | 01 | -12.47 | 8.00 | Pass |
| | 06 | -14.37 | | |
| | 11 | -14.20 | | |
| 802.11n(HT20) | 01 | -14.30 | 8.00 | Pass |
| | 06 | -15.37 | | |
| | 11 | -15.22 | | |

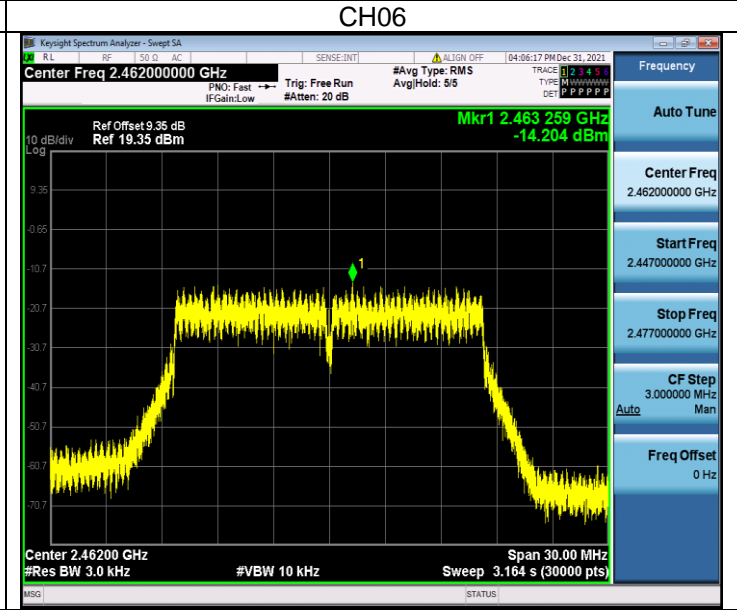
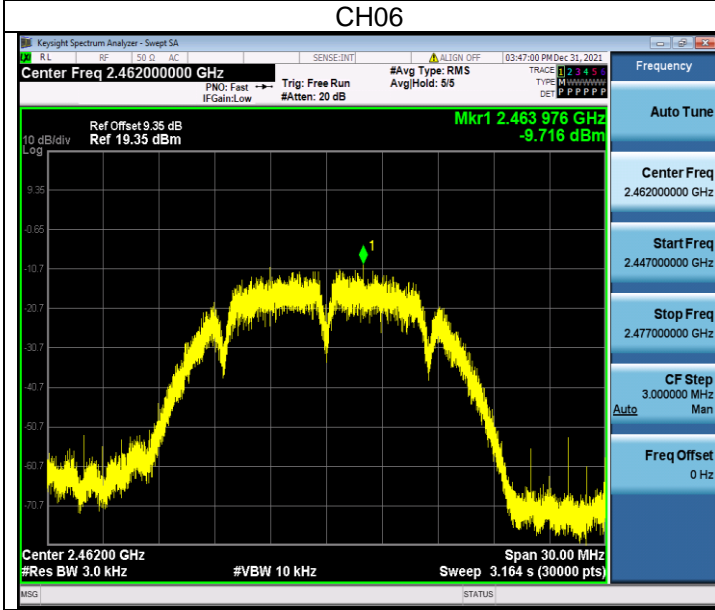
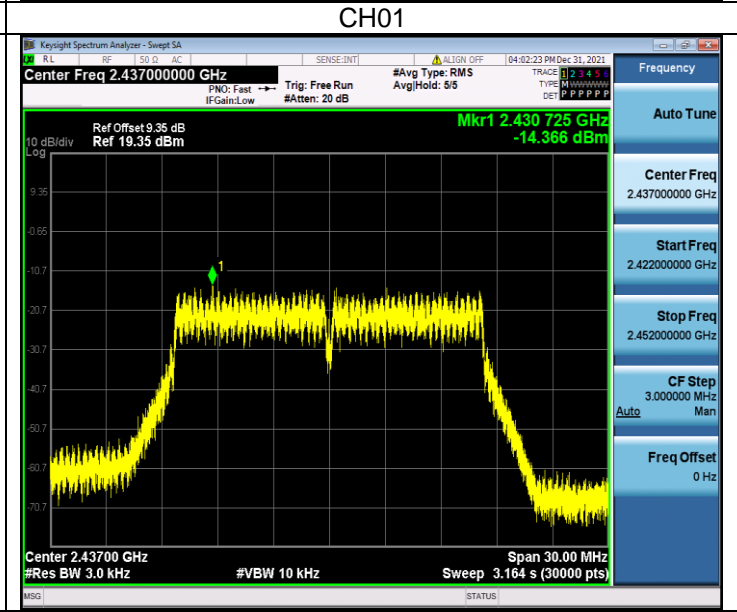
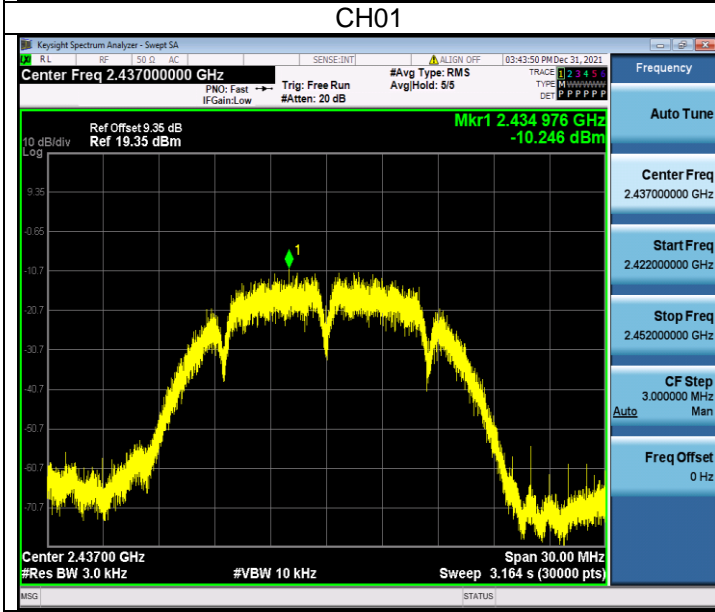
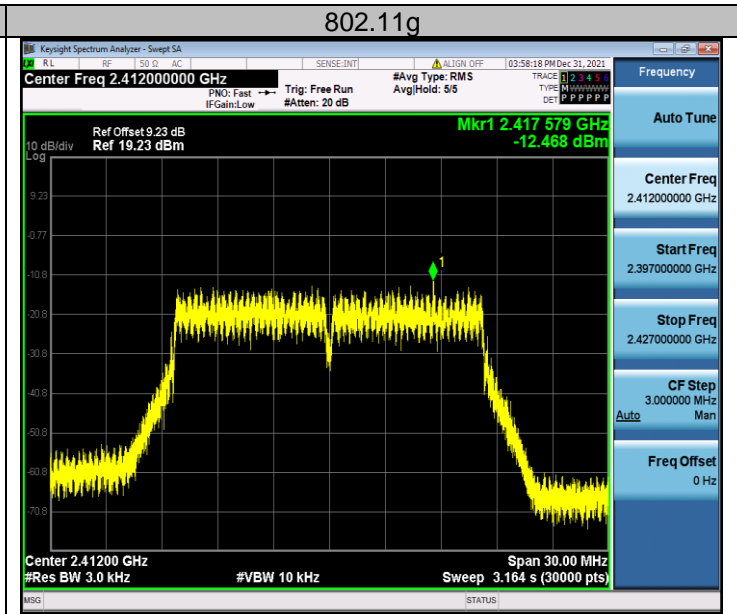
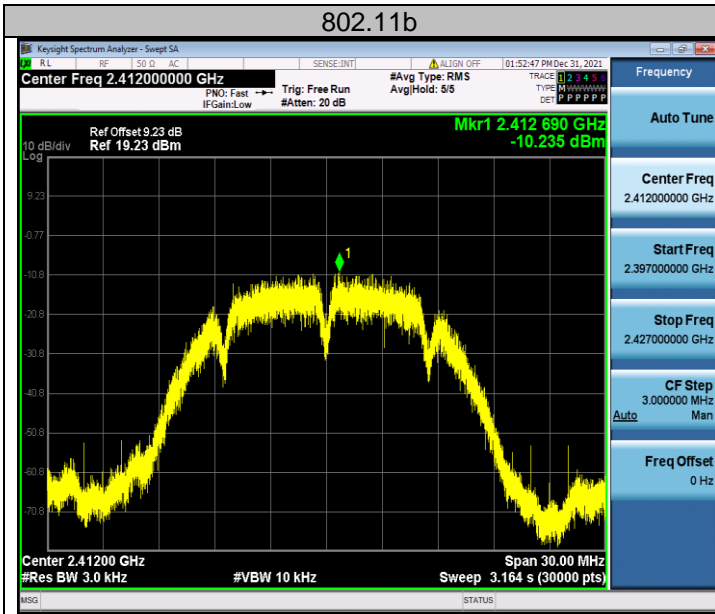

CH11

CH11

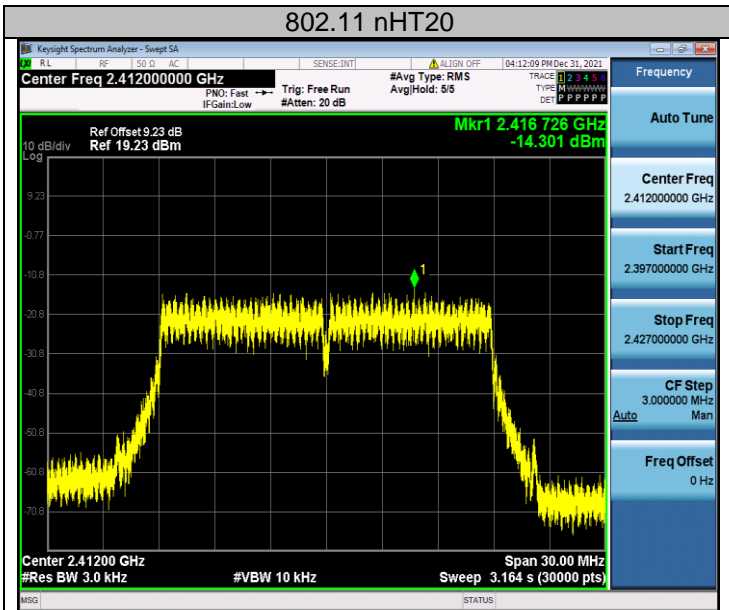

| |
|---------------------------------|
| Frequency |
| Auto Tune |
| Center Freq 2.41200000 GHz |
| Start Freq 2.397000000 GHz |
| Stop Freq 2.427000000 GHz |
| CF Step 3.000000 MHz Auto |
| Freq Offset 0 Hz |

CH01

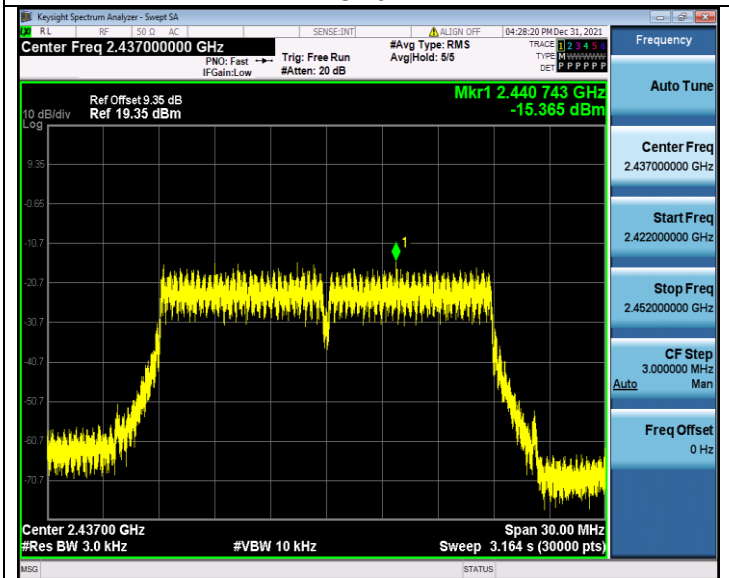

| |
|---------------------------------|
| Frequency |
| Auto Tune |
| Center Freq 2.437000000 GHz |
| Start Freq 2.422000000 GHz |
| Stop Freq 2.452000000 GHz |
| CF Step 3.000000 MHz Auto |
| Freq Offset 0 Hz |

CH06

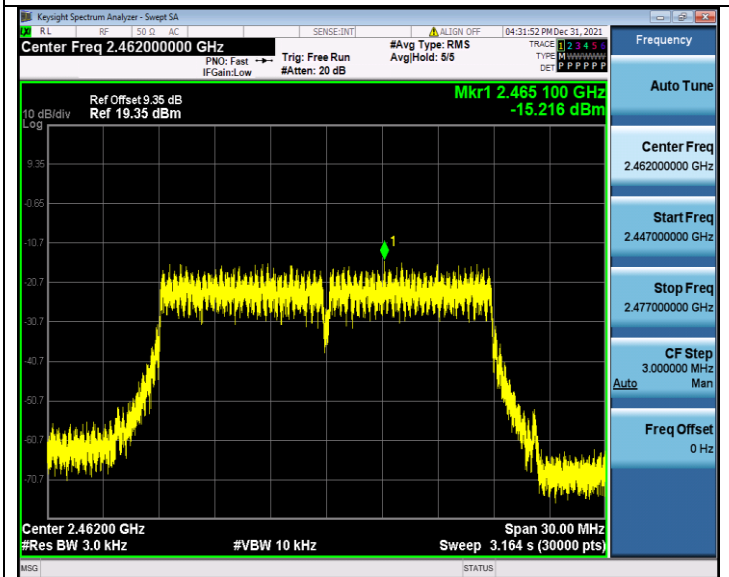

| |
|---------------------------------|
| Frequency |
| Auto Tune |
| Center Freq 2.462000000 GHz |
| Start Freq 2.447000000 GHz |
| Stop Freq 2.477000000 GHz |
| CF Step 3.000000 MHz Auto |
| Freq Offset 0 Hz |

CH11

4.5. 6dB Bandwidth

TEST CONFIGURATION

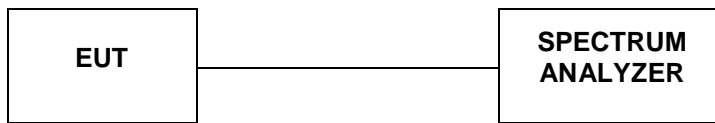

TEST PROCEDURE

The transmitter output was connected to the spectrum analyzer through an attenuator. The bandwidth of the fundamental frequency was measured by spectrum analyzer with RBW=100 KHz and VBW=300KHz. The 6dB bandwidth is defined as the total spectrum the power of which is higher than peak power minus 6dB. According to KDB558074 D01 for one of the following procedures may be used to determine the modulated DTS device signal bandwidth.

1. Set RBW = 100 kHz.
2. Set the video bandwidth (VBW) ≥ 3 RBW.
3. Detector = Peak.
4. Trace mode = max hold.
5. Sweep = auto couple.
6. Allow the trace to stabilize.
7. Measure the maximum width of the emission that is constrained by the frequencies associated with the two outermost amplitude points (upper and lower frequencies) that are attenuated by 6 dB relative to the maximum level measured in the fundamental emission.

LIMIT

For digital modulation systems, the minimum 6 dB bandwidth shall be at least 500 kHz

TEST RESULTS

| | | | |
|---------------|-----------|----------------|------------------|
| Temperature | 23.4°C | Humidity | 52.7% |
| Test Engineer | Oliver Ou | Configurations | IEEE 802.11b/g/n |

| Type | Channel | 6dB Bandwidth (MHz) | Limit (KHz) | Result |
|-------------|---------|---------------------|-------------|--------|
| 802.11b | 01 | 10.160 | ≥500 | Pass |
| | 06 | 10.160 | | |
| | 11 | 10.120 | | |
| 802.11g | 01 | 16.440 | ≥500 | Pass |
| | 06 | 16.480 | | |
| | 11 | 16.440 | | |
| 802.11nHT20 | 01 | 17.640 | ≥500 | Pass |
| | 06 | 17.680 | | |
| | 11 | 17.720 | | |

802.11b

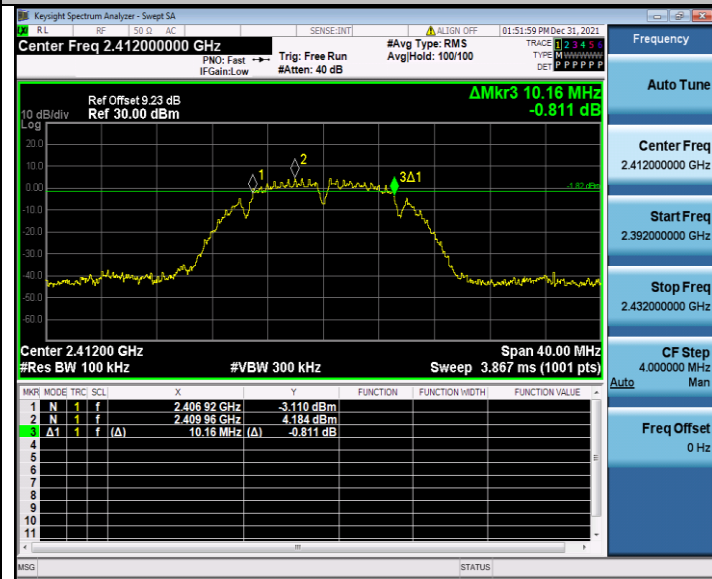

CH01

802.11g

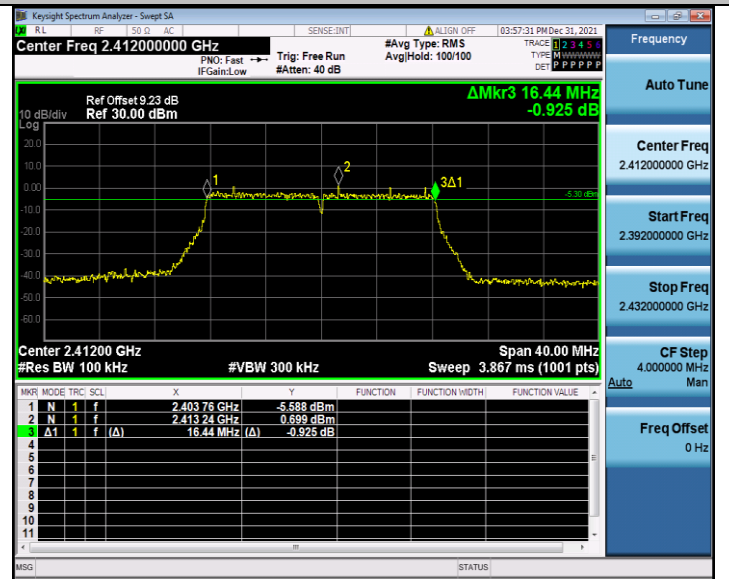

CH01

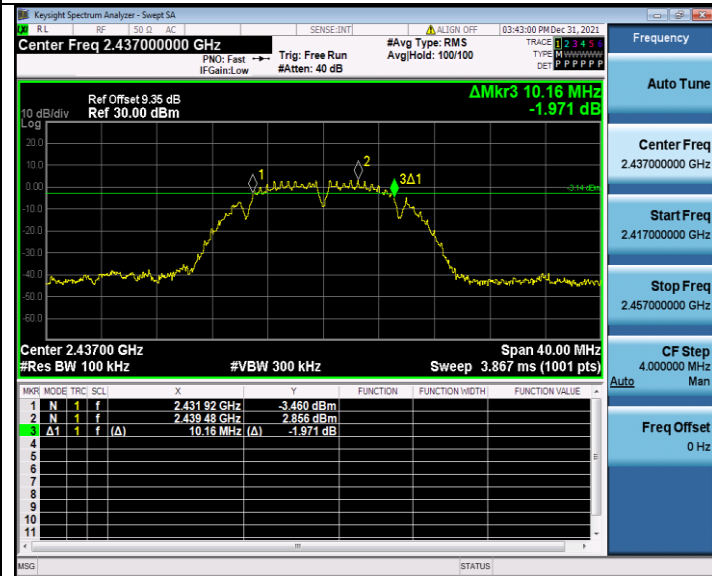

CH06

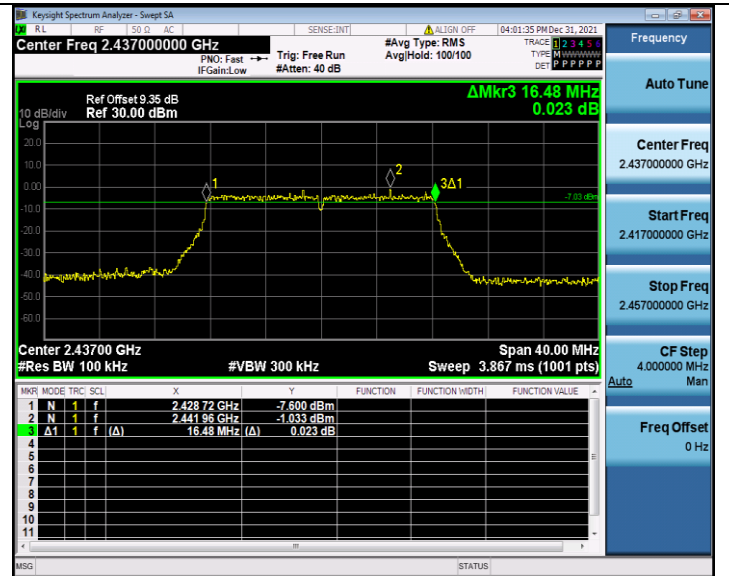

CH06

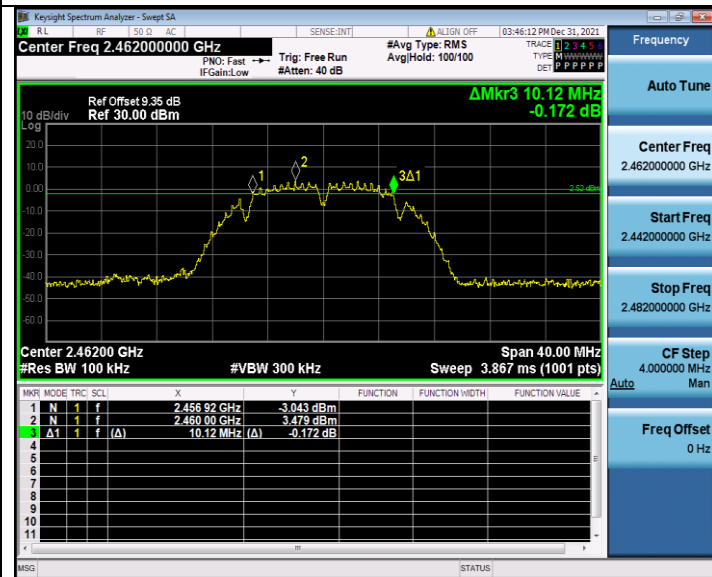

CH11

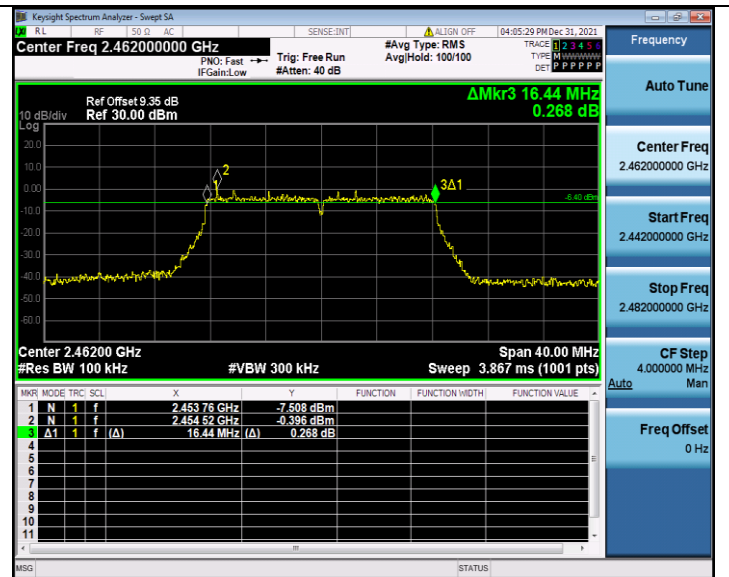

CH11

802.11n HT20

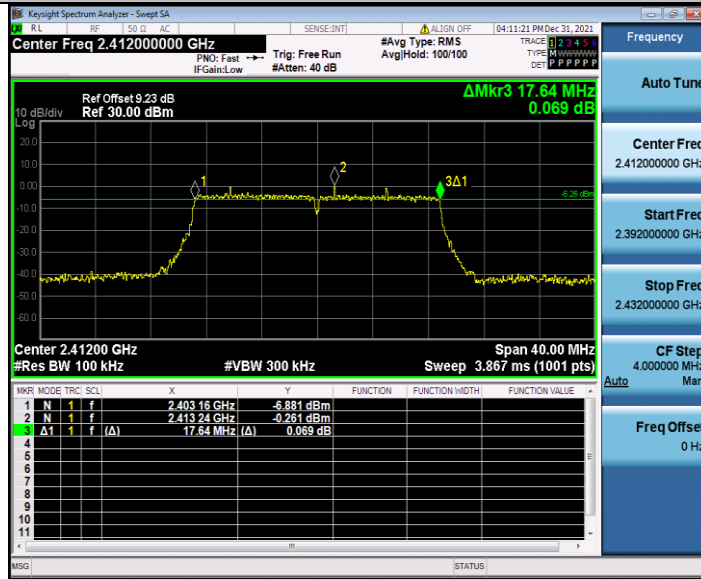

CH01

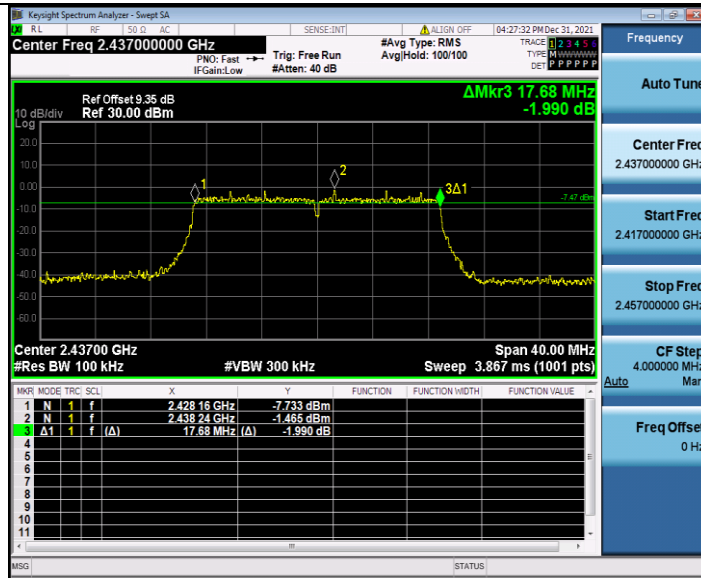

CH06

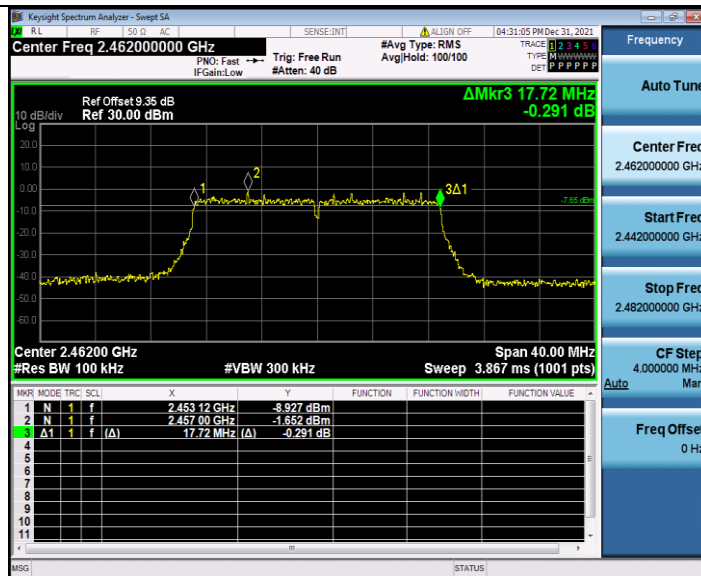

CH11

4.6. Band Edge Compliance of RF Emission

TEST REQUIREMENT

In any 100 kHz bandwidth outside the frequency band in which the spread spectrum or digitally modulated intentional radiator is operating, the radio frequency power that is produced by the intentional radiator shall be at least 20 dB below that in the 100 kHz bandwidth within the band that contains the highest level of the desired power, based on either an RF conducted or a radiated measurement, provided the transmitter demonstrates compliance with the peak conducted power limits. If the transmitter complies with the conducted power limits based on the use of RMS averaging over a time interval, as permitted under paragraph (b)(3) of this section, the attenuation required under this paragraph shall be 30 dB instead of 20 dB. Attenuation below the general limits specified in §15.209(a) is not required. In addition, radiated emissions which fall in the restricted bands, as defined in §15.205(a), must also comply with the radiated emission limits specified in §15.209(a) (see §15.205(c)).

TEST PROCEDURE

According to KDB 558074 D01 for Antenna-port conducted measurement. Antenna-port conducted measurements may also be used as an alternative to radiated measurements for demonstrating compliance in the restricted frequency bands. If conducted measurements are performed, then proper impedance matching must be ensured and an additional radiated test for cabinet/case spurious emissions is required.

1. Check the calibration of the measuring instrument using either an internal calibrator or a known signal from an external generator.
2. Remove the antenna from the EUT and then connect to a low loss RF cable from the antenna port to a EMI test receiver, then turn on the EUT and make it operate in transmitting mode. Then set it to Low Channel and High Channel within its operating range, and make sure the instrument is operated in its linear range.
3. Set both RBW and VBW of spectrum analyzer to 100 kHz with a convenient frequency span including 100kHz bandwidth from band edge, for Radiated emissions restricted band RBW=1MHz, VBW=3MHz for peak detector and RBW=1MHz, VBW=10Hz for average detector.
4. Measure the highest amplitude appearing on spectral display and set it as a reference level. Plot the graph with marking the highest point and edge frequency.
5. Repeat above procedures until all measured frequencies were complete.
6. Measure the conducted output power (in dBm) using the detector specified by the appropriate regulatory agency (see 12.2.2, 12.2.3, and 12.2.4 for guidance regarding measurement procedures for determining quasi-peak, peak, and average conducted output power, respectively).
7. Add the maximum transmit antenna gain (in dBi) to the measured output power level to determine the EIRP level (see 12.2.5 for guidance on determining the applicable antenna gain)
8. Add the appropriate maximum ground reflection factor to the EIRP level (6 dB for frequencies \leq 30 MHz, 4.7 dB for frequencies between 30 MHz and 1000 MHz, inclusive and 0 dB for frequencies $>$ 1000 MHz).
9. For devices with multiple antenna-ports, measure the power of each individual chain and sum the EIRP of all chains in linear terms (e.g., Watts, mW).
10. Convert the resultant EIRP level to an equivalent electric field strength using the following relationship:

$$E = \text{EIRP} - 20\log D + 104.8$$

where:

E = electric field strength in dB μ V/m,

EIRP = equivalent isotropic radiated power in dBm

D = specified measurement distance in meters.

11. Since the out-of-band characteristics of the EUT transmit antenna will often be unknown, the use of a conservative antenna gain value is necessary. Thus, when determining the EIRP based on the measured conducted power, the upper bound on antenna gain for a device with a single RF output shall be selected as the maximum in-band gain of the antenna across all operating bands, or 2 dBi, whichever is greater. However, for devices that operate in multiple frequency bands while using the same transmit antenna, the highest gain of the antenna within the operating band nearest in frequency to the restricted band emission being measured may be used in lieu of the overall highest gain when the emission is at a frequency that is within 20 percent of the nearest band edge frequency, but in no case shall a value less than 2 dBi be used.
12. Compare the resultant electric field strength level to the applicable regulatory limit.
13. Perform radiated spurious emission test dures until all measured frequencies were complete.

LIMIT

Below -20dB of the highest emission level in operating band.

Radiated emissions which fall in the restricted bands, as defined in § 15.205(a), must also comply with the radiated emission limits specified in § 15.209(a).

TEST RESULTS

4.6.1 For Radiated Bandedge Measurement

| | | | |
|---------------|-----------|----------------|------------------|
| Temperature | 23.8°C | Humidity | 53.7% |
| Test Engineer | Oliver Ou | Configurations | IEEE 802.11b/g/n |

Horizontal (802.11b-2412MHz)

Test Graph

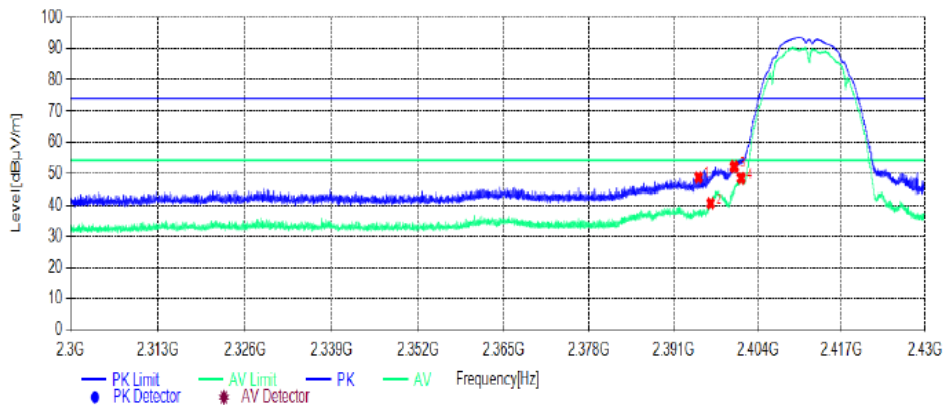

Suspected List

| NO. | Frequency [MHz] | Factor [dB] | Margin [dB] | Height [cm] | Angle [°] | Detector | Polarity | Remark |
|-----|-----------------|-------------|-------------|-------------|-----------|----------|------------|--------|
| 1 | 2394.8575 | 4.27 | 25.40 | 150 | 150 | PK | Horizontal | PASS |
| 2 | 2396.7297 | 4.27 | 13.44 | 150 | 230 | AV | Horizontal | PASS |
| 3 | 2400.3570 | 4.28 | 21.98 | 150 | 250 | PK | Horizontal | PASS |
| 4 | 2401.4361 | 4.28 | 5.63 | 150 | 160 | AV | Horizontal | PASS |

Note: 1. Result (dBµV/m) = Reading(dBµV/m) + Factor (dB) .

2. Factor (dB) = Antenna Factor (dB/m) + Cable loss (dB) - Pre Amplifier gain (dB).

Horizontal (802.11b-2462MHz)

Test Graph

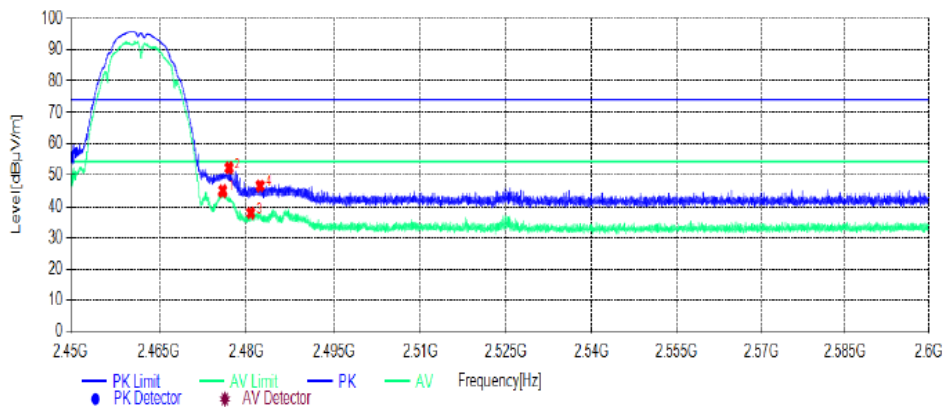

Suspected List

| NO. | Frequency [MHz] | Factor [dB] | Margin [dB] | Height [cm] | Angle [°] | Detector | Polarity | Remark |
|-----|-----------------|-------------|-------------|-------------|-----------|----------|------------|--------|
| 1 | 2475.9076 | 4.59 | 9.21 | 150 | 230 | AV | Horizontal | PASS |
| 2 | 2476.9877 | 4.59 | 21.91 | 150 | 120 | PK | Horizontal | PASS |
| 3 | 2480.7081 | 4.61 | 16.05 | 150 | 210 | AV | Horizontal | PASS |
| 4 | 2482.3282 | 4.62 | 27.68 | 150 | 140 | PK | Horizontal | PASS |

Note: 1. Result (dBµV/m) = Reading(dBµV/m) + Factor (dB) .

2. Factor (dB) = Antenna Factor (dB/m) + Cable loss (dB) - Pre Amplifier gain (dB).

Vertical(802.11b-2412MHz)

Test Graph

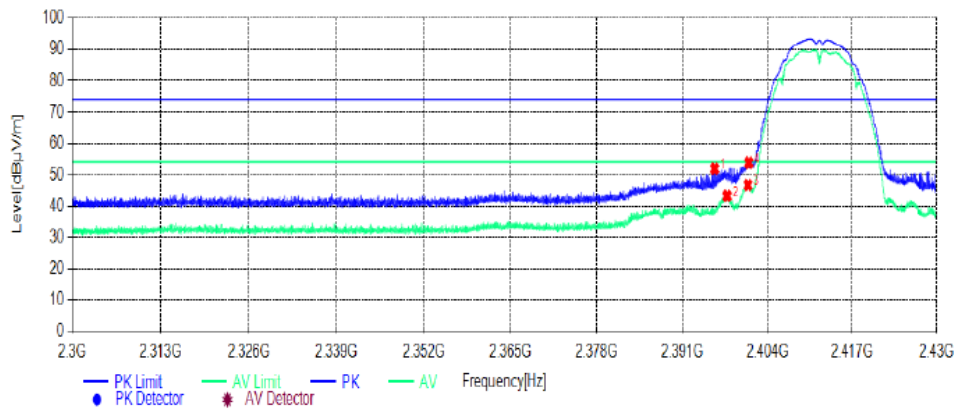

Suspected List

| NO. | Frequency [MHz] | Factor [dB] | Margin [dB] | Height [cm] | Angle [°] | Detector | Polarity | Remark |
|-----|-----------------|-------------|-------------|-------------|-----------|----------|----------|--------|
| 1 | 2395.9496 | 4.27 | 22.11 | 150 | 250 | PK | Vertical | PASS |
| 2 | 2397.8348 | 4.27 | 10.84 | 150 | 190 | AV | Vertical | PASS |
| 3 | 2401.0461 | 4.28 | 7.32 | 150 | 120 | AV | Vertical | PASS |
| 4 | 2401.1631 | 4.28 | 20.22 | 150 | 190 | PK | Vertical | PASS |

Note: 1. Result (dBµV/m) = Reading(dBµV/m) + Factor (dB) .

2. Factor (dB) = Antenna Factor (dB/m) + Cable loss (dB) - Pre Amplifier gain (dB).

Vertical(802.11b-2462MHz)

Test Graph

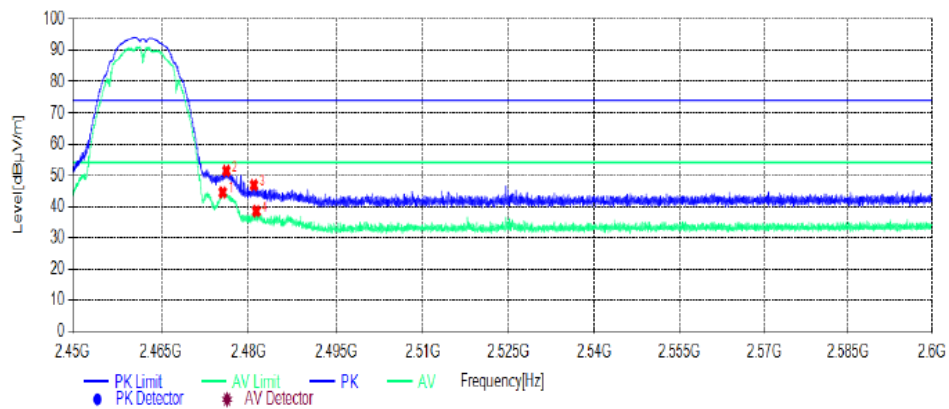

Suspected List

| NO. | Frequency [MHz] | Factor [dB] | Margin [dB] | Height [cm] | Angle [°] | Detector | Polarity | Remark |
|-----|-----------------|-------------|-------------|-------------|-----------|----------|----------|--------|
| 1 | 2475.5476 | 4.58 | 9.51 | 150 | 50 | AV | Vertical | PASS |
| 2 | 2476.1476 | 4.59 | 22.61 | 150 | 50 | PK | Vertical | PASS |
| 3 | 2480.8731 | 4.62 | 27.17 | 150 | 40 | PK | Vertical | PASS |
| 4 | 2481.3081 | 4.62 | 15.58 | 150 | 30 | AV | Vertical | PASS |

Note: 1. Result (dBµV/m) = Reading(dBµV/m) + Factor (dB) .

2. Factor (dB) = Antenna Factor (dB/m) + Cable loss (dB) - Pre Amplifier gain (dB).

NOTE: All the modes have been tested and recorded worst mode in the report.

4.6.2 For Conducted Bandedge Measurement

| | | | |
|---------------|-----------|----------------|------------------|
| Temperature | 23.4°C | Humidity | 52.7% |
| Test Engineer | Oliver Ou | Configurations | IEEE 802.11b/g/n |

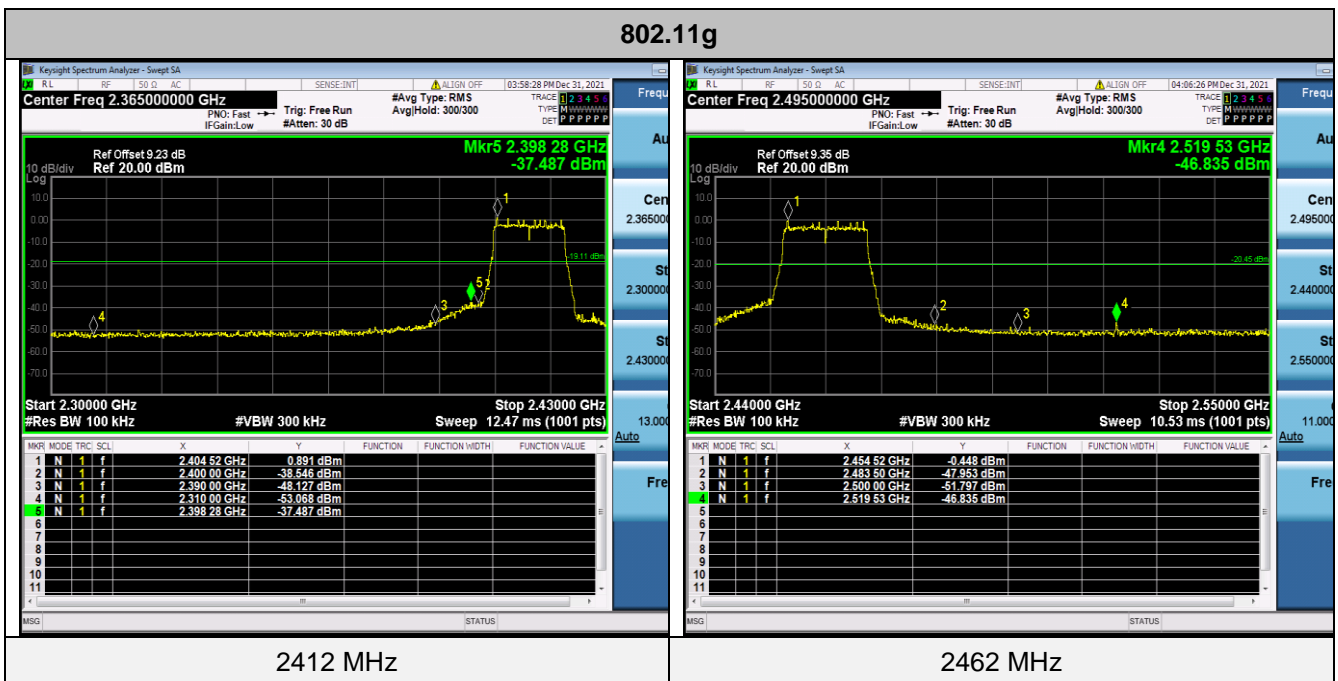
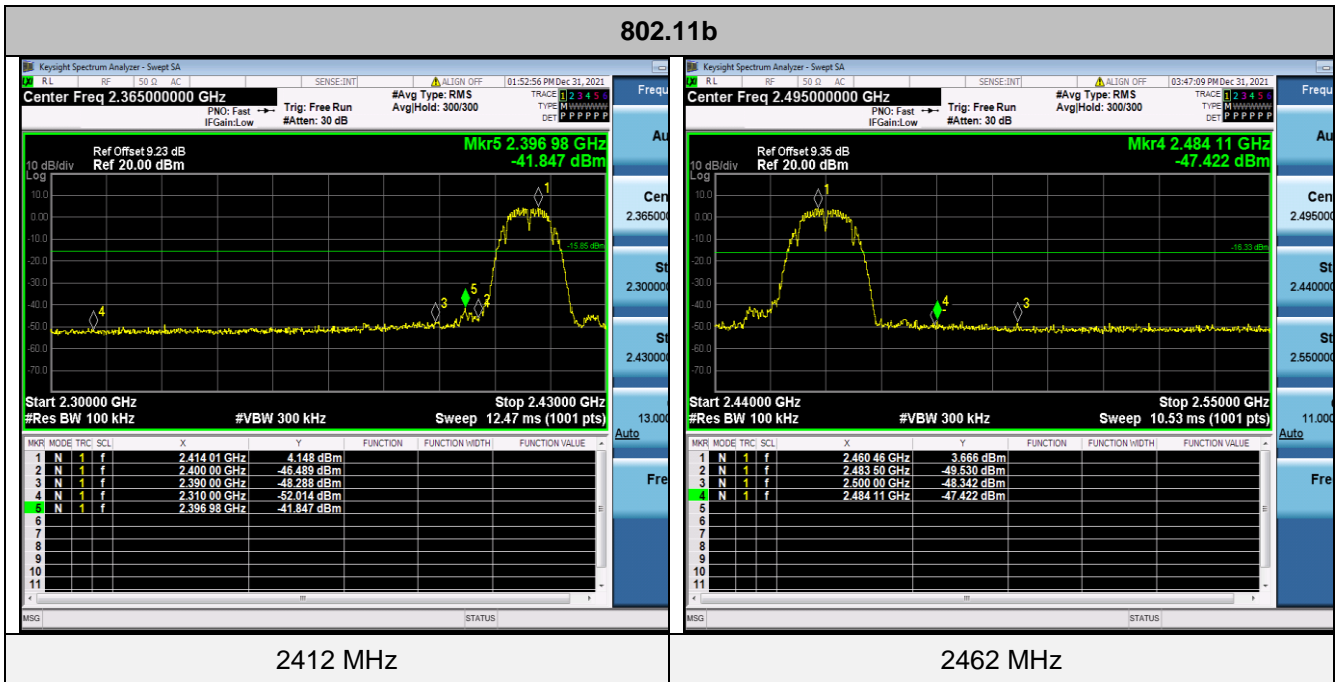

802.11n HT20

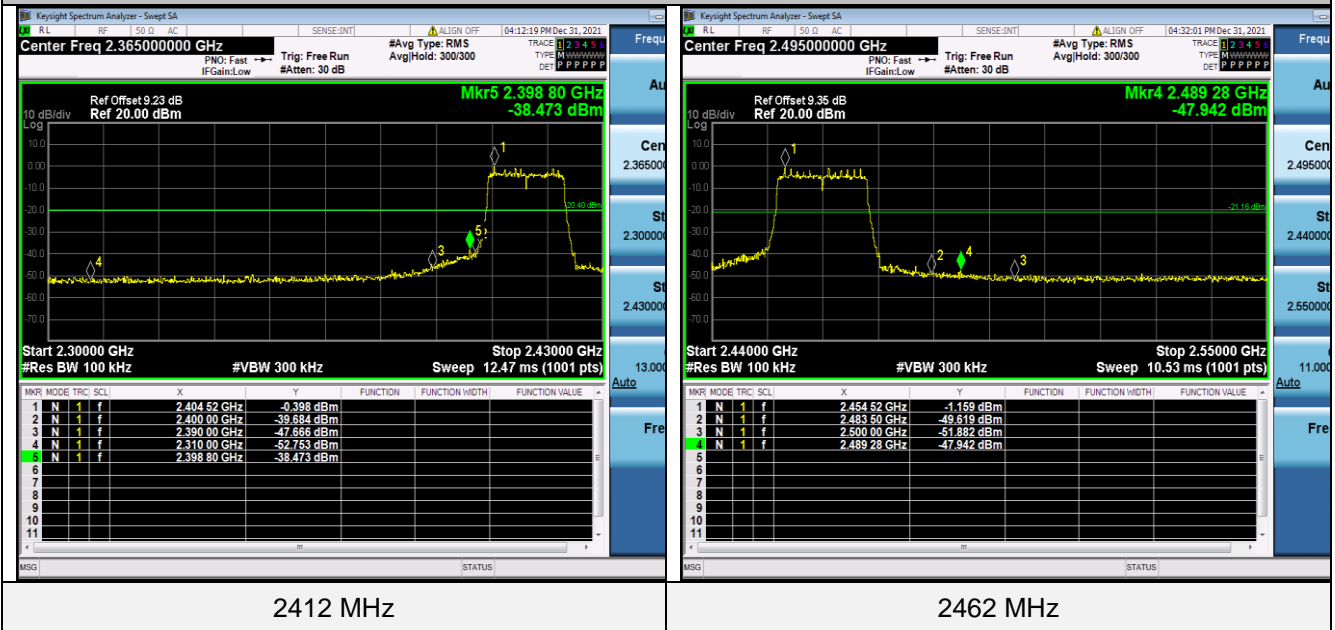

4.7. Antenna Requirement

Standard Applicable

For intentional device, according to FCC 47 CFR Section 15.203, an intentional radiator shall be designed to ensure that no antenna other than that furnished by the responsible party shall be used with the device.

And according to FCC 47 CFR Section 15.247 (c), if transmitting antennas of directional gain greater than 6dBi are used, the power shall be reduced by the amount in dB that the directional gain of the antenna exceeds 6dBi.

Antenna Information

The antenna is FPC Aantenna, through the buckle stretched out, The directional gains of antenna used for transmitting is 2.92dBi.

Reference to the **Internal photos**.

5. TEST SETUP PHOTOS OF THE EUT

Adapter: TPA-46B050100UU

Radiated Emission

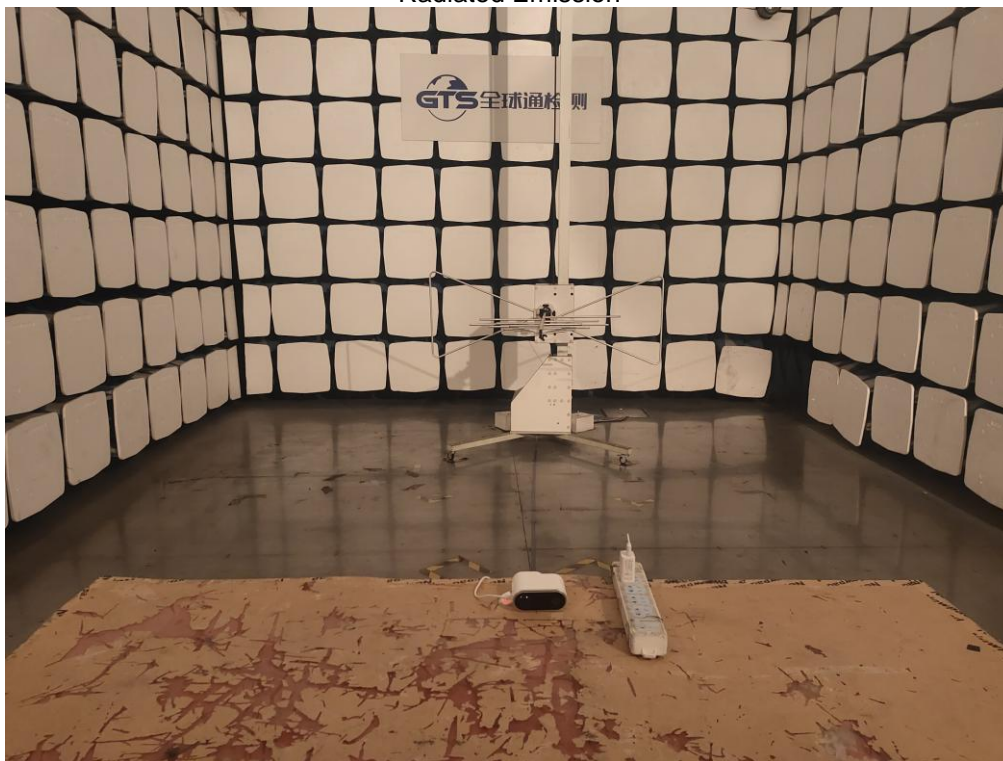

Conducted Emission



Adapter:GTA92-0501000US

Radiated Emission

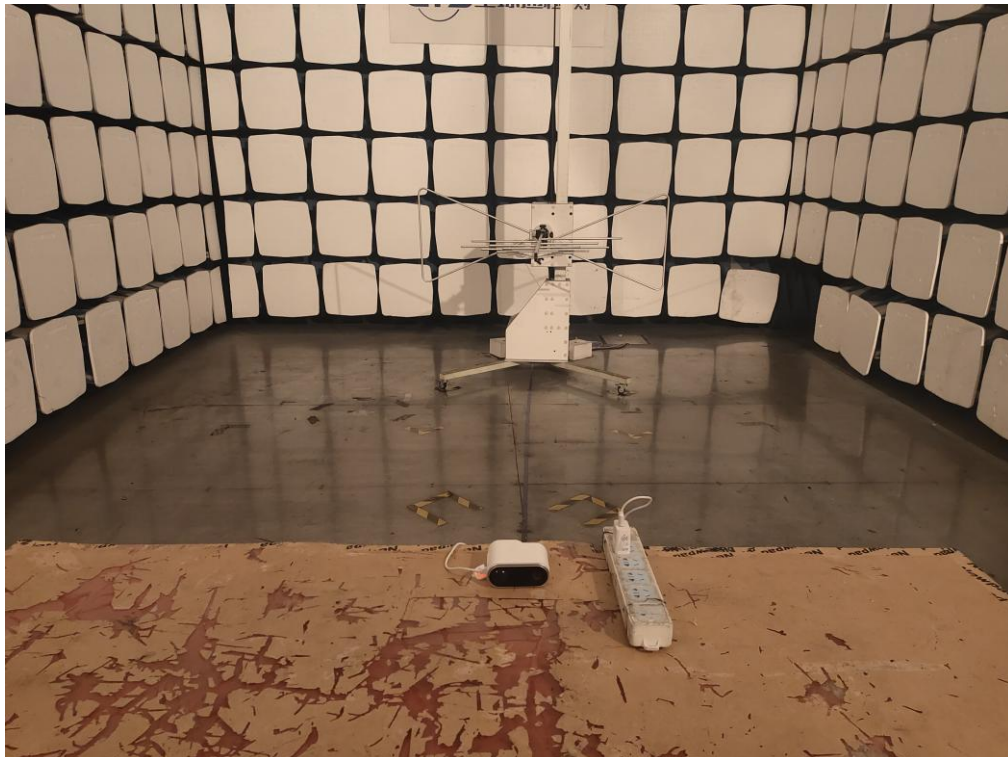



Conducted Emission

