

# Mini 12S

ORIGINALITY DESIGN SMART AND BEAUTIFUL

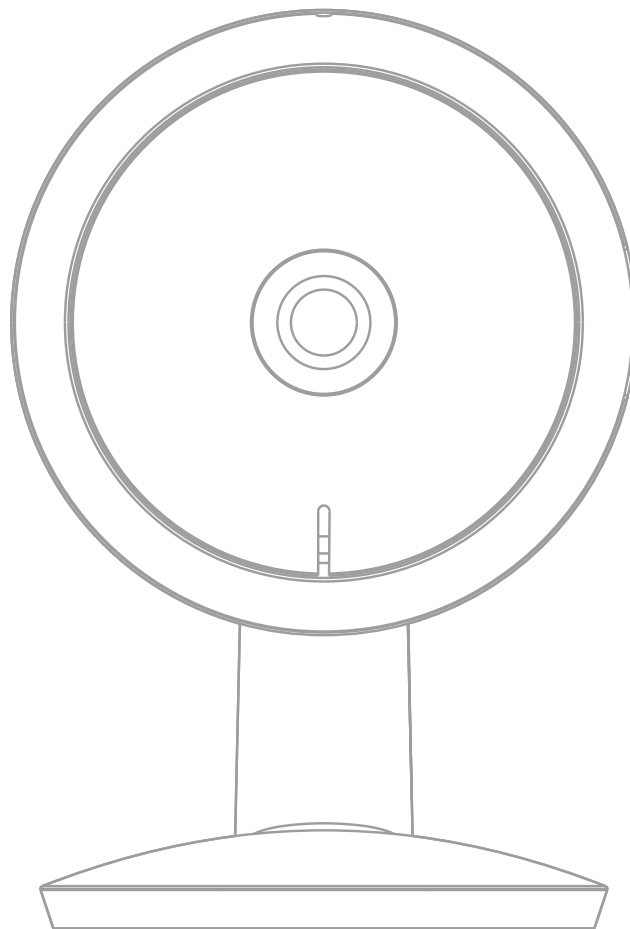

# QUICK GUIDE



Consult the checklist below for all components.

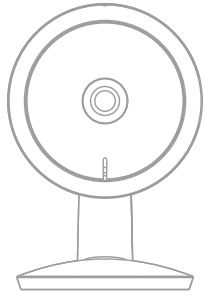

Mini 12S

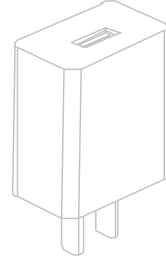

Power adapter

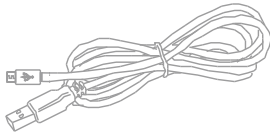

USB cable

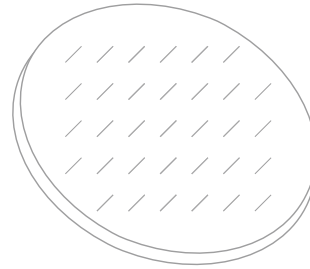

Adhesive tape

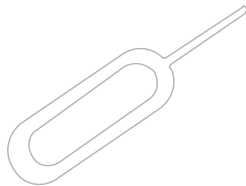

Pin

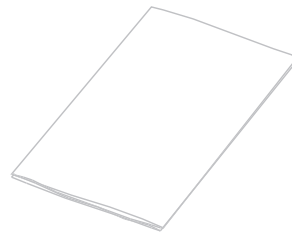

Manual

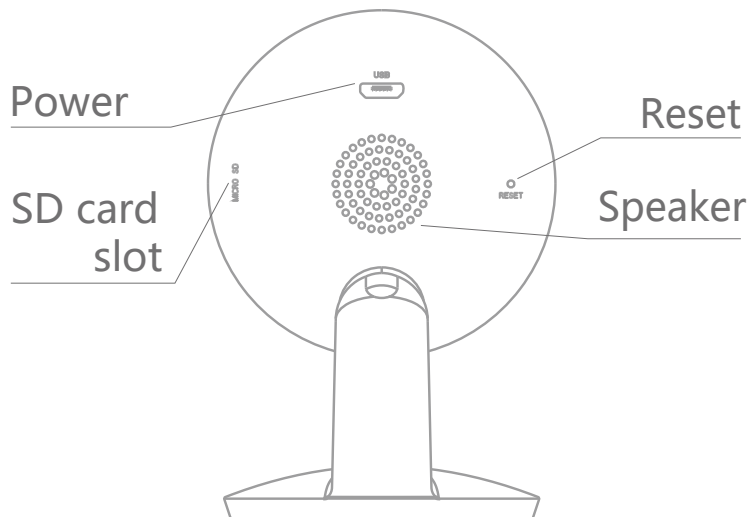
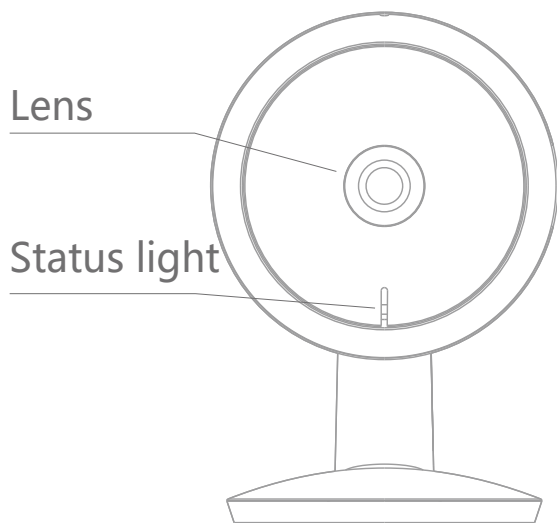

Power	DC5V±10%
Status light	<ul style="list-style-type: none"> <li>• Red light solids on: network is abnormal</li> <li>• Blinking red light: wait for network connection (slowly blinking) connecting the network (quickly blinking)</li> <li>• Solid blue light on: the camera is working correctly</li> </ul>
Microphone	Captures sounds for your video
SD card slot	Supports local SD Card storage (Max.128GB)
Reset	Press and hold the 'RESET' for 5 seconds with pin to reset the device(Camera will return to factory defaults)

- 1 Stick the adhesive tape in the middle of camera bottom

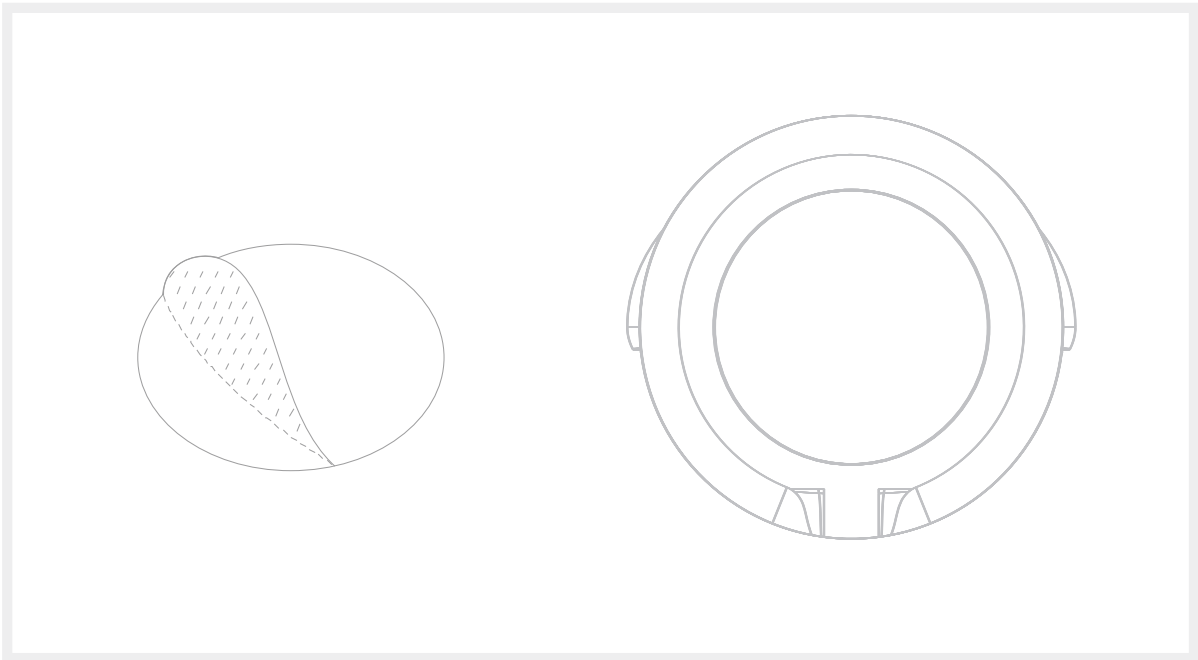

- 2 Put the camera on the clean plane

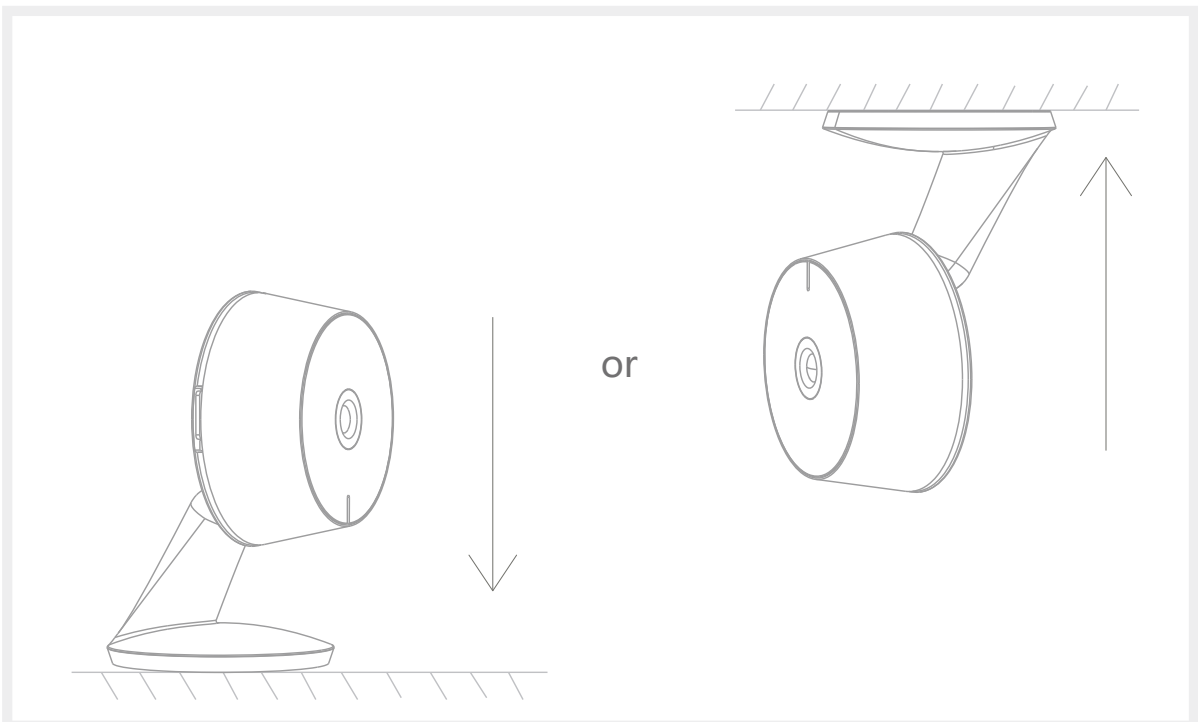

## Download

CloudEdge is available for both iOS and Android OS. Search the name 'CloudEdge' in App Store or Google Play, or scan the QR-Code to download the App.

·Support

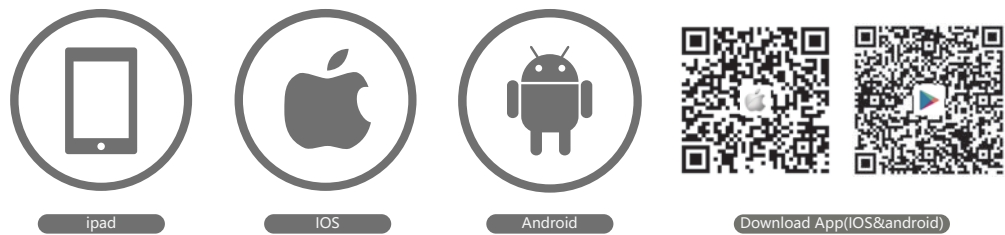

## Add camera

Log in the CloudEdge, select "Add Camera", and add the smart camera to the App according to the screen tips(Make the smart camera close to the router when configuring).

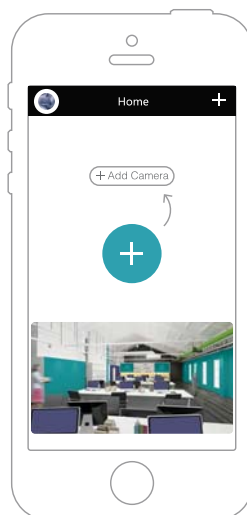

**NOTE:** If you need to re-select the WiFi network, please press and hold the "RESET" button for 5 seconds, the device will restart, and the indicator will be flashing red.

Q: The device cannot be previewed properly?

A: Check whether the network is normal, you can place the camera close to the router, and if not, it is recommended to reset the device and add it again.

Q: Why is it still in the list of devices after resetting?

A: The reset device only resets the network configuration of the camera, but cannot change the configuration on the App, remove the camera, and must be deleted by the App.

Q: How to cut the camera network to another router?

A: First remove and reset the device on the App and then configure the device again by the App.

Q: Why doesn't the device identify the SD card?

A: It is recommended to plug in SD card after power cut. Confirm whether the SD card is normally available and the format is FAT32. And the TF card can't be identified when the internet environment is not good.

Q: Why I can't get the notifications with my cell phone App?

A: Please confirm that the App has been running on the phone, and the relevant reminder function has been opened; Message notification and authority confirmation in the mobile phone system have been opened.

## Video flip

Flip your video stream vertically anytime for maximum flexibility.

## Motion detection

Motion sensors will notify you when movement is detected.

## Record

Record every moment using high capacity SD card storage.

## Daytime & Night

Powerful night vision means no interruptions, even in complete darkness.



Daytime



Night

## FCC Statement

This equipment has been tested and found to comply with the limits for a Class B digital device, pursuant to part 15 of the FCC Rules. These limits are designed to provide reasonable protection against harmful interference in a residential installation. This equipment generates, uses and can radiate radio frequency energy and, if not installed and used in accordance with the instructions, may cause harmful interference to radio communications. However, there is no guarantee that interference will not occur in a particular installation. If this equipment does cause harmful interference to radio or television reception, which can be determined by turning the equipment off and on, the user is encouraged to try to correct the interference by one or more of the following measures:

- Reorient or relocate the receiving antenna.
- Increase the separation between the equipment and receiver.
- Connect the equipment into an outlet on a circuit different from that to which the receiver is connected.
- Consult the dealer or an experienced radio/TV technician for help.

## FCC Radiation Exposure Statement

This device complies with FCC radiation exposure limits set forth for an uncontrolled environment and it also complies with Part 15 of the FCC RF Rules. This equipment must be installed and operated in accordance with provided instructions and the antenna(s) used for this transmitter must be installed to provide a separation distance of at least 20 cm from all persons and must not be co-located or operating in conjunction with any other antenna or transmitter. End-users and installers must be provide with antenna installation instructions and consider removing the no-collocation statement.

This device complies with Part 15 of the FCC Rules. Operation is subject to the following two conditions: (1) this device may not cause harmful interference, and (2) this device must accept any interference received, including interference that may cause undesired operation.

## Caution!

Any changes or modifications not expressly approved by the party responsible for compliance could void the user's authority to operate the equipment.