

Bullet 2S

ORIGINALITY DESIGN SMART AND BEAUTIFUL



QUICK GUIDE



What's in the box

Consult the checklist below for all components.

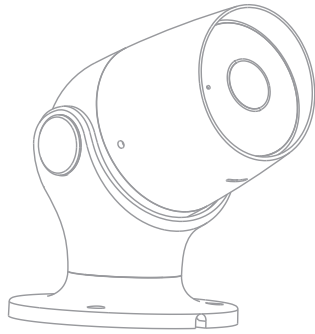

Bullet 2S

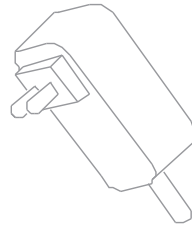

Power adapter



Screws

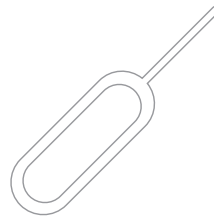

Pin

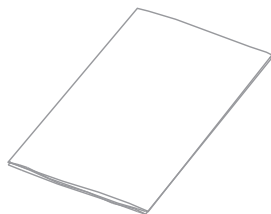

I/M

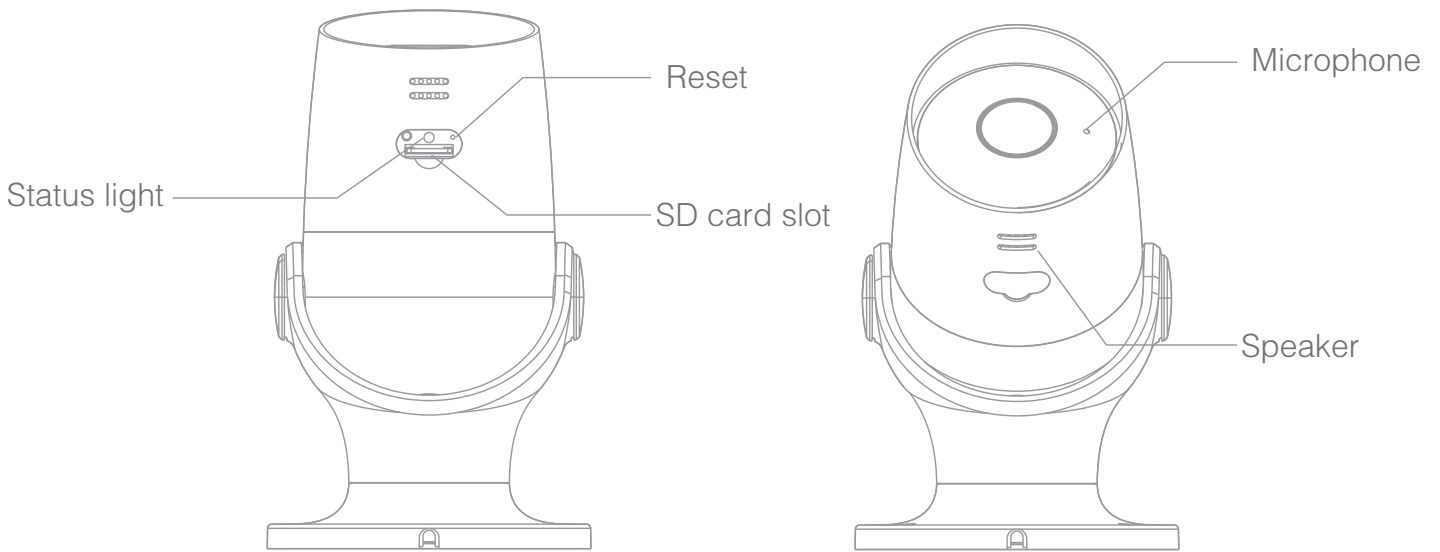

Description

Power DC12V \pm 10%

Status light

- Red light solid on: the camera network is abnormal
- Blinking red light: awaiting WiFi connection, or currently connecting (faster blinking)
- Blue light solid on: camera running correctly
- Blinking blue light: awaiting manual WiFi configuration, or currently connecting (faster blinking)

Microphone Captures sound for your video

SD card Supports local SD Card storage (Max 128G)

Speaker Speaker speak with the app and it will revert too

Reset Press and hold for 5 seconds with pin to reset the camera (if you have modified settings, they will return to factory defaults)
Pressing for 1 second will activate manual WiFi setup mode

Install

1 Fix the Camera to the wall with screws

2 Adjust camera angle to a correct view
(as shown in the picture)

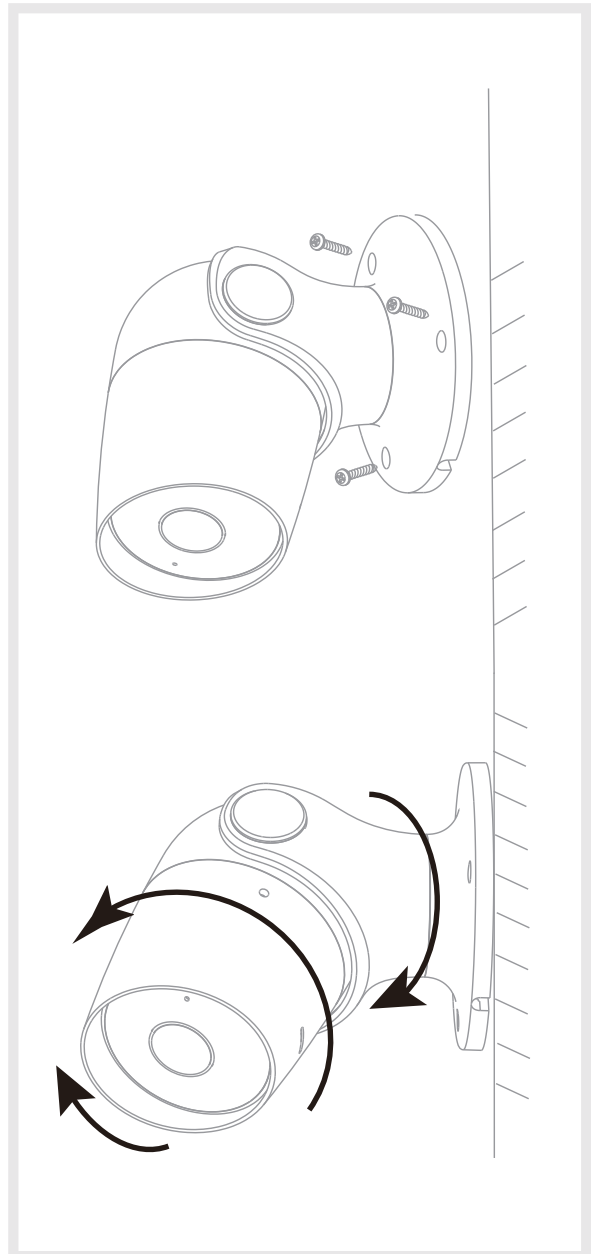

Connect

Download

CloudEdge is available for both iOS and Android OS. Search the name 'CloudEdge' in App Store or Android Market, or scan upper QR-Code to download the App.

• Support

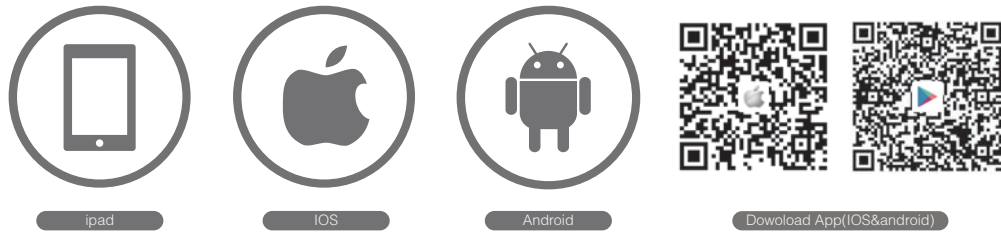

Set up router

This product only supports 2.4GHz frequency band router, does not support 5GHz frequency band router, please set the relevant parameters of the router before WiFi configuration, WiFi passwords do not include special characters such as ~!@#\$\$%^&*(). When the device is configured in WiFi, the mobile phone and device are as close as to the router, which can speed up the configuration of the device.



Registration process

Step 1 Open the CloudEdge App, click 'SIGN UP', input a valid email address and select 'registration means agreement with user agreement privacy agreement' then click 'NEXT'.

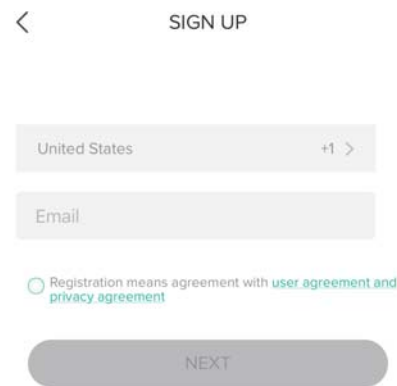
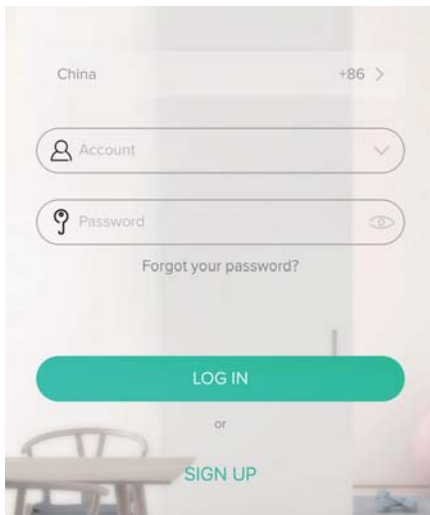

Step 2 Enter the email address and click 'OK', create a nickname and login password.

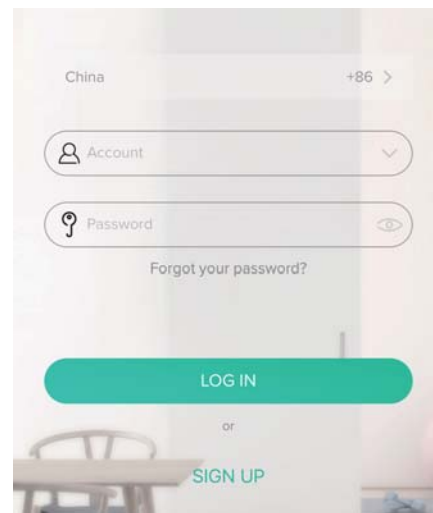
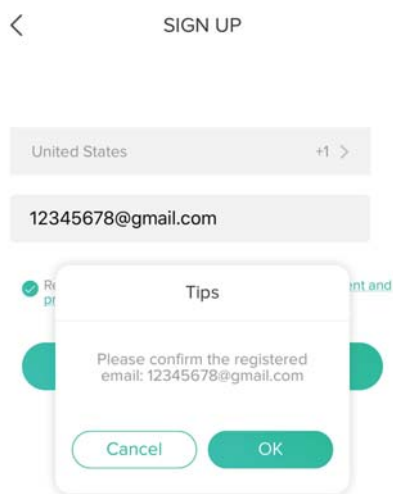

Note: Make sure your router, device, and mobile phone are nearby.

QR Code Configuration

Few notices before adding the device

1. This device only supports 2.4GHz WiFi router, please make sure you are using a 2.4GHz WiFi router.
2. Please follow the instructions and make sure the password is inputed correctly.
3. One device can only be added with one App account, if the device has been added with another account already, then it can't be added to any another account again.

Process

Step 1 Open the CloudEdge App, click '+', and select the type of device to add.

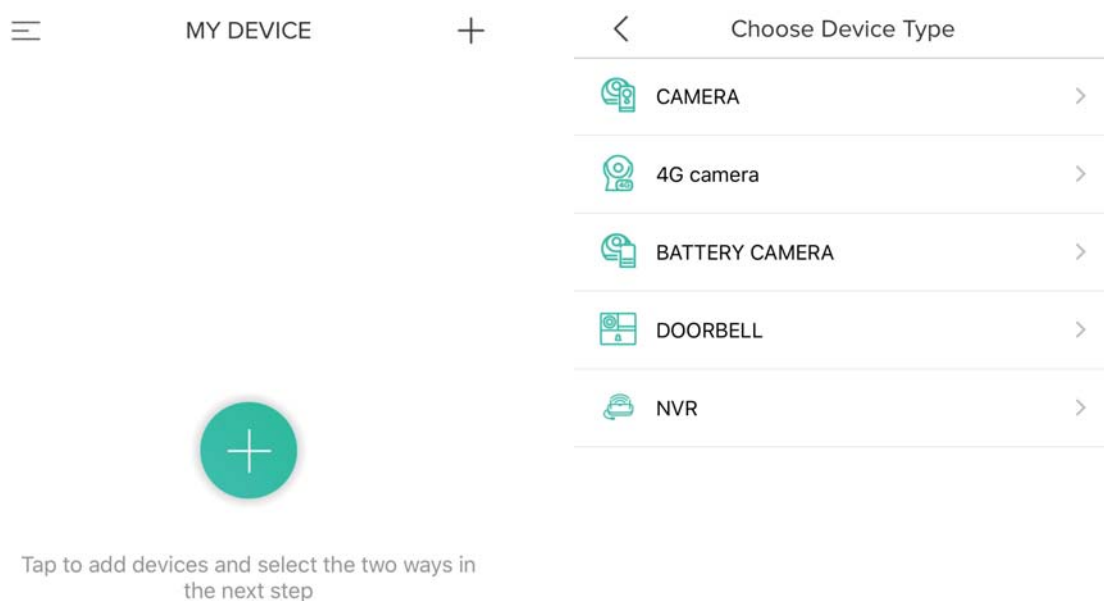

Step 2 Please confirm the red LED light blinks, select 'The device has flashed red slowly or you hear a tone', click 'Next'. Then input the wireless password, click 'Next'.



1. After powering on the device, wait until the device starts
2. Make sure the status indicator changes from steady red to slow red, or hear the device prompt: "Please configure wireless network for camera".

[Descriptions for Status light](#)

- The device has flashed red slowly or you hear a tone

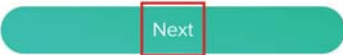

Please fill in the wireless network to be connected
Please ensure that the mobile phone is connected to the 2.4G WIFI network.

XXXXXXX [Change WiFi](#)

●●●●●●

[Show password](#)



Step 3 The device is scanning the QR code at a distance of 15~25cm (you can click the 'operation' to view the scanning mode). After the device scans successfully, click 'Hear tone'.

Equipment scanning QR code
The distance between the two-dimension code is about 15~25cm, and the device scans the two-dimensional code and it will send a tone



[Did not hear the tone](#) [Hear tone](#)



Please point the QR code in the screen of the mobile phone towards the device and keep the distance of about 15~25cm. Wait for the device to scan the QR code on the mobile phone.

Step 4 The device is successfully connected to the network. After the configuration is completed, the App automatically adds the successfully scanned device, and return to the device list. The configuration is completed.

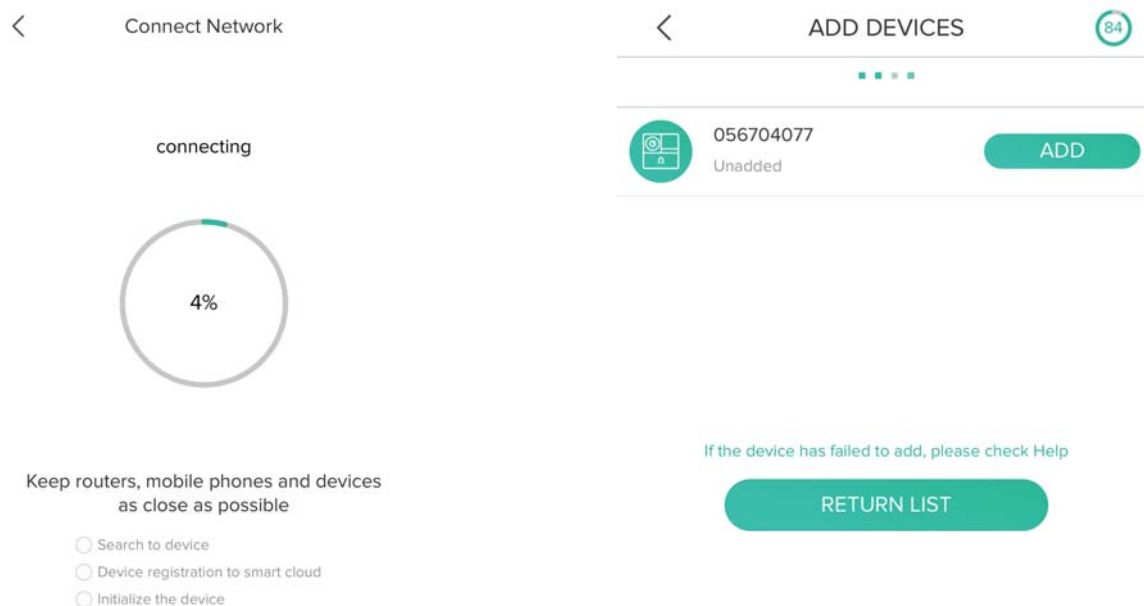

Step 5 Click the play button to complete the preview. (Remind: long press the image to be previewed to remove the device, add device again to reset the device)

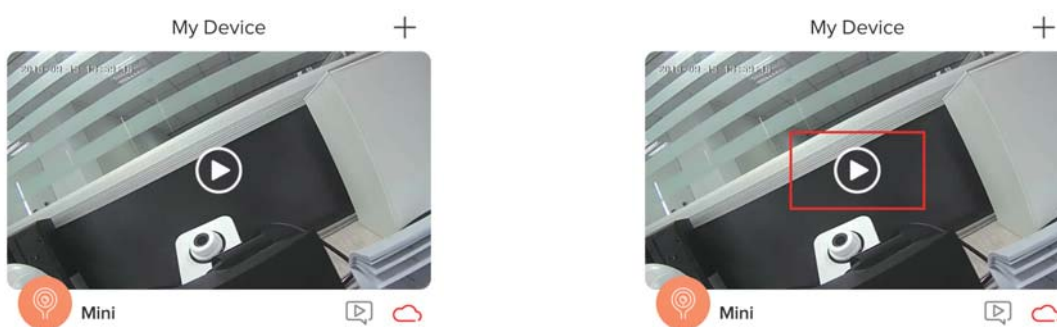

Functions

Video flip

Flip your video stream up or down for maximum flexibility.

Motion detection

Built-in motion sensors detect movement, and the camera will send you push notifications and app alerts.

Record

Support 24H continuous recording with high capacity SD storage.

Daytime & Night

Never miss a moment, even in complete darkness, with powerful night-vision technology.

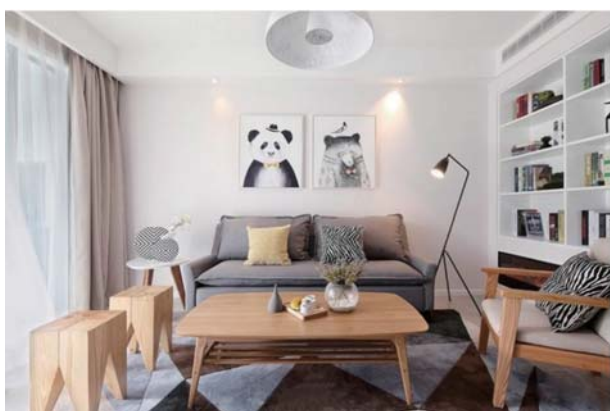

Daytime



Night

Q: The device cannot be previewed properly?

A: Check whether the network is normal, you can place the camera close to the router, and if not, it is recommended to reset the device and add it again.

Q: Why is it still in the list of devices after resetting?

A: The reset device only resets the network configuration of the camera, but cannot change the configuration on the App, remove the camera, and must be deleted by the App.

Q: How to cut the camera network to another router?

A: First remove and reset the device on the App and then configure the device again by the App.

Q: Why doesn't the device identify the SD card?

A: It is recommended to plug in SD card after power cut. Confirm whether the SD card is normally available and the format is FAT32. And the TF card can't be identified when the internet environment is not good.

Q: Why I can't get the notifications with my cell phone App?

A: Please confirm that the App has been running on the phone, and the relevant reminder function has been opened; Message notification and authority confirmation in the mobile phone system have been opened.

FCC Statement:

Any Changes or modifications not expressly approved by the party responsible for compliance could void the user's authority to operate the equipment.

This device complies with part 15 of the FCC Rules. Operation is subject to the following two conditions:

- (1) This device may not cause harmful interference, and
- (2) this device must accept any interference received, including interference that may cause undesired operation.

FCC Radiation Exposure Statement:

This equipment complies with FCC radiation exposure limits set forth for an uncontrolled environment. This equipment should be installed and operated with minimum distance 20cm between the radiator and your body.

Note: This equipment has been tested and found to comply with the limits for a Class B digital device, pursuant to part 15 of the FCC Rules. These limits are designed to provide reasonable protection against harmful interference in a residential installation. This equipment generates uses and can radiate radio frequency energy and, if not installed and used in accordance with the instructions, may cause harmful interference to radio communications. However, there is no guarantee that interference will not occur in a particular installation. If this equipment does cause harmful interference to radio or television reception, which can be determined by turning the equipment off and on, the user is encouraged to try to correct the interference by one or more of the following measures:

- Reorient or relocate the receiving antenna.
- Increase the separation between the equipment and receiver.
- Connect the equipment into an outlet on a circuit different from that to which the receiver is connected.
- Consult the dealer or an experienced radio/TV technician for help.