

# Bell 9S

ORIGINALITY DESIGN SMART - AND BEAUTIFUL

DOOR BELL

CE FC

## QUICK GUIDE

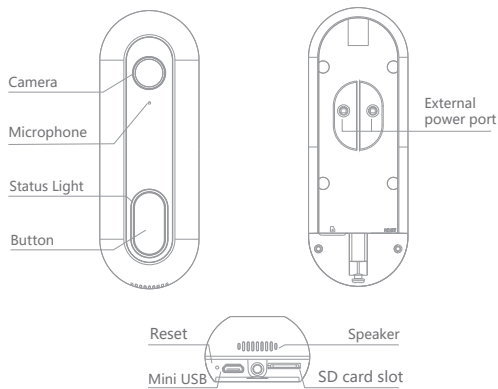
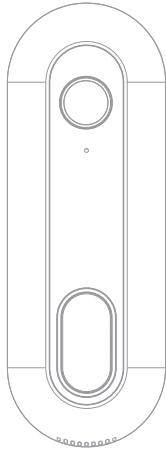

### Description

Power Port	AC 12V~24V/DC 5V
Doorbell button	Press the button to activate the doorbell
Status light	<ul style="list-style-type: none"> <li>Red light solids on: the camera or network is abnormal</li> <li>Red light blinking: awaiting WiFi connection</li> <li>Blue light solids on: camera running correctly</li> </ul>
Microphone	Captures sound for your video
SD card slot	Supports local SD Card storage (Max.128G)
Reset	Press and hold on for 5 seconds with pin to reset the doorbell

2

## What's in the box

Please consult this checklist for all parts.

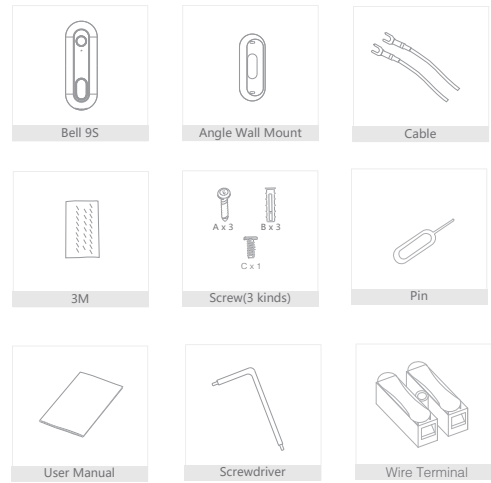

1

## Install

### Mode 1 Doorbell General Installation

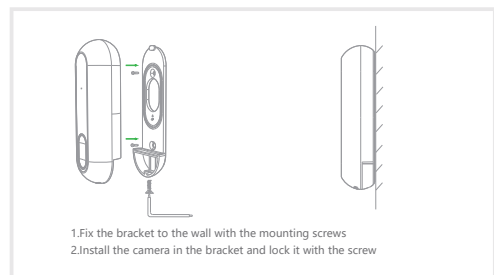

### Mode 2 Angle Wall Mount + Bracket + Doorbell Installation

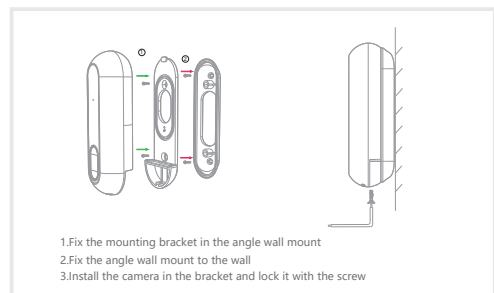

3

## Connect

### Download

Smart Life is available for both iOS and Android OS. Search the name "Smart Life" in App Store or Android Market, or scan the QR-Code to download the App.

Support



### Set up router

The router supports the 2.4GHz WiFi (doesn't support the 5GHz), and is connected to the WiFi network. Please set the parameters of the router before connecting the WiFi network, and record the SSID and password of your WiFi.

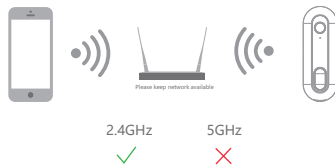

4

## QR Code Configuration

- 1 Open the Smart Life App, click "Create family", and you can customize the Family name and related settings.

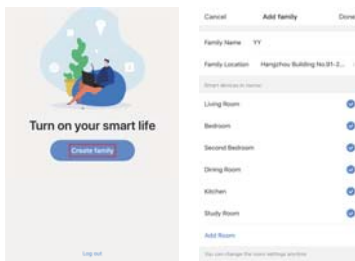

- 2 Continue to click "Security & Sensor" >> "Smart Camera", and then choose "Add Device" or "+", ready to add camera.

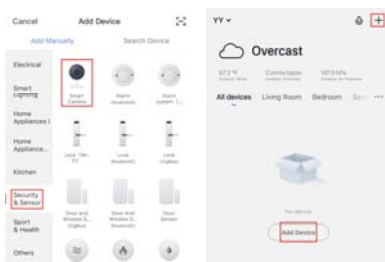

6

### Registration process

- Step 1 Open the Smart Life App, click "Register", read the "Privacy Policy" and click "Agree".

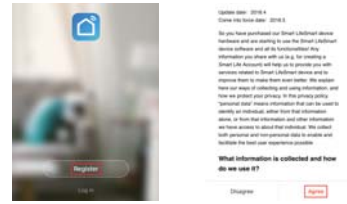

- Step 2 Input a legal and valid Mobile number or Email address and click "Continue". Input Verification Code, then log in the app.



5

- 3 In "Add Device" this interface, continue to click "next step", and then you should input your WiFi's passwords.

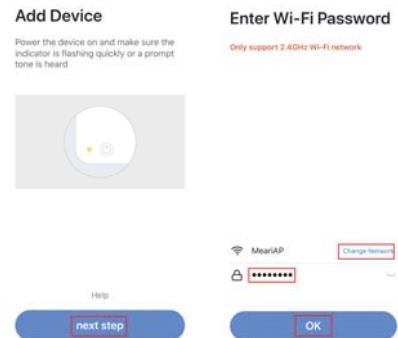

Note:

- 1) Camera only supports 2.4GHz WiFi network.
- 2) The number of bits in the ssid and passwords of the router should not exceed 24 digits.

7

- 4 In this interface, you should scan the QR code in your phone with the camera, when the camera comes out "dong dong dong". And you can complete the configuration about 30s.



8

- 5 When connecting, you should make sure your router, mobile, and camera are as close as possible. When camera added successfully, click "✔". You could also DIY the camera's name.

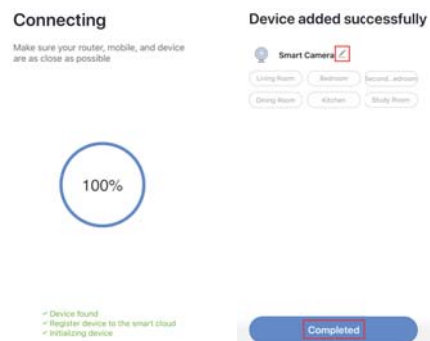

9

## Settings

In "Smart Camera" interface, click "✔", you can set the camera common functions.

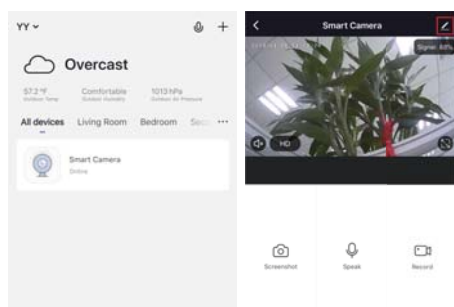

10

## Functions

### Full-duplex audio

When the visitor pushes the doorbell button, you will get a call. You can see and hear the visitor in your App from the doorbell if you answer.

### Motion detection

Motion sensors will notify you when movement is detected.

### Shared device

The doorbell device can be shared with friends, and friends can also preview online. There is no limit to the number of sharing devices, but only 6 accounts are supported for online preview at the same time.

### Record

Record every moment by using high capacity SD card storage.

### Day & Night

Powerful night vision means no interruptions, even in complete darkness.



Daytime



Night

11

## FAQ

Q: In the network process, the process bar is always not 100%, add failure?

A: This camera only supports 2.4GHz WiFi router, please make sure you are using a 2.4GHz WiFi router. And confirm the WiFi password again.

Q: Repeated additions are failures?

A: After adding a failure, it is recommended to restart the device or power off, and then try to add again.

Q: The device cannot be previewed properly?

A: Check whether the network is normal, you can place the camera close to the router, and if not, it is recommended to reset the device and add it again.

Q: How to cut the camera network to another router?

A: First remove and reset the device on the App and then configure the device again by the App.

Q: Why I can't get the notifications with my cell phone App?

A: Please confirm that the App has been running on the phone, and the relevant reminder function has been opened; Message notification and authority confirmation in the mobile phone system have been opened.

Q: Why doesn't the device identify the SD card?

A: It is recommended to plug in SD card after power cut. Confirm whether the SD card is normally available and the format is FAT32. And the TF card can't be identified when the internet environment is not good.

12

## Mechanical Chime Installation

**Step 1** First turn off the power breaker at your fuse box for your existing doorbell and mechanical chime. Ring your doorbell again to confirm it is now off.

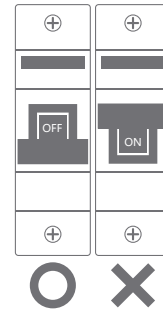

**Step 2** Find your mechanical chime that is a rectangular box, produces the sound when your doorbell is pressed. It may (or may not) be mounted immediately inside your FRONT door. And remove the cover.

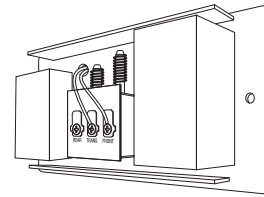

13

## Mechanical Chime Installation

**Step 3** Slightly unscrew both screw terminals and one hook from the Chime Kit under each screw (It does not matter which color wire from the Chime Kit connects to which screw).

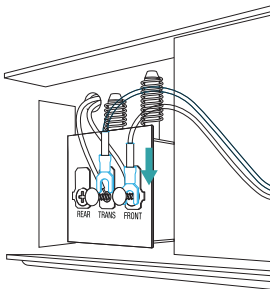

Locate the Chime Kit included in the smart doorbell's packaging, and the terminals on the inside of the chime. Connect one of the Chime Kit's prongs to the transformer terminal (usually labeled TRANS, T, AC, or 0). Connect the other prong to the chime's front terminal (usually labeled FRONT, F, 1, or C1). Either prong on the Chime Kit can be connected to either of the terminals on the chime.

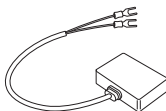

14

## Mechanical Chime Installation

**Step 4** Using the included double-sided tape, affix the Chime Kit to your chime wherever there is space and replace the cover. Be careful not to interfere with any of the chime's moving parts.

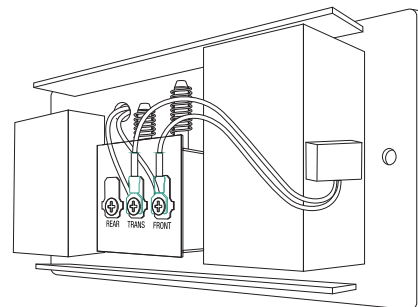

Ensure that the Chime Kit and wires DO NOT interfere with the mechanical parts of the chime. Mount on the outside of the chime if there is not enough room to mount inside. And replace your chime's cover.

15



Note: If the wires coming out from your home are too short you can use the included Wire Terminal. Take existing doorbell wire from your home, plug into included crimp connector, then plug into wire extender.

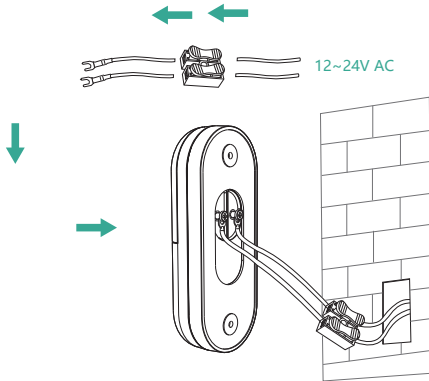

Turn the doorbell power back on at the fuse box. The light on the doorbell button should turn on and after a few minutes become red slowly.

**FCC Statement**  
 Any Changes or modifications not expressly approved by the party responsible for compliance could void the user's authority to operate the equipment.  
 This device complies with part 15 of the FCC Rules. Operation is subject to the following two conditions: (1) This device may not cause harmful interference, and (2) This device must accept any interference received, including interference that may cause undesired operation.  
**FCC Radiation Exposure Statement:**  
 This equipment complies with FCC radiation exposure limits set forth for an uncontrolled environment. This equipment should be installed and operated with minimum distance 20cm between the radiator & your body.

**IMPORTANT NOTE:**  
 Note: This equipment has been tested and found to comply with the limits for a Class B digital device, pursuant to part 15 of the FCC Rules. These limits are designed to provide reasonable protection against harmful interference in a residential installation. This equipment generates, uses and can radiate radio frequency energy and, if not installed and used in accordance with the instructions, may cause harmful interference to radio communications. However, there is no guarantee that interference will not occur in a particular installation. If this equipment does cause harmful interference to radio or television reception, which can be determined by turning the equipment off and on, the user is encouraged to try to correct the interference by one or more of the following measures:  
 —Reorient or relocate the receiving antenna.  
 —Increase the separation between the equipment and receiver.  
 —Connect the equipment into an outlet on a circuit different from that to which the receiver is connected.  
 —Consult the dealer or an experienced radio/TV technician for help.

## EXPLANATION

1. First, to be clear about which kind of Chime to be used? Then please power on the doorbell after installation of Chime. Ensure that you have selected the right type of Chime in App (Mechanical Chime).

2. Mechanical Chime only can be used along with Chime Kit. You have to follow the steps for installation of Chime kit and also need to set "Mechanical Chime" in app if you want to continue with your existing mechanical chime.