

Bell 5S

ORIGINALITY DESIGN SMART - AND BEAUTIFUL



DOOR BELL

CE FC 

QUICK GUIDE

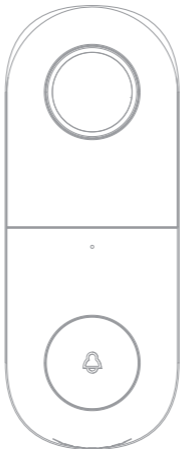

What's in the box

Please consult this checklist for all parts.



Bell 5S



Bracket



Chime Kit



Angle Wall Mount



Screw(4 kinds)



Pin



Screwdriver



3M



Manual

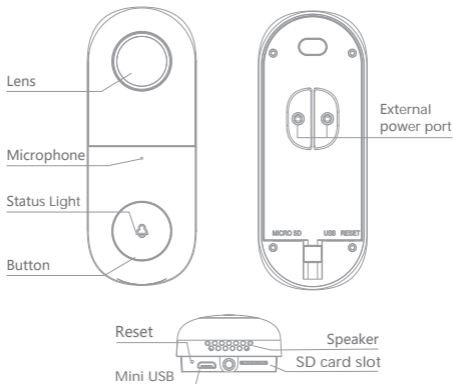

Power Port AC/DC 12-24V& 5V/1A

Doorbell button Press the button to activate the doorbell

Status light

- Red light solids on: the camera or network is abnormal
- Red light blinking: awaiting WiFi connection, or currently connecting (faster blinking)
- Blue light solids on: camera running correctly

Microphone Captures sound for your video

SD card slot Supports local SD Card storage (Max.128G)

Reset Press and hold on for 5 seconds with pin to reset the doorbell

- Step 1** First turn off the power breaker at your fuse box for your existing doorbell and mechanical chime. Ring your doorbell again to confirm it is now off.

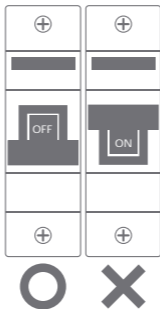

- Step 2** Find your mechanical chime that is a rectangular box, produces the sound when your doorbell is pressed. It may (or may not) be mounted immediately inside your FRONT door. And remove the cover.

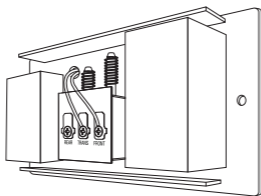

(Example of a Mechanical Chime)

- Step 3** Slightly unscrew both screw terminals and one hook from the Chime Kit under each screw (It does not matter which color wire from the Chime Kit connects to which screw).

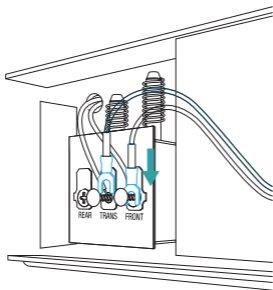

Locate the Chime Kit included in the smart doorbell's packaging, and the terminals on the inside of the chime. Connect one of the Chime Kit's prongs to the transformer terminal (usually labeled TRANS, T, AC, or 0). Connect the other prong to the chime's front terminal (usually labeled FRONT, F1, or C1). Either prong on the Chime Kit can be connected to either of the terminals on the chime.

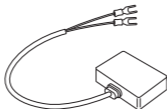

- Step 4** Using the included doubles sided tape, affix the Chime Kit to your chime wherever there is space and replace the cover. Be careful not to interfere with any of the chime's moving parts.

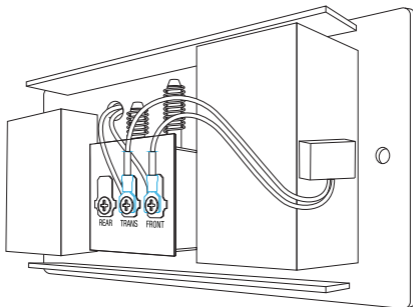

Ensure that the Chime Kit and wires **DO NOT** interfere with the mechanical parts of the chime. Mount on the outside of the chime if there is not enough room to mount inside. And replace your chime's cover.

Mode 1 Doorbell General Installation

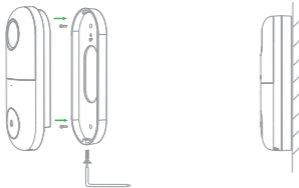

1. Fix the bracket to the wall with the mounting screws
2. Install the camera in the bracket and lock it with the screw

Mode 2 Angle Wall Mount + Bracket + Doorbell Installation

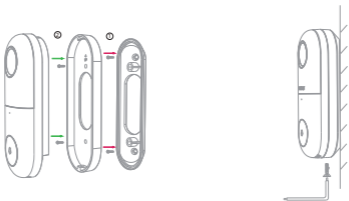

1. Fix the angle wall mount to the wall
2. Fix the mounting bracket in the angle wall mount
3. Install the camera in the bracket and lock it with the screw



Turn the doorbell power back on at the fuse box. The light on the doorbell button should turn on and after a few minutes become red slowly.

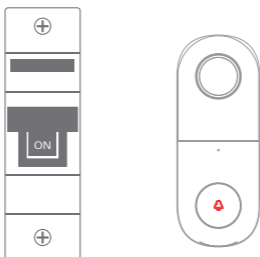

Download

Smart Life is available for both iOS and Android OS. Search the name 'Smart Life' in App Store or Android Market, or scan the QR-Code to download the App.

Support



iOS



Android



Download App(iOS,Android)

Set up router

The router supports the 2.4GHz /5GHz WiFi (support the WiFi 5GHz), and is connected to the WiFi network. Please set the parameters of the router before connecting the WiFi network, and record the SSID and password of your WiFi.

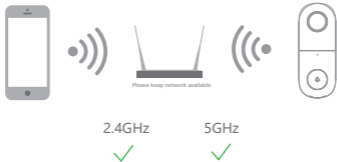

Registration process

Step 1 Open the Smart Life App, click "Register", read the "Privacy Policy" and click "Agree" .

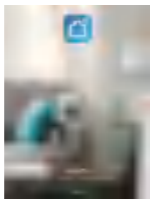

Step 2 Input a legal and valid Mobile number or Email address and click "Register". Input Verification Code, then log in the app.



- 3 In "Add Device" this interface, continue to click "next step", and then you should input your WiFi's passwords.



Note:

- 1) Camera only supports 2.4/5GHz WiFi network.
- 2) The number of bits in the ssid and passwords of the router should not exceed 24 digits.

- 4 In this interface, you should scan the QR code in your phone with the camera, when the camera comes out "dong dong dong". And you can complete the configuration about 30s.



- 5 When connecting, you should make sure your router, mobile, and camera are as close as possible. When camera added successfully, click "Z" you could also DIY the camera's name.

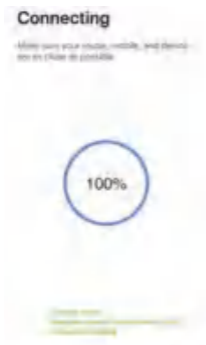

In "Smart Camera" interface,click "",you can set the camera common functions.

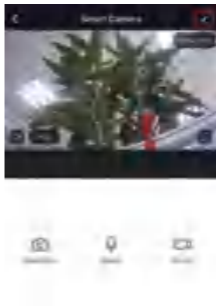
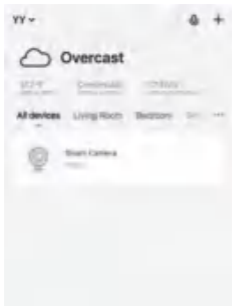

Functions

Full-duplex audio

When the visitor push the doorbell button, you will get a call. You can see and hear the vistor in your App from the doorbell if you answer.

Motion detection

Motion sensors will notify you when movement is detected.

Shared device

The doorbell device can be shared with friends, and friends can also preview online. There is no limit to the number of sharing devices, but only 6 accounts are supported for online preview at the same time.

Record

Record every moment using high capacity SD card storage.

Day & Night

Powerful night vision means no interruptions, even in complete darkness.

Supported phone OS	iOS 9/Android 5.0 and above version
2.4G Wi-Fi	2412-2462 MHz (Max. power<30dBm)
5G Wi-Fi	5150-5700 MHz (Max. power<23dBm)
	5745-5825 MHz(Max. power<23dBm)
Bluetooth	2400-2483.5MHz(Max. power<20dBm)

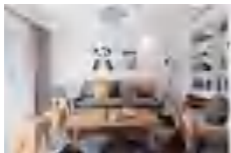

Daytime

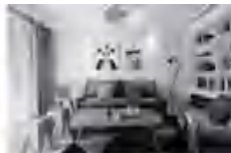

Night

Q: In the network process, the process bar is always not 100%, add failure?

A: This camera only supports 2.4GHz WiFi router, please make sure you are using a 2.4GHz WiFi router. And confirm the WiFi password again.

Q: Repeated additions are failures?

A: After adding a failure, it is recommended to restart the device or power off, and then try to add again.

Q: The device cannot be previewed properly?

A: Check whether the network is normal, you can place the camera close to the router, and if not, it is recommended to reset the device and add it again.

Q: How to cut the camera network to another router?

A: First remove and reset the device on the App and then configure the device again by the App.

Q: Why I can't get the notifications with my cell phone App?

A: Please confirm that the App has been running on the phone, and the relevant reminder function has been opened; Message notification and authority confirmation in the mobile phone system have been opened.

Q: Why doesn't the device identify the SD card?

A: It is recommended to plug in SD card after power cut. Confirm whether the SD card is normally available and the format is FAT32. And the TF card can't be identified when the internet environment is not good.

FCC Statement

This equipment has been tested and found to comply with the limits for a Class B digital device, pursuant to part 15 of the FCC Rules. These limits are designed to provide reasonable protection against harmful interference in a residential installation. This equipment generates, uses and can radiate radio frequency energy and, if not installed and used in accordance with the instructions, may cause harmful interference to radio communications. However, there is no guarantee that interference will not occur in a particular installation. If this equipment does cause harmful interference to radio or television reception, which can be determined by turning the equipment off and on, the user is encouraged to try to correct the interference by one or more of the following measures:

- Reorient or relocate the receiving antenna.
- Increase the separation between the equipment and receiver.
- Connect the equipment into an outlet on a circuit different from that to which the receiver is connected.
- Consult the dealer or an experienced radio/TV technician for help.

FCC Radiation Exposure Statement

This device complies with FCC radiation exposure limits set forth for an uncontrolled environment and it also complies with Part 15 of the FCC RF Rules. This equipment must be installed and operated in accordance with provided instructions and the antenna(s) used for this transmitter must be installed to provide a separation distance of at least 20 cm from all persons and must not be co-located or operating in conjunction with any other antenna or transmitter. End-users and installers must be provide with antenna installation instructions and consider removing the no-collocation statement.

This device complies with Part 15 of the FCC Rules. Operation is subject to the following two conditions: (1) this device may not cause harmful interference, and (2) this device must accept any interference received, including interference that may cause undesired operation.

Caution!

Any changes or modifications not expressly approved by the party responsible for compliance could void the user's authority to operate the equipment.

Industry Canada (ISED) Compliance Statement

This device complies with Industry Canada's licence-exempt RSS(s).

Operation is subject to the following two conditions:

- (1) This device may not cause interference; and
- (2) This device must accept any interference, including interference that may cause undesired operation of the device.

Le présent appareil est conforme aux CNR d'Industrie Canada applicables aux appareils radio exempts de licence. L'exploitation est autorisée aux deux conditions suivantes :

- (1) l'appareil ne doit pas produire de brouillage;
- (2) l'utilisateur de l'appareil doit accepter tout brouillage radioélectrique subi, même si le brouillage est susceptible d'en compromettre le fonctionnement.

The device meets the exemption from the routine evaluation limits in section 2.5 of RSS 102 and compliance with RSS-102 RF exposure, users can obtain Canadian information on RF exposure and compliance.

Le dispositif rencontre l'exemption des limites courantes d'évaluation dans la section 2.5 de RSS 102 et la conformité à l'exposition de RSS-102 rf, utilisateurs peut obtenir l'information canadienne sur l'exposition et la conformité de rf.

This transmitter must not be co-located or operating in conjunction with any other antenna or transmitter. This equipment should be installed and operated with a minimum distance of 20 centimeters between the radiator and your body.

Cet émetteur ne doit pas être Co-placé ou ne fonctionnant en même temps qu'aucune autre antenne ou émetteur. Cet équipement devrait être installé et actionné avec une distance minimum de 20 centimètres entre le radiateur et votre corps.

Safety Information

Power Adapter Safety:

1. The power plug is intended to serve as a disconnect device. Do not drop or cause an impact to the power adapter.
2. If the power cable is damaged (for example, the cord is exposed or broken), or the plug loosens, stop using it at once. Continued use may lead to electric shocks, short circuits, or fire.
3. Do not touch the device or the power adapter with wet hands. Doing so may lead to short circuits, malfunctions, or electric shocks.

Child's safety

1. Comply with all precautions with regard to child's safety. Letting children play with the device or its accessories may be dangerous.
2. The device and its accessories are not intended for use by children. Children should only use the device with adult supervision.

Operation safety

1. Use the device under allowed humidity and temperature conditions.
2. Do not aim the device at strong light sources (such as lamplight, and sunlight) when focusing it, to avoid reducing the lifespan of the CMOS sensor, and causing overbrightness and flickering.
3. Observe local laws and regulations, and respect the privacy and legal rights of others.

Restrictions declaration in the 5 GHz band:

- (i) the device for operation in the band 5150-5250 MHz is only for indoor use to reduce the potential for harmful interference to co-channel mobile satellite systems
- (ii) Les dispositifs fonctionnant dans la bande 5150-5250 MHz sont réservés uniquement pour une utilisation à l'intérieur afin de réduire les risques de brouillage préjudiciable aux systèmes de satellites mobiles utilisant les mêmes canaux.